Kodak EasyShare M753/M853/MD853 zoom digital camera



User's guide

www.kodak.com

For interactive tutorials: www.kodak.com/go/howto

For help with your camera: www.kodak.com/go/m753support,
www.kodak.com/go/m853support, www.kodak.com/go/md853support

Kodak

Eastman Kodak Company
Rochester, NY 14650

© Eastman Kodak Company, 2007



All screen images are simulated.

Kodak, EasyShare, and Perfect Touch are trademarks of Eastman Kodak Company.

P/N 4J6215_en

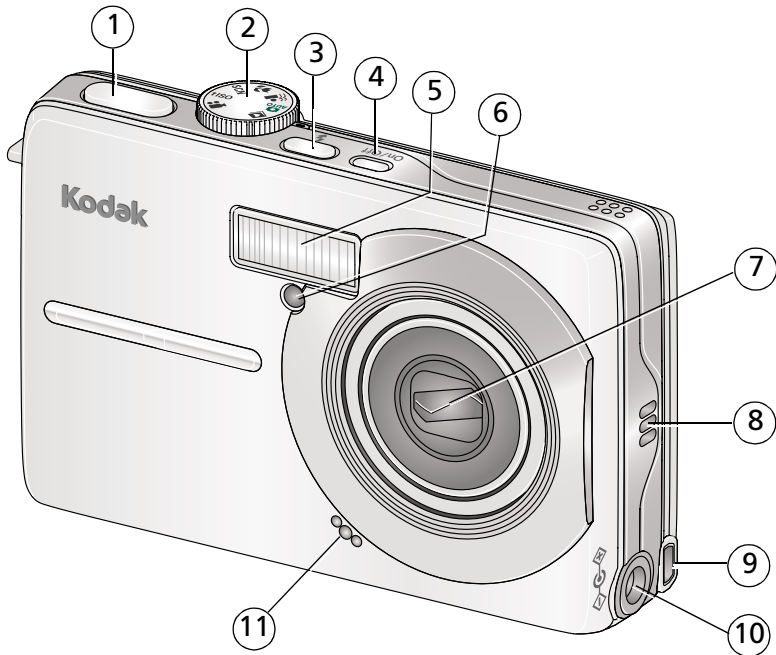
Front view



- | | | | |
|---|------------------------|----|-------------------------------------------------------------------------------------------------------------------------------|
| 1 | Shutter button | 7 | Lens |
| 2 | Mode dial | 8 | Speaker |
| 3 | Flash button | 9 | USB  |
| 4 | On/Off button | 10 | DC-In (5V)  for optional AC adapter |
| 5 | Flash | 11 | Microphone |
| 6 | Self-timer/video light | | |

Back view

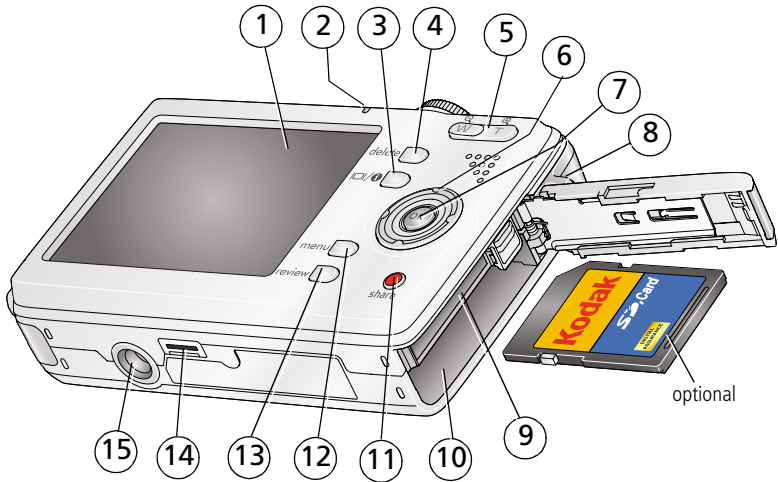



- | | |
|-----------------------------------------------------------------------------------------------------|------------------------------------|
| 1 LCD | 9 Slot for optional SD or MMC card |
| 2 Ready/Battery charging light | 10 Battery compartment |
| 3 LCD/Info button  | 11 Share button |
| 4 Delete button | 12 Menu button |
| 5 Zoom button (Wide/Telephoto) | 13 Review button |
| 6  | 14 Dock connector |
| 7 OK button | 15 Tripod socket |
| 8 Strap post | |

Table of contents

1	Setting up your camera	1
	Attaching the strap	1
	Loading the KLIC-7001 battery	1
	Charging the battery with the USB cable	2
	Turning on the camera	3
	Setting the language, date/time	3
	Storing pictures on an SD or MMC card	4
2	Taking pictures/videos	5
	Taking a picture	5
	Taking a video	6
	Using optical zoom	7
	Using the flash	8
	Using different picture-taking modes	9
	Using camera Help	11
	Taking panoramic pictures	12
	Understanding the picture-taking icons	13
3	Working with pictures/videos	14
	Reviewing pictures/videos	14
	Deleting pictures/videos	16
	Using Kodak Perfect Touch technology	17
	Cropping pictures	17
	Editing videos	18
	Running a slide show	19
	Copying pictures/videos	21
	Understanding the review icons	22
4	Doing more with your camera	24
	Changing picture-taking settings	24
	Customizing your camera	28
	Using exposure compensation to adjust picture brightness	31

Using the framing grid to compose a picture.....	31
Sharing your pictures.....	31
5 Transferring and printing pictures	39
Installing the software.....	39
Transferring pictures with the USB cable.....	40
Printing pictures.....	41
Dock compatibility for your camera.....	43
6 Troubleshooting	44
Camera problems.....	44
Camera/computer communications.....	47
LCD screen messages.....	47
7 Getting help	50
8 Appendix	52
Camera specifications	52
Care and maintenance	54
Upgrading your software and firmware.....	55
Storage capacities	55
Important safety instructions	55
Battery life	56
Limited Warranty	57
Regulatory compliance	59

1

Setting up your camera

Attaching the strap

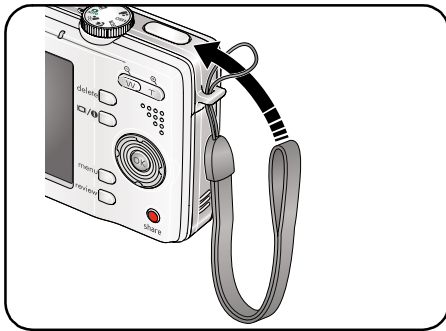

Loading the KLIC-7001 battery

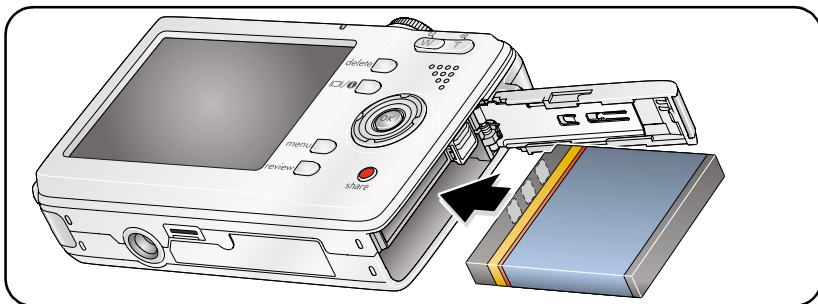

To replace batteries and extend battery life, see [page 57](#).

Charging the battery with the USB cable

NOTE: If the battery charging light does not turn on, ensure:

- The USB cable is connected to the computer's USB port, not a USB HUB
- The computer is turned on and not in sleep mode

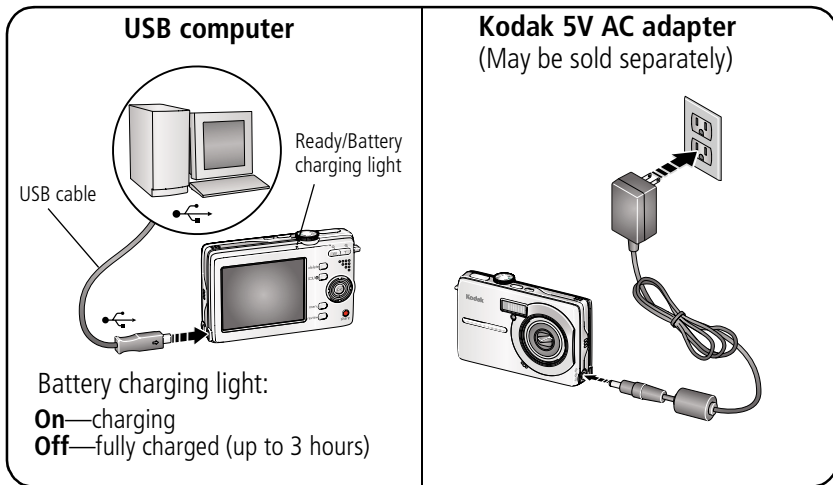

NOTE: Rechargeable batteries have a limited number of charging cycles. Battery life and number of charge cycles vary by use and settings.

Other battery charging accessories that may be sold separately include:

- Kodak EasyShare camera dock
- Kodak EasyShare printer dock

To purchase accessories, visit: www.kodak.com/go/m753accessories,
www.kodak.com/go/m853accessories, www.kodak.com/go/md853accessories.

To learn more about battery charging, visit www.kodak.com/go/support.

Turning on the camera

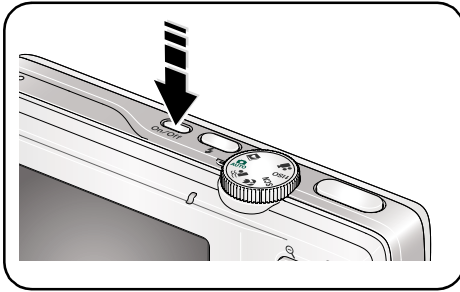

Setting the language, date/time

A diagram of the camera's LCD screen displaying the 'Date & Time' menu. The screen shows '12 2007 12' with yellow arrows indicating navigation. Below the date, it says 'OK when done'. The camera's physical controls are shown with arrows pointing to them: the multi-selector dial for navigation, the OK button for acceptance, and the Menu button for exiting the menu.

Language:

- 1 ▲/▼ to change.
- 2 OK to accept.

Date/Time:

- 1 At the prompt, press OK.
- 2 ▲/▼ to change.
◀/▶ for previous/next field.
OK to accept.

NOTE: To change the date/time and language in the future, use the Menu button (see page 29).

Storing pictures on an SD or MMC card

Your camera has internal memory. You can purchase an SD or MMC card to conveniently store more pictures and videos (www.kodak.com/go/m753accessories, www.kodak.com/go/m853accessories, www.kodak.com/go/md853accessories). We recommend Kodak SD or MMC cards.

NOTE: When using the card for the first time, format the card in this camera before taking pictures ([see page 30](#)). To choose a storage location for pictures and videos, [see page 28](#).

- 1 Turn off the camera.
- 2 Insert or remove the optional card.
- 3 Turn on the camera.

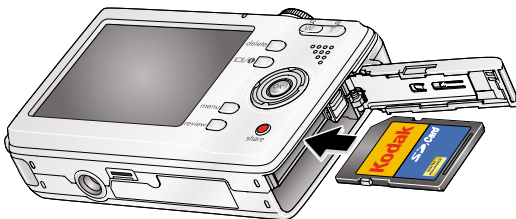

CAUTION:

A card can only be inserted one way; forcing it may cause damage. If you insert or remove a card while the camera is accessing it, the card, pictures, or camera may be damaged.

See [page 55](#) for storage capacities.

2 Taking pictures/videos

Taking a picture

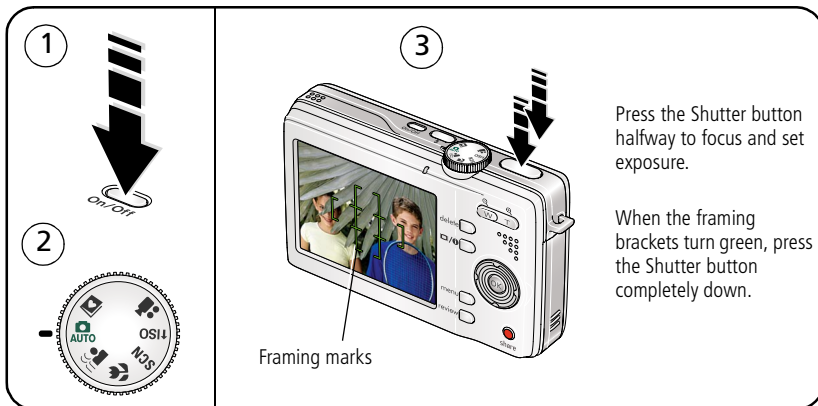

Reviewing the picture just taken

After you take a picture or video, the LCD displays a quickview for approximately 10 seconds. (To exit the quickview sooner, press the Shutter button halfway.)

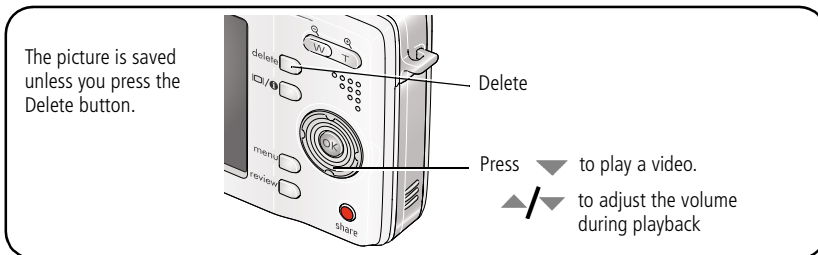

To review pictures/videos anytime, see [page 14](#).

Using the framing marks to take pictures

Framing marks indicate the camera focus area. The camera attempts to focus on foreground subjects, even if the subjects are not centered in the scene.

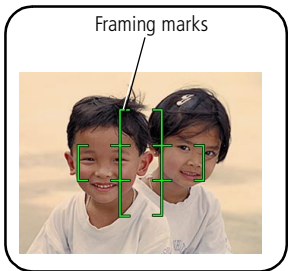

- 1 Press the Shutter button **halfway**.
When the framing marks turn green, focus is accomplished.
- 2 If the camera is not focusing on the desired subject (or if the framing marks disappear), release the Shutter button and recompose the scene.
- 3 Press the Shutter button **completely down** to take the picture.

NOTE: Framing marks do not appear in all modes. When you use AF Zone and set Center Zone, the framing marks are fixed at Center Wide.

Taking a video

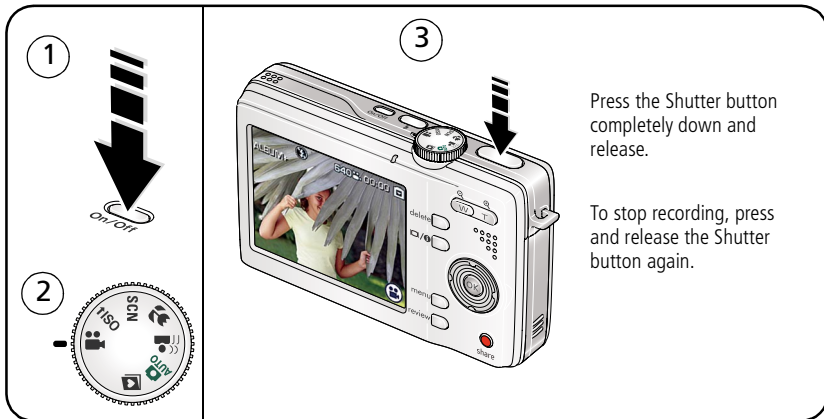

Using optical zoom

Use optical zoom to get up to 3X closer to your subject.

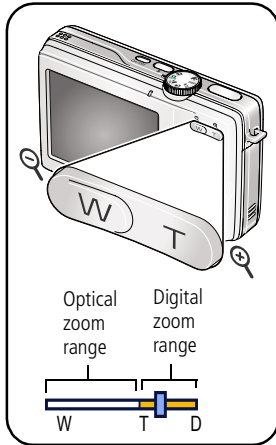

- 1 Use the LCD to frame your subject.
- 2 Press Telephoto (T) to zoom in. Press Wide Angle (W) to zoom out.

The zoom indicator shows zoom status.

- 3 Take the picture or video.

NOTE: For focus distances, [see page 52](#).

- Always use the auto focus framing marks, [page 6](#).
- If you are not using zoom (1X, wide angle), you can be as close as 24 in. (60 cm) to your subject.
- As you zoom, you need to move further from your subject.

Using the digital zoom

Use digital zoom in any Still mode or during video recording to get up to 5X magnification beyond optical zoom.

- 1 Press Telephoto (T) to the maximum optical zoom limit. Release the button, then press it again.
- 2 Take the picture.

NOTE: You may notice decreased image quality when using digital zoom. The slider on the zoom indicator turns red when the picture quality reaches the limit for an acceptable 4 x 6-in. (10 x 15 cm) print.

Using the flash

Use the flash when you take pictures at night, indoors, or outdoors in heavy shadows.

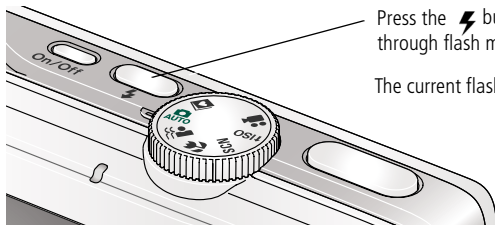

Press the ⚡ button repeatedly to scroll through flash modes (see Flash modes below).





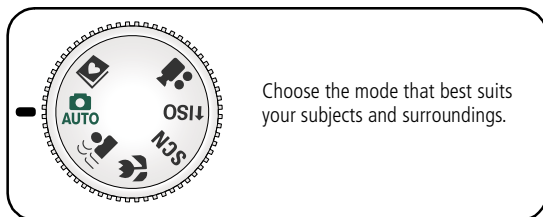

The current flash mode appears in the LCD screen.

Flash-to-subject distance	
Zoom position	Flash distance
Wide angle	0.6–3.5 m (2–11.5 ft) @ ISO 200
Telephoto	0.6–2.0 m (2–6.6 ft) @ ISO 200

Flash modes	Flash fires	
Auto Flash	When the lighting conditions require it.	
Fill	Every time you take a picture, regardless of the lighting conditions. Use when the subject is in shadow or is “backlit” (when the light is behind the subject). In low light, hold the camera steady or use a tripod.	
Red-eye	If Red-eye Pre-flash is turned off:	If Red-eye Pre-flash is turned on:
	<ul style="list-style-type: none"> ■ The flash fires once and the camera automatically corrects red-eye in the picture. 	<ul style="list-style-type: none"> ■ The flash fires once so the eyes become accustomed to the flash, then fires again when the picture is taken.
To turn the Red-eye Pre-flash feature on/off, see page 30 .		
Off	Never.	

Using different picture-taking modes



Use this mode	For
 Auto AUTO	General picture taking—offers an excellent balance of image quality and ease of use.
 Digital Image Stabilization	Minimizing the effects of camera shake and subject movement.
 Close-up	Close range. Use available light instead of flash if possible.
SCN Scene	Point-and-shoot simplicity when taking pictures under special conditions. (See page 10.)
 High ISO	People in low-light scenes indoors using a higher ISO.
 Video	Capturing video with sound. (See page 6.)
 Favorites	Reviewing favorite pictures. (See page 14.)

Scene modes



Choose a Scene mode—for great pictures in practically any situation!

- 1 Turn the Mode dial to Scene **SCN**.
- 2 Press ◀/▶ to display Scene mode descriptions.
If the mode description turns off before you finish reading it, press OK.
- 3 Press OK to choose a Scene mode.

Use this SCN mode	For
Portrait	Full-frame portraits of people.
Panorama Left-Right	Stitching up to 3 captured images from left to right into one image.
Panorama Right-Left	Stitching up to 3 captured images from right to left into one image.
Sports	Subjects in motion.
Landscape	Far-away scenes. The camera uses infinity auto-focus. Auto-focus framing marks are not available in Landscape.
Night Portrait	Reducing red eye of people in night scenes or low-light conditions. Place the camera on a flat, steady surface or use a tripod.
Night Landscape	Distant scenery at night. Flash does not fire. Place the camera on a flat, steady surface or use a tripod.
Snow	Bright snow scenes.
Beach	Bright beach scenes.
Text/ Document	Documents. Focus is set to Auto Focus (see page 27).
Fireworks	Bright, colorful light displays. Flash does not fire. Place the camera on a flat, steady surface or use a tripod.
Flower	Close-ups of flowers or other small subjects in bright light. Focus is set to Auto Focus (see page 27).

Use this SCN mode	For
Manner/Museum	Quiet occasions, like a wedding or lecture. Flash and sound are disabled.
Self-Portrait	Close-ups of yourself. Assures proper focus and minimizes red eye.
Children	Action pictures of children in bright light.
Backlight	Subjects that are in shadow or "backlit" (when light is behind the subject).
Candle light	Capturing subjects in low light.
Sunset	Capturing the deep hues seen at sunset.

Using camera Help

To better understand each menu option, use camera Help. Select an option you want to learn more about, then press the   button.

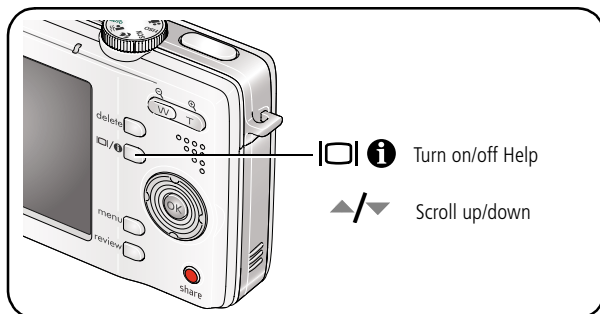

Taking panoramic pictures

Use panorama to “stitch” up to 3 pictures into a panoramic scene.

NOTE: For best results, use a tripod. Individual pictures are not saved, even if panorama capture is cancelled before stitching occurs. (Picture size is set to 3.1 MP for each picture. Exposure Compensation, White Balance, AF Zone, AF Control, and Color Mode are set with the first picture. The flash is set to Off.)

- 1 Turn the Mode dial to SCN.
- 2 Press $\blacktriangleleft/\blacktriangleright$ on the 4-way button to highlight Panorama Left-Right or Panorama Right-Left (depending on the direction you want to pan), then press the OK button.
- 3 Take the first picture.
After a quickview, the LCD displays the liveview and an “overlay” from the first picture.
- 4 Compose the second picture. Make the overlay from the first picture cover the same portion in the new picture. (You can press the Delete button to re-take a picture.)
- 5 If you are taking only 2 pictures, press the OK button to stitch them together.
After you take 3 pictures, the pictures are automatically stitched together. The LCD displays a quickview for approximately 5 seconds.

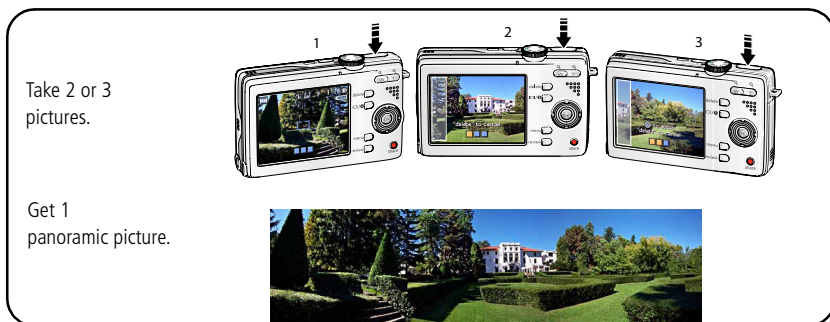

Understanding the picture-taking icons

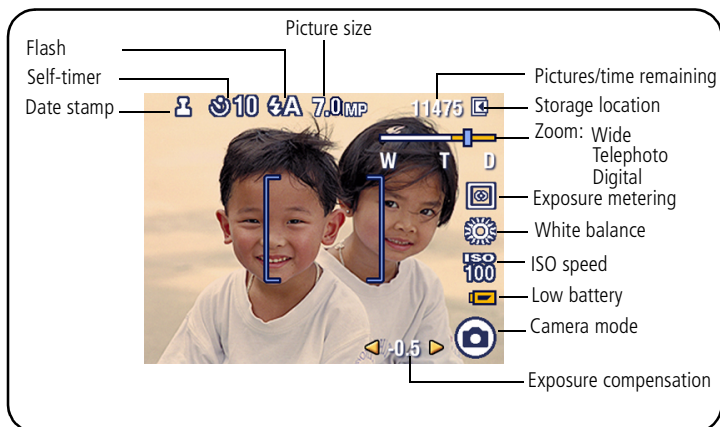

In capture mode—shutter pressed halfway





3

Working with pictures/videos

Reviewing pictures/videos

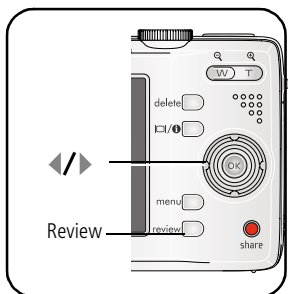
Press the Review button to view and work with your pictures/videos. Press Review again to exit.





- 1 Press the Review button.
- 2 Press  to view previous/next picture/video.

To save battery power, use an optional Kodak EasyShare dock or Kodak 5-volt AC adapter. (Visit: www.kodak.com/go/m753accessories, www.kodak.com/go/m853accessories, www.kodak.com/go/md853accessories.)

NOTE: Pictures taken at 3:2 and 16:9 picture sizes have a black bar at the top and bottom. A video's duration is displayed at the top of the LCD.

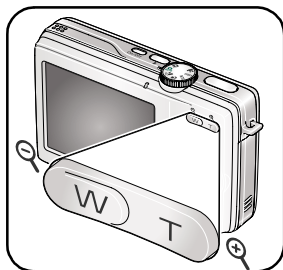
Magnifying pictures

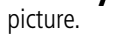

- 1 Press the Review button.
- 2 Press W/T to magnify 2X–8X.
- 3 Press   to view other parts of the picture.
- 4 Press OK to return to 1X.

NOTE: If you press  while at 1X, the view changes from single-picture to multi-up thumbnail pictures. (See [page 15](#).)

Playing a video

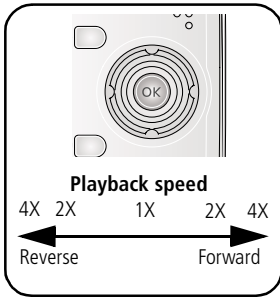

- 1 Press the Review button.
- 2 Press ◀/▶ to find previous/next video.
- 3 Press ▼ to play. Press OK to pause/unpause.
- 4 Press ▲/▼ during playback to adjust the volume.
- 5 Press ▶ during playback to play at 2X, 4X.
- 6 Press ◀ during playback to reverse at 2X, 4X.



Viewing thumbnails (multi-up)



- 1 Press the Review button.
- 2 Press ▼ to change from single-picture view (Still pictures only) to multi-up thumbnails.
- 3 Press OK to return to single-picture view.

Viewing picture/video information



- 1 Press the Review button.
- 2 Repeatedly press the LCD/Info   button to turn on/off status icons and picture/video info.

Deleting pictures/videos

- 1 Press the Review button.
- 2 Press ◀/▶ for previous/next picture/video.
- 3 Press the Delete button.
- 4 Follow the screen prompts.

Protecting pictures/videos from deletion

- 1 Press the Review button.
- 2 Press ◀/▶ for previous/next picture/video.
- 3 Press the Menu button.
- 4 Press ▲/▼ to highlight Protect, then press OK.

The picture/video is protected and cannot be deleted. The Protect icon  appears with the protected picture/video.

- Press the Menu button to exit the menu.



CAUTION:

Formatting internal memory or an SD or MMC card deletes all (including protected) pictures/videos. (Formatting internal memory also deletes email addresses, album names, and favorites. To restore them, see EasyShare software Help.)

Using Kodak Perfect Touch technology

Kodak Perfect Touch technology helps ensure better, brighter pictures.

- 1 Press the Review button, then ◀/▶ for previous/next picture.
- 2 Press the Menu button. Press ▲/▼ to highlight Edit Picture, then press OK.
- 3 Press ▲/▼ to highlight Perfect Touch tech., then press OK.

The enhancement is previewed in a split screen. Press ◀/▶ to view other parts of the picture.

- 4 Press OK. Follow the screen prompts to replace the original picture or to save the enhanced picture as a new one.

NOTE: You cannot enhance previously enhanced pictures.

- Press the Menu button to exit the menu.

Cropping pictures

You can crop a picture so that only the desired portion of the picture remains.

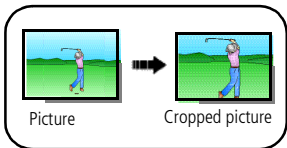

- 1 Press the Review button, then ◀/▶ to find a picture.
- 2 Press the Menu button. Press ▲/▼ to highlight Edit Picture, then press OK.
- 3 Press ▲/▼ to highlight Crop, then press OK.
- 4 Press Telephoto (T) to zoom in, or ◀/▶ ▲/▼ to move the crop box. Press OK.
- 5 Follow the screen prompts.

The picture is cropped. The original is saved. (Cropped pictures cannot be cropped again.)

- Press the Menu button to exit the menu.

Editing videos

Making a picture from a video

You can choose a single frame from a video, then make a picture suitable for printing.

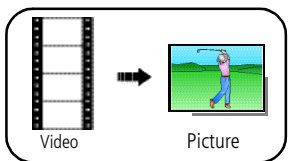

- 1 Press the Review button, then ◀/▶ to find a video.
- 2 Press the Menu button. Press ▲/▼ to highlight Edit Video, then press OK.
- 3 Press ▲/▼ to highlight Make Picture, then press OK.
- 4 Press ▼ to select a video frame.
- 5 Follow the screen prompts to save the picture.
A picture is created. (The original video is saved.)
 - Press the Menu button to exit the menu.

Trimming a video

You can delete an unwanted portion from the beginning or end of a video.

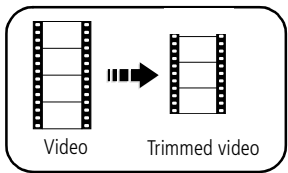

- 1 Press the Review button, then ◀/▶ to find a video.
- 2 Press the Menu button. Press ▲/▼ to highlight Edit Video, then press OK.
- 3 Press ▲/▼ to highlight Trim, then press ▼.
- 4 Follow the screen prompts. (Use fast-forward and fast-reverse, if needed.)
The video is trimmed. (You can save it as a new video or replace the original.)
 - Press the Menu button to exit the menu.

Making a video action print

From a video, you can make a 4-, 9-, or 16-up picture, suitable for a 4 x 6-inch (10 x 15 cm) print.

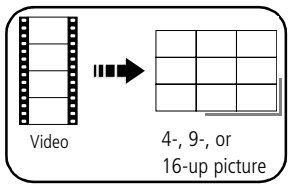

- 1 Press the Review button, then ◀/▶ to find a video.
- 2 Press the Menu button. Press ▲/▼ to highlight Edit Video, then press OK.
- 3 Press ▲/▼ to highlight Video Action Print, then press OK.
- 4 Choose an option, then press OK.

Auto options: The camera includes the first and last frames, then 2, 7, or 14 equally spaced frames.

Manual options: You choose the first and last frames; the camera chooses 2, 7, or 14 equally spaced frames.

- Press the Menu button to exit the menu.

Running a slide show

Use Slide Show to display your pictures/videos on the LCD.

Starting the slide show

- 1 Press the Review button, then the Menu button.
- 2 Press ▲/▼ to highlight Slide Show, then press OK.
- 3 Press ▲/▼ to highlight Begin Show, then press OK.

Each picture/video is displayed once.

To interrupt the Slide Show, press OK.

Changing the slide show display interval

The default interval setting displays each picture for 5 seconds. You can set the display interval from 3–60 seconds.

1 On the Slide Show menu, press ▲/▼ to highlight Interval, then press OK.

2 Select a display interval.

To scroll through the seconds quickly, press and hold ▲/▼.

3 Press OK.

The interval setting remains until you change it.

Running a continuous slide show loop

When you turn on Loop, the slide show is continuously repeated.

1 On the Slide Show menu, press ▲/▼ to highlight Loop, then press OK.

2 Press ▲/▼ to highlight On, then press OK.

3 Press ▲/▼ to highlight Begin Show, then press OK.

The slide show repeats until you press OK or until battery power is exhausted. The loop feature remains until you change it.

Copying pictures/videos

You can copy pictures/videos from a card to internal memory or from internal memory to a card.

Before you copy, make sure that:

- A card is inserted in the camera.
- The camera's image storage location is set to the location **from** which you are copying (see [page 28](#)).

Copy pictures/videos:

- 1 Press the Review button, then the Menu button.
- 2 Press **▲/▼** to highlight Copy, then press OK.
- 3 Press **▲/▼** to highlight an option.
- 4 Press OK.

NOTE: Pictures/videos are copied, not moved. To remove pictures/videos from the original location after copying, delete them (see [page 16](#)).

Tags that you applied for print, email, and favorites are not copied. Protection settings are not copied. To apply protection to a picture/video, see [page 16](#).

Understanding the review icons

Pictures

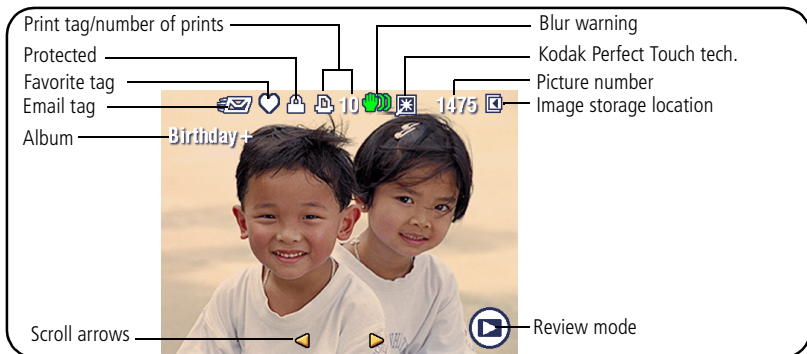

Videos

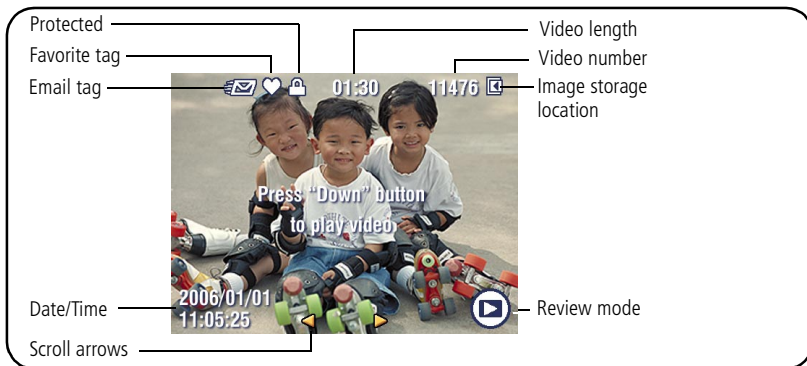

Understanding blur warning icons

A picture blur warning icon  is displayed during quickview and review.

Green—Picture is sharp enough for an acceptable 4 x 6-inch (10 x 15 cm) print.

Yellow—Picture may be sharp enough for an acceptable 4 x 6-inch (10 x 15 cm) print or sharpness is not determined.

Red—Picture is not sharp enough for an acceptable 4 x 6-inch (10 x 15 cm) print.

White—Printability is still being determined.



4

Doing more with your camera



Changing picture-taking settings



You can change settings to get the best results from your camera.



- 1 Press the Menu button.
- 2 Press ▲/▼ to highlight a setting, then press OK.
- 3 Choose an option, then press OK.
 - Press the Menu button to exit the menu.

NOTE: To better understand each menu option, use camera Help. Highlight a menu choice, then press the   button. Some settings remain until you change them; others, until you change modes or turn off the camera. Some modes offer limited settings.

Press Menu ▲/▼, and OK to access settings	Options
<p>Self-timer Choose a self-timer setting.</p>	<p>10 seconds (default)—so you have time to get into the scene.</p> <p>2 seconds—for a steady, auto-shutter release on a tripod.</p> <p>2-shot—one picture is taken after a 10-second delay. A second picture is taken 8 seconds later.</p>
<p>Burst Capture an expected event. Camera takes up to 4 pictures (3 pictures for the M853 and MD853) while the Shutter button is pressed. All the pictures are saved.</p>	<p>Off (default)</p> <p>On</p> <p>NOTE: You cannot use Burst when Long Time Exposure is turned on.</p>

Press Menu , , and OK to access settings	Options		
Exposure Compensation Increase or decrease brightness before taking a picture. (Also see page 31.)	-2.0 to +2.0 (in 0.3 increments)		
Picture Size Choose a picture resolution. For recommended print sizes, visit: www.kodak.com/go/printsizes	M753	For	M853 MD853
	7.0 MP (4:3) (default)	Pictures at the highest resolution, largest file size	8.1 MP (4:3) (default)
	6.2 MP (3:2)	Printing on EasyShare printer docks and photo printers	7.2 MP (3:2)
	5.3 MP (16:9)	HDTV format in high resolution	6.1 MP (16:9)
	5.0 MP (4:3)	Medium file size	5.0 MP (4:3)
	3.1 MP (4:3)	Medium file size	3.1 MP (4:3)
	2.2 MP (3:2)	Printing on EasyShare printer docks and photo printers (at a lower resolution than 6.2/7.2 MP)	2.2 MP (3:2)
	2.1 MP (16:9)	HDTV format	2.1 MP (16:9)
	1.2 MP (4:3)	Email, Internet, or to conserve space	1.2 MP (4:3)

Press Menu  /  , and OK to access settings	Options
<p>White Balance Choose your lighting condition.</p>	<p>Auto (default)—automatically corrects white balance. Ideal for general picture taking.</p> <p>Daylight—for pictures in natural lighting.</p> <p>Tungsten—corrects the orange cast of household light bulbs. Ideal for indoor pictures under tungsten or halogen lighting without flash.</p> <p>Fluorescent—corrects the green cast of fluorescent lighting. Ideal for indoor pictures under fluorescent lighting without flash.</p> <p>Open Shade—for pictures in shade in natural lighting.</p>
<p>Exposure Metering Evaluate light levels at specific areas of a scene.</p>	<p>Multi-Pattern (default)—evaluates lighting conditions throughout the image to give an optimum picture exposure. Ideal for general picture taking.</p> <p>Center-Weight—evaluates the lighting conditions of the subject centered in the lens. Ideal for backlit subjects.</p> <p>Spot—similar to Center-weighted, except the metering is concentrated on a smaller area of the subject centered in the viewfinder. If used with Selectable AF zones, the exposure spot follows the focus zone. Ideal when you need an exact exposure of a specific area in the picture.</p>
<p>ISO Speed Control the camera's sensitivity to light.</p>	<p>Choose a lower ISO setting in brightly lit scenes; use a higher ISO for low-light scenes. Choose Auto (default), 80, 100, 200, 400, 800, 1250.</p> <p>NOTE: ISO returns to Auto when the camera is set to Portrait or SCN mode.</p> <p>Unavailable in Video mode.</p>

Press Menu  ,  , and OK to access settings	Options
<p>AF Zone Select a large or concentrated area of focus.</p>	<p>Multi-zone (default)—evaluates 5 zones to give an even picture focus. Ideal for general picture taking.</p> <p>Center-zone—evaluates the small area centered in the viewfinder. Ideal when precise focus of a specific area in the picture is needed.</p> <p>NOTE: For the best pictures, the camera is set to Multi-zone when in Landscape mode.</p>
<p>Color Mode Choose color tones. Unavailable in Video mode.</p>	<p>High Color Natural Color (default) Low Color Black & White Sepia—pictures have a reddish-brown, antique look.</p> <p>NOTE: EasyShare software also lets you change a color picture to black-and-white or sepia.</p> <p>Unavailable in Video mode.</p>
<p>Long Time Exposure Choose how long the shutter stays open.</p>	<p>0.5 - 4.0 seconds</p>
<p>Set Album Choose Album names.</p>	<p>Clear All—selected album settings are cancelled</p> <p>Pre-select album names before you take pictures/videos. Then, all the pictures/videos you take are tagged with those album names. See page 37.</p>



Press Menu ▲/▼, and OK to access settings	Options
Image Storage Choose a storage location for pictures/videos.	Auto (default) —the camera uses the card if one is in the camera. If not, the camera uses internal memory. Internal Memory —the camera uses internal memory, even if a card is installed. NOTE: If you fill up your card while taking pictures, your camera's memory plus feature prompts you to switch to internal memory, if space is available. Memory plus is unavailable in Video mode.
Maintain Settings Choose which settings are saved, even after the camera is turned off. Available only in Auto mode.	Exit (default) Flash White Balance ISO Speed Color Mode AF Zone Clear All
Video Size Available only in Video mode.	640 x 480 (default) 320 x 240
Setup Menu Choose additional settings.	See Customizing your camera on page 28 .

Customizing your camera

Use Setup to customize your camera settings.

- 1 In any mode, press the Menu button.
- 2 Press ▲/▼ to highlight Setup, then press OK.
- 3 Press ▲/▼ to highlight a setting, then press OK.
- 4 Choose an option, then press OK.

5 Press the Menu button to exit.

NOTE: Press the LCD/Info button   for information about camera settings and options. These settings remain until you change them.

Press Menu, ▲/▼ to highlight Setup, then OK to access settings	Options
Return to previous menu.	
Camera Sounds Choose sound effects.	Themes —applies the same sound effect set to all functions. Individual —choose a sound effect for each function.
Sound Volume	Off Low Medium (default) High
LCD Brightness	Power Save High Power (default)
Auto Power Off Choose inactivity time until camera turns off.	10 minutes 5 minutes 3 minutes (default) 1 minute
Date & Time	See page 3 .
Video Out Choose the regional setting that lets you connect the camera to a television or other external device.	NTSC (default) —used in North America and Japan. PAL —used in Europe and China.
Orientation Sensor Orient pictures so that they are displayed with the correct side up.	On (default) Off

Press Menu, ▲/▼ to highlight Setup, then OK to access settings	Options
<p>Red-eye Pre-flash Choose if the Red-eye flash fires automatically before a picture is taken. NOTE: The camera automatically corrects red-eye when the Red-eye Pre-flash is set to Off.</p>	<p>On (default) Off</p>
<p>Date Stamp Imprint the date on pictures.</p>	<p>Choose a date option, or turn off the feature. (Default is off.)</p>
<p>Video Date Display Display Date/Time at the start of video playback.</p>	<p>On (default)—choose from date formats. Off</p>
<p>Blur Warning See page 23.</p>	<p>On (default) Off</p>
<p>Language</p>	<p>See page 3.</p>
<p>Format</p> <p> CAUTION: Formatting deletes all pictures/videos, including those that are protected. Removing a card during formatting may damage the card.</p>	<p>Memory Card—deletes everything on the card; formats the card. Cancel—exits this setting. Internal Memory—deletes everything in internal memory including email addresses, album names, and favorites; formats the internal memory.</p>
<p>About View camera information.</p>	

Using exposure compensation to adjust picture brightness

Before you take a picture, you can adjust exposure compensation to make pictures darker or lighter.

- Press ◀ to decrease exposure compensation.
- Press ▶ to increase exposure compensation.

The exposure compensation level is shown on the LCD; the LCD gets brighter or dimmer.

Using the framing grid to compose a picture

The framing grid divides the LCD into thirds—vertically and horizontally. This is helpful if, for example, you want to balance a picture between water, earth, and sky.



To turn on the framing grid in Auto/SCN modes, press the Info/Display **i**  button until the grid appears.

Sharing your pictures

Press the Share button to tag your pictures and videos. When they are transferred to your computer, you can share them. Use the Share button:

- Any time. (The most recent picture/video taken is then displayed.)
- Just after you take a picture/video, during quickview.
- After pressing the Review button.

Tagging pictures for printing

- 1 Press the Share button. Press ◀/▶ to locate a picture.
- 2 Press ▲/▼ to highlight Print, then press OK.*
- 3 Press ▲/▼ to select the number of copies (0-99). Zero removes the tag for that picture.
Optional: You can apply a print quantity to other pictures. Press ◀/▶ to locate a picture. Press ▲/▼ to change the print quantity. Repeat until the desired print quantity is applied to pictures.
- 4 Press OK.
The Print icon  appears in the status area.
- 5 Press the Share button to exit the menu.

* To tag all pictures in the storage location, highlight Print All, press OK, then indicate the number of copies. Print All is not available in quickview. To remove print tagging for all pictures in the storage location, highlight Cancel Prints, then press OK. Cancel Prints is not available in quickview.

Printing tagged pictures

When you transfer the tagged pictures to your computer, the Kodak EasyShare software print screen opens. For details, click the Help button in EasyShare software.

For more information on printing from your computer, printer dock, PictBridge enabled printer, or card, see [page 41](#).

NOTE: For the best 4 x 6 in. (10 x 15 cm) prints, set the camera to the 3:2 picture size setting ([see page 25](#).)

Tagging pictures and videos for emailing

First—on your computer

Use Kodak EasyShare software to create an email address book on your computer. Then copy up to 32 email addresses to the camera's internal memory. For details, click the Help button in EasyShare software.

Second—tag pictures/videos on your camera

- 1 Press the Share button. Press ◀/▶ to locate a picture/video.
- 2 Press ▲/▼ to highlight Email, then press OK.
The Email icon  appears in the status area.
- 3 Press ▲/▼ to highlight an email address, then press OK.
- 4 To tag other pictures/videos with the same address, press ◀/▶ to scroll through them. When the picture you want is displayed, press OK.
- 5 To send the pictures/videos to more than one address, repeat step 3 for each address.
Selected addresses are checked.
- 6 To remove a selection, highlight a checked address and press OK. To remove all email selections, highlight Clear All.
- 7 Press ▲/▼ to highlight Exit, then press OK.
- 8 Press the Share button to exit the menu.

Third—transfer and email

When you transfer the tagged pictures/videos to your computer, the Email screen opens and lets you send them to the addresses you specified. For details, click the Help button in Kodak EasyShare software.

Tagging pictures as favorites

You can preserve your favorite pictures in the Favorites section of your camera's internal memory, then share them with friends and family.





NOTE: When you transfer pictures from your camera to your computer, all pictures (including favorites) are stored on your computer at full size. Favorite pictures - smaller copies of your originals - are loaded back to your camera, so you can share and enjoy more.

1. Tag pictures as favorites	<p>1 Press the Share button. Press ◀/▶ to locate a picture.</p> <p>2 Press ▲/▼ to highlight Favorite, then press OK. <i>The Favorite icon ♥ appears in the status area. To remove the tag, press OK again.</i></p> <p>Press the Share button to exit the menu.</p>
2. Transfer pictures to your computer	<p>1 To enjoy all the available features, load and use the EasyShare software that was packaged with this camera. (See page 39.)</p> <p>2 Connect the camera to the computer using the USB cable (see page 40) or an EasyShare dock. <i>The first time you transfer pictures, the software helps you make choices about your favorite pictures. Then, your pictures are transferred to the computer. Favorite pictures (smaller versions of the originals) are loaded to the Favorites section of your camera's internal memory.</i></p>
3. View favorites on your camera	<p>1 Turn the Mode dial to Favorites .</p> <p>2 Press ◀/▶ to scroll through favorites.</p>

NOTE: The camera holds a limited number of favorites. Use Camera Favorites in the EasyShare software to customize the size of your camera Favorites section. Videos tagged as favorites remain in the Favorites folder in EasyShare software. For details, click the Help button in EasyShare software.

Optional settings

In Favorites mode, press the Menu button to access optional settings.

	Slide Show (page 19)		Remove favorites (page 35)
	Multi-up (page 15)		Setup Menu (page 28)

NOTE: Pictures taken at 3:2 and 16:9 picture sizes have a black bar at the top and bottom. A video's duration is displayed at the top of the LCD.

Removing favorites from your camera

- 1 Turn the Mode dial to Favorites .
- 2 Press the Menu button.
- 3 Highlight Remove Favorites, then press OK.

All pictures stored in the Favorites section of internal memory are removed. Favorites are restored the next time you transfer pictures to the computer.

- 4 Press the Menu button to exit the menu.

Preventing camera favorites from synchronizing with the software

If you don't want to use the favorites feature:



- 1 Open EasyShare software.
- 2 From the Tools menu, select Cameras/Viewers > Sync and Transfer Manager.
- 3 Click to highlight your camera, then click Camera Favorites Album Properties.
NOTE: If your camera model is not visible, use the USB cable to connect your camera to the computer.
- 4 Drag the Internal Memory slider to 0%, then click OK.
- 5 Close the Sync and Transfer Manager window.

Camera favorites will no longer synchronize with EasyShare software.

To turn on the sync feature, select Yes, synchronize with my software.

To delete favorites from your camera, press the Delete button while in Favorites mode.

Printing and emailing favorites

- 1 Turn the Mode dial to Favorites . Press / to locate a picture.
- 2 Press the Share button.
- 3 Highlight Print or Email, then press OK.

NOTE: Favorites that were taken on this camera (not imported from another source) are good for prints up to 4 x 6 in. (10 x 15 cm).

Tagging pictures/videos for albums

Use the Album feature in Review mode to tag the pictures/videos in your camera with album names.

First—on your computer

Use EasyShare software to create albums on your computer, then copy up to 32 album names to the camera's internal memory. See EasyShare software Help for details.

Second—on your camera

- 1 Press the Review button, then locate the picture or video.
- 2 Press the Menu button.
- 3 Press ▲/▼ to highlight Album, then press OK.
- 4 Press ▲/▼ to highlight an album folder, then press OK.

To add other pictures to the same album, press ◀/▶ to scroll through the pictures. When the picture you want is displayed, press OK.

To add the pictures to more than one album, repeat step 4 for each album.

The album name appears with the picture. A plus (+) after the album name means the picture was added to more than one album.

To remove a selection, highlight an album name and press OK. To remove all album selections, select Clear All.

Third—transfer to your computer

When you transfer the tagged pictures/videos to your computer, EasyShare software opens and categorizes your pictures/videos in the appropriate album folder. See EasyShare software Help for details.

Pre-tagging for album names

Use the Set Album feature to pre-select album names before you take pictures or videos. Then, all the pictures or videos you take are tagged with those album names.

First—on your computer

Use the EasyShare software that was packaged with your camera to create album names on your computer. The next time you connect the camera to the computer, copy up to 32 albums to the album name list. See EasyShare software Help for details.

Second—on your camera

- 1 In any mode, press the Menu button.
- 2 Press ▲/▼ to highlight Set Album, then press OK.
- 3 Press ▲/▼ to highlight an album name, then press OK. Repeat to mark pictures or videos for albums.

Selected albums are noted with a check mark.

- 4 To remove a selection, highlight an album name and press OK. To remove all album selections, select Clear All.
- 5 Highlight Exit, then press OK.

Your selections are saved. If you turn on the LCD, your album selection is displayed on the screen. A plus (+) after the album name means more than one album is selected.

- 6 Press the Menu button to exit the menu.

Third—transfer to your computer

When you transfer the tagged pictures or videos to your computer, EasyShare software opens and categorizes your pictures in the appropriate album. See EasyShare software Help for details.

5

Transferring and printing pictures

Installing the software



CAUTION:

Install EasyShare software *before* connecting the camera to the computer. Failure to do so may cause the software to load incorrectly.

- 1 Close all software applications that are open on your computer (including anti-virus software).
- 2 Place the EasyShare software CD into the CD-ROM drive.
- 3 Load the software:

Windows OS—if the install window does not appear, choose Run from the Start menu and type **d:\setup.exe** where **d** is the drive letter that contains the CD.

Mac OS X—double-click the CD icon on the desktop, then click the Install icon.

- 4 Follow the on-screen instructions to install the software.

NOTE: When prompted, take few minutes to electronically register your camera and software. To register later, visit www.kodak.com/go/register.

- 5 If prompted, restart the computer. If you turned off anti-virus software, turn it back on. See the anti-virus software manual for details.

For information on the software applications included on the EasyShare software CD, click the Help button in EasyShare software.

Transferring pictures with the USB cable

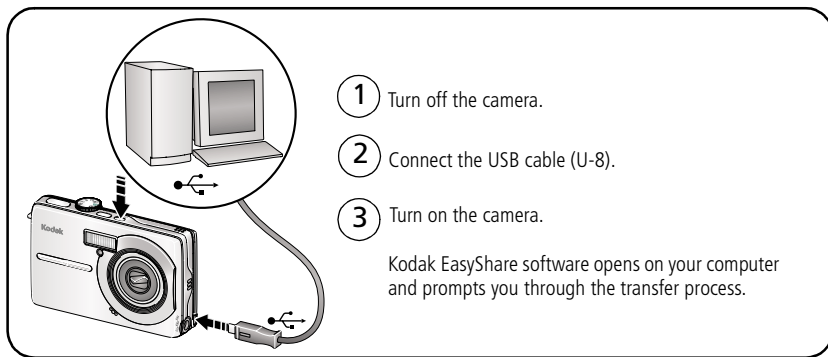

NOTE: Visit www.kodak.com/go/howto for an online tutorial on connecting.

Also available for transferring

You can also use these Kodak products to transfer your pictures and videos.

- Kodak EasyShare camera dock, Kodak EasyShare printer dock (see [page 41](#))
- Kodak multi-card reader, Kodak SD multimedia card reader-writer

Purchase these and other accessories at a dealer of Kodak products or visit www.kodak.com/go/m753accessories, www.kodak.com/go/m853accessories, www.kodak.com/go/md853accessories.

Printing pictures

Printing with a Kodak EasyShare printer dock

Dock your camera to the Kodak EasyShare printer dock and print directly—with or without a computer. Purchase this and other accessories at a dealer of Kodak products or visit www.kodak.com/go/m753accessories, www.kodak.com/go/m853accessories, www.kodak.com/go/md853accessories.

Direct printing with a PictBridge enabled printer

Your camera is compatible with PictBridge technology, so you can print directly to PictBridge enabled printers. You need:

- Camera with fully charged batteries
- PictBridge enabled printer
- USB cable (may be sold separately)

Connecting the camera to a PictBridge enabled printer

- 1 Turn off the camera and printer.
- 2 Connect the appropriate USB cable from the camera to the printer. (See your printer user guide or visit www.kodak.com/go/m753accessories, www.kodak.com/go/m853accessories, www.kodak.com/go/md853accessories.)

Printing from a PictBridge enabled printer

- 1 Turn on the printer. Turn on the camera.

The PictBridge logo is displayed, followed by the current picture and menu. (If no pictures are found, a message is displayed.) If the menu interface turns off, press any button to redisplay it.

- 2 Press ▲/▼ to choose a printing option, then press OK.

Current Picture—Press ◀/▶ to choose a picture. Choose the number of copies.

Tagged Pictures—If your printer is capable, print pictures that you tagged for printing and choose a print size.

Index Print—Print thumbnails of all pictures. This option requires one or more sheets of paper. If the printer is capable, choose a print size.

All Pictures—Print all pictures in internal memory, on a card, or in Favorites. Choose the number of copies.

Image Storage—Access internal memory, a card, or Favorites.

NOTE: During direct printing, pictures are not permanently transferred or saved to the computer or printer.

Disconnecting the camera from a PictBridge enabled printer

- 1 Turn off the camera and printer.
- 2 Disconnect the USB cable from the camera and the printer.

Using a printer that is not PictBridge enabled

For details on printing pictures from your computer, click the Help button in EasyShare software.

Ordering prints online

Kodak Gallery (www.kodakgallery.com) is one of the many online print services offered in the Kodak EasyShare software. You can easily:

- Upload your pictures.
- Edit, enhance, and add borders to your pictures.
- Store pictures, and share them with family and friends.
- Order high-quality prints, photo greeting cards, frames, and albums—and have them delivered to your door.

Printing from an optional SD/MMC card

- Automatically print tagged pictures when you insert your card into a printer with an SD/MMC card slot. See your printer user's guide for details.
- Make prints at an SD/MMC-capable Kodak picture maker/picture kiosk. (Contact a location before visiting. Visit www.kodak.com/go/picturemaker.)
- Take the card to your local photo retailer for professional printing.

Dock compatibility for your camera

To see which Kodak EasyShare docks are compatible with your camera, visit www.kodak.com/go/dockcompatibility.

Purchase camera docks, printer docks, and other accessories at a dealer of Kodak products or visit www.kodak.com/go/m753accessories, www.kodak.com/go/m853accessories, www.kodak.com/go/md853accessories.

6

Troubleshooting

For step-by-step product support, visit www.kodak.com/go/m753support, www.kodak.com/go/m853support or www.kodak.com/go/md853support, and select Interactive Troubleshooting & Repairs.

Camera problems

If...	Try one or more of the following
Camera does not turn on.	<ul style="list-style-type: none"> ■ Remove the battery, then reinsert correctly (see page 1). ■ Install new battery. ■ Charge rechargeable battery (see page 2).
Camera does not turn off.	
Camera buttons and controls do not function	
Pictures remaining number does not decrease after taking a picture.	<ul style="list-style-type: none"> ■ The camera is operating normally. Continue taking pictures.
Short battery life with Kodak Li-Ion rechargeable digital camera battery KLIC-7001.	<ul style="list-style-type: none"> ■ Wipe the contacts with a clean, dry cloth (see page 54) before loading batteries in the camera. ■ Limit the following activities that quickly deplete battery power: reviewing pictures/videos on the LCD; excessive use of the flash. ■ If you own an EasyShare camera dock series 3 or EasyShare printer dock series 3, use the Battery Refresh feature.

If...	Try one or more of the following
Stored pictures are corrupted.	<ul style="list-style-type: none"> ■ Retake pictures. Do not remove card while the camera is accessing it. Keep rechargeable batteries charged. ■ Transfer pictures to the computer (see page 40), then format the card in the camera (see page 30). <p>Caution: Formatting a card deletes all pictures and videos, including protected files.</p>
In Review mode, you do not see a picture (or the expected picture) on the LCD screen.	<ul style="list-style-type: none"> ■ Check the image storage location setting (see page 28).
In Review mode, a blue or black screen is displayed instead of a picture.	<ul style="list-style-type: none"> ■ Transfer the picture to the computer (see page 40), then format the card in the camera (see page 30). <p>Caution: Formatting a card deletes all pictures and videos, including protected files.</p>
Shutter button does not work.	<ul style="list-style-type: none"> ■ Turn on the camera (see page 3). ■ Transfer pictures to the computer (see page 40), delete pictures from the camera (see page 16), switch image storage locations (see page 28), or insert a card with available memory (see page 4).
Picture is too light.	<ul style="list-style-type: none"> ■ Move so there is at least 2 ft (0.6 m) between the camera and the subject. ■ Decrease Exposure Compensation (see page 31).
Picture is not clear.	<ul style="list-style-type: none"> ■ Clean the lens (see page 54). ■ Make sure your camera is not in Close-up mode. ■ Move so there is at least 2 ft (0.6 m) between the camera and the subject. ■ Place the camera on a flat, steady surface or use a tripod.

If...	Try one or more of the following
Picture is too dark.	<ul style="list-style-type: none"> ■ Turn on the flash (see page 8). ■ Move so there is no more than 11.5 ft (3.5 m) in wide angle and 6.6 ft (2.0 m) in telephoto between the camera and the subject. ■ Use Fill flash (page 8) or change your position so light is not behind the subject. ■ Increase Exposure Compensation (see page 31).
Camera does not recognize SD/MMC card.	<ul style="list-style-type: none"> ■ Purchase a certified SD/MMC card. ■ Reformat the card (see page 30). <p>Caution: Formatting a card deletes all pictures and videos, including protected files.</p> <ul style="list-style-type: none"> ■ Insert a card into the slot, then push to seat (see page 4).
Camera freezes up when a card is inserted or removed.	<ul style="list-style-type: none"> ■ Turn the camera off, then back on. ■ Make sure the camera is turned off before inserting or removing a card.
Memory card full.	<ul style="list-style-type: none"> ■ Insert a new card (see page 4), transfer pictures to the computer (see page 40), or delete pictures (see page 16).
Memory card and internal memory full.	<ul style="list-style-type: none"> ■ Transfer pictures to the computer (see page 40), then format the card or internal memory (see page 30). <p>Caution: Formatting a card deletes all pictures and videos, including protected files.</p>

Camera/computer communications

If...	Try one or more of the following
The computer does not communicate with the camera.	<ul style="list-style-type: none"> ■ Turn on the camera (see page 3). ■ Install new batteries (see page 1) or charge rechargeable batteries (see page 2). ■ Connect the USB cable to camera and computer port (see page 40). ■ Install the software (see page 39). ■ Disconnect the USB cable. Close all software applications. Re-install the software (see page 39). ■ Disconnect camera from the computer. Close all software applications, reconnect camera.
Cannot transfer pictures. (The Add New Hardware Wizard cannot locate drivers.)	<ul style="list-style-type: none"> ■ Disconnect the USB cable. (If using camera dock or printer dock, disconnect cable and remove camera from dock). Close all open applications. Re-install the software (see page 39). ■ Disconnect the USB cable. Close all software applications. Re-install the software (see page 39).

LCD screen messages

If...	Try one or more of the following
No images to display	<ul style="list-style-type: none"> ■ Change image storage location setting (see page 28).
Memory card requires formatting Memory card cannot be read (Please format memory card or insert another card)	<ul style="list-style-type: none"> ■ Insert a new card (see page 4) or format the card (see page 30). <p>Caution: Formatting a card deletes all pictures and videos, including protected files.</p>

If...	Try one or more of the following
<p>Only one USB connection allowed.</p> <p>Disconnect cable or rem. (remove) camera from dock.</p>	<ul style="list-style-type: none"> ■ Unplug the USB cable from the camera.
<p>Internal memory requires formatting</p>	<ul style="list-style-type: none"> ■ Format the internal memory (see page 30). <p>Caution: Formatting deletes all pictures and videos, including protected files. (Formatting internal memory also deletes email addresses, album names, and Favorites. To restore them, see the Kodak EasyShare software Help.)</p>
<p>Internal memory cannot be read (Please format internal memory)</p>	
<p>No memory card (Files not copied)</p>	<ul style="list-style-type: none"> ■ Insert a card (see page 4).
<p>Not enough space to copy files (Files not copied)</p>	<ul style="list-style-type: none"> ■ Delete pictures from the image storage location you are copying to (see page 16), or insert a new card (see page 4).
<p>Memory card is locked (Insert new memory card)</p>	<ul style="list-style-type: none"> ■ Insert a new card (see page 4), move the switch on the card to unlock the card, or change the image storage location to internal memory (see page 28).
<p>Read-only memory card.</p> <p>Remove write protection to capture or write to card.</p>	
<p>Memory card is unusable (Insert new memory card)</p>	<ul style="list-style-type: none"> ■ Insert a new card (see page 4) or format the card (see page 30). <p>Caution: Formatting a card deletes all pictures and videos, including protected files.</p>

If...	Try one or more of the following
Date and time have been reset	■ Reset the clock (see page 3).
No address book on camera (Connect with computer to import address book)	■ Create and copy address book from computer. See the Kodak EasyShare software Help.
No album names on camera (Connect with computer to import album names)	■ Create and copy album names from computer. See the Kodak EasyShare software Help.
High camera temperature. (Camera will be turned off.)	■ Leave the camera off for 10 minutes, then turn it back on.
Can only mark image with 32 album names. Only the first 32 album names will be saved	■ Delete one or more album names associated with the image (see page 36).
Unrecognized file format	■ Transfer the picture to the computer (see page 40), or delete it (see page 16).
Camera error #XXXX. See user's guide.	■ Turn camera off, then back on.

7

Getting help

Camera

Email, write, or phone customer support	www.kodak.com/go/contact
Get support for your product (FAQs, troubleshooting information, arrange for repairs, etc.)	www.kodak.com/go/m753support www.kodak.com/go/m853support www.kodak.com/go/md853support
Purchase camera accessories (camera docks, printer docks, lenses, cards, etc.)	www.kodak.com/go/m753accessories www.kodak.com/go/m853accessories www.kodak.com/go/md853accessories
Download the latest camera firmware and software	www.kodak.com/go/m753downloads www.kodak.com/go/m853downloads www.kodak.com/go/md853downloads
See online demonstrations of your camera	www.kodak.com/go/howto

Software

Get information on EasyShare software	www.kodak.com/go/easysharesw (or click the Help button in EasyShare software)
Get help with the Windows operating system and working with digital pictures	www.kodak.com/go/pcbasics

Other

Get support for other cameras, software, accessories	www.kodak.com/go/support
Get information on Kodak EasyShare printer docks	www.kodak.com/go/printerdocks
Get information on Kodak inkjet products	www.kodak.com/go/inkjet
Optimize your printer for truer, more vibrant colors	www.kodak.com/go/onetouch
Register your camera	www.kodak.com/go/register

NOTE: If you have questions concerning this product, you may speak with Kodak customer support.

Australia	1800 267 588	Netherlands	020 346 9372
Austria	0179 567 357	New Zealand	0800 880 120
Belgium	02 713 14 45	Norway	23 16 21 33
Brazil	0800 891 42 13	Philippines	1 800 1 888 9600
Canada	1 800 465 6325	Poland	00800 4411625
China	800 820 6027	Portugal	021 415 4125
Czech Republic	00 800 56325000	Russia	8 495 929 9166
Denmark	3 848 71 30	Singapore	800 6363 036
Ireland	01 407 3054	Slovakia	00 800 56325000
Finland	0800 1 17056	Spain	91 749 76 53
France	01 55 1740 77	Sweden	08 587 704 21
Germany	069 5007 0035	Switzerland	01 838 53 51
Greece	00800 44140775	Taiwan	0800 096 868
Hong Kong	800 901 514	Thailand	001 800 631 0017
Hungary	06 80 456 325	Turkey	00800 448827073
India	91 80 41374555 (toll free 000800 440 1227)	United Kingdom	0870 243 0270
Italy	02 696 33452	United States	1 800 235 6325
Japan	03 5540 9002	International Toll Line	+44 131 458 6714
Korea	080 708 5600	International Toll Fax	+44 131 458 6962

Camera specifications

For more specifications, visit www.kodak.com/go/m753support,
www.kodak.com/go/m853support, www.kodak.com/go/md853support.

CCD—1/2.5 in. CCD, 4:3 aspect ratio

Picture sizes—

M753

7.0 MP (4:3): 3056 x 2292 pixels
6.2 MP (3:2): 3056 x 2038 pixels
5.3 MP (16:9): 3056 x 1720 pixels
5.0 MP (4:3): 2592 x 1944 pixels
3.1 MP (4:3): 2048 x 1536 pixels
2.2 MP (3:2): 1800 x 1200 pixels
2.1 MP (16:9): 1920 x 1080 pixels
1.2 MP (4:3): 1280 x 960 pixels

M853/MD853

8.1 MP (4:3): 3296 x 2472 pixels
7.2 MP (3:2): 3296 x 2196 pixels
6.1 MP (16:9): 3296 x 1854 pixels
5.0 MP (16:9): 2592 x 1944 pixels
3.1 MP (4:3): 2048 x 1536 pixels
2.2 MP (3:2): 1800 x 1200 pixels
2.1 MP (16:9): 1920 x 1080 pixels
1.2 MP (4:3): 1280 x 960 pixels

Color display—6.4 cm (2.5 in.); 154K (640 x 240) pixels; 30 fps; field-of-view: 100%.

Taking lens—3X optical zoom lens f/2.8–f/5.2;
37 mm–111 mm (35 mm equivalent)

Lens barrier—Automatic built-in

Focus system—TTL-AF; selectable multi-zone AF, center-zone AF. Working range:
0.4 m (1.3 ft)–infinity @ normal

0.15–0.7 m (5.9–28 in.) @ close-up/macro, wide

0.40–0.7 m (15.7–28 in.) @ close-up/macro, tele

10 m (32.8 ft)–infinity @ Landscape

Digital zoom—5.0X continuous with 0.2X increments

Exposure metering—Multi-pattern, Center-weight, Spot

Exposure compensation—+/-2.0 EV with 0.3 EV steps

Shutter speed—Mechanical shutter with CCD; Auto: 4–1/1400 sec.

ISO speed—Auto: 80–200; Digital Image Stabilization, High ISO: 80–1000

Manual: 80, 100, 200, 400, 800, 1250 (selectable)

Electronic flash—Guide no. 7.0 (@ ISO 100); auto flash working range at ISO 200:

Wide: 0.6–3.5 m (2–11.5 ft.); Tele: 0.6–2.0 m (2–6.6 ft.)

Flash modes—Auto, Off, Fill, Red-eye

Capture modes—Auto, Digital Image Stabilization, Close-up, SCN, High ISO, Video

Video capture—VGA (640 x 480) @ 15 fps; QVGA (320 x 240) @ 30 fps

Image file format—Still: EXIF 2.21 (JPEG compression); file organization: DCF

Video: MOV; CODEC Motion JPEG; G.711 (audio)

Image storage—Optional SDHC/SD/MMC Card . (The SD logo is a trademark of the SD Card Association.)

Internal storage capacity—16 MB internal memory/11 MB available for image storage (1 MB equals one million bytes)

Power—Kodak Li-Ion rechargeable digital camera battery KLIC-7001; 5V AC adapter

Communication with computer—USB 2.0 Full Speed (PIMA 15740 protocol), via USB cable model U-8, EasyShare camera dock or printer dock

PictBridge support—Yes

Self Timer—2 seconds, 10 seconds, or 2-shot

White balance—Auto, Daylight, Tungsten, Fluorescent, Open Shade

Auto power off—Selectable 1, 3, 5, 10 minutes

Microphone—Yes (for audio recording at Video mode)

Color modes—Color (high, natural, low), Black & White, Sepia

Tripod mount—1/4 inch

Operating temperature—32–104°F (0–40°C)

Size—93 mm (3.7 in.) x 58 mm (2.3 in.) x 23 mm (0.9 in.) @ power off

Weight—145 g (5.1 oz.) without battery or card

Care and maintenance

- If you suspect water has gotten inside the camera, remove the battery and card. Allow all components to air-dry for at least 24 hours before using the camera.
- Blow gently on the lens or LCD to remove dust and dirt. Wipe gently with a soft, lint-free cloth or an untreated lens-cleaning tissue. Do not use cleaning solutions unless designed specifically for camera lenses. Do not allow chemicals, such as suntan lotion, to contact painted surfaces.
- Service agreements may be available in your country. Contact a dealer of Kodak products for more information.
- For digital camera disposal or recycling information, contact your local authorities. In the US, visit the Electronics Industry Alliance Web site at www.eiae.org or the Kodak Web site at www.kodak.com/go/m753support, www.kodak.com/go/m853support, www.kodak.com/go/md853support.

Upgrading your software and firmware

Download the latest versions of the software included on the Kodak EasyShare software CD and the camera firmware (the software that runs on the camera). Visit www.kodak.com/go/m753downloads, www.kodak.com/go/m853downloads, www.kodak.com/go/md853downloads.

Storage capacities

The LCD displays the approximate number of pictures (or minutes/seconds of video) remaining. For average SD card capacities, visit www.kodak.com/go/SDcapacities. Actual storage capacity varies depending on subject composition, card size, and other factors. You may be able to store more or fewer pictures and videos. Favorites take up additional space in internal memory.

Important safety instructions



CAUTION:

Do not disassemble this product; there are no user-serviceable parts inside. Refer servicing to qualified service personnel. Kodak AC adapters and battery chargers are intended for indoor use only. The use of controls, adjustments, or procedures other than those specified herein may result in exposure to shock and/or electrical or mechanical hazards. If the LCD breaks, do not touch the glass or liquid. Contact Kodak customer support.

- The use of an accessory that is not recommended by Kodak may cause fire, electric shock, or injury. For approved accessories, visit www.kodak.com/go/accessories.
- Use only a USB-certified computer equipped with a current-limiting motherboard. Contact your computer manufacturer if you have questions.
- If using this product in an airplane, observe all instructions of the airline.
- When removing the battery, allow it to cool; it may be hot.
- Read and follow all warnings and instructions supplied by the battery manufacturer.

- Use only batteries approved for this product to avoid risk of explosion.
- Keep batteries out of the reach of children.
- Do not allow batteries to touch metal objects, including coins. Otherwise, a battery may short circuit, discharge energy, become hot, or leak.
- Do not disassemble, install backward, or expose batteries to liquid, moisture, fire, or extreme temperature.
- Remove the battery when the product is stored for an extended period of time. In the unlikely event that battery fluid leaks inside the product, contact Kodak customer support.
- In the unlikely event that battery fluid leaks onto your skin, wash immediately with water and contact your local health provider. For additional health-related information, contact your local Kodak customer support.
- Dispose of batteries according to local and national regulations. Visit www.kodak.com/go/kes.
- Do not charge non-rechargeable batteries.

For more information on batteries, visit www.kodak.com/go/batterytupes.

Battery life

Kodak Li-Ion rechargeable
digital camera battery KLIC-7001

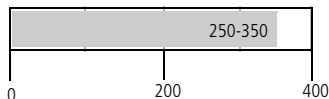

Approximate number of pictures in Auto mode
(CIPA testing method using internal memory.)

For acceptable battery life, and to make sure your camera operates dependably, use the batteries listed. Actual battery life may vary based on usage.

Extending battery life

- See Auto Power Off (see page 29).
- Limit the following activities that quickly deplete battery power:
 - Reviewing your pictures on the LCD (see page 14)
 - Excessive use of the flash
- Dirt on the battery contacts can affect battery life. Wipe the contacts with a clean, dry cloth before loading batteries in the camera.
- Battery performance is reduced at temperatures below 41° F (5° C). When using your camera in cold weather, carry spare batteries and keep them warm. Do not discard cold batteries that do not work; when they return to room temperature, they may be usable.

Limited Warranty

Kodak warrants Kodak consumer electronic products and accessories ("Products"), excluding batteries, to be free from malfunctions and defects in both materials and workmanship for one year from the date of purchase.

Retain the original dated sales receipt. Proof of the date of purchase will be required with any request for warranty repair.

Limited warranty coverage

Warranty service is only available from within the country where the Products were originally purchased. You may be required to ship Products, at your expense, to the authorized service facility for the country where the Products were purchased.

Kodak will repair or replace Products if they fail to function properly during the warranty period, subject to any conditions and/or limitations stated herein. Warranty service will include all labor as well as any necessary adjustments and/or replacement parts. If Kodak is unable to repair or replace a Product, Kodak will, at its option, refund the purchase price paid for the Product provided the Product has been returned to Kodak along with proof of the purchase price paid. Repair, replacement, or refund of the purchase price are the sole remedies under the warranty.

If replacement parts are used in making repairs, those parts may be remanufactured, or may contain remanufactured materials. If it is necessary to replace the entire Product, it may be replaced with a remanufactured Product. Remanufactured Products, parts, and materials are warranted for the remaining warranty term of the original Product, or 90 days after the date of repair or replacement, whichever is longer.

Limitations

This warranty does not cover circumstances beyond Kodak's control. This warranty does not apply when failure is due to shipping damage, accident, alteration, modification, unauthorized service, misuse, abuse, use with incompatible accessories or attachments (such as third party ink or ink tanks), failure to follow Kodak's operation, maintenance, or repacking instructions, failure to use items supplied by Kodak (such as adapters and cables), or claims made after the duration of this warranty.

Kodak makes no other express or implied warranty for this product, and disclaims the implied warranties of merchantability and fitness for a particular purpose. In the event that the exclusion of any implied warranty is ineffective under the law, the duration of the implied warranty will be one year from the purchase date or such longer period as required by law.

The option of repair, replacement, or refund is Kodak's only obligation. Kodak will not be responsible for any special, consequential or incidental damages resulting from the sale, purchase, or use of this product regardless of the cause. Liability for any special, consequential or incidental damages (including but not limited to loss of revenue or profit, downtime costs, loss of the use of the equipment, cost of substitute equipment, facilities or services, or claims of your customers for such damages resulting from the purchase, use, or failure of the Product), regardless of cause or for breach of any written or implied warranty is expressly disclaimed.

Your rights

Some states or jurisdictions do not allow exclusion or limitation of incidental or consequential damages, so the above limitation or exclusion may not apply to you. Some states or jurisdictions do not allow limitations on how long an implied warranty lasts, so the above limitation may not apply to you.

This warranty gives you specific rights, and you may have other rights which vary from state to state or by jurisdiction.

Outside the United States and Canada

In countries other than the United States and Canada, the terms and conditions of this warranty may be different. Unless a specific Kodak warranty is communicated to the purchaser in writing by a Kodak company, no warranty or liability exists beyond any minimum requirements imposed by law, even though defect, damage, or loss may be by negligence or other act.

Regulatory compliance

FCC compliance and advisory



Kodak EasyShare M753/M853/MD853 zoom digital

This equipment has been tested and found to comply with the limits for a Class B digital device, pursuant to Part 15 of the FCC Rules. These limits are designed to provide reasonable protection against harmful interference in a residential installation.

This equipment generates, uses, and can radiate radio frequency energy and, if not installed or used in accordance with the instructions, may cause harmful interference to radio communications. However, there is no guarantee that interference will not occur in a particular installation.

If this equipment does cause harmful interference to radio or television reception, which can be determined by turning the equipment off and on, the user is encouraged to try to correct the interference by one or more of the following measures: 1) reorient

or relocate the receiving antenna; 2) increase the separation between the equipment and the receiver; 3) connect the equipment to an outlet on a circuit different from that to which the receiver is connected; 4) consult the dealer or an experienced radio/TV technician for additional suggestions.

Any changes or modifications not expressly approved by the party responsible for compliance could void the user's authority to operate the equipment. Where shielded interface cables have been provided with the product or specified additional components or accessories elsewhere defined to be used with the installation of the product, they must be used in order to ensure compliance with FCC regulation.

Australian C-Tick



Canadian DOC statement

Observation des normes-Classe B

Cet appareil numérique de la classe B est conforme à la norme NMB-003 du Canada.

Waste Electrical and Electronic Equipment labeling



In the European Union, do not discard this product as unsorted municipal waste. Contact your local authorities or visit www.kodak.com/go/recycle for recycling program information.

Korean Class B ITE

이 기기는 가정용으로 전자파적합등록된 한 기기로서 주거지역에서는 물론 모든 지역에서 사용할 수 있습니다.

VCCI Class B ITE

この装置は、情報処理装置等電波障害自主規制協議会（VCCI）の基準に基づいてクラスB情報技術装置です。この装置は、家庭環境で使用することを目的としていますが、この装置がラジオやテレビジョン受信機に近接して使用されると、受信障害を引き起こすことがあります。
取扱説明書に従って正しい取り扱いをして下さい。

China RoHS

环保使用期限 (EPUP)

在中国大陆, 该值表示产品中存在的任何危险物质不得释放, 以免危及人身健康、财产或环境的时间期限(以年计)。该值根据操作说明中所规定的产品正常使用而定。

有毒有害物质或元素名称及含量标识表						
部件名称	有毒有害物质或元素					
	铅	汞	镉	六价铬	多溴联苯	多溴二苯醚
数码相机电路板元件	×	○	○	○	○	○
锂电池	×	○	○	○	○	○
交流变压器	×	○	○	○	○	○

○：表示该有毒有害物质在该部件所有均质材料中的含量均在SJ/T 11363-2006规定的限量要求以下。
×：表示该有毒有害物质至少在该部件的某一均质材料中的含量超出SJ/T 11363-2006规定的限量要求。



USB 数据线

Russian GOST-R



Eastman Kodak Company
Rochester, NY 14650

Фотокамера изготовлена в Китае; остальные элементы -
в соответствии с маркировкой.

Index

A

- about picture, video, 15
- about this camera, 30
- accessories, 40
 - battery, 57
 - buying, 50
 - printer dock, 41
 - SD/MMC card, 4
- album
 - tagging pictures, 37
- albums
 - set, 27
- appendix, 52
- auto, 9
 - flash, 8
 - focus framing marks, 6

B

- backlight, 11
- battery
 - charge, 2
 - compartment, ii
 - extending life, 57
 - loading, 1
 - types, 53
- beach, 10
- blur, 23
- blur warning, 30
- button
 - delete, 5
 - flash/status, 8
 - LCD/info, ii

- ok, ii
- on/off, i
- review, ii, 14
- share, ii
- shutter, i
- zoom, 7

C

- cable, USB, 40
- camera sounds, 29
- candle light, 11
- caring for your camera, 54
- charge battery, 2
- children, 11
- clock, setting, 3
- color mode, 27
- compatibility, dock, 43
- copy pictures
 - card to memory, 21
 - memory to card, 21
 - to computer, 39
- cropping pictures, 17, 18
- customer support, 50, 51
- customizing camera settings, 28

D

- date
 - setting, 3
 - stamp, 30
- DC-in, i
- deleting
 - during quickview, 5

from internal memory, 16
from SD/MMC card, 16
protecting pictures, videos, 16
digital image stabilization, 9
digital zoom, using, 7
displaying slide show, 19
disposal, recycling, 54, 60
dock
 compatibility, 43
 connector, ii
 printer, 41
doing more with your camera, 24
download pictures, 39

E

EasyShare software
 installing, 39
emailing pictures, videos, 33
exposure
 compensation, 31
 long time, 27
 metering, 26

F

favorites
 removing, 35
 settings, 35
 tagging, 34
fireworks, 10
firmware, upgrading, 55
flash
 settings, 8
flower, 10
focus

framing marks, 6
 zone, 27
format, 30
framing grid, 31

G

grid, framing, 31
guidelines, battery, 57

H

help, 44

I

icon
 blur, 23
icons, mode dial, 9
image storage, 28
information
 about pictures, videos, 15
installing
 batteries, 1
 SD/MMC card, 4
 software, 39
internal memory
 storage capacity, 55
ISO speed, 26

K

Kodak
 EasyShare software, 39, 55
 Perfect Touch technology, 17

L

landscape, 10
LCD, ii

- brightness, 29
 - reviewing pictures, 14
 - reviewing videos, 14
- LCD/info button, ii
- lens
 - cleaning lens, 54
- loading
 - batteries, 1
 - SD/MMC card, 4
 - software, 39
- long time exposure, 27

M

- Macintosh computers, installing
 - software on, 39
- maintenance, camera, 54
- manner/museum, 11
- memory
 - inserting card, 4
 - storage capacities, 55
- mode dial, i, 9
- modes
 - auto, 9
 - backlight, 11
 - beach, 10
 - candle light, 11
 - children, 11
 - fireworks, 10
 - flower, 10
 - landscape, 10
 - manner/museum, 11
 - night landscape, 10
 - night portrait, 10
 - portrait, 10

- SCN, 9
- self-portrait, 11
- snow, 10
- sports, 10
- sunset, 11
- text/document, 10

N

- night landscape, 10
- night portrait, 10

O

- ok button, ii
- on/off button, i
- online prints, ordering, 43
- optical zoom, 7
- orientation sensor, 29

P

- panoramic pictures, 12
- Perfect Touch technology, 17
- PictBridge enabled printer, 41
- picture size, 25
- pictures
 - checking settings, 22
 - copying, 21
 - cropping, 17, 18
 - deleting, 16
 - emailing tagged, 33
 - printing, 42
 - protecting, 16
 - reviewing, 14
 - storage capacity, 55
 - tagging, 37
 - taking, modes, 9

- transfer, 39
- picture-taking settings, 24
- portrait, 10
- power, camera, 3
- printer dock, 41
- printing
 - from a card, 43
 - from computer, 42
 - order online, 43
 - PictBridge technology, 41
 - tagged pictures, 43
 - with EasyShare printer dock, 41
- problem-solving, 44
- protecting pictures, videos, 16

Q

- quickview, using, 5

R

- recycling, disposal, 54, 60
- red-eye, flash, 8
- regulatory information, 59
- removing favorites, 35
- repair, 50
- return, 29
- review button, ii, 14
- reviewing pictures
 - as you take them, 5
 - deleting, 16
 - LCD, 14
 - protecting, 16
 - slide show, 19
- reviewing videos
 - deleting, 16

- LCD, 14
 - protecting, 16
 - slide show, 19
- running slide show, 19

S

- scene modes, 10
 - panorama, 12
- SCN, 9
- SD/MMC card
 - inserting, 4
 - printing from, 43
 - storage capacities, 55
- self-portrait, 11
- self-timer light, i
- service and support telephone
 - numbers, 51
- setting
 - about, 30
 - blur warning, 30
 - camera sounds, 29
 - color mode, 27
 - date and time, 3
 - date stamp, 30
 - exposure metering, 26
 - flash, 8
 - focus zone, 27
 - image storage, 28
 - ISO, 26
 - LCD brightness, 29
 - long time exposure, 27
 - orientation sensor, 29
 - picture size, 25
 - picture taking mode, 9

- return, 29
- sound volume, 29
- video date display, 30
- video out, 29
- video size, 28
- white balance, 26
- setting, albums, 27
- settings
 - picture taking, 24
- setup mode, using, 28
- shaking hand, 23
- share button, ii
- sharing pictures, videos, 31
- shutter
 - button, i
 - problems, 45
- slide show
 - continuous loop, 20
 - running, 19
- snow, 10
- software
 - installing, 39
 - upgrading, 55
- sound volume, 29
- sounds, 29
- specifications, camera, 52
- sports, 10
- status
 - blur, 23
- storage capacity, 55
- strap post, ii
- sunset, 11
- support, technical, 50, 51

T

- tagging
 - favorites, 34
 - for albums, 37
 - for email, 33
 - for print, 32
- telephone support, 51
- text/document, 10
- time, setting, 3
- tips
 - care & maintenance, 54
- transferring pictures, videos, 39
- trash can, deleting, 5
- tripod socket, ii
- troubleshooting, 44
- turning camera on and off, 3

U

- upgrading software, firmware, 55
- USB cable, 40
- USB, A/V out, i

V

- VCCI compliance, 61
- video
 - action print, 19
 - checking settings, 22
 - copying, 21
 - date display, 30
 - deleting, 16
 - out, 29
 - protecting, 16
 - reviewing, 14
 - size, 28

- storage capacities, 55
- viewing, 14
- videos
 - emailing tagged, 33
 - transfer, 39
- viewing picture
 - after taking, 5, 14
- viewing picture, video information, 15
- volume, 29

W

- warranty, 57
- WEEE, 60
- white balance, 26
- Windows OS-based computers
 - installing software, 39
- wrist strap, 1

Z

- zoom
 - digital, 7
 - optical, 7