

1 Charge and load the batteries

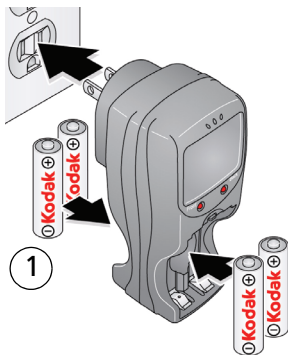

Lights are on while the charger is plugged in. (See the charger documentation for instructions and charging times.)

For longer life, charge KODAK Ni-MH Rechargeable Batteries AA prior to use, and occasionally discharge them to depletion.

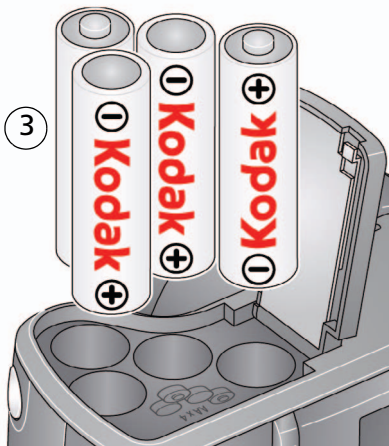

2 Attach the strap



3 Turn on the camera

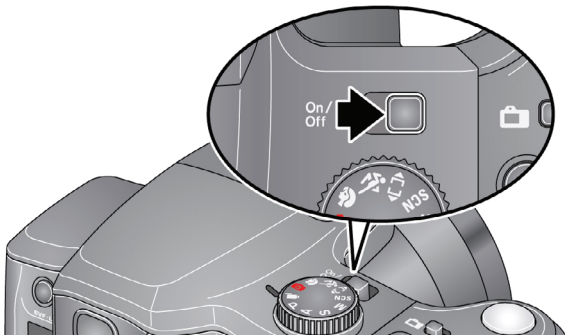

4 Set the language and date/time

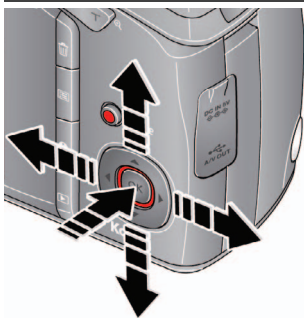

Language:

▲▼ to change.

OK to accept.

Date/Time:

At the prompt, press OK.

▲▼ to change current field.

◀▶ for previous/next field.

OK to accept.

See the Extended user guide www.kodak.com/go/z981support

5 Take a picture

1 Turn the Mode dial to Smart Capture .

2 Press the Shutter button halfway to lock the focus. When the framing marks turn green, press the Shutter button completely down.

To save battery power, press the EVF/LCD button and use the electronic viewfinder.



Framing marks



See other modes



see [page 10](#)

See the Extended user guide www.kodak.com/go/z981support

6 Review pictures/videos



Review

- 1 Press the Review  button to enter/exit Review.
- 2  View previous/
next picture or
video.
OK Play a video.

See the Extended user guide www.kodak.com/go/z981support

7 Download software, transfer pictures

When you connect the camera to the computer, it prompts you to run the KODAK Software Downloader on your computer.

Make sure the computer is connected to the Internet. When you connect the camera to the computer, the KODAK Software Downloader automatically runs. Follow the prompts to download and install KODAK Software.



- 1 Turn off the camera.
- 2 Use the KODAK Camera USB Cable, U-8 to connect camera to computer. (Use only the cable included with this camera!)
- 3 Turn on the camera.
- 4 After the software is installed, follow the prompts to transfer pictures and videos to your computer.

NOTE: If the downloader does not run, find it here and launch it:



- WINDOWS OS: in My Computer
- MAC OS: on your Desktop

Download KODAK Software www.kodak.com/go/camerasw

To use this camera on more than one computer See the Extended user guide at www.kodak.com/go/z981support

8 Use the camera Help system



- 1 Press the Menu  button, then highlight a menu choice.
- 2 Press the Info  button.
 Scroll through a Help topic.

Keep learning about your camera!

Go to www.kodak.com/go/z981support for:

- the Extended user guide
- interactive troubleshooting and repairs
- interactive tutorials
- and more!

See the Extended user guide www.kodak.com/go/z981support

Back View

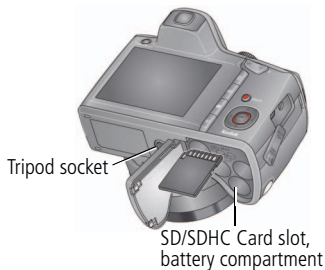
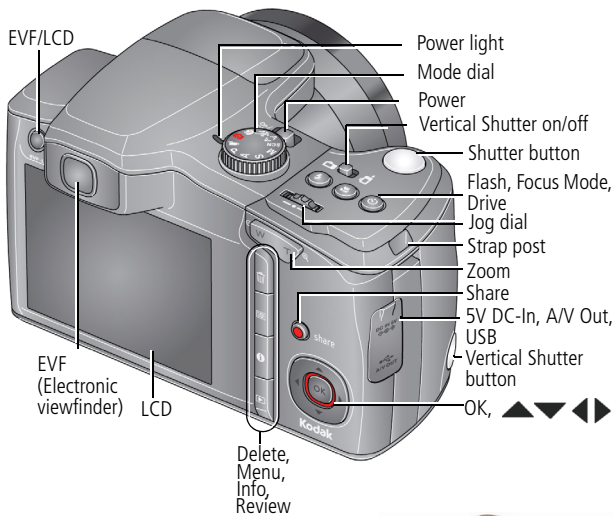

Front View

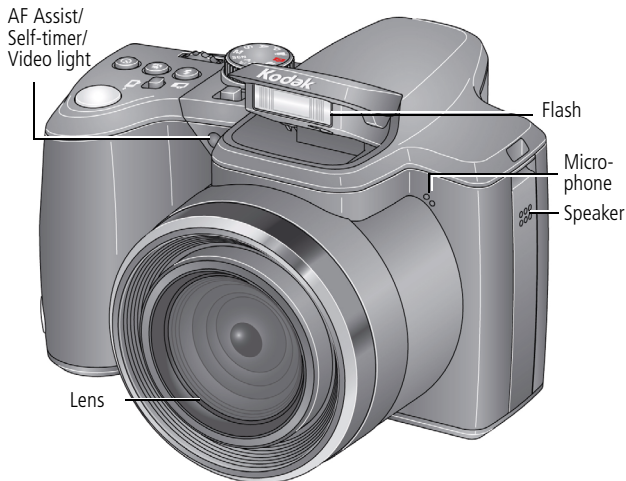



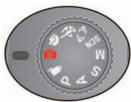

1

Do more with your camera



Choose the mode that best suits your subjects and surroundings.

Capture mode	For
 Smart Capture	Excellent image quality and ease of use.
 Portrait	Full-frame portraits of people.
 Sport	Subjects that are in motion. Shutter speed is fast.
 Panorama	"Stitching" 2 or 3 pictures into 1 panoramic scene.
SCN Scene	Point-and-shoot simplicity when taking pictures under special conditions.
P Program	More creative control (see page 14).
A Aperture Priority	
S Shutter Priority	
M Manual	
 Video	Video with sound (see page 11).

NOTE: To adjust the LCD brightness for your environment, see the Extended user guide (www.kodak.com/go/z981support).





Take a video



- 1 Turn the Mode dial to Video

- 2 Press the Shutter button **completely down**, then release it. To stop recording, press and release the Shutter button again.

Use Scene (SCN) modes

Choose a Scene mode—for great pictures in any situation.

- 1 Turn the Mode dial to SCN.
- 2 Press     to choose a mode and read its description.
- 3 Press OK (or let the description turn off) to enter the chosen Scene mode.

To read a mode description after it has turned off, press OK.

SCN modes: High ISO, Night Portrait, Landscape, Night Landscape, Flower, Sunset, Backlight, Candle light, Manner/Museum, Text, Beach, Snow, Fireworks, Children, Self-Portrait, and Stage.





See the Extended user guide www.kodak.com/go/z981support

Use the flash



Press the Flash button repeatedly to scroll through flash modes.

The current flash mode appears on the LCD or EVF.

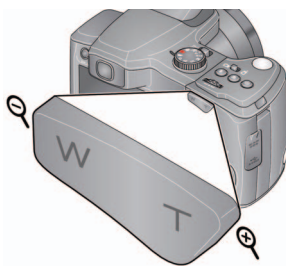

Flash modes		Flash fires
Auto		When the lighting conditions require it.
Fill (Flash On)		Every time you take a picture, regardless of the lighting conditions. Use when the subject is in shadow or is "backlit" (when the light is behind the subject). NOTE: Not available in Smart Capture mode.
Red-eye Reduction Choose a setting in the Setup menu.		A preflash fires, shrinking the eye pupil, before the picture is taken.
		A preflash does not fire; the camera corrects red eye. NOTE: When using digital correction, image processing takes longer than when using preflash.
Off		Never

Use the optical zoom



- 1 Use the LCD or EVF to frame your subject.
- 2 To zoom in, press Telephoto (T). To zoom out, press Wide Angle (W).
- 3 Take the picture.

Delete pictures/videos

- 1 Press the Review  button.
- 2 Press  for previous/next picture/video.
- 3 Press the Delete button.
- 4 Follow the screen prompts.

See the Extended user guide www.kodak.com/go/z981support

P, A, S, and M modes

Use these modes for more control over your camera.





Jog dial

Mode	When to use	Press Jog dial to control
P	Program mode offers the ease of auto shooting with access to all menu options.	Exposure compensation (how much light enters the camera), flash compensation, and ISO speed
A	Aperture Priority mode controls depth of field (the range of sharpness).	Aperture, exposure compensation, flash compensation, and ISO speed
S	Shutter Priority mode controls shutter speed.	Shutter speed, exposure compensation, and flash compensation
M	Manual mode offers the highest level of creative control.	Aperture, shutter speed, flash compensation, and ISO speed

See the **Extended user guide** www.kodak.com/go/z981support

Use the menu button to change settings

You can change settings to get the best results from your camera. Some modes offer limited settings.

- 1 Press the Menu  button.
- 2 Press  to choose a tab:
 - **Capture/Video** for the most common picture- and video-taking settings
 - **Setup** for other camera settings
- 3 Press  to choose a setting, then press OK.
- 4 Choose an option, then press OK.

To access the camera Help system, see [page 7](#).

Understand the picture-taking icons

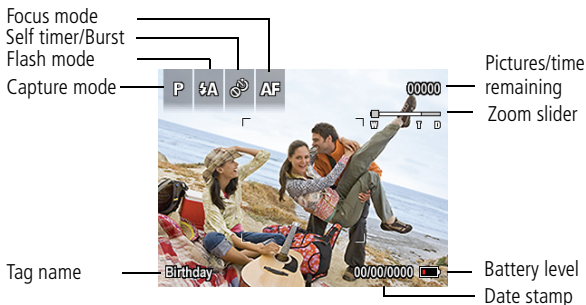



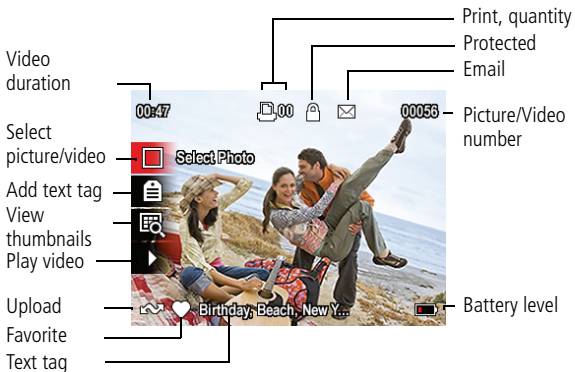

Understand the review icons





See the Extended user guide www.kodak.com/go/z981support

It's never been easier to share pictures on your favorite social networking sites.

IMPORTANT: *To use the social networking features, you need to download KODAK Software. (See page 6.)*

- 1 Press the Review  button, then   to find a picture.
- 2 Press the Share button.
If it's your first time, a Help screen appears.
- 3 Press   to choose a social networking site, then press OK.

A check mark appears. Repeat this step to choose more sites. (Press OK again to remove a check mark.)

- 4 Press   to choose Done, then press OK.

The picture is displayed with the Share icon. When you transfer the picture to your computer, it will be sent to the networking site(s) that you chose.











Tip: Do you send pictures to the same sites each time?

Find a picture, then press and hold the Share button for about 1 second.

The camera applies the networking site(s) that you used previously and adds the Share icon to the picture.

Choose networking sites to show

You can show/hide social networking sites on your camera so that only your favorite sites appear.

- 1 In Review, press the Menu  button.
- 2 Press   to choose the Setup tab, then   to choose Share Button Settings, then press OK.
- 3 Press   to choose a social networking site, then press   to choose Show/Hide. Repeat this step for each network.
- 4 When finished, press   to choose Done, then press OK.

To return to picture-taking mode, press the Shutter button halfway down. When you are in Review and press the Share button, your chosen sites appear.

To access the camera Help system, see [page 7](#).

Manage email addresses and KODAK PULSE Digital Frames

You can add, edit, or delete email addresses and KODAK PULSE Digital Frames on your camera.

- 1 In Review, press the Share button. Press ▲▼ to choose Manage Email Addresses (or Manage Frames), then press OK.
- 2 To add an email address or frame, press ▲▼ to choose New Email or New Frame, then press OK. Use the on-screen keyboard to make the addition.
(Example: JohnDoe@domain.com)

To edit an email address or frame, press ▲▼ to choose the address's nickname ("Dad" or "Mary") or the frame, then press OK. Use the on-screen keyboard to make edits.

To delete an email address or frame, choose Delete Email or Delete Frame, then press OK. Press ▲▼ to choose the address or frame, then press OK so that a check mark appears. Press ▲▼ to choose Delete, then press OK.

- 3 When finished, press ▲▼ to choose Done, then press OK.

Use the keyboard

The keyboard appears when you need it.

- 1 Press ◀▶ ▲▼ to choose a letter, then press OK.
- 2 When finished, press ▲▼ to choose OK, then press OK.
- 3 If you've added a new name, the camera prompts you to update all faces to match assigned names. Choose Yes, then press OK.

The name is assigned to all faces that match this one.







Tag pictures

Tag pictures to make them easy to find, later. You can tag pictures in 2 ways:

- **People**, and then find all pictures of "Mary."
- **Keywords**, and then find all pictures from "Dad's 60th Birthday."

Tag people



When you tag faces, you're helping your camera to recognize people by name. Then it matches names and faces in pictures you've taken—and those you take in the future!

- 1 Press the Review  button, then  to find a picture that contains faces.
- 2 Press the Menu  button. Press  to choose Tag People, then press OK.
- 3 Press  to choose Apply Tags, then press OK.
- 4 Press  to choose an existing name, or New Name to add a new one, then press OK.

If more than one face is detected, a name or question mark is assigned to each detected face. To resolve an incorrect name or a question mark, press  to select a face, then press OK.

- 5 If prompted to Update People Tags, press  to choose Yes, then press OK.



Other pictures are scanned and updated with the name(s) you applied here.

Press  to add names to other pictures. When finished, press  to choose Done, then press OK. To return to picture-taking mode, press the Shutter button halfway down.

To access the camera Help system, see [page 7](#).

Need to update a name?

If you meet a new friend—James—but you already have pictures tagged with an old friend, James, you can:













- Tag the new James with “James Smith” and/or
 - Update the old James to “James Monroe”
- 1 Press the Review  button.
 - 2 Press the Menu  button. Press ▲▼ to choose Tag People, then press OK.
 - 3 Press ▲▼ to choose Modify Names List, then press OK.
 - 4 Press ▲▼ to choose the name you want to modify, then press OK.
 - 5 Edit the name, press ▲▼ to choose OK, then press OK. (If prompted to Update People Tags, press ▲▼ to choose Yes, then press OK.)

To return to picture-taking mode, press the Shutter button halfway down.

NOTE: You can have up to 20 active names.

To access the camera Help system, see [page 7](#).

Tag with keywords

- 1 Press the Review  button, then   to find a picture.
- 2 Press the Menu  button. Press   to choose Keyword Tag, then press OK.
- 3 Press   to choose an existing keyword or New Keyword to add a new one, then press OK.
- 4 Press   to add keywords to other pictures. When finished, press   to choose Done, then press OK.



To return to picture-taking mode, press the Shutter button halfway down.

Tip: You can pre-choose a tag so that new pictures/videos are assigned that tag. See the Extended user guide at www.kodak.com/go/z981support.

To access the camera Help system, see [page 7](#).

A smarter way to find your pictures

Tag pictures—by people or keywords—to make them easy to find, later. For example, the camera can find all pictures that contain “Mary” or “Dad’s 60th Birthday.” (See [Tag people, page 21](#) or [Tag with keywords, page 23](#).)

- 1 Press the Review  button.
- 2 Press the Wide Angle (W) button to view pictures by thumbnail (or choose View Thumbnails shortcut).
- 3 Press  to choose a tab and sort pictures by All, Date, People, Favorite, or Keyword.
- 4 Press  to choose a picture or picture stack.

Press Telephoto (T) to see pictures in a stack or to see an individual picture. Press Wide Angle (W) to see thumbnails or picture stacks. To return to picture-taking mode, press the Shutter button halfway down.

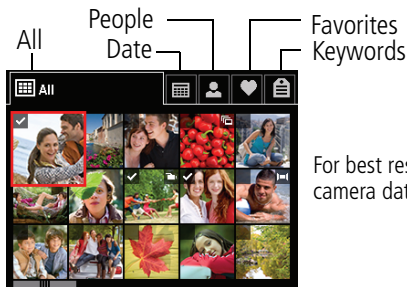

For best results, make sure the camera date/time is current.

3

Solve camera problems

To access the camera Help system, see [page 7](#).

Status	Solution
Camera does not turn on or off	<ul style="list-style-type: none">■ Make sure the batteries are charged and installed correctly (see page 1).
Camera buttons and controls do not function	
Flash does not fire	<ul style="list-style-type: none">■ Check the flash setting, and change as needed (see page 12). <p>NOTE: The flash does not fire in all modes.</p>
In Review, a blue or black screen is displayed instead of a picture	<ul style="list-style-type: none">■ Transfer <i>all</i> pictures to the computer (see page 6).■ Take another picture.
You cannot take a picture	<ul style="list-style-type: none">■ Turn the camera off, then on again.■ Press the Shutter button all the way (see page 4).■ Insert new or charged batteries (see page 1).■ Memory is full. Transfer pictures to the computer (see page 6), delete pictures (see page 13), or insert another card.

See the Extended user guide www.kodak.com/go/z981support



CAUTION:

Do not disassemble this product; there are no user-serviceable parts inside. Refer servicing to qualified service personnel. KODAK AC Adapters and Battery Chargers are intended for indoor use only. The use of controls, adjustments, or procedures other than those specified herein may result in exposure to shock and/or electrical or mechanical hazards. If the LCD breaks, do not touch the glass or liquid. Contact Kodak customer support.

- The use of an accessory that is not recommended by Kodak may cause fire, electric shock, or injury. For approved accessories, go to www.kodak.com/go/accessories.
- Use only a USB-certified computer equipped with a current-limiting motherboard. Contact your computer manufacturer if you have questions.
- If using this product in an airplane, observe all instructions of the airline.
- When removing the batteries, allow them to cool; they may be hot.
- Follow all warnings and instructions supplied by the battery manufacturer.
- Use only batteries approved for this product to avoid risk of explosion.
- Keep batteries out of the reach of children.
- Do not allow batteries to touch metal objects, including coins. Otherwise, a battery may short circuit, discharge energy, become hot, or leak.
- Do not disassemble, install backward, or expose batteries to liquid, moisture, fire, or extreme temperature.
- Remove the batteries when the product is stored for an extended period of time. In the unlikely event that battery fluid leaks inside the product, contact Kodak customer support.
- In the unlikely event that battery fluid leaks onto your skin, wash immediately with water and contact your local health provider. For additional health-related information, contact your local Kodak customer support.
- See www.kodak.com/go/reach for information about the presence of substances included on the candidate list according to article 59(1) of Regulation (EC) No. 1907/2006 (REACH).
- Dispose of batteries according to local and national regulations. Go to www.kodak.com/go/kes.
- Do not charge non-rechargeable batteries.
For more information on batteries, see www.kodak.com/go/batterytupes.

Limited Warranty

Kodak warrants its digital cameras and accessories (excluding batteries) to be free from malfunctions and defects in both materials and workmanship for the warranty period specified on your KODAK Product packaging. Retain the original dated sales receipt. Proof of purchase date is required with any request for warranty repair.

Limited warranty coverage

Warranty service is only available from within the country where the products were originally purchased. You may be required to ship products, at your expense, to the authorized service facility for the country where the products were purchased. Kodak will repair or replace products if they fail to function properly during the warranty period, subject to any conditions and/or limitations stated herein. Warranty service will include all labor as well as any necessary adjustments and/or replacement parts. If Kodak is unable to repair or replace a product, Kodak will, at its option, refund the purchase price paid for the product provided the product has been returned to Kodak along with proof of the purchase price paid. Repair, replacement, or refund of the purchase price are the sole remedies under the warranty. If replacement parts are used in making repairs, those parts may be remanufactured, or may contain remanufactured materials. If it is necessary to replace the entire product, it may be replaced with a remanufactured product. Remanufactured products, parts and materials are warranted for the remaining warranty term of the original product, or 90 days after the date of repair or replacement, whichever is longer.

Limitations

This warranty does not cover circumstances beyond Kodak's control. This warranty does not apply when failure is due to shipping damage, accident, alteration, modification, unauthorized service, misuse, abuse, use with incompatible accessories or attachments (such as third party ink or ink tanks), failure to follow Kodak's operation, maintenance or repacking instructions, failure to use items supplied by Kodak (such as adapters and cables), or claims made after the duration of this warranty. **Kodak makes no other express or implied warranty for this product, and disclaims the implied warranties of merchantability and fitness for a particular purpose.** In the event that the exclusion of any implied warranty is ineffective under the law, the duration of the implied warranty will be one year from the purchase date or such longer period as required by law. The option of repair, replacement, or refund is Kodak's only obligation. Kodak will not be responsible for any special, consequential or incidental damages resulting from the sale, purchase, or use of this product regardless of the cause. Liability for any special, consequential or incidental damages (including but not limited to loss of revenue or profit, downtime costs, loss of the use of the equipment, cost of substitute equipment, facilities or services, or claims of your customers for such damages resulting from the purchase, use, or failure of the product), regardless of cause or for breach of any written or implied warranty is expressly disclaimed. The limitations and exclusions of liability set forth herein apply to both Kodak and its suppliers.

Your rights

Some states or jurisdictions do not allow exclusion or limitation of incidental or consequential damages, so the above limitation or exclusion may not apply to you. Some states or jurisdictions do not allow limitations on how long an implied warranty lasts, so the above limitation may not apply to you. This warranty gives you specific rights, and you may have other rights which vary from state to state or by jurisdiction.

Outside the United States and Canada

In countries other than the United States and Canada, the terms and conditions of this warranty may be different. Unless a specific Kodak warranty is communicated to the purchaser in writing by a Kodak company, no warranty or liability exists beyond any minimum requirements imposed by law, even though defect, damage, or loss may be by negligence or other act.

FCC compliance and advisory

This equipment has been tested and found to comply with the limits for a Class B digital device, pursuant to Part 15 of the FCC Rules. These limits are designed to provide reasonable protection against harmful interference in a residential installation.

Canadian DOC statement

DOC Class B Compliance—This Class B digital apparatus complies with Canadian ICES-003.

Observation des normes-Classe B—Cet appareil numérique de la classe B est conforme à la norme NMB-003 du Canada.

Australian C-Tick



N137

VCCI Class B ITE

この装置は、情報処理装置等電波障害自主規制協議会（VCCI）の基準に基づくクラスB情報技術装置です。この装置は、家庭環境で使用することを目的としていますが、この装置がラジオやテレビジョン受信機に近接して使用されると、受信障害を引き起こすことがあります。
取扱説明書に従って正しい取り扱いをして下さい。

Korean Class B ITE

B급 기기 (가정용 방송통신기기)	이 기기는 가정용(B급)으로 전자파적합등록을 한 기기로서 주로 가정에서 사용하는 것을 목적 으로 하며, 모든 지역에서 사용할 수 있습니다.
-----------------------	---

China RoHS

环保使用期限 (EPUP)

在中国大陆, 该值表示产品中存在的任何危险物质不得释放, 以免危及人身健康、财产或环境的时间期限 (以年计)。该值根据操作说明中所规定的产品正常使用而定。

有毒有害物质或元素名称及含量标识表						
部件名称	有毒有害物质或元素					
	铅	汞	镉	六价铬	多溴联苯	多溴二苯醚
数码相机电路板元件	×	○	○	○	○	○
充电电池	×	○	○	○	○	○
电池充电器电路板元件	×	○	○	○	○	○

○: 表示该有毒有害物质在该部件所有均质材料中的含量均在SJ/T 11363-2006规定的限量要求以下。
 ×: 表示该有毒有害物质至少在该部件的某一均质材料中的含量超出SJ/T 11363-2006规定的限量要求。



USB 数据线

Kodak

Eastman Kodak Company
 Rochester, New York 14650

© Kodak, 2009

Kodak, EasyShare, and Pulse are trademarks of Eastman Kodak Company.

4H6893_en