



KODEN

OPERATION MANUAL

MARINE RADAR

MDC-7000P

SERIES

MDC-7900P

SERIES

This product is specifically designed to be installed on boats and other means of maritime transport. If your country forms part to the EU, please contact your dealer for advice before attempting to install elsewhere.

MDC-7000P/7900P Series Operation Manual**Doc No: 0093169006****Document Revision History**

No.	Doc. No.- Rev. No.	Date Revised (Y/M/D)	Revised Content
0	0093169006-05	2015/08/30	First edition
1	0093169006-05A	2016/03/09	Wording
2	0093169006-05B	2016/04/08	Chapter 2 EXPANSION, Wording
3	0093169006-05C	2016/05/20	Revised document code of cover, Chapter 2, Chapter 9
4	0093169006-05D	2016/12/12	DATUM [TOY] and SEA OFFSET addition, Correction
5	0093169006-05E	2016/12/22	For Your Safe Operation FCC/IC addition, Chapter 6 C-MAP chart display addition
6			
7			
8			
9			
10			

Document No. Revised Version Norm

When part of the document needs to be revised, the document has advanced revision number.

The document No. is indicated at the lower right side on the cover and at the left or right side of the footer region of each page.

© 2015-2016 Kodan Electronics Co., Ltd. All rights reserved.

No part of this publication may be reproduced, transmitted, translated in any form by any means without the written permission of Kodan Electronics Co., Ltd. The technical descriptions contained in this publication are subject to change without notice. Kodan assumes no responsibility for any errors, incidentals or consequential damages caused by misinterpretation of the descriptions contained in this publication.





Important Notice

- For copy and transcription of this Operation Manual (hereinafter referred to as this manual), permission from Koden is needed. Koden prohibits the un-authorized copy and transcription of this manual.
- If this manual is lost or damaged, consult a dealer of Koden or Koden.
- The specification of the products and the contents in this manual are subject to change without notice.
- The contents displayed on the menu of product may be different from the expression of this manual. The fonts and shapes of the keys and menus in the illustration may differ from the actual ones, and some parts may be omitted.
- Koden is not liable for damages and troubles arisen from misunderstanding of the contents in this manual.
- Koden is not liable for any damages caused by earthquake, lightning, wind and flood damage and fire for which Koden is not responsible, and actions by third parties, other accidents, customer's unintended error/abuse and the use under other abnormal conditions.
- Koden is not liable for damages of accompaniment (change/loss of memorized content, loss of business profit, stop of business) arisen from use or failure of our products.
- If the stored data are changed or lost, irrespective of causes of troubles and damages, Koden is not liable for them.
- Koden is not liable for any damages arisen from malfunction caused by combination of software and connected equipment in which Koden is not engaged.





For Your Safe Operation

Symbols used in this Operation Manual

This manual uses the following symbols. Understand the meaning of each symbol and implement the maintenance and inspection.

Symbol	Meaning
 Warning	Warning Symbol This symbol denotes that there is a risk of death or serious injury when not dealt with it correctly.
	High Voltage Danger Symbol This symbol denotes that there is a risk of death or serious injury caused by electric shock when not dealt with it correctly.
 Caution	Caution Symbol This symbol denotes that there is a risk of slight injury or damage of device when not dealt with it correctly.
	Prohibition Symbol This symbol denotes restriction of the specified conduct. Description of the restriction is displayed near the mark.
IMPORTANT	Important Symbol This mark indicates important area where attention is needed. This may include possible data lose or other issues that may interfere with radar operation.
	Reference Symbol This mark shows the part to be referred to concerning this description.

Caution related to Equipment

	<p>Caution, high voltage inside.</p> <p>High voltage that may cause severe injury or death is present. High voltage remains in circuit even after power is turned off. High voltage circuit has a protective cover with a warning label. Make sure to turn off power and discharge capacitors before working on the system. Only authorized personnel should access this circuit for repair and maintenance.</p>
 <p>Warning</p>	<p>Confirm main power is turned off before servicing the equipment.</p> <p>If power switch is turned on while working on the system, possible severe injury or death may occur due to high voltage. Make sure main power is off and a label “Work In Progress” is attached to the breaker powering the system.</p>
 <p>Warning</p>	<p>Caution related to dust</p> <p>Inhaling dust may cause A respiratory disease. When cleaning the inside of equipment, be careful not to inhale dust. Wearing a safety mask is recommended.</p>
 <p>Caution</p>	<p>When choosing equipment location</p> <p>Do not install the equipment where it is excessively damp, humid and under direct dripping water.</p>
 <p>Caution</p>	<p>Caution related to static electricity</p> <p>Static electricity may be generated from floor carpet or synthetic clothes. Static may destroy some electronics parts of the circuit and therefore anti-static measures should be done.</p>

Caution related to Handling

 Caution	<p>Caution related to rotating aerial</p> <p>The radar antenna may start rotating to rotate without notice. Please stand clear from the antenna for your safety.</p>
--	---

ENGLISH

 Caution	<p>Caution related to electromagnetic disturbance</p> <p>The operating Antenna & Scanner unit radiates high-energy electromagnetic wave. It may cause harmful effect for human body due to its continuous radiation. As International regulation says, electromagnetic waves less than 100 watt/m² does not have a harmful effect on human bodies, but some kind of medical devices such as heart pacemakers are sensitive even under the low energy electromagnetic wave. Any personnel with such a device should keep away from the electromagnetic wave generating position at all times.</p> <p>Specified power density and distance from the radar (in accordance with the provision as specified in IEC 60945)</p> <table border="1" style="width: 100%; border-collapse: collapse;"> <thead> <tr> <th style="text-align: left;">Model name</th> <th style="text-align: left;">Transmission power / Antenna length</th> <th style="text-align: center;">100W/m²</th> <th style="text-align: center;">50W/m²</th> <th style="text-align: center;">10W/m²</th> </tr> </thead> <tbody> <tr> <td>MDC-7012P</td> <td>12kW / 4 feet Antenna</td> <td style="text-align: center;">2.01m</td> <td style="text-align: center;">2.84m</td> <td style="text-align: center;">6.34m</td> </tr> <tr> <td rowspan="2">MDC-7912P</td> <td>12kW / 6 feet Antenna</td> <td style="text-align: center;">2.38m</td> <td style="text-align: center;">3.37m</td> <td style="text-align: center;">7.54m</td> </tr> <tr> <td>12kW / 9 feet Antenna</td> <td style="text-align: center;">2.83m</td> <td style="text-align: center;">4.01m</td> <td style="text-align: center;">8.96m</td> </tr> <tr> <td>MDC-7025P</td> <td>25kW / 4 feet Antenna</td> <td style="text-align: center;">2.89m</td> <td style="text-align: center;">4.09m</td> <td style="text-align: center;">9.15m</td> </tr> <tr> <td rowspan="2">MDC-7925P</td> <td>25kW / 6 feet Antenna</td> <td style="text-align: center;">3.44m</td> <td style="text-align: center;">4.86m</td> <td style="text-align: center;">10.88m</td> </tr> <tr> <td>25kW / 9 feet Antenna</td> <td style="text-align: center;">4.09m</td> <td style="text-align: center;">5.78m</td> <td style="text-align: center;">12.93m</td> </tr> </tbody> </table>	Model name	Transmission power / Antenna length	100W/m ²	50W/m ²	10W/m ²	MDC-7012P	12kW / 4 feet Antenna	2.01m	2.84m	6.34m	MDC-7912P	12kW / 6 feet Antenna	2.38m	3.37m	7.54m	12kW / 9 feet Antenna	2.83m	4.01m	8.96m	MDC-7025P	25kW / 4 feet Antenna	2.89m	4.09m	9.15m	MDC-7925P	25kW / 6 feet Antenna	3.44m	4.86m	10.88m	25kW / 9 feet Antenna	4.09m	5.78m	12.93m
Model name	Transmission power / Antenna length	100W/m ²	50W/m ²	10W/m ²																														
MDC-7012P	12kW / 4 feet Antenna	2.01m	2.84m	6.34m																														
MDC-7912P	12kW / 6 feet Antenna	2.38m	3.37m	7.54m																														
	12kW / 9 feet Antenna	2.83m	4.01m	8.96m																														
MDC-7025P	25kW / 4 feet Antenna	2.89m	4.09m	9.15m																														
MDC-7925P	25kW / 6 feet Antenna	3.44m	4.86m	10.88m																														
	25kW / 9 feet Antenna	4.09m	5.78m	12.93m																														

FRENCH:



Caution

Mise en garde relative aux perturbations électromagnétiques produites par les radars de navire

L'antenne & l'émetteur des radars de navire ont un rayonnement d'ondes électromagnétique de haute intensité. Ceci peut causer des effets nocifs pour le corps humain en raison de son rayonnement continu. Comme la réglementation internationale le spécifie, les ondes électromagnétiques à moins de 100 watt/m² n'ont pas un effet néfaste sur le corps humain, mais certains types d'appareils médicaux tels que les stimulateurs cardiaques peuvent être affectés même par des ondes électromagnétiques de faible énergie. Tout membre du personnel avec un tel dispositif devrait se tenir à l'écart des générateurs d'ondes électromagnétiques en tout temps.

Spécification de densité de la puissance et de la distance du radar (conformément à la disposition comme spécifié dans la IEC 60945)

Nom Modèle	Puissance de transmission / longueur d'antenne	100W/m ²	50W/m ²	10W/m ²
MDC-7012P	12kW / Antenne 4 pieds	2.01m	2.84m	6.34m
MDC-7912P	12kW / Antenne 6 pieds	2.38m	3.37m	7.54m
	12kW / Antenne 9 pieds	2.83m	4.01m	8.96m
MDC-7025P	25kW / Antenne 4 pieds	2.89m	4.09m	9.15m
MDC-7925P	25kW / Antenne 6 pieds	3.44m	4.86m	10.88m
	25kW / Antenne 9 pieds	4.09m	5.78m	12.93m

Warning Statements related to FCC and IC rules

- IC RSS-GEN, Sec 8.3 Warning Statement- (Required for Transmitters w/ detachable antennas)

ENGLISH:

This radio transmitter (identify the device by certification number, or model number if Category II) has been approved by Industry Canada to operate with the antenna types listed below with the maximum permissible gain and required antenna impedance for each antenna type indicated. Antenna types not included in this list, having a gain greater than the maximum gain indicated for that type, are strictly prohibited for use with this device.

FRENCH:

Le présent émetteur radio (identifier le dispositif par son numéro de certification ou son numéro de modèle s'il fait partie du matériel de catégorie I) a été approuvé par Industrie Canada pour fonctionner avec les types d'antenne énumérés ci-dessous et ayant un gain admissible maximal et l'impédance requise pour chaque type d'antenne. Les types d'antenne non inclus dans cette liste, ou dont le gain est supérieur au gain maximal indiqué, sont strictement interdits pour l'exploitation de l'émetteur.

Antenna type name	Antenna Gain (dBi)	Required Impedance (ohm)
RW701A-04	27.0dBi	50ohm
RW701A-06	28.5dBi	50ohm
RW701B-09	30.0dBi	50ohm

- IC RSS-102, Sec 2.6 Warning Statement Requirements

ENGLISH:

The applicant is responsible for providing proper instructions to the user of the radio device, and any usage restrictions, including limits of exposure durations. The user manual shall provide installation and operation instructions, as well as any special usage conditions, to ensure compliance with SAR and/or RF field strength limits. For instance, compliance distance shall be clearly stated in the user manual.

FRENCH:

Le demandeur est responsable de fournir des instructions appropriées et toute restriction d'utilisation, y compris les limites des durées d'exposition, à l'utilisateur de l'appareil radio. Le manuel de l'utilisateur doit fournir des instructions d'installation et d'utilisation, ainsi que toutes les conditions d'utilisation spéciales, pour assurer la conformité aux limites SAR et / ou RF. Par exemple, la distance de conformité doit être clairement indiquée dans le manuel de l'utilisateur.

- IC RSS-GEN, Sec 8.4 Warning Statement- (Required for license-exempt devices)

ENGLISH:

This device complies with Industry Canada license-exempt RSS standard(s). Operation is subject to the following two conditions: (1) this device may not cause interference, and (2) this device must accept any interference, including interference that may cause undesired operation of the device.

FRENCH:

Le présent appareil est conforme aux CNR d'Industrie Canada applicables aux appareils radio exempts de licence. L'exploitation est autorisée aux deux conditions suivantes : (1) l'appareil ne doit pas produire de brouillage, et (2) l'utilisateur de l'appareil doit accepter tout brouillage radioélectrique subi, même si le brouillage est susceptible d'en compromettre le fonctionnement.

- Warning statement regarding RF exposure compliance

ENGLISH:

The user manual of devices intended for controlled use shall also include information relating to the operating characteristics of the device; the operating instructions to ensure compliance with SAR and/or RF field strength limits; information on the installation and operation of accessories to ensure compliance with SAR and/or RF field strength limits; and contact information where the user can obtain Canadian information on RF exposure and compliance. Other related information may also be included.

FRENCH:

Le manuel de l'utilisateur des dispositifs destinés à une utilisation contrôlée doit également comporter des informations relatives aux caractéristiques de fonctionnement du dispositif; Le mode d'emploi pour assurer la conformité aux limites SAR et / ou RF; Des informations sur l'installation et le fonctionnement des accessoires afin d'assurer la conformité aux limites SAR et / ou RF; Et des coordonnées où l'utilisateur peut obtenir des renseignements canadiens sur l'exposition aux radiofréquences et la conformité. D'autres renseignements connexes peuvent également être inclus.

- FCC Part 15.19 Warning Statement

THIS DEVICE COMPLIES WITH PART 15 OF THE FCC RULES. OPERATION IS SUBJECT TO THE FOLLOWING TWO CONDITIONS: (1) THIS DEVICE MAY NOT CAUSE HARMFUL INTERFERENCE, AND (2) THIS DEVICE MUST ACCEPT ANY INTERFERENCE RECEIVED, INCLUDING INTERFERENCE THAT MAY CAUSE UNDESIRE OPERATION.

- FCC Part 15.21 Warning Statement





NOTE: THE GRANTEE IS NOT RESPONSIBLE FOR ANY CHANGES OR MODIFICATIONS NOT EXPRESSLY APPROVED BY THE PARTY RESPONSIBLE FOR COMPLIANCE. SUCH MODIFICATIONS COULD VOID THE USER'S AUTHORITY TO OPERATE THE EQUIPMENT.

- FCC Part 15.105(b) Warning Statement

NOTE: This equipment has been tested and found to comply with the limits for a Class B digital device, pursuant to part 15 of the FCC Rules. These limits are designed to provide reasonable protection against harmful interference in a residential installation. This equipment generates uses and can radiate radio frequency energy and, if not installed and used in accordance with the instructions, may cause harmful interference to radio communications. However, there is no guarantee that interference will not occur in a

particular installation. If this equipment does cause harmful interference to radio or television reception, which can be determined by turning the equipment off and on, the user is encouraged to try to correct the interference by one or more of the following measures:

- Reorient or relocate the receiving antenna.
- Increase the separation between the equipment and receiver.
- Connect the equipment into an outlet on a circuit different from that to which the receiver is connected.
- Consult the dealer or an experienced radio/TV technician for help.

 Warning	Do not disassemble or modify. It may lead to trouble, fire, smoking or electric shock. In case of trouble, contact our dealer or our company.
 Warning	In case of smoke or fire, switch off the power in the boat and the power of equipment. It may cause fire, electric shock or damage.
	Caution related to remaining high voltage. A high voltage may remain in the capacitor for several minutes after system is powered off. Before inspecting inside, wait at least 5 minutes after powering off or discharging the remaining electricity in an appropriate manner. Then, start the work.
 Caution	The information displayed in this unit is not provided directly for your navigation. For your navigation, be sure to see the specified material.
 Caution	Use properly rated fuse. If incorrect fuse is used, it may cause fire, smoke or damage.

Break in procedure of stored radar**Caution**

Following procedure is recommended for “Break In” of the stored radar. Otherwise the radar sometimes exhibits unstable transmitting operation such as arcing at its initial operation after long period of storage and make the operation more difficult.

1. Extend preheat time as long as possible (preferably 20 to 30 minutes).

2. Set the pulse width to the shortest one and start the operation.

When the operation in the shortest pulse is stable then go to operation in longer pulse and repeat the similar step until the operation reaches to the final pulse condition.

Used battery and radar disposal



Warning

A high-energy density lithium ion battery is installed in this radar. Improper disposal of a lithium ion battery is discouraged as the battery has a possibility of short-circuiting. If it gets wet, the generation of heat, explosion or ignition may occur resulting in an injury or fire.

Treatment of the used lithium ion battery

To dispose of built-in lithium ion battery (CR2032) in this radar, insulate each terminal with tape, and wrap in plastic bag.

The disposal and collection rules may be different depending on each municipal district. Obey the directions of each district.

Disposal of this radar

This radar shall be disposed according to the municipal regulations or rules.

Contents

Document Revision History.....	i
Important Notice.....	ii
For Your Safe Operation.....	iii
Break in procedure of stored radar.....	xii
Used battery and radar disposal.....	xiii
Contents.....	xiv
Introduction.....	xxi
Configuration items.....	xxii
System configuration.....	xxii
Option.....	xxiii
Chapter 1 Display and Operation.....	1-1
1.1 Radar Display.....	1-1
Upper left corner.....	1-1
Lower left corner.....	1-2
Lower right corner.....	1-2
Own ship data.....	1-3
Target status.....	1-3
Target and MAP information area.....	1-4
Assistant display (Navigation information).....	1-5
Alarm display area.....	1-6
1.2 Operation Unit.....	1-8
1.3 Menu usage.....	1-10
Turn MENU on and off.....	1-10
Select menu item.....	1-10
Display [MAINTENANCE] menu.....	1-11
1.4 Cursor Access usage.....	1-11
Chapter 2 Radar Basic Operation.....	2-1
2.1 Power ON/OFF.....	2-1
Power ON.....	2-1
Power OFF.....	2-1
2.2 Change Brilliance.....	2-2
Display Brilliance.....	2-2
Operation unit Brilliance.....	2-2
2.3 Transmission.....	2-3
Transmission ON.....	2-3
Transmission OFF.....	2-3

2.4	Tuning method	2-4
	Change MAN (manual) and AUTO.....	2-4
	Optimized value setup method	2-4
2.5	Change range scale.....	2-5
	Change range unit (NM / km).....	2-5
2.6	Adjust receiver gain (GAIN)	2-6
	Selection of MAN GAIN and AUTO GAIN.....	2-6
	AUTO adjustment of GAIN.....	2-6
	MAN adjustment of GAIN.....	2-7
2.7	Reject sea clutter (anti-SEA).....	2-8
	Selection of MAN SEA and AUTO SEA	2-8
	AUTO adjustment of SEA	2-9
	Manual adjustment of SEA.....	2-9
2.8	Reject rain/snow clutter (anti-RAIN)	2-10
	Changing method of CFAR and MAN.....	2-11
	CFAR (Constant False Alarm Rate) adjustment	2-11
	RAIN MAN (manual) adjustment.....	2-12
2.9	Change transmission pulse width (SP/LP)	2-13
2.10	Select Display Mode	2-14
	For H UP (Head up mode)	2-14
	For C UP (Course up mode)	2-15
	For N UP (North up mode)	2-16
	For relative motion (RM) and true motion (TM).....	2-17
	Reset true motion.....	2-18
2.11	Ground and Sea stabilization.....	2-19
	SEA (Sea stabilization).....	2-19
	GND (Ground stabilization)	2-20
2.12	Measurement of distance by RR and VRM	2-21
	Display Range Rings (RR).....	2-21
	Measurement Range (VRM: Variable Range Marker)	2-22
	Measurement Range (Cursor)	2-22
2.13	Measurement of bearing by EBL	2-23
	Using the EBL OFFSET	2-24
2.14	Bearing mode set up.....	2-25
2.15	Measurement of distance/bearing by PI	2-26
2.16	Measurement distance/bearing by ERBL	2-28
	Change ERBL mark to LINE or RING.....	2-29
	Change ERBL offset method.....	2-29
2.17	Change color and brightness (Day/Night).....	2-30

Setup color	2-30
Setup brightness.....	2-30
Color and brightness settings reset.....	2-30
2.18 Remove the heading line/navigation data	2-31
2.19 Target trail.....	2-31
Relative display (R)	2-33
True display (T)	2-33
2.20 Off Center.....	2-34
2.21 Function key usage	2-35
2.22 Set picture mode	2-36
2.23 Echo process.....	2-37
Correlation image echo process.....	2-37
2.24 Echo expansion.....	2-38
2.25 Interference rejection (IR)	2-39
2.26 Video contrast	2-39
2.27 Noise rejection.....	2-40
2.28 Echo color rejection.....	2-40
2.29 Pulse width	2-41
2.30 Receiving Radar Beacons, SART and Radar Enhancer.....	2-42
2.31 Inter-switch	2-44
2.32 Cursor data.....	2-46
CURSOR setting menu	2-46
2.33 Performance monitor.....	2-47
2.34 Reference position and Display center	2-48
Reference position	2-48
Display center.....	2-48
Antenna position mark ON or OFF.....	2-49
2.35 Setup own ship outline	2-50
Setup CCRP number and ship outline	2-50
2.36 FERRY MODE	2-51
Chapter 3 Alarm.....	3-1
Collision avoidance	3-1
3.1 Echo alarm	3-1
How to set echo alarm area (Fan type).....	3-1
3.2 Map area alarm	3-3
How to edit map area	3-3
How to move map area	3-4
How to add data to map area	3-5

	How to delete the data of map area	3-6
	How to clear entire block of map area data	3-6
3.3	Guard zone alarm	3-7
	How to set guard zone alarm	3-7
3.4	Nav line cross	3-8
	How to edit	3-8
	How to move nav line.....	3-9
	How to add	3-10
	How to delete	3-11
	How to clear	3-11
3.5	Alarm List	3-12
3.6	Alarm History list	3-13
3.7	Alarm on/off (TT and AIS)	3-14
 Chapter 4 Target (AIS, TT and Trial manoeuvre).....		4-1
4.1	Common setting	4-1
	VECTOR REL/TRUE	4-1
	CPA/TCPA alarm.....	4-3
	LOST ALARM.....	4-3
	Set AIS ID DISP TYPE.....	4-4
	Set TT ID DISP TYPE	4-4
	Set ID DISP SIZE	4-5
	Set Input range.....	4-5
	ASSOCIATION	4-6
	Automatic acquisition area	4-7
	PAST POSN: Past position	4-8
4.2	AIS	4-9
	Enable AIS function.....	4-10
	Select ID.....	4-10
	ACTIVE/SLEEP	4-10
	Ship outline	4-10
	HDG line.....	4-10
	Turn indicator	4-11
	OS display	4-11
	OS MMSI.....	4-11
	Message display	4-11
	AIS filter.....	4-12
	AIS alarm [Sleeping lost].....	4-13
	AIS auto ACQ.....	4-13

	Types of AIS target symbol.....	4-14
4.3	TT (ARPA)	4-17
	Limitations of the TT function	4-17
	Enable TT function	4-18
	Manual acquisition.....	4-18
	Delete TT target.....	4-19
	Delete all TT targets	4-19
	Reference target acquisition.....	4-20
	Types of tracked target symbol	4-22
	TEST TGT	4-23
4.4	Trial manoeuvre	4-34
 Chapter 5 Nav tool.....		5-1
5.1	Guard line.....	5-1
5.2	HL blink.....	5-2
5.3	Stern line	5-2
5.4	Barge icon	5-3
 Chapter 6 Map operation.....		6-1
6.1	MAP function display ON or OFF	6-1
6.2	OWN SHIP PAST TRACK.....	6-1
	How to Clear OWN SHIP PAST TRACK	6-2
6.3	Target track past position display	6-2
6.4	COAST LINE	6-3
	How to edit.....	6-3
	How to move.....	6-5
	How to add	6-6
	How to delete.....	6-7
	How to clear.....	6-7
6.5	NAV LINE	6-8
6.6	ROUTE.....	6-9
6.7	EVENT MKR	6-10
6.8	AREA.....	6-11
6.9	MONITORED ROUTE.....	6-12
6.10	WPT ID DISP	6-12
6.11	TARGET TRACK ID	6-12
6.12	DATUM.....	6-13
6.13	EDIT USER DATUM.....	6-13
6.14	POSITION OFFSET	6-14

	POSITION MANUAL OFFSET	6-14
6.15	GPS BUOY	6-15
6.16	WPT FLAG.....	6-16
6.17	LAT/LON LINE	6-16
6.18	C-MAP chart display	6-16
Chapter 7 System and Maintenance menu operation		7-1
7.1	SYSTEM MENU.....	7-1
7.2	Change UTC / LOCAL time	7-1
7.3	User memory	7-2
	Change USER memory.....	7-2
	How to save to memory	7-2
	Edit User Name.....	7-2
	Default User setting.....	7-2
7.4	Sound setting	7-3
	Sound ON/OFF	7-3
	Sound frequency	7-3
	Key click ON/OFF	7-3
	External buzzer setting.....	7-3
7.5	HELP window ON/OFF	7-4
7.6	MAINTENANCE MENU	7-5
7.7	BACKUP of Setup data (Cannot be used while transmitting).....	7-5
	Internal save of setup data.....	7-5
	External save of setup data (Cannot be performed while transmitting).....	7-6
	Parameter reset	7-6
7.8	TOTAL HOUR and TX HOUR (Cannot be used while transmitting).....	7-7
7.9	MENU SETUP	7-7
7.10	System Program	7-8
	Version confirmation.....	7-8
	How to update the system program	7-8
Chapter 8 Principal of radar system		8-1
8.1	What is radar system?	8-1
	Side lobe	8-1
	Beam width.....	8-2
8.2	Characteristics of radar radio wave	8-2
	Target hardness reflected.....	8-2
	Radar shadow	8-3
	False image.....	8-3

8.3	Radar interference.....	8-5
Chapter 9 Simple fault diagnosis		9-1
9.1	No alarm sound	9-2
9.2	Operation unit (panel) key is not operational	9-3
9.3	TT is not operational.....	9-4
9.4	No AIS display	9-5
9.5	Need to confirm serial input	9-6
9.6	No radar video display	9-7
9.7	Frozen Display	9-8
	Indication of presentation failure	9-8
9.8	About alarms	9-9
	Alarm list.....	9-10
	Operation note.....	9-14
Chapter 10 Specifications		10-1
10.1	Antenna and Scanner unit (Exposed).....	10-1
10.2	Display, Processor and Operation unit (Protected).....	10-2
10.3	External view and dimensions.....	10-3
Chapter 11 Appendix.....		11-1
11.1	Menu tree	11-1
11.2	Input data	11-12
	11.2.1 Validity and integrity of input data.....	11-12
	11.2.2 Details of the data input format.....	11-12
11.3	Details of TT tracking data output	11-21
11.4	Details of the radar data output.....	11-22
11.5	Interface specification	11-25
	11.5.1 NAV and EPFS serial data input/output specification.....	11-25
	11.5.2 SDME serial data input/output specification.....	11-26
	11.5.3 VDR (external monitor) and Alarm output signal specification	11-27
	11.5.4 Serial data input/output specification (AIS)	11-28
	11.5.5 Radar input/output signal specification.....	11-29
	11.5.6 Talker device code of the data output devices.....	11-30
	11.5.7 Priority of talker device code	11-30
Chapter 12 Index		12-1

Introduction

The MDC-7000P/7900P series is a compact and high performance shipboard radar system consisting of the Antenna & Scanner unit with a transmit power of 12kW/25kW, a Display unit with a 19 inch color LCD (Liquid Crystal Display) and Operation unit.

For this radar, its multi functions and high performance are accomplished with microcomputer technology as well as an image processing in the newly developed radar-dedicated LSI (Large Scale Integration).

- A slim Display unit using liquid crystal technology.
- Stable indication and reliable acquisition of small targets.
- Clear distinction between a moving target and land by true trail display.
- Provision of multi targets TT (ARPA) information and AIS information.
- Various models for selection of optimum radar for your needs.
- Simple and easy operation by user-friendly rotating knobs.
- Capable of adjusting gain, anti- sea clutter, anti- rain clutter, bearing cursor, and range marker, etc. using rotating knobs.
- The waterproof operating panel (IP23) has a great flexibility in installation.
- Capable of remote control using USB Mouse/Trackball.

Configuration items

System configuration

MDC-7012P/7025P

No.	Name	Type
1	Antenna	*
2	Scanner	**
3	Processor unit	MRM-108P
4	Operation unit with connecting cable	MRO-108P
5	Junction box with connecting cable	JB-35
6	Connecting cable	CW-845-15M
7	DC power cable	CW-259-2M
8	Display cable	CW-592-3M
9	Spare parts	SP-MRD/MRM-108
10	Installation material	M12-BOLT.KIT
11	Installation material	CONNECTOR.KIT
12	Operation manual	MDC-7000P_7900P.OM.E
13	Installation manual	MDC-7000P_7900P.IM.E
14	Quick reference	MDC-7000P_7900P.QR.E

MDC-7912P/7925P

No.	Name	Type
1	Antenna	*
2	Scanner	**
3	Display unit	MRD-108P
4	Operation unit with connecting cable	MRO-108P
5	Junction box with connecting cable	JB-35
6	Connecting cable	CW-845-15M
7	DC power cable	CW-259-2M
8	Spare parts	SP-MRD/MRM-108
9	Installation material	M12-BOLT.KIT
10	Installation material	CONNECTOR.KIT
11	Operation manual	MDC-7000P_7900P.OM.E
12	Installation manual	MDC-7000P_7900P.IM.E
13	Quick reference	MDC-7000P_7900P.QR.E

* RW701A-04: 4feet, RW701A-06: 6feet, RW701B-09: 9feet

** RB808P: 12kW (MDC-7012P / 7912P), RB809P: 25kW (MDC-7025P / 7925P)

Option

No.	Name	Type	Comment
1	Gyro Interface	S2N, U/N 9028C	Gyro converter
2	Log pulse NMEA converter	L1N, U/N 9181A	200pulse/NM only
3	Rectifier unit	PS-010	5A fuse attached. For 4 or 6 feet antenna only.
4		VL-PSG001	20A fuse attached. For 4 - 9 feet antenna.
5	AC power cable	VV-2D8-3M	Without a connector on the both sides
6	Connecting cable	CW-373-*	With 6-pin water resistant connectors at both ends (cable for data)
7		CW-374-5M	With a 6-pin connector and a 6-pin water resistant connector (cable for data)
8		CW-376-5M	With a 6-pin water resistant connector and one end plain (cable for data)
9		CW-387-5M	With a 8-pin water resistant connector and one end plain (cable for AIS)
10		CW-561-*	With 12-pin water resistant connectors at both ends (connector for remote display)
11		CW-576-0.5M	With a 10-pin water resistant connector and D-Sub connector (analog RGB) +Alarm out
12		CW-560-2M	With 15-pin water resistant D-Sub connectors at both ends (Cable for VDR or external Display unit to connect CW-576-0.5M)
13	Operation unit connecting cable	CW-401-*	With connectors on both sides
14	Antenna unit – Display unit connecting cable	CW-845-*	With connectors on both sides
		*: 5M, 10M, 50M, 65M	

- This page intentionally left blank.-

Chapter 1 Display and Operation

1.1 Radar Display

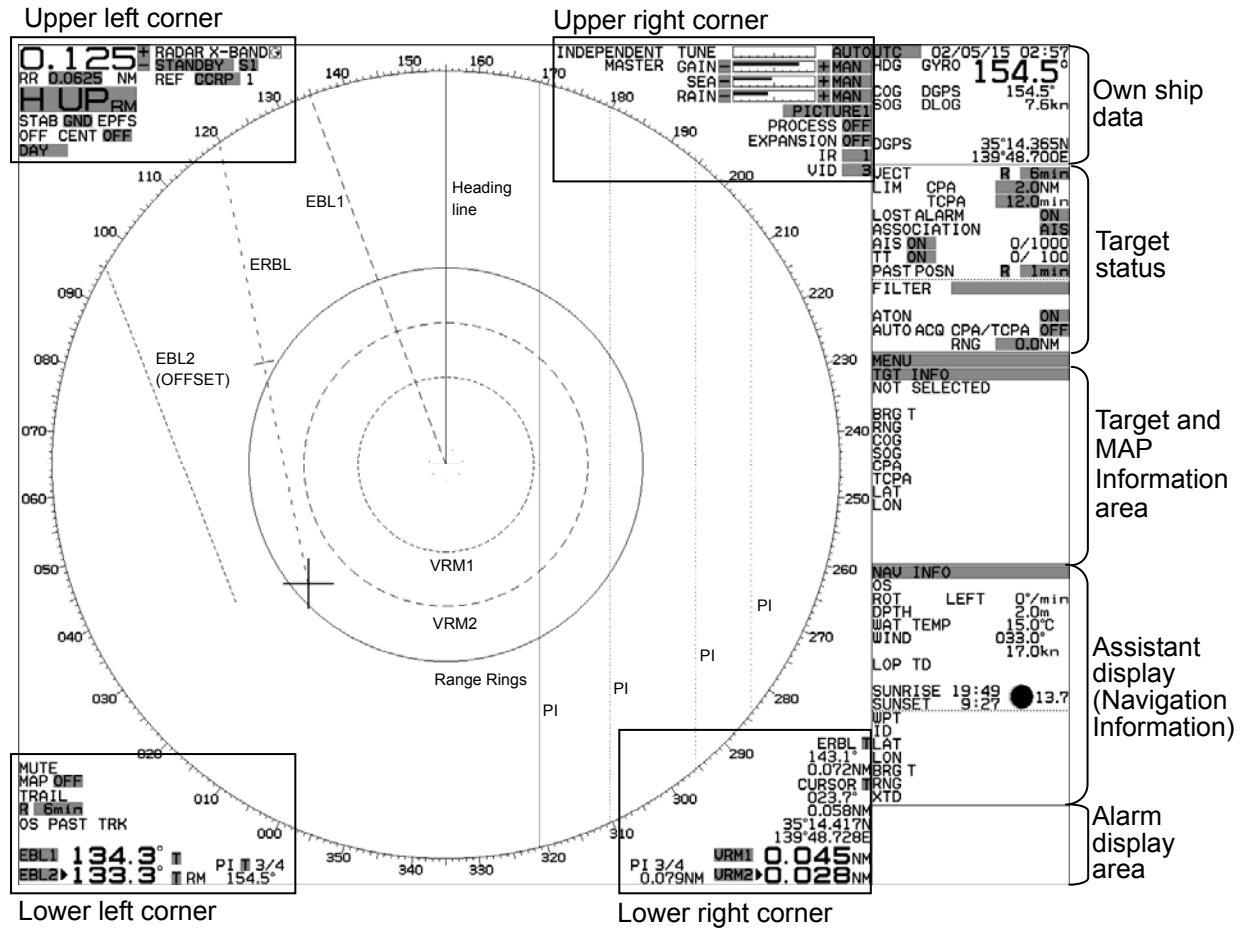

Upper left corner

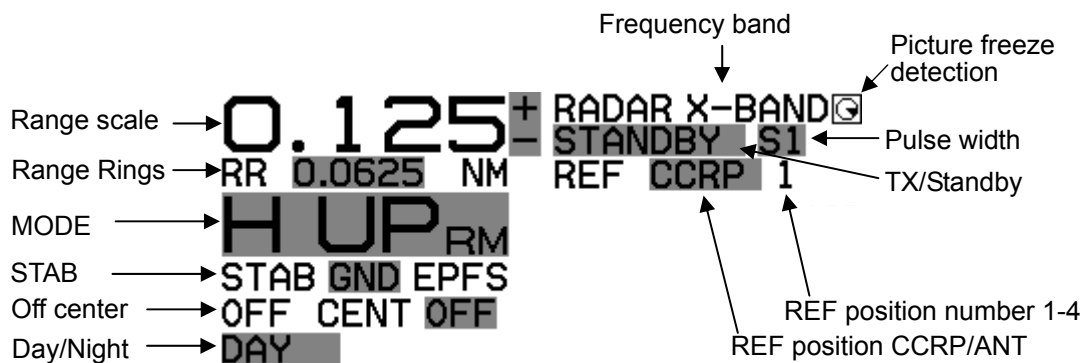

Upper right corner

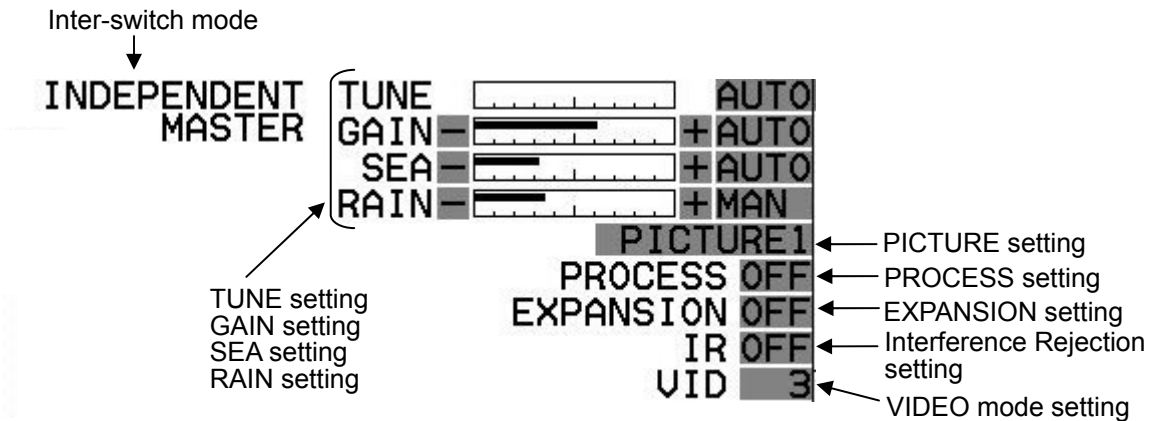

Lower left corner

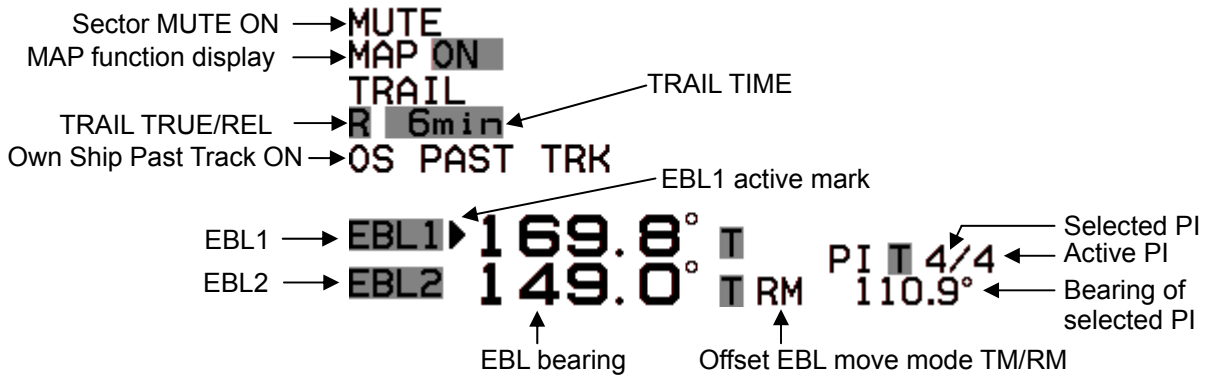

Lower right corner

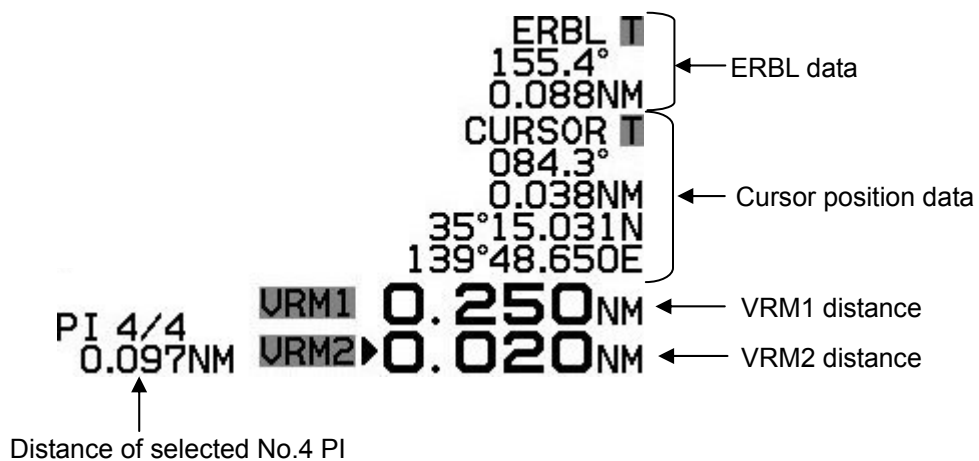

Own ship data

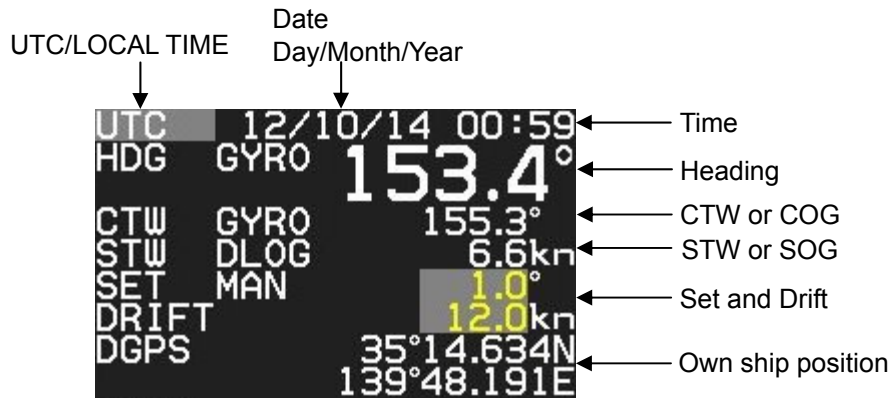

Target status

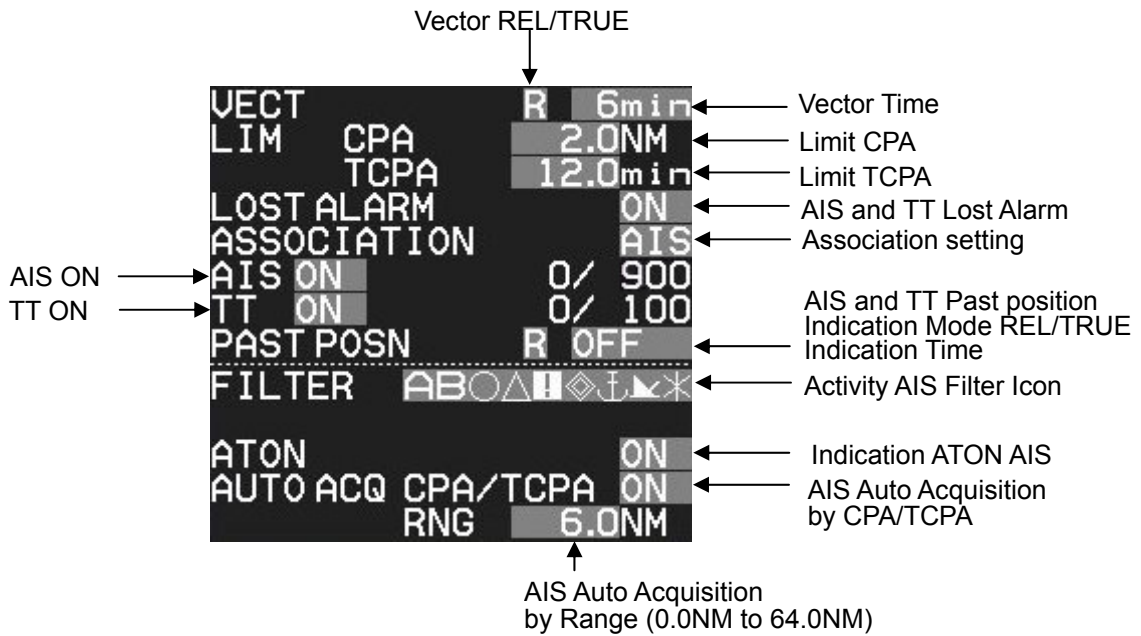

Target and MAP information area

Selected AIS, TT or MAP (COAST LINE, NAV LINE, ROUTE, EVENT MKR and AREA) information is displayed, this data can be changed by selecting with cursor and pressing **ENT** key.

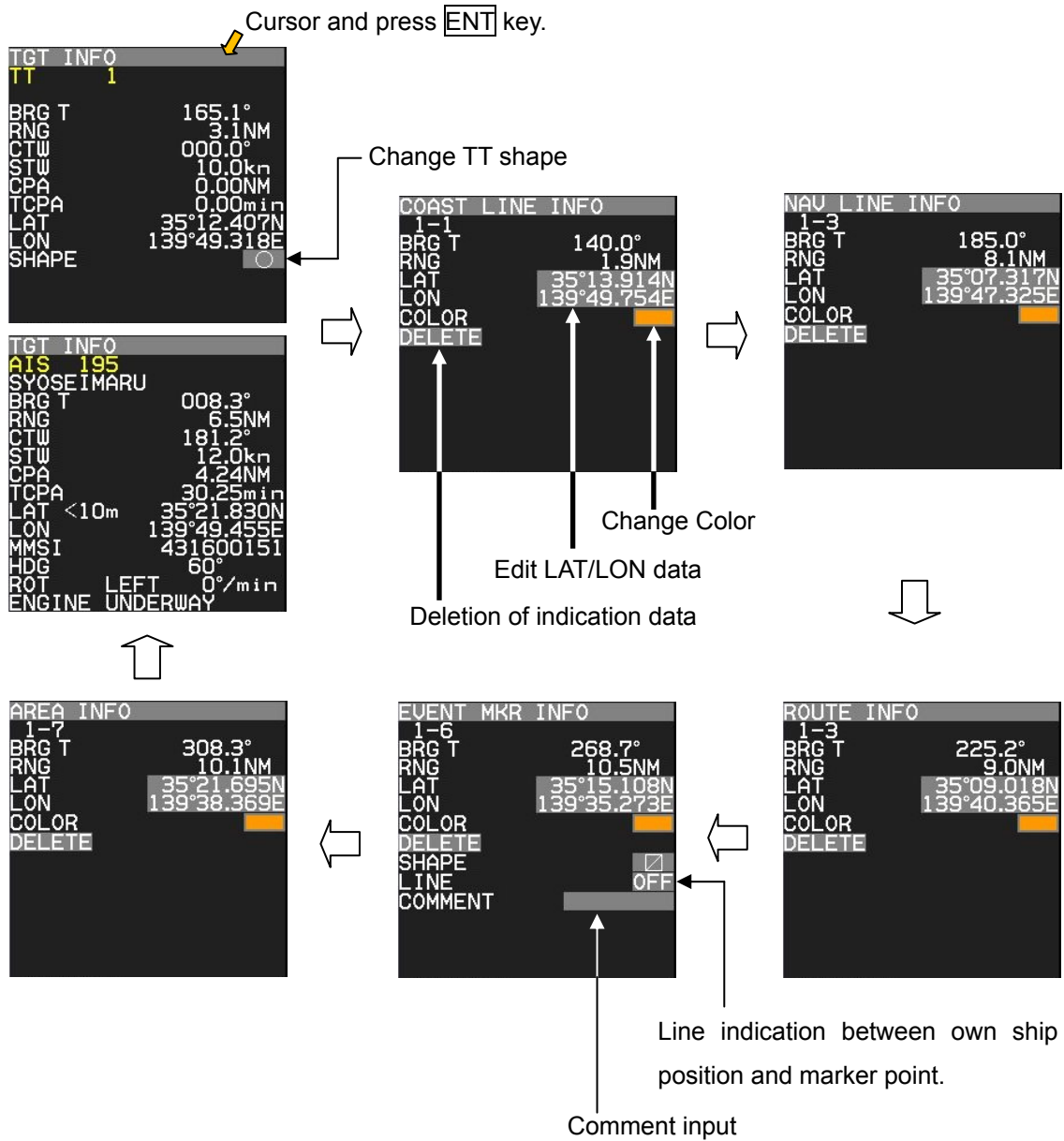

Assistant display (Navigation information)

NAV INFO



TGT OUTLINE

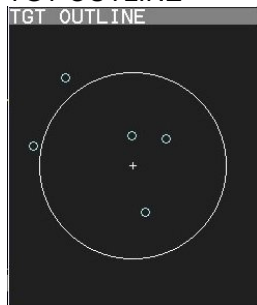

TGT LIST CPA/TCPA

TGT LIST	SORT:TCPA	
ID	CPA:NM	TCPA:min
156	0.00	0.00
206	0.02	-15.28
220	7.74	16.08
132	11.18	20.86
186	16.01	28.26
136	12.30	28.91
154	12.43	29.63
113	18.60	-31.40
231	10.83	33.31
130	13.57	39.13
238	9.29	41.88
195	12.90	42.43
220	4.24	47.05
195	3.49	53.48
240	3.38	53.55
117	18.98	55.80

TGT LIST BRG/RNG

TGT LIST	SORT:RNG	
ID	BRG:T	RNG:NM
235	273.8°	3.1
1	200.6°	3.2
232	008.0°	6.6
240	018.4°	6.8
195	015.9°	6.8
141	023.3°	7.4
172	022.1°	7.4
185	025.0°	7.4
206	329.9°	7.9
239	009.0°	8.7
127	010.0°	9.1
165	002.3°	10.1
220	328.3°	11.4
164	010.3°	11.8
186	331.3°	12.7
223	356.1°	12.8

TGT LIST LAT/LON

TGT LIST	SORT:TCPA	
ID	LAT	LO
1	35°12.247N	139°40.885E
206	35°28.119N	139°40.456E
220	35°24.873N	139°40.985E
156	35°10.098N	139°44.665E
186	35°26.394N	139°40.838E
136	35°26.540N	139°40.795E
132	35°29.121N	140°00.330E
231	35°28.091N	139°40.795E

TGT LIST COG/SOG

TGT LIST	SORT:TGT	
ID	COG	SOG:kt
142	110.4°	00.0
156	142.4°	00.0
113	045.7°	00.0
111	134.5°	00.0
123	152.1°	00.0
111	299.3°	00.9
193	156.9°	0.1
149	233.2°	0.1
222	010.0°	0.1
168	307.0°	0.1
104	177.7°	0.1
210	207.3°	0.1
132	316.3°	10.7
208	319.3°	0.0
173	058.5°	0.1
103	171.0°	0.0

TGT LIST LABEL

TGT LIST	SORT:TGT	
ID	LABEL	
142	FUKUJOU MARU	
156	TOHSHI	
113	TAKO MARU	
111	TUG BUKOU	
123		
111	TOKACHI MARU	
193		
149	MT SIENA	
222	CAPE LILAC	
168	AN GUANG JIANG	
104	ASAHI MARU	
210	TAISETSU MARU	
132		
208		
173	HEISEI MARU	
103	YAYOI EXPRESS	

SELECTED AIS INFO

SELECTED AIS INFO	
CLASS	A
RATM	OFF
TYPE	CARGO
CALL SIGN	URAL4
IMO	9113173
DRAUGHT	6.8m
DEST	
TOKOY	
ETA UTC	02/10 13:00
DIMENSIONS	A 14m
	B 121m
	C 16m
	D 5m
DTE	ON
DEVICE	GPS

BIRDVIEW

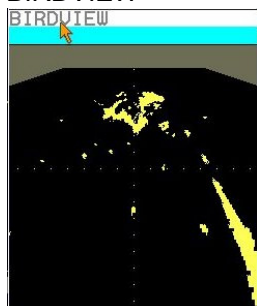

WIDEVIEW

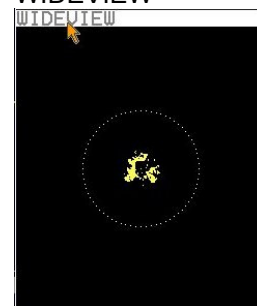

ZOOMVIEW



Selection values are NAV INFO, TGT OUTLINE, TGT LIST (CPA/TCPA), TGT LIST (BRG/RNG), TGT LIST (LAT/LON), TGT LIST (COG/SOG), TGT LIST (LABEL), SELECTED AIS INFO, BIRDVIEW, WIDEVIEW and ZOOMVIEW.

TGT LIST can be sorted by CPA, TCPA, RNG, TGT and SEL

CPA: It is displayed with the nearest first from the top of display.

TCPA: It is displayed with the shortest first from the top of display.

RNG: It is displayed with the nearest first the top of display

TGT: It is displayed with the nearest to the selected target first from the top of display.

SEL: It is displayed with the selected target first from the top of display.

Alarm display area

When a malfunction or operation error has been detected in the radar, alarm message will appear at the alarm display area.

Abnormalities are categorized as [ALARM], [WARNING] and [CAUTION]. When these messages actually appear and there is something wrong with radar, record the alarm details by type, location and status and press **[OFF]** key. The alarm sound (when ALARM and WARNING) and display will disappear.

Multiple errors may be displayed one by one. Record all alarms and press **[OFF]** key for every alarm.

Alarm list: Refer to 9.8 About alarms “Alarm list”.

ALARM (Displayed with red)

Alert management icons

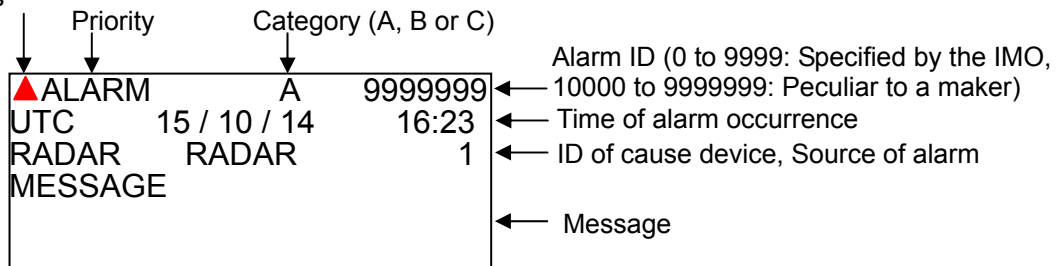

In case of unacknowledged alarm, icon and ALARM of priority will be flashing, and 3 short audible signals will be repeating every 7 sec.

In case of silenced alarm, audible signals will be stopping. If silenced alarm condition keeps more than 30 sec. silence alarm condition will cancel.

Type of ALARM icons

	Active Unacknowledged alarm
	Active Silenced alarm
	Active Acknowledged alarm
	Active Responsibility transferred alarm
	Rectified Unacknowledged alarm

WARNING (Displayed with yellowish orange)

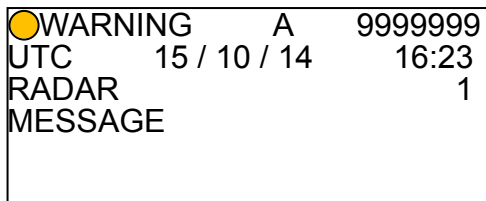

In case of unacknowledged alarm, icon and WARNING of priority will be flashing, and 2 short audible signals will be repeating every 60 sec.

Type of WARNING icons

	Active Unacknowledged warning
	Active Silenced warning
	Active Acknowledged warning
	Active Responsibility transferred warning
	Rectified Unacknowledged warning

CAUTION (Displayed with yellow)

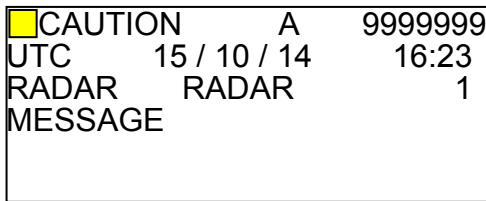

In case of CAUTION status, icon and CAUTION of priority is not flashing and audible signal is silent.

Type of CAUTION icon

	Caution
--	---------

1.2 Operation Unit

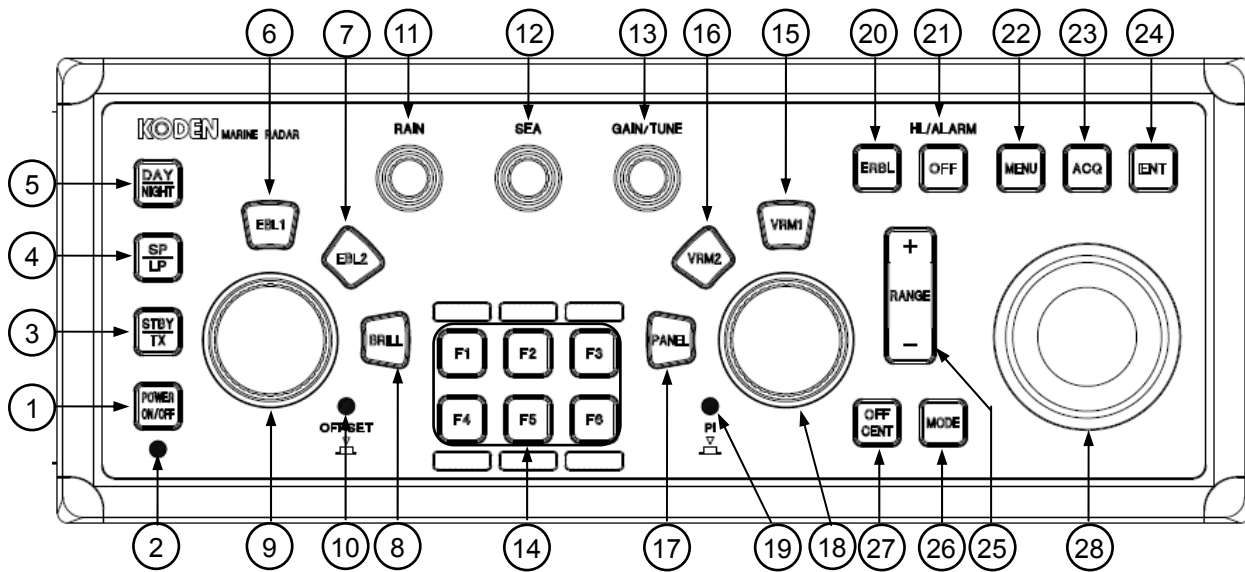

No.	Key/knob name	Contents
1	POWER ON/OFF key	Turn on and off the power.
2	POWER lamp	Status of power on.
3	STBY/TX key	Transmission on and off.
4	SP/LP key	Change transmission pulse width.
5	DAY/NIGHT key	Change echo color, day or night.
6	EBL1 key	EBL1 on and off.
7	EBL2 key	EBL2 on and off.
8	BRILL key	Display brilliance adjust mode on and off.
9	EBL/BRILL knob	Adjust EBL1, EBL2 or display brilliance.
10	OFFSET lamp	Status lamp of offset EBL mode on.
11	RAIN knob	Reduce rain clutter.
12	SEA knob	Reduce sea clutter.
13	GAIN knob	Adjust radar receiver gain.
14	FUNCTION keys F1 - F6	Quick short cut menu access.
15	VRM1 key	VRM1 on and off.
16	VRM2 key	VRM2 on and off.

17	PANEL key	Control panel brilliance adjustment.
18	VRM/PANEL knob	Adjust VRM1, VRM2 or panel brilliance.
19	PI lamp	Status lamp of parallel index lines.
20	ERBL key	Electronic range and bearing line on and off.
21	OFF key	Erase heading line, stop alarm sound, etc.
22	MENU key	Turn MENU on and off.
23	ACQ key	Start manual TT acquisition.
24	ENT key	Key most often used to make a selection.
25	RANGE key	Change radar range scale.
26	MODE key	Change display mode HU/NU/CU.
27	OFF CENT key	Off center mode on and off.
28	TRACKBALL	Used to make MENU selection and move cursor.

1.3 Menu usage

Turn MENU on and off

- 1 Press **MENU** key, "Menu" display on the right side of the display.
- 2 "Menu" display is turned off by pressing **MENU** key again.

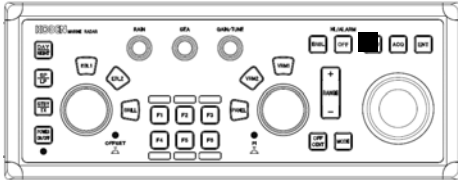

Select menu item

- 1 Press **MENU** key and "Main menu" will show on the display. Select one of main menu items by moving the trackball up or down.
- 2 Move the trackball to the right after making selection in main menu and the sub menu will show on the display.
- 3 Select a sub menu item by moving the trackball up or down.
- 4 Move the trackball to the right after making selection in sub menu and value of selected item will show.
- 5 Select desired value, then press **ENT** key.
Note: Pay attention that **ENT** key must be pressed for selected item to take effect.
- 6 Move trackball to the left to return to previous menu.
To exit from menu, press **MENU** key again.

<Example of menu display>

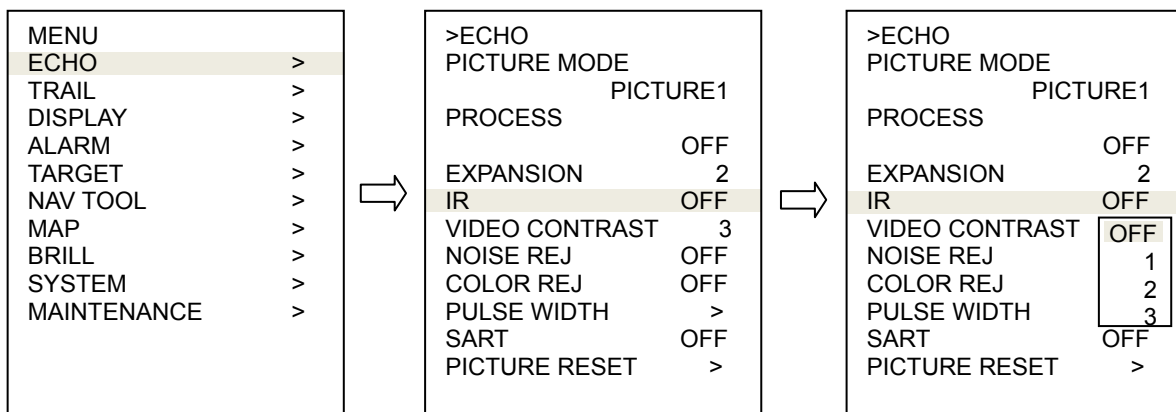

Note: "Menu" setup value is stored in the non-volatile memory inside the radar. Therefore, no setup operation is required after power is turned on.

Note: About the shaded menu:

[INTER-SWITCH] in [SYSTEM] menu, and [SECTOR MUTE], [BACKUP], [TOTAL HOUR] and [TX HOUR] in [MAINTENANCE] menu are not available during transmission, therefore they are greyed out.

Note: [MAINTENANCE] is protected menu and it is normally not displayed.

Display [MAINTENANCE] menu

- 1 Press **MENU** key to display "Menu".
Select [SYSTEM] => [PROTECT MENU] => [ON], and press **ENT** key after selection.
- 2 [PROTECT MENU xxxx] => turn trackball to right, [Set password (xxxx)], and press **ENT** key after setting.

Initial password value (xxxx): (0000).

Menu display disappears once after a correct password is input. Press **MENU** key once again to use "Menu".

How to change PASSWORD

After [PROTECT MENU] => [ON], select [MAINTENANCE] => [PASSWORD] => [New PASSWORD input], and press **ENT** key.

Selection values: 0000 to 9999

Note: The new password is active after a restart.

1.4 Cursor Access usage

Basic radar functions can be operated by using trackball and **ENT** key without using menu. This function is effective for the operation with USB Mouse/Trackball from the remote place. Move cursor on a grey item with trackball, then press **ENT** key.

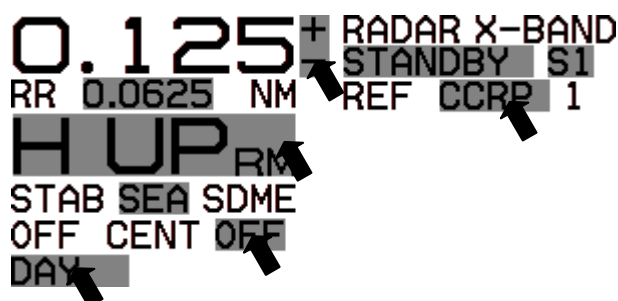

- This page intentionally left blank.-

Chapter 2 Radar Basic Operation

2.1 Power ON/OFF

Power ON

Press **POWER ON/OFF** key located at the lower left corner of the Operation unit. Radar system is turned on with beep sound.

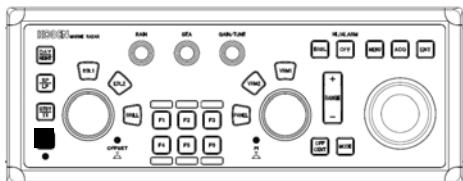

After power on, radar model name and preheating countdown time will appear at the center of the display.

Wait for 120 sec. (*1) or 180 sec. (*2) until preheating countdown time has disappeared, and status changes from **WAIT** to **STANDBY** at the upper left of the display.

(*1) MDC-7012P/7912P

(*2) MDC-7025P/7925P

RADAR X-BAND WAIT S1 REF CCRP 1	➔	RADAR X-BAND STANDBY S1 REF CCRP 1
--	---	---

The brilliance of the display is set to the previous value of the last power off.

During operation, "POWER LAMP" under **POWER ON/OFF** key lights up red.

Note: The power source shall not be turned off until operational window is displayed.

Power OFF

Press **POWER ON/OFF** key for two sec. for power off.

"SHUTDOWN" message appears at the center of the display, release **POWER ON/OFF** key immediately, and few sec. later will completely power off.

Note:

- The power source shall be turned off by pressing **POWER ON/OFF** key.

When the ship's power source is lost during operation, an important setup data may be lost

- After radar has been turned off, wait at least five seconds before turning it back on.

2.2 Change Brilliance

Display Brilliance

- 1 Press **BRILL** key.
- 2 The BRILL adjustment window will appear in the upper left of the display.

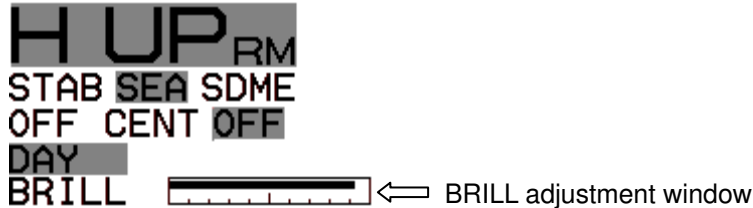

- 3 Turn **EBL** knob clockwise to increase the display brilliance.
Turn **EBL** knob counterclockwise to decrease the display brilliance.
The display brilliance can also be changed in five steps by pressing **EBL** knob.

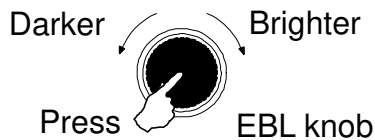

Operation unit Brilliance

- 1 Press **PANEL** key.
- 2 The PANEL adjustment window will appear in the upper left of the display.

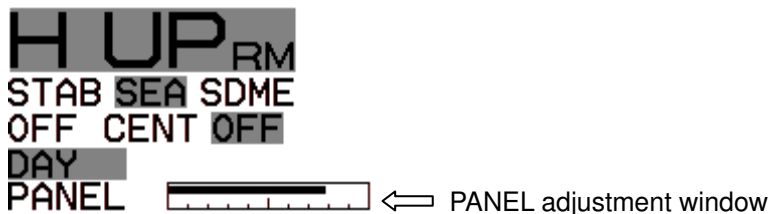

- 3 Turn **VRM** knob clockwise to increase the lighting of the panel brilliance.
Turn **VRM** knob counterclockwise to decrease the lighting of the panel brilliance.
The panel brilliance can also be changed in five steps by pressing **VRM** knob.

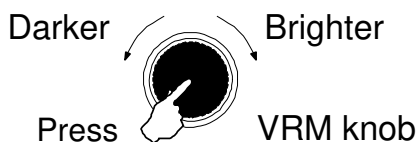

2.3 Transmission

Transmission ON

After preheating time countdown is completed, the radar can be placed in transmit mode.

Press **STBY/TX** key, or select the **STANDBY** box at the upper left corner of the display using trackball and press **ENT** key.

Radar system will start transmission.

The status of **STANDBY** changes to **TRANSMIT**.

Operation of **STBY/TX** key

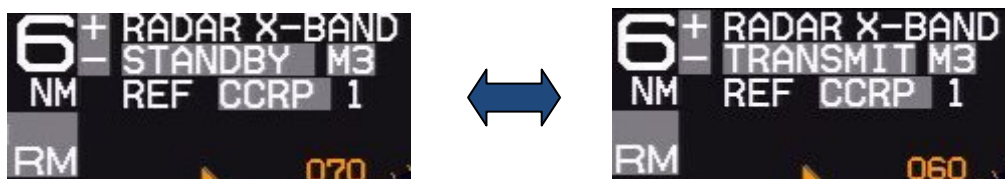

Operation of trackball

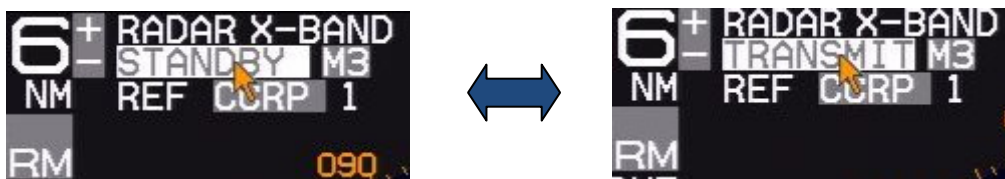

Transmission OFF

Press **STBY/TX** key, or select the **TRANSMIT** box at the upper left corner of the display using trackball and press **ENT** key to stop transmission.

The status of **TRANSMIT** returns to **STANDBY** at upper left of the display.

2.4 Tuning method

The transmitting and receiving frequency of this radar may become detuned by environmental changes.

This result in “detuning” of the gain and the same echo images may show weaker, even if the setup is the same as before.

Tuning method can be changed directly in the upper right of the display, with trackball and **ENT** key, without using menu function.

Tuning menu operation method, refer to 4.2.1 Tune adjustment of Installation manual.

Change MAN (manual) and AUTO

Move cursor to the **MAN** or **AUTO** box (whichever is shown) of tune indicator at upper right of the display using trackball and press **ENT** key.

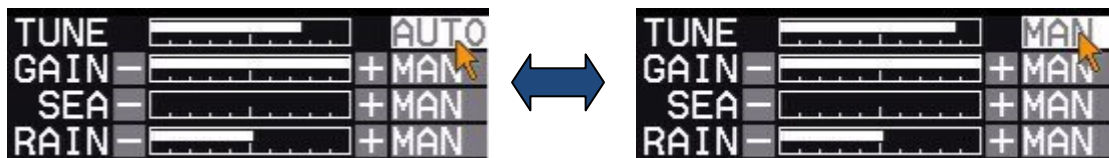

Optimized value setup method

Adjustment shall be performed based on stable echo object such as from land. (Land is used in following explanation.)

- 1 Set RAIN and SEA at 0.
- 2 Set lower GAIN until land echo almost disappears.
- 3 Press **GAIN/TUNE** knob until light around knob turns red.
Tune value box will appear on the place of **MAN** or **AUTO** box of tune indicator.

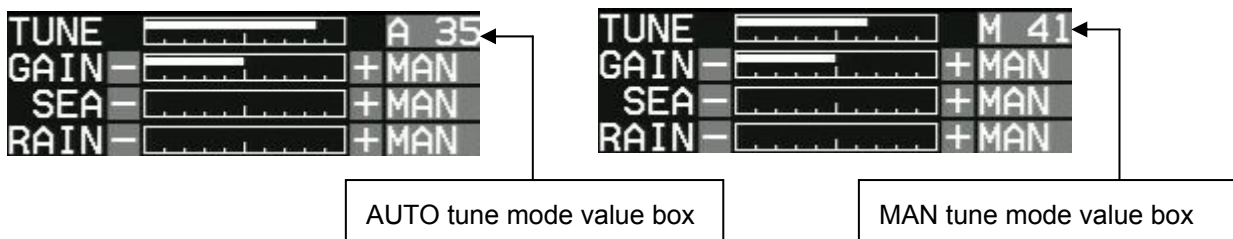

- 4 Turn **GAIN/TUNE** knob clockwise or counterclockwise to get the strongest land echo.
- 5 When tune adjustment is completed, press **GAIN/TUNE** knob or **ENT** key to save setting data to internal memory.
Light around **GAIN/TUNE** knob will turn green.
- 6 Repeat step 3 to 5 for both **MAN** and **AUTO** modes.

2.5 Change range scale

The coverage area can be changed by changing range scale.

Larger the value of range the more coverage area expands. (The target image will become smaller.)

The range scale value and range rings value are indicated at the upper left on the display.

Range scale can be changed directly at the upper left of the display, with trackball and **[ENT]** key, without using **[RANGE+]** and **[RANGE-]** key.

Range is changed centering on the antenna position.

- 1 Press **[Range +]** key to zoom out the picture, and to observe a wider area.
Press **[Range -]** key to zoom in the picture, to magnify and to observe closer to Antenna position.

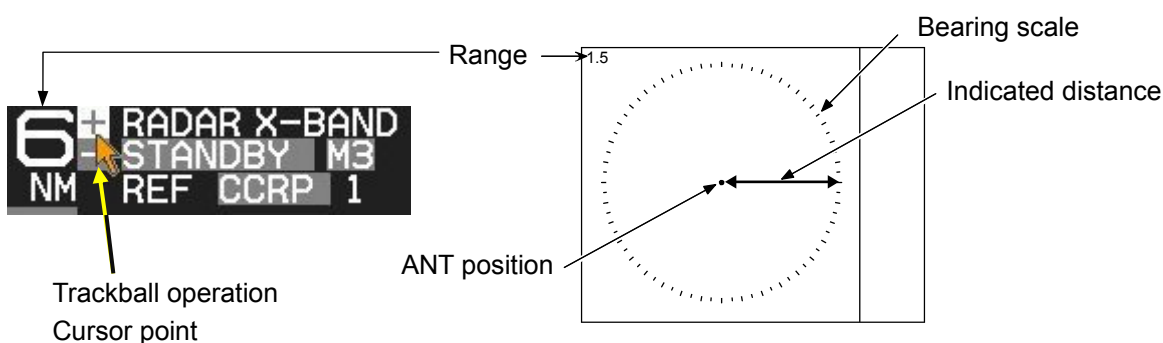

Model-specific ranges are as shown below.

Model name	MDC-7025P/7925P (Max. output : 25 KW)												
	MDC-7012P/7912P (Max. output : 12 KW)												
Range(NM)	0.125	0.25	0.5	0.75	1.5	3	6	12	24	32*	48	64*	96**

* 32NM and 64NM is for 12kW only.

** 96NM is for 25kW only.

Change range unit (NM / km)

The unit of range measurement can be changed from nautical miles (NM) to metric (km).

- 1 Press **[MENU]** key to display "Menu".
Select **[DISPLAY]** => **[RANGE UNIT]** => select **[NM]** or **[km]**, and press **[ENT]** key.

When changing to **[km]** range unit, Range and Cursor range unit will be changed.

2.6 Adjust receiver gain (GAIN)

It is recommended to adjust [GAIN] in the upper right side of the display to have the evenly scattered vague background noise with low intensity in the PPI.

Lower than required [GAIN] may result in missing small vessels and buoys.

Higher [GAIN] than required may result in difficult discrimination between small ships and densely displayed high level background noise.

Under some situation, desired target object may be masked by side lobe of antenna directivity or false echo by multi path.

Lower [GAIN] until masked target echo can be recognized outside of the area where 2.7 "Reject sea clutter (anti-SEA)" is effective.

However since lower [GAIN] tends to lose weak target echo, try to return the [GAIN] to original position each time [GAIN] is changed to maintain target recognition. In the short distance area where anti-SEA is effective, recognize target by adjusting MAN SEA.

When suppressing RAIN clutter (rain & snow), adjust **[GAIN]** knob and **[RAIN]** knob side by side.

[GAIN] state is displaying in the upper right of the display.

Selection of MAN GAIN and AUTO GAIN

By **[GAIN]** knob

When the **[GAIN]** knob is pressed, **[AUTO GAIN]** and **[MAN GAIN]** change alternately.

By trackball

- 1 Move cursor on the **[MAN]** or **[AUTO]** display (whichever is shown) at right side of [GAIN] on the top of the display.
- 2 Press **[ENT]** key to change **[AUTO]** or **[MAN]** as appropriate.

AUTO adjustment of GAIN

When **[AUTO GAIN]** is set, [GAIN] is adjusted automatically.

Note: AUTO GAIN may remove weak target echoes, or too much sea clutter may be on the display, turn **[GAIN]** knob clockwise or counterclockwise to adjust AUTO GAIN effectively.

If not setup properly, adjust AUTO GAIN settings by referring to 4.5.3 Setup GAIN MIN and MAX mode of Installation manual.

MAN adjustment of GAIN

When **MAN GAIN** is selected, GAIN can be adjusted manually.

- 1 Turn **GAIN** knob clockwise to increase receiving gain.
- Turn **GAIN** knob counterclockwise to decrease receiving gain.



Note:

- Decrease gain for shorter range and dense targets.
- Increase gain for long range targets and small target however take care in not using too much gain and losing targets in the surrounding noise.

Result picture after adjustment a [GAIN] knob

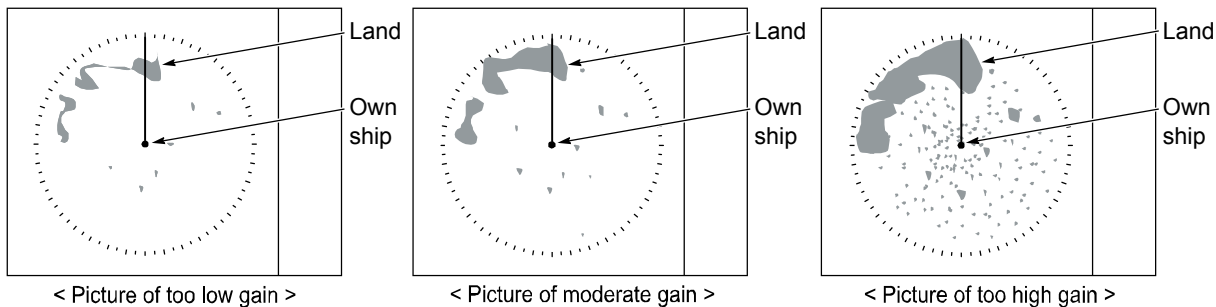

2.7 Reject sea clutter (anti-SEA)

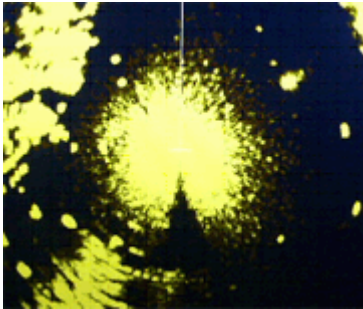

SEA clutter at center

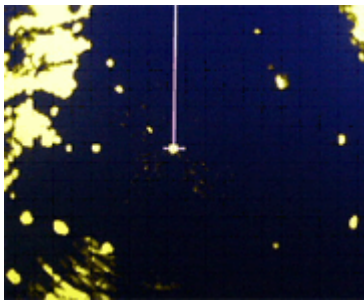

After Adjusted MAN SEA

MAN (manual) SEA and AUTO (automatic) SEA are provided for anti-SEA function. On the rough sea, SEA clutter noise appears around antenna position (center spot), and short distant targets are masked and not recognizable. In that case, anti-SEA function suppresses sea clutter noise and reveals masked target echoes. Recommended adjustment of anti-SEA is to adjust to make echoes from sea clutter vaguely displayed by low (weak) level. If anti-SEA level is too high to show sea clutter noise, short distance gain is over suppressed and it may result in loss of targets like buoys and small ships.

On the other hand, if anti-SEA level is too low, clutter noise around antenna position (center spot) is displayed by high intensity level and it makes difficult to discriminate small ships and buoys from sea clutter.

Anti-SEA is effective to suppress false echoes and ground clutter in short distance. However adjustment of GAIN should be used beyond effective coverage of anti-SEA.

If target echoes are masked by excessive false echoes within anti-SEA effective area, then adjust MAN SEA to confirm it. Excessive anti-SEA may lose echoes from small ships and buoys. So, return to appropriate anti-SEA level for normal use.

Note:

- Small targets become harder to detect when [SEA] is used together with [RAIN]. Therefore, please adjust them carefully.
- The echo process (refer to 2.23 Echo process) is useful to reject sea clutter. Be careful, when the echo process is active, high-speed targets are harder to detect than stationary ones.

Selection of MAN SEA and AUTO SEA

By **SEA** knob

When the **SEA** knob is pressed, **AUTO SEA** and **MAN SEA** change alternately.

By trackball

- 1 Move cursor on the **MAN** or **AUTO** display (whichever is shown) at right side of [SEA] on the top of the display.
- 2 Press **ENT** key to display **AUTO** or **MAN** as appropriate.

AUTO adjustment of SEA

When **AUTO SEA** is set, anti-SEA is adjusted automatically.

Note: AUTO SEA may erase weak target echoes. If excessive sea clutter erasing or too much clutter is observed, turn **SEA** knob clockwise or counterclockwise to adjust AUTO SEA effectively.

If not setup properly, adjust it by referring to 4.5.3 Setup GAIN MIN and MAX mode of Installation manual.

In case there are strong echo targets such as in the harbor or canal, anti-SEA tends to suppress excessively, use MAN SEA in that case.

Manual adjustment of SEA

When **MAN SEA** is selected, anti-SEA can be adjusted manually.

By using **SEA** knob, suppress this effect and make targets seen easier.

[SEA] state is displayed in the upper right of the display.

- 1 Turn **SEA** knob clockwise to increase anti-sea clutter effect.
Turn **SEA** knob counterclockwise to decrease anti-sea clutter effect.
- 2 Turn **SEA** knob clockwise until even low (weak) SEA clutter is displayed by observing the display.
- 3 Adjust **SEA** knob from time to time to get low (weak) SEA clutter on the display as intensity of sea clutter changes as time passes.



Note:

- When waves do not affect the result, turn the knob fully counterclockwise.
- This function reduces gain in closest ranges. Too much sea clutter may result in actual targets being lost.
- Manual SEA user keep watching and adjusting SEA with changing conditions.
- If SEA and anti-RAIN are used in combination, then small targets will be less visible.

2.8 Reject rain/snow clutter (anti-RAIN)

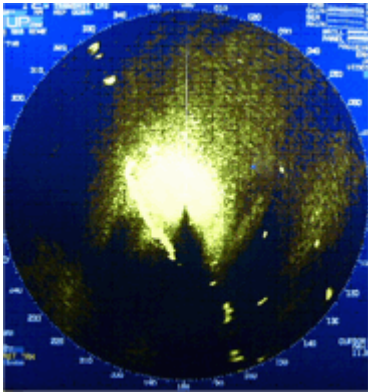

Rain clutter

In rain or snow, targets become hard to be seen as a result of unwanted weather reflection.

Rain or snow image appears as a large target echo with surrounding mid gradation rim as shown in the picture.

Anti-RAIN is available MAN and CFAR.

Adjustment of MAN (manual) and CFAR (Constant False Alarm Rate) by turning **RAIN** knob suppresses clutter, and helps to see targets clearly.

MAN is effective for suppression of rain and snow.

CFAR is effective for suppression of sea, rain and snow clutter.

[RAIN MODE] can be changed directly in the upper right of the display without using menu function.

Note:

- Small target becomes harder to detect when [RAIN] is used together with [SEA]. Therefore, please adjust them carefully.
- The echo process (refer to 2.23 Echo process) is useful to reject rain clutter. Be careful, when the echo process is active, high-speed targets are harder to detect than stationary ones.
- The performance of radar detection range is degraded by rain as shown in the figure below.

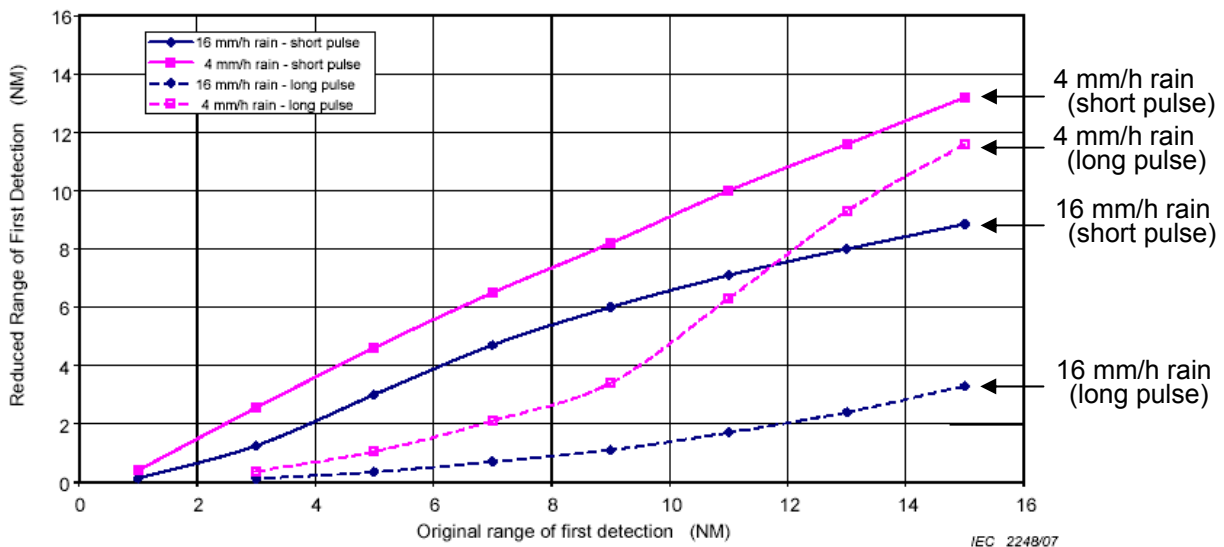

The details of the figure (An example of 6NM range)

A target which was able to observe at 6 NM (Original range of first detection), can only be detected at the ranges (Reduced Range of First Detection) shown below in rain condition.

- | | | | |
|-----------------------------|----------------|----------------------------|----------------|
| 4 mm/h rain (short pulse): | approx. 5.6 NM | 4 mm/h rain (long pulse): | approx. 1.5 NM |
| 16 mm/h rain (short pulse): | approx. 3.9 NM | 16 mm/h rain (long pulse): | approx. 0.5 NM |

Changing method of CFAR and MAN

By **RAIN** knob

When **RAIN** knob is pressed, **MAN** and **CFAR** change because of the alternation.

By trackball

- 1 Move cursor on the **MAN** or **CFAR** display (whichever is shown) at right side of [RAIN] on the top of the display.
- 2 Press **ENT** key to alternate **CFAR** and **MAN**.

CFAR (Constant False Alarm Rate) adjustment

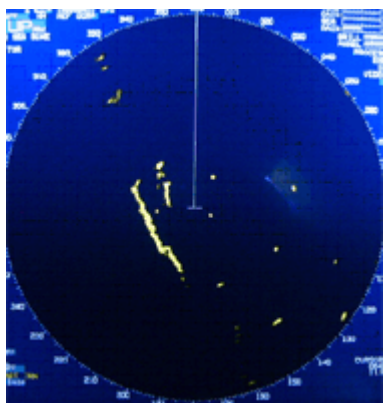

CFAR function is used to suppress of sea, rain and snow clutter easily.

CFAR function is active when **CFAR** is indicated at the upper right side of the display.

Level of CFAR is indicated on the left side of **CFAR** indication.

After CFAR adjustment

- 1 Turn **RAIN** knob clockwise to increase anti-clutter effect.
Turn **RAIN** knob counterclockwise to decrease anti-clutter effect.



- 2 Turn **RAIN** knob clockwise to get even low (weak) clutter while watching the display.

Note:

- In the case of **CFAR** mode, the gain adjustment is not possible.
Adjust **SEA** knob to suppress remaining sea clutter.
- In typical environment CFAR should be turned all the way down via **RAIN** knob, and no white level should be indicated by CFAR window.
- Turning the knob to the right shows the targets hidden in the rain/snow image, but care shall be taken that small target may be hidden and not displayed if over adjusted.
- If there are strong echo targets such as in the harbor or channel, CFAR tends to suppress targets excessively. In that case, change CFAR to MAN and use MAN SEA in addition.

RAIN MAN (manual) adjustment

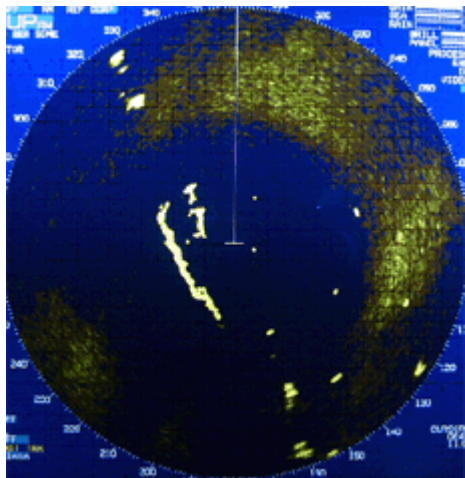

After adjusted anti-SEA

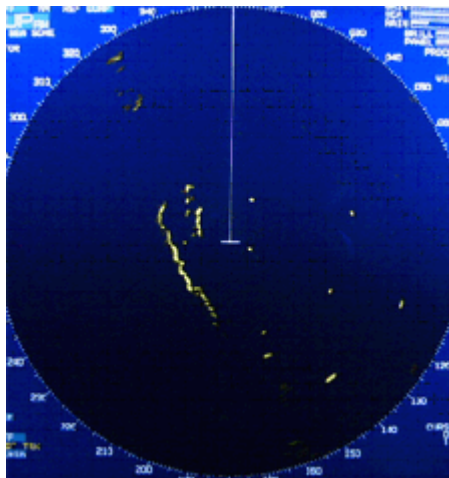

After adjusted anti-SEA & RAIN MAN

- 1 Turn **RAIN** knob clockwise to increase anti-clutter effect.
Turn **RAIN** knob counterclockwise to decrease anti-clutter effect.
Turn **GAIN** knob clockwise until sea clutter is visible on the display.



- 2 Use anti-SEA (AUTO SEA or MAN SEA).
- 3 While observing the display, suppress RAIN clutter outside of anti-SEA effective area by turning **RAIN** knob clockwise. Adjust RAIN so that sea clutter is lightly visible.
- 4 Intensity of RAIN clutter is affected by weather. Adjust by **RAIN** knob according to weather change by watching the display.

Note:

- In typical environment RAIN should be turned all the way down via **RAIN** knob, and no white level should be indicated by RAIN window.
- Turning the knob to the right shows profiles of the targets hidden in the rain/snow image, but care shall be taken that small target may be hidden and not displayed.
- Small target becomes harder to detect when RAIN is used together with SEA.

2.9 Change transmission pulse width (SP/LP)

This radar provides a function capable of achieving suitable target detection by manually changing the transmission pulse width.

Eight different pulse widths are available.

	Pulse width	Pulse repetition frequency	IF Band width
S1	0.08 μ s	2600Hz	15MHz
S2	0.15 μ s	2600Hz	15MHz
M1	0.3 μ s	2400Hz	15MHz
M2	0.4 μ s	2000Hz	3MHz
M3	0.6 μ s	1400Hz	3MHz
L1	0.8 μ s	1000Hz	3MHz
L2	1.2 μ s	600Hz	3MHz
L3	1.2 μ s	450Hz	3MHz

The short (narrow) pulse width used in short range has high resolution and is effective for dense targets.

The long (wide) pulse width used in long range has high gain (sensitivity) and is effective for detecting small targets.

Two different pulse widths are set by default in the following ranges, 0.75NM, 1.5NM, 3NM and 6NM.

Ranges 0.5NM and below, and 12NM and above are setup with same pulse width in SP and LP.

Note: Refer to 2.29 Pulse width to set pulse width.

Range(NM)	0.125	0.25	0.5	0.75	1.5	3	6	12	24	32*	48	64*	96**
SP mode	S1	S1	S1	S1	S2	M1	M3	L2	L2	L2	L2	L3	L3
LP mode	S1	S1	S1	S2	M1	M3	L1	L2	L2	L2	L2	L3	L3

* 32NM and 64NM is for 12kW only.

** 96NM is for 25kW only.

- 1 Press **[SP/LP]** key. Two different pulse widths are toggled by each key press.
Current pulse width is shown at the upper left of the display.



Note: Pulse width can be changed directly at the upper left of the display, with cursor and **[ENT]** key.

2.10 Select Display Mode

The display mode is a combination of the bearing indication and the target motion indication.

The bearing is indicated in three ways: **HUP**, **CUP** and **NUP**.

The target motion is indicated in two ways: **RM** and **TM**.

- 1 Press **MODE** key. The display changes in following order by pressing **MODE** key. Current display mode is displayed at the upper left of the display.



For H UP (Head up mode)

Heading line is always oriented toward the top of the display.

This mode is based on the bow of the ship and is suitable to monitor targets because targets are seen as they are in navigating own ship.

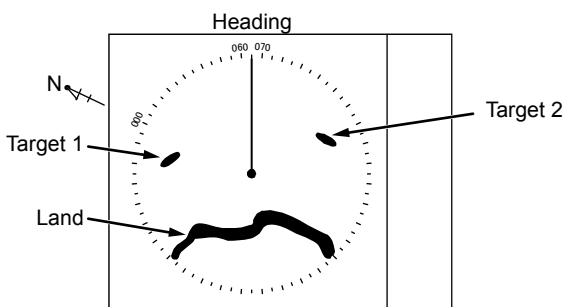

When heading signal is connected, H UP works by stabilized mode. (STAB H UP)

Note:

- This is a presentation mode stabilized in azimuth with fixed origin in which the radar image is oriented “up” toward the top of the bearing scale.
- Radar echoes and tracked targets are shown at their measured distances and moving in a direction relative to own ship’s heading.
- The heading line points from the CCRP the top of the bearing scale showing own ship’s heading in true bearing mode.
- The target trails mode can use both functions of true and relative.

At the time of the XXX.X heading indication of own ship data at upper right of the display, H UP works by non-stabilized mode.

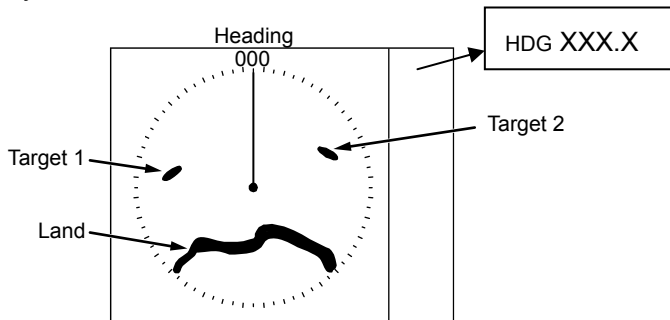

Note:

- This is a presentation mode not stabilized in azimuth with fixed origin in which the radar image is oriented “up” toward the top of the bearing scale.
- Radar echoes and tracked targets are shown at their measured distances and moving in a direction relative to own ship’s heading.
- The heading line points from the CCRP to the top of the bearing scale showing 000 relative bearing.
- Target trails can use only relative mode.

For C UP (Course up mode)

When choosing Course up mode, current heading becomes the course at the top of the display and a moving heading line indicates actual.

This mode is used to navigate towards a specified course.

It easily shows any deviation of own ship from the specified course.

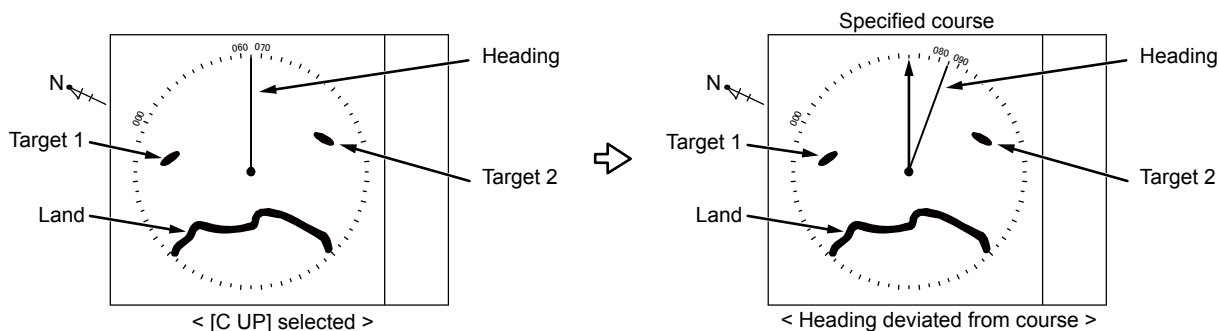

Note:

- This is an azimuth-stabilized presentation in which the bearing scale can be oriented so that own ship’s course on the bearing scale is vertically above the CCRP.
- The heading line points from the CCRP to own ship’s referenced heading on the bearing scale.
- If own ship’s heading differs from the course, then the heading line does not point vertically upwards from the CCRP until the bearing scale is reset (manually or automatically) to reflect the course alteration.

For N UP (North up mode)

This mode always keeps true north at the top of the display.

A north oriented representation makes it easy to reference with a chart.

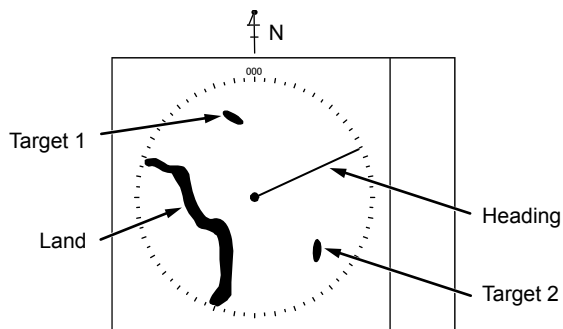

Note:

- This is an azimuth-stabilized presentation in which north on the bearing scale remains fixed vertically above the CCRP.
- The heading line points from the CCRP to own ship's referenced heading on the bearing scale.
- The true bearing of any target on the display is measured from north.

For relative motion (RM) and true motion (TM)

Relative motion fixes your antenna position at the center of the display, and indicates the motion of targets that surround your antenna position.

Your antenna position is displayed at the center. So, while the ship is moving, the fixed targets such as the land also continue to move.

True motion indicates the motion of the target with respect to the specified bearing.

Fixed targets that do not move in any direction stay on the display, and all the moving targets move on the display.

Note: The heading always continues to move. So, no true motion **TM** is available for **HUP**.

Relative motion (RM): The antenna position is fixed and the other surrounding targets move on the display.

This is useful to monitor the surrounding situation with respect to own ship's position.

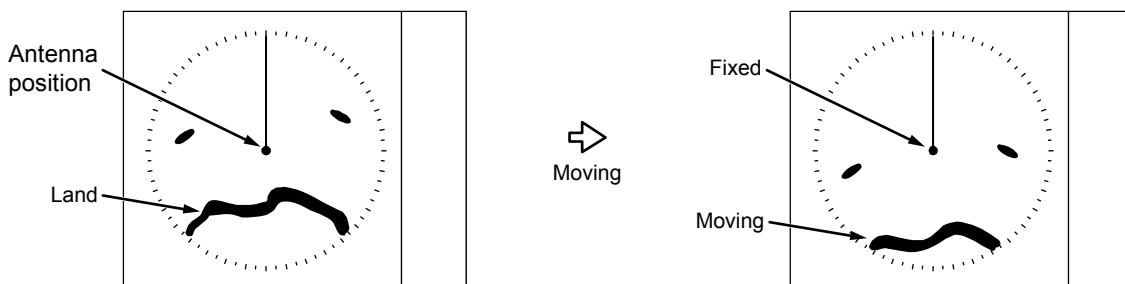

True motion (TM): The antenna position on the display moves according to its speed and tidal current. Stationary targets are fixed on the display. This mode is useful to monitor your position with respect to the fixed targets such as land.

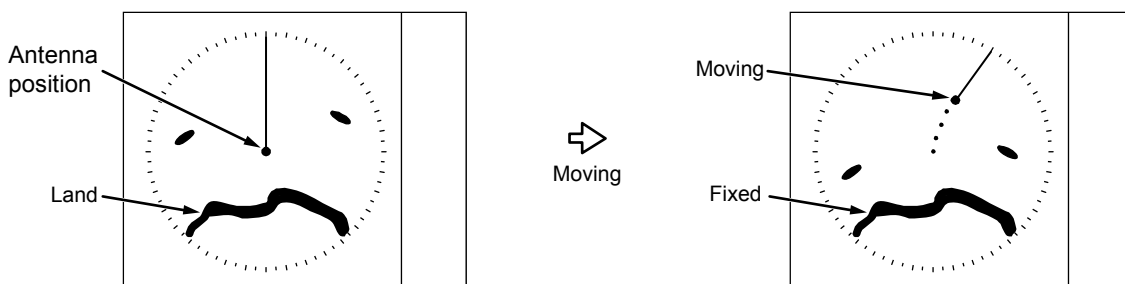

N-UP or C-UP TM mode is selected, own ship position moves to opposite side of heading direction, and begins to show the true motion image. When own ship position reaches center of the range scale, own ship position is to reset to the course over water or to the opposite direction of the course over ground.

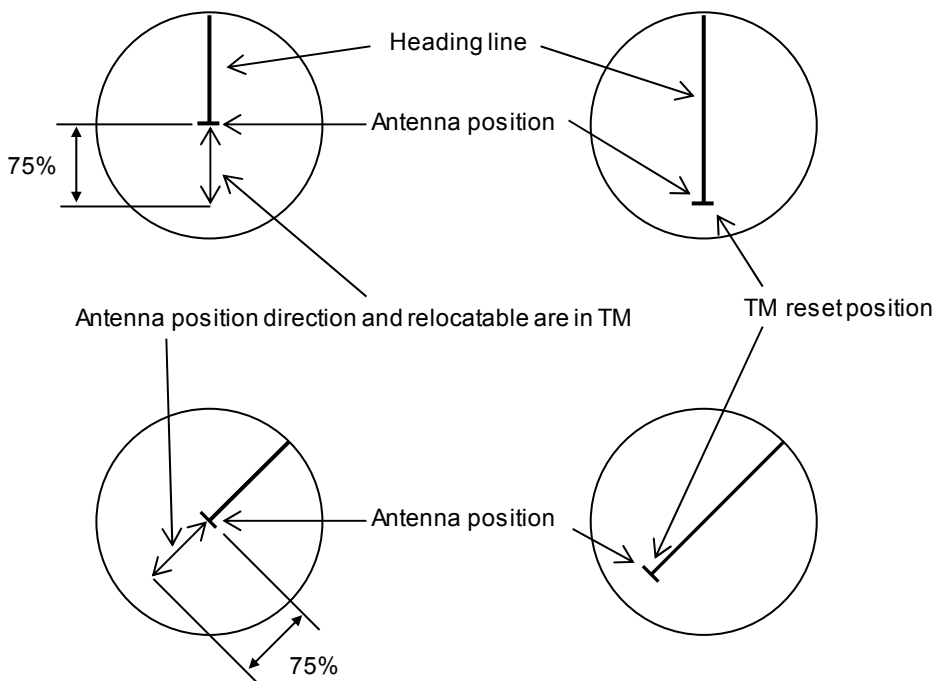

Reset true motion

Own ship display position can be manually reset when in true motion operation at any given point, by following procedure.

- 1 Press **MENU** key to display "Menu".
Select [DISPLAY] => [TM RESET], and press **ENT** key.

2.11 Ground and Sea stabilization

STAB MODE is a function to select speed for movement calculation for True trail, TT (ARPA), Past position and True motion (TM).

SEA: Stabilization mode using speed over water.

GND: Stabilization mode using speed over ground.

[STAB MODE] can be changed directly at the upper left of the display, by cursor and **[ENT]** key.



When SDME or EPFS is not available for any reason, it is possible to get the speed over ground by setting reference target.

Refer to 4.3 TT (ARPA) "Reference target acquisition".

SEA (Sea stabilization)

SEA stabilization uses CTW (course through water) and STW (speed through water) referenced to water. Accordingly course and speed indication at the upper right of the display becomes CTW/STW.

- STW is relative speed of the ship against water surface in the heading direction.
- Information from SDME (speed and distance measuring equipment) like LOG is inputted by serial data (VBW or VHW).
- Single axis water log indicated as LOG on the display cannot detect the effect of leeway.
- When speed information is interrupted for 30 seconds from SDME for any reason or VBW water status flag is invalid, then the numerical indication of CTW/STW becomes XXX.X in orange color. In this case, speed can be entered manually.

Manual speed input.

By menu

Note: This menu is protected in normal. To cancel the protection, refer to 1.3 Menu usage "Display [MAINTENANCE] menu".

- 1 Press **[MENU]** key to display "Menu".
Select [MAINTENANCE] => [I / O] => [STW] => [STW] => [MAN], and press **[ENT]** key.
- 2 Select [MAINTENANCE] => [I / O] => [STW] => [MAN] => input speed, and press ENT key.

By trackball

- 1 Press **[MENU]** key to display "Menu".
Select [MAINTENANCE] => [I / O] => [STW] => [STW] => [MAN], and press **[ENT]** key.

- 2 Press **MENU** key to close menu.
- 3 Move cursor to the window on the right side of STW MAN on the top right side of the display.
- 4 Press **ENT** key to get ready for speed entry. Enter speed by using trackball.
- 5 Press **ENT** key to save the input.

GND (Ground stabilization)

GND stabilization uses COG (course over ground) and SOG (speed over ground) referenced to the ground. Accordingly course and speed indication at the upper right side of the display becomes COG/SOG.

- SOG is the absolute speed of the ship with reference to the land.
- Two-dimensional GND SDME device like dual axis LOG and EPFS (electronic position fixing system) provide information for serial input.
- If both serial sentence data of VTG (EPFS) and VBW (SDME) are available, then VBW takes priority.
- If failure of EPFS or SDME interrupts the speed information for 30 seconds or if the ground status flag or VTG indicator flag is invalid, then the numerical indication of COG/SOG becomes XXXX in orange color.
- If SDME or EPFS is not usable due to failure or any other reason, then COG/SOG can be obtained by setting Reference target.

Refer to 4.3 TT (ARPA) "Reference target acquisition".

Note: IMO Resolution A.823 (19) ARPAs requires connection to water speed LOG.

In addition, VTG by EPFS or VBW by dual axis LOG should comply with requirements of IMO Resolution MSC96 (72).

2.12 Measurement of distance by RR and VRM

There are three ways to measure distance to a target: Range Rings, Cursor or VRM.

Display Range Rings (RR)

Range rings (RR) are markers displayed at the specified distance from reference point.

They are used as a rough indication of the distance to a target.

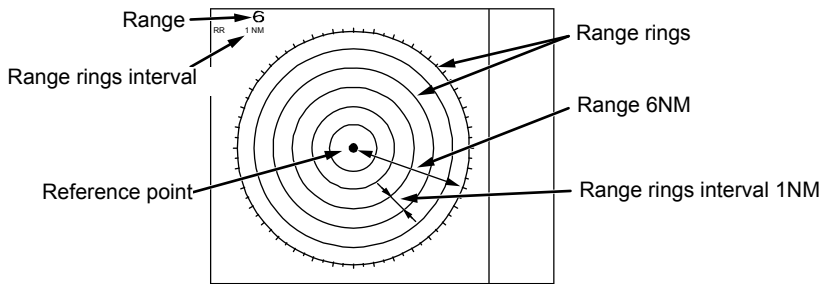

- 1 Press **[MENU]** key to display "Menu".
 Select **[NAV TOOL]** => **[RR]** => **[RR]** => **[ON]**, and press **[ENT]** key.

Note: **[RR]** display can be changed directly in the upper left of the display, by moving cursor and pressing **[ENT]** key.

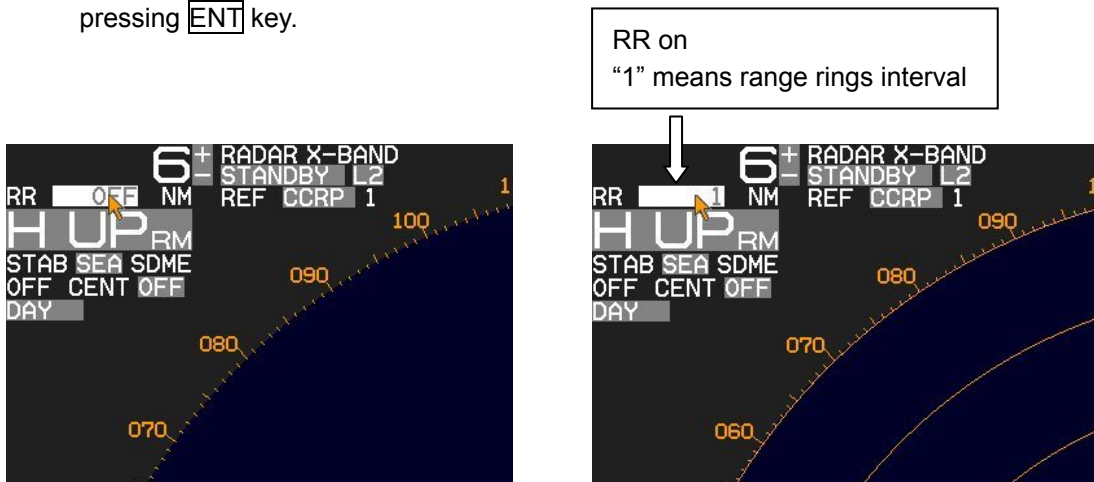

Note: When **[NAV TOOL]** => **[BRG TRUE / REL]** => **[TRUE]** is selected, 0° of the range rings indicates North direction. While, when **[REL]** is selected it indicates heading direction.

Measurement Range (VRM: Variable Range Marker)

Two variable range markers [VRM1] and [VRM2] are provided.

Turn [VRM] knob and lay each circle on the desired target to read the distance to the target on the display.

- 1 Press [VRM1] key to display a dashed line circle of VRM1.

Turn [VRM] knob to adjust the line circle on the desired target.

The distance to the target is indicated at the lower right of the display, and also a ► symbol is displayed on the left side of the distance value.

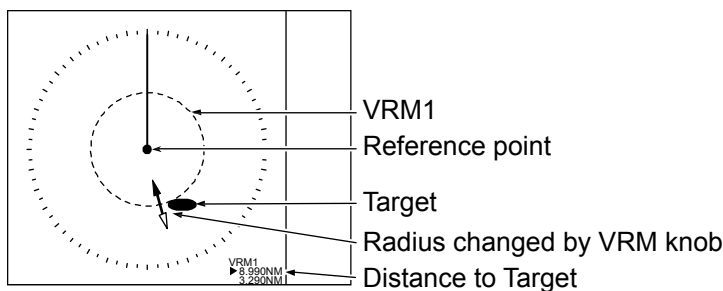

- 2 The dashed line circle is zoomed in or zoomed out by turning [VRM] knob clockwise or counterclockwise, respectively.

Note: Turning [VRM] knob (while pressing it) changes the range quickly.

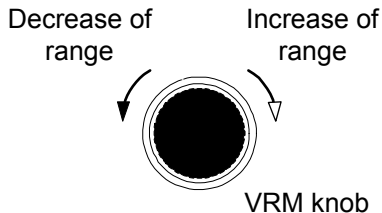

- 3 Another press of [VRM1] key will make the circle disappear.

- 4 Press [VRM2] key to activate the dotted line circle of VRM2.

Operation procedure and distance display are the same as VRM1.

- 5 If you want to display both VRM1 and VRM2 simultaneously, press [VRM1] key and [VRM2] key. Then, both the dashed line circle and the dotted line circle are displayed.

- 6 Switching between VRM1 and VRM2 is performed with pressing either of [VRM] keys as desired. When the selected key is pressed, the color of operation panel changes to red.

Measurement Range (Cursor)

Move the cursor on the target with trackball.

The distance and bearing to the target is indicated at the lower right of the display.

Note: While "MENU" is displayed, the cursor operation cannot be used.

Press [ENT] key while pressing [OFF] key to return the cursor to reference point position.

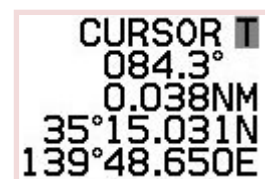

2.13 Measurement of bearing by EBL

This feature is used for measuring the bearing of the target from the base point (reference point for default value.) Two electronic bearing lines [EBL1] and [EBL2] are provided.

Turn **[EBL]** knob and lay each bearing line on the desired target and read the bearing on the display.

[Bearing mode] can be changed directly in the lower left of the display, by cursor and **[ENT]** key, without using menu function.

- 1 Press **[EBL1]** key, and the bearing line of EBL1 is displayed as a dashed line.
The bearing value to the target is indicated at the lower left of the display, and a ► symbol is displayed on the left side of the bearing value.
- 2 Rotate bearing line using **[EBL]** knob to adjust the line on the desired target.
The bearing value changes at the same time and you can read the bearing of the target.

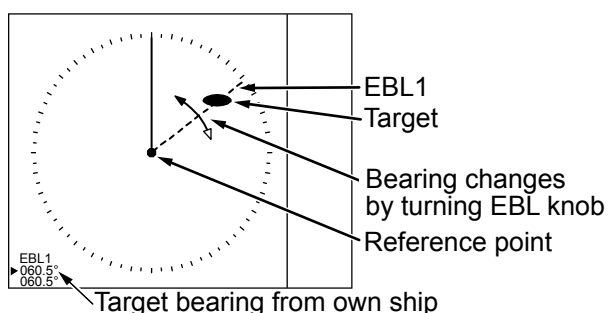

Note: Turning **[EBL]** knob (while pressing it) changes the bearing quickly.

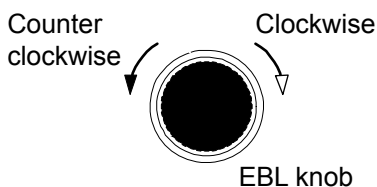

- 3 Another press of **[EBL1]** key, and the dashed line disappears and the bearing value on the lower left of the display also disappears.
- 4 Press **[EBL2]** key, and the bearing line is shown as a dotted line.
The operation procedure and display of the bearing is the same as EBL1.
- 5 If you want to display both EBL1 and EBL2 simultaneously, press **[EBL1]** key and press **[EBL2]** key.
Then, you can show both the dashed bearing line and the dotted bearing line.
- 6 Press **[EBL]** key to switch EBL1 or EBL2 as you desired.
The color of selected **[EBL]** key on the operating panel changes to red.

Using the EBL OFFSET

EBL base point can be changed to any position other than the initial reference point.

By changing the base point, the bearing from a random target can be measured.

- 1 Display the EBL for which the base point is required to be changed.
- 2 Move the cursor to new position.

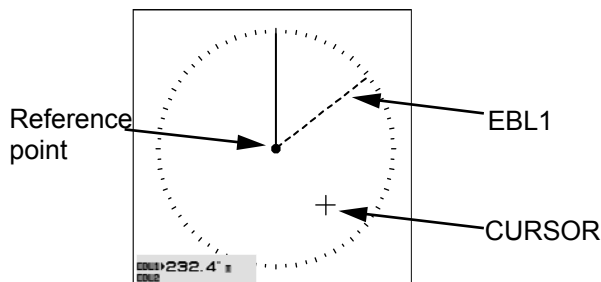

- 3 Press **[EBL]** knob, and the base point of EBL changes. During offset, the color of [OFFSET lamp] at the lower right of **[EBL]** knob changes from green to red, and the “TM” or “RM” mark is added right of the numerical figures.

“TM” means true motion, and “RM” means relative motion of OFFSET EBL1 and EBL2.

The motion selection can be changed by [NAV TOOL] => [EBL] => [EBL1 OFFSET] or [EBL2 OFFSET] => select [RM] or [TM], and press **[ENT]** key.

EBL knob

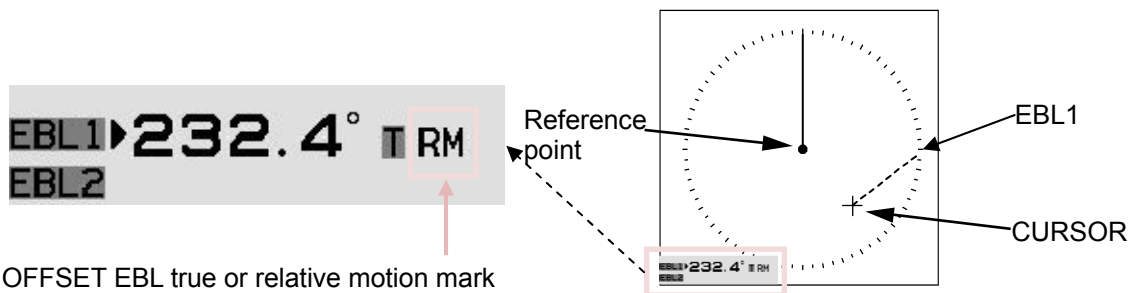

- 4 Press **[EBL]** knob again, and the base point returns to the reference point.

Note: The base point for VRM cannot be changed.

2.14 Bearing mode set up

This menu is used to change the bearing mode in EBL, PI, ERBL, Bearing scale and CURSOR.

The settings available in the true bearing with the true north of 000 degree, and in the relative bearing with the heading of 000 degree.

- 1 Press **[MENU]** key to display "Menu".
 Select **[NAV TOOL]** => **[BRG TRUE/REL]** => **[TRUE]** or **[REL]**, and press **[ENT]** key.

[EBL], **[PI]**, **[ERBL]** and **[CURSOR]** can be changed directly on the display by using trackball.

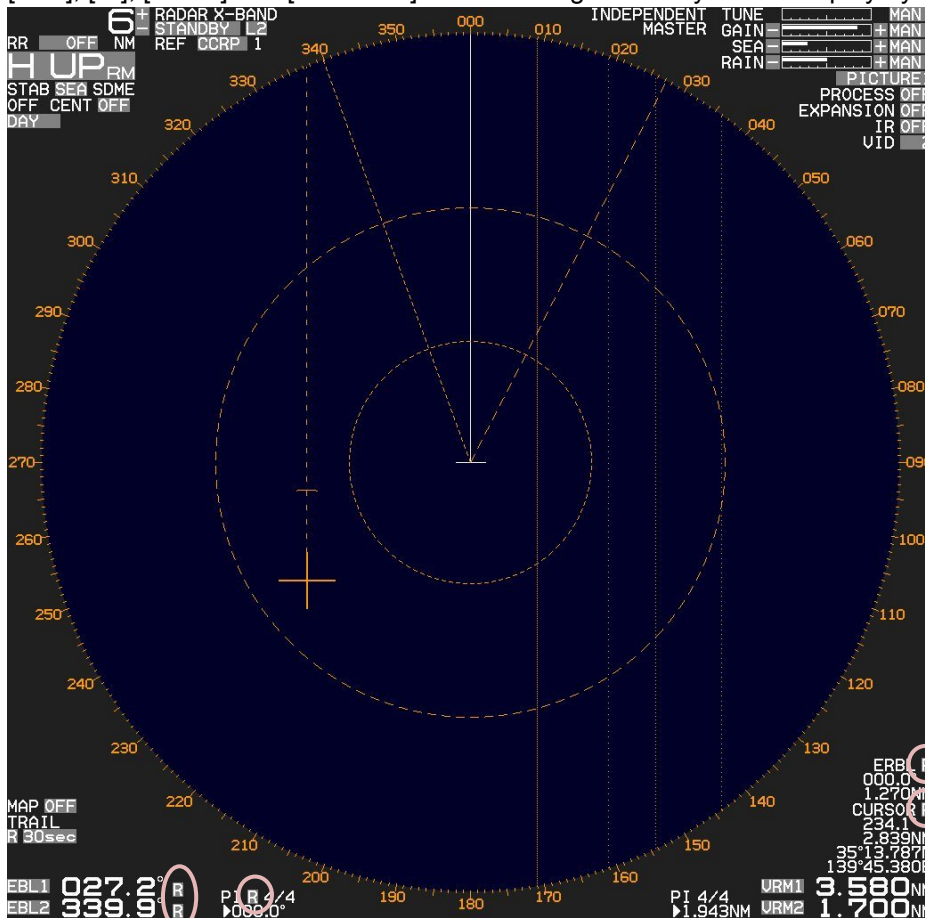

Relative mode

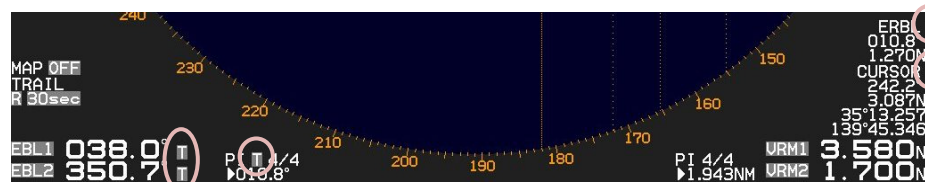

True mode

2.15 Measurement of distance/bearing by PI

This function is used to display straight Parallel Index (PI) lines on one or both sides of the vessel, range and bearing of which can be manipulated by following procedures.

Display location (distance, bearing) of each line can be changed independently or together when in BULK operation. The length of LINE can also be changed.

[Bearing mode] can be changed directly in the lower left of the display, with trackball and **[ENT]** key, without using menu function.

- 1 Press **[VRM]** knob, and PI lines are displayed.

By pressing **[VRM]** knob again, line number will be changed and will be turned off after the last line selection.

Press **[VRM]** knob

Press **[VRM]** knob

Press **[VRM]** knob

Press **[VRM]** knob

Press **[VRM]** knob

Total number of lines

Activated PI line number
1, 2, 4 and 7 lines are active in this case.

- 2 While activated, the bearing and range are shown at the lower left and lower right of the display, respectively.

The lamp color of PI located at the lower left of **[VRM]** knob changes from green to red when PI is activated.

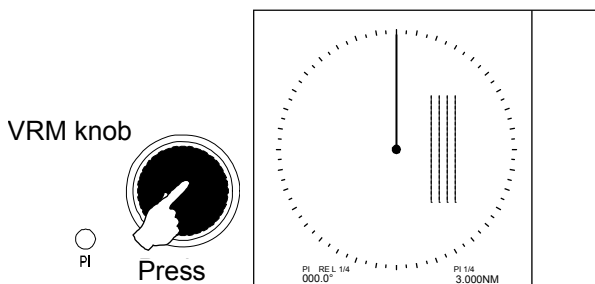

- 3 The range of selected line can be changed by turning **[VRM]** knob.

Note: Turning **[VRM]** knob (while pressing it) changes the range quickly.

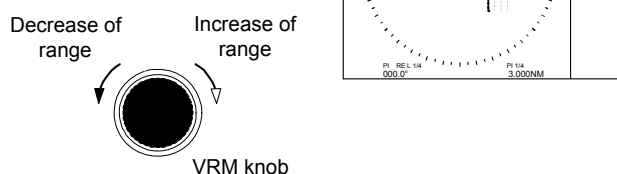

- 4 Turning **EBL** knob changes the bearing of a selected line.

Note: Turning **EBL** knob (while pressing it) changes the bearing quickly.

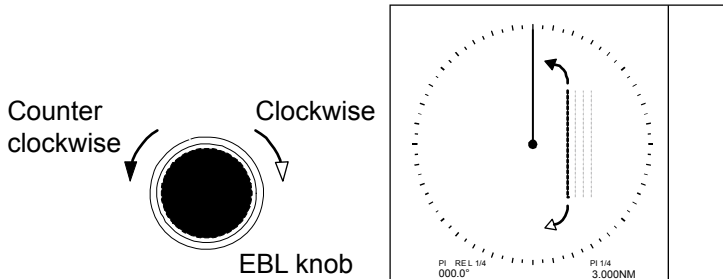

- 5 To return all PI lines to original position, press **OFF** key following by a quick press of **VRM** knob while holding the **OFF** key. Make sure that the **VRM** knob press is followed immediately after pressing the **OFF** key.

- 6 By following procedure user can turn any one of 7 lines ON or OFF and change its needed.

Press **MENU** key to display "Menu".

Select **[NAV TOOL] => [PI] => [LINE]**

LINE => LINE: Lets user choose line number (1-7) and its parameters.

LINE => DISP: Lets user turn selected line ON or OFF.

LINE => START RNG: Lets user choose starting position of selected line.

(-96.0 – 96.0 NM)

LINE => END RNG: Lets user choose ending position of selected line.

(-96.0 – 96.0 NM)

PI DISP SIDE: Select HALF or FULL

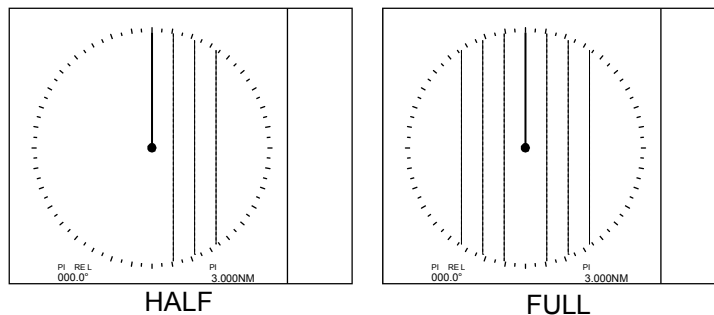

MODE: Select CURSOR or LINE

CURSOR: If mode is set to CURSOR available selections are NORMAL, 1, 2, 3, 4, 5, 6 or 7

PI UNIT: Select NM, km or RANGE LINK

(RANGE LINK sets PI Units to same units used for range)

PI OPERATION: Select BULK or INDIVIDUAL

(When BULK is selected all PI lines are operated together by **VRM** and **EBL** knobs.)

(When INDIVIDUAL is selected PI lines are operated one by one in sequence by pressing **VRM** knob)

2.16 Measurement distance/bearing by ERBL

The given point of distance and bearing can be measured with the cursor as follows.

Measurement of distance and bearing from reference point can be performed by moving cursor to reference point position.

[Bearing mode] can be changed directly in the lower right of the display, with trackball and **[ENT]** key, without using menu function.

- 1 Press **[ERBL]** key and ERBL is displayed.

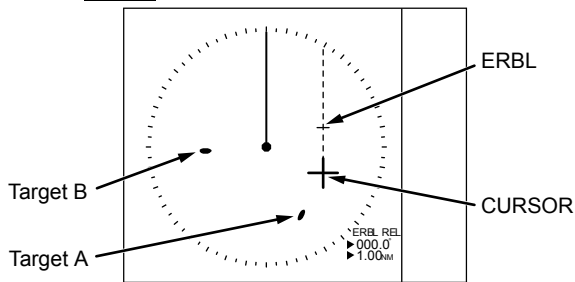

- 2 By moving cursor to target A, measurement of distance and bearing from target A to target B can be obtained by using **[VRM]** knob and **[EBL]** knob.

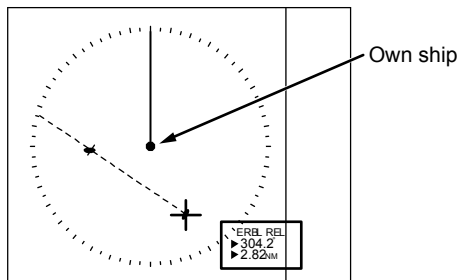

- 3 Pressing **[ENT]** key (while pressing **[OFF]** key) returns cursor to the reference point position. Therefore, it is possible to measure the distance/bearing from the reference point position.

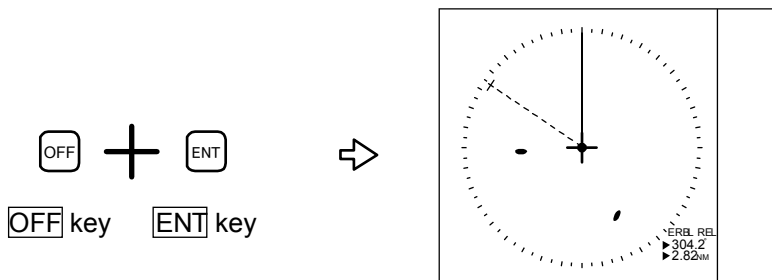

Change ERBL mark to LINE or RING

ERBL mark can be changed from LINE to RING.

- 1 Press **MENU** key to display "Menu".
Select [NAV TOOL] => [ERBL] => [RNG] => select [LINE] or [RING], and press **ENT** key.

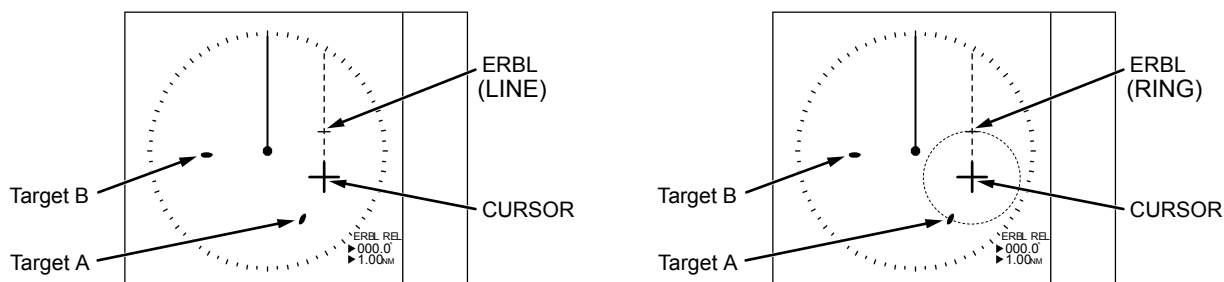

Change ERBL offset method

ERBL offset function can be operated by "CURSOR" or "TM".

- 1 Press **MENU** key to display "Menu".
Select [NAV TOOL] => [ERBL] => [OFFSET] => select [CURSOR] or [TM], and press **ENT** key.

[CURSOR]: The basic point of ERBL moves with the movement of the cursor.

[TM]: A cursor position becomes the basic point of ERBL.

After that, a position is fixed without synchronizing cursor movement.

The operation is limited to a bearing marker and range marker.

Note: [TM] function needs heading and Lat/Lon signal input of the own ship.

A basic point moves to the position of the last [TM] setting.

Move cursor in a new basic point, and press **ERBL** key.

2.17 Change color and brightness (Day/Night)

This function is used to change default echo, trail and all data color and contrast for day and night mode.

DAY/NIGHT mode can be changed directly by pressing **DAY/NIGHT** key, or select **DAY** or **NIGHT** icon at the upper left of the display by moving cursor and pressing **ENT** key.

Setup color

- 1 Select the mode (day or night) by pressing **DAY/NIGHT** key, color palette of which you would like to change.
- 2 Press **MENU** key to display "Menu".
Select **[BRILL]** => select **[ECHO]**, **[TRAIL]**, **[BKGND PPI]**, **[BKGND DATA]**, **[DATA]** or **[OTHERS]**.
After selecting color for each item, press **ENT** key.

ECHO:	YELLOW or GREEN
TRAIL:	BLUE or BROWN
BKGND PPI:	BLACK or BLUE
BKGND DATA:	BLACK or BLUE
DATA:	WHITE or GREY
OTHERS:	CHART LAND: BROWN, GREEN, LIME, YELLOW or GREY
	DEPTH: WHITE, BLUE
- 3 Make sure day or night mode is selected by **[BRILL]** first before making adjustments in step 2.

Setup brightness

This is to set up brightness of ECHO, TRAIL, BKGND, OS TOOL, TGT, MAP, CURSOR, DATA, WARNING and ALARM.

Default value of these items is 100 (max).

For safety reason, brightness cannot be adjusted to less than 20.

- 1 Select the mode (day or night) by pressing **DAY/NIGHT** key, brightness of which you would like to change.
- 2 Press **MENU** key to display "Menu".
Select **[BRILL]** => select **[ECHO]**, **[TRAIL]**, **[BKGND]**, **[OS TOOL]**, **[TGT]**, **[MAP]**, **[CURSOR]**, **[DATA]**, **[WARNING]** or **[ALARM]**
After adjusting each item with trackball, press **ENT** key.

Color and brightness settings reset

If you want to return the color and brightness settings back to default value, please use following procedure.

- 1 Press **MENU** key to display "Menu".
Select **[BRILL]** => **[RESET]** => **[GO]**, and press **ENT** key.

2.18 Remove the heading line/navigation data

This function is used when a target is overlapped with a heading line and hard to be distinguished.

- 1 Press **[OFF]** key to temporarily hide the heading line.
For safety reason, the heading line disappears only while the key is pressed. (It is not possible to keep it removed.)
Continue pressing **[OFF]** key for 2sec. All navigation tool data (RR, EBL, VRM, ERBL, PI, [MAP], such as COAST LINE, NAV LINE, ROUTE, EVENT MKR, and AREA, etc.) will hide.

2.19 Target trail

Other ships trails are displayed by following procedures.

Two display modes, relative display **[REL]** and true display **[TRUE]** are available.

At the start of trail, "TRAIL" characters at lower left of the display change to yellow. When trail time has passed, character color turns white.

Note:

- The trail by its nature records and displays past images. The trail does not display right after transmission is started.
In addition, after the change of [TIME], or after the change of two or more steps in [RANGE], the trail will disappear, because the recording is reset (erased).
- The trail [TIME] and [REL] or [TRUE] mode can be changed directly at the lower left of the display, with trackball and **[ENT]** key, without using menu function.

- 1 Press **[MENU]** key to display "Menu".
Select [TRAIL] => [TRUE / REL], and press **[ENT]** after making selection.

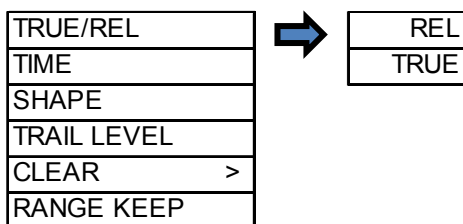

- 2 There are additional set up items, [TIME], [SHAPE], [TRAIL LEVEL], [CLEAR] and [RANGE KEEP].

[TIME]: This is to set up the time of the trail to be displayed.

Initial set up time: OFF, 30sec, 1min, 3min, 6min, 12min, 30min, 60min, PERM

Time setting can be changed by [STARTUP] => [TIME] menu operation.

[SHAPE]: Seven types of trail shapes available, as shown below.

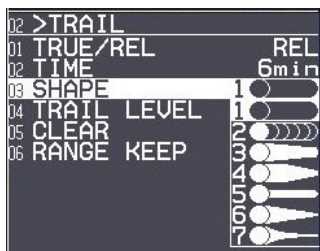

[TRAIL LEVEL]: This is to set up echo level of trail to be recorded.

“1” records all signal levels returned as a trail, “15” records only the strongest signal levels as a trail.

[CLEAR]: Is to delete all current trails and restart new trails.

[RANGE KEEP]: “OFF” deletes trails when changing range, “ON” does not delete trails when changing range.

Relative display (R)

The target trail is displayed as result of sum of vector (course and speed) of the target ship and your ship. When your ship is on the projected course of this trail, it shows that a collision may occur in future. This display is useful to help detect a dangerous situation.

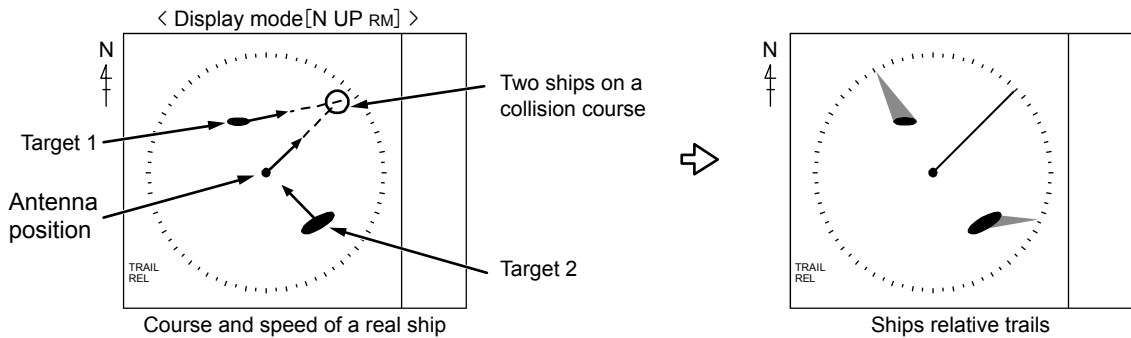

Target 1, whose trail is overlapping the EBL, is a dangerous target while the Target 2 is not. If trail setting is six minutes, and if the trail length is equal to the distance between the antenna position and Target 1, then the collision will occur after six minutes.

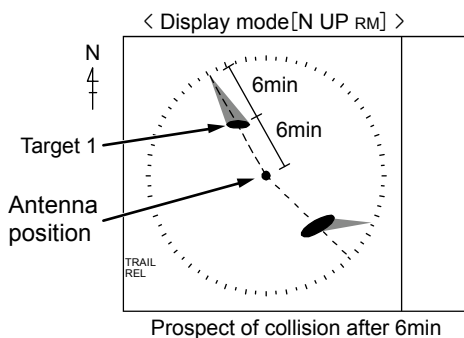

True display (T)

This mode displays the trail of the moving target over a specified time interval independently from own ship's movement.

This mode is used to monitor the bearing and speed of the target.

No trails of fixed targets such as land are shown using this display.

The amount of movement of all ships, own ship, Target 1 and Target 2 are drawn as trails.

The land does not move, so its trail is not shown.

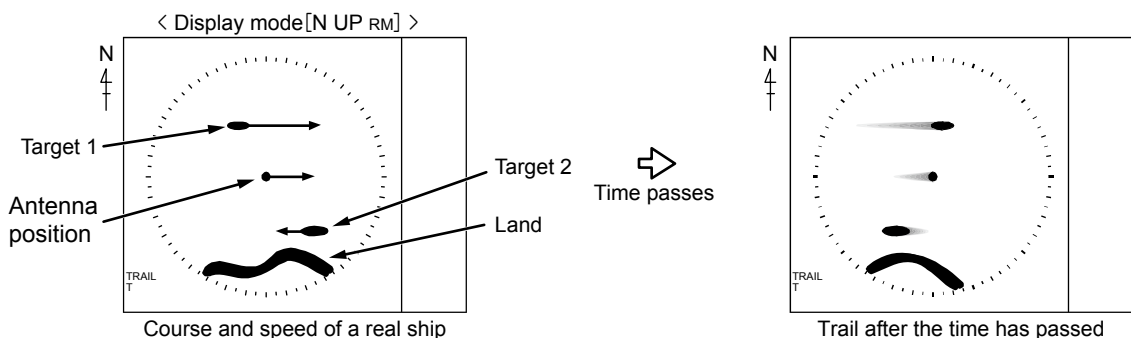

2.20 Off Center

This function is used to get larger view in heading direction.

Two ways “OFF CENTER” can be setup.

[CURSOR]: Off-centering to CURSOR direction.

[OPPOSITE]: Off-centering to the stern direction.

- 1 Press **MENU** key to display “Menu”.
 Select [DISPLAY] => [OFF CENT POINT] and press **ENT** key after selecting the off center point “CURSOR” or “OPPOSITE”.
- 2 Off-centering is executed by pressing **OFF CENT** key, or move cursor to set value of **ON** or **OFF** of [OFF CENT] at the upper left part of the display, and press **ENT** key.

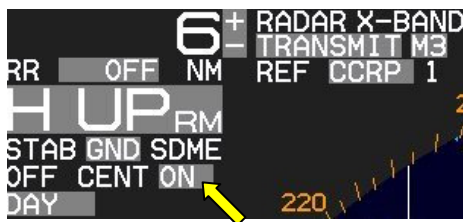

- 3 The difference of [CURSOR] and [OPPOSITE] are as follows.

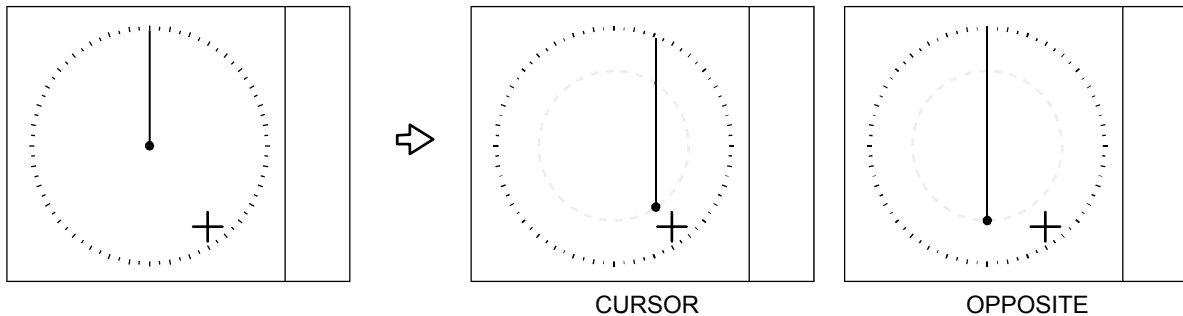

Note: When CCRP is selected for the reference position, there is possibility that CCRP is located outside of 90 % echo image area at OFF CENTER function in short range.

In this case, alarm message of “Cannot use the CCRP” will appear at lower right of the display, and the reference position is automatically changed to ANT position.

Refer to 2.34 Reference position and Display center.

2.21 Function key usage

For quick function access, there are six dedicated function keys provided on this radar (“F1”, “F2”, “F3”, “F4”, “F5” and “F6”).

You can switch to a pre-specified function by pressing each key.

Note: This menu is protected in normal. To cancel the protection, refer to 1.3 Menu usage “Display [MAINTENANCE] menu”.

1 Press **[MENU]** key to display “Menu”.

Select [MAINTENANCE] => [STARTUP] => [FUNCTION KEY] => [F1] key => press **[ENT]** key and after selecting the setup value.

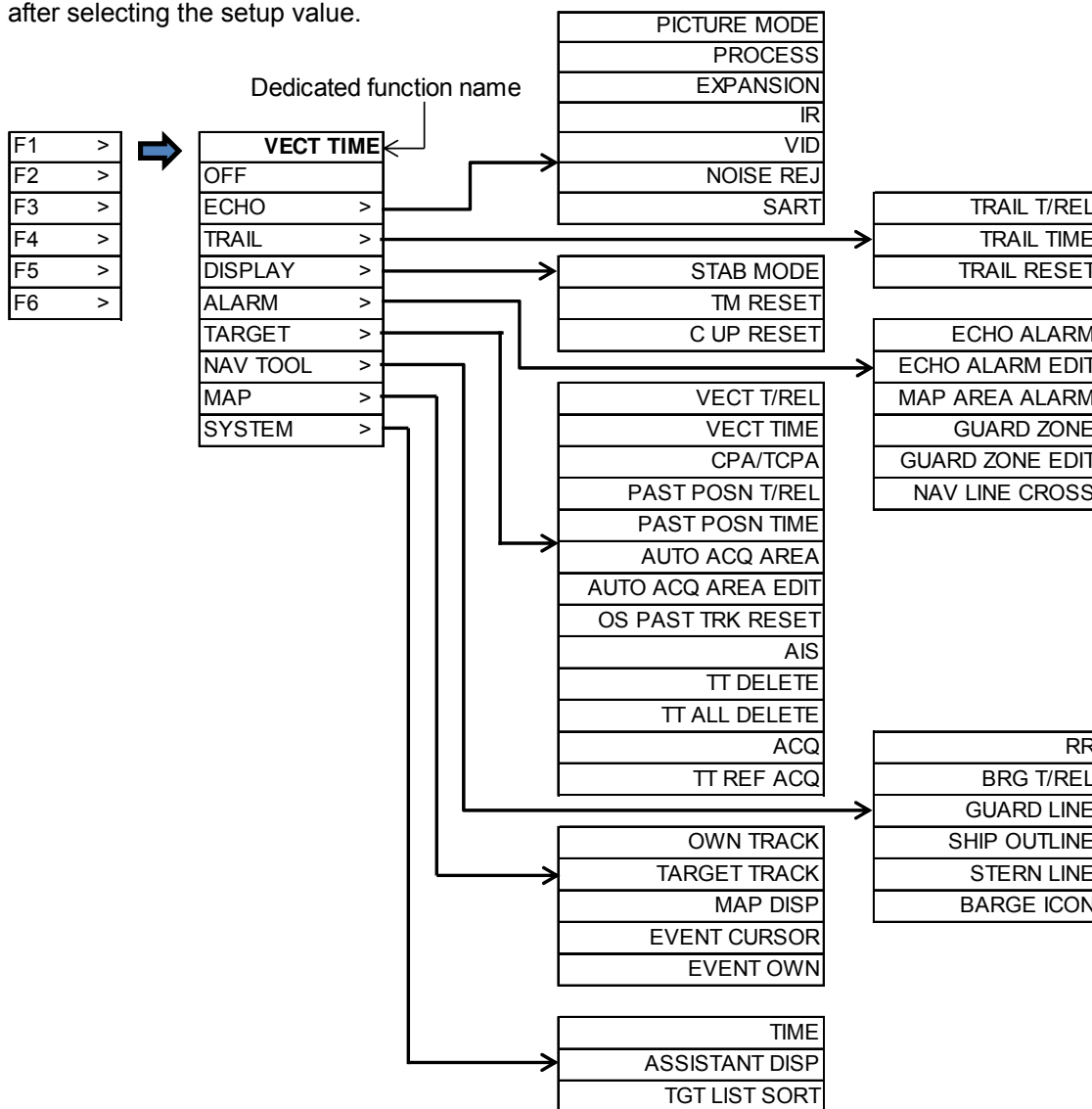

2 Follow procedure (1) to setup keys [F2], [F3], [F4], [F5] and [F6] by selecting each item and press **[ENT]** key.

3 Another way to setup each function key is to press and hold desired key until menu selection shows up on the right of display. Using trackball and **[ENT]** key make a selection and save to designated function key.

2.22 Set picture mode

It is necessary to make adjustment to the radar picture as environment and sea condition changes. The Picture mode can quickly change for different settings, [PROCESS], [EXPANSION], [IR] and [VID], depending on the situation. You can change these setting items individually, and these changes are stored in internal memory.

- 1 Press **MENU** key to display "Menu".
Select [ECHO] => [PICTURE MODE] => press **ENT** key after making your selection.

The setting value can be selected from "PICTURE1, PICTURE2, PICTURE3, NEAR, FAR, HARBOR, ROUGH SEA, RAIN or PURE".

	PROCESS	EXPANSION	IR	VID
PICTURE1:	OFF	OFF	1	3
PICTURE2:	C2	2	OFF	2
PICTURE3:	C2	1	OFF	1
NEAR:	OFF	OFF	1	1
FAR:	C1	2	OFF	4
HARBOR:	C1	1	2	1
ROUGH SEA:	C2	OFF	1	1
RAIN:	C1	OFF	1	1
PURE:	OFF	OFF	OFF	1

PROCESS: Refer to 2.23 Echo process.

EXPANSION: Refer to 2.24 Echo expansion.

IR: Refer to 2.25 Interference rejection (IR).

VID: Refer to 2.26 Video contrast.

[PICTURE MODE] can be changed directly at the upper right of the display using trackball.



2.23 Echo process

Echo process mode feature reduce sea clutter effectively. Echo process mode is used correlation method. Two types of C1 and C2 are available.

[PROCESS] mode can be changed directly at the upper right of the display using trackball.

- 1 Move the cursor to **OFF**, **C1** or **C2** of [PROCESS] at the upper right part of the display. Press **ENT** key repeatedly until the desired choice appears.



Correlation image echo process

At setup value of C1 or C2, correlation images are averaged.

When there is a stable image such as a ship among sporadic images such as sea clutter, the sea clutter is reduced by averaging to leave the stable image.

Due to the averaging process, even though stable strong images appeared just after transmission, they are displayed weaker and gradually turn into strong images.

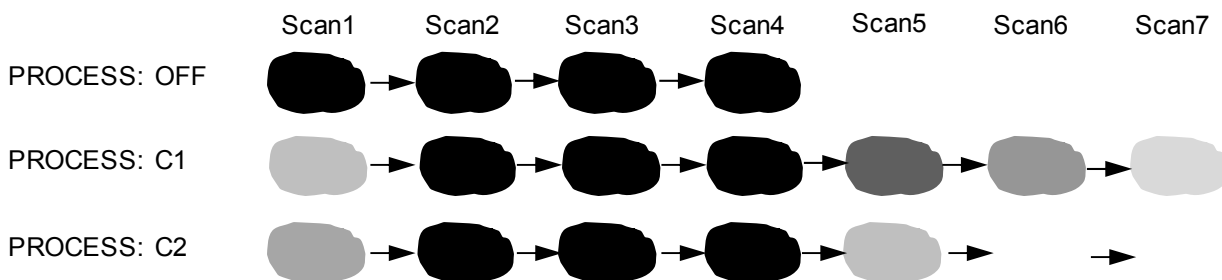

Display of correlation image process in the case when an image appeared and disappeared.

Note:

- For confirmation of an image that may be hidden between the waves and the image of a fast ship that appears at a different position for each scan, the image may be displayed weaker than the actual one. Therefore, when fast moving target on the display, select [PROCESS] **OFF**.
- For operation of GAIN, SEA and RAIN, it may take some time before it becomes effective. Take enough time for the operation, or operate again after [PROCESS] has been once off.
- Echo process mode requires heading signal, echo process mode turns into **OFF** if heading signal is unavailable.

2.24 Echo expansion

This function is to enlarge an image in the direction of distance/bearing.

Small ships and remote targets can be enlarged to be easier to see.

[EXPANSION] can be changed directly at the upper right of the display.

- 1 Move the cursor to set value window of **OFF**, **1**, **2**, **3** or **4** of [EXPANSION] at the upper right part of the display.

Press **ENT** key repeatedly until the desired choice appears.

Note: The setting value can be selected from “OFF, 1, 2, 3 and 4” and the larger value applies stronger enhance effect.

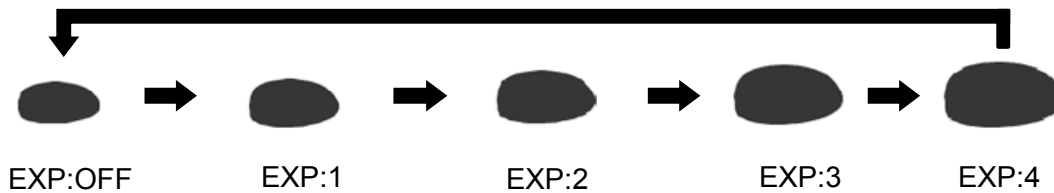

Note: The enlargement of targets has effect on all echoes. So, a large target such as land is also enlarged. Consequently, land and a small target may sometimes be seen as a single target. Pay attention to that.

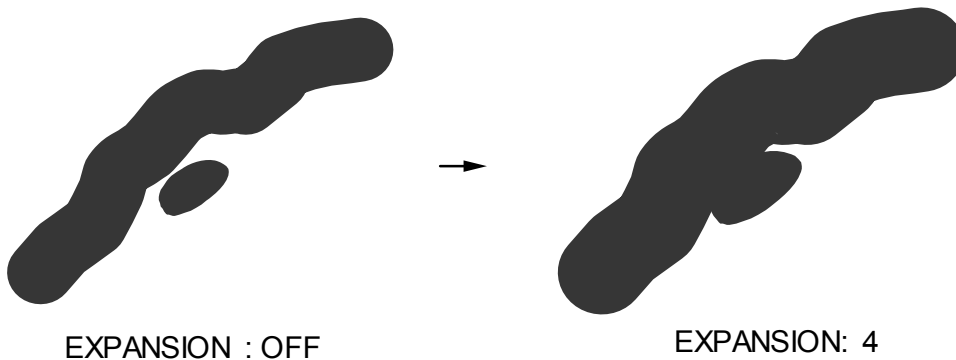

2.25 Interference rejection (IR)

This feature is used to reject interference from other radars.

Radar transmissions on same frequency band can cause interference noise on the display depending on its transmitted power. This noise pattern appearance varies case by case, but is usually spiral shape or like the spokes of a wheel in shape. This function can reduce interference effect.

[IR] can be changed directly at the upper right of the display.

[IR] is also effective to reduce second echo phenomenon.

- 1 Move the cursor to set value window of [IR] at the upper right part of the display.
Press **ENT** key repeatedly until desired value appears.

Note:

- The setting value can be selected from “OFF, 1, 2, and 3” and the larger value applies stronger interference rejection effect.
- Too much removal effect may also remove small targets. Pay attention to that.

2.26 Video contrast

This is a function to change the relation between the strength of returned echo and their display gradation.

At **VID 1**, the difference of signals strength between strong echo and weak echo becomes larger. As the numerical figure becomes larger in **VID 2**, **VID 3**, **VID 4**, and **VID 5** the difference in signal strength becomes smaller.

[VID] can be changed directly at the upper right of the display.

- 1 Move cursor to **1**, **2**, **3**, **4** or **5** of [VID] at the upper right part of the display.
Press **ENT** key repeatedly until desired value appears.

When the difference of signal strength is small, images becomes sharper.

However, signal strength from small ships and buoys is weak, and the difference between clutter and them is not large enough.

Therefore, it is necessary to display clutter which may blend together with small ships and buoys.

2.27 Noise rejection

This radar is equipped with a function that is capable to remove various signals picked up by the radar such as white noise, and display clean picture.

- 1 Press **MENU** key to display "Menu".
Select [ECHO] => [NOISE REJ] => select [OFF], [1] or [2], and press **ENT** key.

2.28 Echo color rejection

This radar has a function to remove a color selected by menu operation.

This effect is to show the strong signal image clearly and to delete the unwanted signal such as noise.

- 1 Press **MENU** key to display "Menu".
Select [ECHO] => [COLOR REJ] => select [OFF] or [1 to 14], and press **ENT** key.

Selection value 1: Lowest signal level color
Selection value 14: Highest signal level color

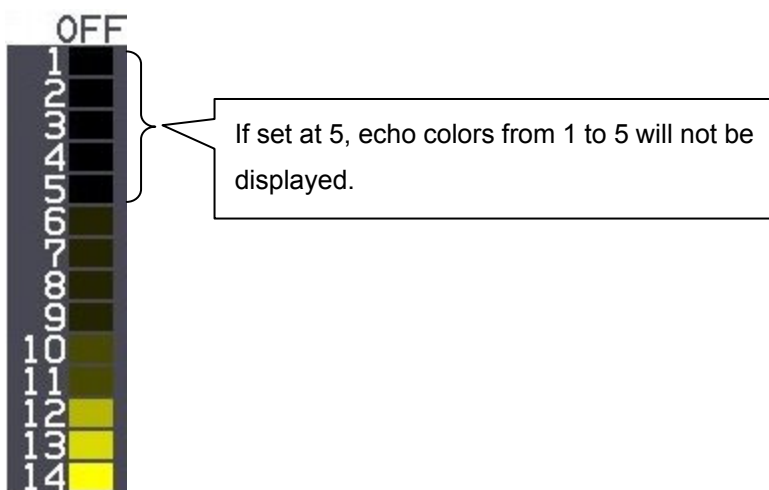

2.29 Pulse width

This radar can change pulse width of the transmission from 0.5NM to 12NM range scale.

SP and LP pulse width can be set separately.

1 Press **[MENU]** key to display "Menu".

Select **[ECHO]** => **[PULSE WIDTH]** => set pulse width, and press **[ENT]** key.

12kW

Range	SP mode							LP mode						
0.125	S1							S1						
0.25	S1							S1						
0.5	S1	S2						S1	S2					
0.75	S1	S2						S1	S2					
1.5	S1	S2	M1	M2				S1	S2	M1	M2			
3		S2	M1	M2	M3	L1			S2	M1	M2	M3	L1	
6				M2	M3	L1	L2				M2	M3	L1	L2
12						L1	L2						L1	L2
24							L2							L2
32							L2							L2
48							L2							L2
64							L3							L3

25kW

Range	SP mode							LP mode						
0.125	S1							S1						
0.25	S1							S1						
0.5	S1	S2						S1	S2					
0.75	S1	S2						S1	S2					
1.5	S1	S2	M1	M2				S1	S2	M1	M2			
3		S2	M1	M2	M3	L1			S2	M1	M2	M3	L1	
6				M2	M3	L1	L2				M2	M3	L1	L2
12						L1	L2						L1	L2
24							L2							L2
48							L2							L2
96							L3							L3

2.30 Receiving Radar Beacons, SART and Radar Enhancer

The X-band radar system is required to be capable of receiving signals emitted from a Radar Beacon, SART (Search and Rescue Transponder) and Radar enhancer. To receive those signals by the radar system, use the following procedures.

- 1** Press **MENU** key to display "Menu".
Select [ECHO] => [SART] => [ON], and press **ENT** key.
- 2** Radar functions are set with following settings.
Range scale: 12 NM
Pulse width: L2
PROCESS: OFF
Interference Rejection: OFF
Performance Monitor: OFF
- 3** In case the radar picture is obscured with too many signals, reduce gain for better observation.
- 4** When own ship approaches the transmitting Radar Beacon or SART, the echoes will become blurred in an arc. For better observation of those signals, adjust the Gain, SEA and RAIN controls, as appropriate.
- 5** [ECHO] => [SART] => [OFF], and press **ENT** key, the setting of above 3 is restored.

About SART

According to the GMDSS (Global Maritime Distress and Safety Systems) requirement, the IMO/SOLAS class ships must be equipped with a SART. When a ship is in distress, a signal will be automatically emitted from the SART so that other ships and/or aircrafts can identify its location. When your ship equipped with a X-band radar comes within 8 NM of a ship in distress, the SART picks up the radar signal and responds to it. The signal consists of 12 sweeps and is emitted in the frequency range of 9.2 GHz through to 9.5 GHz. The SART has two sweep times that switch from slow sweep (7.5 μ s) to fast sweep (0.4 μ s) and vice versa, according to the distance. When the radar receives this signal, a line of 12 dots, which is equally spaced at about 0.64 NM, appears on the display. The nearest blip of the SART indicates the location of the ship in distress. When your ship comes within 1 NM to the SART, a fast sweep signal is displayed on the radar and a thin line connects the 12 blips.

Actual location of the ship carrying the SART

If your ship is located at 1 NM or more away from the SART, the position at which the first echo is displayed is 0.64 NM behind the actual SART position when the 12 SART echoes are identified. If your ship comes within 1 NM from the SART, the fast sweep signal is indicated. The position of this echo is displayed 150 m beyond the actual SART position.

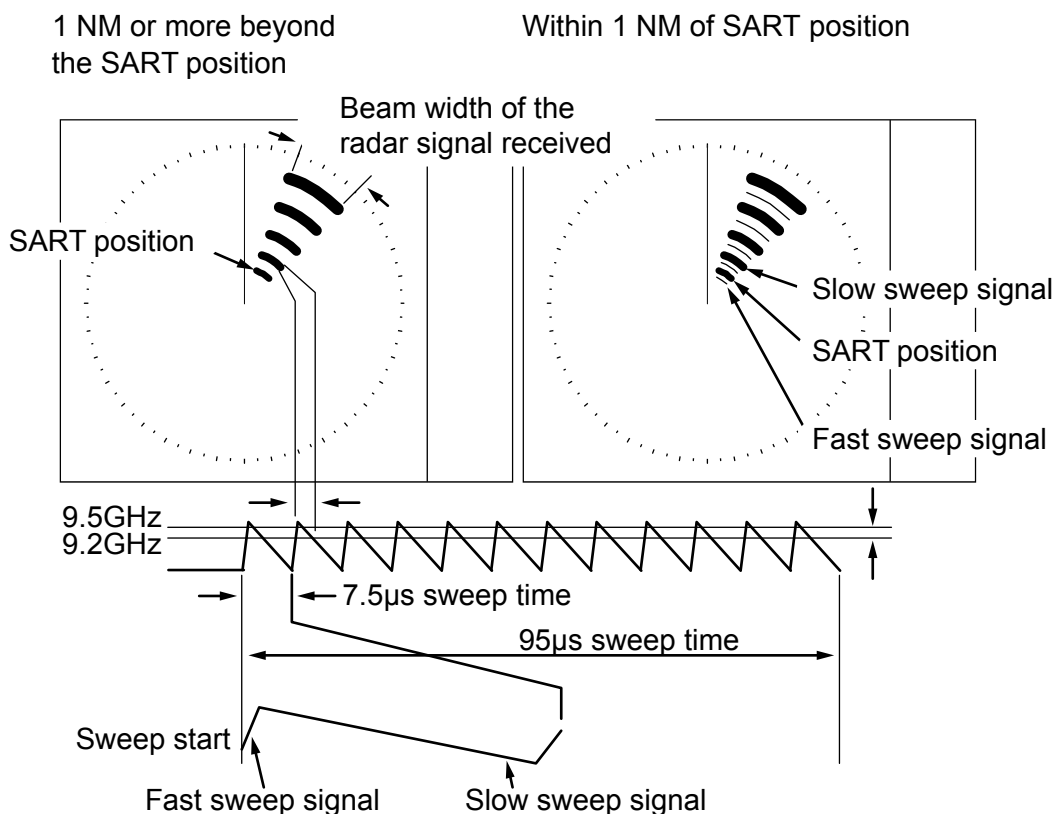

The SART signal presentation and its signal timing

2.31 Inter-switch

Inter-switch is a way to setup two radars to be connected together

Note: If either radar fails while two radars are in use, then set the [INTER-SWITCH] menu of the working radar to [INDEPENDENT MASTER] and use it independently.

Note: [INTER-SWITCH] menu cannot be used while transmitting.

1 Press **MENU** key to display "Menu".

Select [SYSTEM] => [INTER-SWITCH] => select [INTER-SWITCH] mode*, and press **ENT** key.

* Available choices: INDEPENDENT MASTER, INDEPENDENT SLAVE, DUAL MASTER, DUAL SLAVE, CROSS, MONITOR

INDEPENDENT MASTER: Connection status where one antenna is connected to one radar.

INDEPENDENT SLAVE: Connection status where the dedicated cable is connected to the above -mentioned INDEPENDENT (MASTER), and the image of antenna of INDEPENDENT (MASTER) is displayed.

The antenna cannot be controlled. So, it is impossible to perform the change etc. of pulse width.

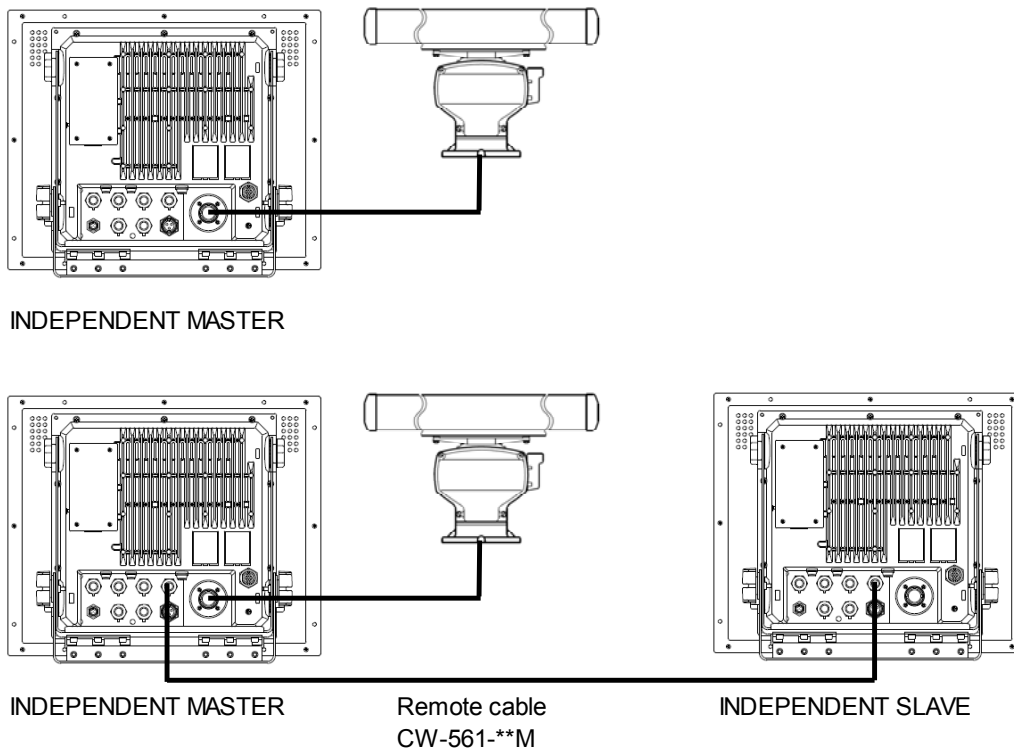

DUAL MASTER: Connection topology is the same as the above-mentioned INDEPENDENT (MASTER) and INDEPENDENT (SLAVE). By this way, either radar can control the antenna. The radar to which the antenna is connected is DUAL (MASTER).

DUAL SLAVE: The radar to which the antenna is not connected is DUAL (SLAVE).

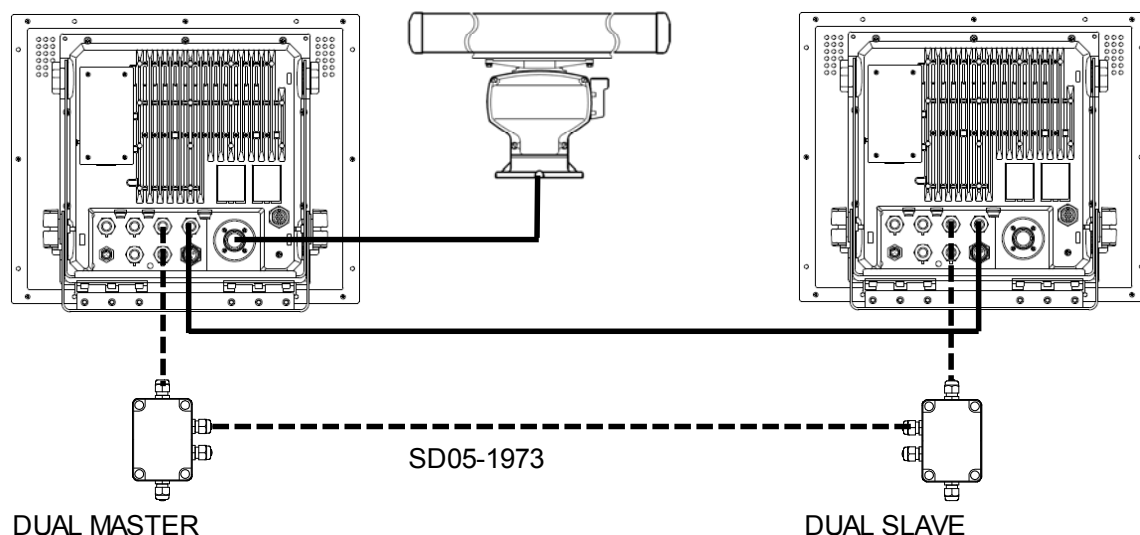

CROSS: In this status, there are two radars to which each antenna is connected. In this status, the antenna that is not connected to its own radar is used.

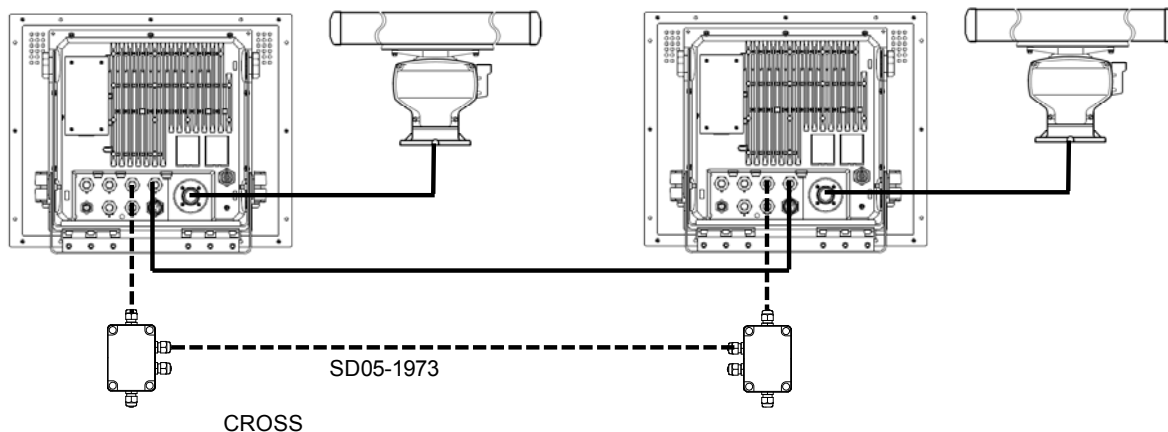

MONITOR: In this status, the antenna is not connected, and a simulator is connected and used.

Note: When you use inter-switch mode at first time, please set Heading (HL OFFSET), TX DELAY and ANT CABLE adjustment of each antenna. (Refer to 4.2.2, 4.2.3 and 4.2.4 of Installation manual) These setting data are memorized in non-volatile memory, and applied automatically when each antenna is selected.

2.32 Cursor data

Cursor data is displayed in distance and bearing at lower right of the display. In addition, it can also be displayed in latitude and longitude position.



CURSOR setting menu

- 1 Press **[MENU]** key to display "Menu".
select **[NAV TOOL]** => **[CURSOR]** =>

CURSOR SHAPE: Set up shape of cursor.

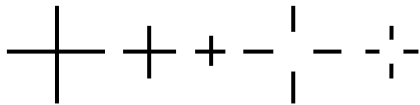

CURSOR: ON/OFF of the cursor indication.

LAT/LON: ON/OFF of the latitude and longitude position display.

CURSOR HUP MOVE: When HUP mode is used, OFF always remains at the fixed position.

ON links a bearing changes and moves.

INFO: ON/OFF of the TT, AIS and MAP information data display selected by cursor and **[ENT]** key.

ON: TT, AIS and MAP information data will be displayed near cursor during about 15 sec. after these data is selected.

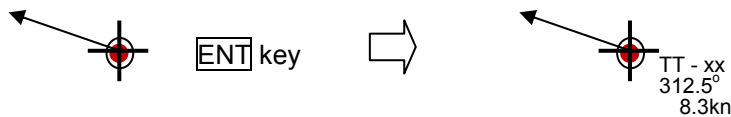

2.33 Performance monitor

Performance monitor is a function to confirm performance degradation such as aging phenomena etc., by recording performance of antenna on its installation or on exchange of antenna parts.

Note: Carry out initial setup without failure on its installation or on exchange of antenna parts.

Confirmation method for degradation of Antenna performance after operation

- 1** Press **MENU** key to display "Menu".
Select [SYSTEM] => [MON] => [ON], and press **ENT** key.
Range is changed to 24NM automatically.
- 2** Confirm SYSTEM bar value.
Please contact with our sales agent or our sales department when SYSTEM bar becomes a half (−10dB) or less in length, because there is a possibility of large performance degradation.
When contacting, please let person in charge know about degradation rate of TX and RX bars.
- 3** Select [SYSTEM] => [MON] => [OFF], and press **ENT** key.

Initial setup methods: Refer to Installation manual.

2.34 Reference position and Display center

Reference position

The base point for range, bearing, relative course, relative speed, CPA or TCPA, EBL or VRM is named [Reference position], respectively.

Either CCRP (consistent common reference point) or ANT (antenna position) can be used as the reference position.

Selection of the reference position is made in **CCRP** or **ANT** of [REF] located of the upper left of the display, with trackball and **ENT** key.



Display center

The display center position can be changed to CCRP (consistent common reference point) or ANT (antenna position) when reference position is CCRP.

- 1 Press **MENU** key to display "Menu".
Select [DISPLAY] => [DISPLAY CENTER] => select [ANT] or [CCRP], and press **ENT** key.

The display center of echo image (PPI) is always ANT position.

When CCRP is selected for the reference position, there is possibility that CCRP is located outside of 90 % echo image area in short distance range.

In this case, the reference position is automatically changed to ANT position.

Antenna position mark ON or OFF

- 1 Press **MENU** key to display "Menu".
Select **[DISPLAY]** => **[ANT POSN]** => select **[ON]** or **[OFF]**, and press **ENT** key.

Note: Antenna position mark is displayed at transmission on condition.

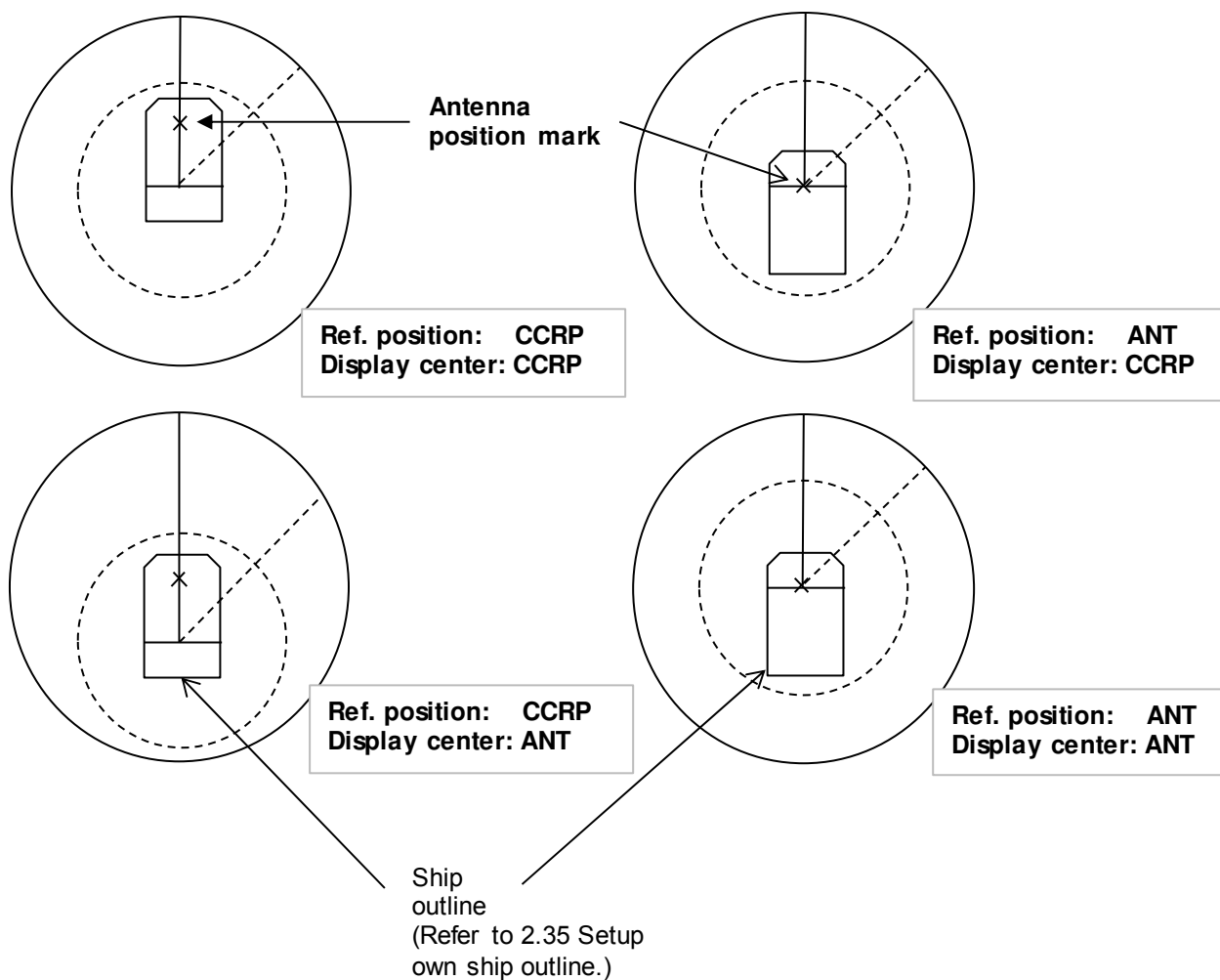

2.35 Setup own ship outline

Set up own ship outline and antenna position from CCRP (Consistent common reference point).

Setup CCRP number and ship outline

- 1 Press **MENU** key to display "Menu".
Select [NAV TOOL] => [SHIP OUTLINE] => [CCRP] => select CCRP number (1 to 4), and press **ENT** key.
- 2 Select [OS PROFILE] => and after selection.

This setup is to designate ship's outline and antenna location of CCRP.

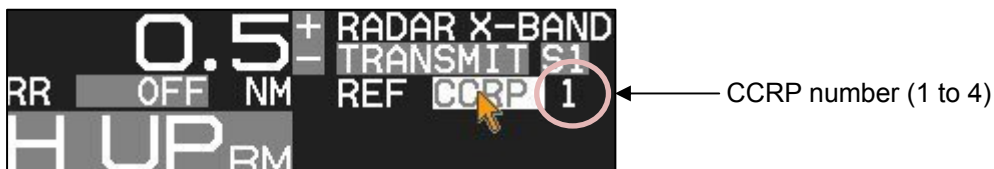
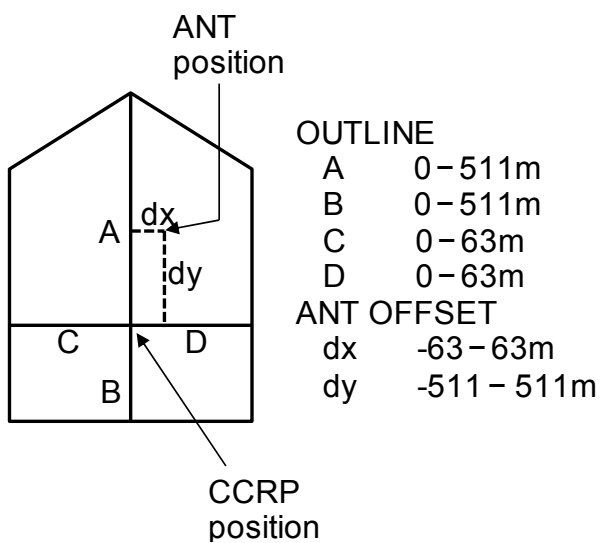

To show own ship outline, turn on ship outline menu.

- 1 Press **MENU** key to display "Menu".
Select [NAV TOOL] => [SHIP OUTLINE] => [SHIP OUTLINE] => [ON], and press **ENT** key.

If ship's width (C+D) is less than 10m, then even 0.125NM range will not show own ship outline.

2.36 FERRY MODE

It is a function to use a river for by coming and going ferry etc.

It becomes effective at H UP, and the letter of the FERRY appears on the screen while using it.

[FERRY MODE] menu is not available by default.

Note: This menu is protected in normal. To cancel the protection, refer to 1.3 Menu usage “Display [MAINTENANCE] menu”.

1 Press **[MENU]** key to display “Menu”.

Select [MAINTENANCE] => [STARTUP] => [FERRY MENU] to use [FERRY MODE] menu.

Selection values: [DISPLAY] => [FERRY MODE] =>

FERRY MODE: OFF, ON Turn ferry mode on or off

HDG: 0°, 180° Gyro reading has 180 degrees added to it or subtracted from it

HEADING LINE: UP, DOWN Change of the heading line indication up or down

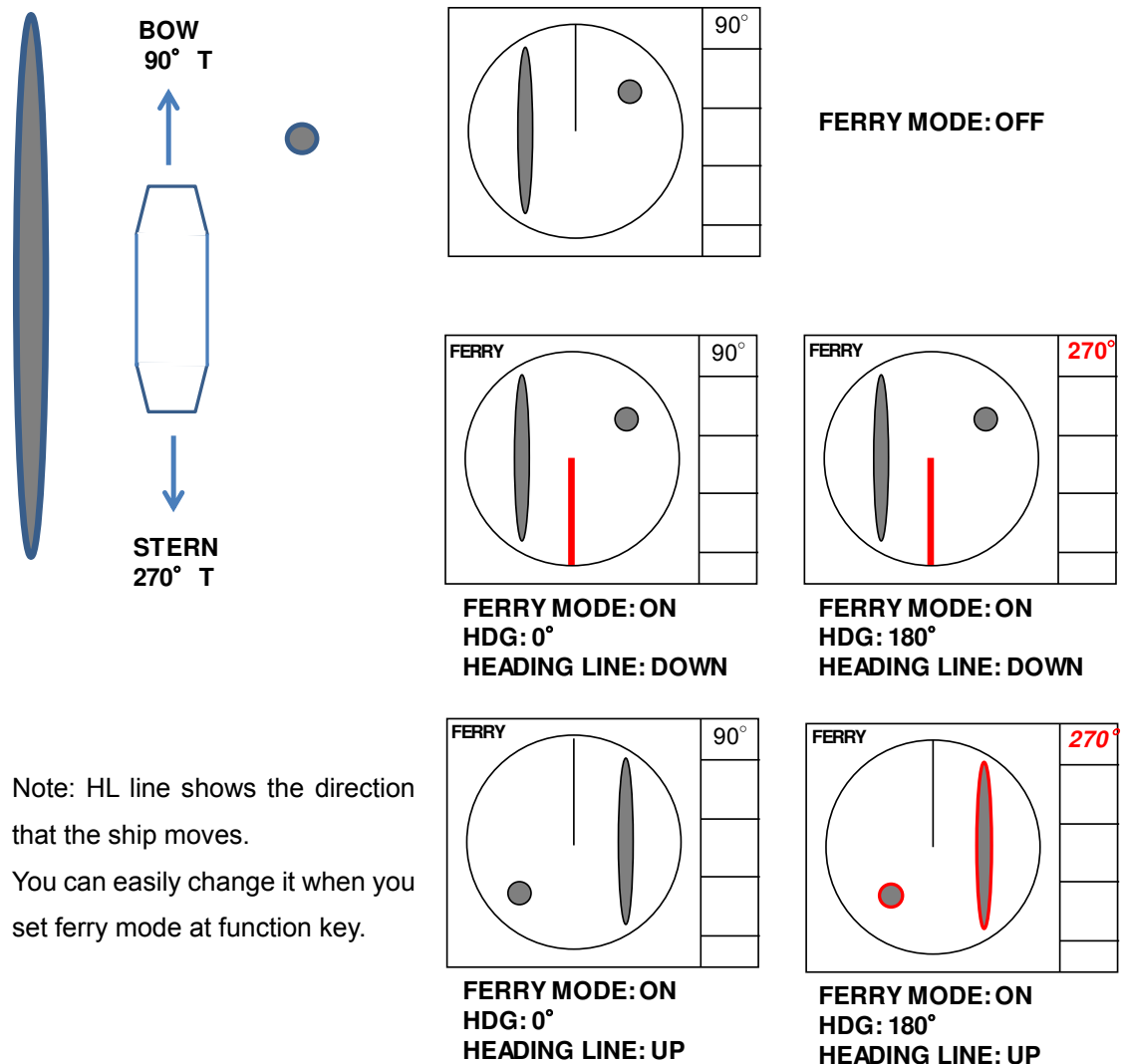

Note: HL line shows the direction that the ship moves.

You can easily change it when you set ferry mode at function key.

- This page intentionally left blank.-

Chapter 3 Alarm

This function is used to monitor hazardous targets such for collision prevention.

Collision avoidance

It is strongly recommended to maneuver the ship for collision avoidance based on true and dependable SOG and COG information.

This is because ship's heading and running speed against water may be different from the actual ship's movement due to foreign or mostly natural environmental effect such as wind, current, wave etc.

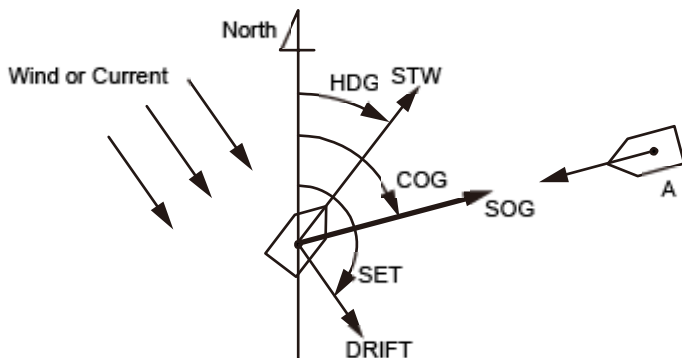

3.1 Echo alarm

Echo alarm function has two movement modes of [IN] and [OUT].

[IN] mode: When the echo enters a specified fan type alarm area, warning message will be displayed at lower right of the display and an alarm will sound.

[OUT] mode: When echoes leave specified fan type alarm area, warning message will be displayed at lower right of the display and an alarm will sound.

How to set echo alarm area (Fan type)

- 1 Press **[MENU]** key to display "Menu".
 Select **[ALARM]** => **[ECHO ALARM]** => select **[IN]** or **[OUT]**, and press **[ENT]** key.
 The color of **[EBL1]**, **[EBL2]**, **[VRM1]** and **[VRM2]** key's light turn red.
 ► symbol will be shown at the left of numerical indication of **[BRG REL]** or **[WIDTH]** and **[RNG]** or **[DEPTH]** menu.
 Blue dotted line of echo alarm area and orange dashed circle line will be displayed on the display.

14	>ALARM	
11	ECHO ALARM	IN
12	BRG REL	328 .0°
13	WIDTH	▶110 .0°
14	RNG	▶004 .5NM
15	DEPTH	001 .0NM

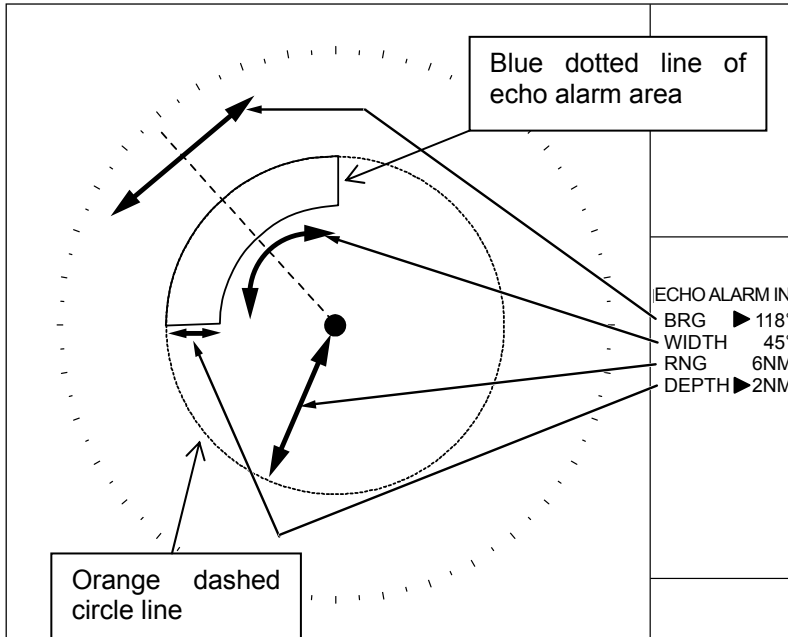

VRM knob and **EBL** knob are used for setup.

- 3** Press **EBL1** or **EBL2** key, and select an item to be set between [BRG REL] and [WIDTH] by using **EBL** knob.
 In the same way, press **VRM1** or **VRM2** key, and select an item to be set between [RNG] and [DEPTH] by using **VRM** knob.
 The selected item is shown with a ► symbol at the left of numerical indication at the echo alarm in the menu display.
- 4** When the setting of the echo alarm area is completed, then press **ENT** key, orange dashed circle line will disappear, and echo alarm will be active.
- 5** There are additional items, [ALARM] => [DETECT LEVEL] => select [1 to 15]
 It designates echo strength to determine an alarm sound.
 1 means lowest signal echo level, 15 means highest signal echo level.
 When the level is set too low, noise may cause false alarm.
 Note: [DETECT LEVEL] is applied to the map area alarm function of next section.

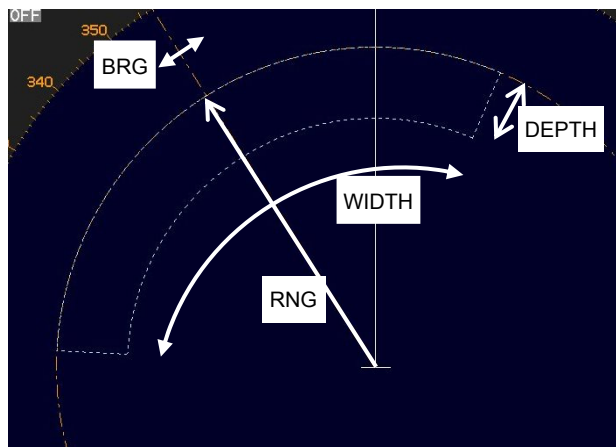

Note: If the echo alarm area is set in the whole circumference, [WIDTH] needs to be set the 0.0° or 360.0°.

3.2 Map area alarm

Map area alarm function provides alarm display when echo enters or leaves from the MAP AREA.

- 1 Press **MENU** key to display "Menu".

Select [ALARM] => [MAP AREA ALARM] => select [IN] or [OUT], and press **ENT** key.

[IN] mode: When the echo enters a specified map area, warning message will be displayed at lower right of the display and an alarm will sound.

[OUT] mode: When the echo leaves a specified map area, warning message will be displayed at lower right of the display and an alarm will sound.

How to edit map area

There are two methods to edit map area. First method is to use cursor, second is to input latitude/longitude via the menu.

Example: Cursor method

- 1 Press **MENU** key to display "Menu".

Select [ALARM] => [MAP AREA ALARM] => [EDIT] => [CURSOR] => select [1 to 10] => [GO], and press **ENT** key.

- 2 Move cursor to first input position, then press **ENT** key.

No.1 mark (small circle) is displayed with numerical number on the display, and numerical data information is displayed in the "AREA INFO" area at right side on the display.

If necessary, Latitude and longitude data can be changed using cursor and **ENT** key by "AREA INFO". Also line color can be changed directly by using cursor by "AREA INFO". If you want to delete input data, move cursor to word "DELETE", then press **ENT** key.

- 3 Move cursor to second input position, then press **ENT** key. No.2 mark is displayed, and a line is generated from No.1 to No.2.

- 4 Move cursor to third input position, then press **ENT** key. No.3 mark is displayed, and a line is generated from No.2 to No.3 and No.1 to No.3.

You can input up to 100 points. The minimum is three points. When input is completed, press **MENU** key, numerical marks on the display will disappear, and map area alarm will be activated.

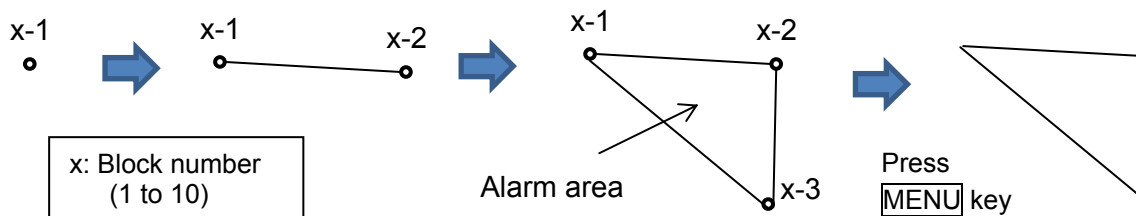

- 5** The procedures to input plural divided map areas in the memory of same block number are as follows. (Example)

After input the one map area (from x-1 to x-3), please input the start point of the new map area (x-4). Press **OFF** key to divide the start point (x-4) from the first and last point (x-1, x-3).

Repeat operation of clause 3 and 4 mentioned previously (x-5, x-6).

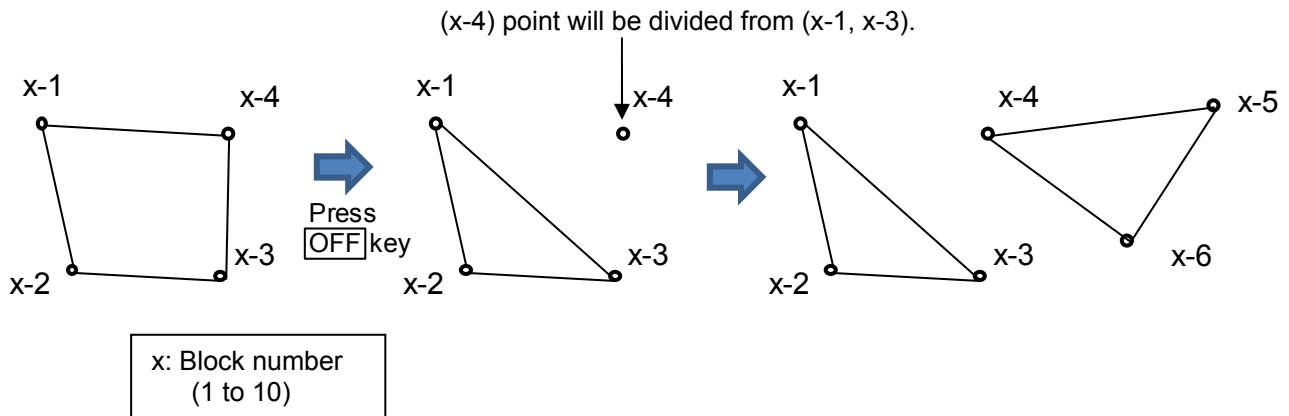

- 6** There are additional items, [ALARM] => [DETECT LEVEL] => select [1 to 15]

It designates echo strength to determine an alarm sound.

1 means lowest signal echo level, 15 means highest signal echo level.

When the level is set too low, noise may cause false alarm.

Note: [DETECT LEVEL] is applied to the echo alarm function in previous section.

How to move map area

There are two methods to move map area position. First method is to use cursor, second is to input latitude/longitude via the menu.

Example: Cursor method

- 1** Press **MENU** key to display "Menu".
Select [ALARM] => [MAP AREA ALARM] => [MOVE] => [CURSOR] => select [1 to 10] => [GO], and press **ENT** key.
- 2** Move cursor to the map area mark which you want to move to new position, then change color or delete position data.
- 3** Press **ACQ** key, middle circle mark will appear on the selected mark position, and numerical data information is displayed in the "AREA INFO" at right side of the display.
- 4** Move cursor to new position, then press **ENT** key. Selected mark position will move to new position.
Latitude and longitude position data can be changed directly by using cursor and **ENT** key by "AREA INFO". Line color can be changed directly by using cursor by "AREA INFO". If you want to delete selected data, move cursor to word "DELETE", then press **ENT** key.
- 5** Repeat operation of clause 2 to 4 mentioned previously.

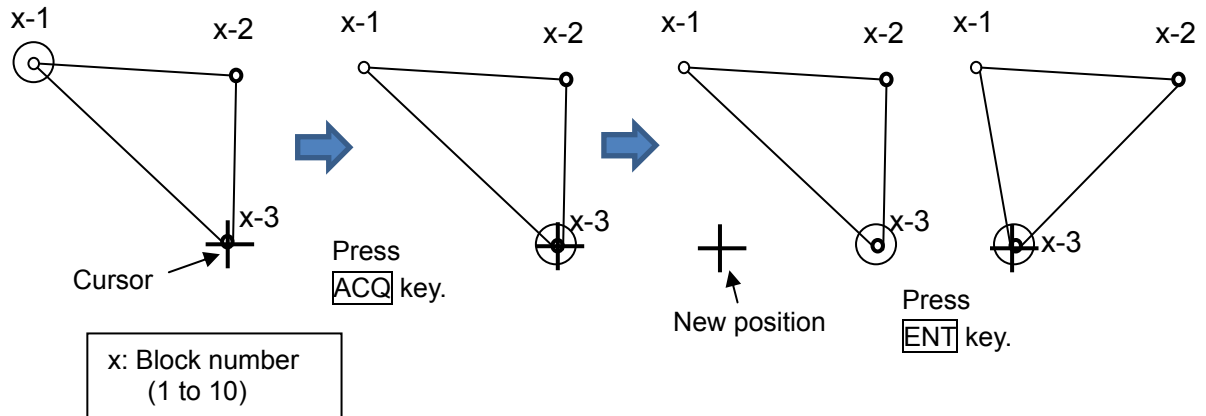

- 6** When move operation is completed, press **MENU** key, numerical marks on the display will disappear, and map area alarm function will be active.

How to add data to map area

There are two methods to add map area alarm position. First method is to use cursor, second is to input latitude/longitude via the menu.

Example: Cursor method

- 1** Press **MENU** key to display "Menu".
Select **[ALARM]** => **[MAP AREA ALARM]** => **[ADD]** => **[CURSOR]** => select [1 to 10] => **[GO]**, and press **ENT** key.
- 2** Move cursor on the map area mark before which you want to insert new mark, then change color or delete position data.
- 3** Press **ACQ** key, middle circle mark will appear on the selected mark position, and numerical data information is displayed in the "AREA INFO" at right side on the display.
- 4** Move cursor to new position where you want to add point, then press **ENT** key. New position point will be inserted on the display.

Selected latitude and longitude position data can be changed directly by using cursor and **ENT** key by "AREA INFO". Line color can change directly using cursor by "AREA INFO". If you want to delete selected data, move cursor to word "DELETE", then press **ENT** key.

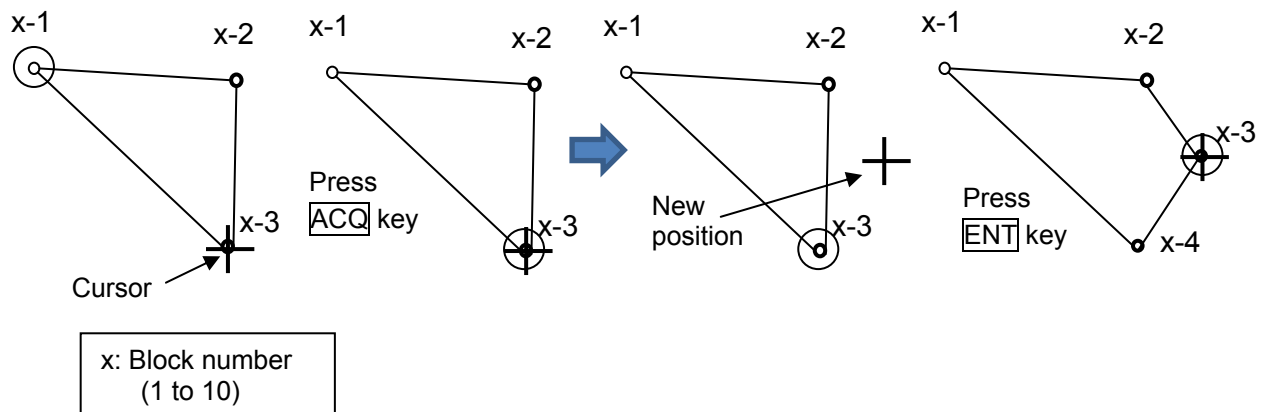

How to delete the data of map area

There are two methods to delete map area alarm position. First method is to delete the point that is selected by cursor, second is to select the number from the menu.

Example: Cursor method

- 1 Press **MENU** key to display "Menu".
Select [ALARM] => [MAP AREA ALARM] => [DELETE] => [CURSOR] => select [1 to 10] => [GO], and press **ENT** key.
- 2 Move cursor on the map area mark which you want to delete.
- 3 Press **ENT** key.
Selected map area position data will delete.

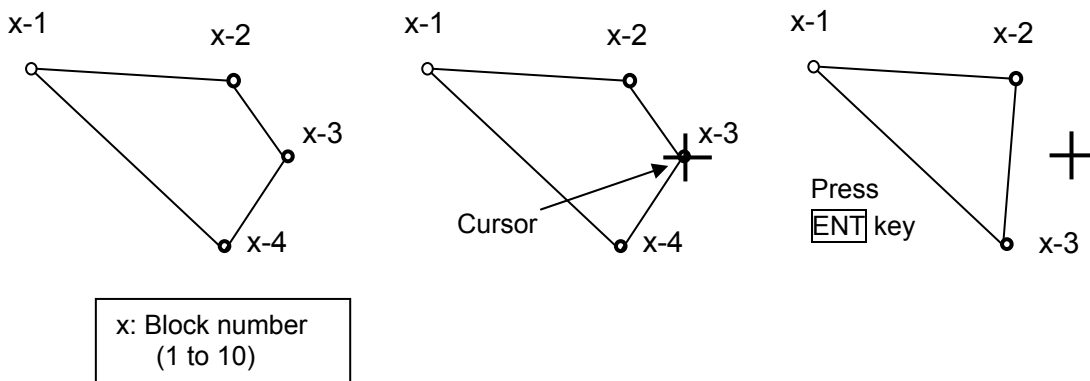

How to clear entire block of map area data

The map area data block can be cleared by using menu operation.

- 1 Press **MENU** key to display "Menu".
Select [ALARM] => [MAP AREA ALARM] => [CLEAR] => [BLOCK NUMBER] => select [1 to 10] => [GO], and press **ENT** key.
Selected map area block will be cleared.

3.3 Guard zone alarm

Guard zone alarm is an alarm system using TT (ARPA) tracked target or an AIS active target signal.

If a TT (ARPA) tracked target or an AIS active target enters a guard zone, then a large, red symbol is displayed and [ALARM] is generated.

If a TT (ARPA) un-tracked target or an AIS sleeping target enters there, then no alarm is generated.

How to set guard zone alarm

- 1 Press **[MENU]** key to display "Menu".

Select [ALARM] => [GUARD ZONE] => [ON], and press **[ENT]** key.

The color of **[EBL1]**, **[EBL2]**, **[VRM1]** and **[VRM2]** key's light turns red.

▶ symbol will be shown at the left of numerical indication of [BRG REL] or [WIDTH] and [RNG] or [DEPTH] menu.

Blue dashed line of guard zone alarm area and orange dashed circle line will be displayed on the display.

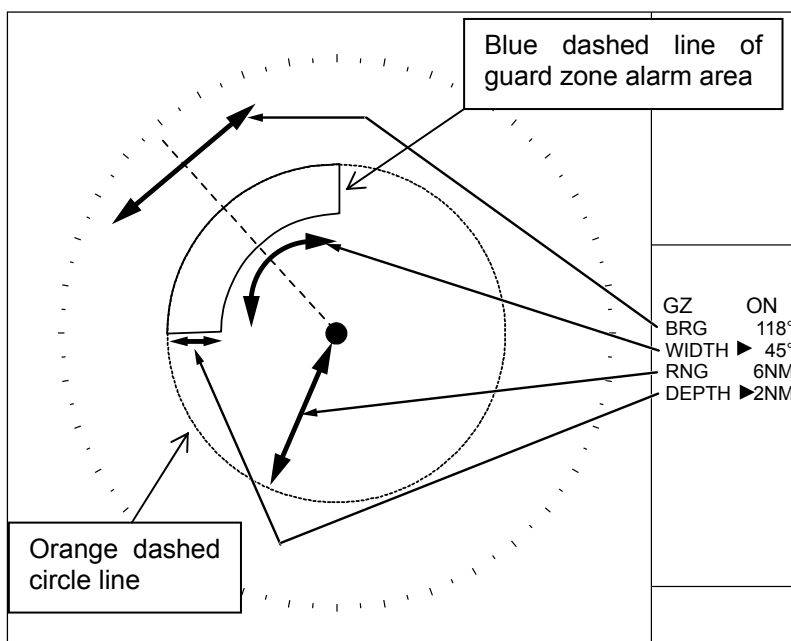

[VRM] knob and **[EBL]** knob are used for setup.

- 2 Press **[EBL1]** or **[EBL2]** key, and Select an item to be set between [BRG REL] and [WIDTH] by using **[EBL]** knob.

In the same way, press **[VRM1]** or **[VRM2]** key, and select an item to be set between [RNG] and [DEPTH] by using **[VRM]** knob.

The selected item is shown with a ▶ symbol at the left of numerical indication at the guard zone alarm in the menu display.

- 3 When the setting of the guard zone alarm area is completed, then press **[ENT]** key, orange dashed circle line will disappear, and guard zone area alarm will be activated.

Note: If the guard zone alarm area is set in the whole circumference, [WIDTH] needs to be set the 0.0° or 360.0°.

3.4 Nav line cross

Nav line cross function enables to attract attention for safety navigation with alarm display when own ship crosses the course preliminarily set (by cursor or latitude/longitude input).

- 1 Press **MENU** key to display "Menu".
Select [ALARM] => [NAV LINE CROSS] => [ON], and press **ENT** key.

Note: When set [NAV LINE CROSS] menu to [OFF], this data will be displayed as line data of map that looks like coast line.

Refer to 6.4 COAST LINE.

Refer to 6.5 NAV LINE.

How to edit

There are two methods to edit nav line cross alarm. First method is to use cursor, second is to input latitude/longitude by the menu.

Example: Cursor method

- 1 Press **MENU** key to display "Menu".
Select [ALARM] => [NAV LINE CROSS] => [EDIT] => [CURSOR] => select [1 to 10] => [GO], and press **ENT** key.
- 2 Move cursor to first input position, then press **ENT** key. No.1 mark (small circle) is displayed with numerical number on the display, and numerical data information is displayed in the "NAV LINE INFO" area at right side on the display.
If necessary, latitude and longitude data can be changed using cursor and **ENT** key by "NAV LINE INFO" area. Also line color can be changed directly by using cursor and **ENT** key by "NAV LINE INFO" area. If you want to delete input data, move cursor to word "DELETE", then press **ENT** key.
- 3 Move cursor to second input position, then press **ENT** key. No.2 mark is displayed, and a line is generated from No.1 to No.2.
- 4 Move cursor to third input position, then press **ENT** key. No.3 mark is displayed, and a line is generated from No.2 to No.3.

You can input up to 100 points. The minimum is two points. When input is completed, press **MENU** key, numerical marks on the display will disappear, and nav line cross alarm will be activated.

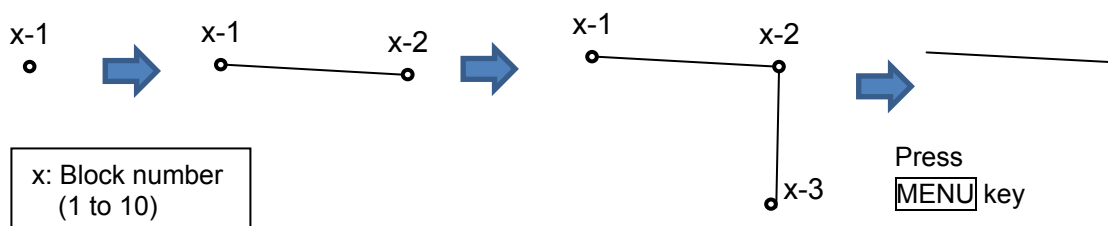

- The procedures to input plural divided nav line in the memory of same block number are as follows.
(Example)

After input the one nav line (from x-1 to x-3), please input the start point of the new nav line (x-4).

Press **OFF** key to divide the start point (x-4) from the last point (x-3).

Repeat operation of clause 3 and 4 mentioned previously (x-5, x-6).

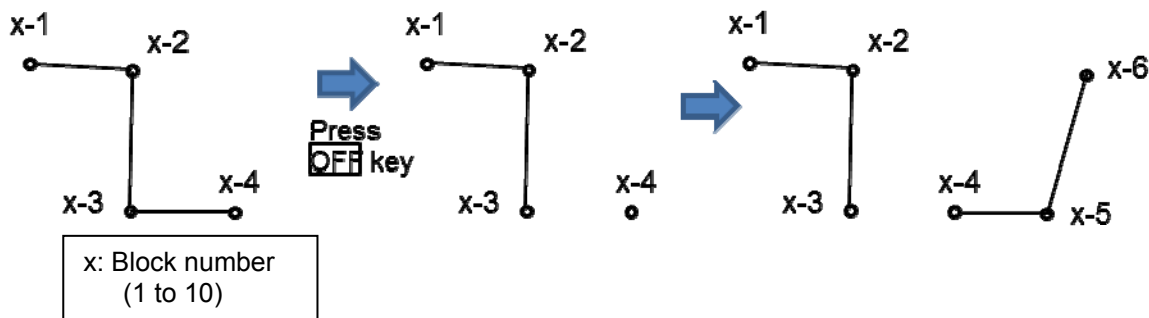

How to move nav line

There are two methods to move nav line cross alarm. First method is to use cursor, second is to input latitude/longitude by the menu.

Example: Cursor method

- Press **MENU** key to display "Menu".
Select [ALARM] => [NAV LINE CROSS] => [MOVE] => [CURSOR] => select [1 to 10] => [GO], and press **ENT** key.
- Move cursor to the nav line cross mark which you want to move to new position, then change color or delete position data.
- Press **ACQ** key, medium circle mark will appear on the selected mark position, and numerical data information will be displayed in the "NAV LINE INFO" area at right side on the display.
- Move cursor to new position, then press **ENT** key. Selected mark position will move to new position.
Latitude and longitude position data can be changed directly by using cursor and **ENT** key by "NAV LINE INFO". Line color can be changed directly by using cursor by "NAV LINE INFO" area. If you want to delete selected data, move cursor to word "DELETE", then press **ENT** key.
- Repeat operation of clause 2 to 4 mentioned previously.

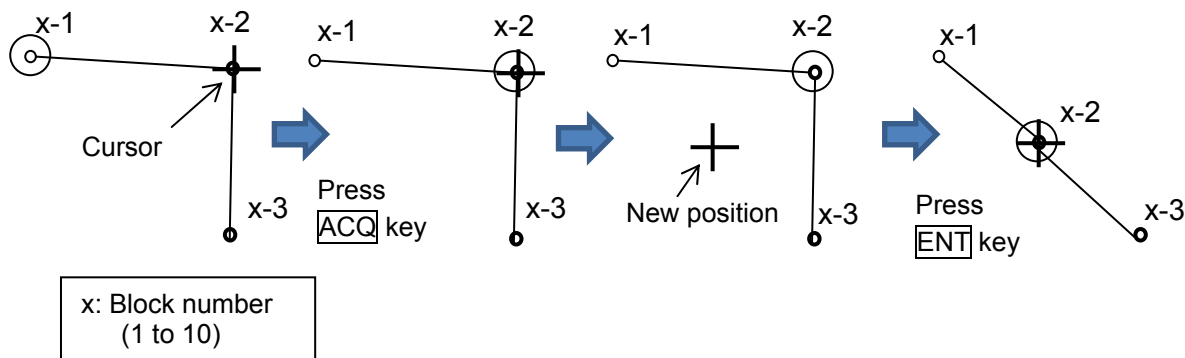

- 6 When move operation is completed, press **MENU** key, numerical marks on the display will disappear, and nav line cross alarm will be activated.

How to add

There are two methods to add nav line cross alarm position. First method is to use cursor, second is to input latitude/longitude by the menu.

Example: Cursor method

- 1 Press **MENU** key to display "Menu".
Select [ALARM] => [NAV LINE CROSS] => [ADD] => [CURSOR] => select [1 to 10] => [GO], and press **ENT** key.
- 2 Move cursor to the nav line cross mark before which you want to add new mark, then change color or delete position data.
- 3 Press **ACQ** key, medium circle mark will appear on the selected mark position, and numerical data information is displayed in the "NAV LINE INFO" area at right side on the display.
- 4 Move cursor to new additional position, then press **ENT** key. New position point will be inserted on the display.

Selected latitude and longitude position data can be changed directly using cursor and **ENT** key via "NAV LINE INFO" area. Line color can be changed directly using cursor via "NAV LINE INFO" area. If you want to delete selected data, move cursor to word "DELETE", then press **ENT** key.

- 5 Repeat operation of clause 2 to 4 mentioned previously.

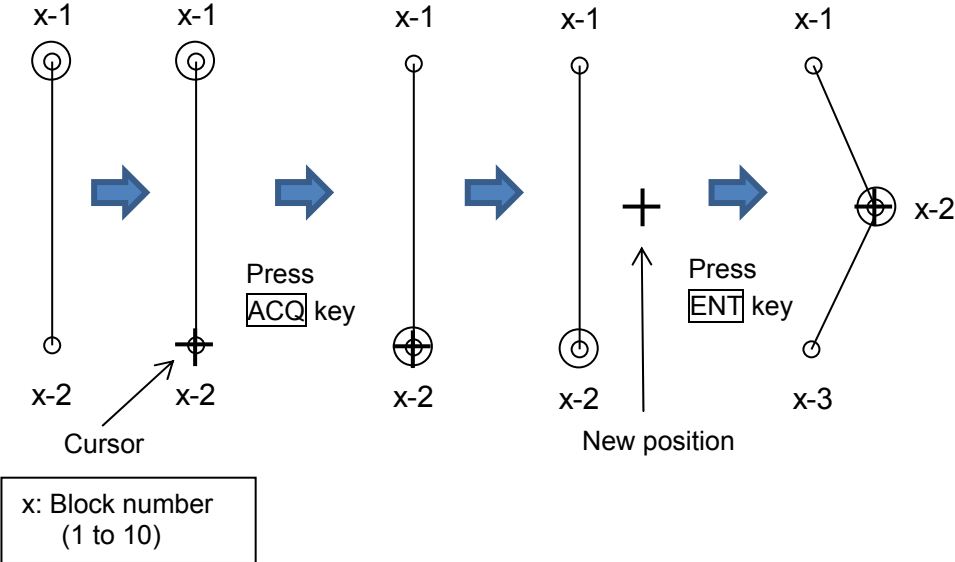

- 6 When add operation is completed, press **MENU** key, numerical marks on the display will disappear, and nav line cross alarm will be activated.

How to delete

There are two methods to delete the data of nav line cross alarm position. First method is to delete the point that is selected by cursor directly, second is to select the number from the menu.

Example: Cursor method

- 1 Press **[MENU]** key to display "Menu".
Select **[ALARM]** => **[NAV LINE CROSS]** => **[DELETE]** => **[CURSOR]** => select [1 to 10] => **[GO]**, and press **[ENT]** key.
- 2 Move cursor to the nav line cross mark which you want to delete.
- 3 Press **[ENT]** key.
Selected nav line cross position data will be deleted.

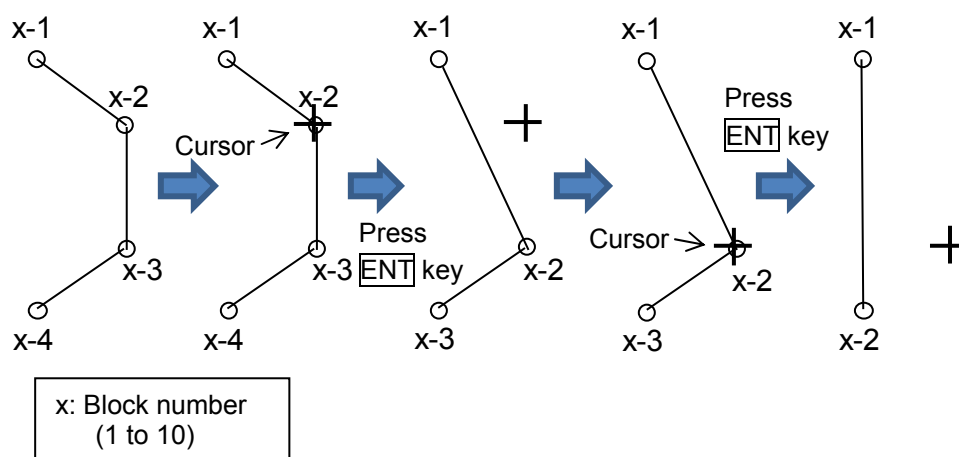

How to clear

The nav line cross alarm data block can be cleared by using menu operation.

- 1 Press **[MENU]** key to display "Menu".
Select **[ALARM]** => **[NAV LINE CROSS]** => **[CLEAR]** => **[BLOCK NUMBER]** => select [1 to 10] => **[GO]**, and press **[ENT]** key.
Selected nav line cross alarm data block will be cleared.

3.5 Alarm List

List is an area that displayed a list of currently present alarms.

It lists the alarms activated by the error device selected by the after-mentioned [PRIORITY] in chronological order from top to bottom. Then, it lists the alarms of other error devices in the same order.

1 Press **MENU** key to display "Menu".

Select [ALARM] => [LIST] =>

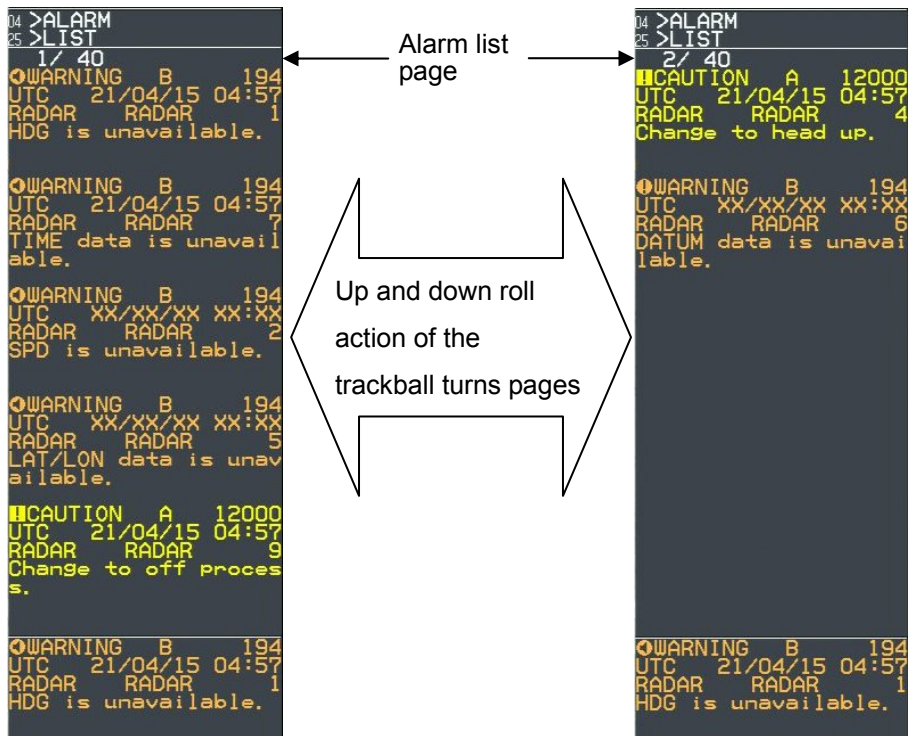

Alarm goes off automatically when cause of alarm disappears.

3.6 Alarm History list

Alarm History List is an area that displayed a list of past alarms.

It lists the alarms activated in the past in chronological order from top to bottom.

- 1 Press **[MENU]** key to display "Menu".
Select **[ALARM]** => **[HISTORY LIST]** =>



Maximum number of alarms which can be displayed is 200. Alarms in excess of 200 are deleted.
The up and down roll action of the trackball turns 40 pages.

History List Sort menu sorts the indication contents of History List.

- 1 Press **[MENU]** key to display "Menu".
Select **[ALARM]** => **[HISTORY LIST SORT]** => **[PRIORITY, CATEGORY or TIME]** =>
[PRIORITY] => ALL, ALARMS, WARNINGS or CAUTIONS
Sorts the kinds of alerts
[CATEGORY] => ALL, A or B
Sorts the kinds of category
[TIME] => LAST IN or FIRST IN
Choose a turn of the indication

3.7 Alarm on/off (TT and AIS)

This function is to set auto acquisition target (TT and AIS) alarm function on or off which is set by [TARGET] => [AUTO ACQ AREA] menu.

[AUTO ACQ] function [ON] activates the alarm function when TT and/or AIS target enters designated auto acquisition area.

[MESSAGE] function of [ALARM] => [ALARM ON/OFF] => [AIS] menu is the alarm of received message.

When AIS receive a message for own ship, alarm information is displayed on alarm display area, and select AIS symbol automatically to know the sender.

Using AIS message alarm function user must input own ship MMSI number correctly.

Chapter 4 Target (AIS, TT and Trial manoeuvre)

4.1 Common setting

VECTOR REL/TRUE

The course and speed are indicated as vector after tracking is established.

Two types of display mode are available: relative display (REL) and true display (TRUE).

REL: This vector adds the course/speed of a target to the course/speed of own ship.

If the vector is directed towards own ship, possibility of collision exists.

It shows danger of collision at a glance and is useful to avoid collision.

TRUE: This vector shows the course/speed of a target only, regardless of own ship.

- 1 Press **[MENU]** key to display "Menu".

Select **[TARGET]** => **[VECT]**, and press **[ENT]** key after making selection.

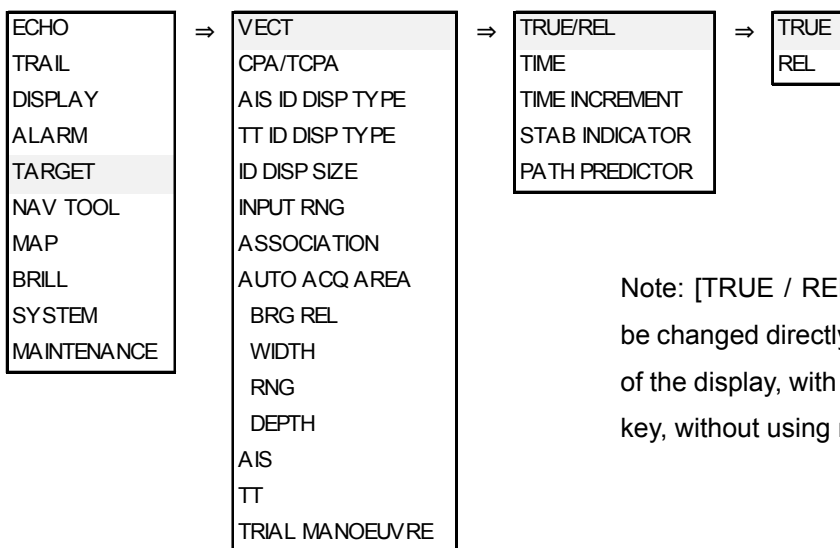

Note: **[TRUE / REL]** and **[TIME]** can be changed directly at the upper right of the display, with trackball and **[ENT]** key, without using menu.

- 2 In addition, there are **[TIME]**, **[TIME INCREMENT]**, **[STAB INDICATOR]** and **[PATH INDICATOR]** setups.

[TIME]: It designates length of vector by time. When **[TIME]** is specified by 1 min, the vector is displayed to the position that will be reached in 1 min by present target speed.

Selection values: OFF, 30sec, 1min, 3min, 6min, 12min, 30min, 60min

[TIME INCREMENT]: This vector displays the division number of time divider. When the setup value is 2, vector is 1/2 and the parting line is displayed at a half-length location of vector.

Selection values: OFF, 2, 3, 5, 10

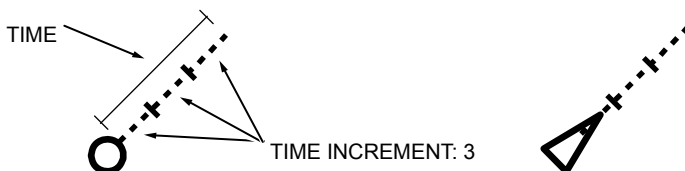

[STAB INDICATOR]: This function is to display the mark of GND or SEA stabilization on the end of own ship vector.

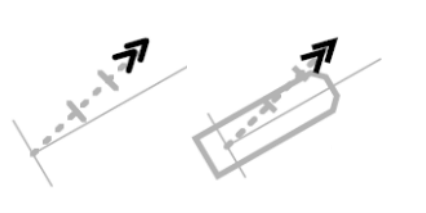
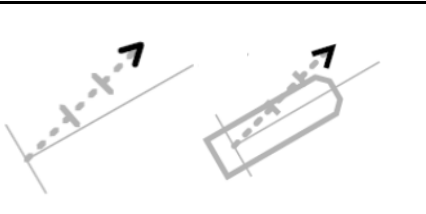
Symbol	Symbol name
	GNG indicator (Double arrowhead)
	SEA indicator (Single arrowhead)

STAB INDICATOR is displayed only when VECTOR is displayed.

STAB INDICATOR is not displayed when PATH PREDICTOR is "on".

[PATH PREDICTOR]: This function is to display a path predictor in place of a velocity vector as a curved line.

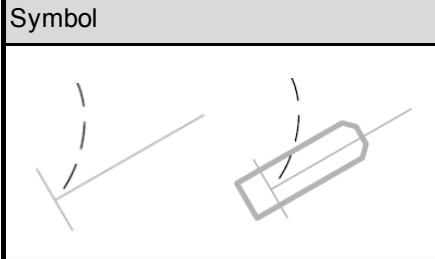
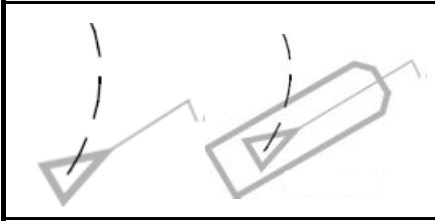
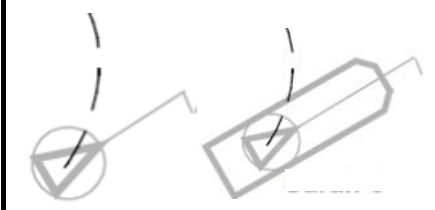
Symbol	Symbol name
	Own ship path predictor
	AIS target predictor
	Associated target path predictor

CPA/TCPA alarm

The menu of "[TARGET] => [CPA/TCPA]" sets the alarm function ON or OFF.

To avoid collision, it sets up LIMIT CPA (closest point of approach) and LIMIT TCPA (time to CPA).

[LIMIT CPA] and [LIMIT TCPA] can be changed directly at the upper right of the display.

- 1 Move the cursor to set the value window of [CPA] at the upper right of the display.

Press **ENT** key and change the setting value with the trackball.

Press **ENT** key to save after changing the setup value.

- 2 In addition, [LIMIT TCPA] is used to specify limit by time.

LOST ALARM

LOST ALARM function of target status area can be changed lost alarm ON or OFF mode of TT (ARPA) and AIS target.

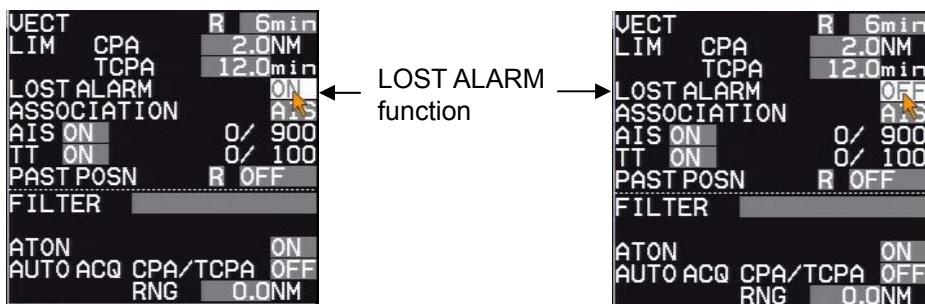

- 1 When LOST ALARM is ON, lost target symbol is displayed on the last reported (known or predicted) target position and a lost target warning is appeared on alarm area display until confirmation operation with **OFF** key.
- 2 When LOST ALARM is OFF, lost target symbol is not displayed, and does not appear lost alarm message on alarm area display.

Note: When Sleeping lost of AIS alarm mode sets to OFF, Lost of AIS sleeping target will delete without using confirmation operation.

Refer to 4.2 AIS "AIS alarm [Sleeping lost]".

Set AIS ID DISP TYPE

ID can be displayed with AIS target.

Set items: NUMBER, NAME, MMSI, IMO and CALLSIGN

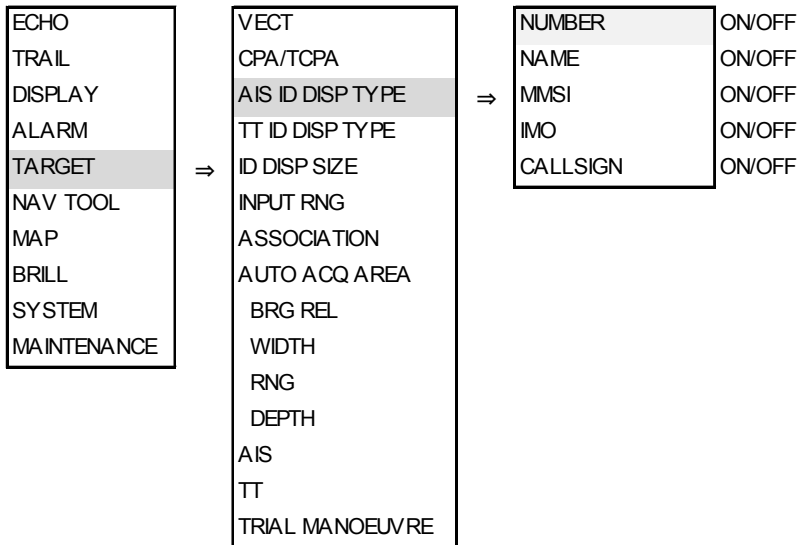

Set TT ID DISP TYPE

ID can be displayed with TT (ARPA) target.

Set items: NUMBER and LABEL

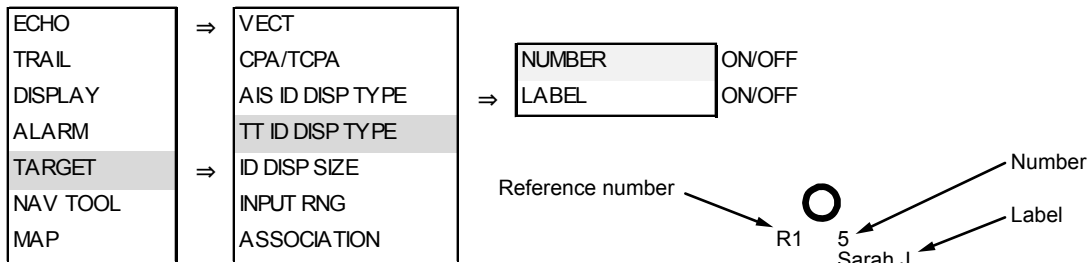

Refer to 4.3 TT (ARPA) "Reference target acquisition" about reference number.

Set ID DISP SIZE

This menu is used to specify display ID size.

Selection values: X-SMALL, SMALL, MEDIUM, LARGE

Set Input range

This is to set up the operation range of TT (ARPA) and AIS.

It designates the entire operation range of TT (ARPA) and AIS. So, TT (ARPA) and AIS do not function outside of the range.

- 1** Press **MENU** key to display "Menu".
Select **[TARGET] => [INPUT RNG]**, and press **ENT** key after selecting the setup value.
Selection values: 1.0NM to 64.0NM

ASSOCIATION

When an AIS target and a tracked target of TT (ARPA) are the same target, it is automatically associated to a single target.

Select priority of the association with either AIS or TT (ARPA).

If the low-speed ship is associated and displayed with TT priority, then HDG may be unstable. So, the display with AIS priority is recommendable.

1 Press **[MENU]** key to display "Menu".

Select **[TARGET]** => **[ASSOCIATION]** => **[ASSOCIATION]**, and press **[ENT]** key after selecting the setup value.

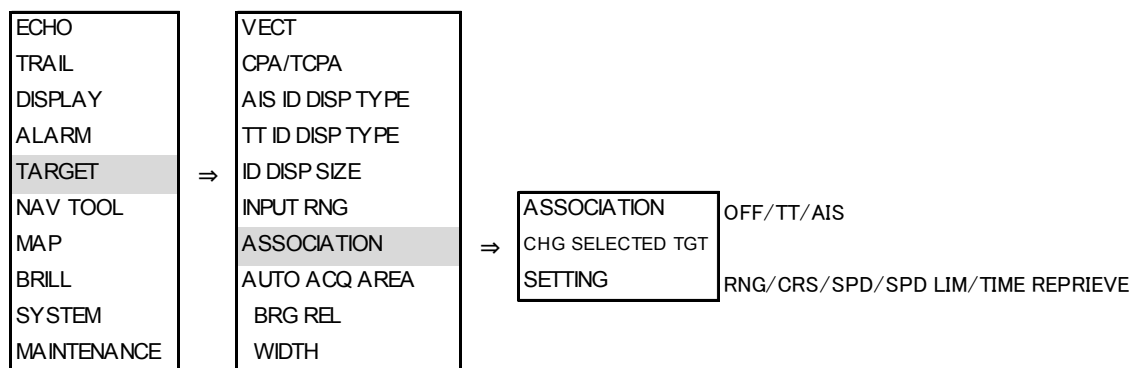

OFF: Association is turned off.

TT: Symbols of both TT (ARPA) and AIS are associated to TT (ARPA). However when the target of AIS is sleeping target it is not associated.

AIS: Symbols of both TT (ARPA) and AIS are associated to AIS. However when the target of AIS is sleeping target it is not associated.

[ASSOCIATION] can be changed directly at the upper right of the display, with trackball and **[ENT]** key, without using menu function.

In addition, **[CHG SELECTED TGT]** and **[SETTING]** are provided.

[ASSOCIATION] changes priority of the association of all targets while **[CHG SELECTED TGT]** changes priority of the association for selected target only.

[SETTING] designates conditional items of association among RNG, CRS, SPD, SPD LIM and TIME REPRIEVE.

RNG: It designates the range to determine association. (0.001NM to 1.000NM)

CRS: It designates the course to determine association. (10.0° to 60.0°)

SPD: It designates the speed difference to determine association. (1.0kn to 20.0kn)

SPD LIM: It designates the minimum speed to determine association. (1.0kn to 10.0kn)

TIME REPRIEVE: It designates the time to determine association. (1sec to 99sec)

Automatic acquisition area

AUTO ACQ AREA is function that is used for automatic acquisition of TT or AIS targets that enter area designated in a fan type range.

TT: When an un-tracked target enters, it is automatically acquired and an alarm sounds.*¹

When a tracked target enters, no alarm sounds.

AIS: When a sleeping target enters, it is changed to an active target (activated) and an alarm sounds.*²

When an active target enters, no alarm sounds.

It takes at least 20 seconds before target is acquired by TT (ARPA).

Take note that the target may not be acquired when the setting area is too narrow or target is moving at high speed.

*1: Press **MENU** key to display "Menu".

Select [ALARM] => [ALARM ON/OFF] => [TT] => [AUTO ACQ] => select [ON] or [OFF], and press **ENT** key.

Select [OFF], alarm sound will be disappeared.

*2: Press **MENU** key to display "Menu".

Select [ALARM] => [ALARM ON/OFF] => [AIS] => [AUTO ACQ] => select [ON] or [OFF], and press **ENT** key.

Select [OFF], alarm sound will be disappeared.

1 Press **MENU** key to display "Menu".

Select [TARGET] => [AUTO ACQ AREA] => [ON], and press **ENT** key.

The color of **EBL1**, **EBL2**, **VRM1** and **VRM2** key's light turn red.

2 Setup area. (Method using the cursor)

The items to be selected are [BRG REL], [WIDTH], [RNG], and [DEPTH]

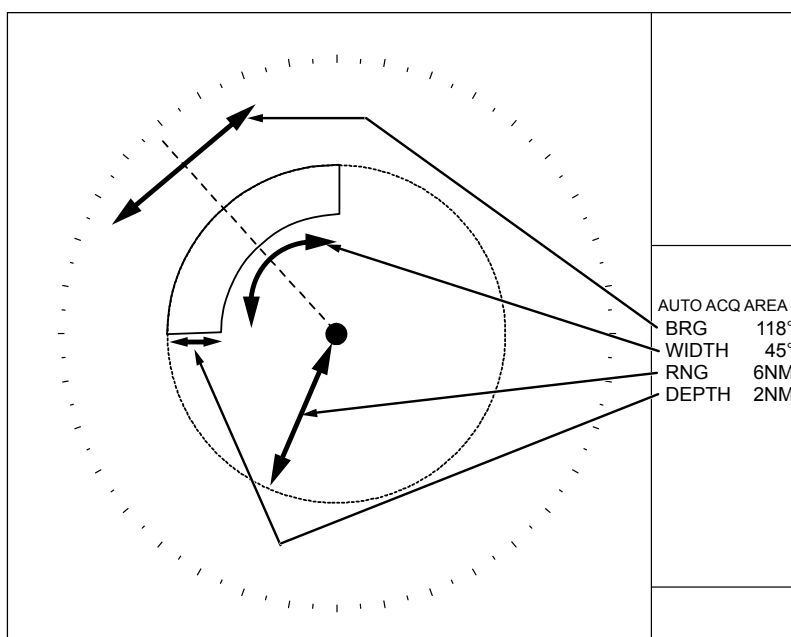

VRM knob and **EBL** knob are used for setup.

3 Press **EBL1** or **EBL2** key, and select an item to be set between [BRG REL] and [WIDTH] by using **EBL** knob.

In the same way, press **VRM1** or **VRM2** key, and select an item to be set between [RNG] and [DEPTH] by using **VRM** knob.

The selected item is shown with a ► symbol at the left of numerical indication at the auto acquisition area in the menu display.

4 When the setting of the automatic acquisition area is completed, then press **ENT** key, AUTO ACQ AREA will be activated.

Note: If AUTO ACQ AREA is set in the whole circumference, [WIDTH] needs to be set the 0.0° or 360.0°.

PAST POSN: Past position

The past position of TT (target tracking) and AIS (activated target) can be displayed.

1 Move the cursor to set value window of [PAST POSN] upper right part of the display.

Press **ENT** key to select [T] or [R].

Note: [TRUE/REL] is in common with [TRAIL] (Refer to 2.19 Target trail). So, if you change one part, the other part will change accordingly.

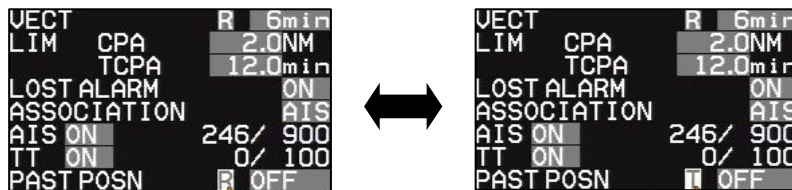

2 [PAST POSN TIME] item designates recording length.

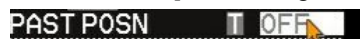

Setting value: OFF, 30sec, 1min, 3min, 6min, 12min, 30min, 60min

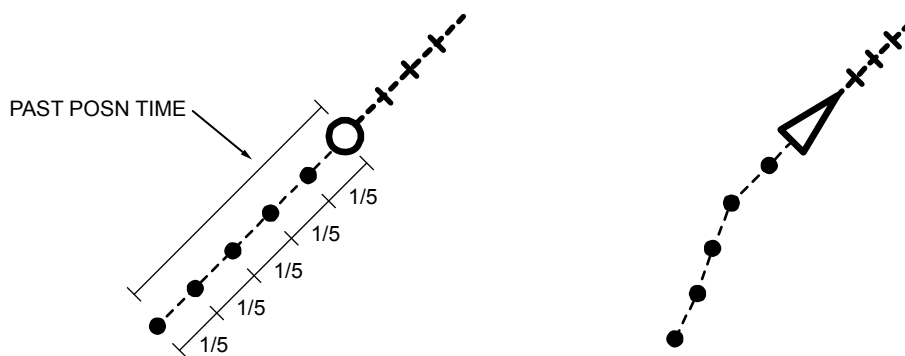

Up to five record points are available.

Note: The past position by its nature records and displays past positions. Immediate display is impossible after the start of TT (ARPA) and after the change from AIS sleep target to active target. In addition, when [TIME] is changed, a past position record is reset (erased). So, immediate display is impossible.

In above case, TT or AIS target number characters in [TGT INFO] message at right of the display change to yellow. When "PAST POSN" setting time has passed, character color turns white.

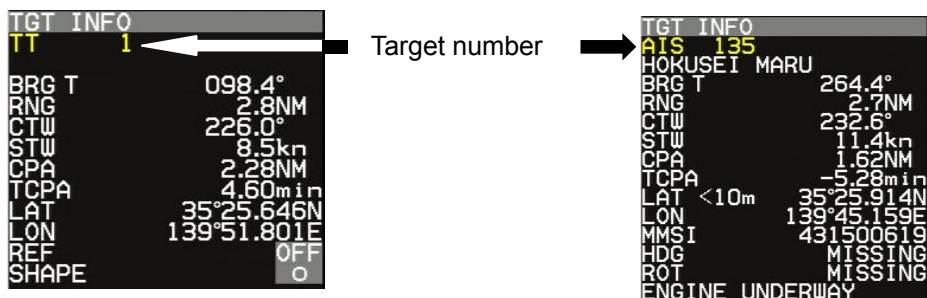

4.2 AIS

- The AIS communicates with other ships via VHF (Very High Frequency) radio by transmitting your ship information and by receiving other ships information.
- Only AIS data with WGS84 datum is accepted.
If AIS data has no datum or if datum is other than WGS84, then the warning of [AIS datum is not WGS84] appears. AIS data is not displayed.
- Capable of displaying up to 900 other ship symbols/IDs.
- If the displayed targets exceed 855, then caution is displayed at the lower right of the display.
AIS target count number at the upper right of the display changes to yellow.
- If the displayed targets exceed 900, then warning is displayed at the lower right of the display.
AIS target count number at upper right of the display changes to red.
In that case, change [TARGET] => [INPUT RNG] value and decrease the displayed targets.

Note:

- If the displayed targets exceed 900, then next coming AIS data cannot be displayed. For the sake of safety, if warning is displayed, then change [INPUT RNG] value immediately and decrease the displayed targets.
- If the own ship information display at upper right of the display is turned orange, then it means that the input sentence is incomplete. So, this function does not work.

If AIS is used in combination with [ASSISTANT DISP], then AIS is effective.

Enable AIS function

There are two methods to enable this function. One is [ON/OFF] using menu. The other is [ON/OFF] of [AIS] at the upper right of the display using cursor.

- 1 Press **MENU** key to display "Menu".
Select [TARGET] => [AIS] => [AIS] => [ON], and press **ENT** key.

Select ID

This is to change the target selected by using [ACTIVE/SLEEP].

- 1 Press **MENU** key to display "Menu".
Select [TARGET] => [AIS] => [SELECT ID], and press **ENT** key after selecting the setup value.
Selection values: 101 to 1000

ACTIVE/SLEEP

This is to change ACTIVE/SLEEP of the target selected by [SELECT ID] function.

The change of ACTIVE/SLEEP can be executed also by using trackball, moving a cursor to the desired target, then press **ENT** key.

Ship outline

Ship outline function is displayed only when OUTLINE is included in the target information received by AIS.

Ship outline is not displayed if it is less than 3 mm in size of the display, and it is not displayed when own ship outline is OFF.

(Refer to 4.2 AIS "Types of AIS target symbol")

(Refer to [NAV TOOL] => [SHIP OUTLINE] => [SHIP OUTLINE] and [OS PROFILE])

- 1 Press **MENU** key to display "Menu".
Select [TARGET] => [AIS] => [SHIP OUTLINE] => [ON], and press **ENT** key.
Selection values: OFF, ON

HDG line

This is displayed only when HDG LINE is included in the target information received by AIS.

(Refer to 4.2 AIS "Types of AIS target symbol")

- 1 Press **MENU** key to display "Menu".
Select [TARGET] => [AIS] => [HDG LINE] => [ON], and press **ENT** key.
Selection values: OFF, ON

Turn indicator

This is displayed only when HDG LINE is included in the target information received by AIS.

(Refer to 4.2 AIS “Types of AIS target symbol”)

- 1 Press **MENU** key to display “Menu”.
Select [TARGET] => [AIS] => [TURN INDICATOR] => [ON], and press **ENT** key.
Selection values: OFF, ON

OS display

This is to turn own ship AIS symbol ON or OFF.

- 1 Press **MENU** key to display “Menu”.
Select [TARGET] => [AIS] => [OS DISP] => [ON], and press **ENT** key.
Selection values: OFF, ON

OS MMSI

This menu is where user can enter MMSI number of own ship.

MMSI number is necessary to be able to receive message for own ship.

- 1 Press **MENU** key to display “Menu”.
Select [TARGET] => [AIS] => [OS MMSI] => set numbers, and press **ENT** key.
Selection values: 0 to 1073741824

Message display

This is to set up displayed speed when message is included in AIS information.

Message is displayed at “AIS INFO” of ASSISTANT DISP.

- 1 Press **MENU** key to display “Menu”.
Select [TARGET] => [AIS] => [MESSAGE DISP], and press **ENT** key after selecting the setup value.
Selection values: OFF, SLOW, MEDIUM, FAST

AIS filter

When there are many AIS targets, the display may become unclear. In that case, by setting AIS FILTER, it is possible to hide unnecessary sleeping targets or to display the necessary targets only, and the clear view of the target can be achieved.

Note: The filter is absolutely used to limit display. When input is to be limited, [INPUT RNG] shall be operated.

- 1 Press **MENU** key to display "Menu".
 Select [TARGET] => [AIS] => [AIS FILTER], and press **ENT** key after selecting the setup value.
 Selection values:

- A** CLASS A: OFF, ON
- B** CLASS B: OFF, ON
- RNG: 0.0 to 64.0NM
- △** SPD: 0.0 to 100.0kn
- !** CPA/TCPA: OFF, ON
- ◇** MOORED: OFF, ON
- ⚓** AT ANCHOR: OFF, ON
- ⚓** AGROUND: OFF, ON
- *** NUC: OFF, ON
- GUARD ZONE: OFF, ON
- ECHO ALARM: OFF, ON

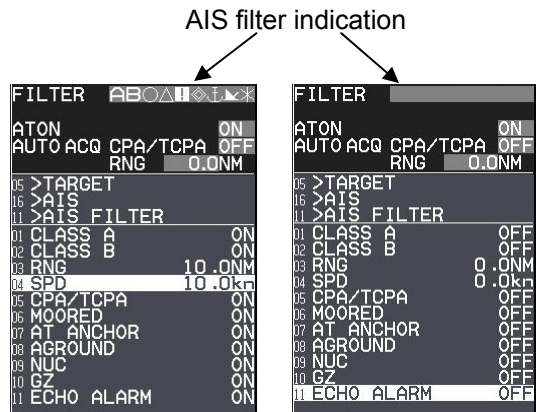

Exclude from RNG filter.
 Exclude from RNG filter.

AIS alarm [Sleeping lost]

When sleeping target disappears, AIS alarm will come on.

- 1 Press **MENU** key to display "Menu".
 Select [TARGET] => [AIS] => [AIS ALARM] => [SLEEPING LOST] => [ON], and press **ENT** key.
 Selection values: OFF, ON

AIS auto ACQ

When sleeping target enters the "AUTO ACQ AREA" or "AIS AUTO ACQ", sleeping targets is changed to active target.

"AUTO ACQ AREA" is applied to both "AIS" and "TT (ARPA)". (Refer to 4.1 Common setting "Automatic acquisition area".)

The range of "AIS AUTO ACQ" sets up in the "Target status" area at right side on the display.

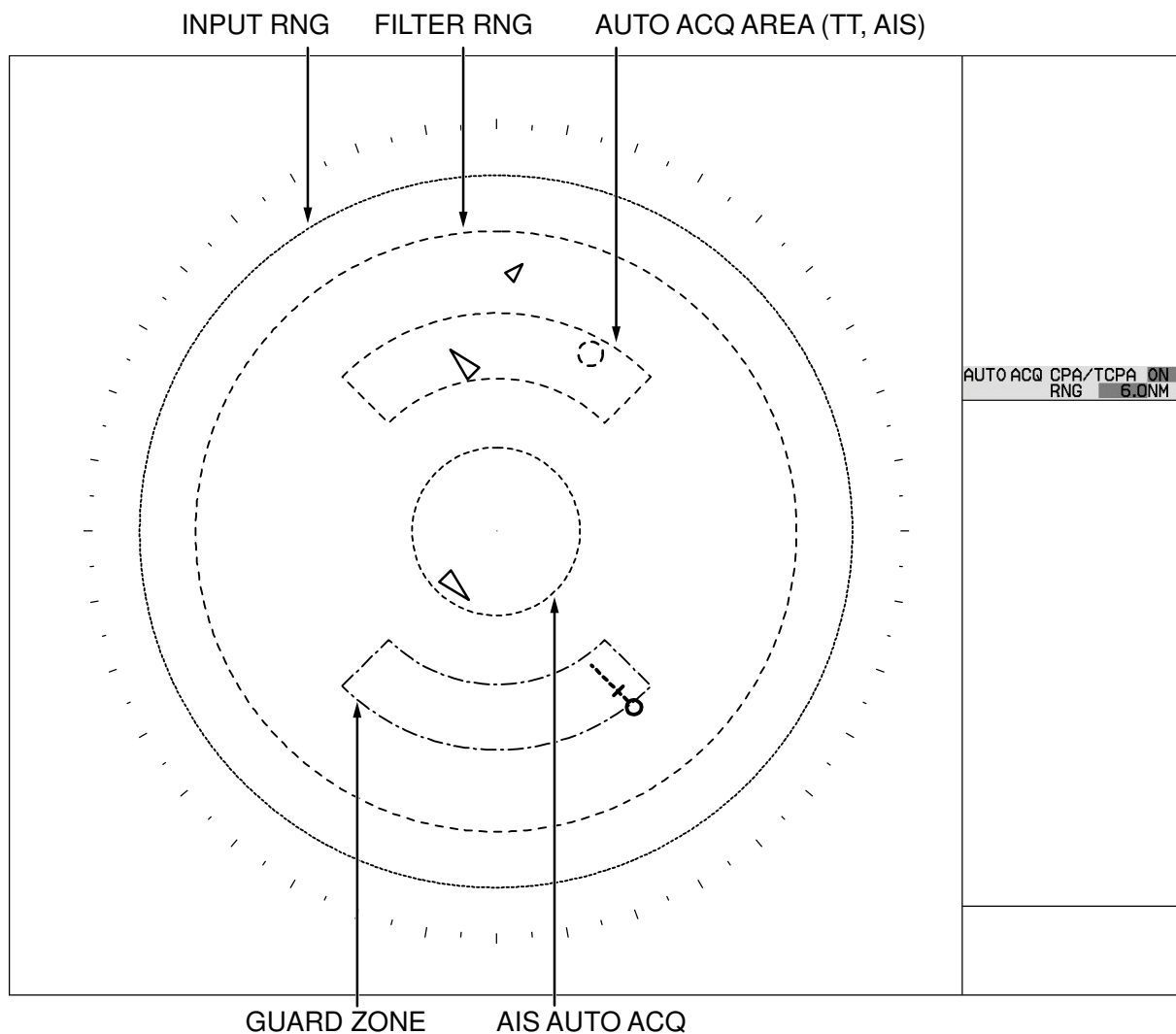





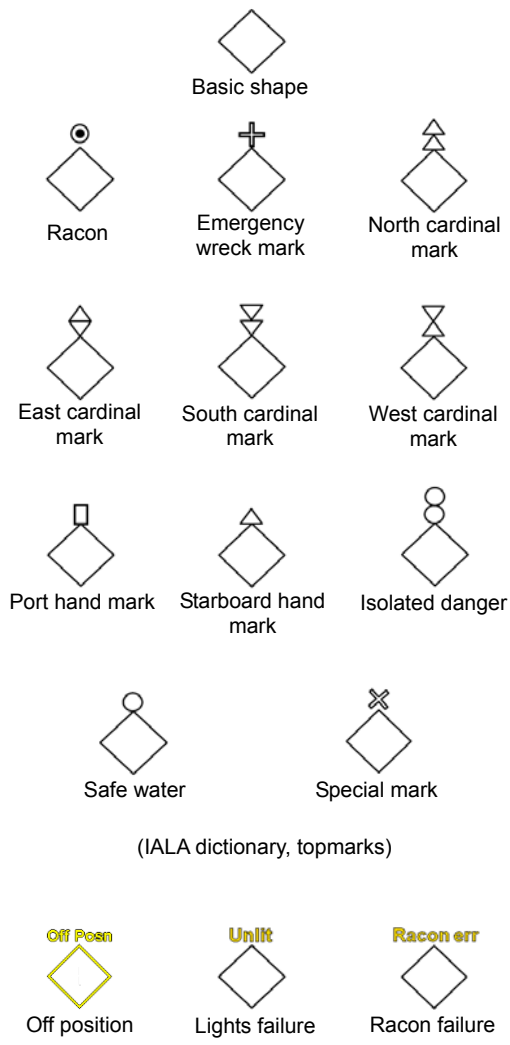
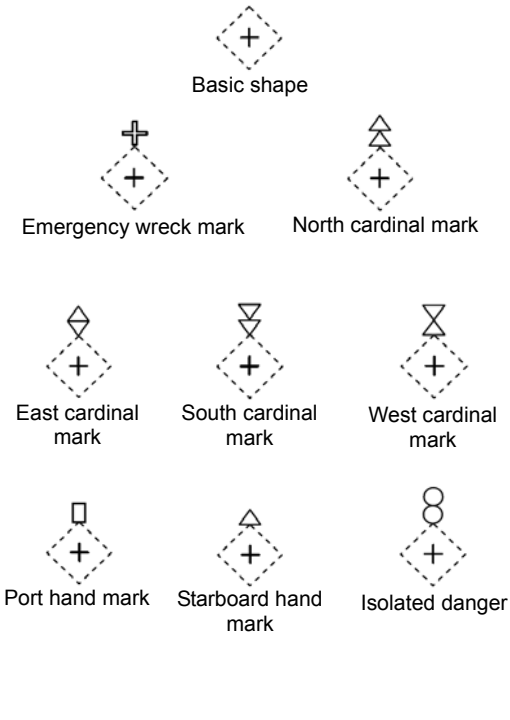

Types of AIS target symbol

The following symbols are overlapped on target.

Symbol	Symbol name
	Sleeping target
	Sleeping target without HDG.
	Sleeping target with neither reported HDG nor COG.
*	Activated target
*	Activated target without HDG.
*	Activated target with neither reported HDG nor COG.
*	Activated target - true scaled outlines
*	Activated target - dangerous targets
*	Activated target without HDG.
*	Activated target with neither reported HDG nor COG.
*	Activated target with heading lines
*	Activated target with turn indicators

 <p>Basic shape</p> <p>Racon</p> <p>Emergency wreck mark</p> <p>North cardinal mark</p> <p>East cardinal mark</p> <p>South cardinal mark</p> <p>West cardinal mark</p> <p>Port hand mark</p> <p>Starboard hand mark</p> <p>Isolated danger</p> <p>Safe water</p> <p>Special mark</p> <p>(IALA dictionary, topmarks)</p> <p>Off position</p> <p>Lights failure</p> <p>Racon failure</p>	<p>Physical AIS AtoN</p>
 <p>Basic shape</p> <p>Emergency wreck mark</p> <p>North cardinal mark</p> <p>East cardinal mark</p> <p>South cardinal mark</p> <p>West cardinal mark</p> <p>Port hand mark</p> <p>Starboard hand mark</p> <p>Isolated danger</p>	<p>Virtual AIS AtoN</p>

 <p>Safe water</p>  <p>Special mark</p> <p>(IALA dictionary, topmarks)</p>  <p>Missing</p> <p>Intended location of missing ATON</p>	
	<p>AIS –SART (AIS Search and Rescue Transponder)</p>
	<p>BASE</p>
	<p>AIS SAR aircraft</p>
	<p>AIS SAR vessel</p>

* ID can be displayed with Activated target.

4.3 TT (ARPA)

It is an effective mean for collision avoidance by generating vectors on tracked targets.

It is an effective means for collision avoidance to set up CPA/TCPA.

If AIS information is available with tracked targets, association increases tracking accuracy.

Limitations of the TT function

There are the following limitations on use of the target acquisition and tracked target of TT (ARPA) functions.

Note:

- If multiple targets approach each other, this may cause the system to regard them as one target and thus to swap them or loss part of them. Such swapping or loss of targets may also occur if the picture of the target being tracked is affected by rain/snow clutter returns or sea clutter returns or moves very close to land.
- Intensity of echoes and the TT function have a correlation ship, and thus the target will be lost if no echoes and detected during six scans in succession. If a lost target exists, therefore, radar gain must be increased to support detection of the target. If radar gain is increased too significantly, sea clutter returns or other noise may be erroneously detected and tracked as a target, and resultingly, a false alarm may be issued.
- To execute accurate tracking, it becomes necessary first to appropriately adjust the **GAIN**, **SEA** and **RAIN** knobs of the radar so that the target to be acquired and tracked id clearly displayed on the radar display. Inappropriate settings of these adjustments reduce the reliability / accuracy of automatic tracking.

Enable TT function

There are two methods to enable TT function.

By menu

- 1 Press **[MENU]** key to display "Menu".
Select **[TARGET]** => **[TT]** => **[TT]** => **[ON]**, and press **[ENT]** key.

By trackball

- 1 Move cursor on the TT **[OFF]** in the upper right of the display, then press **[ENT]** key.

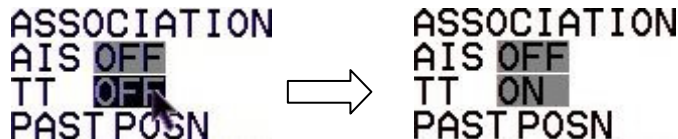

Note:

- Pressing **[ACQ]** key in **[OFF]** state automatically turns to **[ON]** state.
- TT function does not work due to incompleteness of input sentence when own ship information display in upper right of the display is turned orange.
- TT (ARPA) is effective by using TT in combination with **[ASSISTANT DISP]**.

Manual acquisition

- 1 Move cursor to a target to be acquired, then press **[ACQ]** key.

A broken circle symbol is displayed at the cursor location, and acquisition starts.

About 30sec. from 1min. later, a broken circle symbol turn into a thick solid line, displayed vector of target's motion trend and TT ID number (if selected), and displayed within 3min. the target's prediction motion.

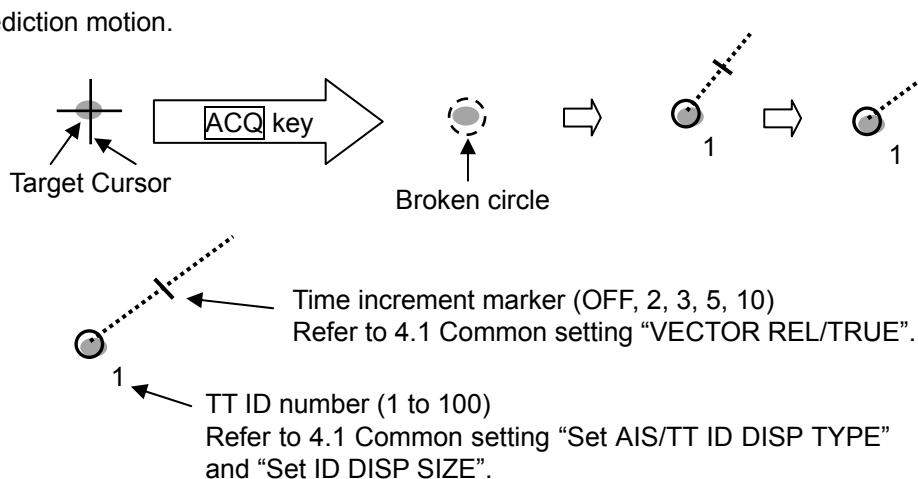

Delete TT target

There are two methods to delete TT target. First method is to use menu operation, second is to use cursor operation.

Menu operation

This is to delete the TT target selected [SELECT ID] and [DELETE] function.

- 1 Press **MENU** key to display "Menu".
Select [TARGET] => [TT] => [SELECT ID] => select ID number, and press **ENT** key.
Selection values: 1 to 100
- 2 Select [DELETE], and press **ENT** key.

Cursor operation

- 1 Move cursor to a TT (ARPA) target to be deleted, keep **OFF** key pressed, and then press **ACQ** key.

Delete all TT targets

- 1 Press **MENU** key to display "Menu".
Select [TARGET] => [ALL DELETE], and press **ENT** key.
All TT targets acquisitions are deleted.

Reference target acquisition

If SDME or EPFS is not usable due to malfunction or other reason, then COG/SOG can be obtained by setting Reference target.

By tracking 1 or 2 stationary targets, the true speed course can be used.

This stationary tracked target is called [Reference target].

A letter "R" denoting reference and number are attached to the lower left of Reference target symbol.

Note:

- Reference target can be used only when COG/SOG is not available.
- HDG input is necessary to use a reference target.
- Reference target has considerable error factor caused by target size, backlash and distance. Accordingly, if COG/SOG is obtained from the reference target, then its accuracy is generally not good. It is probable to mistake a moving target for a reference target. Therefore, if a reference target is used, then CPA/TCPA of TT (ARPA), relative vector and relative speed are prohibited by IEC 62388. For this reason, if a reference target is used, its speed and vector should be only informative.
- Pay attention to that, if a reference target is lost, then accuracy of the true speed/the true course is significantly reduced.
- Select a stationary target as a reference target to calculate own ship speed as ground tracking speed. Do not choose a moving target as a reference target. A moving produces target error in the vector for TT and AIS, which results in wrong collision avoidance information. Further, an unstable stationary target produces inaccurate speed data and the target itself may become lost.
- The combined use with AIS function cannot be performed.
- When a reference target is lost, that reference target mark blinks and the indication "Ref tracked target is lost" appears in the alarm display area.
- If the target is lost for 20 seconds, then reference target function is considered a lost target. If a lost target happens, then the numerical indication of COG/SOG becomes XXXX in orange color. Then stabilization mode automatically changes from ground stabilization to water stabilization.
- Loss of reference target will affect the calculation of true speed and true course of targets. Further, own ship speed will be inaccurate.

By using menu







- 1** Move cursor using trackball to the stationary target to be acquired.
- 2** Press **MENU** key to display "Menu".
Select [TARGET] => [TT] => [REF ACQ], and press **ENT** key.
- 3** When reference target is tracked, [GYRO] characters in the own ship information area at right side of the display change to yellow. Move cursor using trackball to the [GYRO] characters, then press **ENT** key. [GYRO] characters change to [REF] characters.
COG/SOG computed by the reference target can be used.

By without using menu

- 1** Move cursor using trackball to the stationary target to be acquired, then press **ACQ** key.
- 2** Move cursor to the acquired target, then press **ENT** key.
Acquired target information will be displayed in "TGT INFO" area at side of the display.
- 3** Move cursor to the **REF OFF** position in "TGT INFO" area at side of the display, and [OFF] characters change to reverse characters.
Press **ENT** key to set REF target from TT target.
[GYRO] characters in the own ship information area at right side of the display change to yellow.
Move cursor using trackball to the [GYRO] characters, then press **ENT** key. [GYRO] characters change to [REF] characters.
COG/SOG computed by the reference target can be used.

Types of tracked target symbol

The following symbols are overlaid on target.

Symbol	Symbol name
	Radar target in acquisition state
*  Blink in 0.5 sec. interval	Radar target in acquisition state - Automatic acquisition (Red color)
** 	Tracked radar target
** 	Tracked radar target (Displayed at indicating numerical value.)
**  Blink in 0.5 sec. interval	Tracked radar targets - dangerous target (Red color)
**  Blink in 0.5 sec. interval	Lost target (Red color)

* Pressing key to acknowledge changes of target symbol to normal color and stop blinking.

** ID can be displayed in Tracked target.

*** Alarm display and alarm sound disappear by pressing key to acknowledge, while color remains red until the target leaves outside of setting range or tracking is stopped.

**** The lost target display disappears automatically when key is pressed to acknowledge or when 10 seconds have passed.

TEST TGT

Two types of test are provided.

One is check of TT (ARPA) performance and the other is check of functions.

Note:

- For TEST TGT execution, input of own-ship position is required.
- Time input (ZDA, DTM) is not necessary, but without time input, an alarm will activate periodically.

• TT (ARPA) performance check

Confirm that the acquisition and track of target is possible, and that the accuracy of data is within the specification mentioned below.

Time of steady state minutes	CPA NM	TCPA minutes	True course Degrees (°)	True speed
1 min: trend	1.0	–	–	–
3 min: prediction	0.3	0.5	5	0.5 kn or 1 % (whichever is greater)

• Preparation

Display Range rings as follows.

By menu

- 1 Press **[MENU]** key to display "Menu".
Select **[NAV TOOL]** => **[RR]** => **[RR]** => **[ON]**, and press **[ENT]** key.

By trackball

- 1 Move cursor on the RR **[OFF]** display at upper left of the display, then press **[ENT]** key.

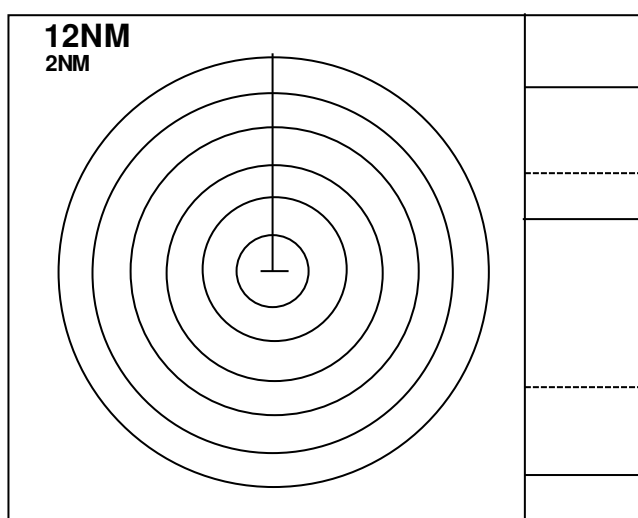

- 2 Set **[RAIN]** at a minimum level by turning **[RAIN]** knob and set **[SEA]** at a minimum level by turning **[SEA]** knob.
- 3 Set **[GAIN]** at a maximum level by turning **[GAIN]** knob.

TEST TGT ON

By turning TEST TGT [ON], a large character [X] is displayed at the lower middle of the display center. A small character [x] is displayed in Target position.

Turn on TEST TGT, and start transmission. Then, range scale changes to 12NM automatically, and a test target appears under the small character [x] position.

A test target appears near the direction 10° and range 12NM. After approaching to own ship, the target moves toward direction 207°.

Own ship's speed is about 42kn and the test target speed is about 32kn (Relative speed is 74kn).

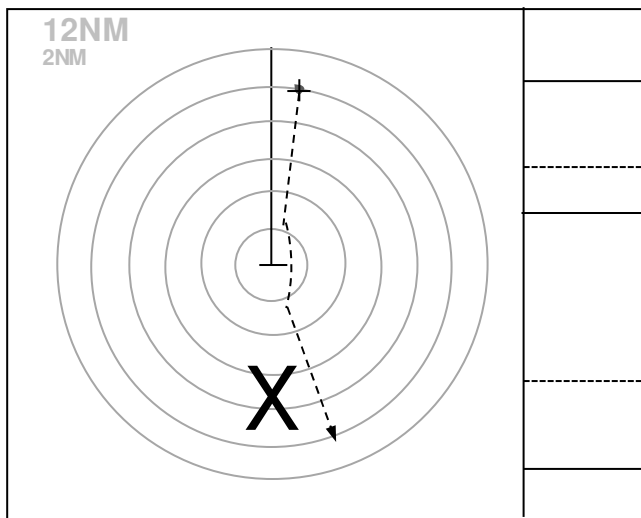

Turn ON TEST TGT.

- 1 Press **MENU** key to display "Menu".
 Select [TARGET] => [TT] => [TEST TGT] => [ON], and press **ENT** key.
 Range scale will change to 12NM automatically.
 During [TEST TGT] operation, range scale is fixed at 12 NM and cannot be changed.
- 2 Press **STBY / TX** key to start transmission.

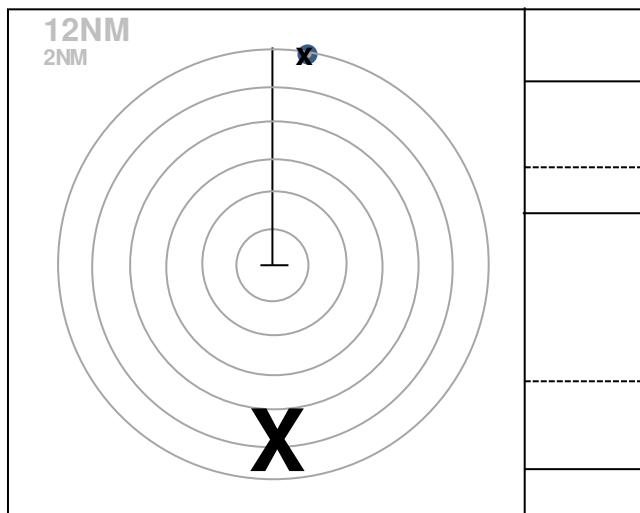

Start ACQ

- 1 After the center of the target reaches to 10NM (the second ring from outside), use a trackball, and move cursor to the target and press **ACQ** key.

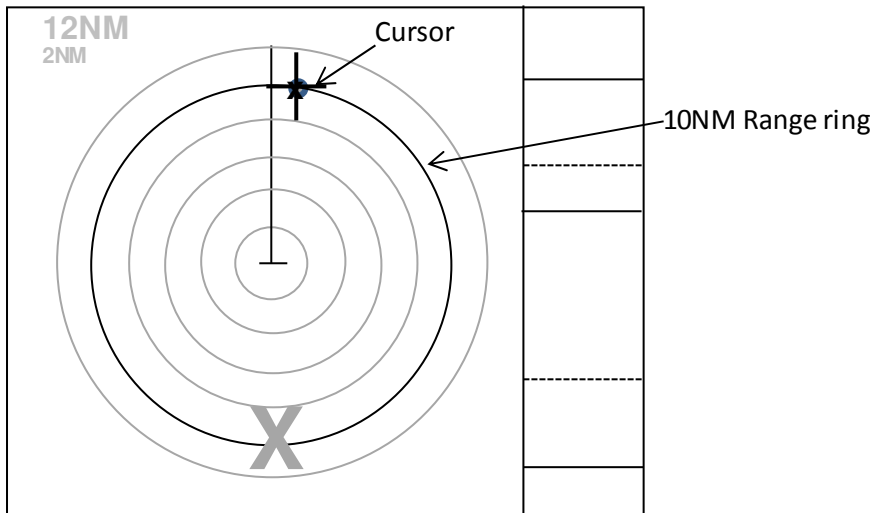

- 2 Confirm appearance of the dotted circle of acquisition start symbol and the parenthesis of value near it.
The values are indicated in "TGT INFO" area.

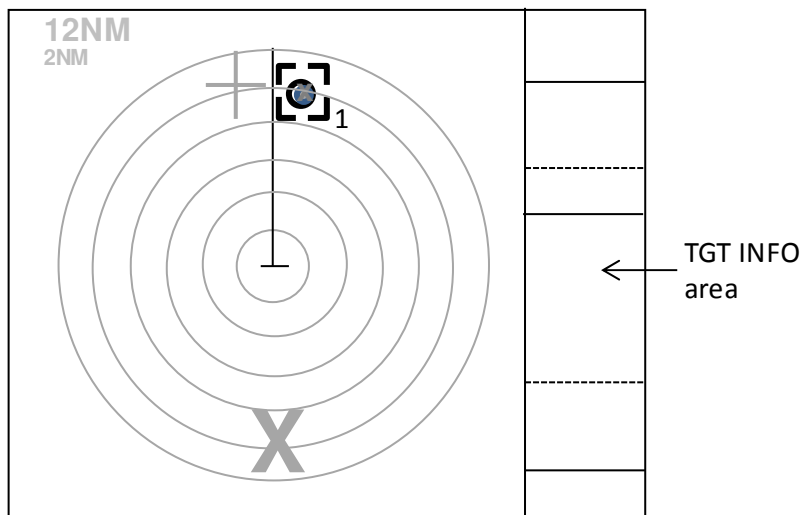

Note: If the parentheses are not displayed, then drag a cursor to the acquisition start symbol and press **ENT** key.

Compare it with the known result.

- Tracking starts 30 seconds after the start of acquisition
 Confirm that the target has the tracking symbol.
 Confirm that the symbol number is [1].

Note: If the number is not correct, then no comparison with the known result is made. Delete the symbol and start it over.

- Compare with the known result after 1 minute from acquisition start

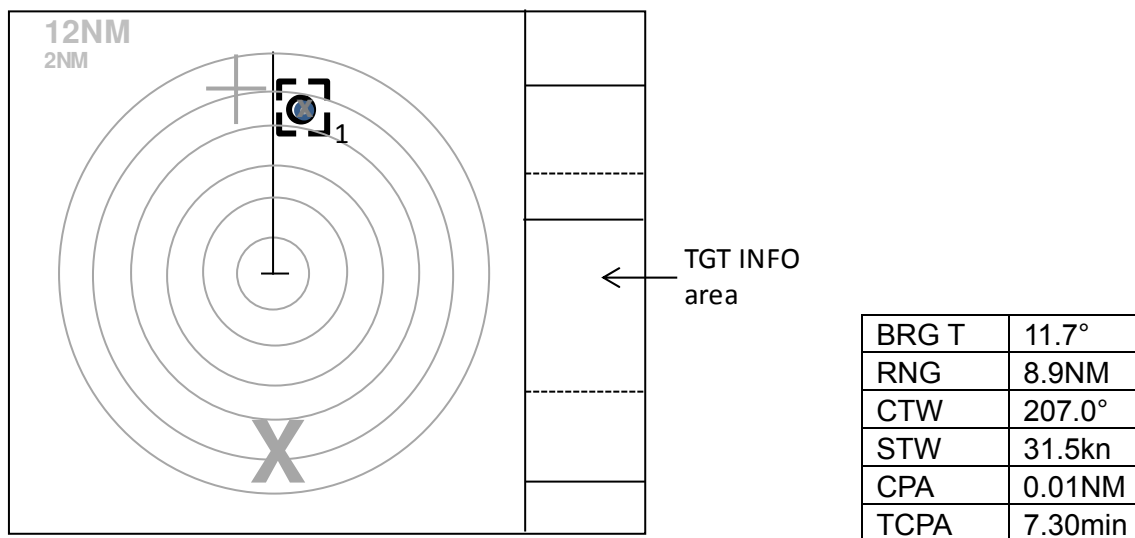

- Compare with the known result after 3 minutes from acquisition start.

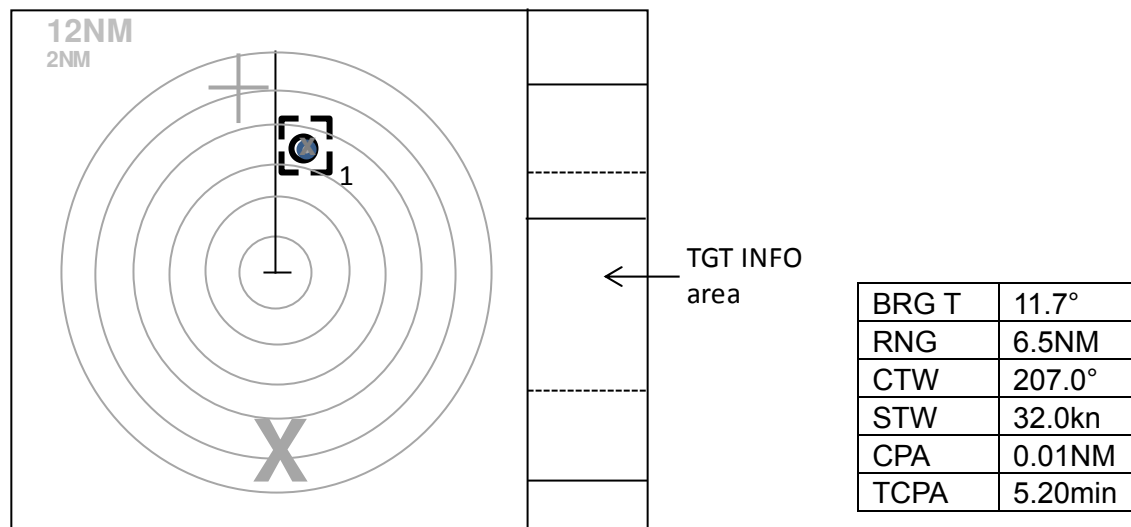

Note: If difference from the known result exceeds the limit, then the following warning is indicated in alarm display are at lower right of the display.

Tracking malfunction. BRG T	(Bearing accuracy is degraded)
Tracking malfunction. RNG	(Range accuracy is degraded)
Tracking malfunction. CPA	(CPA accuracy is degraded)
Tracking malfunction. TCPA	(TCPA accuracy is degraded)
Tracking malfunction. T CRS	(True course accuracy is degraded)
Tracking malfunction. T SPD	(True course accuracy is degraded)

TEST TGT OFF

1 Press **MENU** key to display "Menu".

Select [TARGET] => [TT] => [TEST TGT] => [OFF], and press **ENT** key.

Stop transmission and restore GAIN, RAIN, and SEA setting value of knobs to the original value.

• Function check

This function is used to confirm the operation of Echo alarm, Manual acquisition TT (ARPA), Auto acquisition, Past position and Guard zone.

• Preparation

- 1** Set up the range to 12 NM.
- 2** Turn **GAIN**, **RAIN** and **SEA** knobs and set these levels at a minimum.
- 3** Set up the echo alarm as follows:
Press **MENU** key to display "Menu".
Select **[ALARM]** => **[ECHO ALARM]** => **[IN]**, and press **ENT** key.
Set up the echo alarm range.
- 4** Set up the Guard zone.
Select **[ALARM]** => **[GUARD ZONE]** => **[EDIT]** => **[ON]**, and press **ENT** key.
Set up the range of Guard zone.
- 5** Set up the Auto acquisition.
Select **[TARGET]** => **[AUTO ACQ AREA]** => **[ON]**, and press **ENT** key.
Set up the range of Auto acquisition.

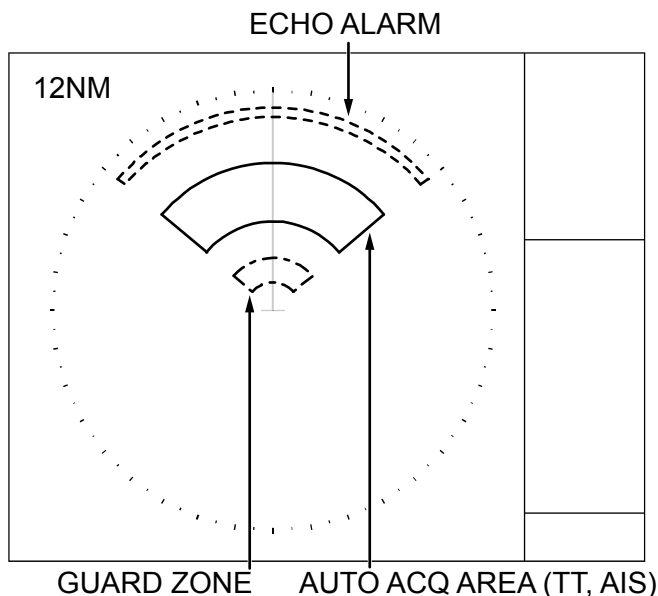

• TEST TGT ON

By turning TEST TGT [ON], a large character [X] is displayed at the lower middle of the display.

A small character [x] is displayed in Target position.

Turn on TEST TGT, press **[STBY / TX]** key, and start transmission. Then, a target appears.

A target appears near the direction 10° and range 12 NM. After approaching to own ship, the target moves toward direction 207°.

Own ship's speed is about 42 kn and the target speed is about 32 kn (Relative speed is 74 kn).

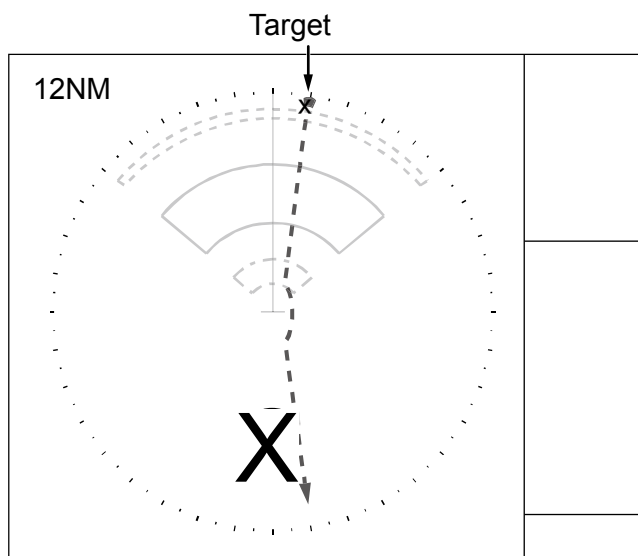

- 1 Press **[MENU]** key to display "Menu".
Select [TARGET] => [TT] => [TEST TGT] => [ON], and press **[ENT]** key.
Range is fixed at 12 NM and cannot be changed.
- 2 Press **[STBY / TX]** key to start transmission.

• Echo alarm

- 1 Confirm that when the target enters the echo alarm area, the echo alarm is displayed in alarm display area at the lower right of the display.

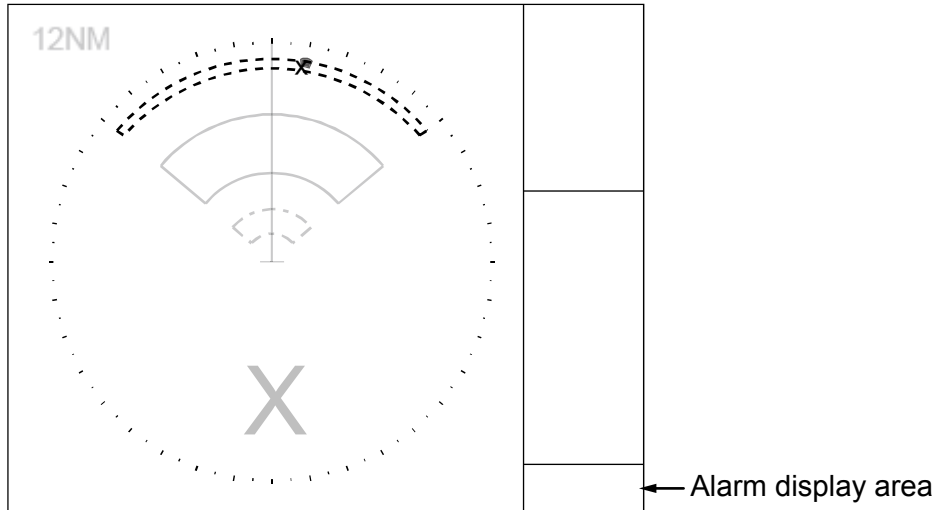

Press key to acknowledge. Then, alarm will disappear.

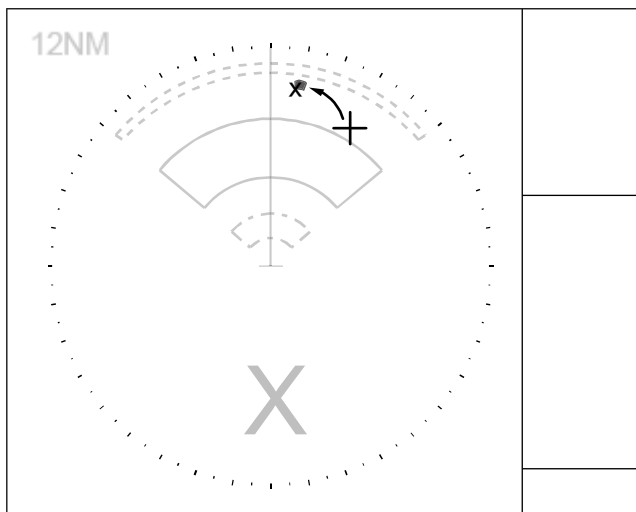

• **Manual acquisition TT (ARPA)**

- 1 Use a trackball to move cursor to the target and press **ACQ** key.



- 2 Symbol  will be displayed by acquisition. Information of symbol with  is displayed in the "TGT INFO" area. CPA/TCPA are displayed as [missing] until tracking is started.

Move the cursor on symbol and press **ENT** key, if  is not displayed yet.

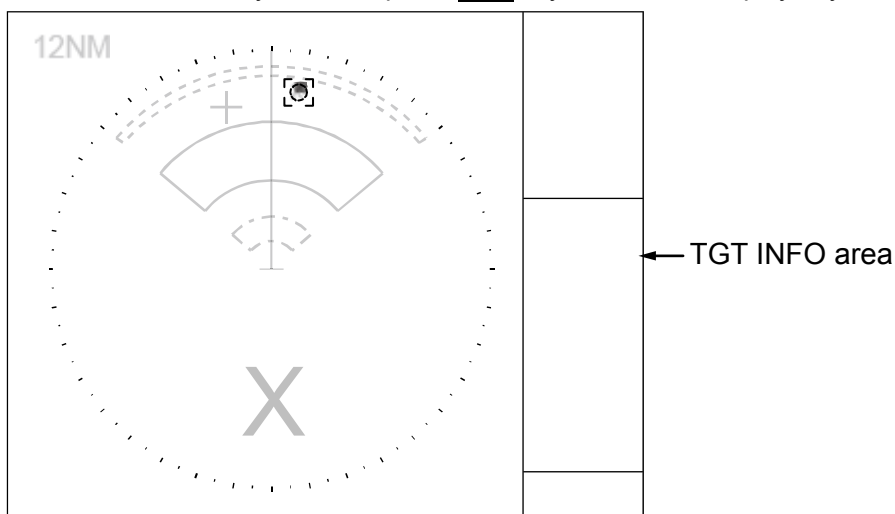

- 3 Confirm that data is changed from [missing] after the symbol is changed to tracked one.
- 4 Move the cursor again. Delete the tracked symbol by pressing **ACQ** key while keeping **OFF** key pressed.

• Auto acquisition

- 1 If a target enters the Auto acquisition area and 15 seconds pass, then automatic acquisition starts. Start of tracking is displayed in the alarm display area at lower right of the display. Acquired symbol is shown in blinking red until **OFF** key is pressed to acknowledge.

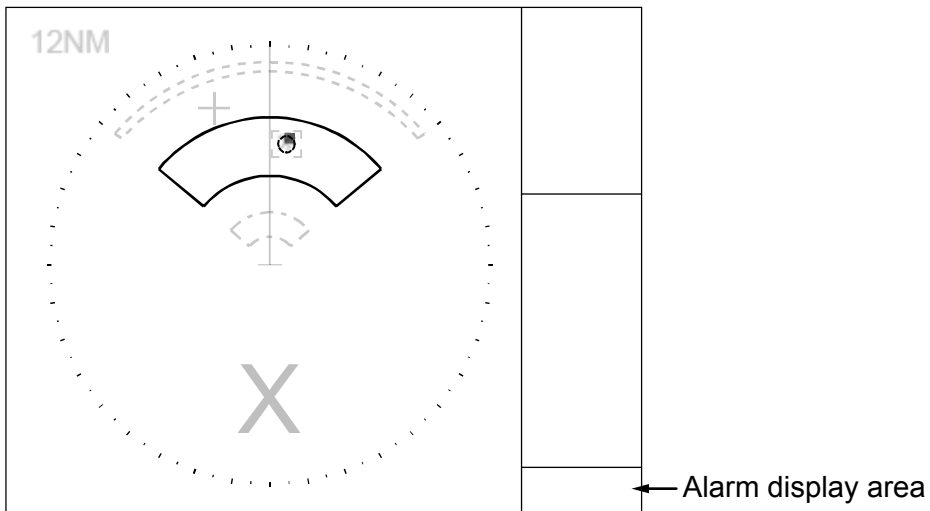

• Past position

- Trail of tracked symbol is displayed by setting past position time.

Set up the past position time in the "PAST POSN" at the right middle of the display.

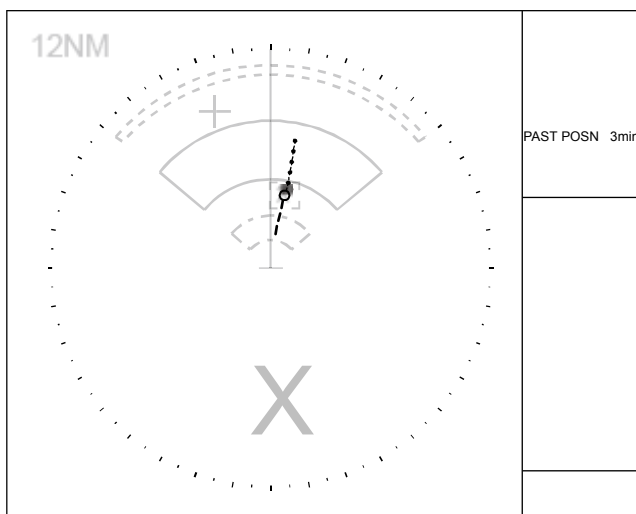

• Guard zone

- Confirm that the Guard zone alarm is displayed in the alarm display area at the lower right of the display when the tracked symbol has entered the Guard zone.

Blinking of tracked symbol will stop by pressing **[OFF]** key to acknowledge.

The tracked symbol remains red until it leaves from Guard zone.

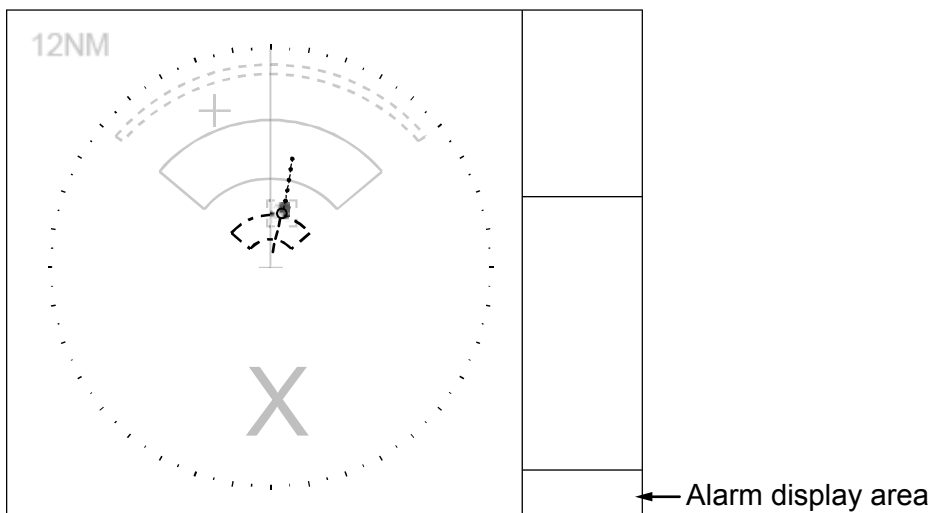

• TEST TGT OFF

Select [TARGET] => [TT] => [TEST TGT] => [OFF], and press **[ENT]** key.

Stop transmission and restore GAIN, RAIN, and SEA setting value to original knob position.

4.4 Trial manoeuvre

In case it is suspected the own ship could collide with tracked targets or activated AIS targets, this function provides such reference information as the actual anti-collision manoeuvre can be taken. This function is to display the simulation result in the form of graphic vector on the radar display, on the assumption that the own ship travels with the current course and speed.

- Assuming that the own ship and other ships (tracked targets and activated AIS targets) are both concurrently moving at the present course and speed [CRS·SPD] for the duration set at [DELAY], vector is displayed in such a way that the own ship is to move at the set [CRS T], [SPD], [RATE OF TURN] and [RATE OF SPD] from the starting point.

Note:

- Better information is provided by using relative motion and sea stabilization (water tracking).
- The function is terminated once the HDG input, SPD input, LAT/LON input (AIS only) are disrupted, as tracked targets and activated AIS targets are used.

1 Press **MENU** key to display "Menu".

Select [TARGET] => [TRIAL MANOEUVRE] => [GO], and press **ENT** key.

2 By turning TRIAL MANOEUVRE [GO], a large character [T] is displayed at the lower center of the display and the setting menu of TRIAL MANOEUVRE is displayed at the lower right of the display.

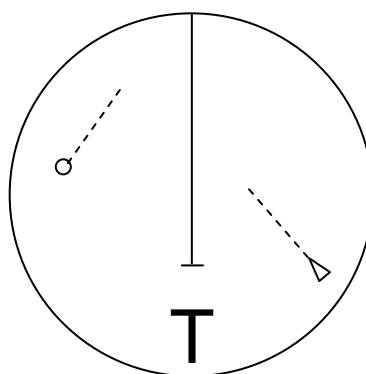
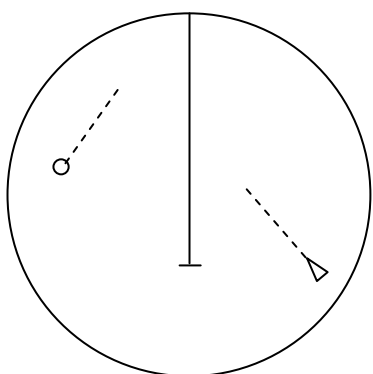

TRIAL MANOEUVRE
TRIAL
CRS T
SPD
DELAY
RATE OF TURN
RATE OF SPD

In addition, the movement of the own ship and the other ships is displayed in vector after elapse of the time set at [DELAY] of TRIAL MANOEUVRE setting menu.

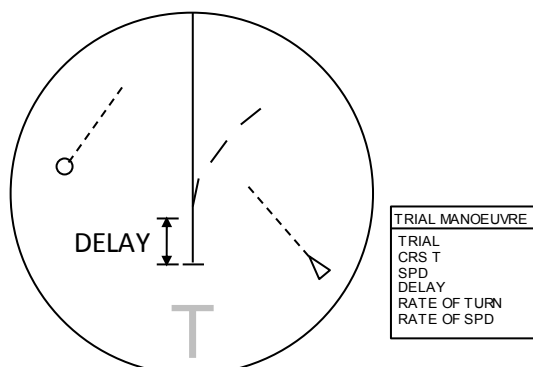

3 TRIAL MANOEUVRE setting menu

Each numerical value in the grey background color area is set by user. Move the cursor to the grey area, press **[ENT]** key, and a numerical value input dialogue box will appear. The value of the dialog box can be set by the trackball.

For [TRIAL OFF], moved the cursor **[OFF]** and press **[ENT]** key, TRIAL MANOEUVRE is finished immediately.

TRIAL MANOEUVRE	
TRIAL	OFF 296sec
CRS T	38.3°
SPD	6.6kn
DELAY	3.0min
RATE OF TURN	10.0°/min
RATE OF SPD	10.0kn/min

TRIAL: OFF

When the trial manoeuvre commences, count down starts from 300 seconds and ends at 0 second. When you decide to stop the function during the countdown, select the countdown display and set OFF.

CRS T: This indicates own ship's course after [DELAY].

SPD: This indicates own ship's speed after [DELAY].

DELAY: This indicates the starting time of TRIAL MANOEUVRE. After the time set, the own ship starts moving at [CRS T], [SPD], [RATE OF TURN], [RATE OF SPD].

RATE OF TURN: This indicates own ship's rate of turn after [DELAY].

RATE OF SPD: This indicates own ship's acceleration rate after [DELAY].

- 4 When setting is done for [CRS T], [SPD], [RATE OF TURN], [RATE OF SPD], own ship's vector will change when the vector setting is [VECT T] and the other ship's vector will change when vector setting is [VECT REL].

[TRUE VECTOR when own ship's speed is doubled]

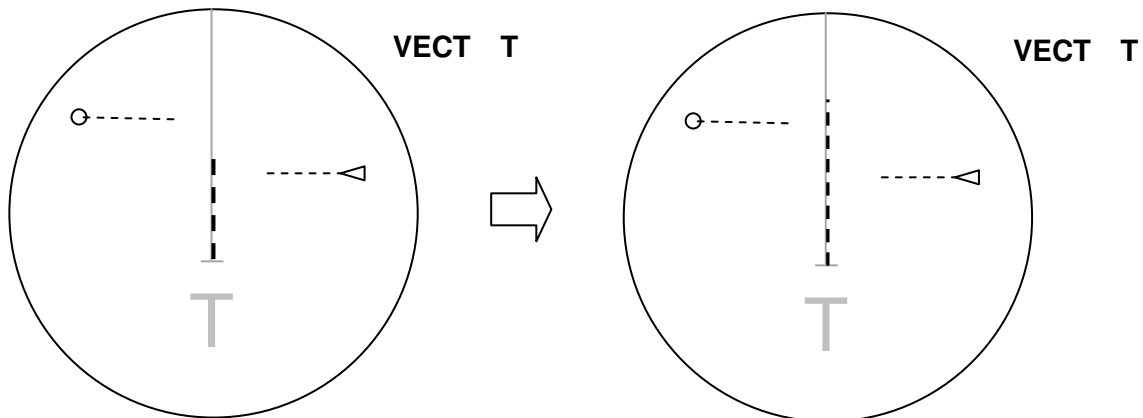

[RELATIVE VECTOR when own ship's speed is doubled]

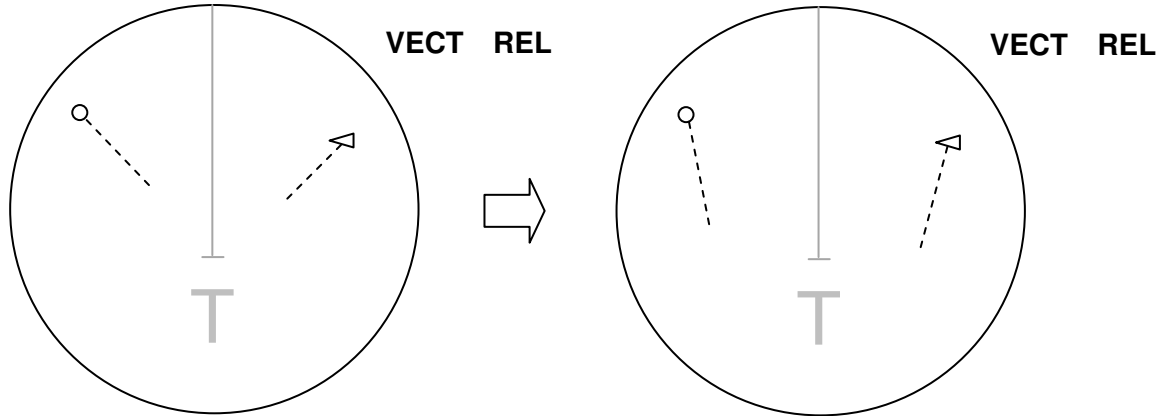

Chapter 5 Nav tool

5.1 Guard line

Guard line function is a function that displays parallel lines to the heading on both side of own ship.

Distance to guard line from own ship can be set from 0 to 10000m (left and right side independently).

- 1 Press **MENU** key to display "Menu".
Select [NAV TOOL] => [GUARD LINE] => [ON], and press **ENT** key.
- 2 Select [LEFT] => set left side distance 0 to 10000m, and press **ENT** key.
- 3 Select [RIGHT] => set right side distance 0 to 10000m, and press **ENT** key.

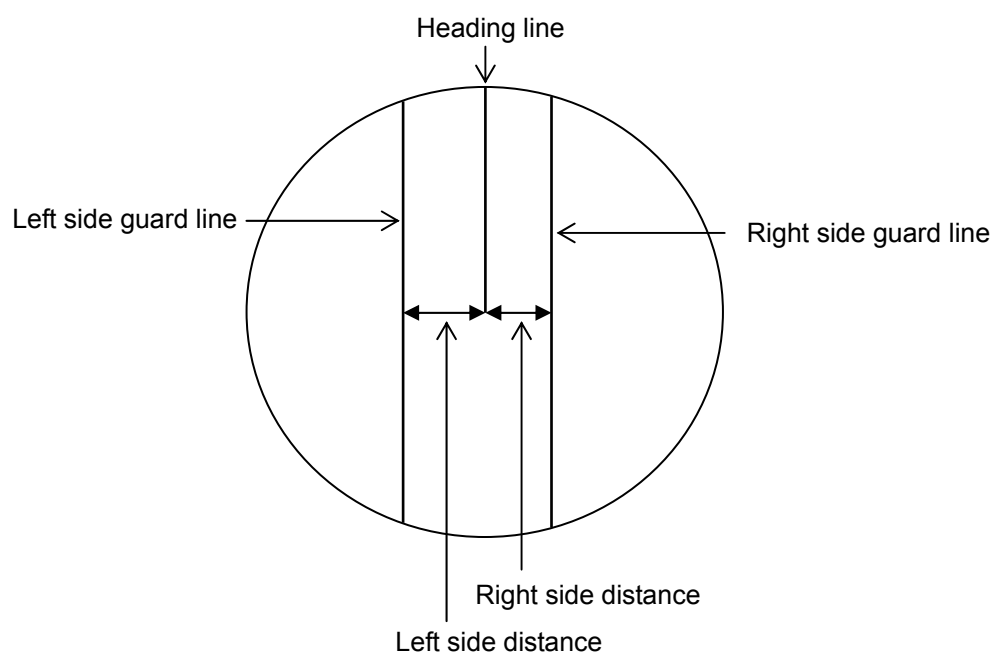

5.2 HL blink

HL BLINK function lets HL marker display blinks every antenna rotation. It is effective to confirm that there is no small targets right under the HL marker.

- 1 Press **MENU** key to display "Menu".
Select [NAV TOOL] => [HL BLINK] => [ON], and press **ENT** key.

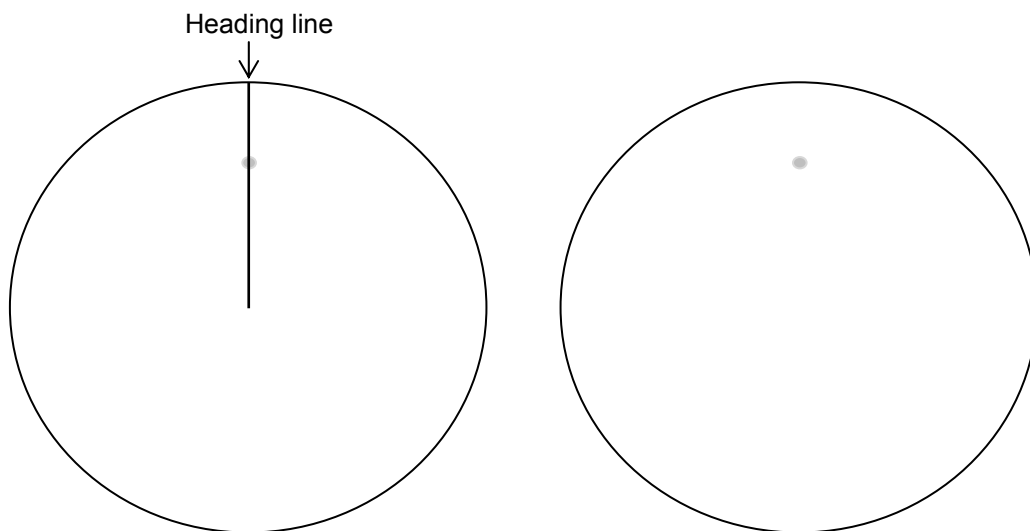

5.3 Stern line

STERN LINE is to set up the display of dotted line extended from reference position to bearing scale toward stern direction.

- 1 Press **MENU** key to display "Menu".
Select [NAV TOOL] => [STERN LINE] => [ON], and press **ENT** key.

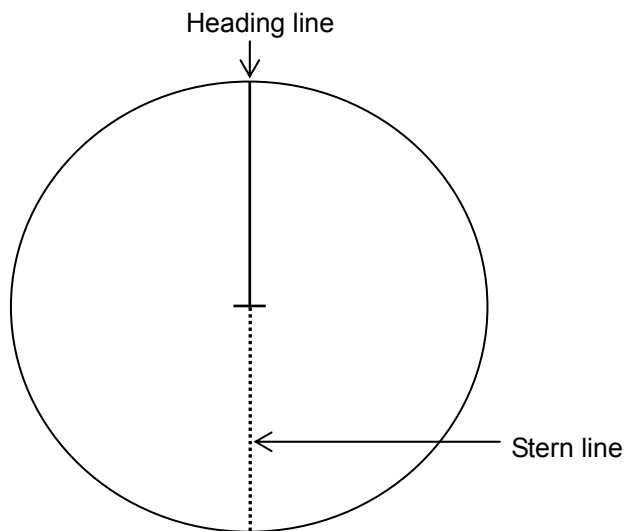

5.4 Barge icon

This radar is equipped with a barge icon feature that is very helpful for river operation where user can set up the size dimensions of the tow and be able to display it on the display.

- 1 Press **MENU** key to display "Menu".
Select [NAV TOOL] => [BARGE ICON] => [ON], and press **ENT** key.
- 2 Select and set [POSITION], [LENGTH], [WIDTH], [LINE NO.], [ROW NO.], [OFFSET]
 POSITION: FWD, AFT
 LENGTH: 0m to 511m
 WIDTH: 0m to 511m
 LINE NO.: 1 to 10
 ROW NO.: 1 to 10
 OFFSET: 0m to 511m

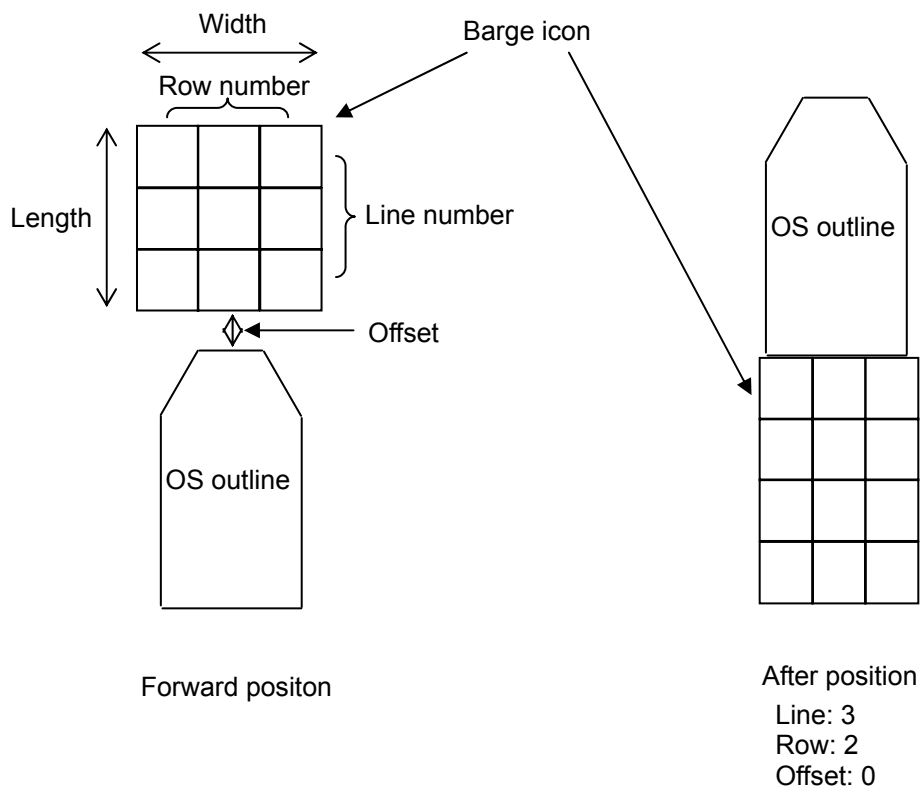

- This page intentionally left blank.-

Chapter 6 Map operation

6.1 MAP function display ON or OFF

This is to turn ON/OFF the entire MAP function.

Select the MAP ON or OFF box at the lower left corner of the display using trackball and press key. (To display CHART, select [MAP] => [CHART] => [ON].)

It is not displayed as well as HL while OFF key is pressed.

This operation links the functions, COAST LINE, NAV LINE, ROUTE, EVENT MKR and AREA. In case CHART is "ON", CHART display is linked to this operation.

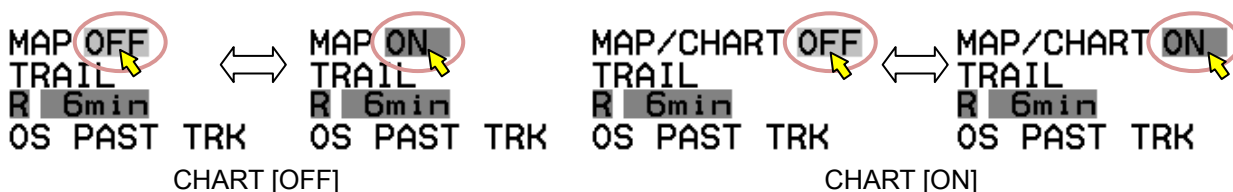

It is not displayed as well as HL while OFF key is pressed.

6.2 OWN SHIP PAST TRACK

This is to set up OWN SHIP PAST TRACK display, function on or off, clear operation, color setting, plot style, plot interval and maximum plot numbers.

- 1 Press key to display "Menu".

Select [MAP] => [OWN TRACK] => [ON] and press key.

[OS PAST TRK] message will appear at the lower left of the display, and displays past track line.

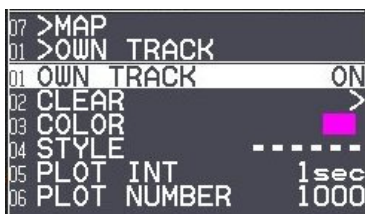

- 2 Select [COLOR] => select color from eight colors => press key.
PAST TRACK will turn selected color.
- 3 Select [STYLE] => select past track line style* => press key.

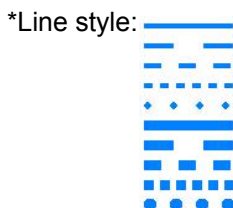

- 4 Select [PLOT INT] => and press key after selecting the set up value.
Selection values: 1sec, 2sec, 5sec, 10sec, 30sec, 1min, 3min
- 5 Select [PLOT NUMBER] => and press key after selecting the set up value.
Selection values: 1000, 2000, 4000, 5000, 7000, 10000, 20000

How to Clear OWN SHIP PAST TRACK

- 1 Press **MENU** key to display "Menu".
Select [MAP] => [OWN TRACK] => [CLEAR] => [GO], and press **ENT** key.
All OWN SHIP PAST TRACK disappears, recording and display will restart.

6.3 Target track past position display

This is to set up TT past track position display, display ON or OFF, clear operation, color setting, select track style, plot interval and maximum plot numbers.

- 1 Press **MENU** key to display "Menu".
Select [MAP] => [TARGET TRACK] =>
- 2 Select [TARGET TRACK] => turn trackball to right, select [1 to 100], and press **ENT** key.
- 3 Select [DISPLAY] => [ON], and press **ENT** key.
- 4 Select [CLEAR] => [GO], and press **ENT** key.
The past track of chosen TT will be deleted.
- 5 Select [COLOR] => select color from eight colors => press **ENT** key.
TT past track will turn selected color.
- 6 Select [STYLE] => select line style* => press **ENT** key.
*Line style:
 
- 7 Select [PLOT INT] => and press **ENT** key after selecting the set up value.
Selection values: OFF, 2sec, 15sec, 30sec, 1min, 3min, 5min
- 8 Select [PLOT NUMBER] => and press **ENT** key after selecting the set up value.
Selection values: 50, 100, 200, 500, 1000

Target track start

- 1 Move cursor to an AIS target or TT (ARPA) target to display track, keep **ENT** key pressed, and then press **ACQ** key.

Target track finish

- 1 Move cursor to an AIS target or TT (ARPA) target to track off, and then press **OFF** key.

Note: TARGET TRACK ID and numbers are displayed at the lower right of AIS or TT (ARPA) target.
Above ID and numbers are not displayed when [NUMBER] of [AIS ID DISP TYPE] / [TT ID DISP TYPE] setting is [OFF].
(Refer to 4.1 Common setting "Set TT ID DISP TYPE" or "Set ID DISP SIZE".)

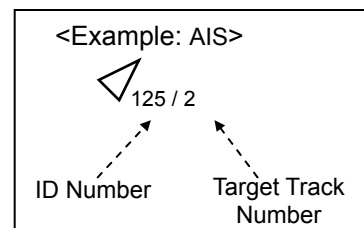

6.4 COAST LINE

This function is to let user generate up to 10 coast lines with up to 100 points each to mark important areas of navigation, such as danger zone areas or navigation channels etc. Coast line can be setup by inputting Lat/Lon information for each point or using cursor and **ENT** key.

It is displayed one by one or all.

- 1 Press **MENU** key to display "Menu".
 Select [MAP] => [COAST LINE] =>
 COAST LINE: Select the number of the coast line to display. (ALL, 1 to 10, OFF)
 ALL: Display all ten coast line.
 1 to 10: Display the coast line of selected number.
 OFF: Don't display coast line.
 EDIT: Create coast line. (CURSOR, BLOCK NUMBER)
 MOVE: Change the position. (CURSOR, BLOCK NUMBER)
 ADD: Insert a position data. (CURSOR, BLOCK NUMBER)
 DELETE: Delete a position data. (CURSOR, BLOCK NUMBER)
 CLEAR: Clear a selected block number coast line data.

How to edit

(1) CURSOR OPERATION

- 1 Press **MENU** key to display "Menu".
 Select [MAP] => [COAST LINE] => [EDIT] => [CURSOR] => select [1 to 10] => [GO] and press **ENT** key.
- 2 Move cursor to first input position, then press **ENT** key. No.1 mark is displayed on the display and numerical data is shown at coast line info area.

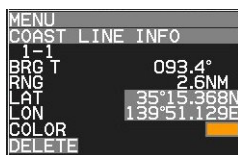

← Edit of LAT/LON data, color setting and delete function can be operated directly using cursor with trackball in this info area.

- 3 Move cursor to second input position, then press **ENT** key. No.2 mark is displayed, and a line is generated from No.1 to No.2.

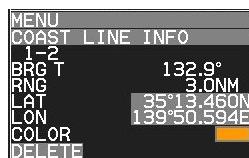
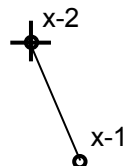

- 4 Move cursor to third input position, then press **ENT** key. No.3 mark is displayed, and a line is generated from No.2 to No.3.
You can input up to 100 point. When input is completed, press **MENU** key. Mark number will disappear.

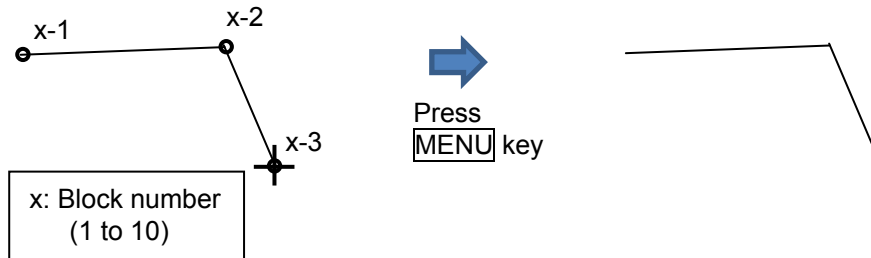

- 5 Refer to 3.4 Nav line cross “How to edit” for the procedures to make plural divided coast line in the memory of same block number.

(2) BLOCK NUMBER OPERATION

- 1 Press **MENU** key to display “Menu”.
Select [MAP] => [COAST LINE] => [EDIT] => [BLOCK NUMBER] => select [1 to 10] =>
Following input menu is displayed.

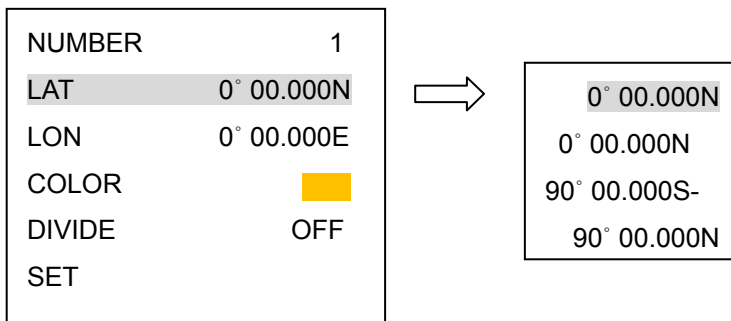

- 2 Select [LAT] => Latitude data set screen is displayed.
Set LAT data by moving of trackball to the right, left, up or down, and press **ENT** key.
- 3 Select [LON] => Longitude data set screen is displayed.
Set LON data by moving of trackball to the right, left, up or down, and press **ENT** key.
- 4 Select [COLOR] => Eight colors box is displayed.
Select color by moving of trackball up or down, and press **ENT** key.
- 5 Select [DIVIDE] => [ON] or [OFF], and press **ENT** key.
[DIVIDE] => [ON] means that it is not connected coast line to the next number data.

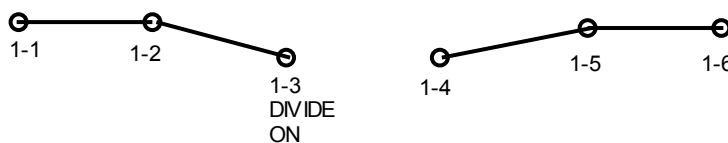

- 6 Select [SET], and press **ENT** key to save input data.

How to move

(1) CURSOR OPERATION

1 Press **[MENU]** key to display "Menu".

Select **[MAP]** => **[COAST LINE]** => **[MOVE]** => **[CURSOR]** => select [1 to 10] => **[GO]**, and press **[ENT]** key. Numerical number is displayed each points of coast line.

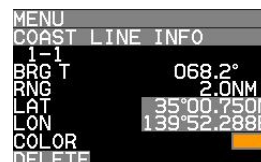
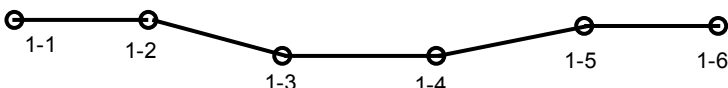

2 Move cursor on editing and moving cursor data.

Press **[ACQ]** key. Circle mark will be displayed on the selected coast line and numerical data is shown at coast line info area.

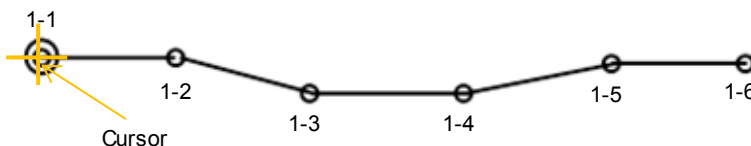

3 Move cursor to new position, then press **[ENT]** key.

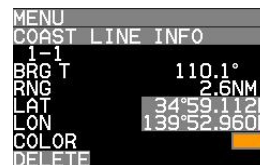
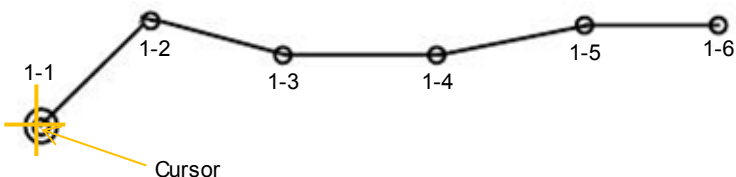

4 Press **[MENU]** key to exit MOVE operation.

(2) BLOCK NUMBER OPERATION

1 Press **[MENU]** key to display "Menu".

Select **[MAP]** => **[COAST LINE]** => **[MOVE]** => **[BLOCK NUMBER]** => select [1 to 10] => Following input menu is displayed.

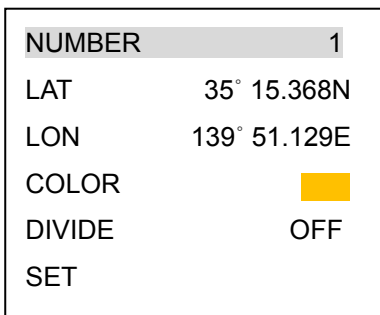

2 Select **[NUMBER]** => NUMBER data screen is displayed. => select [1 to 100] =>

Press **[ENT]** key. Selected number's numerical data is shown.

3 Edit data of LAT, LON, COLOR and DIVIDE.

4 Select **[SET]** and press **[ENT]** key to save input data.

How to add

(1) CURSOR OPERATION

1 Press **MENU** key to display "Menu".

Select **[MAP]** => **[COAST LINE]** => **[ADD]** => **[CURSOR]** => select [1 to 10] => **[GO]** and press **ENT** key. Numerical number is displayed each points of coast line.

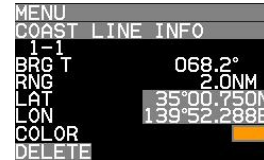
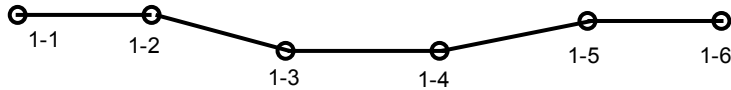

2 Move cursor on position that new data is added in just before it.

Press **ACQ** key. Circle mark will be displayed on the selected.

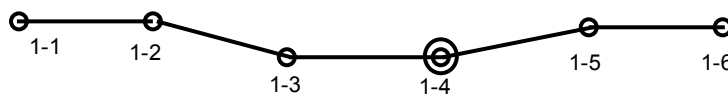

3 Move cursor to the position that new data will be added, then press **ENT** key.

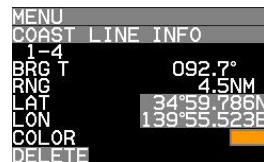
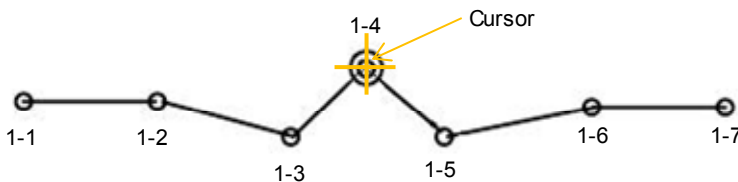

4 Press **MENU** key to exit ADD operation.

(2) BLOCK NUMBER OPERATION

1 Press **MENU** key to display "Menu".

Select **[MAP]** => **[COAST LINE]** => **[ADD]** => **[BLOCK NUMBER]** => select [1 to 10] =>

Following input menu is displayed.

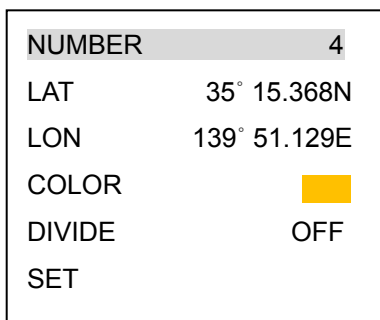

2 Select **[NUMBER]** => NUMBER data screen is displayed. => select [1 to 100] =>

Press **ENT** key. Selected number's numerical data is shown.

3 Edit data of LAT, LON, COLOR and DIVIDE.

4 Select **[SET]** and press **ENT** key to save input data. New data is added as same as cursor operation.

How to delete

(1) CURSOR OPERATION

- 1** Press **[MENU]** key to display "Menu".

Select **[MAP]** => **[COAST LINE]** => **[DELETE]** => **[CURSOR]** => select [1 to 10] => **[GO]** and press **[ENT]** key. Numerical number is displayed each points of coast line.

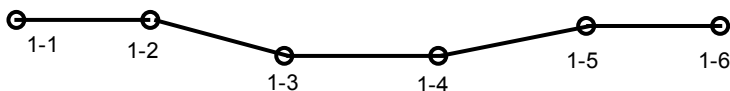

- 2** Move cursor on the position deleting.

Press **[ENT]** key. Selected coast line data will be deleted.

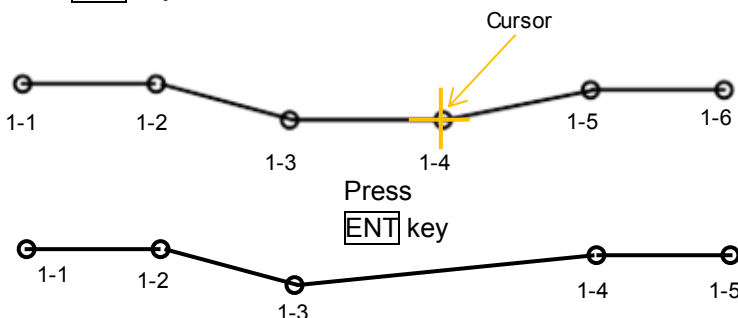

(2) BLOCK NUMBER OPERATION

- 1** Press **[MENU]** key to display "Menu".

Select **[MAP]** => **[COAST LINE]** => **[DELETE]** => **[BLOCK NUMBER]** => select [1 to 10] =>

Following delete menu is displayed.

NUMBER	4
LAT	35° 15.368N
LON	139° 51.129E
SET	

- 2** Select **[NUMBER]** => NUMBER data screen is displayed. => select [1 to 100] =>

Press **[ENT]** key. Selected number's numerical data is shown.

- 3** Select **[SET]**, and press **[ENT]** key to delete selected data.

How to clear

All data of selected block number are cleared.

- 1** Press **[MENU]** key to display "Menu".

Select **[MAP]** => **[COAST LINE]** => **[CLEAR]** => **[BLOCK NUMBER]** => select [1 to 10] => select **[GO]**, and press **[ENT]** key.

6.5 NAV LINE

NAV LINE is a function to display Navigation line by inputting Lat/Lon information for each point or using cursor and **ENT** key to input the points, user can set 10 lines up to 100 points each.

“NAV LINE” generated in this section can also be used in the alarm function for “NAV LINE CROSS” alarm.

Refer to 3.4 Nav line cross.

1 Press **MENU** key to display “Menu”.

Select [MAP] => [NAV LINE] =>

NAV LINE: Select the number of the nav line to display. (ALL, 1 to 10, OFF)

EDIT: Make nav line. (CURSOR, BLOCK NUMBER)

MOVE: Revise the position of the nav line. (CURSOR, BLOCK NUMBER)

ADD: Add a point data in a nav line. (CURSOR, BLOCK NUMBER)

DELETE: Delete a point data in a nav line. (CURSOR, BLOCK NUMBER)

CLEAR: Clear selected block number nav line data.

NAV LINE operation is same as 3.4 Nav line cross and 6.4 COAST LINE operation.

6.6 ROUTE

The ROUTE function is for display purposes only, user can setup ROUTE on radar display for visual navigation aid. ROUTE can be setup using cursor and **ENT** key or by inputting Lat/Lon information for each point. User can add 10 routes with up to 100 points each by using below procedure.

Note: If WPT ID DISP in MAP menu is set to "OFF" then route waypoint name information will not be displayed, and if set to "ON" all waypoints on the route will have name information displayed next to them.

1 Press **MENU** key to display "Menu".

Select [MAP] => [ROUTE] =>

ROUTE: Select the number of the route to display. (ALL, 1 to 10, OFF)

EDIT: Make route. (CURSOR, BLOCK NUMBER)

MOVE: Revise route position. (CURSOR, BLOCK NUMBER)

ADD: Add a point to a route. (CURSOR, BLOCK NUMBER)

DELETE: Delete a point from a route. (CURSOR, BLOCK NUMBER)

CLEAR: Clear selected block number route.

ROUTE operation is same as COAST LINE operation.

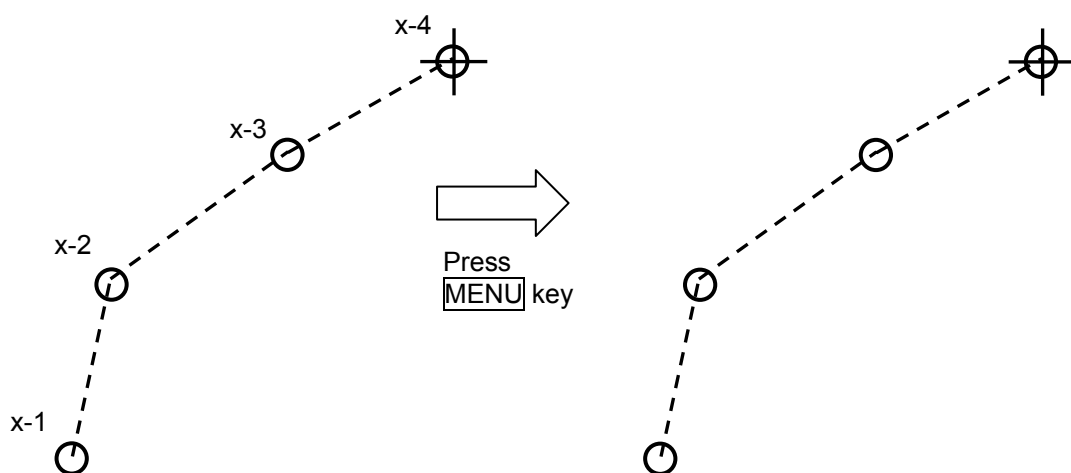

6.7 EVENT MKR

EVENT MKR function displays various marks on the designated place, and can utilize it for sign, such as a destination, a fishery and a caution area. EVENT MKR set can be done by input of Lat/Lon information or by cursor and **ENT** key.

There are 10 blocks that can store 100 marks in each block.

Below procedure is to operate [EVENT MKR] menu.

- 1** Press **MENU** key to display "Menu".
Select [MAP] => [EVENT MKR] =>
EVENT MKR: Select the number of the event mark to display. (ALL, 1 to 10, OFF)
EDIT: Input event mark. (CURSOR, BLOCK NUMBER)
MOVE: Revise position of an event mark. (CURSOR, BLOCK NUMBER)
ADD: Add an event mark. (CURSOR, BLOCK NUMBER)
DELETE: Function to delete event mark using cursor and **ENT** key or BLOCK NUMBER.
CLEAR: Clear all event marks in a given memory block.

User can designate function key such as [F1]-[F6] to [EVENT CURSOR] or [EVENT OWN] for quick shortcut to input [EVENT MKR].

Refer to 2.21 Function key usage.

When set [EVENT MKR] by using function key operation, this radar can output Lat/Lon data of EVENT MKR to external device.

It is necessary to set the output port to output [EVENT MKR] data to external device, following [MAINTENANCE] menu must be set.

Note: This menu is protected in normal. To cancel the protection, refer to 1.3 Menu usage "Display [MAINTENANCE] menu".

- 1** Press **MENU** key to display "Menu".
Select [MAINTENANCE] => [I/O] => [OUTPUT] => [TLL OUT] => [MARK], and press **ENT** key.
- 2** Select [MAINTENANCE] => [I/O] => [OUTPUT] =>
Select [OUTPUT PORT from NAV, EPFS, SDME, GYRO and OTHER] that is connected to external device.
- 3** Select [TLL] => set time to [0.1 to 10.0 sec (except 0.0 sec)], and press **ENT** key.

When press function key (EVENT CURSOR or EVENT OWN), this radar outputs the Lat/Lon data of EVENT by \$RATLL sentence.

6.8 AREA

Area function is for visual navigation where user can input points connected by a line to help with navigation. There are 10 memory blocks for area that can hold up to 100 points each. This function is valid with a minimum input of 3 points which will be connected with a line.

It is possible to use AREA to set alarm for targets entering or leaving the area.

Refer to 3.2 Map area alarm.

1 Press **[MENU]** key to display "Menu".

Select **[MAP]** => **[AREA]** =>

AREA: Select the block number to display. (ALL, 1 to 10, OFF)

EDIT: To create new area. (CURSOR, BLOCK NUMBER)

MOVE: Revise the position of points in area. (CURSOR, BLOCK NUMBER)

ADD: Add a point to any given position in an area line. (CURSOR, BLOCK NUMBER)

DELETE: Delete a point data in area. (CURSOR, BLOCK NUMBER)

CLEAR: Clear selected block number area data

AREA operation is same as COAST LINE operation.

6.9 MONITORED ROUTE

This function when activated can display ROUTE information from external device such as chart plotter or GPS navigator.

RTE + WPL sentences are required from external device to display ROUTE information.

RMB or BWC sentence when inputted from external device will display waypoint information only.

If [RTE + WPL] and [RMB] or [BWC] are inputted in the radar, the ROUTE [RTE + WPL] information takes priority over [RMB] or [BWC] waypoint information.

Route is displayed by dotted line in orange color.

- 1 Press **MENU** key to display "Menu".
Select [MAP] => [MONITORED ROUTE] => [ON], and press **ENT** key.

6.10 WPT ID DISP

This function when activated can display WPT name information from external device such as chart plotter or GPS navigator. This applies to all waypoints from WPT and also ROUTE waypoints. When [WPT ID DISP] turned on, ID information will be displayed next to waypoints and when turned off only waypoints without ID information will be displayed.

- 1 Press **MENU** key to display "Menu".
Select [MAP] => [WPT ID DISP] => [ON], and press **ENT** key.

6.11 TARGET TRACK ID

When tracking a target and past target track is activated, each track will have a label number associated with it, to turn the numbers "on" or "off" use TARGET TRACK ID and the numbers will disappear or reappear.

- 1 Press **MENU** key to display "Menu".
Select [MAP] => [TARGET TRACK ID] => [ON], and press **ENT** key.

6.12 DATUM

Local geodetic datum and datum offsets from a reference datum. This is used to define the datum to which a position location and geographic locations are referenced. Latitude, Longitude and altitude offsets from the reference datum, and the selection of the referenced datum is provided in following menu.

This is to set up DATUM code.

- 1 Press **MENU** key to display "Menu".
 Select [MAP] => [DATUM] => select [W84], [W72], [S85], [P90], [TOY], [999], and press **ENT** key.
 [999] is a user datum. In some special cases and or areas specific datum should be entered therefore please use user datum and edit it for that specific datum. User datum can be setup by following "EDIT USER DATUM" menu.

6.13 EDIT USER DATUM

In case that user specific datum needs to be entered, then use below procedure to set the name.

- 1 Press **MENU** key to display "Menu".
 Select [MAP] => [EDIT USER DATUM] => [DATUM] data input window will appear.

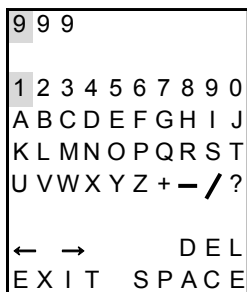

- 2 Select each letter one by one and press **ENT** key after each letter, when finished select [EXIT] and press **ENT** key.

The three letters of [999] in the [DATUM] menu change to the edited letters.

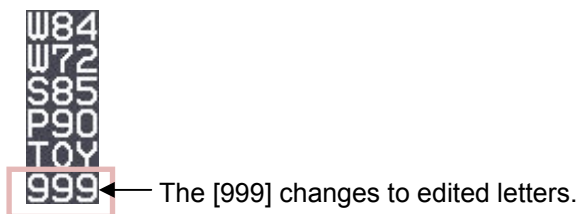

6.14 POSITION OFFSET

This is to select OFFSET input of position.

Selection values: EPFS, MAN

- 1 Press **MENU** key to display "Menu".
Select [MAP] => [OFFSET] => select [EPFS] or [MAN], and press **ENT** key.

POSITION MANUAL OFFSET

LAT/LON position offset values input is available only when [MAN] of [POSITION OFFSET] menu is selected.

- 1 Press **MENU** key to display "Menu".
Select [MAP] => [MAN OFFSET] => input offset value of latitude/longitude separately => and press **ENT** key.
Selection values: 1.000S to 1.000N
1.000W to 1.000E

6.15 GPS BUOY

GPS BUOY, of which display is connected to a GPS BUOY's transmitter-receiver made by Taiyo Musen, will receive buoy information sentences (BLV).

A buoy ID can record 10 kinds of information, and time, position and water temperature at 100 points can be recorded per 1 ID. As for the latest data, in addition to time, position and water temperature, course, speed and battery voltage can be recorded.

Examples of display:

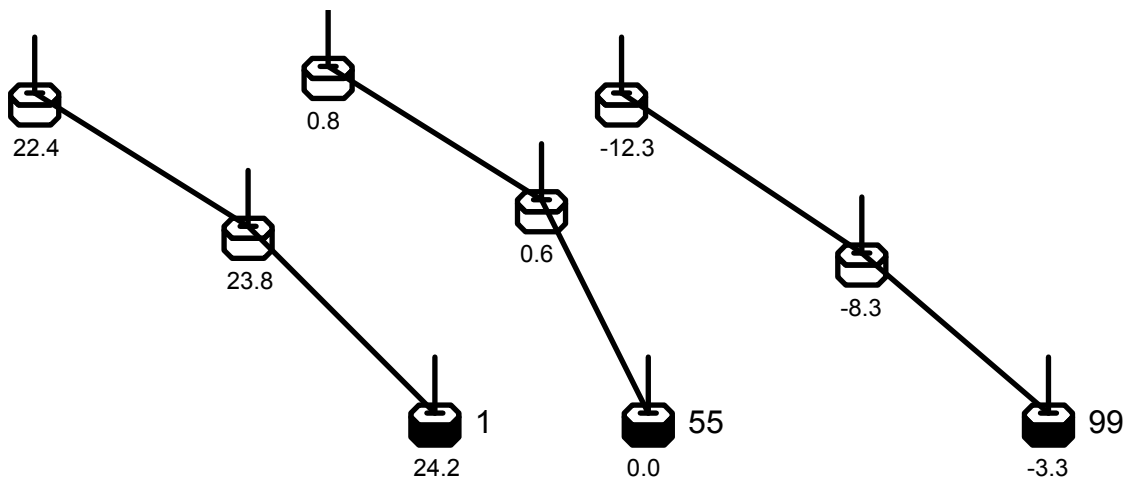

Buoys with same ID will be displayed linked with straight lines. Under each buoy symbol, water temperature can be indicated.

The latest data will be indicated with marked-out symbols, and ID can be also indicated at the right hand side of the symbol as shown in the above examples.

1. NUM DISP

This is the function to display Buoy IDs at the right sides of the latest data buoy symbols.

2. WAT TEMP DISP

This is the function to display water temperature under the buoy symbols.

3. BLOCK NUMBER

This is the function to select block numbers. 1 ID buoy data can be recorded in 1 block.

The following 4 ~ 6 will be applied to the blocks selected in above 3.

4. BLOCK CLEAR

This is the function to deleted buoy data recorded in blocks.

5. BLOCK DATA

This is the function to confirm buoy data in blocks in a list of data.

6.16 WPT FLAG

This function is related to MONITORED ROUTE function. When route or waypoint is inputted from external device flag will be shown of first waypoint, when route and waypoint information is inputted the first waypoint on a route takes priority and flag is displayed. Follow below procedure to turn [WPT FLAG] on and off

- 1 Press **MENU** key to display "Menu".
Select [MAP] => [WPT FLAG] => select [ON] or [OFF], and press **ENT** key.

6.17 LAT/LON LINE

LAT/LON LINE is a function which when enabled displays geographical latitude and longitude lines on the radar display. Follow below procedure to turn LAT/LON LINE on and off.

- 1 Press **MENU** key to display "Menu".
Select [MAP] => [LAT/LON LINE] => select [ON] or [OFF], and press **ENT** key.

6.18 C-MAP chart display

This radar can display chart of C-MAP. The CHART and CHART DISP SET menu are displayed when C-MAP chart of SD-card type has been inserted in the lower card reader on the rear of the Display unit.

Chart on/off

- 1 Press **MENU** key to display "Menu".
Select [MAP] => [CHART] => select [ON] or [OFF], and press **ENT** key.

Setting of the detailed chart display

- 1 Press **MENU** key to display "Menu".
Select [MAP] => [CHART DISP SET] => select item of detailed setting, and select [ON] or [OFF]
=> press **ENT** key.

Setting item: LAND FILL, PLACE NAME, LIGHTHOUSE, BUOY, FISH HAVEN/WRECK,
TRAFFIC ROUTES, CAUTION AREA, FISHERY, CABLE

Note: C-MAP chart data is non official chart data.

**Non Official
Chart Data**

Chapter 7 System and Maintenance menu operation

7.1 SYSTEM MENU

INTER-SWITCH: Refer to 2.31 Inter-switch.

TIME

USER

SOUND

HELP

PROTECT MENU: Refer to 1.3 Menu usage.

MON: Refer to 2.33 Performance monitor.

7.2 Change UTC / LOCAL time

1 Press **MENU** key to display "Menu".

Select **[SYSTEM]** => **[TIME]** => select **[UTC]** or **[LOCAL]**, and press **ENT** key.

[UTC / LOCAL] time can be changed directly at the upper right of the own ship data area, with trackball and **ENT** key, without using menu.



Note: Refer to **[MAINTENANCE]** => **[I/O]** => **[TIME]** menu for detailed how to set time.

(This menu is protected in normal. To cancel the protection, refer to 1.3 Menu usage "Display **[MAINTENANCE]** menu".)

7.3 User memory

This radar is equipped with four user memory slots. All functions and settings can be memorized in the user memory slots and names can be edited individually.

Change USER memory

- 1 Press **MENU** key to display "Menu".
Select [SYSTEM] => [USER] => select new user memory [1 name to 4 name] => [GO], and press **ENT** key.

How to save to memory

All operations are automatically saved in selected user memory slot in real time as they take place so no action is required from user to save settings.

Edit User Name

The used user memory's name can be changed by next operation.

- 1 Press **MENU** key to display "Menu".
Select [SYSTEM] => [USER] => [EDIT USER NAME] =>
- 2 Edit user name window will appear and can change user name.
Maximum 10 letters or numbers can be set for the name.
After name has been changed, press **ENT** key to save setting.

Default User setting

Using these steps it is possible to clear all data associated with currently selected user.

To delete all user settings and return to default, follow below procedure.

- 1 Press **MENU** key to display "Menu".
Select [SYSTEM] => [USER] => [DEFAULT SETTING] => [GO], and press **ENT** key.
This operation will clear all information stored in current user memory.

7.4 Sound setting

Sound menu is to turn sound ON/OFF, setup frequency of sound in Operation unit, key click sound and external buzzer.

Sound ON/OFF

- 1 Press **MENU** key to display "Menu".
Select [SYSTEM] => [SOUND] => [SOUND] => select [ON] or [OFF], and press **ENT** key.

Sound frequency

- 1 Press **MENU** key to display "Menu".
Select [SYSTEM] => [SOUND] => [FREQUENCY] => select [1 to 8], and press **ENT** key.
Selection values: 1 to 8
1: Lowest frequency
8: Highest frequency

Key click ON/OFF

- 1 Press **MENU** key to display "Menu".
Select [SYSTEM] => [SOUND] => [KEY CLICK] => select [ON] or [OFF], and press **ENT** key.

External buzzer setting

External buzzer signal (Failure alarm) can be output from J1 connector on the back panel.

Output signal is relay contact. (Alarm contact will open in case of failure.)

Output of relay contact is continuous when set to continue.

Output of relay contact is intermittent when set to interval.

- 1 Press **MENU** key to display "Menu".
Select [SYSTEM] => [SOUND] => [EXT BUZZER] => select [OFF], [CONTINUE] or [INTERVAL],
and press **ENT** key.

7.5 HELP window ON/OFF

Help window is displayed at the lower right of the display. When the help window menu is on, it displays a procedure of complicated operation such as ALARM and MAP.

- 1 Press **MENU** key to display "Menu".
Select [SYSTEM] => [HELP] => select [ON] or [OFF], and press **ENT** key.

```
Map ADD Operation
ACQ:Select item
ENT:Insert to the
    point
OFF:Divide the item
MENU:Exit of edit
```

7.6 MAINTENANCE MENU

STARTUP: Refer to 4.2 STARTUP menu of Installation manual.

I/O: Refer to 4.3 Setup I/O Interface of Installation manual.

SECTOR MUTE: Refer to 4.4 Setup SECTOR MUTE mode of Installation manual.

PRESET: Refer to 4.5 Setup PRESET of Installation manual.

BACKUP:

BITE: Refer to Chapter 9 Simple fault diagnosis.

TOTAL HOUR:

TX HOUR:

MENU SETUP:

PASSWORD: Refer to 1.3 Menu usage.

MON: Refer to 2.33 Performance monitor.

VERSION:

7.7 BACKUP of Setup data (Cannot be used while transmitting)

By saving setup data to the internal memory or external memory, the initial setup and all settings are saved, in the event that the radar needs to be reinitialized or some setup changes been made, user can go back to the original settings by restoring from memory.

Backup of setup data should be saved after initial setup.

In case of malfunction of display where re-initialization must be done, restore of backup data completed at the time of original setup will bring all proper settings and tuning setup back to normal operation.

Internal save of setup data

Note: This menu is protected in normal. To cancel the protection, refer to 1.3 Menu usage "Display [MAINTENANCE] menu".

To save data internally at the time of setup,

- 1 Press **MENU** key to display "Menu".
Select [MAINTENANCE] => [BACKUP] => [SETUP SAVE] => [GO], and press **ENT** key.

To restore from internally backup after re-initialization,

- 1 Press **MENU** key to display "Menu".
Select [MAINTENANCE] => [BACKUP] => [SETUP LOAD] => [GO], and press **ENT** key.

External save of setup data (Cannot be performed while transmitting)

To save setup data externally, this information can be later used to restore after a possible malfunction.

The external memory uses an SD memory card.

CAUTION: Please do not use the SD memory card which is loaded with software program files.

Note: This menu is protected in normal. To cancel the protection, refer to 1.3 Menu usage “Display [MAINTENANCE] menu”.

To perform external backup to SD card,

- 1** Insert SD memory card in the upper card reader on the rear of the Display unit.
- 2** Press **MENU** key to display “Menu”.
Select [MAINTENANCE] => [BACKUP] => [SD CARD] => select [SETUP SAVE], [MARK SAVE], [TGT TRACK SAVE] or [OWN TRACK SAVE] => [CANCEL] or [GO], and press **ENT** key.
When SD memory card not inserted, [SD CARD] menu is greyed out and cannot be operated.

To restore from SD card backup after re-initialization,

- 1** Insert SD card that was used to store settings in above procedure in the upper card reader on the rear of the Display unit.
- 2** Press **MENU** key to display “Menu”.
Select [MAINTENANCE] => [BACKUP] => [SD CARD] => select [SETUP LOAD], [MARK LOAD], [TGT TRACK LOAD] or [OWN TRACK LOAD] => [CANCEL] or [GO], and press **ENT** key.
When SD memory card not inserted or no data found on the card, [SD CARD] menu is greyed out and cannot be operated.

Parameter reset

Use this function as means to return the radar to its default settings as it was at first power on.

Note: This menu is protected in normal. To cancel the protection, refer to 1.3 Menu usage “Display [MAINTENANCE] menu”.

- 1** Press **MENU** key to display “Menu”.
Select [MAINTENANCE] => [BACKUP] => [PARAMETER RESET] => [RESET], and press **ENT** key.

7.8 TOTAL HOUR and TX HOUR (Cannot be used while transmitting)

Note: This menu is protected in normal. To cancel the protection, refer to 1.3 Menu usage “Display [MAINTENANCE] menu”.

TOTAL HOUR menu indicates the total operating time of the radar.

This menu can reset total hour to 0.

- 1 Press **MENU** key to display “Menu”.
 Select [MAINTENANCE] => [TOTAL HOUR] => [RESET], and press **ENT** key.

TX HOUR menu indicates the total transmitting time of the radar.

This is useful information to use when exchanging radar parts. Use this hour information to judge magnetron life expectancy.

Reset after components have been exchanged

- 1 Press **MENU** key to display “Menu”.
 Select [MAINTENANCE] => [TX HOUR] => [RESET], and press **ENT** key.

7.9 MENU SETUP

Note: This menu is protected in normal. To cancel the protection, refer to 1.3 Menu usage “Display [MAINTENANCE] menu”.

MENU SETUP menu can be used to simplify full menu and turn off the items in full menu that are not used. This is often used to remove not needed menu items for simple operation of the radar.

- 1 Press **MENU** key to display “Menu”.
 Select [MAINTENANCE] => [MENU SETUP] => [GO], and press **ENT** key.
 Setup menu display will display.
- 2 Select menu item to set ON or OFF => select [X] or [O], and press **ENT** key.
- 3 When setup finish, press **MENU** key. Menu display will disappear.
 Press **MENU** key again. [X] mark menu items are not displayed.

>ECHO	
PICTURE MODE	x
PROCESS	x
EXPANSION	x
IR	O
VIDEO CONTRAST	O
NOISE REJ	O
COLOR REJ	O
PULSE WIDTH	O
SART	O
PICTURE RESET	O
>ECHO	O



>ECHO	
IR	OFF
VIDEO CONTRAST	3
NOISE REJ	OFF
COLOR REJ	OFF
PULSE WIDTH	>
SART	OFF
PICTURE RESET	>

← When set [>ECHO] to [x], all ECHO menu items will not be available.

7.10 System Program

Version confirmation

Currently installed firmware version can be found by using following menu operation.

Note: This menu is protected in normal. To cancel the protection, refer to 1.3 Menu usage “Display [MAINTENANCE] menu”.

- 1 Press **MENU** key to display “Menu”.
Select [MAINTENANCE] => [VERSION] =>

MRD/MRM-108P

KM-F44 xx.xx ⇐ Firmware version of Display/Processor unit

MRO-108P

KM-F45 yy.yy ⇐ Firmware version of Operation unit

How to update the system program

- 1 Prepare SD memory card with latest program.
File name: radar
File type: MOT
- 2 Turn off the power.
- 3 Insert SD memory card in the upper card reader on the rear of the Display unit.
- 4 Press **POWER ON/OFF** key to turn on, radar will start update procedure automatically.
Message of “LOADING IN PROGRESS”, “PLEASE DO NOT POWER OFF” etc., and time bar will be displayed.
During updating, **EBL1** and **VRM1**, **EBL2** and **VRM2**, **BRILL** and **PANEL** key’s lamps flash red.
Few minutes later, when program update is complete, “LOADING COMPLETE” and “PLEASE EJECT SD CARD” messages will appear on the display.
- 5 Remove SD memory card from the card reader, and new system program will run automatically.
The list of updated program file will be shown on the display.

In some cases, message of “SHUTDOWN” is displayed, and power will be turned off.

In this case, please press **POWER ON/OFF** key again, and message of “INITIALIZING” will be displayed.

Chapter 8 Principal of radar system

8.1 What is radar system?

The radar is a navigation device that transmits a very high frequency radio wave referred to as microwave from the antenna. The radar then receives the radio wave reflected by target(s) (e.g. other ship, buoy, island, etc.) via the same antenna and converts the received radio wave to electronic signals and sends these signals to the Display unit. The radar makes it possible to find objects (targets), such as other ships, rocks or coastline, not seen by eyesight at night or in fog and allows ships to avoid these potential hazards. As the antenna transmits during 360-degree rotation, it is possible to see the current surrounding situation around your ship at a glance.

The microwave radiated from the radar is referred to as pulse wave and the transmitting and receiving of these waves is alternated. Up to thousands of pulse waves are transmitted and received during one rotation

The typical radar antenna is of parabolic type or slotted array type and its performance is essential for good radar performance. Some of factors affecting the quality of the target returns are antenna beam width and side lobe level. The narrow beam width provides high resolution for angular orientation to distinguish objects and the low side lobe level reduces false image effect.

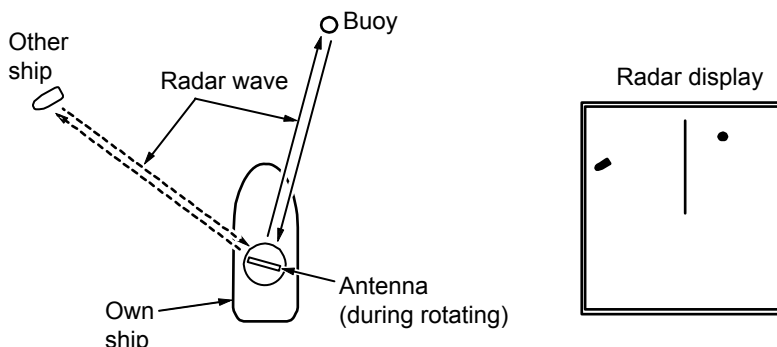

Side lobe

The main lobe means the strongest radiated beam sent from the specific antenna, and the other weaker beams, are referred to as a side lobes. A side lobe level is a difference between the largest side lobe level and main lobe level.

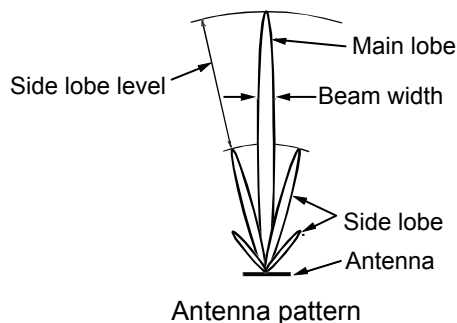

Beam width

Antenna beam width is defined as the angle where the radiation power density is within a half of maximum power density (-3 dB) in main lobe (also, referred to as “half value width”).

8.2 Characteristics of radar radio wave

The radar radio wave propagates slightly along the ground (primarily line of sight). This characteristic varies depending on density of atmosphere, but is generally calculated according to the formula as shown below, considering that the distance with radar sight D is about 6 % longer than the distance with optical sight.

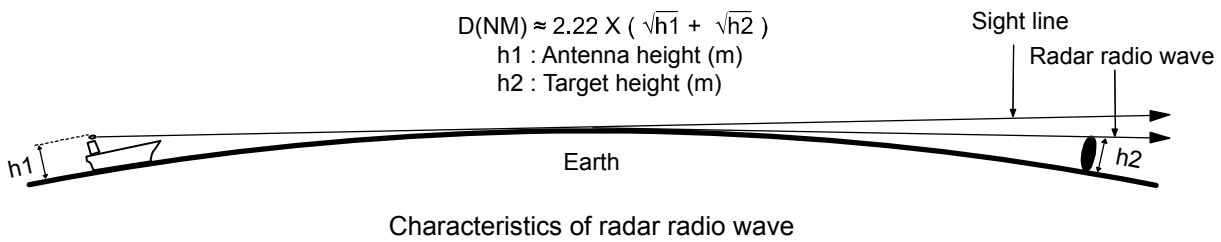

Target hardness reflected

The strength of the reflected wave from a target varies depending on not only the distance from the target, its height or size, but also its material and features. A target with a low degree of reflection or low incident angle, such as FRP (Fiber Reinforced Plastic) and wooden ship is not reflected well. Therefore, care shall be taken that a FRP ship, a wooden ship or an object such as sand, a sandbar and muddy cay are poor radar targets.

Since the distance from the coastline, etc. to your ship on a radar image tends to be seen as longer than that from the actual coastline, more caution should be paid when navigating around such objects.

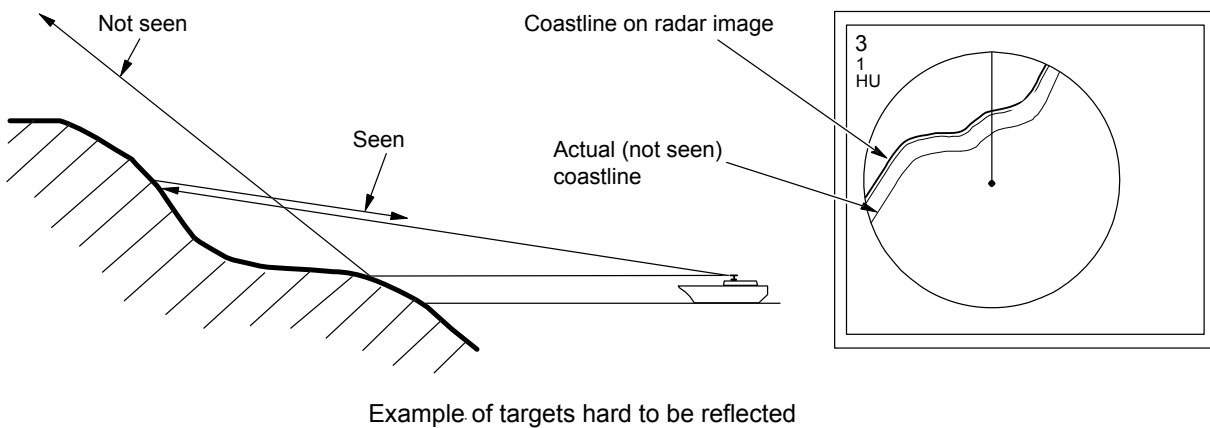

Radar shadow

Since radar radio wave is line of sight in nature your stack mast close to the antenna or, a large ship or mountain may create blind spots for which the radar cannot penetrate. In such cases, they may completely or partially hide targets and cast a long shadow.

Since the shadow of your stack or mast is known at the time of installation, proper selection of the antenna location is necessary to reduce the shadow effect. Since targets in this shadow area is less likely to be seen than in open sea, extra attention should be paid in shadowed areas.

False image

An image that does not actually exist (false image) at sea may appear on the display.

The phenomena that causes false echoes are categorized and be described as follows:

• **Virtual image**

The image of a large physical object in proximity may appear in two different orientations. One is a real image and the other is a false image caused by wave re-reflected by the stack or the mast, etc. On the display, one image appears at the correct distance and bearing, and another one appears in the direction of a stack, a mast, etc. These images may also be generated by re-reflection from bridges and quays too.

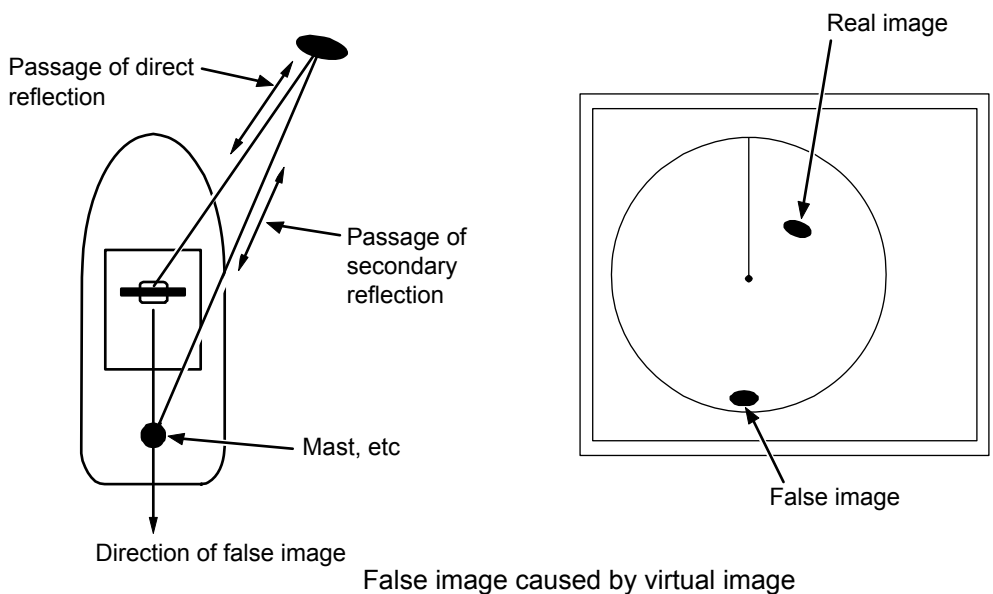

• Duplicate target images

When there is a big reflective surface nearby and it is perpendicular at a close distance (i.e. when your ship is passed by a big ship, etc.), the radio wave bounces between own ship and the other ship. Therefore, two to four images may appear at equal range in the direction of this target. The false images generated by this multi-path reflection are referred to as “double targets”. In this case, the closest target is the real image.

If the distance and bearing between own ship and the reflective target changes, then the duplicate targets will disappear. Therefore, this false image can be easily distinguished.

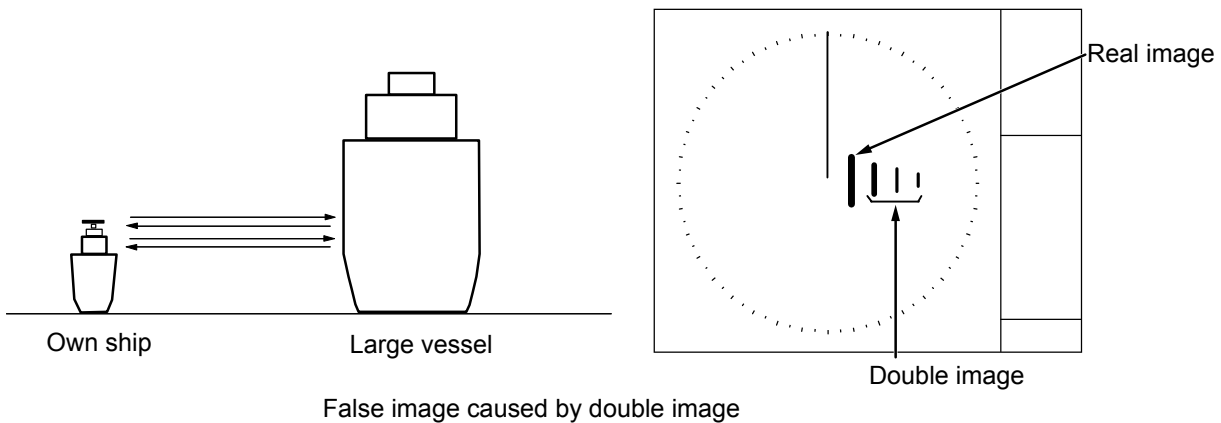

•Side lobe images

The microwave beam radiated from the antenna has a side lobe in different direction than that of the main beam. Since this side lobe level is lower than that of main beam, the effect is negligible for targets at long range, but a close, strong reflecting target may cause false image appearing in a circular arc shape.

 <p style="font-size: 24pt; font-weight: bold; margin: 0;">CAUTION</p>	<p>When own ship is close to large targets such as land, a circular image may appear.</p>
---	---

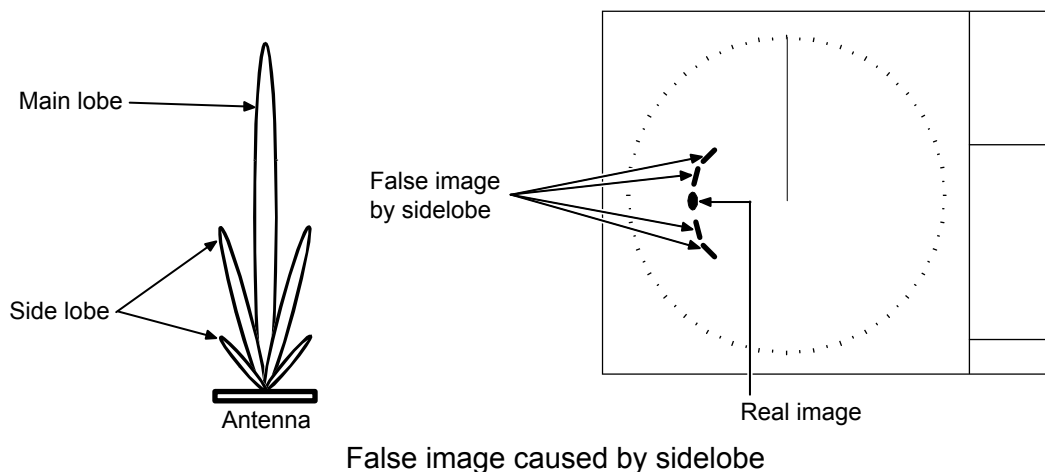

•Skip target images

False image of a distant target caused by “skip” phenomenon

Depending on weather conditions, skip caused by the temperature inversion layer of air, etc. may appear. In this case, the radio wave may unusually propagate to distant targets out of the radar range. A target at more than the maximum range may appear as an image, and may be displayed as a false image with closer distance than the actual one. This phenomenon is a result of the wide range echo delay time exceeding the transmission period, and is displayed as echo in the following rotation. If the range scale is changed and the target range is changed, it can be judged as a false image.

8.3 Radar interference

When the radar with the same frequency band is used nearby, interference noise appears on a display.

Although appearance of interference is not constant, the shape is almost always swirling or radial.

This series of radars features an IR (interference rejection) facility to reduce this interference.

- This page intentionally left blank.-

Chapter 9 Simple fault diagnosis

For simple fault diagnosis, follow below procedures.

For faults not listed below, refer to Installation manual.

Items posted

- 9.1 No alarm sound. (ALARM TEST)
- 9.2 Operation unit (panel) key is not operational. (PANEL TEST)
- 9.3 TT (ARPA) is not operational. (DIAGNOSE TT)
- 9.4 No AIS display. (DIAGNOSE AIS)
- 9.5 Need to confirm serial input. (SERIAL MONITOR)
- 9.6 No radar video display. (ANT MONITOR)
- 9.7 Frozen display.
- 9.8 About alarms

- 1** Press **MENU** key to display "Menu".
Select [SYSTEM] => [PROTECT MENU] => [ON]
- 2** Enter [PASSWORD], and press **ENT** key to display [MAINTENANCE] menu.
- 3** Press **MENU** key to display "Menu".
Select [MAINTENANCE] => [BITE] =>

>MAINTENANCE
>BITE
ALARM TEST
PANEL TEST
DIAGNOSE TT
DIAGNOSE AIS
SERIAL MONITOR
ANT MONITOR
SD CARD

9.1 No alarm sound

Follow this procedure to troubleshoot no alarm sound trouble.

First, select [SYSTEM] => [SOUND] and confirm that the status is [ON].

Note: This menu is protected in normal. To cancel the protection, refer to 1.3 Menu usage “Display [MAINTENANCE] menu”.

- 1 Press **MENU** key to display “Menu”.
Select [MAINTENANCE] => [BITE] => [ALARM TEST] => [ON], and press **ENT** key after selection.
- 2 Please confirm the frequency setting, because it may be hard to hear the alarm sound according to the setting value.
Select [SYSTEM] => [SOUND] => [FREQUENCY] (Initial setting: 4)
- 3 Alarm sounds (two times) and alarm display appears at the lower right of the display.
Alarms displayed are [WARNING B 999], [Test alert only].



- 4 Confirmation is completed if alarm sounded.
- 5 Alarm sounds are repeated every 60 seconds.
Select [MAINTENANCE] => [BITE] => [ALARM TEST] => [OFF], and press **ENT** key to turn alarm test off.

Note: After running the test and there is still no alarm sound the Operation unit has malfunction.

9.2 Operation unit (panel) key is not operational

Following procedure is a test for Operation unit in case some keys don't function properly. First please make sure all cables are connected properly.

Note: This menu is protected in normal. To cancel the protection, refer to 1.3 Menu usage "Display [MAINTENANCE] menu".

- 1 Press **MENU** key to display "Menu".
Select [MAINTENANCE] => [BITE] => [PANEL TEST] =>.
- 2 Panel illustration will appear on the display.
- 3 Press any key expect **MENU** key.
[•] mark will appear at the left side of key name during the key press.

The line in the circle will rotate when the knob is turned.

The circle color will change when the knob is pressed.

The small circle in the square will move when trackball is moved.

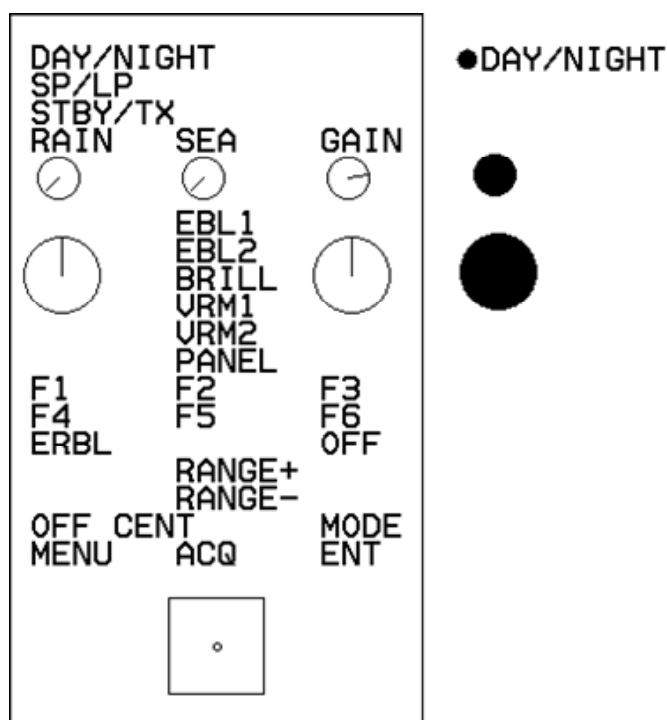

- 4 Pressing **MENU** key will complete the test.

Operation unit (panel) malfunctions, if No.3 item is not normally displayed.

9.3 TT is not operational

This procedure is applied when acquisition operation does not start despite **ACQ** key being pressed.

First, confirm that [INPUT RNG] is properly set.

The targets outside of [INPUT RNG] will not be acquired.

This procedure confirms ATA function.

Note: This menu is protected in normal. To cancel the protection, refer to 1.3 Menu usage "Display [MAINTENANCE] menu".

- 1** Press **MENU** key to display "Menu".
Select [MAINTENANCE] => [BITE] => [DIAGNOSE TT] =>.
- 2** Confirm [O] mark appears on the left side of [HDG].
- 3** Turn trackball to the left to complete.

If [x] mark is displayed in step 2, then confirm HDG input for Display unit.

9.4 No AIS display

This procedure is applied when AIS is not displayed.

First, confirm that [INPUT RNG] is properly set.

Targets outside of [INPUT RNG] are not displayed.

Confirm AIS function by following steps.

Note: This menu is protected in normal. To cancel the protection, refer to 1.3 Menu usage "Display [MAINTENANCE] menu".

- 1** Press **[MENU]** key to display "Menu".
Select [MAINTENANCE] => [BITE] => [DIAGNOSE AIS] =>.
- 2** Confirm that the [O] mark appears at the left side of [AIS DATA], [HDG], [SPD], [LAT/LON] and [COG/SOG].
- 3** Turn trackball to the left to complete.

If [x] mark is displayed in step 2, then

In the case of [AIS DATA]: No valid AIS data input.

Confirm AIS receiver connected to Display unit.

AIS DATA is usually input to AIS (J2) connector.

In the case of [HDG]: No valid HDG input.

Confirm HDG input of Display unit.

HDG is usually input to GYRO connector.

In the case of [SPD]: No valid SPD input.

Confirm SPD input of Display unit.

SPD is usually input to SDME (J6) connector.

In the case of [LAT/LON]: No valid LAT/LON input.

Confirm LAT/LON input of Display unit.

LAT/LON is usually input to EPFS (J5) connector.

In the case of [COG/SOG]: No valid COG/SOG input.

Confirm COG/SOG input of Display unit.

COG/SOG is usually input to SDME (J6) or EPFS (J5) connector.

9.5 Need to confirm serial input

This procedure is applied to confirm serial input of Display unit.

Serial input of connectors can be confirmed with the following 6 connectors:

AIS (J2), NAV, GYRO-unit, OTHER (JB-35), EPFS (J5), SDME (J6).

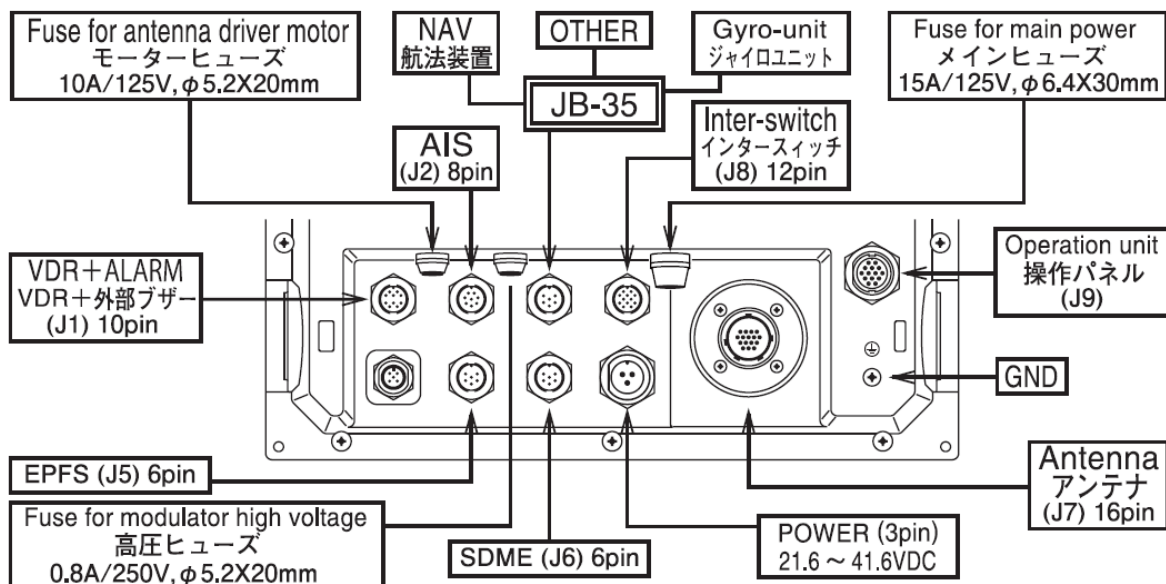

Note: This menu is protected in normal. To cancel the protection, refer to 1.3 Menu usage “Display [MAINTENANCE] menu”.

- 1 Press **[MENU]** key to display “Menu”.
Select [MAINTENANCE] => [I/O] => [SERIAL MONITOR] => select [NAV], [EPFS], [SDME], [GYRO], [OTHER], [AIS] or [ALL], and press **[ENT]** key.
[ALL] can confirm the data of all ports at a time.
- 2 Input data will be displayed.
Since the data keeps coming in and the display keeps changing it may be hard to observe the sentences.
By pressing **[ENT]** key, data display will stop temporarily to confirm data content.
- 3 Turn trackball to left to complete.

Data confirming item in step 2

In the case that data is not displayed: Confirm input data device connected to Display unit.

In the case that data is displayed but is garbled: Confirm baud rate (FORMAT).

9.6 No radar video display

This procedure is applied when no radar video (Echo) is displayed on the display.

Note: This menu is protected in normal. To cancel the protection, refer to 1.3 Menu usage “Display [MAINTENANCE] menu”.

- 1** Press **[MENU]** key to display “Menu”.
Select [MAINTENANCE] => [BITE] => [ANT MONITOR] =>.
- 2** Antenna status will be displayed.
- 3** Turn trackball to left to complete.

Antenna status criteria in step 2

Connected scanner model name and type:

HIGH VOLTAGE: If the value is other than xxx to xxx, indicates high voltage malfunction.

MAG CURRENT MONI: If the value is other than xx to xxx, indicates magnetron malfunction.

MAG HEATER: If the value is other than xx to xxx, indicates magnetron malfunction.

MOTOR MONI:

TUNE VOLTAGE: If the value is other than xx to xxx, indicates magnetron or Front End Module failure.

RATE OF ROTATION: Antenna rotation (rpm).

9.7 Frozen Display

Following procedure applies for troubleshooting Frozen Display phenomenon.

Indication of presentation failure

You can aware of a display presentation failure from identification conspicuous periodically time element on the display.

This element is located upper right of the display by eight pattern triangle icons.



These icons will change every two seconds, three angles of directions turn to the clockwise.

When this movement stopped, radar system will be stopping.

Restart Display unit immediately.

Frozen Display refers to case when video is not refreshed or cursor is not responsive.

- 1 Turn **GAIN**, **SEA** and **RAIN** knob to confirm changes of video (Echo).
- 2 Turn trackball to confirm if cursor is moving.
While Menu is displayed, confirm if menu selection can be changed.

When malfunction of either step 1 or step 2 is found, the display is frozen.

Restart Display unit immediately.

9.8 About alarms

If any malfunction or operation error has been detected in the radar, or if the external device gives the ALR sentence input, then alarms, warnings and cautions shown below appear at the lower right of the display.

Abnormalities are categorized as [Alarm], [Warning] and [Caution]. When alarm display actually appears and there is something wrong with radar, record the alarm details by type, location and status and press **[OFF]** key. The alarm sound and display will disappear. Multiple errors may be displayed one by one. Record all alarms and press **[OFF]** key for every alarm. The type of [Alarm], [Warning] and [Caution] are shown below.

The two or more alarms occur at the same time, then it is possible to confirm all the alarms in [LIST].

- 1 Press **[MENU]** key to display "Menu".
Select [ALARM] => [LIST] =>

Alarms occurred since Power ON can be confirmed by [HISTORY LIST].

- 1 Press **[MENU]** key to display "Menu".
Select [ALARM] => [HISTORY LIST] =>

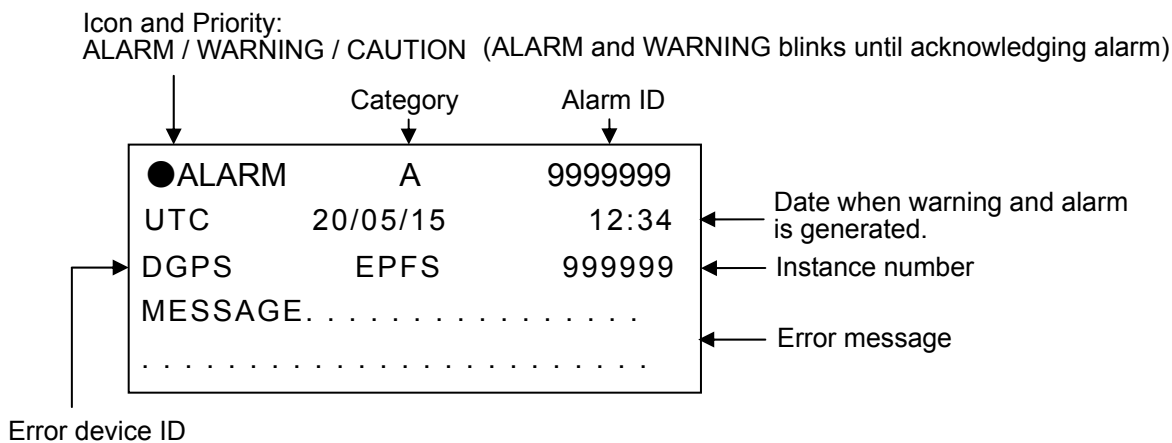

Refer to 1.1 Radar Display "Alarm display area".

Alarm list

List of system alarm and message.

					Contents	Cause
A	W	190	1	57	AIS targets exceed the limit.	Number of AIS targets exceeding the maximum 900 has been input.
A	W	190	2	54	Tracked targets exceeded the limit.	Number of tracked targets in TT (ARPA) exceeded the maximum 100.
A	W	190	3	56	AIS input targets exceeded the limit.	Number of AIS targets exceeding the maximum 900 has been input.
B	C	190	4	58	AIS targets overload. (95%)	Number of AIS targets being input exceeded 855.
B	C	190	5	55	Tracked targets overload. (95%)	Number of tracking targets exceeded 95.
A	A	191	1	3	Tracked target exceeded the CPA/TCPA limit.	Tracked target has turned into dangerous target.
A	A	191	2	8	AIS target exceeded the CPA/TCPA limit.	AIS target has turned into dangerous target.
A	W	192	1	4	Tracked target entered into the guard zone.	Tracked target has entered into the guard zone.
A	W	192	2	5	Auto acquisition of a radar target.	Captured a target entered into auto acquisition area.
A	W	192	3	9	AIS target entered into the guard zone.	AIS target entered into the guard zone.
A	W	192	4	10	Auto activation of an AIS target.	A sleeping target has been activated.
A	W	193	1	1	Tracked target is lost.	TT (ARPA) has been lost.
A	W	193	2	7	AIS target is lost.	AIS target has been lost.
A	W	193	3	2	Ref tracked target is lost.	Ref tracked target has been lost.
B	W	194	1	22	HDG is unavailable.	THS or HDT are not inputted.
B	W	194	2	23	SDP is unavailable.	VBW, VTG, RMA or RMC are not inputted.
B	W	194	3	24	COG/SOG is unavailable.	COG/SOG is not inputted.
B	W	194	4	25	SET/DRIFT data is unavailable.	VDR is not inputted.

B	W	194	5	26	LAT/LON data is unavailable.	GLL or GGA, GNS, RMC, RMA are not inputted.
B	W	194	6	27	DATUM data is unavailable.	DTM is not input.
B	W	194	7	28	TIME data is unavailable.	ZDA or RMC, GGA are not input.
B	C	194	8	60	AIS no OS COG/SOG data.	Own ship's data that is necessary for AIS are not input.
B	W	194	9	61	AIS no data.	There is no AIS data. VDM is not input from AIS.
B	C	194	13	29	HDG is manual.	There is not heading signal.
B	C	194	14	30	SDP is manual.	There is not speed signal.
B	C	194	15	31	COG/SOG is manual.	There are not ground course and speed signal.
B	C	194	16	32	SET/DRIFT is manual.	There is not tide signal.
B	C	194	17	33	LAT/LON is manual.	There are not latitude and longitude signal.
B	C	194	18	80	Receive alert of any signal or sensor in use.	Receive alert of any signal or sensors in use.
B	C	194	25	109	AIS no data.	There is no AIS data. VDM is not input from AIS.
B	C	194	26	110	SPD is unavailable.	VBW, VTG, RMA or RMC are not inputted.
B	C	194	27	111	COG/SOG is unavailable.	COG/SOG is not inputted.
B	W	999	1	89	Test alert only.	Under alert test.
A	W	10000	1	53	Echo area alarm detected.	Images are detected in echo alarm area.
A	W	10000	2	15	Echo map area alarm detected.	Images were detected in map area.
B	C	10000	3	11	Activated AIS target without HDG or COG.	There is neither ship's bearing nor fairway of AIS active target input data to HDG or COG.
B	C	11000	1	14	Nav line exceeded.	Own ship crossed the Nav line.
B	C	11000	2	62	Received AIS message.	Received AIS message to OWN ship.
B	C	12000	1	16	Change to relative bearing.	True bearing is not inputted.
B	C	12000	2	17	Change to relative vector.	VBW, VTG or VDR are not inputted.
B	C	12000	3	18	Change to relative past position.	VBW, VTG or VDR are not inputted.
B	C	12000	4	19	Change to head up.	THS, HDT, HDM or VTG, RMA, RMC are not inputted.
B	C	12000	5	20	Change EBL origin position.	THS, HDT, HDM or VTG, RMA, RMC are not inputted.

B	C	12000	6	34	Change to sea stabilization.	Ship's bearing: THS, HDT, HDM, VTG Course against water: VBW Speed: VBW, VTG, VHW are not input.
B	C	12000	7	64	Change to reference antenna.	The set CCRP went beyond radar display. Reference has moved to antenna position.
A	A	12000	8	65	Cannot use the CCRP.	Cannot display CCRP position. Change position or range.
B	C	12000	9	21	Change to off process.	THS, HDT, HDM or VTG, RMA, RMC are not inputted.
B	C	12000	10	35	Change to ground stabilization	Speed: VBW or VHW is not input. Change to ground stabilization. Check VBW or VHW sentence.
B	C	12000	11	36	Change SOG input to EPFS	Change SOG input source from SDME (VBW) to EPFS (VTG).
B	C	16000	1	47	Inter-switch not connected.	NAV ports between master and slave are not connected.
B	C	16000	2	59	AIS alarm signal.	Alarm for abnormality is input in AIS alarm terminal of AIS port or the terminals are open.
B	C	16000	3	66	No WGS84 DATUM.	Input geodetic system is not WGS84.
A	A	17000	1	41	Antenna not connected.	Connector of Antenna may not be connected to Antenna, or Scanner unit may be faulty.
A	A	17000	2	42	Antenna magnetron current abnormal.	Magnetron may be at the end of life or transmission high voltage fuse blown.
A	A	17000	3	43	Antenna magnetron heater abnormal.	Something is wrong with magnetron or Scanner unit.
A	A	17000	4	44	Antenna magnetron high voltage abnormal.	High voltage fuse for transmission blown.
A	A	17000	5	45	Antenna high voltage abnormal.	High voltage fuse for transmission blown.
A	A	17000	6	46	Motor voltage abnormal.	Motor voltage fuse blown.
A	A	17000	7	48	Azimuth abnormal.	BP signal from Scanner unit is not received. May be fault in angle detecting sensor in Scanner unit or poor connection at connector.
A	A	17000	8	49	Head line signal abnormal.	SHF signal from Scanner unit is not received. May be fault in SHF sensor in Scanner unit or rotation of antenna may be stopped.

A	A	17000	9	50	Trigger abnormal.	Trigger from Scanner unit is not received.
A	A	17000	10	51	Radar video abnormal.	IF video from Scanner unit is not received.
A	A	18000	1	13	Panel not connected.	No communication between operating panel is available. Connector (J9) is disconnected.
B	W	18001	1	37	Flash memory erase & write error.	Flash memory erase and write error.
B	W	18001	2	38	Flash memory erase error.	Flash memory erase error.
B	W	18001	3	39	Flash memory write error.	Flash memory write error.
B	W	18001	4	40	Flash memory checksum error.	Flash memory checksum error.
B	C	18002	1	71	SD card problem.	SD card may be broken.
B	C	18002	2	72	SD card not ready.	There is not SD card.
B	C	18002	3	73	SD card write protected.	SD card is protect mode.
B	C	18002	4	74	SD card not enough free space.	Memory of SD card is not left.
B	C	18002	5	75	Illegal data.	The data does not agree.
B	C	18002	6	76	USB memory problem.	USB memory problem.
B	C	18002	7	77	USB memory not ready.	USB memory not ready.
B	C	18002	8	78	USB memory write protected	USB memory write protected
B	C	18002	9	79	USB memory not enough free space.	USB memory not enough free space.
B	A	18003	1		JB-35 not connected.	No communication between junction box JB-35 is available. Connector J3 is disconnected.
B	A	18003	2		JB-35 not extended mode.	There is not JB-35 with the extended mode.

Operation note

Operation note display may appear at the lower right of the radar display as shown in below when an operation error has been detected in the device.

When operation note display actually appears and there is something wrong with radar operation.

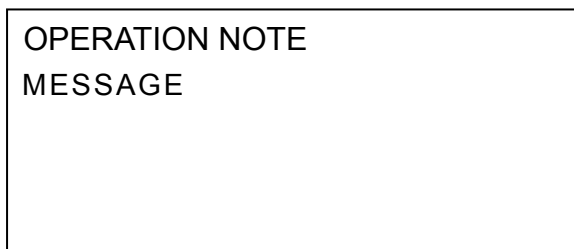

3 short audible signals, and after 5sec. this message will disappear.

Type of Operation note

Contents	Cause
Tracked target full.	Acquired tracked target beyond the maximum tracking number.
Tracked target no data.	Deleted tracked target as there were no tracked targets.
Tracked target out of range.	Acquired tracked target beyond operating distance set for targets.
Pre heating.	Operated transmission key during pre-heating countdown.
No HDG, LAT/LON signal.	As signals of ship's bearing, latitude/longitude had not been input, functions that need those signals have been disabled.
No HDG signal.	As signals of ship's bearing had not been input, functions that need ship's bearing signal were disabled.
No SPD signal.	As speed signal had not been input, functions that needs speed signal were disabled.
Map data full.	More than the specified number of COAST LINE, NAV LINE, ROUTE, EVENT MKR and AREA tried to attempt to register in map function.
Cursor off.	Cursor is not displayed.
Inter-switch changed the mode.	During inter-switch connection, one Display unit switched over inter-switch mode.

No off center.	In the maximum range, off center function was disabled.
Tracking malfunction. BRG T	As the result of TT test, the accuracy of bearing has exceeded the reference.
Tracking malfunction. RNG	As the result of TT test, the accuracy of range has exceeded the reference.
Tracking malfunction. CPA	As the result of TT test, the accuracy of CPA has exceeded the reference.
Tracking malfunction. TCPA	As the result of TT test, the accuracy of TCPA has exceeded the reference.
Tracking malfunction. T CRS	As the result of TT test, the accuracy of true course has exceeded the reference.
Tracking malfunction. T SPD	AS the result of TT test, the accuracy of true speed has exceeded the reference.
Mode hold.	Attempted to change mode during operation of performance monitor. The mode is fixed at H-UP.
Range hold.	During starting up of performance monitor, attempted to change the range. The range is fixed at 24 NM.
Time to trial manoeuvre is less than 30 seconds.	The remaining time of trial manoeuvre is less than 30 seconds.
Reference target overload.	Attempted to acquire reference target beyond 3.
Do not use MAN COG/SOG.	Cannot use AIS with COG/SOG data inputted by manual.
Do not use REF COG/SOG.	Cannot use AIS with COG/SOG data calculated by reference target.
Do not use CURRENT COG/SOG.	Cannot use AIS with SET/DRIFT data inputted by manual.
Do not use MAN STW.	Cannot use AIS with speed data inputted by manual.
Do not use MAN POSITION.	Cannot use AIS with own ship position data inputted by manual.
Time error.	Cannot use AIS with no time data.
Do not use MAN OFFSET POSITION.	Cannot use AIS with offset position inputted by manual.

- This page intentionally left blank.-

Chapter 10 Specifications

10.1 Antenna and Scanner unit (Exposed)

Antenna

Model name	RW701A-04	RW701A-06	RW701B-09
Antenna length	4feet	6feet	9feet
Horizontal beam width	1.8°	1.2°	0.8°
Vertical beam width	22°	22°	25°
Side lobe within ±10°	-25dB	-25dB	-25dB
Side lobe outside ±10°	-30dB	-30dB	-30dB
Polarization	Horizontal		

Scanner

Model name	MDC-7012P/7912P	MDC-7025P/7925P
Scanner unit	RB808P	RB809P
Type	Up-mast	
Rotation	24 rpm	
Output frequency	X-band: 9410MHz ± 30MHz	
Output power (Peak)	12 kW	25 kW
Magnetron	MAF1565N	M1568BS
Performance Monitor	KPM-20	
Temperature	-25°C to +55°C	
Water protection	IPX6	

Range, PRF, Pulse width

PRF (Hz)	Pulse width	Range (NM)												
		0.125	0.25	0.5	0.75	1.5	3	6	12	24	48	64	96	
2600	0.08us	S1												
2600	0.15us			S2										
2400	0.3us					M1								
2000	0.4us					M2								
1400	0.6us						M3							
1000	0.8us						L1							
600	1.2us							L2						
450	1.2us											L3		

10.2 Display, Processor and Operation unit (Protected)

Model name	MDC-7912P/7925P	MDC-7012P/7025P
Display unit	MRD-108P	---
Processor unit	---	MRM-108P
Operation unit	MRO-108P	
Display size and type	19 inch color TFT LCD	---
Display Resolution	1280 X 1024 pixels (SXGA)	
Effective diameter	282 mm (CAT2, CAT3)	--- (CAT1 - CAT3)
Viewing distance	1 m	Refer to specification of display.
Frequency band	X-band 9410MHz \pm 30MHz (9380MHz to 9440MHz)	
Speed class	Normal speed class (< 30 knot)	
Echo color	Green/Yellow	
Off-centering	Max. 75%	
Range data accuracy	8 m or 1 % of range scale selected, whichever is greater	
Range	0.125, 0.25, 0.5, 0.75, 1.5, 3, 6, 12, 24, 48, 64, 96 NM Up to 64 NM for transmit output 12 kW, Up to 96 NM for transmit output 25 kW	
Bearing accuracy	\pm 1°	
Presentation modes	Head up, North up, and Course up	
Functions	CFAR (Clutter rejection), Interference rejection, Expansion, Process (Residual image, Averaging), VRM, EBL, Parallel index, ERBL, Cursor position (Lat/Lon), Bearing (true/relative), Trail (true/relative), Own ship past track, MAP (Event mark, etc.), Analog RGB output, VDR output, Inter-switch, Trial manoeuvre, C-map chart	
NMEA Input/output	5 CH (with JB-35)	
Power supply	21.6 VDC to 41.6 VDC	
Power consumption (at 24 VDC)	MDC-7012P/MDC-7912P: 150W or less MDC-7025P/MDC-7925P: 200W or less	
AIS	900 targets	
TT (ARPA)	100 targets	
Temperature	-15°C to +55°C	
Water protection	Front panel (MDC-7912P/MDC-7925P) and Operation unit: IP23	

10.3 External view and dimensions

MRD-108P

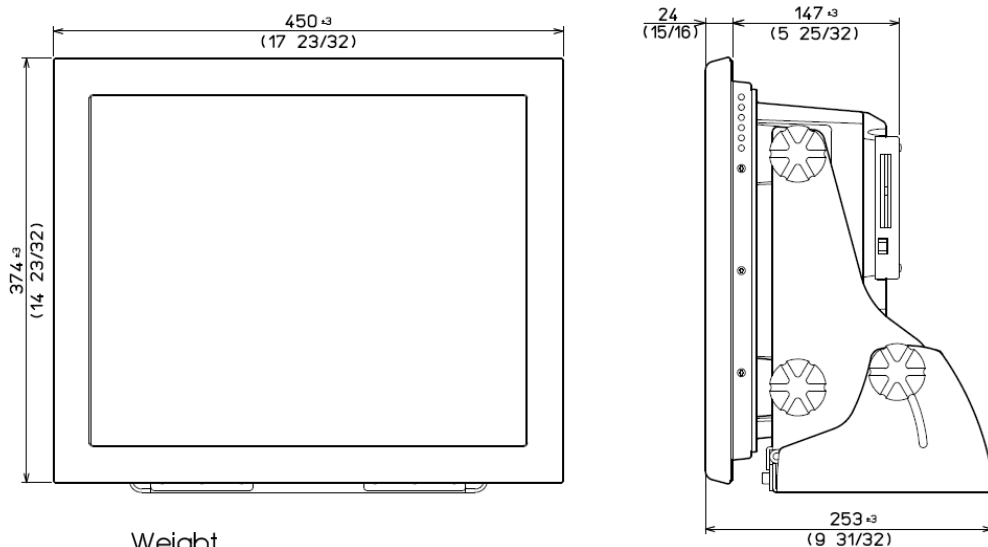

Weight : 13.0kg (29 lb) (架台含む)
重量

MRO-108P

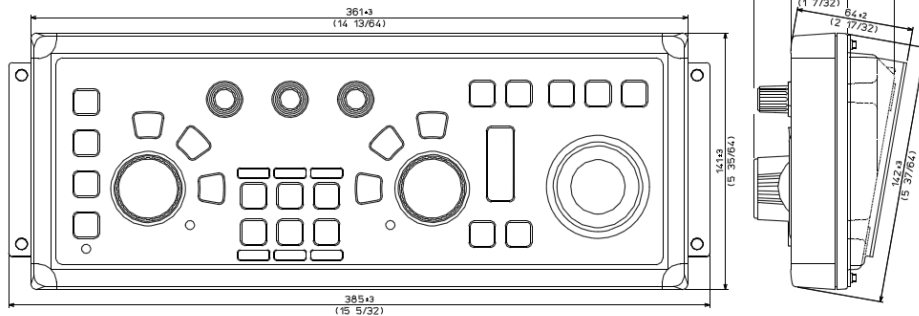

Weight : 1.8kg(4lb) [inclusive base and connecting cable]
重量 / 架台及び接続ケーブル含む

MRM-108P

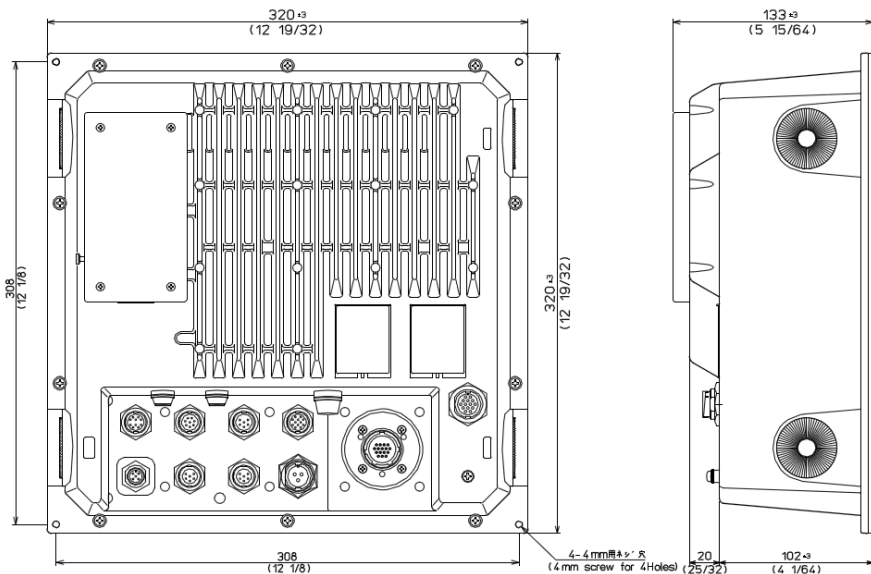

Weight : 5.1kg(11.5lb)
重量

Unit: mm (inch)

RB808P

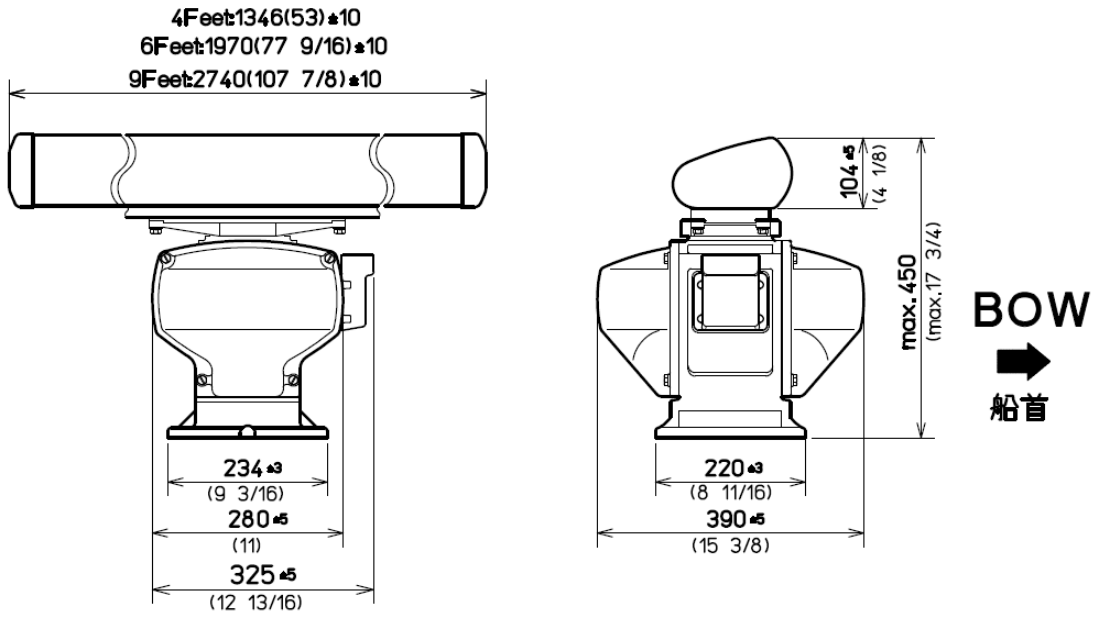

Weight : 24.5kg±2kg(54lb);(RW701A-04)
 26.5kg±2kg(58.5lb);(RW701A-06)
 30.5kg±2kg(67.5lb);(RW701B-09)

RB809P

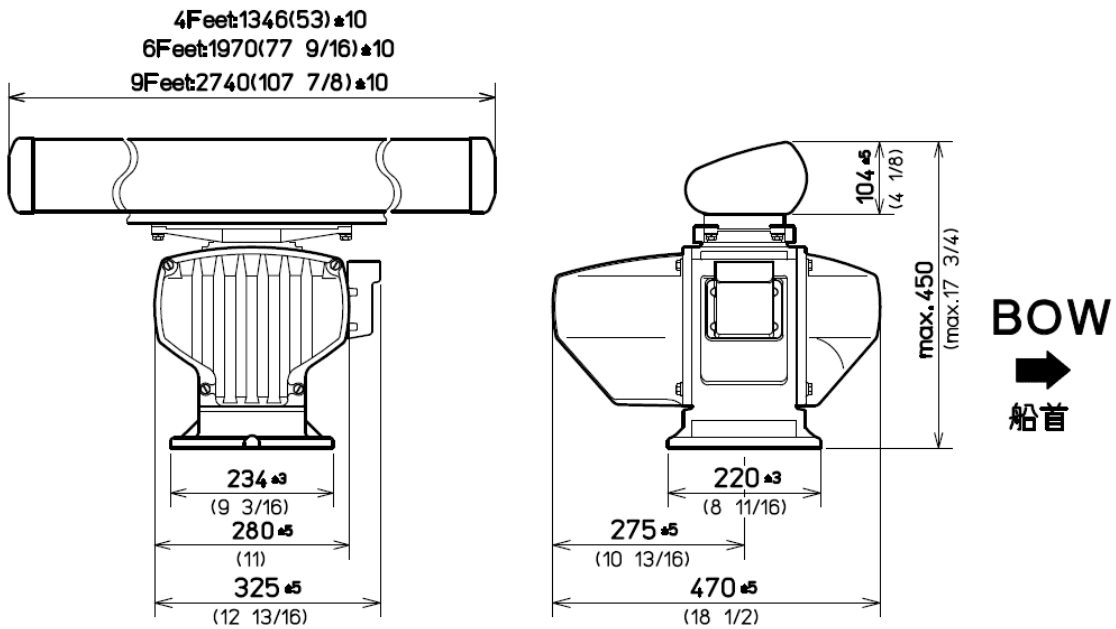

Weight : 26.5kg±2kg(58.5lb);(RW701A-04)
 28.5kg±2kg(63lb);(RW701A-06)
 32.5kg±2kg(72lb);(RW701B-09)

Unit: mm (inch)

Junction box (JB-35)

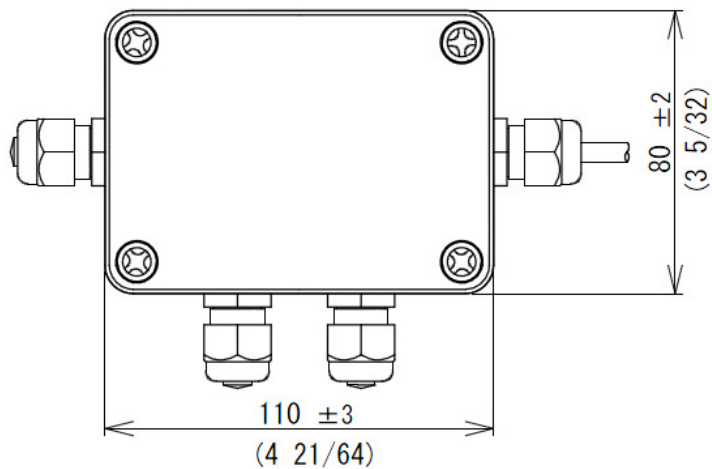

Plane view
平面

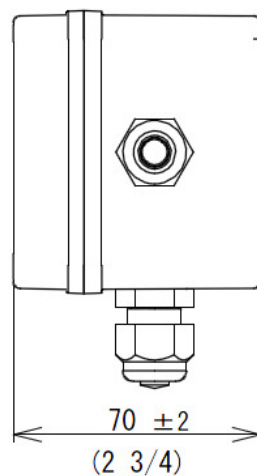

Side view
側面

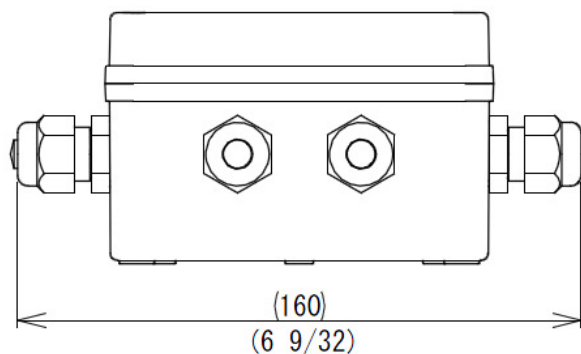

Front view
正面

Unit: mm (inch)

- This page intentionally left blank.-

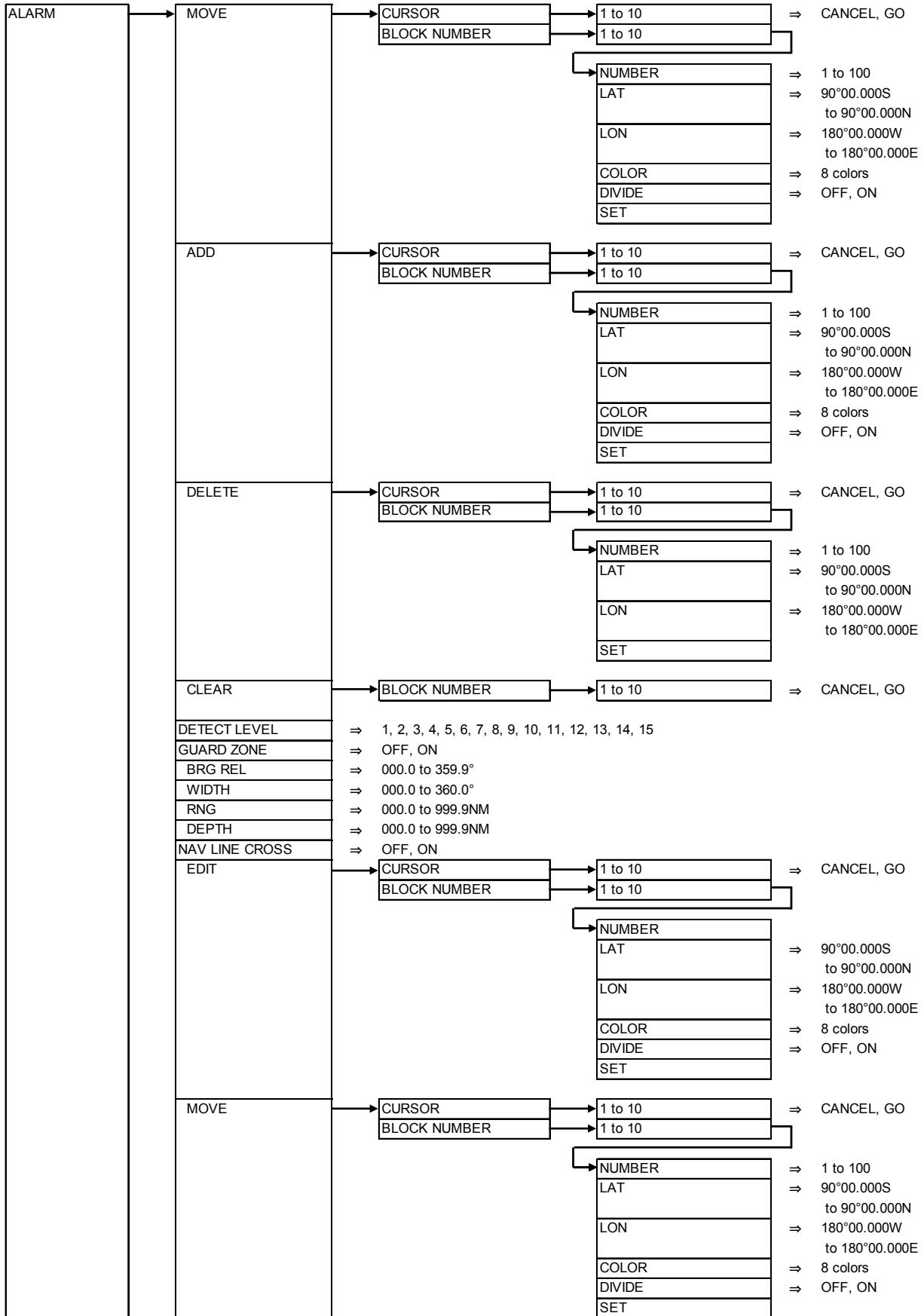

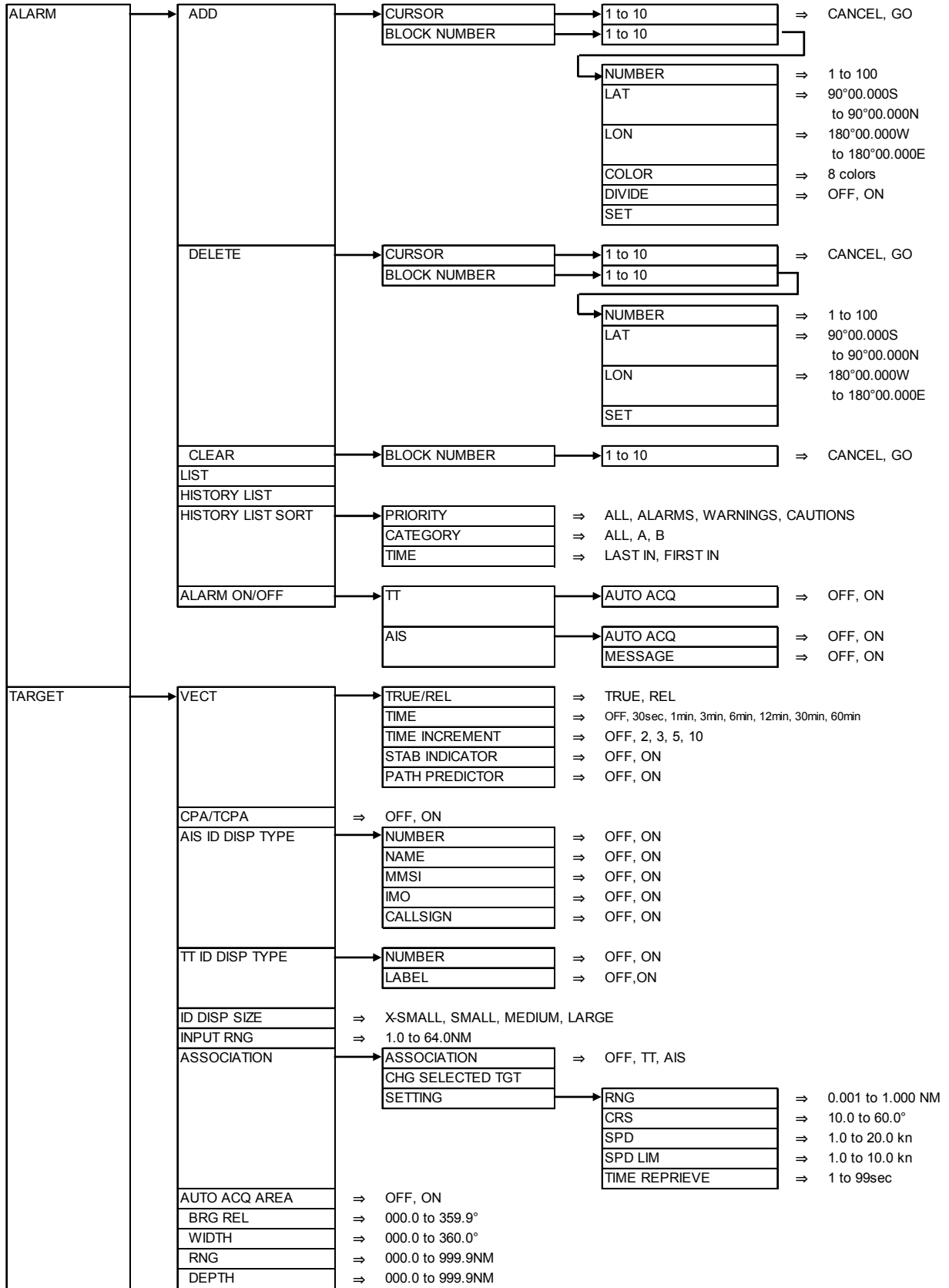

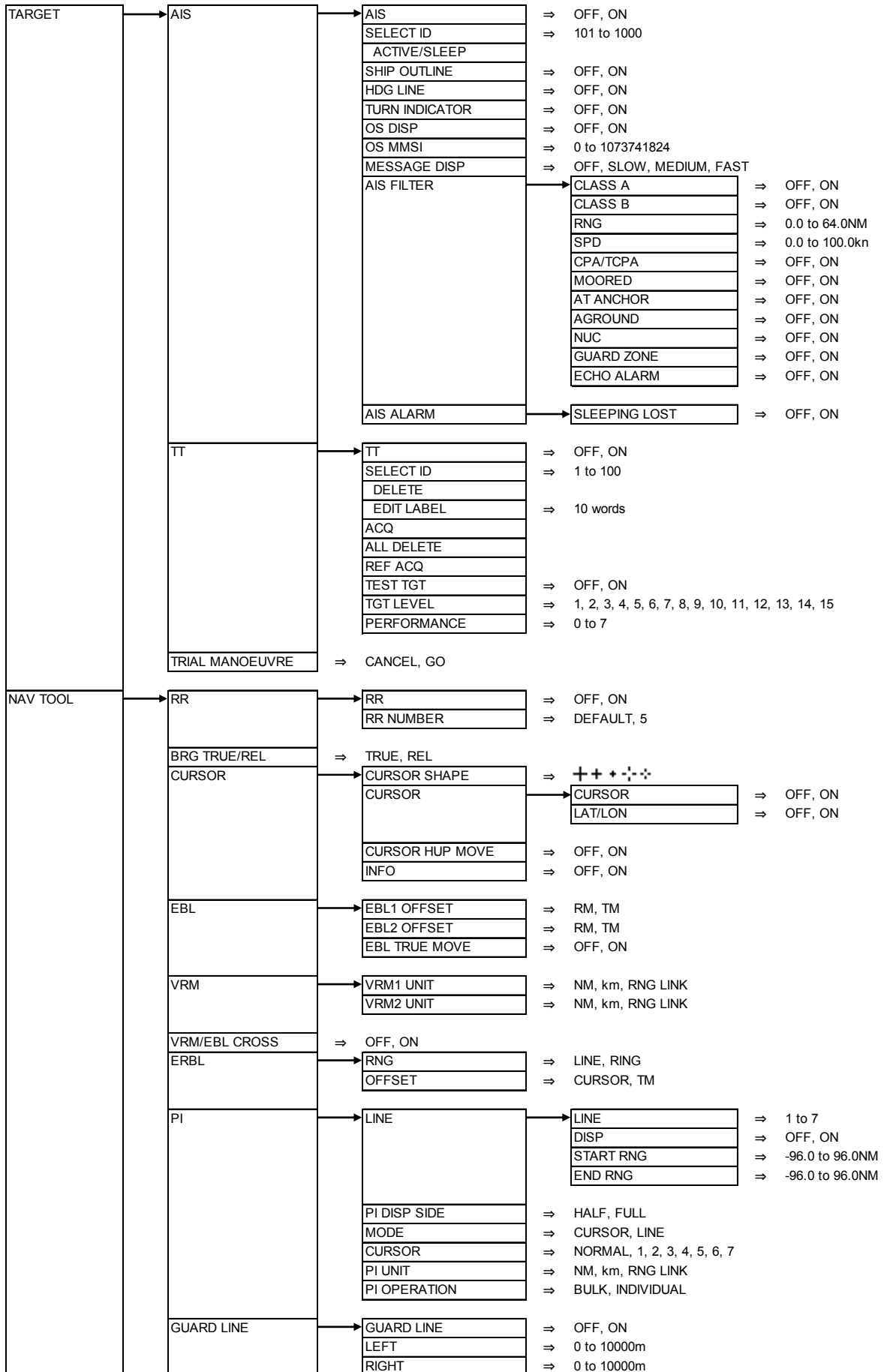

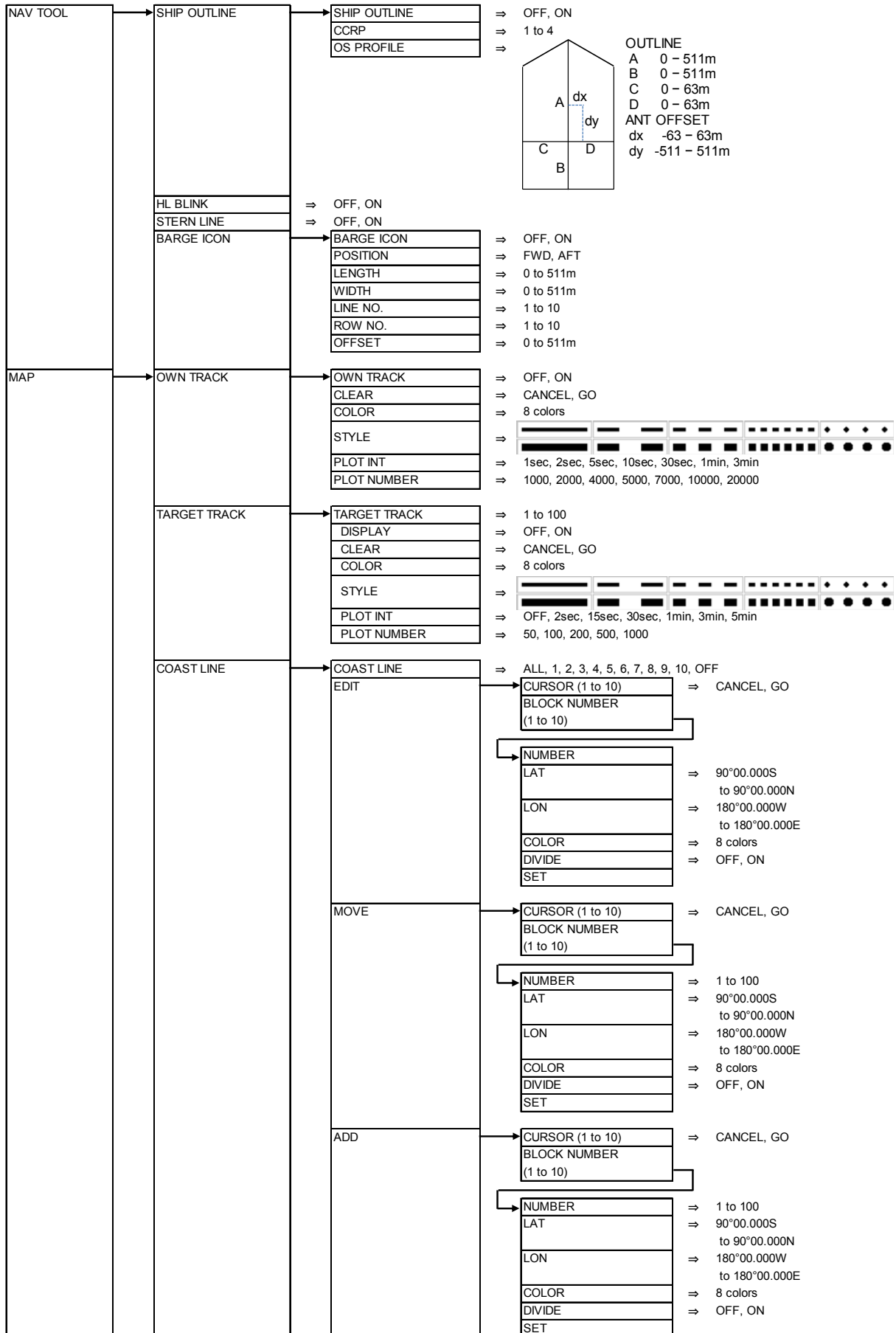

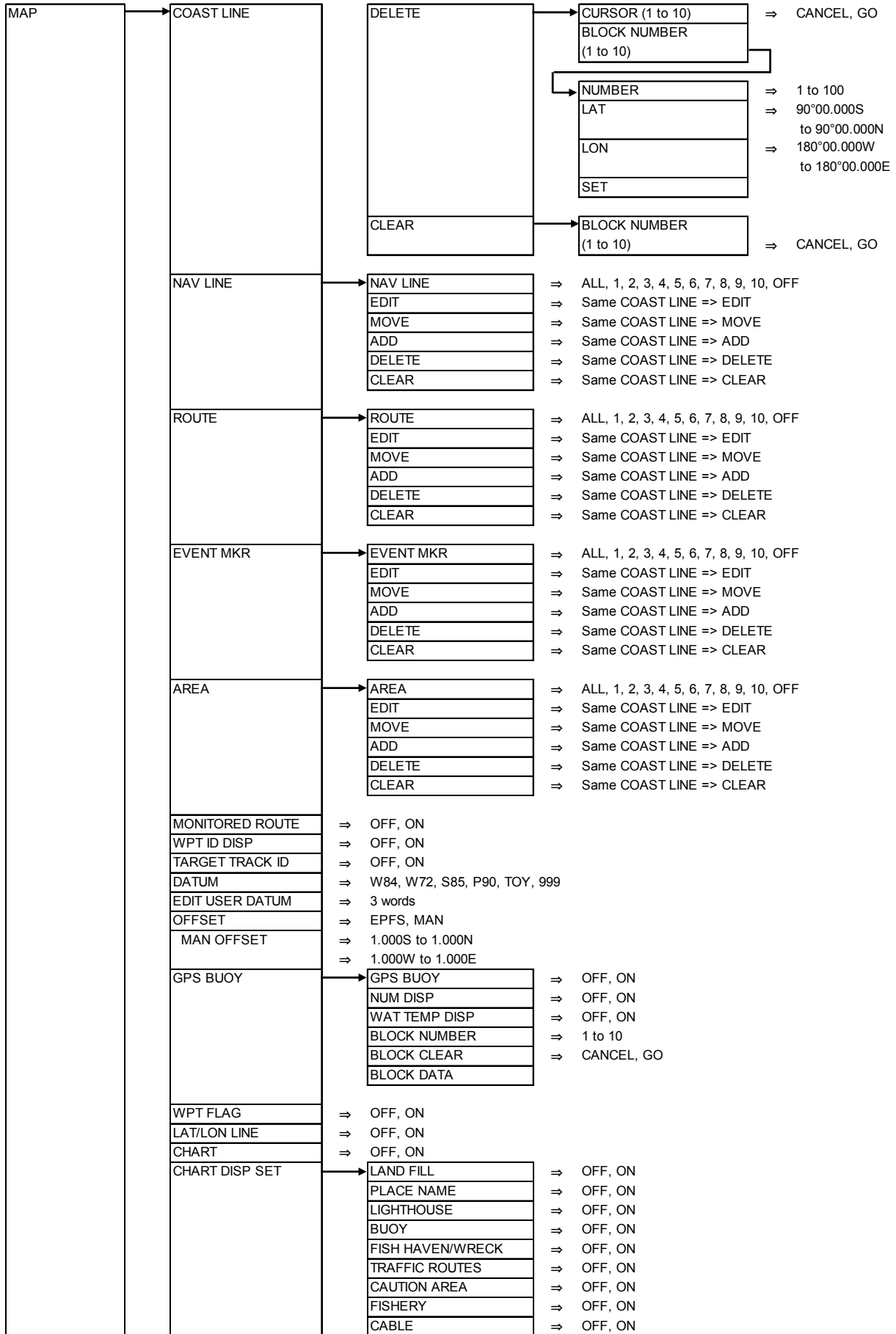

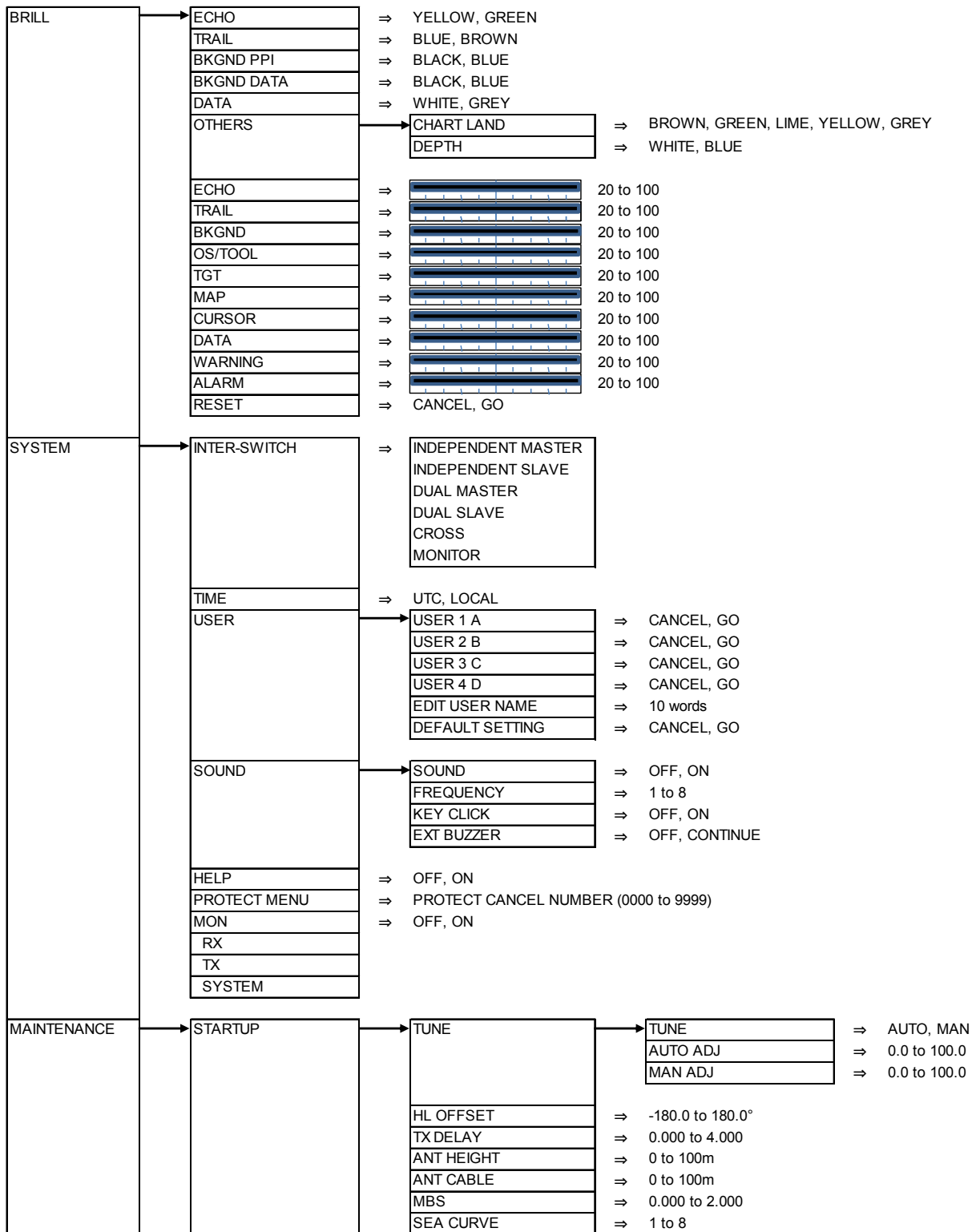

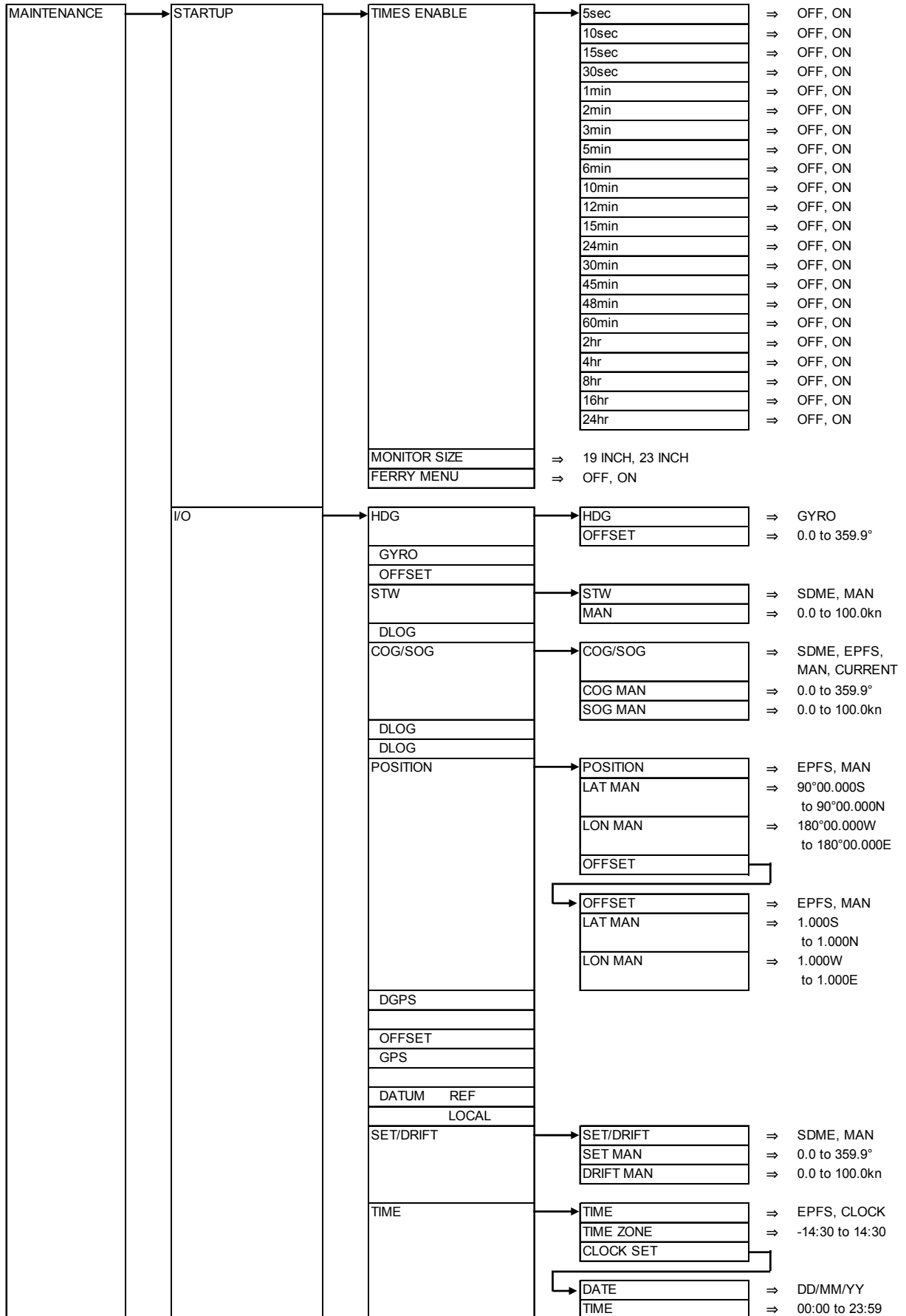

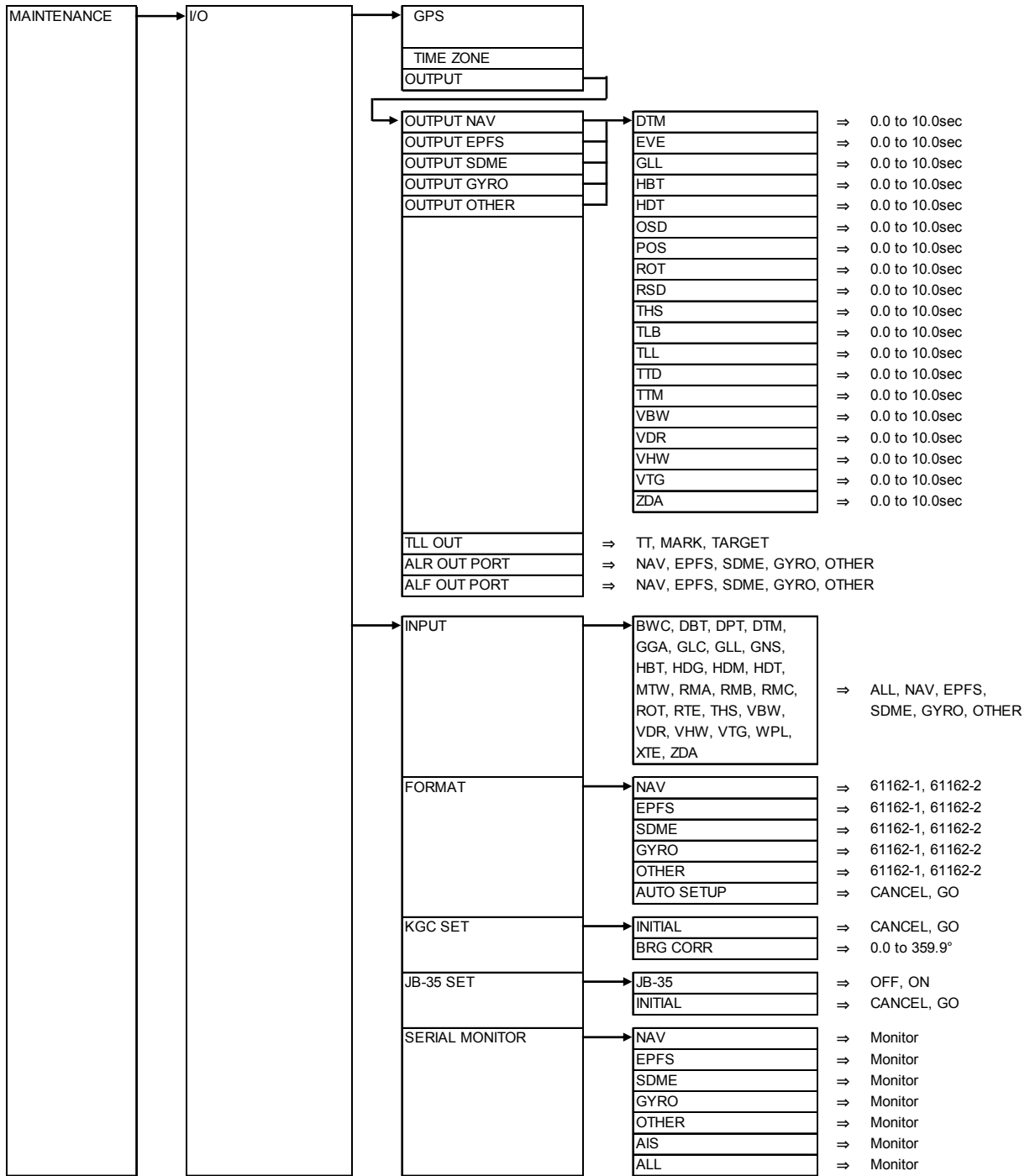

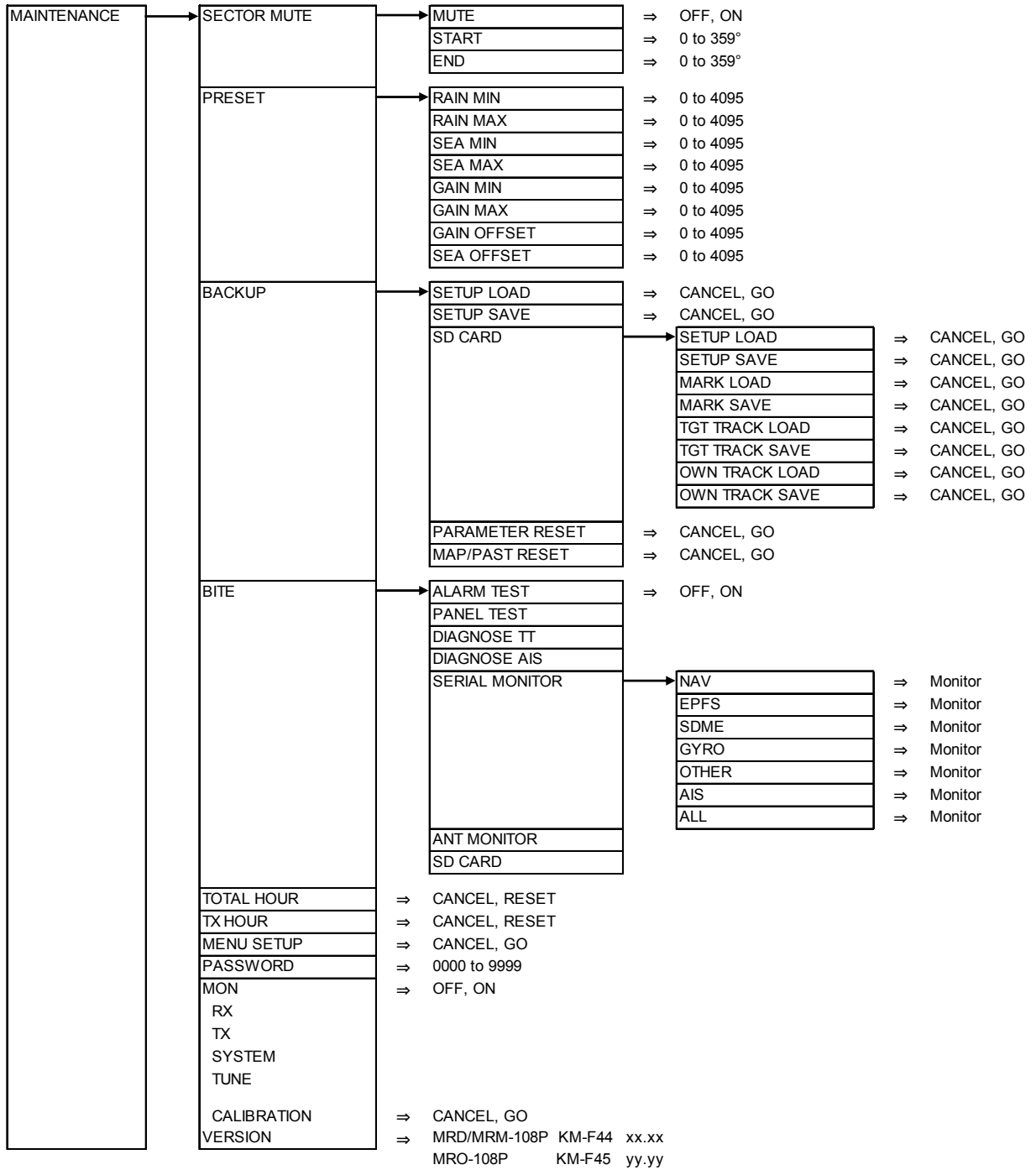

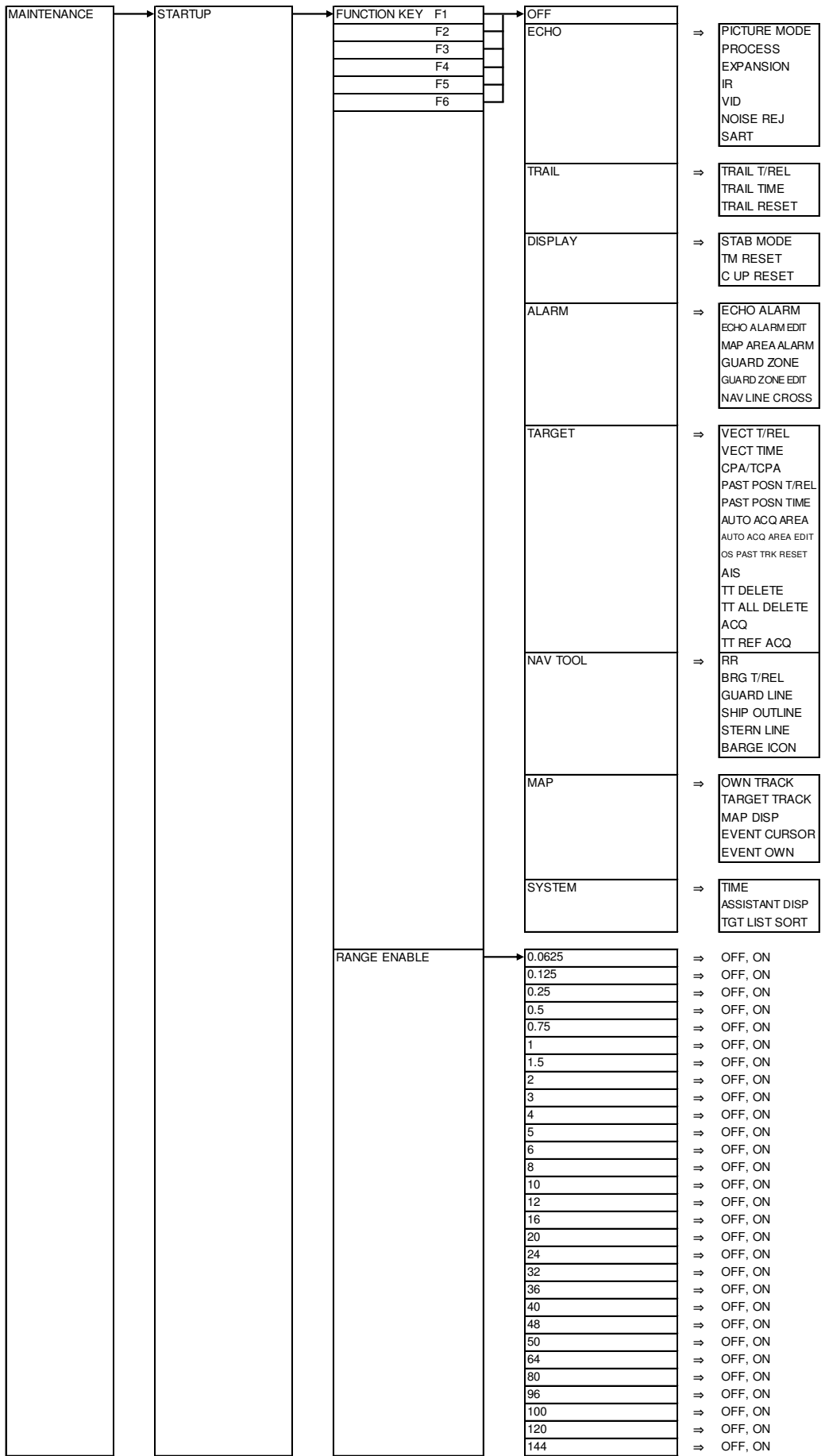

ALR	Set alarm state
<p>\$ -- ALR, <u>hhmmss.ss</u>, <u>xxx</u>, <u>A</u>, <u>A</u>, <u>c--c</u> *<u>hh</u><CR><LF></p> <p style="margin-left: 100px;"> Time of alarm condition change, UTC </p> <p style="margin-left: 150px;"> Alarm condition (A=threshold exceeded, V=not exceeded) </p> <p style="margin-left: 150px;"> Unique alarm number (identifier) at alarm source </p> <p style="margin-left: 200px;"> Alarm's description text </p> <p style="margin-left: 200px;"> Alarm's acknow ledge state, A=acknow ledged V=unacknow ledged </p> <p style="margin-left: 250px;"> Check sum </p>	

ACN	Alert command
<p>\$ -- ACN, <u>hhmmss.ss</u>, <u>aaa</u>, <u>x.x</u>, <u>x.x</u>, <u>c</u>, <u>a</u>*<u>hh</u><CR><LF></p> <p style="margin-left: 100px;"> Release time </p> <p style="margin-left: 150px;"> Alert identifier </p> <p style="margin-left: 150px;"> manufacture mnemonic code </p> <p style="margin-left: 200px;"> Alert instance, 1 to 999999 </p> <p style="margin-left: 200px;"> Alert command, A, Q, O or S* </p> <p style="margin-left: 250px;"> Sentence status flag: "C" </p> <p style="margin-left: 250px;"> Check sum </p> <p style="margin-left: 300px;"> Note* Alert command A: Acknow ledge Q: Request / repeat information O: Responsibility transfer S: Silence </p>	

ACK	Acknowledge alarm
<p>\$ -- ACK, <u>xxx</u> *<u>hh</u><CR><LF></p> <p style="margin-left: 100px;"> Unique alarm number (identifier) at alarm source </p> <p style="margin-left: 150px;"> Check sum </p>	

Heartbeat

HBT	Heartbeat supervision sentence
<p>\$ -- HBT, <u>x.x</u>, <u>A</u>, <u>x</u>*<u>hh</u><CR><LF></p> <p style="margin-left: 100px;"> Configured repeat interval </p> <p style="margin-left: 150px;"> Equipment status A=Yes, V=No </p> <p style="margin-left: 150px;"> Sequential sentence identifier </p> <p style="margin-left: 200px;"> Check sum </p>	

AIS target and own ship information

VDM	AIS VHF data-link message
<p>! -- VDM, <u>x</u>, <u>x</u>, <u>x</u>, <u>a</u>, <u>s-s</u>, <u>x</u>*<u>hh</u><CR><LF></p> <p style="margin-left: 100px;"> Sentence number, 1 to 9 </p> <p style="margin-left: 100px;"> Message number, 1 to 9 </p> <p style="margin-left: 100px;"> AIS channel (A/B) </p> <p style="margin-left: 100px;"> Encapsulated ITU-R M.1371 radio message (Message part, 6bit fields) </p> <p style="margin-left: 150px;"> Number of fill-bits, 0 to 5 </p> <p style="margin-left: 200px;"> Check sum </p> <p style="margin-left: 250px;"> Total number of sentences needed to transfer the message, 1 to 9 </p>	

Waypoint Bearing/Distance

RMB	Recommended minimum navigation information
	<p>\$ -- RMB, A, x.x, a, c-c, c-c, IIII.II, N/S, yyyy.yy, E/W, x.x, x.x, x.x, A, a*hh<CR><LF></p> <p> Status A=Valid V=Data Invalid Not used Direction to steer L/R Cross track error Destination w aypoint latitude, N/S Destination w aypoint ID Destination w aypoint longitude, E/W Not used Check sum Mode indicator A/D=valid E/M/S/N=invalid Bearing to destination, degrees nautical miles Range to destination, nautical miles </p>

BWC	Bearing and distance to waypoint – Great circle
	<p>\$ -- BWC, hhmmss.ss, IIII.II, N/S, yyyy.yy, E/W, x.x, T, x.x, M, x.x, N, c-c, a*hh<CR><LF></p> <p> UTC of observation Waypoint latitude N/S Waypoint longitude E/W Note* Mode indicator A/D=Valid E/M/S/N=Invalid Bearing, digrees true Bearing, digrees magnetic Distance, nautical miles Waypoint ID Check sum Mode indicator* </p>

Cross-track error, measured

RMB	Recommended minimum navigation information
	<p>\$ -- RMB, A, x.x, a, c-c, c-c, IIII.II, N/S, yyyy.yy, E/W, x.x, x.x, x.x, A, a*hh<CR><LF></p> <p> Status A=Valid V=Data Invalid Not used Direction to steer L/R Cross track error Destination w aypoint latitude, N/S Destination w aypoint ID Destination w aypoint longitude, E/W Not used Check sum Mode indicator A/D=valid E/M/S/N=invalid Bearing to destination, degrees nautical miles Range to destination, nautical miles </p>

XTE	Cross-track error, measured
	<p>\$ -- XTE, A, A, x.x, a, N, a*hh<CR><LF></p> <p> Check sum Mode indicator A/D=Valid, E/M/S/N=Invalid Direction to steer, L/R Magnitude of cross-track error Status: A=data valid, V=LORAN-C cycle lock w arning flag Status: A=data valid, V=invalid </p>

11.4 Details of the radar data output

Data standard name: IEC61162-1 or IEC61162-2

Own ship data and radar system data are provided via data connectors (NAV/EPFS/SDME) on the back panel.

Radar system data

RSD	Radar system data
	<p>\$ - RSD, x.x, x.x, x.x, x.x, x.x, x.x, x.x, x.x, x.x, x.x, x.x, a, a*hh<CR><LF></p> <p>Origin 1 Bearing, VRM1 Bearing, EBL1 Bearing, Origin2 Range, VRM2 Bearing, EBL2 Bearing, Cursor range, Cursor Bearing, Display Range, Range unit (K=km/h, N=NM, S=SM/h), Display mode (C=Course up, H=Head up, N=North up), Check sum</p>

Own ship data

OSD	Own ship data
	<p>\$RAOSD, x.x, A, x.x, a, x.x, a, x.x, x.x, a*hh<CR><LF></p> <p>Heading, degrees true, Vessel course, degrees true, Course reference, B/M/W/R/P*, Vessel speed, Vessel set, degrees true, Speed reference, B/M/W/R/P*, Vessel drift (speed), Speed unit, K=km/h, N=knots, S=statute miles/h, Check sum, Note* Reference (B=Bottom tracking log, M=Manually entered, W=Water referenced, R=Radar tracking (or fixed target), P=Positioning system ground reference)</p>

Target latitude and longitude

TLL	Target latitude and longitude
	<p>\$ RATLL, xx, llll.ll, N/S, yyyy.yy, E/W, c-c, hhmmss.ss, a, a*hh<CR><LF></p> <p>Target number (00-99), Target latitude N/S, Target longitude E/W, Target label, UTC of data, Reference target=R, null otherwise, Target status L=Lost, Q=Query, T=Tracking, Check sum</p>

ACK	Acknowledge alarm
	<p>\$ -- ACK, <u>xxx</u> <u>*hh</u><CR><LF></p> <p style="margin-left: 100px;"> </p> <p style="margin-left: 100px;">Unique alarm number (identifier) at alarm source Check sum</p>

Heartbeat

HBT	Heartbeat supervision sentence
	<p>\$ -- HBT, <u>x.x</u>, <u>A</u>, <u>x*hh</u><CR><LF></p> <p style="margin-left: 100px;"> </p> <p style="margin-left: 100px;">Configured repeat interval Equipment status Sequential sentence identifier Check sum</p> <p style="margin-left: 150px;">A=Yes, V=No</p>

Event message

EVE	General event message
	<p>\$ -- EVE, <u>hhmmss.ss</u>, <u>c--c</u>, <u>c--c*hh</u><CR><LF></p> <p style="margin-left: 100px;"> </p> <p style="margin-left: 100px;">Event time Tag code used for identification of source of event Event description Check sum</p>

11.5 Interface specification

11.5.1 NAV and EPFS serial data input/output specification

Input connector: J3 and J5

Connector used: BD-06PMMP-LC7001

Connector acceptable: BD-06BFFA-LL6001

Data connector pin assignment

J3 and J5
Data connector pin assignment
(Display unit upper view)

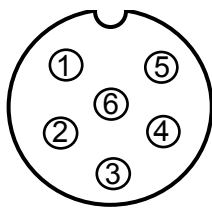

J3 and J5	
Pin number	Signal name
1	Shield
2	OUT-A
3	OUT-B
4	IN-A
5	IN-B
6	+12V

Note: +12V of pin no.6 is used for power supply of Junction box JB-35 or other device

Serial data input (Listener):

Standard-type signal conforming to IEC61162-1 or IEC 61162-2 is acceptable.

Input load: 500 Ohm

Circuit configuration: Photo coupler

Type ACPL-M61 (Avago)

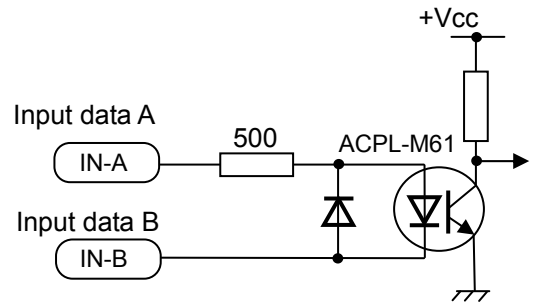

Serial data input circuit

Serial data output (Talker):

Standard-type signal conforming to IEC61162-1 or IEC 61162-2 is transmittable.

Circuit configuration: RS422 driver IC

Type SN65HVD3085 (TI)

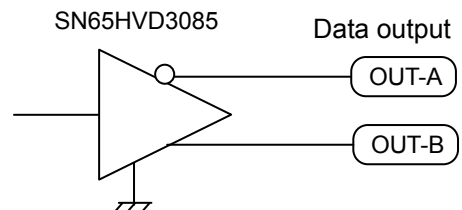

Serial data output circuit

11.5.2 SDME serial data input/output specification

Input connector: J6

Connector used: BD-06PMMP-LC7001

Connector acceptable: BD-06BFFA-LL6001

J6
Data connector pin assignment
(Display unit upper view)

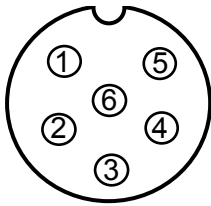

Data connector pin assignment

J6	
Pin number	Signal name
1	Shield
2	OUT-A
3	OUT-B
4	IN-A
5	IN-B
6	NC

Serial data input (Listener):

Standard-type signal conforming to IEC61162-1 or IEC 61162-2 is acceptable.

Input load: 500 Ohm

Circuit configuration: Photo coupler

Type ACPL-M61 (Avago)

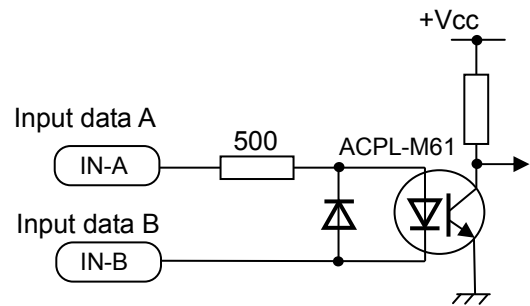

Serial data input circuit

Serial data output (Talker):

Standard-type signal conforming to IEC61162-1 or IEC 61162-2 is transmittable.

Circuit configuration: RS422 driver IC

Type SN65HVD3085 (TI)

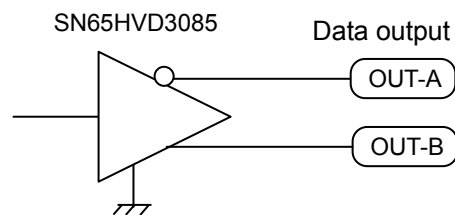

Serial data output circuit

11.5.3 VDR (external monitor) and Alarm output signal specification

Output connector name: VDR & Alarm

Connector used: BU-10PMMP-LC7001

Connector acceptable: BU-10BFFA-LL7001

Pin location is shown below.

J1
External monitor and alarm output connector pin assignment
(Display unit upper view)

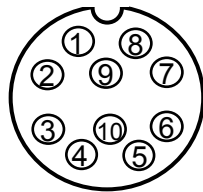

External monitor and alarm output connector pin assignment

Pin number	Signal name
1	RVD
2	R-GND
3	GVD
4	G-GND
5	BVD
6	B-GND
7	H-SYNC
8	V-SYNC
9	ALARM
10	ALARM

Signal specification

This RGB output is compliant with the image test defined in the VDR test standard IEC61996.

VDR output cannot be deactivated by the user.

Signal name	Frequency	Polarity	Signal width	Level	Impedance
Horizontal sync signal (H-SYNC)	63.981 kHz	Negative	1.037 μ s	TTL	200 Ω
Vertical sync signal (V-SYNC)	60.0 Hz	Negative	47 μ s	TTL	200 Ω
R, G, B Video signal	-	Positive	-	0.7 V p-p	75 Ω
Alarm output	-	-	Contact*	-	Capacity 1A

* Alarm contact will open in case of failure.

Circuit for horizontal sync, vertical sync signal output

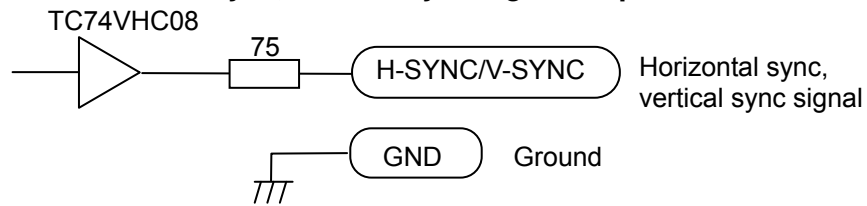

Circuit for R, G, B video signal output

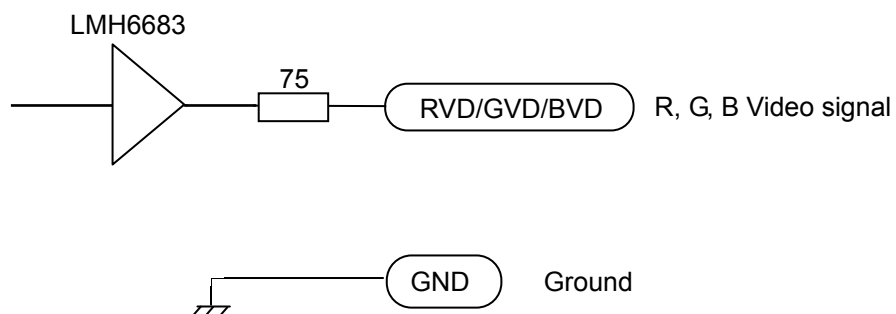

Alarm contact specification

Max. switching voltage 30 V
 Max. current capacity 1 A
 (Resistive load)

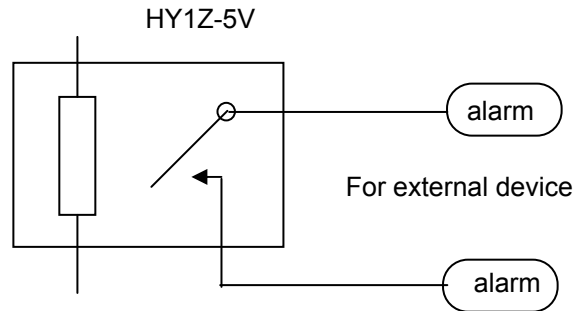

Note: Alarm contact will open in case of failure.

11.5.4 Serial data input/output specification (AIS)

I/O connector AIS (J2)

Connector used: BD-08PMMP-LC7001
 Connector acceptable: BD-08BFFA-LL6001

Serial data input (Listener):

Standard signals conforming to IEC61162-2 is acceptable.

Input load 500 Ohm
 Circuit configuration: Photo coupler
 Type ACPL-M61 (Avago)

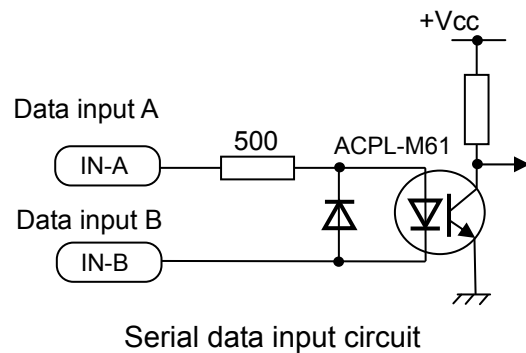

Serial data output circuit (Talker):

Standard signals conforming to IEC61162-2 can be output.

Circuit configuration: RS422 Driver/Receiver IC
 Type SN65HVD3085 (TI)

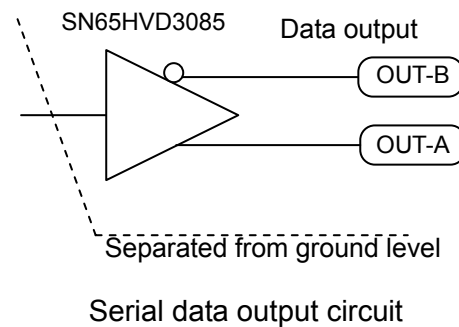

J2
 Data connector pin assignment
 (Display unit upper view)

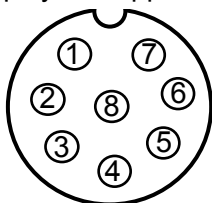

Data connector pin assignment

Pin number	Signal name
1	Shield
2	IN-A
3	IN-B
4	OUT-B
5	OUT-A
6	GND
7	NC
8	NC

Note: Pin 7 and pin 8 are used for error detection input signal for AIS system. It denotes [Short: Normal, Open: Error]. Please short #7 and #8 pin at AIS normal state.

11.5.5 Radar input/output signal specification

I/O connector: Inter-switch (J8)

Connector used: BU-12PMMP-LC7001

Connector acceptable: BU-12BFFA-LL7001

J8
Inter-switch connector pin assignment
(Display unit upper view)

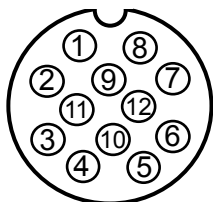

Data connector pin assignment

Pin number	Signal name
1	VIDEO OUT
2	TRIG OUT
3	GND
4	AZIP OUT
5	SHF OUT
6	GND
7	VIDEO IN
8	TRIG IN
9	GND
10	AZIP IN
11	SHF IN
12	+12VDC

Chapter 12 Index

A

ACTIVE/SLEEP	4-10
AIS	4-9
AIS auto ACQ.....	4-13
AIS FILTER	4-12
AIS ID DISP	4-4
AIS target symbol.....	4-14
Alarm	3-1
Alarm display	1-6
Alarm History list.....	3-13
Alarm list	3-12, 9-10
Antenna position mark	2-49
AREA	6-11
ASSOCIATION.....	4-6
AUTO ACQ AREA.....	4-7
AUTO GAIN	2-6
AUTO SEA.....	2-8
Automatic acquisition area.....	4-7

B

BACKUP	7-5
Barge icon.....	5-3
Bearing mode.....	2-25
Brightness	2-30
Brilliance	2-2

C

C UP	2-15
CAUTION.....	1-7
CCRP.....	2-48
CFAR	2-11
COAST LINE.....	6-3
Course up	2-15
CPA/TCPA	4-3
CROSS	2-45

Cursor	2-22, 2-46
Cursor Access.....	1-11
Cursor data	2-46

D

DATUM	6-13
Day/Night.....	2-30
Delete all TT target	4-19
Delete TT target	4-19
Display center	2-48
Display Mode	2-14
DUAL MASTER	2-45
DUAL SLAVE	2-45

E

EBL.....	2-23
EBL OFFSET	2-24
Echo alarm.....	3-1
Echo color.....	2-30
Echo color rejection	2-40
Electronic bearing lines.....	2-23
ERBL	2-28
EVENT MKR.....	6-10
Expansion	2-38
External buzzer	7-3
External save	7-6

F

Fault diagnosis.....	9-1
FERRY MODE	2-51
Function key	2-35

G

GAIN	2-6
GPS BUOY	6-15
Ground stabilization	2-20

Guard line..... 5-1
 Guard zone alarm 3-7

H

H UP2-14
 Head up.....2-14
 Heading line2-31
 HELP window..... 7-4
 HISTORY LIST.....3-13
 HL blink 5-2
 How to update 7-8

I

ID DISP SIZE 4-5
 INDEPENDENT MASTER.....2-44
 INDEPENDENT SLAVE2-44
 Input range 4-5
 Internal save..... 7-5
 Inter-switch.....2-44
 IR2-39

L

LIST3-12
 LOST ALARM..... 4-3

M

MAINTENANCE1-11, 7-5
 MAINTENANCE menu 1-11
 MAN GAIN 2-6
 MAN SEA..... 2-8
 Manual acquisition4-18
 MAP 6-1
 Map area..... 3-3
 MENU1-10
 MMSI.....4-11
 MON.....2-47
 MONITOR2-45
 MONITORED ROUTE.....6-12

N

N UP2-16
 NAV LINE6-8
 Nav line cross3-8
 Noise rejection2-40
 North up2-16

O

Off Center2-34
 Off-centering2-34
 Own ship outline2-50
 OWN SHIP PAST TRACK.....6-1
 Own ship profile2-50

P

Panel brilliance.....2-2
 Parallel Index (PI) lines2-26
 Parameter reset7-6
 PASSWORD 1-11
 Past position4-8
 PAST POSN.....4-8
 PATH PREDICTOR.....4-2
 Performance monitor.....2-47
 PI2-26
 Picture mode.....2-36
 POWER ON/OFF2-1
 Priority.....3-12
 Process2-37
 Pulse width..... 2-13, 2-41
 Pulse width (SP/LP)2-13

R

Radar Beacons2-42
 Radar Display 1-1
 Radar Enhancer.....2-42
 RAIN2-10
 RAIN MAN2-12
 Rain/snow clutter.....2-10



Koden Electronics Co., Ltd.

Tamagawa Office:

2-13-24 Tamagawa, Ota-ku, Tokyo, 146-0095 Japan

Tel: +81-3-3756-6501 Fax: +81-3-3756-6509

Uenohara Office:

5278 Uenohara, Uenohara-shi, Yamanashi, 409-0112 Japan

Tel: +81-554-20-5860 Fax: +81-554-20-5875

www.koden-electronics.co.jp