

Kramer Electronics, Ltd.



USER MANUAL

Model:

VS-66HDCP

6 x 6 DVI Matrix Switcher

Contents

1	Introduction	1
2	Getting Started	1
2.1	Quick Start	2
3	Overview	3
3.1	About HDCP	3
3.2	Recommendations for Best Performance	4
4	Your VS-66HDCP	4
4.1	Using the IR Transmitter	7
5	Installing the VS-66HDCP in a Rack	8
6	Connecting the VS-66HDCP 6 x 6 DVI Matrix Switcher	9
7	Operating the VS-66HDCP 6 x 6 DVI Matrix Switcher	10
7.1	Routing Inputs to Outputs	11
7.2	Disconnecting the Outputs	11
7.3	Storing and Recalling a Setup	11
7.4	Acquiring the EDID	12
7.4.1	Acquiring an EDID from a Single Connected Output	12
7.4.2	Acquiring an EDID from Several Sets of Inputs and Outputs	12
7.4.3	Acquiring an EDID from Several Connected Outputs Automatically	13
7.4.4	Acquiring the Default EDID	14
7.5	Connecting to the VS-66HDCP via RS-232	14
7.6	Operating via the ETHERNET	14
7.6.1	Connecting the ETHERNET Port directly to a PC (Crossover Cable)	14
7.6.2	Connecting the ETHERNET Port via a Network Hub (Straight-Through Cable)	16
7.6.3	Control Configuration via the Ethernet Port	16
8	Technical Specifications	16
9	Default Communication Parameters	17
10	Hex Table	17
11	Kramer Protocol 2000	18

Figures

Figure 1:	VS-66HDCP 6 x 6 DVI Matrix Switcher Front and Rear Views	5
Figure 2:	Connecting the VS-66HDCP 6 x 6 DVI Matrix Switcher	10
Figure 3:	SELECTOR Buttons	11
Figure 4:	Local Area Connection Properties Window	15
Figure 5:	Internet Protocol (TCP/IP) Properties Window	15

Tables

Table 1: VS-66HDCP 6 x 6 DVI Matrix Switcher Front Panel Features	6
Table 2: VS-66HDCP 6 x 6 DVI Matrix Switcher Rear Panel Features	6
Table 3: VS-66HDCP Technical Specifications	16
Table 4: Default Communication Parameters	17
Table 5: VS-66HDCP Hex Codes for Switching via RS-232/RS-485	17
Table 6: Protocol Definitions	18
Table 7: Instruction Codes for Protocol 2000	19

1 Introduction

Welcome to Kramer Electronics! Since 1981, Kramer Electronics has been providing a world of unique, creative, and affordable solutions to the vast range of problems that confront the video, audio, presentation, and broadcasting professional on a daily basis. In recent years, we have redesigned and upgraded most of our line, making the best even better! Our 1,000-plus different models now appear in 11 groups¹ that are clearly defined by function.

Thank you for purchasing the Kramer **VS-66HDCP 6 x 6 DVI Matrix Switcher**, which is ideal for conference room presentations and advertising applications, as well as for rental and staging.

Each package includes the following items:

- The **VS-66HDCP 6 x 6 DVI Matrix Switcher**
- Power cord²
- Windows[®]-based Kramer control software³
- Windows[®]-based Ethernet Configuration Manager and Virtual Serial Port Manager
- Kramer **RC-IR3 Infrared Remote Control Transmitter** (including the required batteries and a separate user manual⁴)
- This user manual⁴

2 Getting Started

We recommend that you:

- Unpack the equipment carefully and save the original box and packaging materials for possible future shipment
- Review the contents of this user manual
- Use Kramer high-performance high resolution cables⁵

1 GROUP 1: Distribution Amplifiers; GROUP 2: Switchers and Matrix Switchers; GROUP 3: Control Systems; GROUP 4: Format/Standards Converters; GROUP 5: Range Extenders and Repeaters; GROUP 6: Specialty AV Products; GROUP 7: Scan Converters and Scalers; GROUP 8: Cables and Connectors; GROUP 9: Room Connectivity; GROUP 10: Accessories and Rack Adapters; GROUP 11: Sierra Products

2 We recommend that you use only the power cord supplied with this device

3 Downloadable from our Web site at <http://www.kramerelectronics.com>

4 Download up-to-date Kramer user manuals from our Web site at <http://www.kramerelectronics.com>

5 The complete list of Kramer cables is on our Web site at <http://www.kramerelectronics.com>

2.1 Quick Start

This quick start chart summarizes the basic setup and operation steps.

Step 1: Mount the machine - see section 5

Mount the machine in a rack or stick the 4 rubber feet to the underside

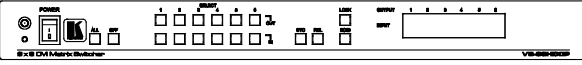

Step 2: Connect the Inputs and outputs - see section 6

Connect the Inputs and the outputs

If required, connect a PC or a controller via RS-232 or the ETHERNET to control the VS-66HDCP

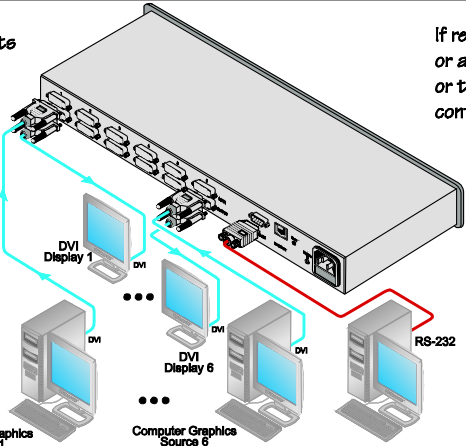

Step 3: Turn the power ON

Step 4: Set the machine - see section 7

<p>ROUTE AN INPUT TO AN OUTPUT</p> <p>Press an output key followed by an Input key to route this input to that output.</p> <p>ACQUIRE THE EDID FROM:</p> <ul style="list-style-type: none"> <input type="checkbox"/> A connected output <input type="checkbox"/> Several sets of Inputs and outputs <input type="checkbox"/> Several connected outputs <input type="checkbox"/> The default EDID 	<p>STORE AND RECALL A SETUP</p> <p>TO STORE:</p> <ol style="list-style-type: none"> 1. Set the machine to the desired setup. 2. Press the STO button. The STO button blinks. 3. Select an IN or OUT button to store the machine setup. 4. Press the LOCK button to store the current setup. <p>TO RECALL:</p> <ol style="list-style-type: none"> 1. Press the RCL button. The RCL button blinks. 2. Press the relevant OUT button. 3. Press the LOCK button to recall the stored setup.
--	---

Step 5: Operate the machine - see section 7

Operate via the front panel buttons, IR remote control, RS-232, and ETHERNET

3 Overview

The high quality Kramer **VS-66HDCP** is an HDCP compatible *6 x 6 DVI Matrix Switcher* that accepts up to six DVI inputs and routes the selected DVI¹ input signal to any or all of six DVI outputs.

The **VS-66HDCP** features:

- HDCP (High Bandwidth Digital Content Protection) support
- I-EDIDPro™ Kramer Intelligent EDID Processing™, an intelligent EDID handling and processing algorithm that ensures Plug and Play operation for DVI systems
- An OFF button to disconnect an output
- A PANEL LOCK button to prevent unwanted tampering with the buttons on the front panel
- 12 preset memory locations for quick access to common configurations
- 1U height to fit into a standard 19” professional rack enclosure

Control the **VS-66HDCP** using the front panel buttons, or remotely via:

- RS-232 serial commands transmitted by a touch screen system, PC, or other serial controller
- The Kramer infrared remote control transmitter
- The ETHERNET
- An external remote IR receiver (optional), see section [4.1](#)

3.1 About HDCP

The High-Bandwidth Digital Content Protection (HDCP) standard (developed by Intel), protects digital video and audio signals transmitted over DVI or DVI connections between two HDCP-enabled devices to eliminate the reproduction of copyrighted material. To protect copyright holders (such as movie studios) from having their programs copied and shared, the HDCP standard provides for the secure and encrypted transmission of digital signals.

¹ DVI-D (Digital). Note that only the digital signal (DVI-D) is available on the DVI connector

3.2 Recommendations for Best Performance

To achieve the best performance:

- Use only high-quality connection cables¹ to avoid interference, deterioration in signal quality due to poor matching, and elevated noise levels (often associated with low quality cables).
- Avoid interference from neighboring electrical appliances that may adversely influence signal quality and position your Kramer **VS-66HDCP** away from moisture, excessive sunlight, and dust

4 Your VS-66HDCP

[Figure 1](#), [Table 1](#), and [Table 2](#) define the unit.

¹ Available from Kramer Electronics on our Web site at <http://www.kramerelectronics.com>

Your VS-66HDCP

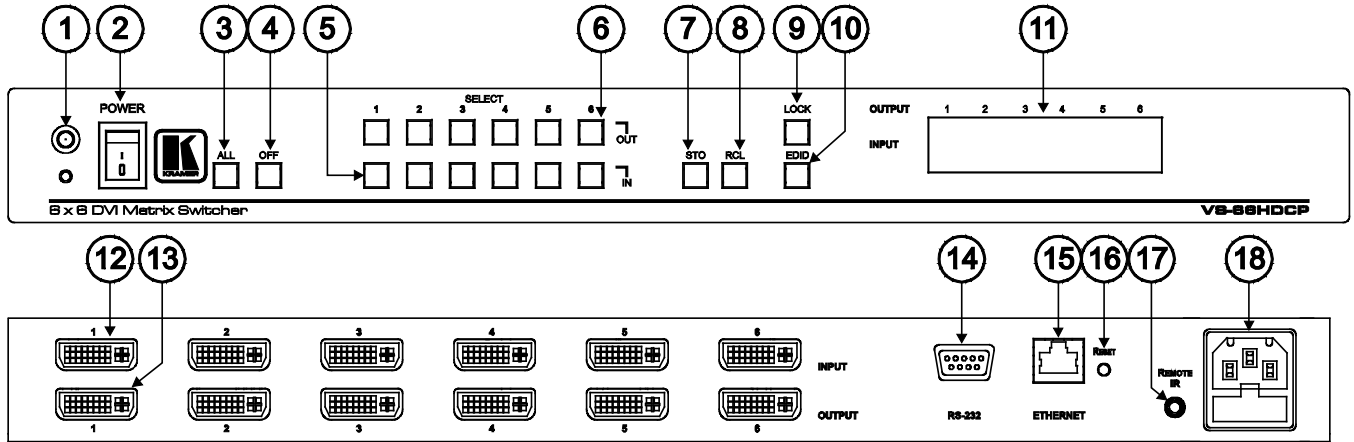

Figure 1: VS-66HDCP 6 x 6 DVI Matrix Switcher Front and Rear Views

Table 1: VS-66HDCP 6 x 6 DVI Matrix Switcher Front Panel Features

#	Feature	Function
1	IR Receiver LED	The red LED is illuminated when receiving signals from the Infrared remote control transmitter
2	POWER Switch	Illuminated switch for turning the unit ON or OFF
3	ALL Button	Use ALL to select all inputs or all outputs (see section 7.1)
4	OFF Button	Use OFF to disconnect one or all outputs (see section 7.2)
5	SELECT IN Buttons	Press an INPUT selector button to select an input (from 1 to 6)
6	SELECT OUT Buttons	Press an OUTPUT selector button to select an output (from 1 to 6)
7	STO Button	Press to store an input setup
8	RCL Button	Press to recall an input setup
9	LOCK Button	Press to toggle disengaging the front panel buttons and to acquire the EDID (see section 7.1)
10	EDID Button ¹	Press to acquire the EDID
11	7-segment Display	Displays the selected audio or video input switched to the output (marked above each input)

Table 2: VS-66HDCP 6 x 6 DVI Matrix Switcher Rear Panel Features

#	Feature	Function
12	INPUT DVI Connectors	Connect to the DVI sources (from 1 to 6)
13	OUTPUT DVI Connectors	Connect to the DVI acceptors (from 1 to 6)
14	RS-232 DB-9F Port	Connects to the PC or the RS-232 Remote Controller
15	ETHERNET Connector	Connects to the PC or other Ethernet Controller
16	RESET Button	Press the reset button to reset to the ETHERNET factory default definitions ² : IP number – 192.168.1.39 Mask – 255.255.255.0 Gateway – 192.168.1.1
17	REMOTE IR 3.5mm Connector	Connect to an external IR receiver unit for controlling the machine via an IR remote controller (instead of using the front panel IR receiver)
18	Power Connector with Fuse	AC connector enabling power supply to the unit

¹ Illuminates when configuring the EDID

² First disconnect the power cord and then connect it again while pressing the RESET button. The unit will power up and load its memory with the factory default definitions

4.1 Using the IR Transmitter

You can use the **RC-IR3** IR transmitter to control the machine via the built-in IR receiver on the front panel or, instead, via an optional external IR receiver¹. The external IR receiver can be located up to 15 meters away from the machine. This distance can be extended to up to 60 meters when used with three extension cables². Before using the external IR receiver, be sure to arrange for your Kramer dealer to insert the internal IR connection cable³ with the 3.5mm connector that fits into the REMOTE IR opening on the rear panel. Connect the external IR receiver to the REMOTE IR 3.5mm connector.

1 Model: C-A35M/IRR-50

2 Model: C-A35M/A35F-50

3 P/N: 505-70434010-S

5 Installing the VS-66HDCP in a Rack

This section provides instructions for rack mounting the unit.

Before Installing in a Rack

Before installing in a rack, be sure that the environment is within the recommended range:

Operating temperature range	+5° to +45° C (41° to 113° F)
Operating humidity range	10 to 90% RHL, non-condensing
Storage temperature range	-20° to +70° C (-4° to 158° F)
Storage humidity range	5 to 95% RHL, non-condensing



CAUTION!

When installing on a 19" rack, avoid hazards by taking care that:

1. It is located within the recommended environmental conditions, as the operating ambient temperature of a closed or multi unit rack assembly may exceed the room ambient temperature.
2. Once rack mounted, enough air will still flow around the machine.
3. The machine is placed straight in the correct horizontal position.
4. You do not overload the circuit(s). When connecting the machine to the supply circuit, overloading the circuits might have a detrimental effect on overcurrent protection and supply wiring. Refer to the appropriate nameplate ratings for information. For example, for fuse replacement, see the value printed on the product label.
5. The machine is earthed (grounded) in a reliable way and is connected only to an electricity socket with grounding. Pay particular attention to situations where electricity is supplied indirectly (when the power cord is not plugged directly into the socket in the wall), for example, when using an extension cable or a power strip, and that you use only the power cord that is supplied with the machine.

How to Rack Mount

To rack-mount a machine:

1. Attach both ear brackets to the machine. To do so, remove the screws from each side of the machine (3 on each side), and replace those screws through the ear brackets.

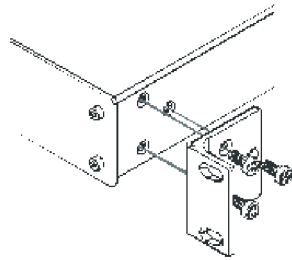

2. Place the ears of the machine against the rack rails, and insert the proper screws (not provided) through each of the four holes in the rack ears.

Note:

- In some models, the front panel may feature built-in rack ears
- Detachable rack ears can be removed for desktop use
- Always mount the machine in the rack before you attach any cables or connect the machine to the power
- If you are using a Kramer rack adapter kit (for a machine that is not 19"), see the Rack Adapters user manual for installation instructions available from: <http://www.kramerelectronics.com>

6 Connecting the VS-66HDCP 6 x 6 DVI Matrix Switcher

To connect the **VS-66HDCP**, as the example in [Figure 2](#) illustrates, do the following¹:

1. Connect up to six DVI sources² (for example, computer graphics sources) to the SELECT IN DVI connectors.
2. Connect the SELECT OUT DVI connectors to up to six DVI acceptors³ (for example, DVI displays).
3. If required, connect a PC and/or controller to the RS-232 port (see section [7.5](#)) and/or the ETHERNET port (see section [7.6](#)).
4. Connect the power cord (not shown in [Figure 2](#)).
5. If required, acquire the EDID (see section [7.4](#)).

1 Switch OFF the power on each device before connecting it to your VS-66HDCP. After connecting your VS-66HDCP, switch on its power and then switch on the power on each device

2 You do not have to connect all the sources

3 You do not have to connect all outputs

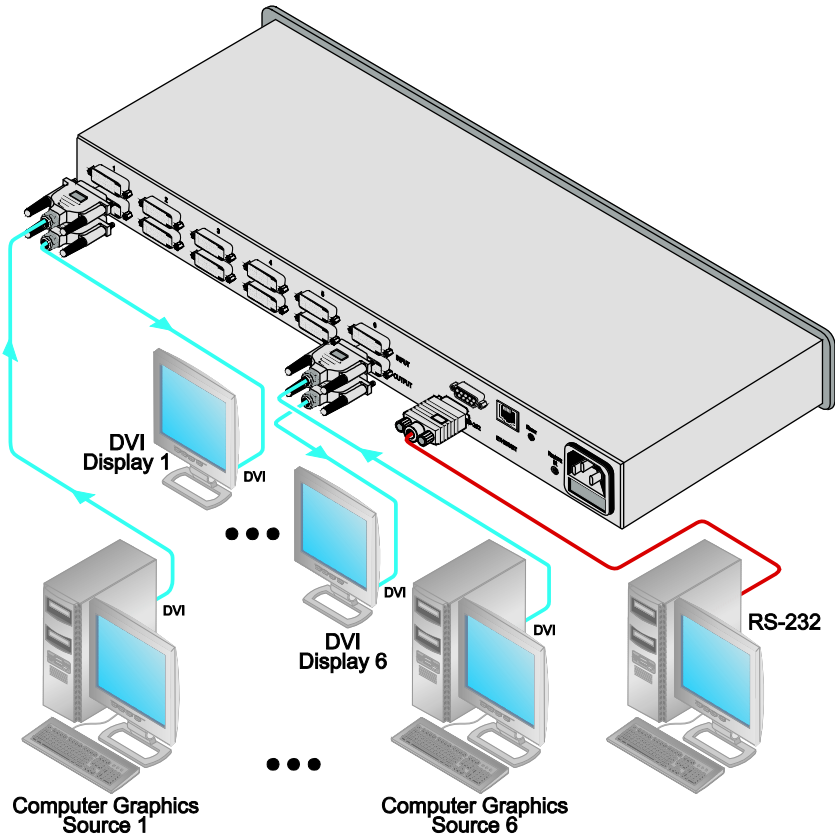

Figure 2: Connecting the VS-66HDCP 6 x 6 DVI Matrix Switcher

7 Operating the VS-66HDCP 6 x 6 DVI Matrix Switcher

This section describes how to:

- Route inputs to outputs (see section [7.1](#))
- Disconnecting outputs (see section [7.2](#))
- Store and recall a setup (see section [7.3](#))
- Acquire the EDID (see section [7.4](#))
- Control the machine via RS-232 (see section [7.5](#))
- Control the machine via the ETHERNET port (see section [7.6](#))

7.1 Routing Inputs to Outputs

To route an input to an output:

- Press an OUT key, followed by an IN key to route this input to that output

To route one input to all outputs:

- Press ALL followed by an IN button. The input is routed to all outputs

7.2 Disconnecting the Outputs

To disconnect one output:

- Press the OUT button of the output to disconnect and press OFF

To disconnect all outputs at once:

- Press the ALL button and then press OFF. This disconnects all the outputs

7.3 Storing and Recalling a Setup

You can use the STO and RCL buttons to store up to 12 setups¹ and then recall them, as [Figure 3](#) illustrates:

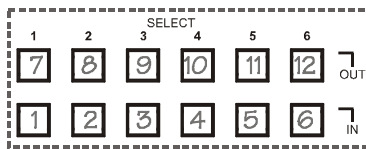

Figure 3: SELECTOR Buttons²

To store a setup:

1. Set the machine to the desired setup.
For example, press the OUT 3 button and IN 4 button³.
2. Press the STO button.
The STO button flashes.
3. Select an OUT or IN SELECT button to store the machine setup (for example, OUT 5).
4. Press the LOCK button⁴ to store the current setup.
In this example, the OUT 5 button stores the setup.

¹ IN 1 is used for setup # 1 and OUT 1 is used for setup # 7

² The gray numbers (1 to 12) in [Figure 3](#) that illustrate the corresponding store/recall configuration numbers, are for the purpose of illustration only and do not actually appear on the buttons

³ You can set all the switcher IN-OUT buttons

⁴ You have to press the LOCK button within 10 seconds, before the store operation times out

To recall a setup:

1. Press the RCL button.
The RCL button flashes.
2. Press the relevant OUT or IN button that stored the setup.
In this example, press OUT 5.
3. Press the LOCK button to recall the stored setup.

7.4 Acquiring the EDID

You can acquire the EDID from:

- A single connected output (see section [7.4.1](#))
- Several sets of inputs and outputs (see section [7.4.2](#))
- Several connected outputs automatically (see section [7.4.3](#))
- The default EDID (see section [7.4.4](#))

7.4.1 Acquiring an EDID from a Single Connected Output

To acquire or change the EDID of a new output display:

1. Turn ON the **VS-66HDCP**.
2. Connect the required acceptor to the output from which you want to acquire the EDID.
3. Press the EDID and STO buttons simultaneously and hold them for 3 seconds.
Both buttons flash.
4. Press the IN SELECTOR button to which the EDID will be copied.
The selected input number flashes on the display.
5. Select the OUT SELECTOR button from which the EDID will be acquired.
6. Press the EDID button.
The process is complete when the display returns to normal.

7.4.2 Acquiring an EDID from Several Sets of Inputs and Outputs

To acquire the EDID from several sets of inputs and outputs (for example, OUT 1 to IN 1 and OUT 6 to IN 3), do the following:

1. Power ON the **VS-66HDCP**.
2. Connect the required acceptors to the outputs from which you want to acquire the EDID.
3. Press the EDID and STO buttons simultaneously and hold them for 3 seconds.
Both buttons flash.

4. Press the SELECT IN button to which the first EDID will be copied (for example, IN 1).
The selected input number flashes on the display.
5. Press the SELECT OUT button from which the first EDID will be acquired (for example, OUT 1).
6. Press the SELECT IN 1 button again.
The IN 1 button ceases to flash.
7. Press another SELECT IN to which the next EDID will be copied (for example, IN 3).
The selected input number flashes on the display.
8. Press the SELECT OUT button from which the next EDID will be acquired (for example, OUT 6).
9. Press the SELECT IN 3 button again.
The IN 3 button ceases to flash.
10. Press the SELECT IN buttons to which you want to copy the EDID (for example, IN 1 and IN 3).
11. Make sure that the relevant input numbers flash on the display.
12. Press the EDID button.
The process is complete when the display returns to normal.

7.4.3 Acquiring an EDID from Several Connected Outputs Automatically

To automatically acquire or change the EDID of several output displays¹:

1. Turn ON the **VS-66HDCP**.
2. Connect the required acceptors to the outputs from which you want to acquire the EDID.
3. Press the EDID and STO buttons simultaneously and hold them for 3 seconds.
Both buttons flash.
4. Press the SELECT IN button to which the EDID will be copied.
The selected input number flashes on the display.
5. Press the OFF button until a “–” (hyphen) appears on the display.
6. Press the EDID button.
The process is complete when the display returns to normal.

¹ The EDID acquired is a weighted average of all the connected outputs. For example, if several displays with different resolutions are connected to the outputs, the acquired EDID supports all the resolutions, as well as other parameters included in the EDID

7.4.4 Acquiring the Default EDID

To reset to the default EDID, do the following:

1. Turn ON the **VS-66HDCP**.
2. Press the EDID and STO buttons simultaneously and hold them for 3 seconds.
Both buttons flash.
3. Press the SELECT IN button to which the EDID will be copied.
The selected input number flashes on the display.
4. Press the OFF button until a "0" (zero) appears on the display.
5. Press the EDID button.
The process is complete when the display returns to normal.

7.5 Connecting to the VS-66HDCP via RS-232

You can connect to the **VS-66HDCP** via an RS-232 connection using, for example, a PC. Note that a null-modem adapter/connection is not required.

To connect to the **VS-66HDCP** via RS-232:

- Connect the RS-232 9-pin D-sub rear panel port on the **VS-66HDCP** unit via a 9-wire straight cable (only pin 2 to pin 2, pin 3 to pin 3, and pin 5 to pin 5 need to be connected) to the RS-232 9-pin D-sub port on your PC

7.6 Operating via the ETHERNET

You can connect the **VS-66HDCP** via the Ethernet, using a crossover cable (see section [7.6.1](#)) for direct connection to the PC or a straight-through cable (see section [7.6.2](#)) for connection via a network hub or network router¹.

7.6.1 Connecting the ETHERNET Port directly to a PC (Crossover Cable)

You can connect the Ethernet port of the **VS-66HDCP** to the Ethernet port on your PC, via a crossover cable with RJ-45 connectors.

This type of connection is recommended for identifying the **VS-66HDCP** with the factory configured default IP address

¹ After connecting the Ethernet port, you have to install and configure your Ethernet Port. For detailed instructions, see the "Ethernet Configuration (FC-11) guide.pdf" file in the technical support section on our Web site:
<http://www.kramerelectronics.com>

After connecting the Ethernet port, configure your PC as follows:

1. Right-click the My Network Places icon on your desktop.
2. Select **Properties**.
3. Right-click Local Area Connection Properties.
4. Select **Properties**.
The Local Area Connection Properties window appears.
5. Select the Internet Protocol (TCP/IP) and click the **Properties** Button (see [Figure 4](#)).

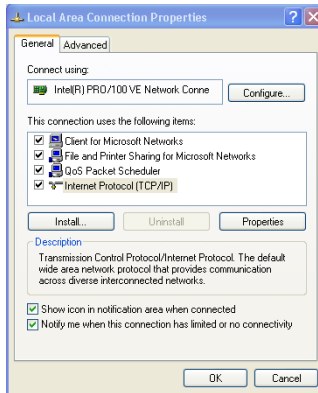

Figure 4: Local Area Connection Properties Window

6. Select Use the following IP Address, and fill in the details as shown in [Figure 5](#).
7. Click **OK**.

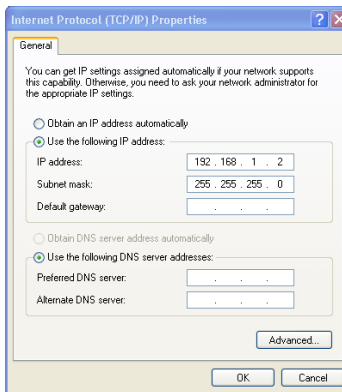

Figure 5: Internet Protocol (TCP/IP) Properties Window

7.6.2 Connecting the ETHERNET Port via a Network Hub (Straight-Through Cable)

You can connect the Ethernet port of the **VS-66HDCP** to the Ethernet port on a network hub or network router, via a straight through cable with RJ-45 connectors.

7.6.3 Control Configuration via the Ethernet Port

To control several units via the Ethernet, connect the Master unit (Machine # 1) via the Ethernet port to the LAN port of your PC. Use your PC initially to configure the settings (see section [7.6](#)).

8 Technical Specifications

The **VS-66HDCP** technical specifications are shown in [Table 3](#):

Table 3: VS-66HDCP Technical Specifications¹

INPUTS:	6 DVI connectors
OUTPUTS:	6 DVI connectors
BANDWIDTH:	Supports up to 1.65Gbps bandwidth per graphic channel
COMPLIANCE WITH STANDARDS:	Supports DVI 1.1 and HDCP
MAX RESOLUTION:	Up to UXGA; 1080p, 1920 x 1200
POWER SOURCE:	100–240VAC; 50/60Hz, 32VA
CONTROLS:	Front panel buttons, Infrared remote control transmitter, RS-232, Ethernet
DIMENSIONS:	19" x 9.4" x 1U W, D, H
WEIGHT:	2.5kg (5.5lbs) approx.
ACCESSORIES:	Power cord, IR transmitter
OPTIONS:	Kramer cables ² ; external remote IR receiver cable

¹ Specifications are subject to change without notice

² For best results, use Kramer cables the such as the C-HM/DM series

9 Default Communication Parameters

Table 4: Default Communication Parameters

RS-232	
Protocol 2000	
Baud Rate:	9600
Data Bits:	8
Stop Bits:	1
Parity:	None
Command Format:	HEX
Example (Output 1 to Input 1):	0x01, 0x81, 0x81, 0x81
Ethernet	
Default Settings	Reset Ethernet Default Settings
IP Address: 192.168.1.39	Power cycle the unit while holding in the Factory Reset button, located on the rear panel of the unit.
TCP Port #: 5000	

10 Hex Table

[Table 5](#) lists the Hex values for a single machine (MACHINE # 1):

Table 5: VS-66HDCP Hex Codes for Switching via RS-232/RS-485

	OUT 1	OUT 2	OUT 3	OUT 4	OUT 5	OUT 6
IN 1	01	01	01	01	01	01
	81	81	81	81	81	81
	81	82	83	84	85	86
	81	81	81	81	81	81
IN 2	01	01	01	01	01	01
	82	82	82	82	82	82
	81	82	83	84	85	86
	81	81	81	81	81	81
IN 3	01	01	01	01	01	01
	83	83	83	83	83	83
	81	82	83	84	85	86
	81	81	81	81	81	81
IN 4	01	01	01	01	01	01
	84	84	84	84	84	84
	81	82	83	84	85	86
	81	81	81	81	81	81
IN 5	01	01	01	01	01	01
	85	85	85	85	85	85
	81	82	83	84	85	86
	81	81	81	81	81	81
IN 6	01	01	01	01	01	01
	86	86	86	86	86	86
	81	82	83	84	85	86
	81	81	81	81	81	81

11 Kramer Protocol 2000

The **VS-66HDCP** is compatible¹ with Kramer's Protocol 2000² (version 0.50) (below). This RS-232/RS-485 communication protocol uses four bytes of information as defined below. The default data rate is 9600 baud, with no parity, 8 data bits and 1 stop bit.

Table 6: Protocol Definitions

MSB								LSB
	DESTINATION		INSTRUCTION					
0	D	N5	N4	N3	N2	N1	N0	
7	6	5	4	3	2	1	0	
1st byte								
	INPUT							
1	I6	I5	I4	I3	I2	I1	I0	
7	6	5	4	3	2	1	0	
2nd byte								
	OUTPUT							
1	O6	O5	O4	O3	O2	O1	O0	
7	6	5	4	3	2	1	0	
3rd byte								
	MACHINE NUMBER							
1	OVR	X	M4	M3	M2	M1	M0	
7	6	5	4	3	2	1	0	
4th byte								

1st BYTE: Bit 7 – Defined as 0.

D – “DESTINATION”: 0 - for sending information to the switchers (from the PC);

1 - for sending to the PC (from the switcher).

N5...N0 – “INSTRUCTION”

The function that is to be performed by the switcher(s) is defined by the INSTRUCTION (6 bits). Similarly, if a function is performed via the machine's keyboard, then these bits are set with the INSTRUCTION NO., which was performed. The instruction codes are defined according to the table below (INSTRUCTION NO. is the value to be set for N5...N0).

2nd BYTE: Bit 7 – Defined as 1.

I6...I0 – “INPUT”.

When switching (ie. instruction codes 1 and 2), the INPUT (7 bits) is set as the input number which is to be switched. Similarly, if switching is done via the machine's front-panel, then these bits are set with the INPUT NUMBER which was switched. For other operations, these bits are defined according to the table.

3rd BYTE: Bit 7 – Defined as 1.

O6...O0 – “OUTPUT”.

When switching (ie. instruction codes 1 and 2), the OUTPUT (7 bits) is set as the output number which is to be switched. Similarly, if switching is done via the machine's front-panel, then these bits are set with the OUTPUT NUMBER which was switched. For other operations, these bits are defined according to the table.

4th BYTE: Bit 7 – Defined as 1.

Bit 5 – Don't care.

OVR – Machine number override.

M4...M0 – MACHINE NUMBER.

Used to address machines in a system via their machine numbers. When several machines are controlled from a single serial port, they are usually configured together with each machine having an individual machine number. If the OVR bit is set, then all machine numbers will accept (implement) the command, and the addressed machine will reply.

1 You can download our user-friendly “Software for Calculating Hex Codes for Protocol 2000” from the technical support section on our Web site at: <http://www.kramerelectronics.com>

2 The instruction codes in [Table 7](#) are a sub-set of the Protocol 2000. You can find the full protocol on our Web site at <http://www.kramerelectronics.com>

Kramer Protocol 2000

For a single machine controlled via the serial port, always set M4...M0 = 1, and make sure that the machine itself is configured as MACHINE NUMBER = 1.

Table 7: Instruction Codes for Protocol 2000

Note: All values in the table are decimal, unless otherwise stated.

INSTRUCTION		DEFINITION FOR SPECIFIC INSTRUCTION		NOTE
#	DESCRIPTION	INPUT	OUTPUT	
0	RESET VIDEO	0	0	1
1	SWITCH VIDEO	Set equal to video input which is to be switched (0 = disconnect)	Set equal to video output which is to be switched (0 = to all the outputs)	2, 15
3	STORE VIDEO STATUS	Set as SETUP #	0 - to store 1 - to delete	2, 3, 15
4	RECALL VIDEO STATUS	Set as SETUP #	0	2, 3, 15
5	REQUEST STATUS OF A VIDEO OUTPUT	Set as SETUP #	Equal to output number whose status is reqd	4, 3
15	REQUEST WHETHER SETUP IS DEFINED / VALID INPUT IS DETECTED	SETUP # or Input #	0 - for checking if setup is defined 1 - for checking if input is valid	8
30	LOCK FRONT PANEL	0 - Panel unlocked 1 - Panel locked	0	2
31	REQUEST WHETHER PANEL IS LOCKED	0	0	16
61	IDENTIFY MACHINE	1 - video machine name 2 - audio machine name 3 - video software version 4 - audio software version 5 - RS422 controller name 6 - RS422 controller version 7 - remote control name 8 - remote software version 9 - Protocol 2000 revision	0 - Request first 4 digits 1 - Request first suffix 2 - Request second suffix 3 - Request third suffix 10 - Request first prefix 11 - Request second prefix 12 - Request third prefix	13
62	DEFINE MACHINE	1 - number of inputs 2 - number of outputs 3 - number of setups	1 - for video 2 - for audio 3 - for SDI 4 - for remote panel 5 - for RS-422 controller	14

NOTES on the above table:

NOTE 1 - When the master switcher is reset, (e.g. when it is turned on), the reset code is sent to the PC. If this code is sent to the switchers, it will reset according to the present power-down settings.

NOTE 2 - These are bi-directional definitions. That is, if the switcher receives the code, it will perform the instruction; and if the instruction is performed (due to a keystroke operation on the front panel), then these codes are sent. For example, if the HEX code

01 85 88 83

was sent from the PC, then the switcher (machine 3) will switch input 5 to output 8. If the user switched input 1 to output 7 via the front panel keypad, then the switcher will send HEX codes:

41 81 87 83

to the PC.

When the PC sends one of the commands in this group to the switcher, then, if the instruction is valid, the switcher replies by sending to the PC the same four bytes that it was sent (except for the first byte, where the DESTINATION bit is set high).

NOTE 3 - SETUP # 0 is the present setting. SETUP # 1 and higher are the settings saved in the switcher's memory, (i.e. those used for Store and Recall).

NOTE 4 - The reply to a "REQUEST" instruction is as follows: the same instruction and INPUT codes as were sent are returned, and the OUTPUT is assigned the value of the requested parameter. The replies to instructions 10 and 11 are as per the definitions in instructions 7 and 8 respectively. For example, if the present status of machine number 5 is breakaway setting, then the reply to the HEX code

0B 80 80 85

would be HEX codes

4B 80 81 85



NOTE 8 - The reply is as in TYPE 3 above, except that here the OUTPUT is assigned with the value 0 if the setup is not defined / no valid input is detected; or 1 if it is defined / valid input is detected.

NOTE 13 - This is a request to identify the switcher/s in the system. If the OUTPUT is set as 0, and the INPUT is set as 1, 2, 5 or 7, the machine will send its name. The reply is the decimal value of the INPUT and OUTPUT. For example, for a 2216, the reply to the request to send the audio machine name would be (HEX codes):

7D 96 90 81 (i.e. 128dec+ 22dec for 2nd byte, and 128dec+ 16dec for 3rd byte).

If the request for identification is sent with the INPUT set as 3 or 4, the appropriate machine will send its software version number. Again, the reply would be the decimal value of the INPUT and OUTPUT - the INPUT representing the number in front of the decimal point, and the OUTPUT representing the number after it. For example, for version 3.5, the reply to the request to send the version number would be (HEX codes):

7D 83 85 81 (i.e. 128dec+ 3dec for 2nd byte, 128dec+ 5dec for 3rd byte).

If the OUTPUT is set as 1, then the ASCII coding of the lettering following the machine's name is sent. For example, for the VS-7588YC, the reply to the request to send the first suffix would be (HEX codes):

7D D9 C3 81 (i.e. 128dec+ ASCII for "Y"; 128dec+ ASCII for "C").

NOTE 14 - The number of inputs and outputs refers to the specific machine which is being addressed, not to the system. For example, if six 16X16 matrices are configured to make a 48X32 system (48 inputs, 32 outputs), the reply to the HEX code

3E 82 81 82 (i.e. request the number of outputs)

would be HEX codes

7E 82 90 82

i.e. 16 outputs

NOTE 15 - When the OVR bit (4th byte) is set, then the "video" commands have universal meaning. For example, instruction 1 (SWITCH VIDEO) will cause all units (including audio, data, etc.) to switch. Similarly, if a machine is in "FOLLOW" mode, it will perform any "video" instruction.

NOTE 16 - The reply to the "REQUEST WHETHER PANEL IS LOCKED" is as in NOTE 4 above, except that here the OUTPUT is assigned with the value 0 if the panel is unlocked, or 1 if it is locked

LIMITED WARRANTY

We warrant this product free from defects in material and workmanship under the following terms.

HOW LONG IS THE WARRANTY

Labor and parts are warranted for seven years from the date of the first customer purchase.

WHO IS PROTECTED?

Only the first purchase customer may enforce this warranty.

WHAT IS COVERED AND WHAT IS NOT COVERED

Except as below, this warranty covers all defects in material or workmanship in this product. The following are not covered by the warranty:

1. Any product which is not distributed by us or which is not purchased from an authorized Kramer dealer. If you are uncertain as to whether a dealer is authorized, please contact Kramer at one of the agents listed in the Web site www.kramerelectronics.com.
2. Any product, on which the serial number has been defaced, modified or removed, or on which the WARRANTY VOID IF TAMPERED sticker has been torn, reattached, removed or otherwise interfered with.
3. Damage, deterioration or malfunction resulting from:
 - i) Accident, misuse, abuse, neglect, fire, water, lightning or other acts of nature
 - ii) Product modification, or failure to follow instructions supplied with the product
 - iii) Repair or attempted repair by anyone not authorized by Kramer
 - iv) Any shipment of the product (claims must be presented to the carrier)
 - v) Removal or installation of the product
 - vi) Any other cause, which does not relate to a product defect
 - vii) Cartons, equipment enclosures, cables or accessories used in conjunction with the product

WHAT WE WILL PAY FOR AND WHAT WE WILL NOT PAY FOR

We will pay labor and material expenses for covered items. We will not pay for the following:

1. Removal or installations charges.
2. Costs of initial technical adjustments (set-up), including adjustment of user controls or programming. These costs are the responsibility of the Kramer dealer from whom the product was purchased.
3. Shipping charges.

HOW YOU CAN GET WARRANTY SERVICE

1. To obtain service on you product, you must take or ship it prepaid to any authorized Kramer service center.
2. Whenever warranty service is required, the original dated invoice (or a copy) must be presented as proof of warranty coverage, and should be included in any shipment of the product. Please also include in any mailing a contact name, company, address, and a description of the problem(s).
3. For the name of the nearest Kramer authorized service center, consult your authorized dealer.

LIMITATION OF IMPLIED WARRANTIES

All implied warranties, including warranties of merchantability and fitness for a particular purpose, are limited in duration to the length of this warranty.

EXCLUSION OF DAMAGES

The liability of Kramer for any effective products is limited to the repair or replacement of the product at our option. Kramer shall not be liable for:

1. Damage to other property caused by defects in this product, damages based upon inconvenience, loss of use of the product, loss of time, commercial loss; or:
2. Any other damages, whether incidental, consequential or otherwise. Some countries may not allow limitations on how long an implied warranty lasts and/or do not allow the exclusion or limitation of incidental or consequential damages, so the above limitations and exclusions may not apply to you.

This warranty gives you specific legal rights, and you may also have other rights, which vary from place to place.

NOTE: All products returned to Kramer for service must have prior approval. This may be obtained from your dealer.

This equipment has been tested to determine compliance with the requirements of:

- EN-50081: "Electromagnetic compatibility (EMC); generic emission standard.
Part 1: Residential, commercial and light industry"
- EN-50082: "Electromagnetic compatibility (EMC) generic immunity standard.
Part 1: Residential, commercial and light industry environment".
- CFR-47: FCC* Rules and Regulations:
Part 15: "Radio frequency devices
Subpart B Unintentional radiators"

CAUTION!

- Servicing the machines can only be done by an authorized Kramer technician. Any user who makes changes or modifications to the unit without the expressed approval of the manufacturer will void user authority to operate the equipment.
- Use the supplied DC power supply to feed power to the machine.
- Please use recommended interconnection cables to connect the machine to other components.
* FCC and CE approved using STP cable (for twisted pair products)



For the latest information on our products and a list of Kramer distributors, visit our Web site: www.kramerelectronics.com where updates to this user manual may be found. We welcome your questions, comments and feedback.



Caution

Safety Warning:

Disconnect the unit from the power supply before opening/servicing.



Kramer Electronics, Ltd.

Web site: www.kramerelectronics.com

E-mail: info@kramerel.com

P/N: 2900-000360 REV 6