

Raptor RP-1

Traffic Safety Radar

OPERATOR'S MANUAL

Copyright © 2008, Kustom Signals, Inc.
All Rights Reserved. Printed in U.S.A.

This publication may not be reproduced, stored in a retrieval system, or transmitted in whole or in part in any form or by any means electronic, mechanical, photocopying, recording, or otherwise without prior written permission of Kustom Signals, Inc., 9325 Pflumm Road, Lenexa, KS 66215-3347

Customer Service 1-800-835-0156 (620-431-2700)
Sales Department 1-800-4-KUSTOM (913-492-1400)

TABLE OF CONTENTS

SECTION	PAGE
1. INTRODUCTION.....	1.1
2. SPECIFICATIONS	
2.0 General.....	2.1
2.1 Operational.....	2.4
3. INSPECTION AND INSTALLATION	
3.0 Initial Inspection	3.1
3.1 Material Supplied.....	3.1
3.2 VSS Pulse Cable Installation	3.2
3.3 Radar Installation.....	3.3
4. UNIT DESCRIPTION	
4.0 Display Panel View.....	4.1
4.1 Target Signal Tracking Bars	4.3
4.2 Remote Control.....	4.4
4.3 Processing Unit Rear Panel.....	4.6
5. GENERAL THEORY of OPERATION	
5.0 Block Diagram.....	5.1
5.1 General.....	5.2
5.2 Microwave RF Emissions.....	5.5
6. TESTING PROCEDURES	
6.0 General.....	6.1
6.1 Power-On.....	6.1
6.2 Automatic Self Test	6.2
6.3 Manual Test	6.2

TABLE OF CONTENTS

SECTION	PAGE
6.4 Tuning Fork Testing	6.3
6.5 Speedometer Verification	6.8
6.6 Minimum Patrol Speed Set	6.10
6.7 Moving Mode Test.....	6.10
7. OPERATION	
7.0 Operating Modes.....	7.1
7.1 Operational Setup.....	7.2
7.2 Stationary Operation	7.4
7.3 Moving Mode—Opposite Direction	7.9
7.4 Moving Mode—Same Direction.....	7.12
7.6 Speedometer Pulse Operation	7.13
7.7 Menu Screen Modes	7.14
7.7.1 Main Menu Screen.....	7.16
7.7.2 Operations Menu Screen.....	7.17
7.7.3 Display Menu Screen.....	7.18
7.7.4 Advanced Menu Screen	7.19
7.7.5 VSS Setup Menu Screen.....	7.20
7.7.6 Options Menu Screen.....	7.21
7.7.7 Time / Date Setup Menu Screen	7.22
7.7.8 System Information Menu Screen	7.23
7.7.9 Diagnostics Menu Screen	7.24
8. INFLUENCES AND INTERFERENCE	
8.0 Natural Influences.....	8.1
8.1 Man-Made Influences	8.2
8.2 Groundspeed	8.4
9. CARE OF THE Raptor RP-1	
9.0 Routine Care	9.1
9.1 Equipment Repair/Return	9.2
9.2 Battery Disposal.....	9.3

TABLE OF CONTENTS

SECTION	PAGE
10. CASE LAW	10.1
11. FCC INFORMATION.....	11.1
12. TROUBLESHOOTING	12.1
13. DIRECTIONAL OPERATIONAL SUPPLEMENT.13.1	
13.0 Directional Operation.....	13.1
13.1 Stationary Road Graphic.....	13.2
13.2 Moving Mode Road Graphic	13.2
13.3 Test Mode	13.3
13.4 Stationary Operation	13.4
13.5 Moving Mode Operation.....	13.7
13.6 Fastest Locking	13.10
14. WARRANTY.....	14.1

1. INTRODUCTION

The Kustom Signals Raptor RP-1 directional radar system comes from a long-standing commitment to the law enforcement community to provide quality, state-of-the-art speed measuring equipment. The Raptor RP-1 offers a wide range of features on this moving/stationary K or Ka-Band radar system, yet allows easy operation and simple one-button mode changes.

Raptor RP-1 units have the newest directional features; **Dual Channel Microwave** antennas and **Directional Digital Signal Processing (DSP)**. This allows Kustom Signals to add features such as same direction with automatic add or subtract difference speed, fastest vehicle detection in all modes, TruTrak with **Automatic Mode Switching (AMS)**, **Smart Patrol Search (SPS)** and stationary modes that allow the operator to select approaching only, receding only, or all targets identification. With these features, the officer can better identify the offending vehicle and eliminate much of the confusion of high traffic environments.

All these features and performance standards are packed into this small, lightweight unit, providing the most flexibility for the operator.

The Raptor RP-1 K-Band antenna sets a new standard for low power / low current operation. This will be appreciated as low draw on the already heavily taxed patrol vehicle's power source. The higher powered Ka-Band antenna offers higher detection range.

2. SPECIFICATIONS

2.0 GENERAL

Type:	Two-piece, Directional Moving / Stationary, Doppler radar system.
Frequency:	K-Band 24.125 GHz \pm 100 MHz
System Accuracy:	Stationary \pm 1 mph (\pm 1km/h) Moving \pm 1/-2 mph (\pm 1/-2 km/h)
Operating Voltage:	Corded: 10.0 to 16.5 VDC, 340 mA max. The Raptor RP-1 will operate normally and not display a low voltage alert to at least 10.0 VDC. Typically it will continue to operate even when the external battery voltage drops substantially below the specified 10.0 VDC.
Low Voltage Threshold:	Corded: Typically 8.5 VDC

SECTION 2--SPECIFICATIONS

Nominal Power Requirements:	Voltage (VDC)	Current (mA)
No target present:		
Backlight = Off	13.6	160
Backlight = On	13.6	230
With target present:		
Audio = Max	13.6	190
Backlight = Off		
With target present:		
Audio = Max	13.6	260
Backlight = On		
Standby (HOLD):	13.6	100
Backlight = Off		
Over Current Protection:	Automatic resetting protection devices on power lines of processing unit, display, antenna, and wired remote.	
Electronic Components:	100% solid state; integrated circuits, Digital Signal Processor, and micro-controller.	
Operating Temperature:	-22°F to +140°F (-30°C to +60°C) 90% relative humidity at 37°C, non-condensing.	

SECTION 2--SPECIFICATIONS

Dimensions:

Display Unit:

Height:	2.6" (6.60 cm)
Width:	4.1" (10.41 cm)
Depth:	1.5" (3.81 cm)
Weight:	0.30 lb. (0.14 kg)

Processing Unit:

Height:	1.2" (3.05 cm)
Width:	3.9" (9.91 cm)
Depth:	2.35" (5.97 cm)
Weight:	0.35 lb (0.16 kg)

Antenna Unit (K-Band):

Height:	3.1" (7.87 cm)
Width:	3.1" (7.87 cm)
Depth:	1.5" (3.81 cm)
Weight:	0.45 lb (0.21 kg)

2.1 OPERATIONAL

Speed Processor:	Digital Signal Processor (DSP) performs all signal analysis and speed calculations.
Manual Test:	All display pixels checked; checks internal calibration and performs a cross check of quartz crystals for timing accuracy.
Automatic self-test:	Comparison of quartz crystals done periodically (5 minutes maximum), upon every mode change and at the time of lock. "XTAL ERROR" displayed if an error is found.
Lock Time:	Instantaneous.
Patrol window area:	Displays Doppler patrol speed.
Target window area:	Displays truncated target speed.
Lock/Fast window:	Displays locked target speed or fastest vehicle in Fast mode.
Display Type:	Transflective Graphical Liquid Crystal Display (LCD).
Back Lighting:	White Light Emitting Diode (LED).

SECTION 2--SPECIFICATIONS

Speed Range:	Meets IACP/NHTSA specifications for target sensitivity. Stationary: 10 dB from 35 to 90 mph (56 to 144 km/h); 5 dB from 60 to 90 mph (96 to 144 km/h). Moving (Opposite Dir.): 10 dB for targets from 40 to 90 mph (64 to 144 km/h); 5 dB from 60 to 90 mph (96 to 144 km/h). Moving (Same Dir.): 10 dB for targets from 5 to 25 mph (8 to 40 km/h).
Stationary:	Spec: 10 to 205 mph (16 to 330 km/h). Typical: 6 to 208 mph (9 to 334 km/h).
Moving: Patrol:	Spec: 10 to 100 mph (16 to 160 km/h) Typical: 6 to 120 mph (9 to 193 km/h).

SECTION 2--SPECIFICATIONS

Target:

Opposite Dir.:

Target minimum (Patrol < 40 mph):

Spec: 10 mph (16 km/h)

Typical: 9mph (14 km/h)

Target minimum (Patrol > 40 mph):

Spec: 20 mph (32 km/h)

Target maximum:

(Combined patrol and target speeds):

Spec: 205 mph (330 km/h)

Typical: 208 mph (334 km/h).

Same Dir.:

Minimum difference speed:

Spec: 5 mph (8 km/h)

Typical: 3 mph (5 km/h).

Maximum difference: 0.65 x Patrol
Speed.

SECTION 2--SPECIFICATIONS

Indicators:	
Stationary:	Stationary operation displays “STA”. Stationary modes display “ALL”, “APR ONLY”, or “REC ONLY”.
Moving:	Moving operation “PATROL” above the patrol speed area.
Low Voltage:	Displays “LOW VOLTAGE” in the message area when internal voltage falls below approximately 8.5 VDC. The transmitter is disabled, but locked speeds will remain.
Radio Frequency Interference:	Displays “RFI ERROR” in the message area during strong radio frequency interference. Active speed displays are blanked during this condition. Locked speeds will remain.
Timing Error:	Displays “XTAL ERROR” in the message area when an internal error in the operating system is detected. Active speed displays will blank. Locked speeds will remain.
Transmitter Hold:	Displays “HOLD” above the active target speed area and in the message area when the system is not transmitting. (Controlled by the front panel or remote control).

SECTION 2--SPECIFICATIONS

Lock:	“LOCK” displayed and flashing above the FAST/LOCK speed area indicating locked target speed.
Fastest:	“FAST” displayed above the FAST/Lock speed area when fastest mode (stationary or moving) is enabled.
Fork Test:	Displays “FORK TEST” in the message area when the unit is in tuning fork test mode.
Km/h:	Displays “Km/h” above the road graphic area when the option for units is set to km/h.
Road Graphic:	These indicators show the mode of operation of the active antenna. In HOLD the mode of operation of both antennas are shown.
Target Direction:	There indicators above both target speed areas to indicate the direction of travel of the targets.
Microwave Freq:	24.125 GHz.
Beam Width: (Horizontal)	12° ±1°.
Polarization:	Linear.
Power Density:	Less than 1 mW/cm ² at aperture.
Source Power:	8 mW max.

3. INSPECTION AND INSTALLATION

3.0 INITIAL INSPECTION

Before installing your Raptor RP-1, please take a moment to carefully inspect the shipping carton for damage. Contact the shipping carrier at once if you notice any damage.

Remove the unit from the shipping carton and check the packing list against your original purchase order. If the shipment is incomplete or parts are missing, please contact Kustom Signals Customer Service Department at 1-800-835-0156, or (620) 431-2700.

3.1 MATERIALS SUPPLIED

The following equipment is normally included:

- Processing/Display Unit
- Antenna Unit
- Wired Remote Control
- Antenna Cable
- Antenna Mount
- Processing/Display Mount
- Speedometer Pulse Interface Cable
- Tuning Forks (35 & 65 mph)
- Operator's Manual - CD

OPTIONAL EQUIPMENT

- 2nd Antenna
- 2nd Antenna Cable
- IR Remote Control
- Processing/Display Separation Cable
- Video Interface Cable
- Heavy Duty Carrying Case

3.2 VSS PULSE CABLE INSTALLATION

Installing the provided cable to the vehicle's speed sensor (VSS) provides a signal to the Raptor RP-1 for Kustom Signals' patented Tru-Trak assisted patrol speed search feature. This feature virtually eliminates the problems of patrol shadowing and patrol combining. This signal also allows the unit to automatically switch between moving and stationary modes as the vehicle's movement is sensed.

1. The VSS pulse cable has a connector at one end, which plugs into the back panel of the processing unit.
2. The red wire (inner conductor) of the cable will be connected to the patrol vehicle's electrical speedometer input cable using the splice connector provided. Due to the vast amount of models, makes and years of vehicles, we have moved access to specific vehicle diagrams online where information can be better maintained and distributed.

Installation details can be accessed at:
<http://www.kustomsignals.com>
(select: radar fixed mount)

If your vehicle year, make and/or model is not listed, please contact Kustom's Customer Service Department at (800) 835-0156. If you are outside the US and Canada, please call (620) 431-2700.

NOTE: Only the inner conductor of the speedometer pulse cable is used. The outer shield is not connected.

3. The speedometer interface will be set up later, in Sec. 6.5.

3.3 RADAR INSTALLATION

3.3.1 INDICATOR UNIT

CAUTION: Equipment mounted in 1994 and later series police vehicles may interfere with the operation of passenger side airbags. Please refer to the vehicle manufacturer or your Kustom Signals District Manager for additional information on safe mounting areas within the vehicle.

1. The indicator unit consists of two components: the front display panel, which contains the unit's LCD display and control switches, and the processing unit, which contains the main signal processing board. These two components can be mounted in the vehicle as one piece or they can be separated and mounted in different locations.

The Raptor RP-1's display panel can be located overhead, on the dashboard or on the radio rack. The processing unit can be located under the dash, in the glove box or under the front seat.

2. Locate the provided Display/Processing mount. Position the display for best viewing position in the patrol vehicle and secure the mount.
3. If the processing section is separated from the display, consider mounting it in a convenient yet protected location, i.e. under the dash, in the glove box or under the front seat. The interconnect cable for the two components attaches to the rear of the display panel and front panel of the processing unit.

3.3.2 FRONT ANTENNA MOUNTING

Provided with the Raptor RP-1 is a windshield-type mount for the antenna. Contact your District Manager or Kustom Signals' Customer Service department for other optional antenna mounts.

1. Attach the antenna to the mount.
2. Use the antenna cable to connect the antenna to the Raptor RP-1's processing unit, front antenna port. Refer to Sec. 4.1 for antenna port location.
3. Connect the Raptor RP-1's power plug to the proper power source.
4. Momentarily depress the POWER switch on the front panel of the Raptor RP-1 (refer to Sec. 4.0 for location and function of front panel switches). It will process through the power-up sequence and internal tests as described later in Sec. 6. Select Stationary mode ALL by depressing the remote MODE switch until "STA" and "ALL" are displayed in the Patrol area. Both directional indicators (front antenna) will be lit.

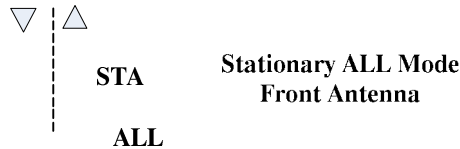

5. Place the Raptor RP-1 in the unsquelched (audio on) mode. Set the audio level to a point the noise from the antenna can be heard.
 - a. Press the Menu switch to go to the main menu screen.
 - b. Use the Down switch to highlight the AUDIO option.
 - c. Press the Enter switch to change audio settings. (Audio level setting will be blinking)
 - d. Use the Test(\surd) switch to toggle the squelch / unsquelch setting.
 - e. Press Enter to save the setting and return to the Exit line.
 - f. Press Enter again to return to the normal operating screen.

6. Start the patrol vehicle and position the A/C - heater fan to a mid-range speed. Move the antenna/mount to different positions on the windshield while listening to the audio. If there is fan interference, the audio will have a raspy sound instead of just noise. Position the antenna to minimize the amount of fan interference.

1. Aim of the antenna:

Stationary: Maximum performance of the system will be achieved when the antenna is aimed directly toward the vehicles being monitored.

Moving: Aim the antenna parallel to the ground and straight down the roadway.

NOTE: The polarization of the Raptor RP-1 K-Band antenna is linear. For best results the antenna must be mounted with the aim site on the housing at the top or bottom, not to the side.

3.3.3 REAR ANTENNA MOUNTING

1. Place the antenna on the rear antenna mount.
2. Follow the procedure for determining any fan interference per Sec. 3.3.2, steps 4-6. Set the Raptor RP-1 for stationary ALL mode, rear antenna.

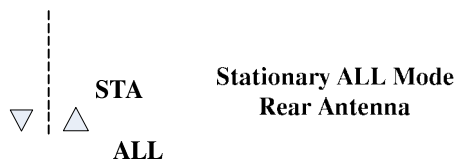

3. After the optimum position has been located (per Sec. 3.2.3 Step 6), secure the mount.
4. Position the antenna cable behind the rear seat and under the rear floorboard, then route up to the processing unit and connect. This method of mounting will minimize the antenna from moving around in the vehicle should it break loose in an accident. It should also prevent anyone from using the cable as a weapon against the officer.
5. Position the antenna parallel to the ground and straight down the roadway.

NOTE: The polarization of the Raptor RP-1 K-Band antenna is linear. For best results the antenna must mounted with the aim site on the housing at the top or bottom, not to the side.

4. UNIT DESCRIPTION

4.0 DISPLAY PANEL VIEW

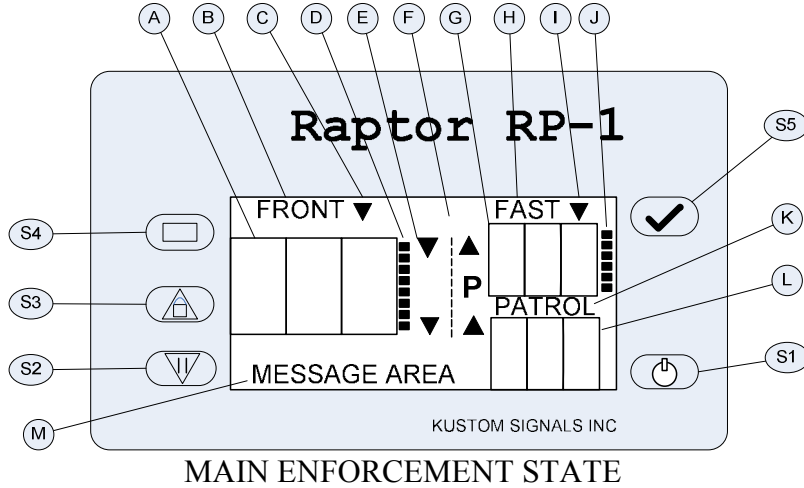

S1. Power Switch	Control for power on / off and for toggling backlight on / off.
S2. Hold (↓) Switch	Toggles the active antenna microwave transmitter on and off. In setup menu screens this is the down control.
S3. Lock/Release (↑) Switch	Alternately Locks and Releases the target and patrol speeds. In setup menu screens this is the up control.
S4. Enter Switch	Places the unit in the menu screen. Used to enter a selection.
S5. Test Switch	Initiates the display, internal self-test and tuning fork test mode.

SECTION 4—UNIT DESCRIPTION

A. Primary Target Speed Area	Displays target vehicle speeds in stationary and moving modes.
B. Active Antenna	Indicates FRONT or REAR for the current active antenna. HOLD if no antenna active.
C. Directional Indicator	Indicates the direction of travel of the target displayed in the Target Speed Area.
D. Target Signal Tracking Bar	Displays the signal strength history of the target displayed in the Target Speed Area.
E. Road Graphic	Indicates the mode of operation for each antenna.
F. Unit of Measure Indicator	Indicates Km/h when the speed readings are in kilometers per hour. This area is blank if speeds are in MPH.
G. Fast / Lock Speed Area	Displays Fastest or Locked target speed.
H. Fast / Lock Label	Displays FAST when the Fast/Lock area is displaying a Fastest speed. Displays LOCK when the Fast/Lock area is displaying a Locked speed.
I. Directional Indicator	Indicates the direction of travel of the target displayed in the Fast/Lock Speed Area.

J. Target Signal Tracking Bar	Displays the signal strength history of the target displayed in the Lock/Fast Speed Area.
K. Patrol Area Label	Displays PATROL in moving mode or STA in stationary mode.
L. Patrol Speed Area	Displays the vehicle's Patrol Speed in moving mode or in stationary mode displays ALL, APR ONLY, or REC ONLY.
M. Message Area	Displays relevant status and error messages in this area

4.1 TARGET SIGNAL TRACKING BARS

The Target Signal Tracking Bars are a new feature from Kustom Signals. The level on the bar shows the user the signal strength duration of the current target. This is not the same as the instantaneous signals strength. The signal strength duration shows the accumulated signal to noise ratio of the current target. A strong target will cause the duration level to rise quickly, whereas a weak target will cause the duration level to rise more slowly.

4.2 REMOTE CONTROL

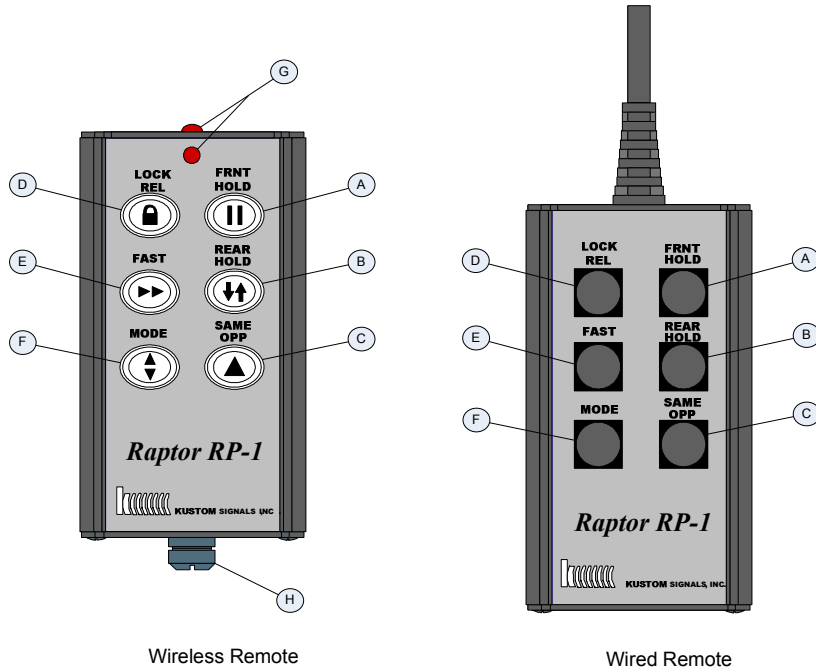

Certain functions of the Raptor RP-1 can be controlled with a wired or optional wireless/infrared (IR) remote.

<p>A. FRONT HOLD</p>	<p>This switch is used to turn the front antenna microwave transmitter on and off. If the rear antenna is active, it will be placed in Hold and the front antenna will become active.</p>
<p>B. REAR HOLD</p>	<p>This switch is used to turn the rear antenna microwave transmitter on and off. If the front antenna is active, it will be placed in Hold and the rear antenna will become active.</p>

SECTION 4—UNIT DESCRIPTION

C. SAME/ OPPOSITE	In moving mode this switch toggles between the same direction or opposite direction mode. In stationary selective modes, this switch toggles approaching only and receding only directions. This changes the modes of the active antenna only. The inactive antenna will retain its mode settings.
D. LOCK-RELEASE	This switch is used for locking and releasing target and patrol speeds.
E. FAST	This switch is used to enable or disable fastest target vehicle mode.
F. MODE	This switch rotates the selected antenna through the four modes of operation. <ol style="list-style-type: none">1. Moving Mode.2. Stationary ALL.3. Stationary Approaching only.4. Stationary Receding only.
G. IR TRANSMITTERS	Two IR transmitter LEDs.
H. Screw Release	Screw fastener to allow access into the battery compartment.

4.3 PROCESSING UNIT REAR PANEL

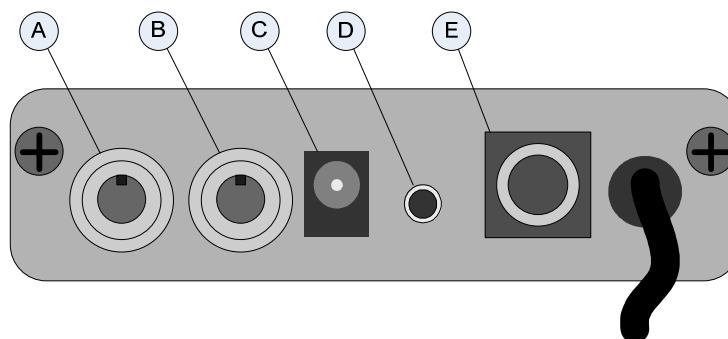

A. Rear Antenna	Connection for rear antenna cable.
B. Front Antenna	Connection for front antenna cable.
C. Speedometer Input	Connection for the Speedometer pulse cable.
D. Remote Control	Connection for the wired remote control cable.
E. Data Port	RS232 I/O port provides information to video systems or for updating operating software. All operations of the Raptor RP-1 can be controlled via this port.

5. GENERAL THEORY OF OPERATION

5.0 BLOCK DIAGRAM:

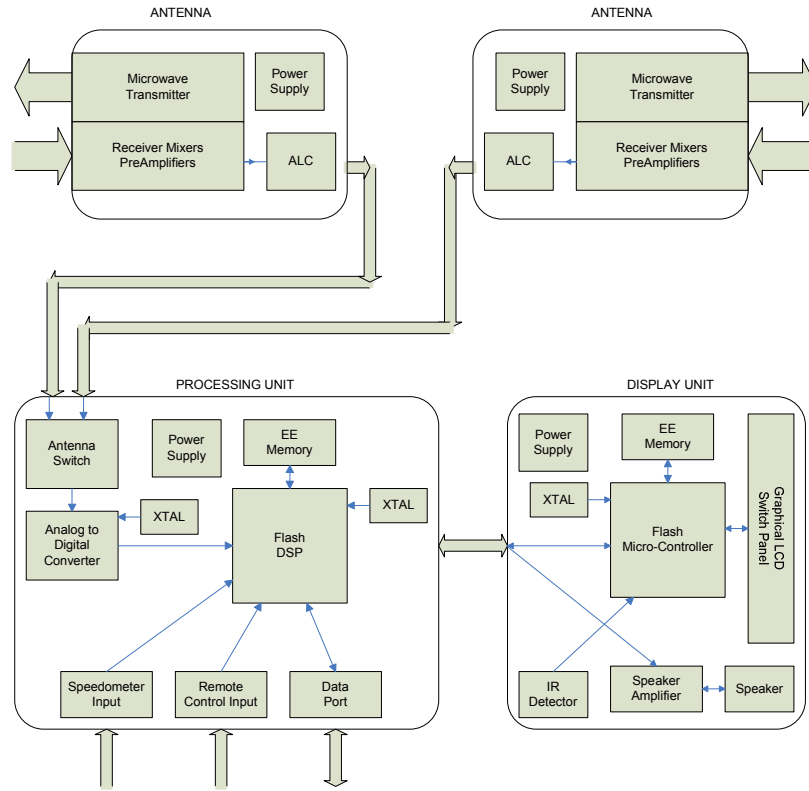

5.1 GENERAL

The Raptor RP-1 moving radar system transmits a K or Ka-Band radio frequency in compliance with the Federal Communications Commission (FCC) regulations.

CIRCUIT DESCRIPTION:

Antenna Description (K-Band): The Raptor RP-1 employs a Doppler Radar Transceiver Module (integrated antenna and micro-wave transceiver). The antenna element is a Microstrip Patch Antenna Array (MSPA). The antenna has one transmit and one receive array sections of connected patch elements. The transceiver is an integrated microstrip design containing the transmitter, low noise amplifier, receiver mixers (I/Q), and pre-amplifiers. An electronic board inside the antenna housing contains the power supply and Automatic Level Control (ALC) circuitry. The output signals from this antenna module are the I/Q Doppler signals.

Antenna Description (KA-Band): The Raptor RP-1 employs a Doppler Radar Transceiver Module (integrated micro-wave transceiver). The single antenna element is a circular horn and lens type. The transmit and receive sections are isolated by employing a turnstile junction in the microwave wave guide. The microwave transmitter is a Gunn effect oscillator placed at one port of the turnstile junction. A pick-up probe at the other port of the turnstile junction feeds the dual (I/Q) microstrip mixers. An electronic board inside the antenna housing contains the power supply and pre-amplifiers, filters and Automatic Level Control (ALC) circuitry. The output signals from this antenna module are the I/Q Doppler signals.

Processing Unit Description: The outputs from the antenna modules are connected to an antenna switch, to select the active antenna between front and rear. The signals from the active antenna are converted from continuous analog to discrete digital samples by the analog to digital converter. These digital samples are use by the DSP for all target

detection, directional phase sensing, and speed processing. Other peripheral circuits in the processing unit are; speedometer input, remote control input, and data input/output. These circuits are not in the I/Q Doppler signal path. The calculated target speed and direction information data is sent to the Display unit.

Display Unit Description: The micro-controller in the display unit receives the data from the processing unit and displays the information on the graphic LCD. Switch presses from the front panel are detected by the micro-controller and are sent to the processing unit. The display unit also contains a IR detector for the optional IR remote control and a speaker driver for the Doppler audio signal.

OPERATION DESCRIPTION:

Moving Mode: In moving mode a portion of the transmitted signal reflects from the surface of passing stationary objects back to the antenna. This returning signal is the "groundspeed" Doppler. From the antenna, it travels to the Digital Signal Processor (DSP) where the signal is translated to the speed of the patrol vehicle (groundspeed) and is displayed for the operator to confirm.

Kustom Signals radar has a patented feature using the patrol vehicle's speed sensor pulses, which steers the DSP processor to look for the "groundspeed" Doppler signal in a specific speed range. This feature will eliminate the often-annoying anomalies such as shadowing, combined patrol speeds, splitting speeds, and displaying patrol speed when stopped at a traffic light or sign.

Moving Opposite Direction Mode: In moving opposite direction mode, a portion of the transmitted signal strikes an oncoming vehicle (target vehicle) and returns a Doppler frequency higher than the groundspeed because the two objects (patrol vehicle and target vehicle) are converging. This returning signal is the "target" Doppler. The processing unit measures this speed of convergence, or combined speed.

Target Doppler Signal: Upon receiving the "target" Doppler signal, the processing unit automatically computes the difference between the speed of the patrol vehicle and the speed of the approaching vehicle. The speed of the approaching vehicle is then displayed as the Target speed. If, for example, a patrol vehicle is traveling 55 MPH and an approaching vehicle is traveling 65 MPH, the Raptor RP-1 would process the groundspeed of 55 MPH and the combined speed of 120 MPH. The DSP would subtract the patrol speed from the combined speed ($120 - 55 = 65$). The Patrol would display 55 and the Target would display 65.

Moving Same Direction Mode: In the moving same direction mode of operation, the target Doppler is received from a target traveling in the same direction as the patrol vehicle. These "groundspeed" Doppler and the "difference" Doppler signals are received and sent to the DSP. The Difference Doppler is the speed difference between the patrol vehicle and a vehicle traveling in the same direction. The Raptor RP-1 uses its directional determination capabilities to automatically determine if the target vehicle is traveling faster or slower than the patrol vehicle. The unit will display the patrol speed then automatically add or subtract the "difference" speed to the patrol speed for the target speed.

If the patrol vehicle's speed was 55 mph and a target was traveling in the same direction at 70 mph, the Raptor RP-1 would display 55 as the Patrol then add the "difference" Doppler signal (15) to the patrol speed ($55 + 15 = 70$) and display 70 as the Target.

5.2 MICROWAVE RF EMISSIONS

Traffic radar operators may have some questions about the biological effects of exposure to the microwave energy produced by the radar devices. According to all credible evidence, the emission levels resulting from traffic radar use pose no threat whatsoever, either to the radar operator or to target vehicle occupants.

One widely recognized authority for safe limits of nonionizing radiation exposure is the American National Standards Institute, which recommends maximum exposure levels for the frequencies on which Kustom traffic radar systems operate (ANSI/IEEE C95.1-1999, "Standard for Safety Levels With Respect to Human Exposure to Radio Frequency Electromagnetic Fields, 3 kHz to 300 GHz"). These exposure levels, expressed in terms of power density, are 10 mW/cm² for K-band and Ka-band radar units. Similarly, the Occupational Safety and Health Administration (OSHA), a division of the U.S. Department of Labor, recommends a 10 mW/cm² exposure limit for both frequency bands ("Radiation Protection Guide", 29 CFR, Chapter XVII, Subpart G, Part 1910.97). This limit is clearly accepted by most reputable scientific and medical authorities.

Kustom radar systems utilize microwave transmitters that produce aperture power densities, measured directly at the face of the antenna, in the range of approximately 0.1 to 2.3 mW/cm². Typical levels for the vast majority of units are in the 0.4 to 1.0 mW/cm² range, which is but a small fraction of the recognized safe limits. Bear in mind that these are level measurements taken directly in the main beam of the antenna, and that the power densities produced at the sides and rear of the unit are typically at least one hundred times lower than in the main beam.

Another reference document on this topic is a DOT publication entitled "Field Strength Measurements of Speed Measuring Radar Units" (NHTSA Technical Report #DOT-HS-805 928). This report documents a series of tests performed by the National Bureau of Standards on twenty-two commonly used models of traffic radar units, from six different manufacturers including Kustom. Aperture power density levels measured were from 0.25 to 2.82 mW/cm², while back-lobe power density values ranged from 0.001 to 0.02 mW/cm². These measurements were obtained with the radars mounted inside vehicles, as in normal operating conditions. Since the NBS study, other laboratories have duplicated these types of measurements, producing consistently similar results.

For a free copy of the latest information regarding the safe human exposure standards, please call or write Kustom to request the "RF Emissions Packet." You may contact us at our corporate headquarters:

Kustom Signals, Inc.
9325 Pflumm
Lenexa, KS 66215-3347
(913) 492-1400

While traffic radar devices do emit microwave energy, the levels are so low that there are no probable harmful effects. You may use your Kustom radar unit with complete confidence in its safety, as well as in its accuracy.

6. TESTING PROCEDURES

6.0 GENERAL

The tuning fork tests explained below should be conducted at the beginning and end of each patrol shift to ensure the accuracy and functionality of the unit. The results of these tests may be recorded in a radar log, similar to the log found at the end of this manual. The internal circuit and antenna tests are periodically performed automatically while the unit is in use.

6.1 POWER ON

Press and release the PWR switch. The unit will progress through the power-up sequence; light all the LCD pixels, test both antenna ports for connected antennas, and perform a crystal cross check to verify the timing accuracy of the speed processing circuitry.

The results of these tests will be displayed on the test results screen before progressing to the main enforcement screen. The results of the Internal Self Test will be “PASS” if all internal tests are within tolerance. If any of the internal tests fails, the specific test failure will be reported, such as “CRYSTAL FAILURE”. The band of each antenna connected to the unit will be displayed (K, KA, NONE). The current setting of the audio and range levels are also displayed on this tests results screen. As well, the audio is unseqelched to allow the user to hear the audio level.

TEST RESULTS SCREEN

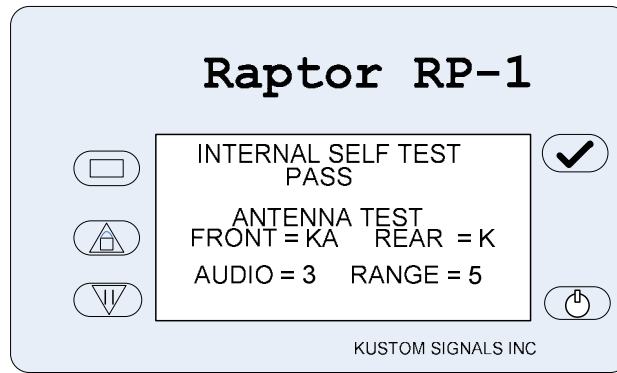

6.2 AUTOMATIC SELF-TEST

As long as the unit is turned on, the Raptor RP-1 performs an internal accuracy test every 5 minutes or whenever the unit's mode of operation is changed, such as moving to stationary, and each time the target speed is locked.

This test is automatic and will not interfere with any radar speed readings being taken. The test passing does not appear in the displays, but if an error is detected during this test, the specific error message will be displayed in the message area and further speed-readings are prohibited.

6.3 MANUAL TEST

The operator can manually perform the display and internal tests at any time during normal radar operation—just press and release the Test (∇) switch. The display test will be performed followed by the display of test results screen.

NOTE: The unit will remain in the TEST state for 30 seconds after releasing the TEST switch, indicated by “FORK TEST” displayed in the message area. Due to the ability of the unit to reject non directional signals, the operator must place the unit in this TEST mode to read tuning forks.

6.4 TUNING FORK TESTING

Supplied with the Raptor RP-1 are two tuning forks, 35 and 65 mph. These tuning forks will simulate targets in the stationary, moving opposite and moving same direction modes.

The tuning fork tests should be conducted with the antennas pointed away from traffic to avoid reflections from moving vehicles.

**** Due to the ability of the Raptor RP-1 to reject non-directional signals, the operator must place the unit in the FORK TEST mode to read tuning forks. Momentarily depress the Test (✓) switch. Upon releasing this switch, the Raptor RP-1 will complete the internal tests and enter the tuning FORK TEST mode.**

The unit will remain in this mode for 30 seconds, indicated by the FORK TEST displayed in the message area. Tuning fork tests may be performed while in this mode. Changing to a new mode will refresh the timeout to 30 seconds, allowing fork testing in different modes without leaving the test mode. Pressing the Test (✓) switch again, while in the Test mode, will terminate the Test mode.

6.4.1 STATIONARY TUNING FORK TEST

1. Place the Raptor RP-1 in the stationary “STA ALL” mode of operation.
2. Momentarily press the Test (✓) switch to enter the Fork Test mode. The message area will display FORK TEST.
3. Lightly strike the lower speed tuning fork on a hard, nonmetallic surface. Place the fork in front of the antenna. Make sure the antenna to be tested is active, (not in HOLD). Verify a target speed display of the value stamped on the tuning fork, ± 1 mph (± 1 km/h).

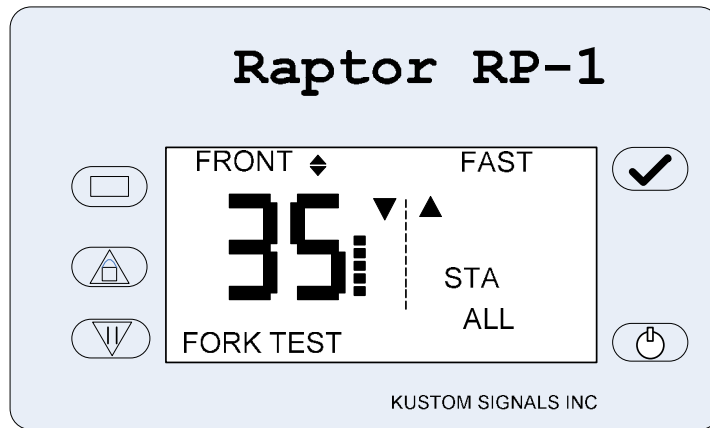

5. Repeat for the higher speed tuning fork.

NOTE: Since the Raptor RP-1 can determine these fork signals are non-moving targets, the speeds displayed during the fork tests cannot be LOCKED.

6.4.2 MOVING-OPPOSITE TUNING FORK TEST

1. Place the Raptor RP-1 in moving mode, opposite direction. (Press the MODE switch on the remote to select moving mode and the SAME/OPP switch remote, if necessary, to select opposite direction.)
2. Ensure the antenna is active, (not in HOLD).
3. Momentarily press the Test (✓) switch to enter the Fork Test mode. The message area will display FORK TEST. This allows the radar to detect a tuning fork and bypasses the speedometer input if it is being used.
4. Lightly strike the lower speed tuning fork on a hard, nonmetallic surface and place it in front of the antenna. The PATROL area should read the speed stamped on the tuning fork, ± 1 mph (± 1 km/h).
5. While holding the lower speed fork in front of the antenna, lightly strike the higher speed tuning fork and place it in front of the antenna. The primary Target area should display the difference between the lower fork and the higher fork.

Target display tolerance is ± 1 mph (1 km/h).

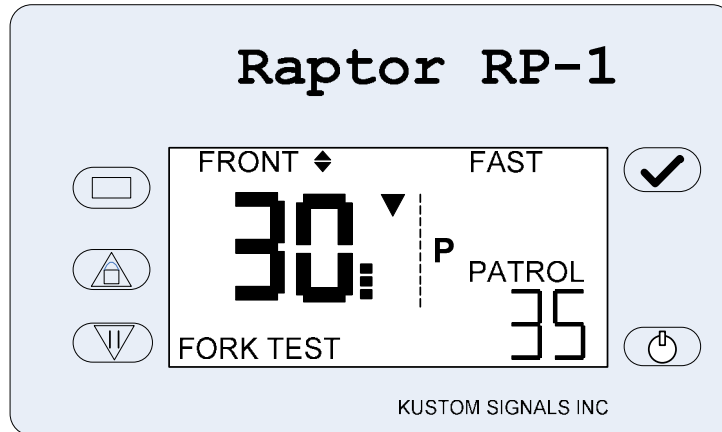

6.4.3 MOVING--SAME DIRECTION TUNING FORK TEST

1. While in the moving mode, press the SAME/OPP switch on the remote control and place the unit in the Same Direction mode.
2. Momentarily press the Test (✓) switch to enter the Fork Test mode. The message area will display FORK TEST. This allows the radar to detect a tuning fork and bypasses the speedometer input if it is being used.
3. Lightly strike the higher speed tuning fork on a hard, nonmetallic surface and hold it in front of the antenna. The PATROL area should display the speed stamped on the fork, ± 1 mph (± 1 km/h).
4. While holding the high speed tuning fork in front of the antenna, lightly strike the lower speed tuning fork and hold it in front of the antenna. The primary Target area should display the sum of the higher and lower speed tuning forks.

Target display tolerance is ± 1 mph (± 1 km/h).

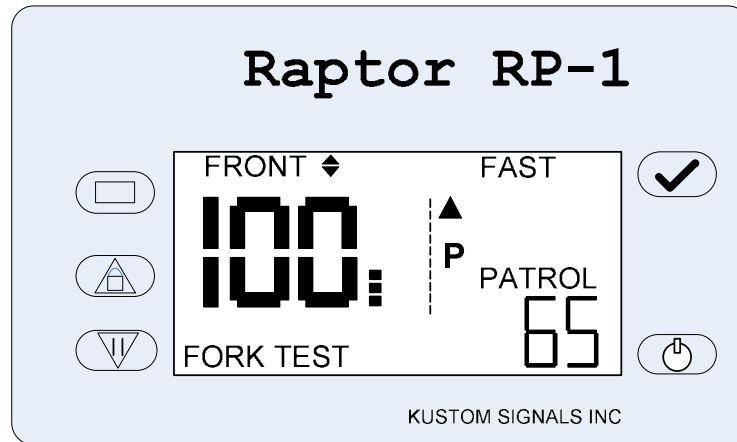

6.4.4 TUNING FORK TEST FAILURE

If the proper speed readings are not obtained during the previous tests, check the following:

1. The Raptor RP-1 cannot test tuning forks if the system is not in Test mode as indicated by the FORK TEST displayed in the message area.
2. Verify that the tuning forks are the proper tuning forks supplied with the unit.
3. Striking the tuning fork too hard or on a metallic surface will cause spurious overtones from the tuning fork. This may cause the speed readings to be double the specified speed. Also, moving the tuning fork while in front of the antenna may cause the speed reading to be slightly lower or higher than specified. These readings are only momentary and the proper readings should appear as the false overtones dissipate.

NOTE: Do not move the tuning forks after they have been placed in front of the antenna.

4. Ensure that the Raptor RP-1 is in the transmit mode and the range control is set to maximum.
5. If the proper readings cannot be obtained, remove the unit from service and contact Kustom Signals Service Support. 1-800-835-0156 (620-431-2700)

6.5 SPEEDOMETER VERIFICATION

Before the Raptor RP-1 can be used with the Vehicle Speed Sensor (VSS) pulse input, the radar unit must be synchronized with the speedometer. From the main Enforcement screen follow these steps to synchronize with the speedometer.

1. After installation and initial testing with tuning forks, the Raptor RP-1 should be driven at a constant speed, between 40 and 70 mph (64 and 112 km/h). Press the Menu switch to go to the main menu screen.
2. Use the Up / Down buttons to highlight the ADVANCED selection and press ENTER to go to the Advanced menu screen.
3. Use the Up / Down buttons to highlight the VSS SETUP selection and press ENTER to go to the VSS Setup screen. The current Synchronization number will be displayed on this screen.
4. Use the Up / Down buttons to highlight the SYNC TO VSS selection and press ENTER to go to the Sync Radar to VSS screen. The current Patrol Speed as read by the Radar will be displayed on this screen.
5. Verify the patrol speedometer and the radar patrol speed displayed agree within reasonable limits, and then press ENTER. This tells the radar that the current speedometer pulses (speed) and the Doppler patrol signal (radar patrol speed) agree

NOTE: Only the actual Doppler signal is used for the Patrol Speed. The speedometer input is used only to steer or guide the DSP to search for the Patrol Doppler signal in a specific area, ignoring signals in other areas.

6. During normal operation, at patrol speeds below the minimum limit of 10 mph, 16 km/h, or when a “groundspeed” Doppler signal cannot be found, the PATROL area will display dashes (---), indicating that the speedometer speed is being received but a patrol speed cannot be found or displayed. As an example, when a patrol vehicle is slowing down and the speed drops below the minimum speed, dashes will be displayed.

6.6 MINIMUM PATROL SPEED SET

When the speedometer input feature is not used, the Raptor RP-1 allows the operator to set a minimum patrol speed of 10, 20, 30 or 40 mph (16, 32, 48 or 64 km/h).

To activate this feature:

1. Press the Menu switch to go to the main menu screen.
2. Use the Up / Down buttons to highlight the PAT MIN selection and press ENTER. The current Patrol minimum setting will be blinking.
3. Use the Up / Down buttons to change the patrol minimum setting to 10, 20, 30, or 40 mph. Press ENTER to save the new setting. Press ENTER again to exit the menu screen.

NOTE: The lowest value (10 mph/16 km/h) is the default setting. At this setting the typical patrol speed readings will be 6 mph / 10 km/h.

6.7 MOVING MODE TEST

Verification of speed readings between the patrol vehicle's speedometer and the Raptor RP-1's PATROL speed display is another accuracy test that can be performed. These readings should be the same, or within reasonable limits, allowing for minor speedometer error.

Speedometer checks should be done on a daily basis. If a discrepancy is found, the radar unit should be removed from service until the error can be corrected.

7. OPERATION

7.0 OPERATING MODES

The Raptor RP-1 radar system offers the operator one of the most versatile traffic radar systems available today. It can be used in 10 different operating modes.

1. Stationary ALL Front Antenna
2. Stationary ALL Rear Antenna
3. Stationary Approaching Only Front Antenna
4. Stationary Approaching Only Rear Antenna
5. Stationary Receding Only Front Antenna
6. Stationary Receding Only Rear Antenna
7. Moving Opposite Direction Front Antenna
8. Moving Opposite Direction Rear Antenna
9. Moving Same Direction Front Antenna
10. Moving Same Direction Rear Antenna

NOTE: The following guide to operating the Raptor RP-1 radar system is not intended to be a training program. Before operating this unit or any other traffic radar system, Kustom Signals recommends that all operators have prior training in radar speed monitoring devices. Such courses are offered by Kustom Signals, various state and local agencies and either IPTM (Institute of Police Technology and Management) or Northwestern University.

7.1 OPERATIONAL SETUP

1. Select a location that provides a good view of the traffic to be monitored.
2. Check the immediate area for potential interference sources, such as large reflecting signs in the direct path of the radar's microwave beam, power substations and other sources of electrical interference.
3. Position the patrol vehicle in a safe location, with easy access to the roadway.

NOTE: Cosine effect, the angle between the target's direction of travel and the path to the radar, in the stationary mode, will ALWAYS be in the driver's favor. Refer to the National Highway Traffic Safety Administration's "Basic Training Program in RADAR Speed Measurement" for speed reduction information due to cosine angle.

7.1.1 POWER ON / OFF

To power on the Raptor RP-1, press and release the power switch in the lower right-hand corner of the display head. To power down the unit press and hold the power switch. If the switch is held down for just over one second the unit will power down.

7.1.2 BACKLIGHT CONTROL

For low light operation, the Raptor RP-1 has a multi-level backlight. After power up, the power switch in the lower right-hand corner of the display head is used to set the level of the backlight. The level settings for the backlight are; off, $\frac{1}{2}$, $\frac{3}{4}$, and full. On power up the default backlight level is set to $\frac{1}{2}$. By pressing and releasing the power switch, the backlight level setting is rotated through $\frac{1}{2}$ - $\frac{3}{4}$ - full - off - $\frac{1}{2}$.

7.1.3 ADJUSTING AUDIO

Adjust the Doppler audio for the desired listening level. Press the Menu switch to get to the menu screen. Use the Up / Down buttons to highlight the AUDIO selection and press ENTER. The current Audio level setting will be blinking. Use the Up / Down buttons to set the desired audio level (1 – 5). Press ENTER to save the new setting. Press ENTER again to exit the menu screen.

While setting the Audio level (Audio level blinking), the user can toggle the Audio Squelch / UnSquelch setting by pressing the Test() switch.

7.1.4 ADJUSTING RANGE

Set the range control to the desired level. Press the Menu switch to get to the menu screen. Use the Up / Down buttons to highlight the RANGE selection and press ENTER. The current Range level setting will be blinking. Use the Up / Down buttons to set the desired Range level (1 – 5). Press ENTER to save the new setting. Press ENTER again to exit the menu screen.

Range level 5 is maximum range; range level 1 reduces the Raptor RP-1 range to its minimum distance.

7.2 STATIONARY OPERATION

The Raptor RP-1 has six modes of stationary operation:

- All (ALL) - front antenna: Targets in front of the patrol vehicle from both directions are displayed and the direction of travel is indicated.
- All (ALL) - rear antenna: Targets behind of the patrol vehicle from both directions are displayed and the direction of travel is indicated.



- Approaching only (APR ONLY) - front antenna: Approaching targets in front of the patrol vehicle are displayed, receding vehicles not displayed.
- Approaching only (APR ONLY) - rear antenna: Approaching targets behind the patrol vehicle are displayed, receding vehicles not displayed.

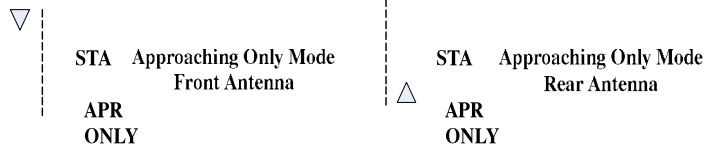

- Receding only (REC ONLY) - front antenna: Receding targets in front of the patrol vehicle are displayed, approaching vehicles not displayed.
- Receding only (REC ONLY) - rear antenna: Receding targets behind the patrol vehicle are displayed, approaching vehicles not displayed.

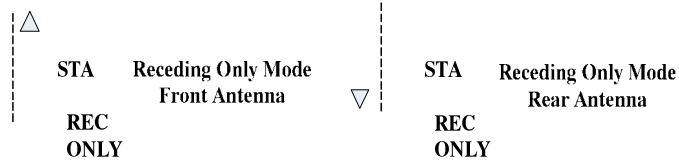

Stationary Setup:

1. Place the unit in the desired stationary mode. Switch to the desired antenna (Front / Rear). Set range and audio to the desired level.
2. *If desired, turn the microwave transmitter off by pressing the remote control HOLD switch for the selected antenna or by pressing the front panel Hold switch. "HOLD" will be displayed in the message area and above the Target area.
3. Complete a tracking history on the target vehicle.
 - A. Observe the target and surrounding traffic.
 - B. Estimate the speed of the target vehicle.
 - C. *Depress the HOLD switch to turn the microwave transmitter on.
 - D. Listen to the pitch of the audio; it should correspond to the estimated speed.
 - E. Observe the speed-reading shown in the Raptor RP-1's Target area display. It should correspond with B and D above.
 - F. Observe the indication of the target's direction of travel from the road graphics indicator. It should correspond to the observed target's direction of travel.
 - G. If any of the above elements are incompatible, the reading must be disregarded.

* Use the HOLD feature to defeat radar detectors.

7.2.1 TAGET LOCK - STATIONARY OPERATION

1. If the operator wishes to lock (retain) the violator's speed, simply depress the LOCK switch on either the remote control or the front panel. A short alert tone will be heard and the target speed will be displayed in the LOCK area.

The Raptor RP-1 will continue to track the violator's speed in the Target area as long as the vehicle is in the antenna beam.

The Raptor RP-1 will automatically run internal tests prior to locking any speed. Depressing the Test(✓) switch will allow the unit to complete a display, antenna, and internal test then return the locked speed.

If the operator switches to the opposite antenna while Locked, the road graphic indicator for the selected antenna at the time of lock will flash and the new selected antenna will be on. If the operator changes back to the original antenna, the original antenna indicator will light steady.

While Locked the operator can not change the mode of operation, such as stationary to moving.

2. To manually unlock or clear the locked speed, again depress the LOCK/REL switch on either the remote control or front panel. This will clear the LOCK display area.

NOTE: If the auto-unlock option is enabled, the locked speed will be automatically unlocked after 14 minutes.

7.2.2 FASTEST MODE--STATIONARY OPERATION

1. The Fastest vehicle operation to be toggled on / off, by the FAST switch on the remote control. When the fastest mode is activated, “FAST” will be displayed above the FAST area.
2. When a fastest vehicle is detected, the Fast area will display the speed of the fastest vehicle and the arrow symbol above the Fast area will display the direction the fastest vehicle is traveling. (The primary target area will continue to display the speed of the strongest target vehicle.)

NOTE: This is especially useful in traffic situations such as a small vehicle overtaking a larger truck. In the FASTEST mode, as in normal radar operation, a good tracking history is essential.

3. The operator may lock the fastest speed by depressing the LOCK switch while a fastest speed is displayed. The strongest speed may be locked by depressing the LOCK switch when only the strongest speed (no fastest speed) is being displayed.
4. When the speed is locked, a short alert tone will be heard. The label above the FAST / LOCK area will change to “LOCK”, and the locked target speed will be displayed in the Lock area.

If the fastest vehicle's speed was locked, the primary Target area will display the current fastest target (for track-through-lock history), and the message area will display “FAST TRACKING”. When there is no target being tracked, the message area will display “FAST LOCKED” to indicate the locked speed was obtained as a fastest speed.

SECTION 7—OPERATION

If the strongest vehicle speed was locked, the primary Target area will continue to display the strongest target and the FAST label above the Fast / Lock area will be replaced with “LOCK”, indicating the locked speed was obtained as a strongest speed.

5. To manually unlock or clear the locked speed, again depress the LOCK/REL switch on either the remote control or front panel. This will clear the LOCK display area.

NOTE: If the auto-unlock option is enabled, the locked speed will be automatically unlocked after 14 minutes.

7.3 MOVING MODE—OPPOSITE DIRECTION

1. Place the Raptor RP-1 in the moving mode by pressing the Mode switch, if needed, until the “PATROL” label is displayed above the Patrol area and ‘P’ is displayed in the road graphic. If necessary, select Opposite Direction mode by pressing SAME/OPP switch on the remote control (the opposite road graphic indicator will be lit).
2. Select the desired antenna, front or rear by pressing the Front Hold or Rear Hold switch on the remote control.



3. If the speedometer input feature is not used, check the setting of the minimum patrol speed. To display the existing patrol minimum setting, press the Menu switch to go to the main menu screen. To change the patrol minimum setting, refer to Sec. (6.6).
3. While driving, observe traffic and complete a tracking history on the target vehicle as described in Section 7.2 Step 3 and verify the radar’s patrol speed reading with the patrol vehicle’s speedometer. When all elements agree, enforcement action may be taken.

NOTE: If an incorrect Patrol speed is obtained, the operator can go in and out of HOLD quickly. This will clear all previous speeds, and a new patrol speed search will be initiated. See Sec. 7.7

7.3.1 HOLD MODE – MOVING OPPOSITE

The Raptor Rp-1 may be placed in the Hold mode (non-transmit) by pressing selected antenna's Hold switch on the remote control ("FRNT HOLD" or "REAR HOLD" or pressing the front panel Hold switch. "HOLD" will be displayed in the message area and above the primary target area. To return to normal radar operation, one of the Hold switches again.

7.3.2 MOVING MODE – TARGET LOCK

1. To lock the target speed reading, press the LOCK switch on the remote control or the front panel. A short alert tone will be heard, and the Locked target speed will be displayed in the Lock area.
2. The Raptor RP-1 will continue to track the target and patrol speeds.
3. When the patrol vehicle's speed has dropped 10 mph (16 km/h) below the speed when lock was activated, or the unit is placed in Hold, the patrol vehicle's speed, at the time of lock, will flash in the Patrol area. This allows the operator to continue to track the target while monitoring the patrol vehicle's speed and still retain the locked patrol speed.

Note: While Locked the operator can not change the mode of operation, such as stationary to moving.

4. The locked speeds may be unlocked by:
 - A. Pressing the remote control or front panel Lock switch again.
 - B. Auto-unlock after 15 minutes, if activated.

7.3.3 MOVING MODE – FASTEST VEHICLE

A Fastest vehicle target is a target that is traveling at a higher speed than the strongest target vehicle.

1. With the unit operating in the moving mode, observe traffic.
2. The Fastest operation can be turned on /off by pressing the “FAST” switch on the remote control. When the fastest mode is activated, the FAST label will be displayed above the Fast area.
3. When a fastest target is detected, the fastest speed will be displayed in the Fast area. The directional arrow symbol above the Fast area, indicating approaching fastest or receding fastest, will indicate the direction of travel of the fastest target. The primary Target area will continue to display the strongest signal speed.

7.3.4 MOVING MODE – FASTEST VEHICLE LOCK

1. To lock the fastest vehicle speed, momentarily press the LOCK switch on the remote control or front panel.
2. If the fastest vehicle speed is locked, the primary Target window will display the current fastest target (for track-through-lock history) and “FAST TRACKING” will be displayed in the message window. If the strongest vehicle speed is locked, the primary Target window will continue to show the strongest target, and the FAST indicator will be turned off, indicating the locked speed was obtained as a strongest target.

7.4 MOVING MODE – SAME DIRECTION (OPTIONAL FEATURE)

1. Select the moving mode, same direction by pressing the SAME/OPP switch on the remote control. The same direction road graphic indicator will be lit.



2. While driving, observe traffic traveling the same direction as the patrol vehicle.
3. Complete a tracking history as in Sec 7.2 step 3, and verify the patrol speed agrees with the speedometer speed reading.

NOTE: Vehicles traveling at the same rate of speed as the patrol vehicle will not qualify as targets. The minimum difference in speed between the patrol vehicle and the target vehicle is 3 mph (5 km/h). The maximum difference is 0.65 x Patrol Speed (65% of Patrol Speed). (For a patrol speed of 50 mph, the maximum difference speed would be 32.

NOTE: If an incorrect Patrol speed is obtained, the operator can go in and out of HOLD quickly. This will clear all previous speeds, and a new patrol speed search will be initiated. See Sec. 7.7

4. The Raptor RP-1 can automatically detect whether the target vehicle is traveling slower or faster than the patrol vehicle. There is no need for the operator to input slower or faster information for same-direction targets.

5. The Fastest feature can also be used in the Same Direction mode. To qualify as a fastest speed, the target must be faster than both the strongest target and the patrol speed.

7.5 VSS PULSE OPERATION

The Raptor RP-1 has hardware and software in place to interface the unit to the patrol vehicles speed sensor (VSS). The speed sensors input pulses steer the DSP in the search for the Doppler patrol signal. This patented technique, (TruTrak) virtually eliminates problems of patrol shadowing and patrol combining.

Once the synchronization procedure has been completed no further action is needed unless the Raptor RP-1 is placed in another patrol vehicle. If so, the operator must repeat the synchronization procedure for the new vehicle if he wishes to use the speedometer pulse input.

The radar may be operated with or without the speedometer pulse input. If it is not connected to the speedometer pulse input, it will operate as standard directional radar. If the Raptor RP-1 is connected to the speedometer pulse input, it will operate as a standard directional radar on power up. When speedometer pulses are detected, it will automatically begin using the stored synchronization code.

7.5.1 AUTOMATIC MODE SWITCHING

The Raptor RP1 with speedometer interface that has been synchronized will perform **Automatic Mode Switching (AMS)**. When the unit has received speedometer pulses, after power up, it will automatically switch to moving mode while the vehicle is traveling and to stationary mode when the vehicle stops.

NOTE: AMS will not change modes if the operator has Locked speeds. If speeds were Locked in stationary mode and then the vehicle begins traveling, the unit will be placed in Hold.

7.6 SMART PATROL SEARCH

The Raptor RP-1 can be operated with or without speedometer input. If the speedometer input is not connected, the unit will use patented Smart Patrol Search (SPS) software routines. This software reduces patrol shadowing and patrol combining when coming out of Hold mode by knowledge of how traffic radar is typically used by the operator.

When using traffic radar in moving mode, typically the operator will activate and deactivate the antenna transmitter as needed to check the speed of target vehicles. The radar may have been in Hold anywhere from several seconds to several minutes. Each time the operator switches from Hold to active mode, the unit must first capture the patrol vehicle speed before any target speeds are processed. It is during this initial capturing from Hold that radar processing is the most vulnerable to patrol shadowing or combining.

SPS software works by storing the patrol speed when the operator enters the Hold mode. This has two purposes; to help track and/or reject patrol signals when returning to active mode. If the unit is in the Hold mode for a typical amount of time (more than one second), the DSP will search first in a region around the stored patrol speed.

Example: The patrol vehicle is traveling 65 MPH and the operator enters Hold mode. When the operator comes out of Hold sometime later, the SPS software will search the region around 65 MPH first for the patrol signal. If a 20 MPH shadowing signal was present, it is not likely to be displayed as a false patrol.



If on the other hand the unit is not in Hold for the typical amount of time (less than one second), the region around the saved patrol will be excluded from the initial patrol search.

Example: The patrol vehicle is traveling 25 MPH, there is a strong approaching target traveling 45 MPH, and the radar has mistakenly combined the two and is displaying 70 MPH for patrol. The operator can quickly go in and out of Hold to reject the region around 70 MPH and the correct 25 MPH patrol speed will be displayed.

7.7 MENU SCREEN MODES

The Raptor RP-1 has a graphical LCD display panel. This allows the operator to make operational and configuration options setup selection using full text menu screens.

7.7.1 MAIN MENU SCREEN

The highest level of the menu screens is the main menu. To get the main menu press the Menu  switch. To select one of the menu options, use the Up and Down switches to highlight the option and then press the Enter  switch.

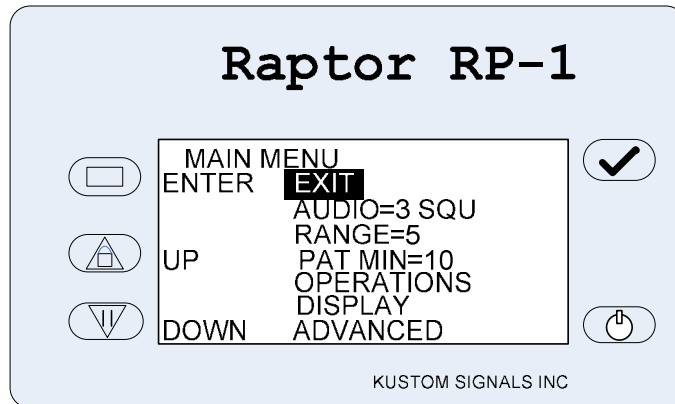

To adjust the Audio, Range, or Patrol Minimum setting, once the option has been selected the current setting will blink, use the Up or Down switches to adjust the setting. Once the setting is at the desired level, press the Enter switch to save the setting. The highlight will return to the EXIT line.

To move to the Operations, Display or Advanced menus, use the Up or Down switches to highlight the desired menu and then press the Enter switch.

7.7.2 OPERATIONS MENU SCREEN

The Operations menu allows the user to change operational settings of the Raptor RP-1 that are normally controlled via the wired or IR remote control. By having this operations menu the user can continue to control the Raptor RP-1 in cases of a lost or broken remote control.

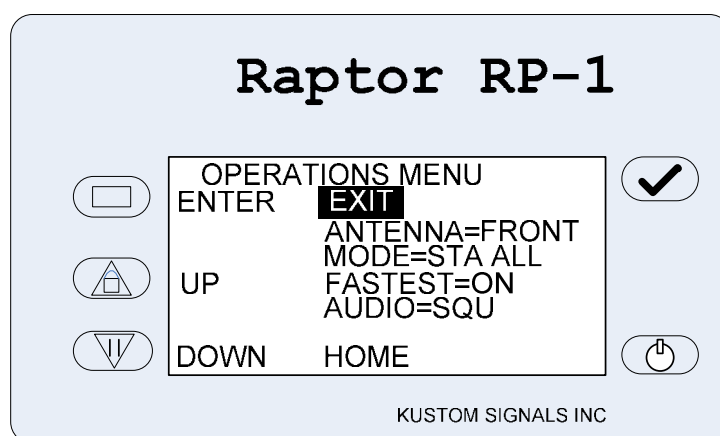

To select one of the operational settings, use the Up and Down switches to highlight the desired item and then press the Enter switch. The current setting will blink, use the Up or Down switches to adjust the setting. Once the desired setting is displayed, press the Enter switch to save the setting and the highlight will return to the Exit line. Choices for the Operational settings are:
Antenna: Front, Rear

Mode: Stationary Approaching Only (STA APR),
Stationary Receding Only (STA REC), Stationary
All (STA ALL), Moving Opposite (MOV OPP),
Moving Same Direction (MOV SAME)
Fastest: On, Off
Audio: Squelch (SQU), UnSquelch (UNSQU)

Pressing Enter while the EXIT line is highlight will return to the main menu screen. Pressing Enter while the HOME line is highlighted will leave the menu screens and return to the normal operation mode.

7.7.3 DISPLAY MENU SCREEN

The Display menu allows the user to change settings for the LCD display.

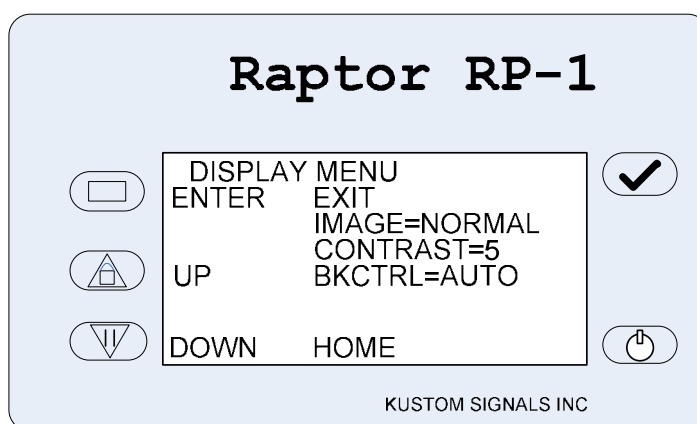

To select one of the display settings, use the Up and Down switches to highlight the desired item and then press the Enter switch. The current setting will blink, use the Up or Down switches to adjust the setting. Once the desired setting is displayed, press the Enter switch to save the setting and the highlight will return to the Exit line.

Choices for the Display settings are:

Image: Normal, Reverse

Contrast: 1 – 5

Back-Light: Manual, Automatic

Pressing Enter while the EXIT line is highlight will return to the main menu screen. Pressing Enter while the HOME line is highlighted will leave the menu screens and return to the normal operation mode.

7.7.4 ADVANCED MENU SCREEN

The Advanced menu allows changes to of the Raptor RP-1 that are rarely are not normally set by the user. By having this advanced menu the user can synchronize to the vehicle VSS signal, set configuration options, set the optional Time and Date, view system information, or run system diagnostics.

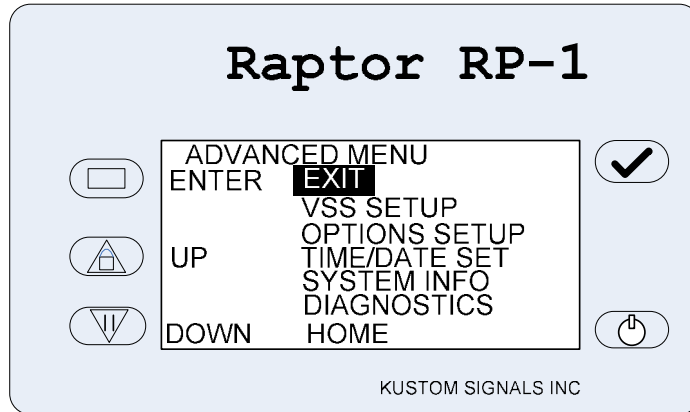

To select one of the menu options, use the Up and Down switches to highlight the option and then press the Enter switch.

Pressing Enter while the EXIT line is highlight will return to the main menu screen. Pressing Enter while the HOME line is highlighted will leave the menu screens and return to the normal operation mode.

7.7.5 VSS SETUP MENU SCREEN

The VSS setup menu allows the user to synchronize the Raptor RP-1 to the vehicles speed sensor (VSS) signal. Follow the steps in Section 6.5 to complete the synchronization.

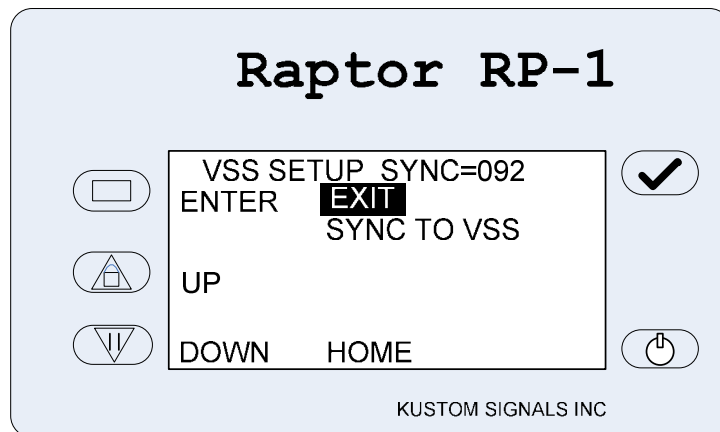

Pressing Enter while the EXIT line is highlight will return to the Advanced menu screen. Pressing Enter while the HOME line is highlighted will leave the menu screens and return to the normal operation mode.

7.7.6 OPTIONS SETUP MENU SCREEN

The Options setup menu allows the user to set Raptor RP-1 configuration options.

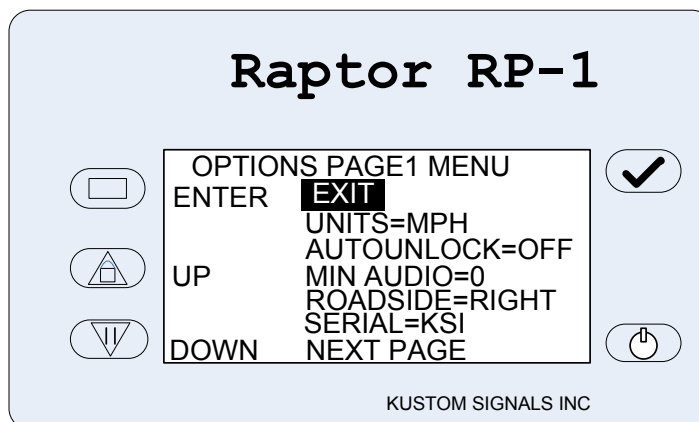

Choices for the configuration options settings are:

Units: MPH, Km/H

Auto UnLock: Off, On

Minimum Audio Setting Allowed: 0, 1

Driver's Roadside: Right, Left

Serial Output Format: KSI, Full Gateway, Reduced Gateway, Test

Pressing Enter while the EXIT line is highlight will return to the Advanced menu screen. Pressing Enter while the NEXT PAGE line is highlighted will go to more future options listings.

7.7.7 TIME / DATE SETUP MENU SCREEN

The Time / Date setup menu allows the user to set Raptor RP-1 current time and date. *This is a non-standard, optional feature.

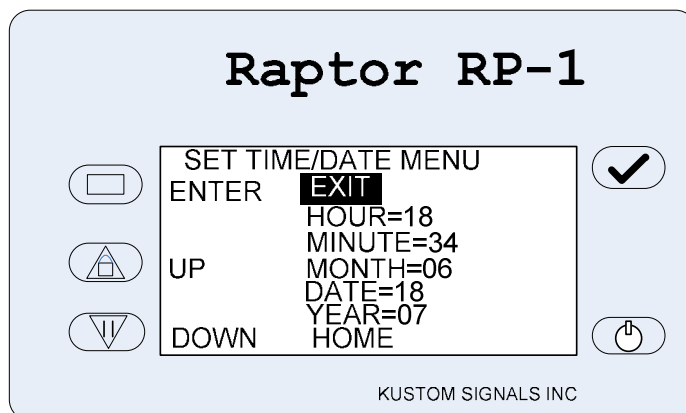

To adjust the Hour, Minute, Month, Date, or Year, use the Up / Down switches to highlight the desired selection and then press the Enter switch. Once the item has been selected the current setting will blink, use the Up or Down switches to adjust the setting. Once the setting is at the desired level, press the Enter switch to save the setting. The highlight will return to the EXIT line.

Pressing Enter while the EXIT line is highlight will return to the Advanced menu screen. Pressing Enter while the HOME line is highlighted will leave the menu screens and return to the normal operation mode.

7.7.8 SYSTEM INFORMATION MENU SCREEN

The System Information menu screens allow the user to view information about their Raptor RP-1 units. This information includes software revisions, type of antennas connected, VSS sync value, and enabled features.

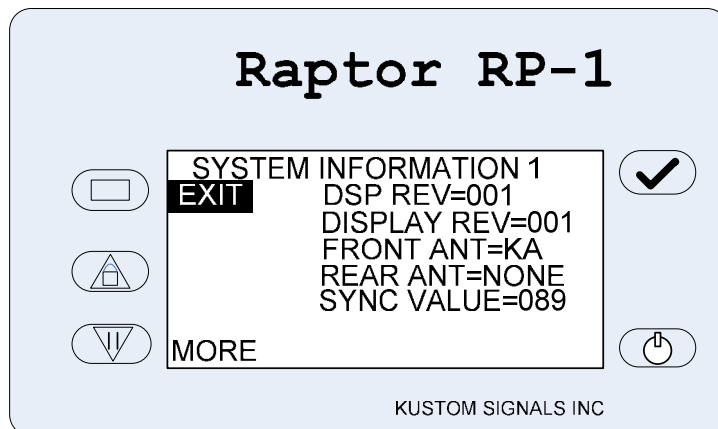

There are no user's settings in these menu screens.

7.7.9 DIAGNOSTICS MENU SCREEN

The Diagnostics menu screens are not for normal users operation. These menu screens are to augment troubleshooting and for test lab operations.

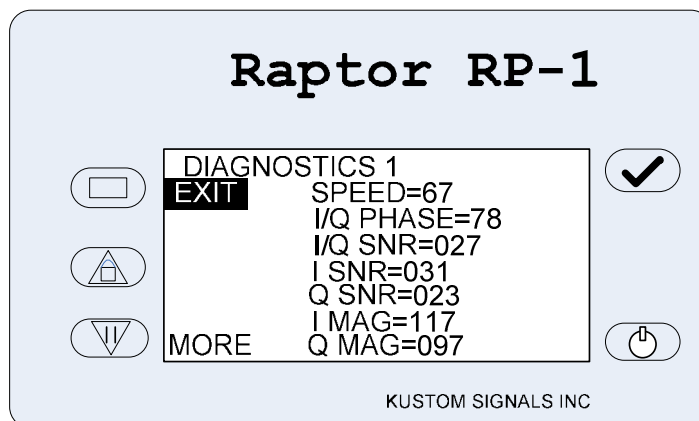

There are no user's settings in these menu screens.

8. INFLUENCES AND INTERFERENCE

Interferences from external sources may affect the standard operation of any radar device, including the Raptor RP-1. These influences can be natural or man-made, however, the Digital Signal Processing circuitry will eliminate most of these influences and a knowledgeable operator should be able to determine the nature of the influences and their effect, if any, on the performance of the Raptor RP-1.

8.0 NATURAL INFLUENCES

1. Heavy rains and blowing dust can cause a scattering effect, which may reduce the effective range of the Raptor RP-1. The patrol speed can also be affected by driving rain. It is recommended that the operator compare the patrol speed reading and the speedometer reading frequently during rainy periods.
2. Terrain can affect the range of the Raptor RP-1. Improper aiming of the antenna can cause the radar to appear to have short range. If the target vehicle were on a slight incline, the antenna could be shooting short of the intended target vehicle.
3. Strong reflections from roadside objects, such as large signs, parked cars and buildings can cause double bounce reflections, which appear to be targets traveling at the same speed as the patrol vehicle. The DSP will analyze signals that are the same as the patrol speed, if it is determined they are possible “harmonics” from double bounce the Target area will be blank or display “- - -” until this condition no longer exists.

8.1 MAN-MADE INFLUENCES

1. Radar units may display incorrect speed readings from various sources. These include shadowing, combined speeds, moving cosine and fan interferences (splitting speeds).
2. Patrol speed shadowing may occur when the radar unit receives a stronger reflected signal from a vehicle traveling the same direction than the groundspeed return signal of the patrol vehicle. This difference speed may be placed in the Patrol area and used instead of the proper patrol speed. See Sec. 8.2.
3. The combined speed effect can occur when the patrol vehicle and the target vehicle are approaching each other at low speeds, usually in the 25 to 35 mph (40 to 56 km/h) range each, and at relative short distances, usually less than 300 feet. The radar unit sees a strong reflection from the combined speed signal and may display this speed instead of the true patrol speed.

NOTE: The Raptor RP-1 with speedometer input will eliminate these shadowing and combining effects, and display the proper patrol and target speeds. If the speedometer input is not used, the Raptor RP-1 has patented software algorithms that allow the radar to correct shadowing or combined readings. If the user suspects that the radar is displaying a shadow or combined speed, entering and exiting the Hold Mode quickly should correct the readings.

4. The Raptor RP-1 has an input power monitor. If the power supply voltage drops below the minimum operating voltage, the unit will not display any new speed-readings until the low voltage condition no longer exists. "LOW VOLTAGE" will be displayed in the Message area.

5. Radio Frequency Interference (RFI) exists when there are strong RF transmitters in the immediate area of the radar unit, such as the patrol vehicle's transmitting radio, high power radio or television stations. Normally these signals are processed as non-moving and not displayed as targets. However, if the RFI signals are strong enough, the Raptor RP-1 will detect these sources of interference. The unit will not display any new speed-readings and the "RFI ERROR" will be displayed in the Message area, until the source of interference is reduced or eliminated.
6. Heater and A/C fan motors can cause a radar unit to display the fan's speed, rather than a weaker target vehicle's speed. A trained operator should not be confused by intermittent fan readings and the distorted audio. Proper antenna mounting, placement, and aiming will eliminate most of the potential fan interferences.

NOTE: If there are still problems with fan interference in your type of patrol vehicle, Kustom Signals can provide antenna noise reduction pads to prevent the fan signal from reaching the antennas. Contact your District Sales Manager or Kustom Signals' Customer Service department for antenna pad options.

NOTE: Refer to the National Highway Traffic Safety Administration's Basic Training Program in RADAR Speed Measurement for further information on interferences and training guides.

8.2 GROUNDSPEED

True groundspeed of the patrol vehicle is required by all moving traffic radar systems before a target vehicle's speed can be accurately computed. If the Raptor RP-1 loses correct groundspeed, the operator can recapture groundspeed by quickly activating and then deactivating the HOLD mode.

If the speedometer input is being used with the Raptor RP-1, the DSP will accurately track even a weak patrol speed return due to the small tracking window, unlike radar without speedometer input.

The Raptor RP-1 will always look for and display groundspeed before displaying any targets. The groundspeed radar signature is unlike most target or interference signals. The DSP can identify this pattern, which is helpful in situations such as shadowing or combined speeds. While the speedometer input and DSP technology will eliminate most of the influences found in moving radar, it is still the responsibility of the operator to complete a tracking history on the target vehicle and verify the patrol speed with the patrol vehicle's speedometer. Close observation of the patrol vehicle's speed reading is recommended to avoid possible confusion.

NOTE: Typically the Raptor RP-1 will not display patrol speeds below 6 mph (10 km/h), or below the patrol minimum setting if the speedometer input is not used.

Operating moving radar in the rain and snow requires the operator to pay close attention to the patrol speed. Since rain, fog and snow may affect the ability of the radar system to find groundspeed, the operator must verify the displayed patrol speed reading is correct.

9. CARE OF THE RAPTOR RP-1

The Raptor RP-1 radar system is designed for long reliable use by law enforcement agencies. Following basic care guidelines will ensure the unit gives many years of trouble-free service.

9.0 ROUTINE CARE

1. Use a damp cloth to clean the outside of the radar unit if it becomes dirty. **DO NOT** use excessive water or any cleaners or sprays on the outer surfaces of the unit or remote control.
2. As with all electrical or electronic equipment, protect the unit from water. While all parts are weather resistant, the processing unit and remote control are not waterproof. If any liquid should get inside, remove power immediately and send the unit in to a repair facility. Prompt action can minimize any damage.
3. If the Raptor RP-1 is used outside in rain or snow, it should be wiped dry with a clean cloth as soon as practical.
4. There are no user serviceable parts inside the Raptor RP-1. All major circuit boards (main processing, display, antenna) have over-current protection by automatically resetting fuses. There is one main fuse located in the end of the cigarette lighter plug. If needed, simply unscrew the tip and replace with the same size fuse.
5. Do not pick up or carry the Raptor RP-1 by the power or remote control cables. Broken power, antenna, and remote control cables are a common cause of intermittent operation.

6. Kustom Signals recommends periodic maintenance and certification of the Raptor RP-1 radar system. Check with your local judicial district for requirements.

9.1 EQUIPMENT REPAIR/RETURN

Should the Raptor RP-1 need repair or certification from Kustom Signals Customer Service, please visit our website (www.kustomsignals.com), click on the “parts & returns” tab and follow the instructions on the Returns Form to receive a Return Material Authorization (RMA) number. If you do not have access to our website, please call our Customer Service Department at (800) 835-0156 or (620) 431-2700 to obtain your RMA number before returning your unit. The following information will be needed:

1. Serial number of unit, department name, return shipping address, contact name at owning department, and phone number.
2. Complete description of failure or problem with unit. Please describe, in detail, what the failure is and when it is observed. EXAMPLE: In moving mode, targets are close to patrol vehicle before being displayed. Target speeds are not multiples of patrol speed.
3. Method of return shipment.

NOTE: Kustom Signals will return the unit via Ground transportation unless otherwise directed.

9.2 BATTERY DISPOSAL

It is a violation of Federal regulations to dispose of rechargeable batteries in a landfill. They must be recycled at an appropriate facility, disposed of in accordance with local ordinances, or shipped back to Kustom Signals for disposal. For more information on disposal facilities near you, contact the Rechargeable Battery Recycling Corp. (RBRC) at 1-800-8-BATTERY, email rbrc@rbrc.com, web page www.rbrc.com.

10. CASE LAW

This section is included so radar operators and those individuals responsible for prosecuting traffic arrests can familiarize themselves with the more important legal cases involving the use of traffic radar. To obtain additional information on the referenced material, consult your community's local law library or the prosecutor's office.

Since the Raptor RP-1 is a Doppler based traffic radar system, some older case law is presented because of its significance to the acceptance of the Doppler principles as well as the basic requirements of the tuning fork test and operator training.

Reference A – *State vs. Dantonio* (N.J.) 1955 115 A2d35, 49 ALR 2d 460. Landmark case on the acceptance of the Doppler principles as used in traffic radar.

Reference B – *State vs. Shelt* (Ohio) 1975 75-D O-3682, L-75-166. Establishes that the courts may take judicial notice of the reliability of moving radar.

Reference C – *Honeycutt vs. Commonwealth* (KY) 1966 408 SW 2d 421. Court establishes that a tuning fork test is an accurate method of testing the accuracy of a radar unit and along with the visual observations of a trained operator, is an accurate means of determining the speed of vehicles.

Reference D – *Krueger, Pantos and Payne vs. State of California* 1986 (class action suit – suppression hearing on radar) 887092, DP44339 and DP54571. Court ruled that a properly built and tested radar used by a trained operator can accurately determine the speed of vehicles. The judge dismissed each of the defendant's claims that outside influences render the radar readings inaccurate in the moving mode of operation. He ruled that proper classroom and field training enables an officer to avoid any false or inaccurate readings due to outside influences.

The court held and took judicial notice of the accuracy of Doppler radar in both the stationary and moving modes of operation.

Reference E – Samuel Knight vs. State of New York Superior Court. 72 N.Y. 2d 481, 530 N.E. 2d 1273 (1988). The court ruled that a trained operator, who properly tested the radar, observed the traffic and checked the patrol speed against the patrol vehicle's speedometer, can accurately determine the speed of vehicles while the patrol vehicle is moving. The court affirmed the lower court's ruling and accepted judicial notice of the radar in the moving mode of operation.

11. FCC INFORMATION

FCC IDENTIFIER	IVQ-RP1
Name of Grantee	Kustom Signals Inc.

The Raptor Rp-1 has been tested and found to comply with the limits pursuant to Part 15 of FCC Rules. These limits are designed to provide reasonable protection against harmful interference in a commercial environment. This equipment generates, uses, and can radiate radio frequency energy and, if not installed and used in accordance with the instruction manual, may cause harmful interference to radio communications. Operation of this equipment in a residential area is likely to cause harmful interference in which case the user will be required to correct the interference at his own expense.

Warning: Changes or modifications to this device not expressly approved by Kustom Signals Inc. could void the user's authority to operate the equipment.

Operation is subject to the following two conditions:
(1) This device may not cause harmful interference, and
(2) this device must accept any interference received, including interference that may cause undesired operation.

12. TROUBLESHOOTING

If an operating difficulty is encountered, check the following list of possible problems and solutions before returning the unit to the factory or local Service Center.

Problem	Possible Solution
----------------	--------------------------

No Power Indication	Check for proper voltage at cigarette plug. Reseat cigarette plug in the socket. Check fuses if using vehicle's cigarette socket.
Unit will not complete test cycle or shows test errors	Power the unit off, then back on. If the problem persists, remove unit from service and record the error message.
No speed reading during tuning fork tests	Verify that unit is in Test mode. Verify the proper tuning forks are being used. Verify unit is not in HOLD. Verify that the unit is in maximum range. Unsquench audio. Listen for Doppler tone. Lightly strike tuning fork to avoid harmonics. Remove unit from service if above tests fail.

SECTION 12—TROUBLESHOOTING

<p>No target readings in Stationary mode</p>	<p>Verify unit is not in HOLD.</p> <p>Verify range control is set properly.</p> <p>Verify unit is aimed properly and the target is within range of the radar.</p> <p>Unsilence audio and verify that a Doppler tone is heard when targets are present. If no Doppler tone is heard, remove unit from service.</p>
<p>No Patrol speed in moving mode.</p>	<p>Verify unit is not in HOLD.</p> <p>Verify the unit is aimed parallel to the ground and straight down the roadway.</p> <p>Verify there are no obstructions directly in front of the antenna.</p> <p>Weather conditions (heavy rain, snow or fog) may affect the unit's ability to pick up groundspeed.</p> <p>Verify speedometer input is synchronized properly.</p> <p>Verify the patrol speed is above patrol minimum setting and below 120 mph.</p> <p>Place unit in stationary mode and drive patrol vehicle. Verify Target area displays proper groundspeed. If no speed readings, remove unit from service.</p>

SECTION 12—TROUBLESHOOTING

<p>No target readings in moving mode</p>	<p>Verify unit is not in HOLD.</p> <p>Verify the range control is set properly.</p> <p>Verify proper patrol speed is displayed.</p> <p>Verify moving mode is selected.</p> <p>Target speed may be a harmonic of patrol speed. Speed up or slow down patrol vehicle.</p> <p>Remove unit from service if above tests fail.</p>
<p>Speedometer synchronization number shows “0”</p>	<p>Check speedometer input cable. Verify it is connected to the unit and to proper VSS input wire.</p> <p>Complete the speedometer synchronization procedure.</p> <p>If above tests fail, disconnect speedometer input cable, press TEST switch and continue using the radar.</p>
<p>Short range</p>	<p>Verify the range control is set for the desired distance to target vehicles.</p> <p>Verify the unit is aimed properly.</p> <p>Verify there are no obstructions between the antenna and the target.</p> <p>Weather conditions (heavy rain, snow and fog) may affect the unit’s range.</p> <p>Strong fan interference will reduce the operating range of the unit.</p> <p>Remove the unit from service if the above tests fail.</p>

13. DIRECTIONAL OPERATIONAL SUPPLEMENT

13.0 DIRECTIONAL OPERATION

The Raptor RP-1 uses state-of-the-art signal processing to determine the direction of travel of target vehicles. This additional information aids the officer in better target identification. This can be done by displaying the direction of travel with the motorist speed or by selecting the direction of vehicles to be displayed.

Definition of Terms:

STA ALL:	Stationary mode: Detects both approaching and receding vehicles. – “STA ALL” shown in the Patrol display area. The directional indicator above the Target display area will show the direction of target travel.
STA APR ONLY:	Stationary mode: Detects approaching vehicles only. – “STA APR ONLY” shown in the Patrol display area.
STA REC ONLY:	Stationary mode: Detects receding vehicles only. – “STA REC ONLY” shown in the Patrol display area.
Strongest Target:	Displays speed of strongest target vehicle signal regardless of speed.
Fastest Target:	Displays speed of fastest target vehicle, if this is not the strongest target signal.

13.1 STATIONARY ROAD GRAPHIC

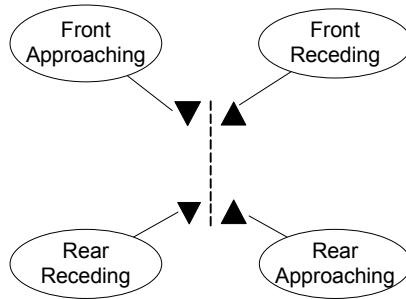

13.2 MOVING MODE ROAD GRAPHIC

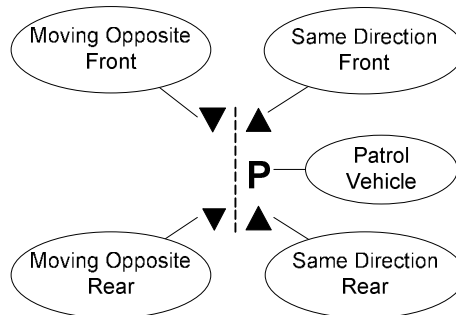

13.3 TEST MODE

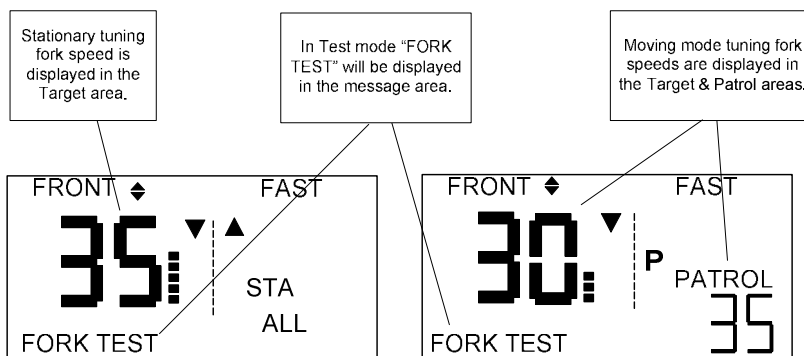

Pressing the Test (√) switch places the radar in **test** mode, which is indicated by the "FORK TEST" displayed in the message area. While in test mode, the radar will display all speeds, both moving targets and non-moving targets such as tuning forks. The unit will remain in test mode for 30 seconds. Selecting a new mode, such as changing from stationary to moving, will refresh the timeout to 30 seconds allowing fork testing of all modes.

NOTE: Pressing the test button while in test mode will turn off test mode immediately.

13.4 STATIONARY OPERATION

13.4.1 STATIONARY ALL

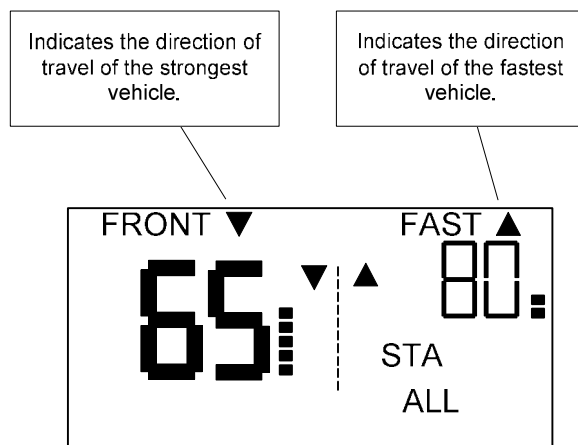

To monitor traffic in both directions (the Raptor RP-1 will automatically indicate which direction the strongest and fastest vehicles are traveling); repeatedly depress the MODE switch until “STA ALL” is displayed in the Patrol area.

When the radar is operated in the Stationary “ALL” mode, the roadway graphic will display both approaching and receding indicators. When a target is detected, the appropriate direction indicator (approaching or receding) will be displayed above the Target area.

If the “Fastest” function is activated, the appropriate fastest directional indicator (approaching or receding) will be displayed above the Fastest Target area.

The example shown is for an approaching 65 mph strongest vehicle and a receding 80 mph fastest vehicle.

13.4.2 STATIONARY APPROACHING ONLY

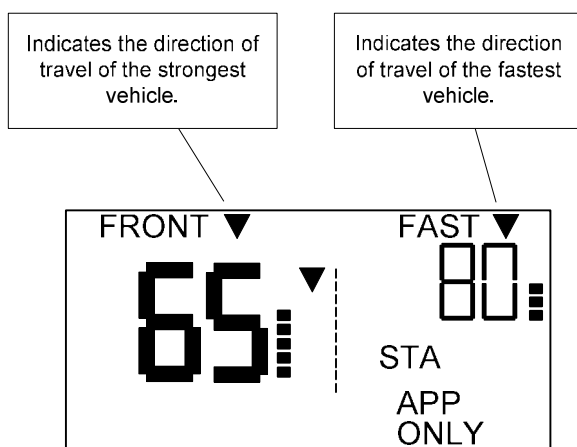

To activate the stationary, approaching targets only mode, repeatedly depress the MODE switch until “STA APR ONLY” appears in the Patrol area. All receding targets will be ignored in this mode.

When the radar is operated in the Stationary Approaching Only mode, the Target area will indicate the strongest approaching target speed. The road graphic indicator for approaching vehicles will be on.

If the “Fastest” function is activated, the Fastest Target area will display the fastest approaching target speed.

The example shown is for an approaching 65 mph strongest vehicle and an approaching 80 mph fastest vehicle.

13.4.3 STATIONARY RECEDING ONLY

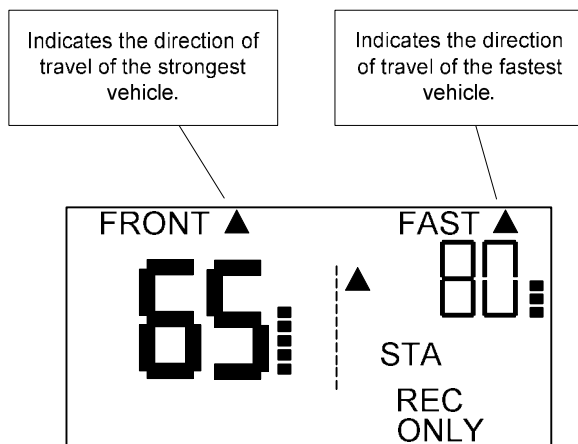

To activate the stationary, receding targets only mode, repeatedly depress the MODE switch until “STA REC ONLY” appears in the Patrol area. All approaching targets will be ignored in this mode.

When the radar is operated in the Stationary Receding Only mode, the Target area will indicate the strongest receding target speed. The road graphic indicator for receding vehicles will be on.

If the “Fastest” function is activated, the Fastest Target area will display the fastest receding target speed.

The example shown is for a receding 65 mph strongest vehicle and a receding 80 mph fastest vehicle.

13.5 MOVING MODE OPERATION

Patrol Speed:

In all moving mode operations the PATROL window indicates the speed of the patrol vehicle and the patrol road graphic indicator will be lit.

13.5.2 MOVING OPPOSITE

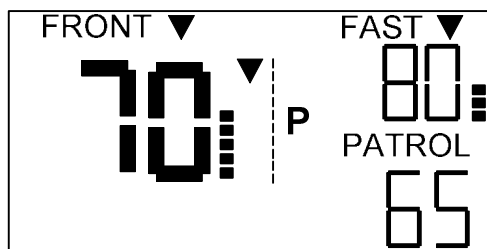

When operating the radar in Moving Opposite mode, the patrol vehicle and moving opposite road graphic will be on. The strongest vehicle speed will be displayed in the Target area.

If the “Fastest” function is activated, the Fastest Target area will display the fastest moving opposite target speed.

The example shown is for a patrol vehicle speed of 65 mph, a moving opposite 70 mph strongest vehicle, and a moving opposite 80 mph fastest vehicle.

13.5.2 MOVING SAME-DIRECTION

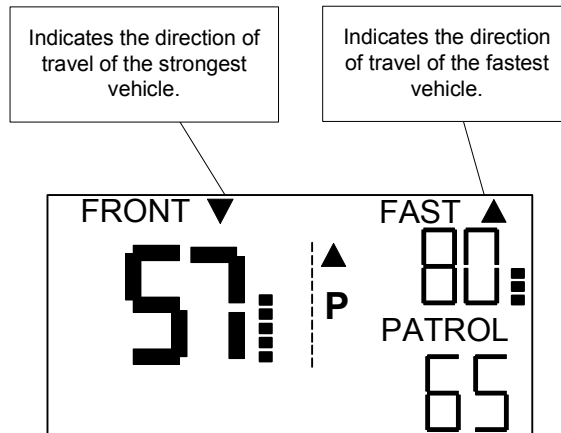

When operating the radar in Same-Direction mode, the patrol vehicle and same direction road graphic indicators will be on. The strongest vehicle speed will be displayed in the Target speed area. When a target is detected, the appropriate direction indicator (approaching or receding) will be displayed above the Target area

If the “Fastest” function is activated, the Fastest Target area will display the fastest moving same direction target speed. When a fastest target is detected, the appropriate fastest directional indicator (approaching or receding) will be displayed above the Fastest Target area

NOTE: The Raptor RP-1 does not require any input from the operator in Same Direction mode. The unit will automatically detect if the target vehicle is slower than the patrol vehicle and subtract the separation speed to always provide the operator the correct speed.

NOTE: In the Same-Direction Fastest Mode, the “fastest” target vehicle must be faster than the patrol vehicle by 3 MPH. EXAMPLE 1: Patrol vehicle = 65 MPH. Large target (strongest) = 43 MPH. Fastest vehicle = 56. In this event, no fastest speed would be displayed since the faster vehicle is SLOWER than the patrol vehicle.

EXAMPLE 2: Patrol vehicle = 65. Large target = 43 MPH. Fastest vehicle = 78 MPH. The PATROL window will display 65, the TARGET window will display 43 and the FAST window will display 78.

13.6 FASTEST LOCKING

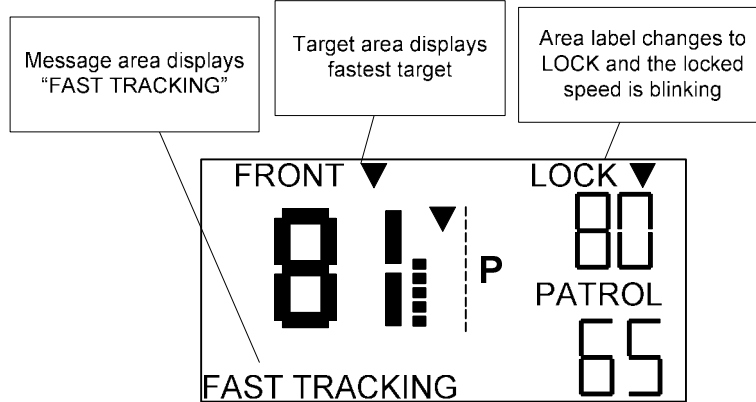

If the Lock button is pressed while tracking a fastest vehicle in any mode, the fastest speed will be locked and blinked in the Lock area, and fastest tracking will move to the Target area. The Message will display "FAST TRACKING" to alert the user the speed in the Target area is from the fastest target speed.

If there is no longer a vehicle to track after lock, the Message area will display "FAST LOCKED" to alert the user the current lock was made on a fastest target.

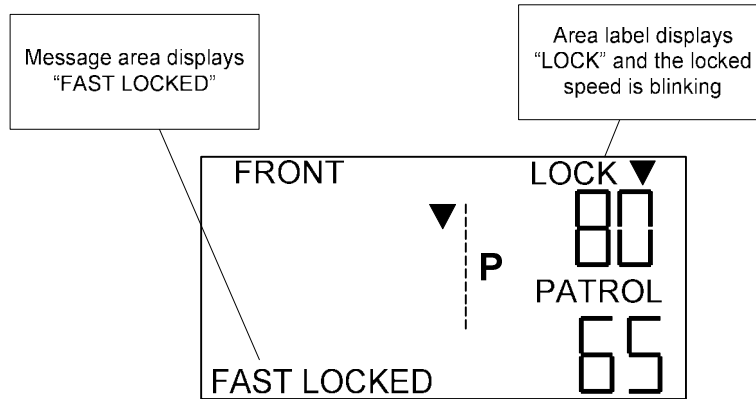

14. WARRANTY

The Kustom Signals *Traffic Safety Radar* system is guaranteed to be free of defects in materials and workmanship for a period of two (2) years from date of delivery to the Owner or Lessee.

- This Warranty applies only to the original registered Owner or Lessee on file at Kustom Signals, Inc., and cannot be assigned or transferred to a third party.
- The Owner or Lessee shall use the Equipment in accordance with the manufacturer's operational instructions.
- The Owner's or Lessee's exclusive remedy under this Warranty is limited to repair to the manufacturer's operational specifications or replacement, at the sole discretion of Kustom Signals, Inc. or its agent, of the Equipment as (i) is covered by this Warranty; (ii) is delivered to Kustom Signals, Inc. or its agent at the Owner's or Lessee's expense within the term of this Warranty; and (iii) upon examination thereof discloses to the exclusive satisfaction of Kustom Signals, Inc. or its agent to have been defective in material or workmanship. Warranty service and repairs must be performed by an Authorized Kustom Signals Warranty Service Center or the Factory Customer Service Center or this Warranty is void.
- Failure of the Owner or Lessee to observe any conditions set forth in this warranty; or equipment damage arising from flood, fire, vehicle collision, act of God or similar event or catastrophe; or tampering, abuse, or misuse of the equipment by Owner, Lessee or third party will render the Owner or Lessee responsible for the cost of bringing the system within the manufacturer's operational specifications.

- This warranty is not intended to supplant normal care and service by the Owner or Lessee, as specified in the Operator's Manual, and shall not apply to equipment that has been defaced or damaged through normal usage.
- The liability of Kustom Signals, Inc., if any, with respect to the equipment, shall be limited as provided in this Warranty. Kustom Signals, Inc. disclaims any obligation or liability for the loss of use of the Equipment warranted, loss of time, inconvenience, commercial loss or other direct, consequential, special or incidental damages. Kustom Signals, Inc. makes no warranties of any kind other than as herein expressly provided, expressed or implied, and specifically disclaims the implied warranties of merchantability and of fitness for a particular purpose. You may have additional rights under this Warranty that vary from state to state.
- No action for breach of this warranty may be commenced more than one year after the date of alleged breach.

EQUIPMENT SUPPLIED WITH CONSUMABLE ITEMS

Items such as tires, non-rechargeable batteries, light bulbs, transmitter carrying pouches, and microphone cables w/microphone and windscreen are considered consumable items and as such are not covered by this warranty.

SMART RADAR

SMART system radar units are warranted for two years, subject to the warranty terms listed above.

AIRBAG CAUTION

Equipment mounted in 1994 or later series police vehicles may interfere with the operation of passenger side airbags. Information is available directly from the automobile manufacturers regarding areas for safe mounting of equipment such as police radar.

Since this information will vary by vehicle make and model year, Kustom Signals recommends contacting the vehicle manufacturer and following their instructions with respect to mounting of radar units and other equipment.

For additional mounting suggestions, please contact the Kustom Signals Customer Service Department.

Kustom Signals cannot accept any liability for equipment, which has been mounted in conflict with the vehicle manufacturer's recommendation for proper airbag deployment.

PRINTER'S NOTES

1. Print Airbag Caution Sheet (located at back of manual) on green bond and insert between pages 3.6 and 4.1 in the manual.
2. Print Section A—Printer / DataLogger Optional Features (front and back) on Buff bond and insert between warranty section and radar log.

**DO NOT INCLUDE
THIS SHEET AS
PART OF THE
MANUAL.**

