



OWNER'S MANUAL
KG100FX212 GUITAR AMPLIFIER



Congratulations on the purchase of your new Kustom guitar amplifier.

Your KG Model draws on decades of amp design and manufacturing experience at Kustom. This model was built from the ground up to offer world-class tone, useful features and reliable performance. Inside this manual, you'll find valuable information about the amp's controls and specifications. Being familiar with its features will help you effectively dial in different tones.

We wish you many years of enjoyment with your Kustom amplifier.

FCC Statements

1. Caution: Changes or modifications to this unit not expressly approved by the party responsible for compliance could void the user's authority to operate the equipment.

2. Note: This equipment has been tested and found to comply with the limits for a Class B digital device, pursuant to Part 15 of the FCC Rules. These limits are designed to provide reasonable protection against harmful interference in a residential installation. This equipment generates, uses, and can radiate radio frequency energy and, if not installed and used in accordance with the instructions, may cause harmful interference to radio communications. However, there is no guarantee that interference will not occur in a particular installation. If this equipment does cause harmful interference to radio or television reception, which can be determined by turning the equipment off and on, the user is encouraged to try to correct the interference by one or more of the following measures:

- Reorient or relocate the receiving antenna.
- Increase the separation between the equipment and receiver.
- Connect the equipment into an outlet on a circuit different from that to which the receiver is connected.
- Consult the dealer or an experienced radio/TV technician for help.

ENGLISH

Danger

Exposure to extremely high noise levels may cause a permanent hearing loss. Individuals vary considerably to noise induced hearing loss but nearly everyone will lose some hearing if exposed to sufficiently intense noise for a sufficient time.

The U.S. Government's Occupational Safety and Health Administration (OSHA) has specified the following permissible noise level exposures:

DURATION PER DAY (HOURS)	8	6	4	3	2	1
SOUND LEVEL (dB)	90	93	95	97	100	103

According to OSHA, any exposure in the above permissible limits could result in some hearing loss. Ear plugs or protectors in the ear canal or over the ears must be worn when operating this amplification system in order to prevent a permanent hearing loss. If exposure in excess of the limits as put forth above, to insure against potentially harmful exposure to high sound pressure levels, it is recommended that all persons exposed to equipment capable of inducing high sound pressure levels, such as this amplification system, be protected by hearing protectors while this unit is in operation.

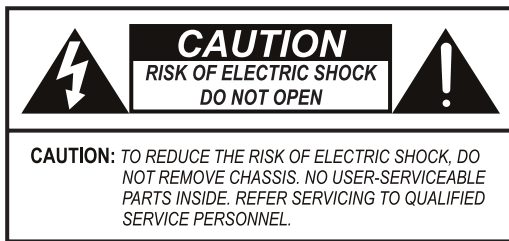

AVIS: RISQUE DE CHOC ELECTRIQUE-NE PAS OUVRIR.



THIS SYMBOL IS INTENDED TO ALERT THE USER TO THE PRESENCE OF NON-INSULATED "DANGEROUS VOLTAGE" WITHIN THE PRODUCT'S ENCLOSURE THAT MAY BE OF SUFFICIENT MAGNITUDE TO CONSTITUTE A RISK OF ELECTRIC SHOCK TO PERSONS.



THIS SYMBOL IS INTENDED TO ALERT THE USER TO THE PRESENCE OF IMPORTANT OPERATING AND MAINTENANCE (SERVICING) INSTRUCTIONS IN THE LITERATURE ACCOMPANYING THE UNIT.



APPARATUS SHALL NOT BE EXPOSED TO DRIPPING OR SPLASHING AND THAT NO OBJECTS FILLED WITH LIQUIDS, SUCH AS VASES, SHALL BE PLACED ON THE APPARATUS.

IMPORTANT SAFETY INSTRUCTIONS

1. Read all safety and operating instructions before using this product.
2. All safety and operating instructions should be kept for future reference.
3. Read and understand all warnings listed on the operating instructions.
4. Follow all operating instructions to operate this product.
5. This product should not be used near water, i.e. Bathtub, sink, swimming pool, wet basement, etc.
6. Only use dry cloth to clean this product.
7. Do not block any ventilation openings, It should not be placed flat against a wall or placed in a built-in enclosure that will impede the flow of cooling air.
8. Do not install this product near any heat sources ;such as,radiators, heat registers, stove or other apparatus (including heat producing amplifiers) that produce heat.
9. Do not defeat the safety purpose of the polarized or grounding-type plug. A polarized plug has two blades with one wider than the other. A grounding-type plug has two blades and a third grounding prong. The wide blade or the third prong are provided for your safety If the provided plug does not fit into your outlet, consult an electrician for replacement of the obsolete outlet.
10. Protect the power cord being walked on or pinched, particularly at Plugs, convenience receptacles and the point where they exit from the apparatus. Do not break the ground pin of the power supply cord.
11. Only use attachments specified by the manufacturer.
12. Use only with the cart, stand, tripod, bracket, or table specified by the manufacturer or sold with the apparatus. When a cart is used, use caution when moving cart/ apparatus combination to avoid injury from tip-over.
13. Unplug this apparatus during lightning storms or when unused for long periods of time.
14. Care should be taken so that objects do not fall and liquids are not spilled into the unit through the ventilation ports or any other openings.
15. Refer all servicing to qualified service personnel. Servicing is required when the apparatus has been damaged in any way; such as, power-supply cord or plug is damaged, liquid has been spilled or objects have fallen into the apparatus, the apparatus has been exposed to rain or moisture, does not operate normally or has been dropped.
16. **WARNING:** To reduce the risk of fire or electric shock, do not expose this apparatus to rain or moisture.
17. When the MAINS plug, or an appliance coupler, is used as the disconnect device, the disconnect device shall remain readily operable.



FRENCH

Danger

L'exposition a des niveaux eleves de bruit peut provoquer une perte permanente de l'audition, Chaque organisme humain reagit differemment quant a la perte de l'audition, mais quasiment tout le monde subit une diminution de l'acuite auditive lors d'une exposition suffisamment longue au bruit intense. Les autorites competentes en reglementation de bruit ont defini les expositions tolerees aux niveaux de bruits:

DURE EN HEURES PAR JOUR	8	6	4	3	2	1
INIVEAU SONORE CONTINU EN dB	90	93	95	97	100	103

Selon les autorites, toute exposition dans les limites citees ci-dessus, peuvent provoquer certaines pertes d'audition. Des bouchons ou protections dans l'appareil auditif ou sur l'oreille doivent etre portes lors de l'utilisation de ce systeme d'amplification afin de prevenir le risque de perte permanente de l'audition, Dans le cas d'expositions superieures aux limites precitees il est recommande, afin de se premunir contre les expositions aux pressions acoustiques elevees potentiellement dangeureuses, aux personnes exposees aux equipements capables de delivrer de telles puissances, tels ce systeme d'amplification en fonctionnement, de proteger l'appareil auditif.



CE SYMBOLE A POUR BUT D'AVERTIR L'UTILISATEUR DE LA PRESENCE DE VOLTAGE DANGEREUX NON-ISOLE A L'INTERIEUR DE CE PRODUIT QUI PEUT ETRE DE PUISSANCE SUFFISAMMENT IMPORTANTE POUR PROVOQUER UN CHOC ELECTRIQUE AUX PERSONNES.



CE SYMBOLE A POUR BUT D'AVERTIR L'UTILISATEUR DE LA PRESENCE D'INSTRUCTIONS D'UTILISATION ET DE MAINTENANCE DANS LES DOCUMENTS FOURNIS AVEC CE PRODUIT.



AFIN DE REDUIRE LES RISQUÉ D'INCENDIE ET DE DECHARGE ELECTRIQUE, NE PAS EXPOSER CET APPAREIL A LA PLUIE OU A L'HUMIDITE.

IMPORTANTES INSTRUCTIONS DE SECURITE

1. Lire avec attention toutes les recommandations et précautions d'emploi avant d'utiliser ce produit.
2. Toutes les recommandations et précautions d'emploi doivent être conservées afin de pouvoir s'y reporter si nécessaire.
3. Lire et comprendre tous les avertissements énumérés dans les précautions d'emploi.
4. Suivre toutes les précautions d'emploi pour utiliser ce produit.
5. Ce produit ne doit pas être utilisé près d'eau, comme par exemple baignoires, éviers, piscine, sous-sol humides ... Etc.
6. Utiliser exclusivement un chiffon sec pour nettoyer ce produit.
7. Ne bloquer aucune ouverture de ventilation. Ne pas placer le produit tout contre un mur ou dans une enceinte fermée, cela gênerait le flux d'air nécessaire au refroidissement.
8. Ne pas placer le produit près de toute source de chaleur telle que radiateurs, arrivées d'air chaud, fourneaux ou autres appareils générant de la chaleur (incluant les amplificateurs producteurs de chaleur) .
9. Ne pas négliger la sécurité que procure un branchement polarisé ou avec raccordement à la terre, Un branchement polarisé comprend deux fiches dont l'une est plus large que l'autre. Un branchement à la terre comprend deux fiches plus une troisième reliée à la terre. Si la fiche secteur fournie ne s'insert pas dans votre prise de courant. consulter un 'électricien afin de remplacer votre prise obsolète.
10. Protéger le cordon d'alimentation de tout écrasement ou pincement, particulièrement au niveau des fiches, des réceptacles utilisés et à l'endroit de sortie de l'appareil. Ne pas casser la fiche de terre du cordon d'alimentation.
11. Utiliser uniquement les accessoires spécifiés par le constructeur.
12. Utiliser uniquement avec le chariot de transport, le support, le trépied, la console ou la table spécifiés par le constructeur ou vendus avec l'appareil. Lors de l'utilisation d'un chariot, bouger avec précaution l'ensemble chariot/appareil afin d'éviter les dommages d'un renversement.
13. Débrancher cet appareil lors d'orages ou s'il n'est pas utilisé pendant une longue période.
14. Des précautions doivent être prises afin qu'aucun objet ne tombe et qu'aucun liquide ne se répande à l'intérieur de l'appareil par les orifices de ventilation ou n'importe quelle autre ouverture.
15. Pour toutes interventions techniques s'adresser à un technicien qualifié. L'intervention technique est nécessaire lorsque l'appareil a été endommagé de n'importe quelle façon, comme par exemple si le cordon secteur ou sa fiche sont détériorés, si du liquide a coulé ou si des objets sont tombés à l'intérieur de l'appareil, si l'appareil a été exposé à la pluie ou à l'humidité, s'il ne fonctionne pas normalement ou s'il est tombé.
16. ATTENTION: Pour réduire le risque d'incendie ou de choc électrique ne pas exposer l'appareil à la pluie ou à l'humidité.
17. Quand la prise MAINS, au coupler, est utilisé pour la source d'alimentation électrique, il est conseillé de garder cette prise facilement accessible.



KG100FX212 Control Panel

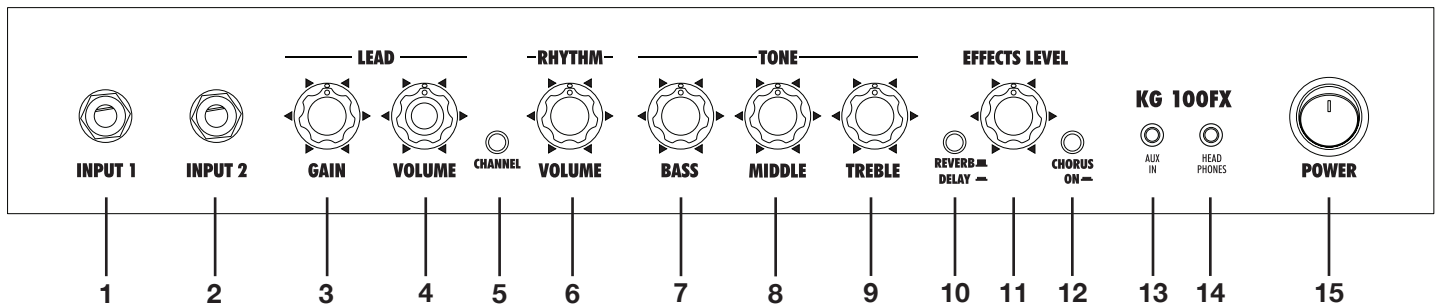

- 1. Input 1:** ¼-inch input jack that is intended for electric guitars but will accept other instruments as well. This input provides the highest gain. It is considered to be the “normal” input.
- 2. Input 2:** This ¼-inch input jack provides 6 dB lower gain so it will allow for a cleaner sound. It can also be useful when using pedals in front of the amp since it provides more headroom. If guitars are plugged into both inputs, they will mix together and both will be 6 dB lower in gain.
- 3. Gain (Lead):** Adjust this control clockwise to increase the amount of distortion. Use in its lower ranges to produce less distorted tones. As you increase the amount of gain, the tonality will shift from a classic rock-type sound to a heavier, modern tone.
- 4. Volume (Lead):** This controls the overall volume level of the Lead channel only.
- 5. Channel:** This switch selects between the Lead and Rhythm channels.
- 6. Volume (Rhythm):** This controls the overall volume level of the Rhythm channel only.
- 7. Bass:** This controls the bass frequencies for both channels. For a “tighter” bass response, set the Bass control in its lower ranges.
- 8. Middle:** This controls the middle frequencies for both channels. For a heavier, more distorted sound, set the Middle control in its lower ranges. For a vintage-style, cleaner tone, set the Middle higher.
- 9. Treble:** This controls the treble frequencies for both channels. Set this control in its higher ranges to brighten up dark-sounding guitars or, alternately, in its lower ranges to reduce brightness.
- 10. Reverb/Delay:** This switch selects between Delay or Reverb effects. Press switch in to choose Delay.
- 11. Effects Level:** This control increases the effect signal level and mixes it with the instrument’s signal. Turn this control clockwise to add the desired level of effects.
- 12. Chorus On:** By pressing in, this switch activates a lush Chorus effect.
- 13. Aux In:** This is a 3-conductor, 1/8-inch, stereo jack that allows playback from a Compact Disc, MP3 player or other audio device. The overall volume level will be determined by the audio device, so start with lower volume levels and increase as needed.
- 14. Headphones:** This is a 3-conductor, 1/8-inch input jack intended for headphone use. The amplifier’s internal speakers are disconnected when this jack is used.
- 15. Power Switch:** This dual-function component is both an On/Off power switch and a status indicator light. When illuminated, it shows that your amplifier is ready to be played. To turn amplifier on, press switch upward. To turn amp off, press switch downward.

KG100FX212 Back Panel

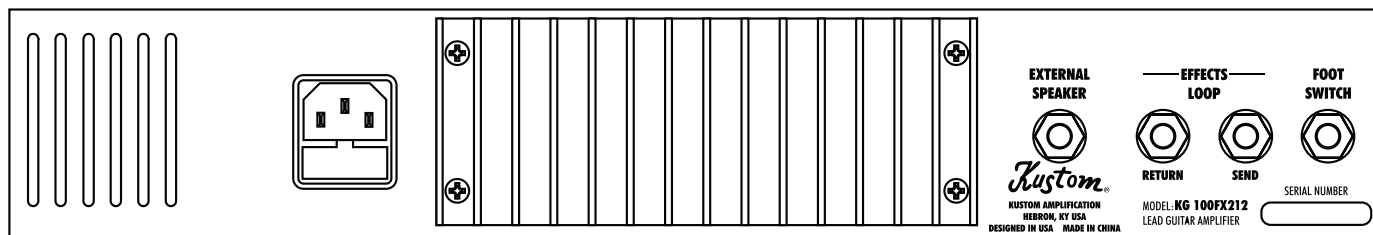

External Speaker: This is a two-conductor, ¼-inch external speaker jack. (Note: This jack is wired in series with the amp’s internal speakers. Therefore, the internal speakers still function when an external speaker cabinet is added. For this reason, there is no minimum external speaker impedance load.)

Footswitch: This amplifier provides foot-switchable channels and a “hidden” volume boost feature that works on either channel to help make solos stand out in the mix. These features may be accessed in the following ways:

- 1) By connecting a single-function footswitch with a stereo cable to the Footswitch jack on the amplifier’s back panel, users may change channels on the amp while playing. The boost feature will not be active. If a single-function footswitch is used with a mono cable, such as a guitar cable, users may still change channels on the amp while playing, but the boost feature will always be active. Kustom offers the model KACFS-100 single-function footswitch which comes with a stereo cable. It may be ordered from a Kustom dealer.
- 2) By connecting a dual-function footswitch, both channel-switching and the boost feature may be activated. The Kustom KACFS201 dual-function footswitch will switch channels and activate the boost function. It may be ordered from a Kustom dealer.

Note 1: On the KACFS201 footswitch, channel-switching is labeled “Channel” and boost is labeled “Effect.”

Note 2: When no footswitch is attached to the amplifier, the “hidden boost” feature is not active.

Effects Loop Send: Use this 2-conductor, ¼-inch jack to connect to the input of an external effects processor or equalizer. This jack can also be used as a Preamp Out.

Effects Loop Return: Use this 2-conductor, ¼-inch jack to connect to the output of an external effects processor or equalizer. This jack can also be used as a Power Amp In. (Note: This jack separates the preamp from the power amp. If using an external effect, the effect will be in series between the Effects Loop Send and Effects Loop Return. The amount of “dry” signal will be controlled by the external effect.)

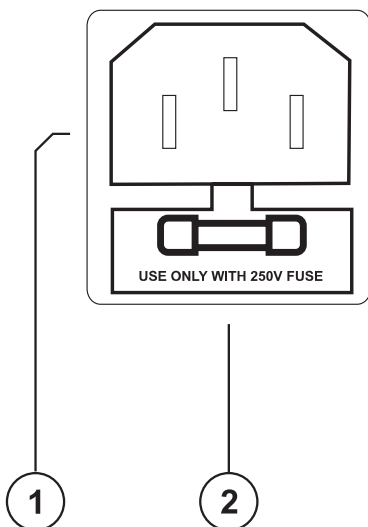

KG100FX212 AC Mains

1. AC Power Cord Receptacle: AC power cord can be removed for easy storage and replacement if damaged. Insert the AC cord (provided) firmly into the AC receptacle. **NOTE:** Replace the AC power cord if protective jacket is damaged or ground pin is damaged or removed.

2. Fuse: The fuse is located in a fuse tray just below the receptacle. Replace only with the same type and size. For your convenience, a spare fuse is located inside the fuse tray toward the front. To replace fuse, remove AC power cord. Remove fuse tray by pulling the tab located above the fuse symbol away from the receptacle.

KG100FX212 Suggested Settings

The following suggested settings will help you dial in a variety of popular tones. Keep in mind, these are starting points to get you up and running with your KG amplifier. Feel free to experiment to achieve your own signature sounds.

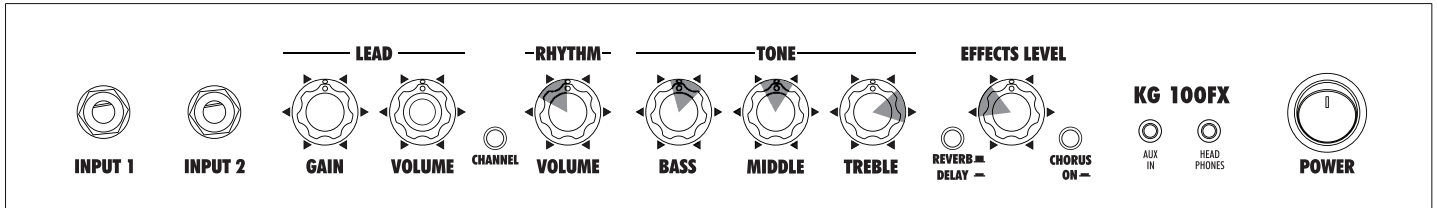

CLEAN GUITAR

These settings are for punchy clean tones that are commonly used in Pop, Country, Alternative and many other genres of music. Use the Rhythm channel with the tone controls set to emphasize brighter sounds. The Bass control should be adjusted to maintain the clarity of the overall tone. Add Reverb and Chorus as desired.

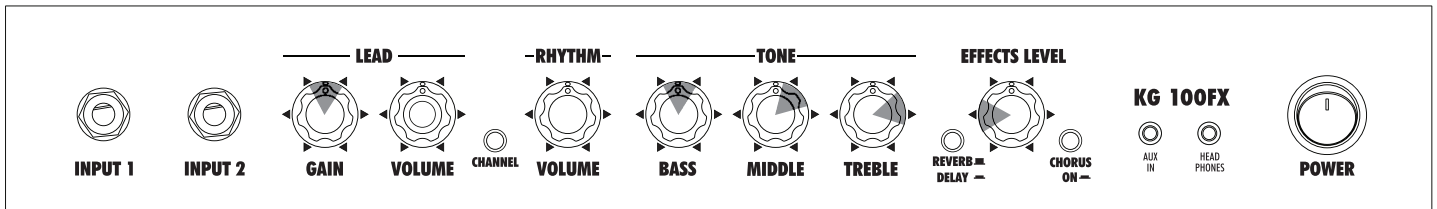

MEDIUM-GAIN GUITAR

These settings are appropriate for Rock, Blues or other music styles that require a moderate amount of distortion. Use the Lead channel with the Gain set to its middle ranges. Likewise, keep the Mid control in its middle ranges but increase the amount of Treble to maintain clarity.

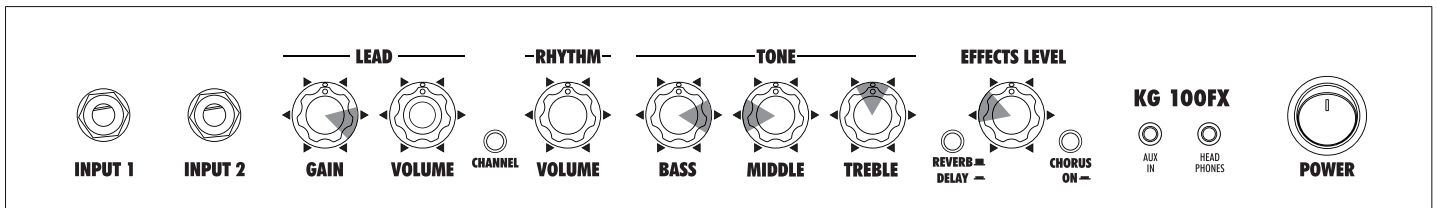

HIGH-GAIN GUITAR

Try these setting ranges when you want to produce the heaviest tones. Notice that the Gain control is cranked up, the amount of Bass is increased and Midrange is reduced for a heavy, modern vibe. Experiment by adding a bit of Delay to high-gain solos.

Kustom® KG100FX212 Specifications

Output Power	100 Watts RMS	4 Ohms at 5% THD
Speaker	2 x 12"	60 watt 8 Ohm Special Design
Input Impedance	470K	
Hum & Noise	-56dB	Residual noise, all level controls 0% (minimum)
Lead Gain	96 dB	Lead Gain and Volume controls full
	70 dB	Lead Gain and Volume controls half way
Clean Gain	60 dB	Clean volume control full
	45 dB	Clean volume control halfway
Nominal Signal to Noise	75 dB	Volumes and Gain halfway
Footswitch	Kustom KACFS-100 / KACFS-201	See Footswitch text in Back Panel description
Effects	4 selectable digital effects	Reverb, Delay, Chorus/Reverb, Chorus/Delay
Power Requirements	USA/Canada	120VAC/60Hz, 180W
	Europe	230VAC/50Hz, 180W
	UK	230VAC/50Hz, 180W
	Australia	240VAC/50Hz, 180W
	Japan	100VAC/50-60Hz, 180W
Dimensions/Weight	mm/Kilogram	505 (Height) X 666 (Width) X 277 (Depth), 20 Kilogram
	Inches/Pounds	19.8 (Height) X 26.2 (Width) X 10.9 (Depth), 44.1 Lbs

KG100FX212 Signal Flow Diagram

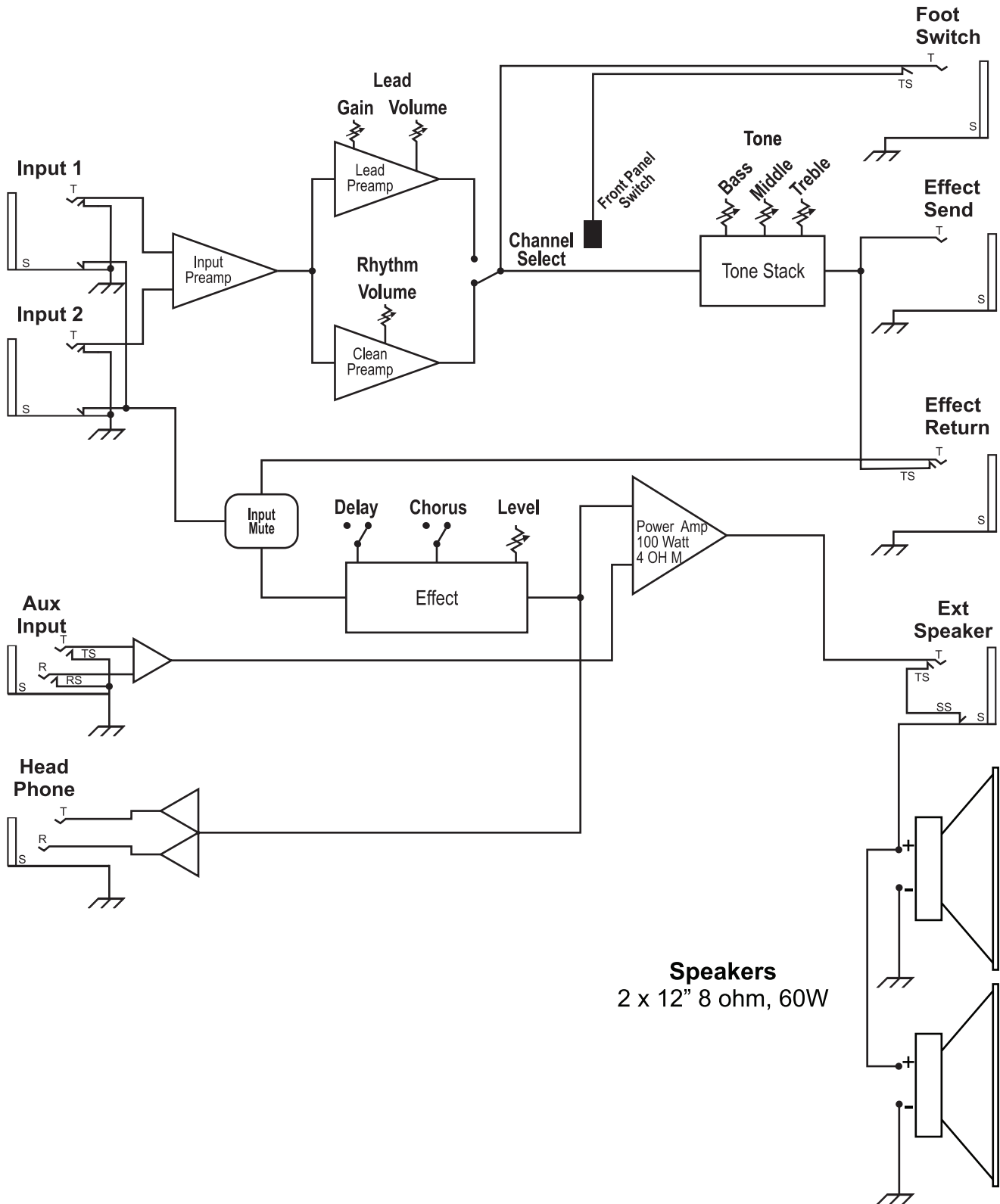

Speakers
2 x 12" 8 ohm, 60W

EC Declaration of Conformity

We: Kustom Musical Amplification Inc.
3015 Kustom Drive
Hebron, Ky 41048-0568
Tel: 1-859-817-7100 Fax: 1-859-817-7150

Declare that the product

Product name: Kustom

Product model number: KG100FX212

to which this declaration relates is in conformity with the following standards;

EN55013 (A12): 1995	Limits and methods of measurement of radio disturbance characteristics of broadcast receivers and associated equipment.
EN55020: 1995	Electromagnetic immunity of broadcast receivers and associated equipment.
EN61000-3-2: 1995	Limits for harmonic current emissions (equipment input current \leq 16A per phase).
EN61000-3-3: 1995	Limitation of voltage fluctuations and flicker in low voltage supply systems for equipment with rated currents \leq 16A.
EN55103-1: 1995	Electromagnetic Compatibility - Product family standard for Audio, Video Audio-visual and entertainment Lighting Control Apparatus.
EN60065: 1994	Safety requirements for main operated electronic and related apparatus for household and similar general use.

Following the provisions of EU Council Directive(s): 72/73 EEC and 89/336/EEC.

We the undersigned, hereby declare that the equipment specified above conforms to the aforementioned directive(s).

Name of authorized person: James Brown, Chief Engineer

Signature:

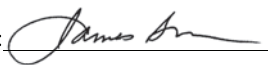

Date: 12 February 2010

Kustom Musical Amplification Inc.
3015 Kustom Drive
Hebron, Ky 41048-0568
Tel: 1-859-817-7100 Fax: 1-859-817-7150



www.kustom.com

Kustom Amplification, Inc.
3015 Kustom Drive
Hebron, Kentucky
USA 41048
888-4-KUSTOM (888-458-7866)

All specifications are subject to change without prior notice. ©2010 Kustom

