

E4255 (F-35)

# [KYOCERA DuraMax]

## User Guide



©2011 Sprint. SPRINT and the logo are trademarks of Sprint. KYOCERA is a registered trademark of Kyocera Corporation. Other marks are the property of their respective owners.

# Table of Contents

---

Get Started.....	1
Your Phone at a Glance.....	1
Set Up Your Phone .....	2
Activate Your Phone .....	2
Set Up Voicemail.....	3
Sprint Account Information and Help .....	4
Sprint Account Passwords .....	4
Manage Your Account.....	4
Sprint Support Services.....	5
Phone Basics .....	6
Your Phone’s Layout.....	7
Key Functions .....	7
Turn Your Phone On and Off .....	9
Battery and Charger.....	9
View the Display Screen .....	10
Navigate Through the Menus.....	14
Display Your Phone Number .....	14
Enter Text.....	15
Select a Text Input Mode .....	15
T9 Text Input.....	16
ABC Mode .....	16
Set Text Entry Options .....	16
Simple Data Exchange.....	17
Phone Calls & Settings.....	20
Make Phone Calls .....	20
Call Using the Phone Keypad .....	20
Call With the Phone Closed .....	21
Call From History.....	21
Call From Contacts.....	21
Call Using the Plus (+) Code.....	22

Call Using a Speed Dial Number .....	22
Call Using Abbreviated Dialing Features .....	22
Call a Phone Number With Pauses.....	23
Call a Phone Number in a Message .....	23
Call Emergency Numbers .....	24
Receive Phone Calls.....	25
Answer an Incoming Call With the Phone Open.....	25
Answer an Incoming Call With the Phone Closed .....	25
Answer an Incoming Call in Speakerphone Mode.....	26
Answer a Roam Call With Roaming Guards Enabled .....	26
Mute the Ringer and Stop the Vibration.....	26
Send an Incoming Call to Voicemail .....	26
Reject an Incoming Call .....	26
Reject an Incoming Call and Send a Message.....	26
In-call Options.....	26
End Phone Calls.....	27
Missed Call Notification.....	27
Voicemail.....	27
Set Up Voicemail .....	27
Voicemail Notification .....	28
New Voicemail Message Alerts.....	28
Retrieve Your Voicemail Messages .....	29
Phone Call Options .....	29
Caller ID.....	29
Call Waiting.....	30
3-Way Calling .....	30
Call Forwarding .....	30
Phone Call Settings.....	31
Call Answer Mode .....	31
Auto-Answer Mode .....	31
Alert Notification .....	32
Airplane Mode.....	32
TTY Use With Sprint Service.....	32

Hearing Aid Device Compatibility .....	33
Sprint Direct Connect.....	35
About Sprint Direct Connect .....	35
Before Making Your First Direct Connect Call.....	35
Your Direct Connect Number .....	36
Dial Direct Connect Numbers.....	36
Save a Direct Connect Number .....	37
Display Your Direct Connect Number .....	38
Make and Answer Direct Connect Calls .....	38
Make a Direct Connect Call by Entering a Number .....	38
Make a Direct Connect Call From Contacts .....	39
Make a Direct Connect Call From History.....	39
Make a Direct Connect Call Using a Speed Dial Number .....	40
Make a Direct Connect Call With the Phone Closed .....	40
Answer Direct Connect Calls.....	41
End a Direct Connect Call .....	41
Direct Connect Permissions .....	42
Call Alerts .....	43
Send a Call Alert.....	43
Reply to a Call Alert.....	44
Group Connect .....	44
Make Group Connect Calls .....	44
Group Connect Call Information.....	46
Invites .....	46
Send an Invite.....	46
Reply to an Invite.....	47
TeamDC .....	47
Set Up a TeamDC Group .....	48
Update TeamDC Groups.....	48
Make a TeamDC Call .....	48
Remove Yourself from a TeamDC Group.....	49
TeamDC Call Information.....	49
Settings .....	50

Display Settings.....	50
Change the Screen Saver .....	50
Change the Brightness .....	51
Change the Backlight Settings .....	51
Set the Notification Pop-up.....	51
Select a Picture ID .....	51
Power Save Mode .....	52
Change the Clock/Calendar Display .....	52
Set a Custom Greeting .....	52
Change the Phone's Menu Style.....	52
Change the Font Size.....	52
Display Language .....	53
Volume Settings .....	53
Adjust the Phone's Volume Settings .....	53
Silence All .....	53
Ringer Settings.....	54
Ringers.....	54
Set Up Voice Guide .....	55
Select a Vibration Pattern.....	55
Messaging Settings.....	56
Set Clear Alerts Icon.....	56
Message Alerts .....	56
Set a Callback Number .....	56
Add a Customized Signature .....	56
Manage Preset Messages.....	57
Long Message Reassembly .....	57
Phone Setup Options .....	57
Navigation Key Shortcuts .....	58
Direct Connect Button .....	58
Keyguard .....	58
Headset Mode .....	58
Roaming .....	59
Roaming on Other Networks.....	59

Roaming Settings .....	60
Roaming Guards .....	60
Security Settings .....	62
Lock Your Phone .....	62
Limit Use .....	63
Delete Phone Content .....	64
Reset Your Phone and Phone Content.....	65
Security Features for Data Services .....	65
History .....	67
View History .....	67
The History List.....	67
History Icons .....	67
History Thread .....	68
History Details.....	68
History Options.....	68
Make a Call From History .....	69
Save the Information in Your History .....	69
Save a Number From History.....	70
Save a Group From History.....	70
Make a New Group Entry From History .....	70
Delete History .....	70
Contacts .....	72
About Contacts.....	72
View Contacts .....	72
The Contacts List.....	73
Contacts Details .....	73
View History From Contacts.....	73
Create a New Contacts Entry .....	73
Create a Personal Entry .....	73
Create a Group Entry .....	74
Save a Number Using the Phone Keypad .....	74
Edit a Contacts Entry .....	75
Edit a Contacts Entry.....	75

Delete a Contacts Entry .....	75
Add a Number to a Personal Entry .....	75
Assign a Ringer to a Personal Entry .....	76
Assign a Picture to a Personal Entry .....	76
Add Members to a Group Entry .....	76
Remove Members From a Group Entry .....	77
Find Contacts Entries .....	77
Find an Entry From Contacts .....	77
Find an Entry Using the Phone Keypad .....	78
Use Contacts Information in Other Applications .....	78
Assign Speed Dial Numbers .....	79
Secret Contacts Entries .....	79
Dial Sprint Services .....	80
Sprint Mobile Sync .....	80
Messaging .....	82
Text Messaging and Multimedia Messaging .....	82
Compose Messages .....	82
Access Messages .....	83
Threaded Messaging .....	83
Email .....	85
Calendar & Tools .....	86
Calendar .....	86
Add an Event to the Calendar .....	86
Add a To Do List Item to the Calendar .....	87
Calendar Alerts .....	88
View Events .....	88
Delete Events .....	88
Alarm .....	89
Bluetooth .....	90
Turn Bluetooth On and Off .....	90
Make Your Phone Discoverable .....	90
Bluetooth Menu .....	91
Pair Bluetooth Devices .....	91

View the Trusted Devices List.....	92
Send Items via Bluetooth .....	93
microSD Card.....	93
Remove or Insert the microSD Card.....	93
microSD Card Settings.....	95
microSD Card Folders.....	96
File Manager.....	96
Connect Your Phone to Your Computer .....	97
Voice Services.....	98
Automatic Speech Recognition (ASR) .....	98
Manage Voice Memos.....	102
Calculator .....	103
World Clock.....	104
Countdown Timer.....	104
Stopwatch.....	104
Camera .....	106
Take Pictures .....	106
Take a Picture.....	106
Assign Pictures.....	107
Camera Mode Options .....	107
Camera Settings.....	109
Record Videos.....	109
Record a Video .....	109
Camcorder Mode Options .....	110
Camcorder Settings.....	111
Store Pictures and Videos .....	111
Set Storage Options .....	112
In Phone Folder .....	112
On Memory Card Folder.....	112
In Phone and Memory Card Folder Options .....	112
Review Pictures and Videos in the Assigned Media Folder .....	113
Send Pictures and Videos.....	113
Send Pictures and Videos Using the Messaging Feature .....	114



Send Pictures and Videos Using the Bluetooth Feature .....	114
Print Pictures .....	114
Print Pictures From Your Phone .....	115
Digital Print Order Format (DPOF) .....	116
Web and Data .....	117
Data Services .....	117
Your User Name .....	117
Launch a Web Connection .....	118
Data Connection Status and Indicators .....	118
Browser .....	118
Learn to Navigate the Web.....	118
Browser Menu.....	120
Download Games, Ringers, and More.....	122
GPS Navigation .....	125
GPS Services .....	125
GPS Navigation.....	125
Sprint Family Locator .....	126
Copyrights .....	128
Index.....	129

# Get Started

This section gives you all the information you need to set up your phone and Sprint service the first time.

[Your Phone at a Glance](#)

[Set Up Your Phone](#)

[Activate Your Phone](#)

[Set Up Voicemail](#)

[Sprint Account Information and Help](#)

## Your Phone at a Glance



# Set Up Your Phone

You must first install and charge the battery to begin setting up your phone.

1. Install the battery.
  - Insert the battery into the battery compartment, making sure the connectors align (1). Gently press down to secure the battery (2).
  - Align the tabs of the battery cover with the slots (3) and press the battery cover down until it snaps into place (4).
  - Slide the battery cover release latch to the locked position (5).

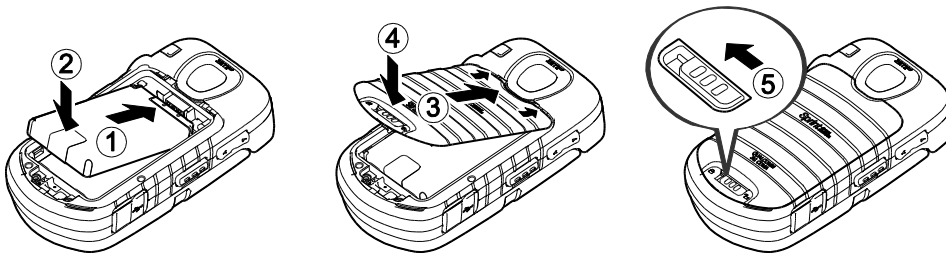

2. Charge your battery.
  - Plug the USB connector into the charger/accessory jack on the lower left side of your phone.
  - Plug the AC adapter into an electrical outlet.

**Note:** Your phone's battery should have enough charge for your phone to turn on and find a signal, set up your voicemail, and make a call. You should fully charge your battery as soon as possible.

3. Press  to turn the phone on.
  - If your phone is activated, it will search for Sprint service and enter standby mode.
  - If your phone is not yet activated, see [Activate Your Phone](#) for more information.

## Activate Your Phone

Depending on your account or how and where you purchased your phone, it may be ready to use or you may need to activate it on your Sprint account.

- If you purchased your phone at a Sprint Store, it is probably activated and ready to use.

- If you received your phone in the mail and it is for a new Sprint account or a new line of service, it is designed to activate automatically.
- If you received your phone in the mail and you are activating a new phone for an existing number on your account (you're swapping phones), you can activate on your computer online or directly on your phone.
  - **Activate on your computer:**
    - Go to [sprint.com/activate](http://sprint.com/activate) and follow the instructions to activate your phone.
  - **Activate on your phone:**
    - Turn on your new phone. (Make sure the old one is turned off.) Your phone will automatically attempt Hands-Free Activation. Follow the onscreen prompts to complete the activation process.
    - If an error occurs, press **ACTIVATE** (left softkey) to override auto-activation and start the manual activation wizard. Follow the onscreen prompts to complete the activation process.
- To confirm activation, make a phone call. If your phone is still not activated or you do not have access to the Internet, contact Sprint Customer Service at **1-888-211-4727** for assistance.

**Tip:** Do not press **END** while the phone is being activated. Pressing **END** cancels the activation process.

**Note:** If you are having any difficulty with activation, contact Sprint Customer Service by calling **1-888-211-4727** from any other phone.

## Set Up Voicemail

Your phone automatically transfers all unanswered calls to your voicemail, even if your phone is in use or turned off. You should set up your Sprint Voicemail and personal greeting as soon as your phone is activated. Always use a password to protect against unauthorized access.

1. Press and hold **1** in standby mode to dial your voicemail number.
2. Follow the system prompts to:
  - Create your password.
  - Record your name announcement.
  - Record your greeting.

**Note: Voicemail Password** – Sprint strongly recommends that you create a password when setting up your voicemail to protect against unauthorized access. Without a password, anyone who has access to your phone is able to access your voicemail messages.

## *Sprint Account Information and Help*

Find out about account passwords and information about managing your account and finding help.

[Sprint Account Passwords](#)

[Manage Your Account](#)

[Sprint Support Services](#)

### *Sprint Account Passwords*

As a Sprint customer, you enjoy unlimited access to your personal account information, your voicemail account, and your data services account. To ensure that no one else has access to your information, you will need to create passwords to protect your privacy.

#### *Account User Name and Password*

If you are the account owner, you will create an account user name and password when you sign on to [sprint.com](#). (Click **Sign in/Sign up** and then click **Sign up now!** to get started.) If you are not the account owner (if someone else receives the bill for your Sprint service), you can get a sub-account password at [sprint.com](#).

#### *Voicemail Password*

You'll create your voicemail password when you set up your voicemail. See [Set Up Voicemail](#) for more information on your voicemail password.

#### *Data Services Password*

With your Sprint phone, you may elect to set up an optional data services password to control access and authorize Premium Service purchases.

For more information, or to change your passwords, sign on to [sprint.com](#) or call Sprint Customer Service at **1-888-211-4727**.

### *Manage Your Account*

Manage your Sprint account from your computer, your Sprint phone, or any other phone.

**Online:** [sprint.com](#)

- Access your account information.
- Check your minutes used (depending on your Sprint service plan).

- View and pay your bill.
- Enroll in Sprint online billing and automatic payment.
- Purchase accessories.
- Shop for the latest Sprint phones.
- View available Sprint service plans and options.
- Learn more about data services and other products like games, ringers, screen savers, and more.

### From Your Sprint Phone

- Press **\*SHR 4 OH TALK** to check minute usage and account balance.
- Press **\*SHR 3 OFF TALK** to make a payment.
- Press **\*SHR 2 ABC TALK** to access a summary of your Sprint service plan or get answers to other questions.

### From Any Other Phone

- Sprint Customer Service: **1-888-211-4727**.
- Business Customer Service: **1-888-788-4727**.

## *Sprint Support Services*

### *Sprint 411*

Sprint 411 gives you access to a variety of services and information, including residential, business, and government listings; movie listings or showtimes; driving directions, restaurant reservations, and major local event information. You can get up to three pieces of information per call, and the operator can automatically connect your call at no additional charge.

There is a per-call charge to use Sprint 411, and you will be billed for airtime.

▶ Press **4 OH 1 1 TALK**.

### *Sprint Operator Services*

Sprint Operator Services provides assistance when you place collect calls or when you place calls billed to a local telephone calling card or third party.

▶ Press **0+ TALK**.

For more information or to see the latest in products and services, visit us online at [sprint.com](http://sprint.com).

# Phone Basics

---

Your phone is packed with features that simplify your life and expand your ability to stay connected to the people and information that are important to you. The topics in this section will introduce the basic functions and features of your phone.

**Tip:** **Phone Software Upgrades** - Updates to your phone's software may become available from time to time. Sprint will automatically upload critical updates to your phone. You can also use the menu to check for and download updates. Press  > **Tools** > **Update Phone** > **Update Firmware** to search for and download available updates.

[Your Phone's Layout](#)

[Turn Your Phone On and Off](#)

[Battery and Charger](#)

[View the Display Screen](#)

[Navigate Through the Menus](#)

[Display Your Phone Number](#)

[Enter Text](#)

[Simple Data Exchange](#)

# Your Phone's Layout

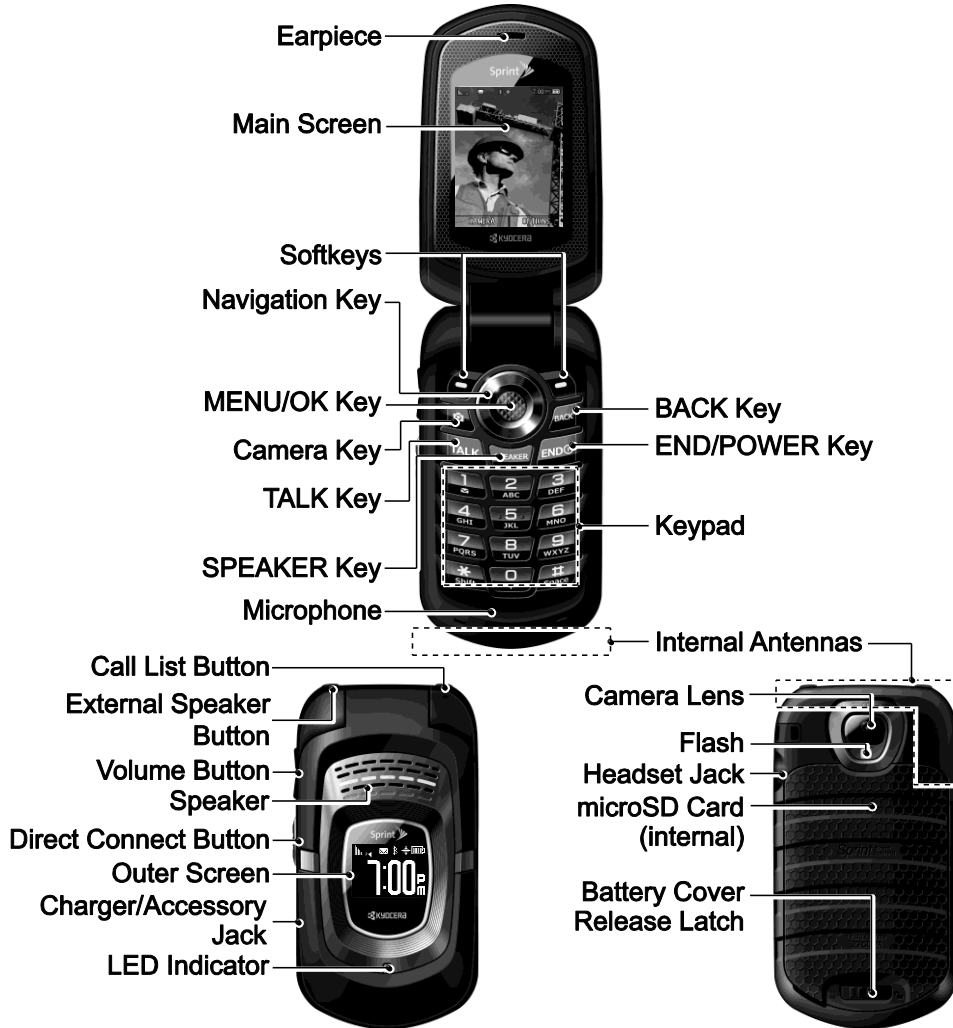

## Key Functions

- **Earpiece** lets you hear the caller and automated prompts.
- **Main Screen** displays all the information needed to operate your phone, such as the call status, the Contacts list, the date and time, and the signal and battery strength.
- **Softkeys** let you select softkey actions or menu items corresponding to the bottom left and right lines on the main screen while the phone is open.
- **Navigation Key** lets you scroll through the phone's menu options.
- **MENU/OK Key** lets you access the phone's menus and selects the highlighted choice when navigating through a menu.



- **Camera Key** lets you activate the camera or video mode and take pictures and videos with the phone open.
- **TALK Key** allows you to place or receive calls, answer Call Waiting, use Three-Way Calling, or activate Automatic Speech Recognition (ASR).
- **SPEAKER Key** lets you place or receive calls in speakerphone mode or turn the speakerphone on and off during a call.
- **Microphone** allows other callers to hear you clearly when you are speaking to them.
- **BACK Key** deletes characters from the display in text input mode. When in a menu, pressing it returns you to the previous menu. This key also allows you to return to the previous screen in a data session.
- **END/POWER Key** lets you turn the phone on or off, end a call, or cancel your input and return to standby mode.
- **Keypad** lets you enter numbers, letters, and characters, and perform functions.
- **Internal Antenna** facilitates reception and transmission. To maximize performance, do not touch the bottom portion of your phone where the internal antenna is located while using the phone.
- **Call List Button** lets you display the recent call history or end a call.
- **External Speaker Button** lets you place or receive calls in speakerphone mode, turn the speakerphone on and off during a call, activate Automatic Speech Recognition (ASR), or unlock the keyguard.
- **Volume Button** allows you to adjust the ringer volume in standby mode or the voice volume during a call.
- **Speaker** lets you hear the different ringers and sounds. The speaker also lets you hear the caller's voice in speakerphone mode.
- **Direct Connect Button (DC Button)** allows you to make Direct Connect calls, send Call Alerts, and view Direct Connect call history. See [Sprint Direct Connect](#).
- **Outer Screen** displays the information such as the call status, the date and time, and the signal and battery strength.
- **Charger/Accessory Jack** allows you to connect a compatible charging cable or USB data cable (not included).

**CAUTION!** Inserting an accessory into the incorrect jack may damage the phone.

- **LED Indicator** shows your phone's status at a glance.
- **Camera Lens**, as part of the built-in camera, lets you take pictures and videos.
- **Flash** allows you to take pictures in low light situations.
- **Headset Jack** allows you to plug in an optional headset for convenient, hands-free conversations.

**CAUTION!** Inserting an accessory into the incorrect jack may damage the phone.

- **microSD Card (internal)** lets you use the included microSD memory card to expand the memory of your phone. The microSD compartment is behind the battery. See [Remove or Insert the microSD Card](#).

**Note:** Your phone comes with the microSD card preinstalled.

- **Battery Cover Release Latch** opens the battery cover to replace the battery.

## Turn Your Phone On and Off

### Turn Your Phone On

- ▶ Open the phone and press .

### Turn Your Phone Off

- ▶ Open the phone and press and hold  for two seconds until you see the powering-down animation on the main screen.

Your screen remains blank while your phone is off (unless the battery is charging).

## Battery and Charger

**Warning:** Use only Sprint-approved or Kyocera-approved batteries and chargers with your phone. The failure to use a Sprint-approved or Kyocera-approved battery and charger may increase the risk that your phone will overheat, catch fire, or explode, resulting in serious bodily injury, death, or property damage.

Sprint-approved or Kyocera-approved batteries and accessories can be found at Sprint Stores or through Kyocera; or call 1-866-866-7509 to order. They're also available at [sprint.com](http://sprint.com).

### Battery Capacity

Your phone is equipped with a Lithium Ion (Li-Ion) battery. It allows you to recharge your battery before it is fully drained.

For a quick check of your battery level, glance at the battery charge indicator located in the upper right corner of your phone's display screen. When there are approximately five minutes of talk time left, the battery icon (🔋) turns red and the phone sounds a warning tone.

After an additional five minutes or so, the phone sounds a warning tone three times and then turns off.

**Note:** Long backlight settings, searching for service, vibrate mode, browser use, and other variables may reduce the battery's talk and standby times.

**Tip:** Watch your phone's battery level indicator and charge the battery before it runs out of power.

### *Install the Battery*

- ▶ See [Set Up Your Phone](#).

### *Remove the Battery*

1. Make sure the power is off so that you don't lose any stored numbers or messages.
2. Slide the battery cover release latch to the right to unlock the cover (1).
3. Slide your thumbnail or a coin under the slot on either side of the phone (2) and pop off the cover (3).
4. Remove the battery and replace the cover. See [Set Up Your Phone](#).

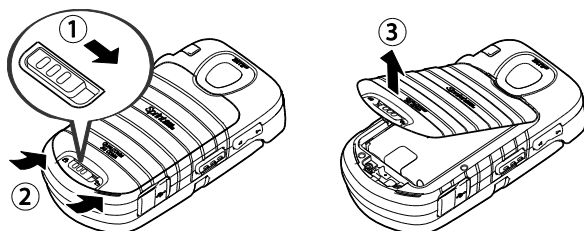







**Warning:** Do not handle a damaged or leaking Li-Ion battery as you can be burned.











## *View the Display Screen*



The status bar at the top of your phone's display screen provides information about your phone's status and options. The following tables identify the symbols you'll see on your phone's display screen.





**Tip:** To view a list of your phone's icons and descriptions, from the main menu select **Settings > Phone Info > Icon Glossary**.





Service Icons	Description
	<b>Signal Strength</b> - Your phone's current signal strength. (More bars = stronger signal.)

	<b>No Service</b> - Your phone cannot find a usable signal.
	<b>Roaming</b> - Your phone is “roaming” off the Nationwide Sprint Network.
	<b>DC Unavailable</b> - Direct Connect services are unavailable in your current location.
	<b>Data Service Available</b> - Sprint data service is available. When active, the icon is animated.
	<b>Data Service Dormant</b> - Sprint data service is currently dormant.
	<b>Data Service Unavailable</b> - Sprint data service is currently unavailable.





Status Icons	Description
	<b>Battery</b> - Your phone’s current battery charge level. (The icon to the left shows the battery is fully charged.) The icon is animated while the battery is charging.
	<b>Location On</b> - Your phone’s location feature is on and available for location-based services such as GPS Navigation.
	<b>Location Off</b> - Your phone’s location feature is off. Your location is available only for 911.
	<b>Silence All</b> - Your phone’s sound is turned off.
	<b>Vibrate All</b> - Your phone’s sound is turned off but vibrate is turned on.
	<b>Ringer Off</b> - Your phone’s ringer is turned off.
	<b>1 Beep</b> - A beep sounds when you receive an incoming call, a message, etc.
	<b>1 Beep and Vibrate</b> - 1 Beep and vibrate are set.
	<b>Ringer and Vibrate</b> - The volume level is set to between 1 and 8 and vibrate is turned on.
	<b>DC Speaker On</b> - The speakerphone is on for Direct Connect calls.
	<b>DC Speaker Off</b> - The speakerphone is off for Direct Connect calls. The earpiece or an optional headset must be used to hear DC calls.



Messaging and Alert Icons	Description
	<b>New Messages</b> - You have one or more new messages waiting.
	<b>New Voicemail</b> - You have one or more new voicemail messages waiting.

















	<b>Urgent Messages</b> - You have one or more new urgent messages waiting.
	<b>Multiple Alerts</b> - You have different kinds of alerts waiting.
	<b>Urgent Multiple Alerts</b> - You have different kinds of alerts (including urgent messages) waiting.
	<b>Application Alerts</b> - You have alert messages from Java applications activated in the background.
	<b>Call Alert</b> - You have a Direct Connect Call Alert waiting. Press the DC button to reply to the alert.





Bluetooth Icons	Description
	<b>Visible</b> - Your phone is discoverable by (visible to) other Bluetooth devices.
	<b>Connected</b> - Your phone is connected to a Bluetooth device.
	<b>Enabled</b> - Your phone's Bluetooth feature is enabled.
	<b>Connected via HFP</b> - Your phone is connected to or communicating with a Bluetooth device via Hands-free Profile (HFP).
	<b>Connected via A2DP</b> - Your phone is connected to or communicating with a Bluetooth device via Advanced Audio Distribution Profile (A2DP).

**Note:** The above icons will blink while your phone is communicating with a Bluetooth device.

Voice Call Icons	Description
	<b>Missed Call</b> - You have one or more missed voice calls.
	<b>Missed DC Call</b> - You have one or more missed Direct Connect calls, or your group is updated.
	<b>Bluetooth Device</b> - A call is in progress using a Bluetooth device.
	<b>Headset</b> - A call is in progress using an optional wired headset.
	<b>Car Kit</b> - A call is in progress using an optional car kit device.

Camera and Video Icons	Description
	<b>Beach/Snow Mode</b> - The picture/video mode is set to Beach/Snow.
	<b>Scenery Mode</b> - The picture/video mode is set to Scenery.

	<b>Mirror Image Mode</b> - The picture/video mode is set to Mirror Image.
	<b>Night/Dark Mode</b> - The picture/video mode is set to Night/Dark.
	<b>Self-Timer (5 Seconds)</b> - The self-timer is set to 5 seconds.
	<b>Self-Timer (10 Seconds)</b> - The self-timer is set to 10 seconds.
	<b>Multiple Shots</b> - The multiple shots function is enabled.
	<b>Camera Resolution (3.2M)</b> - The camera is set to 3.2-megapixel resolution (1536x2048).
	<b>Camera Resolution (2.0M)</b> - The camera is set to 2-megapixel resolution (1200x1600).
	<b>Camera Resolution (1.3M)</b> - The camera is set to 1.3-megapixel resolution (960x1280).
	<b>Camera Resolution (0.3M)</b> - The camera is set to 0.3-megapixel resolution (480x640).
	<b>Camera Resolution (0.1M)</b> - The camera is set to 0.1-megapixel resolution (240x320).
	<b>Video Resolution (QCIF)</b> - The video resolution is set to QCIF (176x144).
	<b>Video Resolution (Sub-QCIF)</b> - The video resolution is set to Sub-QCIF (128x96).
	<b>Camera Flash On This Shot</b> - The camera flash is enabled only for the current shot.
	<b>Camera Flash Always On or Video Light On</b> - The camera flash is always enabled in camera mode, or the video light is on in camcorder mode.
	<b>Automatic Camera Flash</b> - The camera flash will be enabled when needed.
	<b>Saving to Phone</b> - Your phone is saving a picture or video to the phone memory.
	<b>Saving to Memory Card</b> - Your phone is saving a picture or video to the memory card.

Other Icons	Description
	<b>TTY</b> - Your phone is connected to a TTY device.
	<b>Alarm</b> - An alarm or countdown is set.
	<b>Calendar</b> - You have event notifications.
	<b>HAC Enabled</b> - Your phone's HAC (hearing aid compatibility) setting is enabled.



**Multitasking Virtual Machine** - Java applications are running. The number next to the plus sign indicates the number of running applications.

## Navigate Through the Menus

The navigation key on your phone lets you scroll through onscreen items. To navigate through a menu, press the navigation key up or down.

Many menus feature a scroll bar on the right to help you keep track of your position in the menu.

### Select Menu Items

As you navigate through the menu, menu options are highlighted. Select any option by highlighting it and pressing . If the option is numbered, you can select it by pressing the corresponding number on the phone's keypad.

For example, to view the Icon Glossary screen:

1. Press to access the main menu.
2. Select **Settings** by highlighting it and pressing .
3. Select **Phone Info** by highlighting it and pressing .
4. Select **Icon Glossary** by highlighting it and pressing .

For the purposes of this guide, the above steps condense into:

- ▶ Press > **Settings** > **Phone Info** > **Icon Glossary**.

### Back Up Within a Menu

To go to the previous menu:

- ▶ Press .

To return to standby mode:

- ▶ Press .

## Display Your Phone Number

- ▶ Press > **Settings** > **Phone Info** > **Phone#/User ID**.

Your phone number and other information about your phone and account will be displayed.

# Enter Text

You can type on your phone using various input modes.

[Select a Text Input Mode](#)

[T9 Text Input](#)

[ABC Mode](#)

[Set Text Entry Options](#)

## Select a Text Input Mode

Your phone provides convenient ways to enter letters, numbers, and symbols whenever you are prompted to enter text.

1. From a screen where you can enter text, press **OPTIONS** (right softkey) to change the text mode. (If you are in the message entry screen, press **OPTIONS** [right softkey] > **Text Mode**.)
2. Select one of the following options:
  - **Abc** to enter characters by using the alphabet mode. See [ABC Mode](#).
  - **T9Word** to enter text using a predictive text system that reduces the number of key presses required while entering a word.
  - **123** to enter numeric characters.
  - **Symbols** to enter symbols.
  - **Smileys** to enter smile icons.
  - **Emoticons** to enter “emoticons.” (This is available, for example, when composing a message or when editing a Schedule or To Do description in Calendar.)
  - **Paste List** to paste copied or cut text (if applicable).
  - **Web Shortcuts** to enter Web shortcuts (for example, www., http://, or .com).
  - **Text Options** to display the text entry options menu (if applicable). See [Set Text Entry Options](#).

**Tip:** When entering text, press  to change the capitalization style as **Abc** > **ABC** > **abc** (ABC mode), or as **T9Word** > **T9WORD** > **T9word** (T9Word mode). The selected style is displayed in the bottom-right corner of the screen, above the right softkey label (if applicable).



## T9 Text Input

T9 Text Input lets you enter text by pressing keys just once per letter. To select the **T9 Word** mode when entering text, see [Select a Text Input Mode](#).

T9 Text Input uses an intuitive word database to analyze the letters you enter and create a suitable word. (The word may change as you type.)

1. Select the **T9Word** text input mode.
2. Press the corresponding keys once per letter to enter a word. (For example, to enter the word “Bill,” press **2 ABC** **4 OHI** **5 JKL** **5 JKL**.) (If you make a mistake, press **BACK** to erase a single character. Press and hold **BACK** to erase an entire word.)

If the word you want is not displayed after you have entered all the letters, press the navigation key to scroll through additional word selections. To accept a word and insert a space, press **# Spc**.

### Add a Word to the T9 Database

If a word you want to enter is not displayed in a T9 word choice list when you are using T9 Input, add it to the database.

1. While you are in **T9Word** mode, enter a letter. (A word choice list opens.)
2. Scroll down the list and select **<Add Word>**.
3. Enter a word and press **SAVE** (left softkey). The word will appear as an option the next time you scroll through options during T9 Text Input.

For more information about T9 Text Input, visit the Nuance website at [nuance.com/t9/xt9/](http://nuance.com/t9/xt9/).

## ABC Mode

In **Abc** mode, also known as multi-tap entry, you press keys one, two, three, or four times to enter the letters you see on the keypad.

By default, the first letter of a sentence is capitalized and the following letters are lowercased. To switch between lowercase and uppercase, press the **\* SHFT** key. After a character is entered, the cursor automatically advances to the next space after two seconds or when you enter a character on a different key.

1. Select the **Abc** text input mode. See [Select a Text Input Mode](#).
2. Press the corresponding key repeatedly until the correct letter appears. For example, to enter “Abc,” press **2 ABC** once for “a,” twice for “b,” and three times for “c.”

## Set Text Entry Options

The text entry options menu allows you to specify a suitable feature during the text entry process.

1. When entering text, press **OPTIONS** (right softkey) > **Text Options**.

– or –

Press  > **Settings** > **Text Entry**.

2. Highlight an option and press .

- **Word Complete** to suggest possible words based on letters you have entered when the T9 mode is enabled.
- **Next Word Complete** to automatically display the word that may follow the current text input.
- **Phrase Complete** to set the phone to predict possible phrases after one word with a space is entered.
- **Word Scan** to allow the predictive text input system to recognize words by searching Contacts.
- **Word Choice List** to select whether to display the word choice list.
- **Input Language** to select the language to enter (English or Spanish).
- **My Words** to edit or delete custom words you have added to the predictive text database.
  - **Add Word** to store words that you frequently use.
- **Select Text** to select text for copying, cutting or adding (if applicable).
- **Delete All** to delete all text (if applicable).
- **Help** to view the T9 instructions.

## *Simple Data Exchange*

This feature makes it easy to select certain information in a message and automatically save it or use it in a related application.

Simple Data Exchange works with these types of information:

- Email addresses
- Street addresses
- Phone numbers and Direct Connect numbers
- Web addresses (URLs)

### *Email Address Options*

- ▶ Highlight an email address, press , and then select an option:
  - **Send Message** to select **Message**. The messaging application will open and the email address will appear as the message's recipient.
  - **Share** to select **Message**. The messaging application will open and the email address will appear in the message body.
  - **Save to Contacts** to save the email address in Contacts.
  - **Contact Details** to display the Contacts entry if the email address is already saved in Contacts.

### *Street Address Options*

- ▶ Highlight a street address, press , and select an option:
  - **Navigate** to show directions to the address using Sprint Navigation.
  - **Map** to show the address location on a map.
  - **Share** to select **Message**. The messaging application will open and the address will appear in the message body.
  - **Save to Contacts** to save the address in Contacts.

### *Phone Number Options*

- ▶ Highlight a phone number, press , and then select an option:
  - **Call** to call the phone number.
  - **Direct Connect** to call the Direct Connect number.
  - **Call Alert** to send a Call Alert.
  - **Prepend** to prepend a number to the phone number.
  - **Send Message** to send a message to the phone number. The messaging application will open and the phone number will appear in the **To:** field.
  - **Share** to select **Message**. The messaging application will open and the phone number will appear in the message body.
  - **Save to Contacts** to save the phone number in Contacts.
  - **Contact Details** to display the Contacts entry if the phone number is already saved in Contacts.

## *Web Address (URL) Options*

- ▶ Highlight a Web address (URL), press , and select an option:
  - **Browse** to open the browser to the Web page.
  - **Share** to select **Message**. The messaging application will open and the Web address will appear in the message body.
  - **Save to Contacts** to save the Web address in Contacts.

# Phone Calls & Settings

---

With the Nationwide Sprint Network, you can enjoy clear calling across the country. This section explains the features related to phone calls.

[Make Phone Calls](#)

[Receive Phone Calls](#)

[End Phone Calls](#)

[Missed Call Notification](#)

[Voicemail](#)

[Phone Call Options](#)

[Phone Call Settings](#)

**Note:** The calling information in this section refers to traditional wireless phone calls. For information on making and answering Direct Connect calls, Group Connect calls, and TeamDC calls, see [Sprint Direct Connect](#).

## *Make Phone Calls*

There are several convenient ways to place calls from your phone.

[Call Using the Phone Keypad](#)

[Call With the Phone Closed](#)

[Call From History](#)

[Call From Contacts](#)

[Call Using the Plus \(+\) Code](#)

[Call Using a Speed Dial Number](#)

[Call Using Abbreviated Dialing Features](#)

[Call a Phone Number With Pauses](#)

[Call a Phone Number in a Message](#)

[Call Emergency Numbers](#)

### *Call Using the Phone Keypad*

The most “traditional” way to place a call is by using the phone’s keypad.

1. Enter a phone number from standby mode. (If you make a mistake while dialing, press **BACK** to erase the numbers.)
2. Press **TALK**, **SPEAKER**, or the external speaker button.
3. Press **END** when you are finished.

## Call With the Phone Closed

You can make a phone call using Automatic Speech Recognition (ASR) with the phone closed. It also works with the phone open. See [Automatic Speech Recognition \(ASR\)](#).

1. Press and hold the external speaker button to unlock the keyguard if the buttons are locked. See [Keyguard](#).
2. Press and hold the external speaker button to activate ASR.
3. Follow the voice prompts. Say “Call” and the name of an entry saved in your Contacts or a phone number. See [Make a Voice Call Using ASR](#).
  - The call will be made in speakerphone mode unless you have a headset connected to the phone.
4. Press the call list button when you are finished.

**Tip:** You can redial your most recent call using the Recent Calls list. Press the call list button to display the list and select the entry you want to call.

## Call From History

Place a call to the numbers in your History.

1. Press **MENU** > **History**.  
– or –  
Press **TALK** or the call list button in standby mode.
2. Highlight an entry and press **TALK**.

**Tip:** To redial your last outgoing call, press **TALK** twice.

**Note:** You cannot make calls from History to entries identified as **No Caller ID**, **Private (Restricted ID)**, or **Unavailable ID**.

## Call From Contacts

Place a call to the numbers stored in your Contacts.

1. From standby mode, press **CONTACTS** (right softkey).
2. Highlight the entry you want to call.

3. Press **TALK** to dial the entry's default phone number.

– or –

To dial another number from the same entry, press **MENU OK** to select the entry, highlight a number, and then press **TALK**.

## Call Using the Plus (+) Code

When placing international calls, use Plus Code Dialing to automatically enter the international access code for your location (for example, 011 for international calls made from the U.S.).

1. Press and hold **0+** to display “+” on your phone screen.
2. Enter the country code and phone number, and then press **TALK**. (The phone automatically prepends the access code for international dialing, followed by the country code and phone number.)

## Call Using a Speed Dial Number

You can store up to 98 numbers in your phone's speed dial memory to make contacting friends and family easier.

You must have already assigned a speed dial number to an existing phone number. See [Assign Speed Dial Numbers](#).

To use speed dial for locations 2-9:

- ▶ From standby mode, press and hold the appropriate key for approximately two seconds.

To use speed dial for locations 10-99:

- ▶ From standby mode, enter a two-digit speed dial number, and then press **TALK**.

The display confirms that the number has been dialed when it shows “Connecting...”

## Call Using Abbreviated Dialing Features

Abbreviated Dialing is similar to speed dialing. You can use either of the following abbreviated dialing features.

- **Contacts Match** - Retrieve any number saved in your Contacts by entering four or more digits of any part of the number.
- **Prepend** - Prepend the first five or six digits (for example, the area code and prefix) to any four or five digits you enter.

To activate the Prepend feature:

1. Press **MENU OK** > **Settings** > **Others** > **Call Setup** > **Abbrev. Dial**.

2. Select **Prepend > On**.
3. Enter a five- or six-digit number and press .



To place a call using Abbreviated Dialing:

1. Enter the four or more digits of any part of a Contacts entry's phone number to use the Contacts Match feature.

– or –

Enter the last four or five digits of the number to use the Prepend feature.

**Note:** Contacts Match will not retrieve numbers if you enter 911 or reserved three-digit service numbers such as 411 or 711.

2. Press  to call the displayed number. (If there are two or more matched numbers in your Contacts, a list is displayed. Highlight the name or the phone number you want to call, and then press  to place a call.)

## Call a Phone Number With Pauses

You can dial or save phone numbers with pauses for use with automated systems, such as voicemail or credit card billing numbers.

There are two types of pauses available on your phone:

- **Hard Pause** sends the next set of numbers when you press **SEND TONES** (left softkey).
- **2-Sec. Pause** automatically sends the next set of numbers after two seconds.

**Note:** You can have multiple pauses in a phone number and combine two-second and hard pauses.

To dial or save phone numbers with pauses:

1. Enter all or part of a number.
2. Press **OPTIONS** (right softkey) > **Hard Pause** or **2-Sec. Pause**.
3. Enter additional numbers.
4. Press  to dial the number.

**Note:** When dialing a number with a hard pause, press **SEND TONES** (left softkey) to send the next set of numbers.

## Call a Phone Number in a Message

You can place a call to a number that appears in a message.

1. In standby mode, press **MESSAGING** (left softkey) > **Messages**.



2. Select a message with the number you want to call.
3. Select the number and select **Call**.

For more information on utilizing the information in a message, see [Simple Data Exchange](#).

## Call Emergency Numbers

You can place calls to 911 even if your phone is locked or your account is restricted.

▶ Press    .



**Note:** After you have placed an emergency call, your phone automatically enters Emergency mode.

During an emergency call, press **OPTIONS** (right softkey) to display your options. Highlight an option and press .

- **Transfer Audio** to switch the call to an external device (if applicable).
- **Contacts** to show the Contacts list.
- **Voice Memo** to record the other party's voice.
- **Phone Info** to display information about your phone.

**Tip:** Press **MY PHONE#** (left softkey) to display your phone number during an emergency call.

To exit emergency mode:

1. Press  to end a 911 call.
2. Press  .

## Enhanced 911 (E911) Information

This phone features an embedded Global Positioning System (GPS) chip necessary for utilizing E911 emergency location services where available.

When you place an emergency 911 call, the GPS feature of your phone seeks information to calculate your approximate location. Depending on several variables, including availability and access to satellite signals, it may take up to 30 seconds or more to determine and report your approximate location.

**Important:** Always report your location to the 911 operator when placing an emergency call. Some designated emergency call takers, known as Public Safety Answering Points (PSAPs) may not be equipped to receive GPS location information from your phone.

# Receive Phone Calls

Your phone notifies you of incoming calls in the following ways:

- The phone rings or vibrates.
- The LED indicator flashes.
- The backlight illuminates.
- The screen displays an incoming call message.

If the incoming call is from a number stored in your Contacts, the entry's name is displayed. The caller's phone number may also be displayed, if available.

**Note:** If your device is turned off, all calls automatically go to voicemail.

[Answer an Incoming Call With the Phone Open](#)

[Answer an Incoming Call With the Phone Closed](#)

[Answer an Incoming Call in Speakerphone Mode](#)

[Answer a Roam Call With Roaming Guards Enabled](#)

[Mute the Ringer and Stop the Vibration](#)

[Send an Incoming Call to Voicemail](#)

[Reject an Incoming Call](#)

[Reject an Incoming Call and Send a Message](#)

[In-call Options](#)

## *Answer an Incoming Call With the Phone Open*

- ▶ Press  to answer an incoming call. (Depending on your settings, you may also answer incoming calls by pressing other keys. See [Call Answer Mode](#).)

## *Answer an Incoming Call With the Phone Closed*

- ▶ When your phone rings or vibrates, press the external speaker button. (The call will be answered in speakerphone mode.)

– or –

Open the phone to use the earpiece. See [Call Answer Mode](#).

## *Answer an Incoming Call in Speakerphone Mode*

- ▶ Press **SPKR** or the external speaker button.

## *Answer a Roam Call With Roaming Guards Enabled*

1. Press **TALK**.
2. Read the message and press **1■**.

See [Roaming Guards](#) for more information on Roaming Guards.

## *Mute the Ringer and Stop the Vibration*

- ▶ Press **Silence** on the screen.
  - or –
  - Press **BACK**, the DC button, or the volume button up or down.

## *Send an Incoming Call to Voicemail*

- ▶ Press **Send to Voicemail** on the screen.

## *Reject an Incoming Call*

- ▶ Press **END** or the call list button.
  - or –
  - Press and hold **BACK**.

## *Reject an Incoming Call and Send a Message*

- ▶ Press **Ignore with Text**.

## *In-call Options*

Pressing **OPTIONS** (right softkey) during a call displays a list of available in-call features. To select an option, highlight the option and press **MENU OK**.

- **Transfer Audio** to switch the call to a Bluetooth device (if applicable).
- **Save** to save the current call's phone number in your Contacts.
- **Contact Details** to display information about the caller stored in your Contacts.
- **Main Menu** to display the phone's main menu.
- **3-Way Call** to open a call with two other parties.
- **Contacts** to display your Contacts list.

- **Voice Memo** to record the other party's voice.
- **Phone Info** to display information about your phone.
- ▶ Press **MUTE/UNMUTE** (left softkey) to mute/unmute the microphone.
- ▶ Press the volume button up or down to adjust the receiver volume.
- ▶ Press  or the external speaker button to turn the speaker on. Press again to turn it off.

**Warning:** Because of higher volume levels, do not place the phone near your ear during speakerphone use.

## End Phone Calls



- ▶ Press  or the call list button.

After you have finished your call, the phone will display the caller's name (if already in your Contacts), phone number (if available), and the duration of the call. Pressing **OPTIONS** (right softkey) will display the Recent History options. See [History Options](#) for details.

## Missed Call Notification

When an incoming call is not answered, your screen displays the Missed Call log. Press  to dial the phone number.

To display a Missed Alerts entry from standby mode:

1. Press  > **Missed Alerts**.
2. Highlight the entry you wish to view and press .

## Voicemail

Your phone automatically transfers all unanswered calls to your voicemail, even if your phone is in use or turned off. You should set up your Sprint Voicemail and personal greeting as soon as your phone is activated. Always use a password to protect against unauthorized access.

[Set Up Voicemail](#)

[Voicemail Notification](#)

[New Voicemail Message Alerts](#)

[Retrieve Your Voicemail Messages](#)

## Set Up Voicemail

1. Press and hold  in standby mode to dial your voicemail number.

2. Follow the system prompts to:
  - Create your password.
  - Record your name announcement.
  - Record your greeting.

**Important:** **Voicemail Password** – Sprint strongly recommends that you create a password when setting up your voicemail to protect against unauthorized access. Without a password, anyone who has access to your phone is able to access your voicemail messages.

## *Voicemail Notification*

There are several ways your phone alerts you to a new message:

- By displaying a message on the screen.
- By sounding the assigned ringer type.
- By displaying  at the top of the screen.

## *New Voicemail Message Alerts*

When you receive a new voicemail message, your phone alerts you and prompts you to call your voicemail.

To call your voicemail from the notification screen:

1. Press .
2. Enter your voicemail password if prompted.
3. Follow the voice prompts to listen to and manage your voicemail messages.

**Note:** When you are roaming off the Nationwide Sprint Network, you may not receive notification of new voicemail messages. Sprint recommends that you periodically check your voicemail. See [Check for Voicemail Messages While Roaming](#). Roaming rates apply when you access voicemail while roaming off the Nationwide Sprint Network.

**Note:** Your phone accepts messages even when it is turned off. However, your phone notifies you of new messages **only** when it is turned on and you are in a Sprint service area.

To set the frequency of new message alerts:

1. Press  > **Settings** > **Others** > **Alerts** > **Repeated Tone** > **Voicemail**.
2. Select **Single Tone** (once only) or **Repeated Tone** (once every minute).

## Retrieve Your Voicemail Messages

You can review your messages directly from your wireless phone or from any other touch-tone phone.

### Use Your Phone to Access Your Messages

1. Press and hold **1**.

– or –

In standby mode, press **MESSAGING** (left softkey) > **Voicemail**.

2. Enter your voicemail password if prompted.
3. Follow the voice prompts to listen to and manage your voicemail messages.

**Note:** You are charged for airtime minutes when you are accessing your voicemail from your wireless phone.

### Use Another Phone to Access Messages

1. Dial your wireless phone number.
2. When your voicemail answers, press **\* shift** (the star key).
3. Enter your password.

**Tip:** When you call into voicemail, you first hear the header information (date, time, and sender information) for the message. To skip directly to the message, press **4 on** during the header.

## Phone Call Options

Your phone application provides many useful features and options to help you make the most of your calling experience.

[Caller ID](#)

[Call Waiting](#)

[3-Way Calling](#)

[Call Forwarding](#)

### Caller ID

Caller ID identifies a caller before you answer the phone by displaying the number of the incoming call. If you do not want your number displayed when you make a call, follow these steps.

1. Enter **\* shift 6 on 7 on**.

2. Enter the number you want to call.
3. Press **TALK**.

To permanently block your number, call Sprint Customer Service.

## Call Waiting

When you're on a call, Call Waiting alerts you to incoming calls by sounding a beep. Your phone's screen informs you that another call is coming in and displays the caller's phone number (if available).

To respond to an incoming call while you're on a call:

- ▶ Press **TALK**. (This puts the first caller on hold and answers the second call.)

To switch back to the first caller:

- ▶ Press **TALK** again.

**Tip:** For those calls where you don't want to be interrupted, you can temporarily disable Call Waiting by pressing **\*Shift 7Phone 0+** before placing your call. Call Waiting is automatically reactivated once you end the call.

## 3-Way Calling

With 3-Way Calling, you can talk to two people at the same time. When using this feature, the normal airtime rates will be charged for each of the two calls.

1. Enter a number and press **TALK**.
2. Once you have established the connection, press **TALK**. (This puts the first caller on hold.)
3. Select **Contacts**, **Recent History**, or **Enter Phone#**.
4. Select a number from your Contacts or Recent History, or enter a number directly, and then press **TALK**.
5. When you're connected to the second party, press **TALK** again to begin your 3-way call.

If one of the people you called hangs up during your call, you and the remaining caller stay connected. If you initiated the call and are the first to hang up, all callers are disconnected.

## Call Forwarding

Call Forwarding lets you forward all your incoming calls to another phone number—even when your phone is turned off. You can continue to make calls from your phone when you have activated Call Forwarding.

**Note:** You are charged a higher rate for calls you have forwarded.

To activate Call Forwarding:

1. Enter **\*SHIFT 7 FWD 2 ABC**.
2. Enter the area code and phone number to which you want your calls forwarded.
3. Press **TALK**. (You will hear a tone to confirm the activation of Call Forwarding.)

To deactivate Call Forwarding:

1. Enter **\*SHIFT 7 FWD 2 ABC 0 +**.
2. Press **TALK**. (You will hear a tone to confirm the deactivation.)

## Phone Call Settings

Various call-related settings are available.

[Call Answer Mode](#)

[Auto-Answer Mode](#)

[Alert Notification](#)

[Airplane Mode](#)

[TTY Use With Sprint Service](#)

[Hearing Aid Device Compatibility](#)

### Call Answer Mode

Select how to answer incoming calls on your phone.

1. Press **MENU OK** > **Settings** > **Others** > **Call Setup** > **Call Answer**.
2. Select **Talk Key**, **Any Key**, or **Flip Open**.

### Auto-Answer Mode

Set your phone to automatically pick up incoming calls. Remember, your phone will answer calls in auto-answer mode even if you are not present.

1. Press **MENU OK** > **Settings** > **Others** > **Call Setup** > **Auto-Answer**.
2. Highlight an option and press **MENU OK**.
  - **Hands-free** to answer calls automatically when the phone is connected to an optional headset or hands-free device.
  - **Speakerphone** to answer calls automatically in speakerphone mode.



3. Highlight the time you would like your phone to wait before answering and press .



## *Alert Notification*

Set your phone to alert you with an audible tone when you change service areas, once a minute during a voice call, or when a call has been connected.

1. Press  > **Settings** > **Others** > **Alerts**.
2. Select **Beep Each Minute**, **Out of Service**, or **Connect**.
3. Select **On** or **Off**.

## *Airplane Mode*

Airplane Mode allows you to use many of your phone's features, such as games and voice memos, when you are on an airplane or in any other area where making or receiving calls or data is prohibited. When you set your phone to Airplane Mode, it cannot send or receive any calls or access online information.

1. Press  > **Settings** > **Others** > **Airplane Mode**.
2. Read the disclaimer and press .
3. Select an option from the following:
  - **On** to activate Airplane Mode. Airplane Mode will be deactivated when you turn the phone off.
  - **Off** to deactivate Airplane Mode.
  - **On Power-up** to activate Airplane Mode each time you turn the phone on.

While in Airplane Mode, your phone's screen will display "Phone Off."



## *TTY Use With Sprint Service*

A TTY (also known as a TDD or Text Telephone) is a telecommunications device that allows people who are deaf, hard of hearing, or who have speech or language disabilities to communicate by telephone.

Your phone is compatible with select TTY devices. Please check with the manufacturer of your TTY device to ensure that it is compatible with digital cell phones. Your phone and TTY device will connect via a special cable that plugs into your phone's headset jack. If this cable was not provided with your TTY device, contact your TTY device manufacturer to purchase the connector cable.

To turn TTY Mode on or off:

1. Press  > **Settings** > **Others** > **Accessibility** > **TTY**. (You will see an informational message.)

2. Press  .
3. Select one of the following options:
  - **TTY Off** to disable TTY mode.
  - **TTY VCO** to enable TTY mode in Voice Carry Over mode, which allows you to send voice and receive text during a call.
  - **TTY HCO** to enable TTY mode in Hearing Carry Over mode, which allows you to send text and receive voice during a call.
  - **TTY Full** to enable all TTY settings. You can send and receive text during a call.

To access the state Telecommunications Relay Service (TRS) for assistance with TTY calls:

- ▶ Dial     and press  to reach an operator.

For additional information about Sprint Relay Services and TTY compatibility, call Sprint Relay Customer Service at **800-676-3777** or visit [sprintrelay.com](http://sprintrelay.com).

**Note:** In TTY Mode, your phone will display the TTY icon if a TTY device or an optional headset is connected to your phone.



**Note:** When enabled, TTY mode may impair the audio quality of non-TTY devices connected to the headset jack.

**Warning:**      **911 Emergency Calling**

Sprint recommends that TTY users make emergency calls by other means, including Telecommunications Relay Services (TRS), analog cellular, and landline communications. Wireless TTY calls to 911 may be corrupted when received by public safety answering points (PSAPs), rendering some communications unintelligible. The problem encountered appears related to software used by PSAPs. This matter has been brought to the attention of the FCC, and the wireless industry and the PSAP community are currently working to resolve this.

## *Hearing Aid Device Compatibility*

Your phone has been tested and rated for hearing aid device compatibility. To use this function effectively, set the hearing aid option to **On**.

1. Press  > **Settings** > **Others** > **Accessibility** > **Hearing Aid**.
2. Read the disclaimer and press .
3. Select **On** or **Off**.
  - **On** to use a hearing aid device with your phone.

- **Off** to use your phone without a hearing aid device.

# *Sprint Direct Connect*

---

Sprint Direct Connect® on your Sprint phone offers instant, two-way “walkie-talkie-style” communication between you and your family, friends, and co-workers, all at the click of a button. Perfect for get-in get-out conversations such as checking status, getting information, getting directions, or coordinating with others—fast. Call Alert sends an alert to other Direct Connect users to let them know you want to reach them.

[About Sprint Direct Connect](#)

[Before Making Your First Direct Connect Call](#)

[Your Direct Connect Number](#)

[Make and Answer Direct Connect Calls](#)

[Call Alerts](#)

[Group Connect](#)

[Invites](#)

[TeamDC](#)

## *About Sprint Direct Connect*

The following Sprint Direct Connect services are available:



- **Direct Connect®** - Allows two-way radio communication with any other Direct Connect users.
- **Group Connect®** - Create and manage groups in Contacts, “on the fly,” or online to connect instantly with up to 20 other Direct Connect users at the same time. (Currently Sprint phones do not support Group Connect calls with Nextel or PowerSource phones.)\*
- **TeamDC<sup>SM</sup>** - Create a group online that allows nationwide group calling with up to 34 other Direct Connect users (with Sprint phones only). With TeamDC, all members can access the most up-to-date group list on their phone.

*\*In the future, users will be able to include Direct Connect users with Nextel phones in their Group Connect groups.*

## *Before Making Your First Direct Connect Call*

To enable Direct Connect on your phone, a Sprint Customer Service representative must add Direct Connect service to your account.

## Register and Activate Direct Connect

1. Confirm the Direct Connect feature is currently activated on your account.
2. Press  > **Settings** > **DC Settings** > **Update DC**.
  - This validates your Direct Connect service with the Sprint Network and then restarts the phone.
3. Verify that Direct Connect is now active:
  - You should not see the  icon at the top of the screen.

**Important:** When the Direct Connect feature is active, your phone's data services are enabled and the Net Guard feature is disabled (**Settings** > **Others** > **Data Settings** > **Data and Net Guard**).

## Your Direct Connect Number

Your Sprint phone allows you two different options for your Direct Connect number:

- Separate numbers (**DC Only**) - Your Direct Connect number is a unique number (not your wireless number). It is made up of three sets of digits separated by asterisks (for example, 444\*5555\*111).
- A single number (**Mobile+DC**) - Your Direct Connect number is the same as your wireless number (for example, 555-555-1234).

### Dial Direct Connect Numbers

### Save a Direct Connect Number

### Display Your Direct Connect Number

## Dial Direct Connect Numbers

- If the person you are calling has a separate number for Direct Connect, make sure you dial any asterisks (\*) in the number. If you are saving the number in your Contacts, choose **DC Only** for the phone type.
- If the person you are calling has a single number for both voice calls and for Direct Connect, use that ten-digit phone number to make Direct Connect calls. You do not need to add any asterisks (\*) to the number. If you are saving this number in your contacts, choose **Mobile+DC** for the phone type.

**Tip:** Users with a Nextel phone must always add asterisks (\*) between sets of numbers to dial Direct Connect numbers. If you use a single number, make sure to tell your contacts with Nextel phones to dial the ten-digit number using asterisks (\*) in place of hyphens (for example, 555\*555\*1234).

**Tip:** One way to easily ensure that your contacts have your correct number is to call them so that they can save your number from their Call Log. Ask them for their contact information. Remember you will need all digits of the number to make a successful call. Also, if they have a Nextel phone or a separate number for Direct Connect, you will need to enter asterisks (\*) between sets of numbers.

To tell if a number is a valid Direct Connect number:

- ▶ Check the icon for the highlighted number. If it has a Mobile+DC icon (📶) or a DC Only icon (📶), it is a valid Direct Connect number.

– or –

Highlight a contact and press . “DC capable” will appear below the valid Direct Connect number.

## Save a Direct Connect Number

1. Use your keypad to enter a Direct Connect number.
  - The Direct Connect number may be the ten-digit wireless phone number of the contact.

– or –

  - The Direct Connect number may be a unique number made up of three sets of digits separated by asterisks (for example, 444\*555\*111). When saving this type of number, always include the asterisks (\*).
2. Press **OPTIONS** (right softkey) > **Save**.
3. Select **New Entry** or **Existing Entry**.
4. Select a number type for the entry:
  - Select **Mobile+DC** if the wireless phone number and the Direct Connect number are the same.
  - Select **DC Only** if the Direct Connect number is different from the wireless phone number. Make sure to include the asterisks (\*) between the sections of a DC Only number.

**Note:** All Direct Connect users with Nextel or PowerSource phones must ALWAYS use an asterisk (\*) between sets of digits, even if they are calling another user whose DC number is the same as their wireless phone number. Make sure to include the asterisks when giving your number to a Nextel or PowerSource user (for example, if your number is 555-555-1234, when giving it to a Nextel or PowerSource user, it should be 555\*555\*1234).

5. Press **DONE** (left softkey) to save the entry.

**Tip:** You can also save a Direct Connect number from History. From a History listing, press **OPTIONS** (right softkey) > **Save Contact**, and then complete steps 3-5 in [Save a Direct Connect Number](#). To create a new Contacts entry with a Direct Connect Number, see [Create a Personal Entry](#).

## *Display Your Direct Connect Number*

▶ Press  > **Settings** > **Phone Info** > **Phone#/User ID**.

Your Direct Connect number and other information about your phone and account will be displayed.

## *Make and Answer Direct Connect Calls*

You can make a Direct Connect call by entering a Direct Connect number manually or by selecting an entry containing a Direct Connect number in your Contacts or History. For information on saving Direct Connect numbers to Contacts, see [Save a Direct Connect Number](#).

**Note:** Bluetooth devices cannot be used for Direct Connect calls.

[Make a Direct Connect Call by Entering a Number](#)

[Make a Direct Connect Call From Contacts](#)

[Make a Direct Connect Call From History](#)

[Make a Direct Connect Call Using a Speed Dial Number](#)

[Make a Direct Connect Call With the Phone Closed](#)

[Answer Direct Connect Calls](#)

[End a Direct Connect Call](#)

[Direct Connect Permissions](#)

## *Make a Direct Connect Call by Entering a Number*

1. Use your keypad to enter a Direct Connect number.
  - The Direct Connect number may be the ten-digit wireless phone number of the person you are calling (Mobile+DC).  
  
– or –  
  
If calling a Nextel customer, the Direct Connect number may have three parts with an asterisk between each part (for example: 444\*5555\*111). When dialing or saving this type of number, always include the asterisks ().
2. Press and release the Direct Connect button (DC button) on the side of your phone.

- Pressing and releasing the DC button “pings” the recipient. The recipient’s phone emits an incoming tone and displays your name or number. If available, he or she can choose to respond and begin the conversation.
  - Alternatively, you can hold the button and speak after you first press and hear the tone. In this case, your voice will broadcast instantly over the recipient’s speaker. Pinging the recipient’s phone by pressing and releasing may avoid unintentional interruptions.
3. After the recipient accepts your call:
    - Wait for “**Open**” to appear onscreen.
    - Press and hold the DC button.
    - Wait for a tone to sound and “**Me**” to appear onscreen before you begin talking.
  4. Release the DC button to listen.
  5. Press  to end the call.

**Note:** All Direct Connect calls end automatically if there is no activity on the call for several seconds.

**Tip:** To display your Direct Connect number, press  > **Settings** > **Phone Info** > **Phone#/User ID**.

### *Make a Direct Connect Call From Contacts*

1. In standby mode, press **CONTACTS** (right softkey).
2. Highlight an entry and press and release the DC button.
3. Continue the Direct Connect call as described previously.

### *Make a Direct Connect Call From History*















1. Press  > **History**.

– or –

From standby mode, press the DC button to display your Direct Connect (including Call Alert) call history only.

- The following icons indicate the types of Direct Connect history entries.



	Incoming	Outgoing	Missed
Direct Connect Call			
Group Connect Call			
TeamDC Call			
Call Alert			
Group Connect Invite			

2. Highlight a Direct Connect entry and press and release the DC button.
3. Continue the Direct Connect call as described previously.

**Tip:** To redial your most recent Direct Connect call, press and hold the DC button.

### *Make a Direct Connect Call Using a Speed Dial Number*

- From standby mode, enter a speed dial number and press the DC button.

To assign a Direct Connect number to a speed dial location, see [Assign Speed Dial Numbers](#).

### *Make a Direct Connect Call With the Phone Closed*



1. Press and hold the external speaker button to unlock the keyguard if the buttons are locked. See [Keyguard](#).
2. Press and hold the external speaker button until you see “DC Speaker mode on” on the external display.
3. Press and release the DC button to display the History on the external display.
4. Use the volume button to scroll through the list and highlight an entry.
5. Press and hold the DC button to begin talking.

**Tip:** If you see the incoming caller’s information on the external display, but you cannot hear the caller, the audio is being routed to the internal speaker. Press the external speaker button again to route the conversation to the external speaker.

6. Press the call list button to finish the DC call.

## Answer Direct Connect Calls

When you receive a Direct Connect call, you hear an incoming tone or the phone vibrates, depending on your settings. You will see the Direct Connect number and the caller's name (if available) on your screen. You may also hear the caller's voice through the speakerphone. Default for Direct Connect calls is speakerphone on. You can turn the speakerphone off and listen to Direct Connect calls through the earpiece as you would a regular call, or you can listen through a headset.

1. Press  or the external speaker button to either enable or disable the Direct Connect speakerphone feature.
  - If you enable the Direct Connect speakerphone () , you will hear the caller's voice through the speakerphone on the front of the phone.
  - If you disable the Direct Connect speakerphone () , you will only hear the caller's voice through the earpiece.
2. Accept the incoming call. If available, the caller's name and Direct Connect number also appear on the display.
3. When the caller has finished speaking, you will hear a tone and see **"Push to Talk"** on the display.
4. Press and hold the DC button and wait for a tone to sound and a message ("**Me**") to appear onscreen. Continue the Direct Connect call as described previously.

**Tip:** Press  or the call list button to dismiss an incoming Direct Connect call.

## End a Direct Connect Call

- ▶ Do nothing; the call will automatically end after several seconds if neither party presses the DC button.

– or –

Press  or the call list button.

## Convert a Direct Connect Call to a Voice Call

1. While on a Direct Connect call, press **OPTIONS** (right softkey) > **Convert Call**.
2. Read the message, and then select a number (if more than one number is available) or select **CONVERT CALL** (left softkey).

Your phone ends the Direct Connect call and dials the selected number.

**Tip:** **Quieting incoming calls and increasing your privacy.** When you are in an area where incoming Direct Connect calls may disturb others, or if you wish to increase the privacy of your calls, please set your speakerphone to off and your ringer to vibrate.

When the speakerphone is off, Direct Connect calls use the phone's earpiece and microphone, while still utilizing the DC button. You may also use an earbud or other hands-free device for increased convenience.

## Direct Connect Permissions

You can control which numbers can reach your phone using Direct Connect.

### Set Direct Connect Permissions

1. Press  > **Settings** > **DC Settings** > **Permissions**.
2. Select **Accept all DC calls, except those from numbers I block** or **Reject all DC calls, except those from numbers I allow**.
3. If you selected **Accept all DC calls, except those from numbers I block**, select **Block Another #** > **New Number**, **Contacts**, or **Recent DC's**.

– or –

If you selected **Reject all DC calls, except those from numbers I allow**, select **Allow Another #** > **New Number** or **Contacts**.

4. Follow the instructions to add or edit the **BLOCKED DC #S** or the **ALLOWED DC #S** list.
5. The blocked numbers show a red circle with a bar, and the allowed numbers a tick mark in a green circle, both on the phone type icons which appear next to the numbers on the Contacts list, Contacts details, etc.

**Tip:** You can also allow or block numbers directly from the Contacts list or History. From the Contacts or Recent History list, press **OPTIONS** (right softkey) > **Allow DC Calls** or **Block DC Calls** and follow the onscreen instructions.

### Change Permissions

You can change the permissions approach from specifying the blocked numbers to specifying the allowed numbers, or vice versa. All the entries on your existing Blocked DC #s or Allowed DC #s list will be deleted when this switch is made.

1. Press  > **Settings** > **DC Settings** > **Permissions**.
2. Press **OPTIONS** (right softkey) > **Change Approach**.
3. Read the message and press **CHANGE** (left softkey) > **Block Another #** or **Allow Another #**.
4. Follow the instructions to add or edit the **Blocked DC #s** or the **Allowed DC #s** list.

# Call Alerts

Call Alerts let you notify others that you want to communicate with them using Direct Connect. When a user receives a Call Alert, the phone sounds a tone and displays your name or Direct Connect number.

[Send a Call Alert](#)

[Reply to a Call Alert](#)

## Send a Call Alert

Send a notification to start a Direct Connect call.

1. Enter a Direct Connect number or select a number from History or Contacts.

**Note:** When sending a Call Alert, make sure you select the Direct Connect number for the person you are trying to reach. See [To tell if a number is a valid Direct Connect number](#).

2. Press **MSG/ALERT** (left softkey) > **Call Alert**. (You will see a prompt.)
3. Press and release the DC button. (The receiving phone emits an incoming tone and displays an alert.)

**Tip:** If you get an error message saying that your contact “is not reachable via Direct Connect” or “this number is not DC capable,” please check to see that you have entered or highlighted a valid Direct Connect number. See [To tell if a number is a valid Direct Connect number](#).

## Preset Text Feature With Call Alert

You may attach a brief preset text message to the call alert.

1. Enter a Direct Connect number or select a number from History or contacts.
2. Press **MSG/ALERT** (left softkey) > **Call Alert**. (You will see a prompt.)
3. Press the navigation key left or right to scroll through available messages.
4. Display a message and press and release the DC button.

**Note:** Preset text messages with Call Alert can only be sent to and from Direct Connect users with Sprint phones. If you send a Call Alert with text to another Direct Connect subscriber without this capability (such as a Nextel user), the user will receive the Call Alert but will not receive the text message.

**Note:** There is no additional charge to send preset text messages with Call Alerts.

## *Reply to a Call Alert*

Call Alerts continue to repeat for a set amount of time (default is five minutes) or until you return the call or dismiss the alert. You can adjust the default time in the **Settings > DC Settings > Call Alerts > Repetition > Repeat** menu.

1. With the Call Alert displayed, press and hold the DC button to return the call.
2. Continue with the Direct Connect call as previously detailed.

To dismiss a Call Alert:

- ▶ Press **IGNORE** (right softkey).

## *Group Connect*

A Group Connect call is a Direct Connect call made to up to 20 Direct Connect users with Sprint phones nationwide at one time. You can make a Group Connect call in several different ways:

- By setting up a group entry in Contact on your phone.
- By using the Sprint Mobile Sync tool available at [sprint.com](http://sprint.com). See [Sprint Mobile Sync](#).
- By selecting or entering multiple numbers for a one-time call.

For information on creating groups and storing them in Contacts, see [Create a Group Entry](#).

**Important:** When making a Group Connect call or creating a group list for Group Connect calls in Contacts, you must select an entry's DC-capable number. If you select a non-DC-capable number, the name will be added to the list, but Group Connect calls will not go through to that group member.

### [Make Group Connect Calls](#)

#### [Group Connect Call Information](#)

## *Make Group Connect Calls*

You can make Group Connect calls by selecting saved groups from your Contacts, selecting from group calls saved in History, or by creating groups for one-time use.

### *Make a Group Connect Call From Contacts*

1. In standby mode, press **CONTACTS** (right softkey).
2. Highlight a group and press the DC button to begin the Group Connect call.
3. Continue the Group Connect call in the same manner as a one-to-one Direct Connect call.

**Note:** Only one person at a time may speak on a Group Connect Call.

4. When you are finished, press  to end the call. (By default, when you end a Group Connect call that you initiated, all other participants are dropped from the call. To change this option, see [Set Group Termination Options](#).)

**Note:** If you get an error message saying that your contact “is not reachable via Direct Connect” or “this number is not DC capable,” please check to see that you have entered or highlighted a valid Direct Connect number.

**Note:** Currently Sprint phones do not support Group Connect calls with Nextel and PowerSource phones. This enhancement is planned for future implementation. If your calls are not going through, please check to see whether your contact is using a Sprint phone.

### *Make a Group Connect Call From History*

1. Press  > **History**.
2. Highlight a group entry and press the DC button.
3. Continue the Group Connect call as described previously.

### *Make a Group Connect Call Without Saving*

1. In standby mode, press  > **Contacts** > **Add New** > **New Group**.
2. Press **START** (left softkey) to add Contacts entries with DC-capable numbers to the group.
  - When adding a contact for the Group Connect call, make sure you highlight the entry’s DC-capable number (**DC Only** or **Mobile+DC**).
3. When you have finished selecting entries, press the DC button.
4. Continue the Group Connect call as described previously.

### *Join or Rejoin a Group Connect Call*

If you are not available at the beginning of a Group Connect call, or if you drop off the call temporarily, you can rejoin an in-progress Group Connect call.



1. Press  > **History**.
2. Highlight the call and press the DC button.
3. Continue the Group Connect call as described previously.

**Tip:** You can also join or rejoin a Group Connect call from your Contacts list if you have stored the group. See [Create a Group Entry](#). Select the group entry and press the DC button.

**Note:** If the Group Connect call has already ended, pressing the DC button initiates a new Group Connect call.

**Note:** If you do not want to participate in a Group Connect call, press .

### *Set Group Termination Options*

1. Press  > **Settings** > **DC Settings** > **Group Call Options**.
2. Highlight an option and press 
  - **End the call for everyone:** terminates the call session for all connected members.
  - **Allow the call to continue:** keeps the call active even after you hang up. The call will remain active until the last members disconnect.

### *Group Connect Call Information*

During a Group Connect call, the following information may appear on your screen:

- The name of the group.
- The name or Direct Connect number of the person speaking.
- The number of group members who are connected to the call out of the number invited (for example, 4 out of 6).

### *Invites*

You can send an Invite to initiate a Group Connect call. When the group members receive an Invite, their phones sound a tone and display your name (if it is in Contacts).

While on a call, you may also send an invitation message to a specific Contacts entry, or to the group members who have not joined the call yet.

#### [Send an Invite](#)

#### [Reply to an Invite](#)

### *Send an Invite*

#### *Send an Invite to start a call*

1. Select a group from History or Contacts.
2. Press **MSG/INVITE** (left softkey) > **DC Invite**. (You will see a prompt.)
3. Press and release the DC button.

## *Send an Invite during a call*

To send an Invite to the group members who have not joined the call yet during a Group Connect call:

- ▶ While on a Group Connect call, press **OPTIONS** (right softkey) > **Send Invites**.

To send an Invite to a personal or group Contacts entry during a Direct Connect or Group Connect call:

1. While on a Direct Connect or Group Connect call, press **OPTIONS** (right softkey) > **Add to Call**.
2. Select an entry from the displayed list or select one of the following options:
  - **Go to Contacts** to select an entry from the available Contacts list.
  - **NEW #** (left softkey) to enter a Direct Connect number and press **NEXT** (left softkey).
3. Press **Send Invites**.

## *Reply to an Invite*

1. With the DC Invite displayed, press and hold the DC button to return the call.
2. Continue with the Direct Connect call as previously detailed.

To dismiss an Invite:

- ▶ Press **IGNORE** (right softkey).

## *TeamDC*

TeamDC lets Direct Connect users make group calls to up to 34 other users nationwide. With TeamDC, any Direct Connect or Sprint user can create a TeamDC group online, which the system then automatically pushes to all the group members' phones. Once a user creates and distributes a TeamDC group, any member of the group can make a TeamDC call to the entire group. If the user who created the group makes any changes to the group, the system automatically sends updates to the members' phones.

**Note:** The TeamDC feature supports group calls only with Direct Connect users with Sprint phones. You cannot include users with Nextel phones in TeamDC groups.

[Set Up a TeamDC Group](#)

[Update TeamDC Groups](#)

[Make a TeamDC Call](#)

[Remove Yourself from a TeamDC Group](#)



## Set Up a TeamDC Group

Any Direct Connect subscriber on a Sprint phone can create TeamDC groups online. Only the TeamDC group creator or an account administrator may modify a group member list once he or she has created it.

1. Sign on to your account at [sprint.com](http://sprint.com).
2. From your account summary page, click **My Online Tools > Sprint Mobile Sync > My Contacts > Add Group > TeamDC**.
3. Add TeamDC members directly (using Direct Connect numbers) or select individual members or groups from your Contacts list.
4. **(Optional)** Click **Set Talker Priority** to select a Talker Priority for each group member. (Default is **Medium**.)
  - You can assign a priority of **Low**, **Medium**, or **High** to each member.
  - During a TeamDC call, members with a higher Talker Priority can “break in” when members with a lower priority are speaking.

**Note: Talker Priority:** The optional TeamDC “Talker Priority” feature lets you define a priority level (Low, Medium, or High) for each member of a TeamDC group. When a TeamDC call is active, members with a higher priority may interrupt a member with a lower priority while he or she is speaking. By default, the system all members of a TeamDC group a “Medium” priority level.

5. Click **Save** to save the TeamDC group and distribute it to the other group members.

## Update TeamDC Groups

1. In standby mode, press **CONTACTS** (right softkey).
2. Highlight any entry in the list and press **OPTIONS** (right softkey) > **List TeamDC Groups**.
  - Your phone will connect to the network and retrieve a current list of TeamDC Groups for your account.

## Make a TeamDC Call

1. In standby mode, press **CONTACTS** (right softkey).  
– or –  
Press  > **History**.
2. Highlight a TeamDC group and press the DC button.

3. Continue the TeamDC call as any other Direct Connect or Group Connect call.
4. When you are finished, press  to end the call. (When you end a TeamDC call that you initiated, all other participants are dropped from the call.)

**Note: Group Termination Options:** By default, when the originator of a Group Connect or TeamDC call ends the call, the system disconnects all other participants as well. When available, you will be able to select a setting in **Settings > DC Settings > Group Call Options** to allow Group Connect and TeamDC calls you initiate to remain active after you leave the call.

### *Join or Rejoin a TeamDC Call*

If you are not available at the beginning of a call, or if you drop off the call temporarily, you can rejoin the in-progress TeamDC call.

1. Press  > **History**.
2. Highlight the TeamDC entry and press the DC button.
3. Continue the TeamDC call as described previously.

**Tip:** You may also join or rejoin a TeamDC call from your Contacts. Select the TeamDC group and press the DC button.

**Note:** If the TeamDC call has already ended, pressing the DC button initiates a new TeamDC call.

### *Remove Yourself from a TeamDC Group*

1. In standby mode, press **CONTACTS** (right softkey).
2. Highlight a TeamDC group and press **OPTIONS** (right softkey) > **Remove Me**.
3. Press **REMOVE** (left softkey).

**Note:** This action also deletes the TeamDC group you belonged to from your Contacts.

**Note:** TeamDC group membership can either be forced or non-forced. With a forced TeamDC group, an end user on the same account cannot be removed from the group, whereas a user not on the same account can.

### *TeamDC Call Information*

During a TeamDC call, the following information may appear on your screen:

- The name of the group.
- The name or Direct Connect number of the person speaking.
- The number of TeamDC members who are connected to the call out of the number invited (for example, 4 out of 6).

# Settings

---

This section provides an overview of items you can change using your phone's **Settings** menus.

[Display Settings](#)

[Volume Settings](#)

[Ringer Settings](#)

[Messaging Settings](#)

[Phone Setup Options](#)

[Roaming](#)

[Security Settings](#)

## *Display Settings*

Adjusting your phone's display settings not only helps you see what you want, it can also help increase battery life.

[Change the Screen Saver](#)

[Change the Brightness](#)

[Change the Backlight Settings](#)

[Set the Notification Pop-up](#)

[Select a Picture ID](#)

[Power Save Mode](#)

[Change the Clock/Calendar Display](#)

[Set a Custom Greeting](#)

[Change the Phone's Menu Style](#)

[Change the Font Size](#)

[Display Language](#)



## *Change the Screen Saver*

You can set a screen saver to display while in standby mode.

1. Press  > **Settings** > **Display** > **Screensaver**.
2. Select a screen saver option by pressing the navigation key up or down, and select a screen saver.

## *Change the Brightness*

You can adjust the brightness on the main screen.

1. Press  > **Settings** > **Display** > **Brightness**.
2. Highlight a brightness level and press  twice.

## *Change the Backlight Settings*

Select how long the display screen remains backlit after any keypress is made. You can also change the backlight settings for a Java application that is running in the foreground.

To change the main screen backlight setting:

1. Press  > **Settings** > **Display** > **Backlight**.
2. Select **Backlight Dim** or **Backlight Off**.
  - If you select **Backlight Dim**, select **Always Bright**, **Always Dim**, or a preset length of time to elapse before the screen backlight dims.
  - If you select **Backlight Off**, select a preset length of time to elapse before the screen and keypad backlights turn off. (When you select **Always Bright** for the **Backlight Dim** setting in step 2, the keypad backlight will turn off after about one minute.)

**Note:** Long backlight settings reduce the battery's talk and standby times.

To change the Java application backlight setting:

- ▶ Press  > **Settings** > **Display** > **Backlight** > **Java Backlight** > **Default** or **Continuous**.

## *Set the Notification Pop-up*



This option allows you to enable or disable notification pop-up when you receive a new notification (except for incoming call and alarm).

1. Press  > **Settings** > **Display** > **Notification**.
2. Select **Enable Pop-up** or **Disable Pop-up**.

**Tip:** If you select **Disable Pop-up**, you will see only a notification icon. (The notification pop-up will not appear while an application is running.)

## *Select a Picture ID*

You can select an image as a picture ID.

1. Press  > **Settings** > **Display** > **Picture ID**.
2. Select **Contact**, **Unsaved Numbers**, or **Private / Unknown**.
  - If you select **Contact**, select an entry.
3. Select a picture ID option and press .
4. Select an image and press  to assign it.



## *Power Save Mode*

This feature helps conserve your battery power by automatically adjusting the backlight setting of your phone.

1. Press  > **Settings** > **Display** > **Power Save Mode**.
2. Select **On**. (Select **Off** to deactivate this feature.)
3. Read the message and press **CONTINUE** (left softkey).



## *Change the Clock/Calendar Display*

Select a clock/calendar display on the main screen in standby mode.

1. Press  > **Settings** > **Display** > **Clock/Calendar**.
2. Highlight an option and press  twice.

## *Set a Custom Greeting*

You can display your own custom greeting in standby mode.

1. Press  > **Settings** > **Display** > **Greeting** > **Custom**.
2. Enter a custom greeting and press .
3. Press **DONE** (left softkey) to save your greeting.

## *Change the Phone's Menu Style*

Choose the layout of your phone's menu.

1. Press  to display the main menu.
2. Press **OPTIONS** (right softkey) > **Grid View** or **List View** to change the menu style.

## *Change the Font Size*

Adjust the font size for the main screen. This setting does not affect all screens.

- ▶ Press  > **OPTIONS** (right softkey) > **Large Font** or **Normal Font**.

– or –

1. Press  > **Settings** > **Others** > **Accessibility** > **Font Size**.
2. Highlight a font size. You can see the current and new font sizes in the display window above the menu.
3. If you are satisfied with the font size, press **SAVE** (left softkey).

## *Display Language*

You can choose to display your phone's onscreen menus in English or in Spanish.

1. Press  > **Settings** > **Others** > **Language**.
2. Select **English** or **Español**.

## *Volume Settings*



Adjust your phone's volume settings to suit your needs and your environment.

### [Adjust the Phone's Volume Settings](#)

#### [Silence All](#)

## *Adjust the Phone's Volume Settings*

You can separately adjust the volume of various sounds your phone makes.

1. Press  > **Settings** > **Volume**.
2. Select **Incoming Ringer**, **Playback Volume**, **Power Up/Down**, or **Key Beeps**.
  - If you select **Power Up/Down**, select **On** or **Off**.
  - If you select **Key Beeps**, select **Tone Volume** or **Tone Type**.
3. Select a volume level and press .

**Tip:** You can adjust the ringer volume in standby mode or during an incoming call and the volume during playback by using the volume button.

## *Silence All*

The Silence All option allows you to mute all sounds without turning your phone off.

To activate Silence All:

- ▶ Press and hold the volume button down in standby mode. (The screen will display "Silence All.")

To deactivate Silence All:

- ▶ Press the volume button up repeatedly to select a volume level.

## *Ringer Settings*

You can assign a ringer or vibration pattern to incoming calls, messages, etc. and also enable audio guidance.

### Ringers

#### Set Up Voice Guide

#### Select a Vibration Pattern

## *Ringers*

Ringers help you identify incoming calls and messages. You can assign ringers to individual Contacts entries, types of calls, and messages.

### *Select Ringers for Incoming Calls/Messages*

1. Press  > **Settings** > **Ringers** > **Incoming Calls** or **Messages**.
2. Select **Contacts**, **Unsaved Numbers**, or **Private / Unknown**.
  - If you select **Contacts**, select **All Contacts**, or select **One Contact** and then select an entry.
3. Select a ringer option by pressing the navigation key up or down, and then select a ringer. (See [Get New Ringers](#) if you selected **Downloaded** > **Get New**.)

**Tip:** Ringers can be assigned from the **Contacts** menu. See [Assign a Ringer to a Personal Entry](#).

### *Select Ringers for Direct Connect*



1. Press  > **Settings** > **Ringers** > **Direct Connect**.
2. Select **Incoming DC Calls** or **Chirp**.
3. Select a ringer option by pressing the navigation key up or down, and then select a ringer.

### *Select Ringers for Voicemail, Calendar, and Power Up/Down*

1. Press  > **Settings** > **Ringers**.
2. Select **Voicemail**, **Calendar**, or **Power Up/Down**.
3. Select a ringer option by pressing the navigation key up or down, and then select a ringer.

## Get New Ringers

A wide variety of new ringers is available from the Sprint Digital Lounge, and you can access them right from your phone. (Additional charges may apply, but some are free.)

1. Press  > **Settings** > **Ringers**.
2. Select a ringer type category (**Incoming Calls**, **Voicemail**, **Messages**, etc.) and any applicable subcategories.
3. Select **Downloaded** > **Get New**. (The Digital Lounge will launch and display the Ringers menu.)
4. Use the navigation key and keypad to search through available ringers. When you find one you want, highlight it and press .
5. To purchase the ringer, use your navigation key to move the cursor over **Buy**. When the cursor changes from an arrow into a hand, press . (The ringer will download automatically.)
6. When the download is finished, select an option to continue:
  - **Listen** to listen to the ringer.
  - **Assign** to assign the ringer to a call or message type or to a specific contact.
  - **Shop** to browse for other items to download.

## Set Up Voice Guide



Voice Guide allows you to hear voice prompts and spoken numbers or key names as you press a key, and also to hear menus and options, Contacts names, email addresses, URLs, etc., as you highlight each item onscreen. (The default setting is **Off**.)

1. Press  > **Settings** > **Others** > **Accessibility** > **Voice Services** > **Voice Guide**.
2. Select **On** or **Off**.

**Note:** When the ringer volume is set to **Silence All** or **Vibrate All**, Voice Guide does not work.

## Select a Vibration Pattern

You can select vibration patterns for incoming calls, messages, alarms, and scheduled events.

1. Press  > **Settings** > **Others** > **Accessibility** > **Vibrate Type**.
2. Select **Incoming Calls**, **Voicemail**, **Messages**, or **Alarm/Calendar**.
3. Highlight a vibration pattern and press .



## *Messaging Settings*

Your phone's advanced messaging capabilities let you send and receive different kinds of messages without placing a voice call.

Messaging settings allow you to create a signature with each sent message and your own preset messages.

[Set Clear Alerts Icon](#)

[Message Alerts](#)

[Set a Callback Number](#)

[Add a Customized Signature](#)

[Manage Preset Messages](#)

[Long Message Reassembly](#)

### *Set Clear Alerts Icon*

Clear Alerts Icon will clear the envelope icon on the display.

1. In standby mode, press **MESSAGING** (left softkey) > **OPTIONS** (right softkey) > **Clear Alerts Icon**.
2. Press **YES** (left softkey).

### *Message Alerts*

You can set how often your phone alerts you when there is a new message notification.

1. In standby mode, press **MESSAGING** (left softkey) > **OPTIONS** (right softkey) > **Repeated Tone** > **Messages**.
2. Select **Single Tone** (once only) or **Repeated Tone** (once every minute).

### *Set a Callback Number*

With this feature, you can specify the callback number your recipients see when you send messages.

1. In standby mode, press **MESSAGING** (left softkey) > **OPTIONS** (right softkey) > **Callback Number**.
2. Select **None**, **My Phone Number**, or **Other**. If you select **Other**, enter a callback number and press .

### *Add a Customized Signature*

Add a customized signature to each message you send.

1. In standby mode, press **MESSAGING** (left softkey) > **OPTIONS** (right softkey) > **Signature**.
2. Select **On**. (If you do not wish to attach a signature to your outgoing messages, select **Off**.)
3. Enter a signature and press .

## Manage Preset Messages

Your phone is loaded with 20 preset messages to help make sending messages easier. Customize or delete these messages, such as “Where are you?,” “Let’s get lunch,” and “Meet me at” to suit your needs, or add your own messages to the list.

To edit or delete a preset message:

1. In standby mode, press **MESSAGING** (left softkey) > **OPTIONS** (right softkey) > **Preset Messages**. The list of preset messages will be displayed.
2. To edit or delete a message, highlight it and press **OPTIONS** (right softkey).
3. Select **Edit**, edit the message, and press .

– or –

Select **Delete** > **YES** (left softkey) to delete the message. (You can also reset all messages by selecting **Reset all messages** > **YES** [left softkey].)

To change the language of the preset message:

1. In standby mode, press **MESSAGING** (left softkey) > **OPTIONS** (right softkey) > **Preset Messages**.
2. Press **OPTIONS** (right softkey) > **Select Language**.
3. Select **English** or **Spanish**.

## Long Message Reassembly

When you receive a long message, it is divided into up to 15 messages and delivered to your phone. You can choose to combine them to display as one message rather than segmented ones.

1. In standby mode, press **MESSAGING** (left softkey) > **OPTIONS** (right softkey) > **Long Message Re-assembly**.
2. Select **On** or **Off**.

## Phone Setup Options

[Navigation Key Shortcuts](#)



Direct Connect Button

Keyguard

Headset Mode

## *Navigation Key Shortcuts*

You can use the navigation keys as shortcuts to access specific menu items directly from standby mode. You can reassign the default shortcuts to the menu items you choose.

1. Press  > **Settings** > **Others** > **Navigation Keys**.
2. Highlight the navigation key you wish to reassign and press .
3. Using the navigation key or your keypad, highlight a function.
4. Press **ASSIGN** (left softkey) to save. (For options with submenu levels, such as Settings, you can assign submenu options by navigating to the desired option before pressing **ASSIGN**.)

## *Direct Connect Button*

When you are not provisioned for Direct Connect service, you can assign the DC button to other function.

1. Press the DC button in standby mode and then press **CUSTOMIZE** (left softkey).  
– or –  
Press  > **Settings** > **Others**.
2. Select **DC Button** > **Do Nothing**, **Calendar**, **Bluetooth**, or **Alarm**.

## *Keyguard*

This feature enables you to lock side buttons while the phone is closed.

1. Press  > **Settings** > **Keyguard**.
2. Select **On**.

**Tip:** You can deactivate this feature temporarily by pressing and holding the external speaker button while the phone is closed.

## *Headset Mode*

Set up your phone for hands-free use, the type of headset (mono or stereo), and the ringer mode.

To set the audio mode:

- ▶ Press  > **Settings** > **Others** > **Headset Mode** > **Earpiece** > **Stereo** or **Mono**.

To set the ringer mode:

- ▶ Press  > **Settings** > **Others** > **Headset Mode** > **Ringer Sound** > **Normal** or **Headset Only**.

To set the headset button mode:

Press  > **Settings** > **DC Settings** > **Headset Mode** > **Headset Button** > **Headset button starts Voice calls. [TALK Key]** or **Headset button starts DC calls. [DC button]**.

## *Roaming*

Roaming is the ability to make or receive calls and access data services when you're off the Nationwide Sprint Network.

[Roaming on Other Networks](#)

[Roaming Settings](#)

[Roaming Guards](#)

### *Roaming on Other Networks*

When you're roaming on other networks, your call quality and security will be similar to the quality you receive when making calls on the Nationwide Sprint Network. However, you may not be able to access certain features, such as data services, depending on the available network.

**Note:** If you're on a call when you leave the Nationwide Sprint Network, your call is dropped. If your call is dropped in an area where you think Sprint service is available, turn your phone off and on again to reconnect to the network.

### *Roaming Icon*

Your phone's display screen always lets you know when you're off the Nationwide Sprint Network.

Anytime you are roaming, the phone displays the roaming icon (.

**Note:** **Sprint Direct Connect** - Direct Connect services are not available while roaming off the Nationwide Sprint Network.

### *Check for Voicemail Messages While Roaming*

When you are roaming off the Nationwide Sprint Network, you may not receive on-phone notification of new voicemail messages. Callers can still leave messages, but you will need to periodically check your voicemail for new messages if you are in a roaming service area for an extended period of time.

1. Dial your ten-digit wireless phone number.
2. When you hear your voicemail greeting, enter **\*66**.
3. Enter your password at the prompt and follow the voice prompts.

When you return to the Nationwide Sprint Network, voicemail notification will resume as normal.

## Roaming Settings

Your phone allows you to control your roaming capabilities. By using the Roaming menu option, you can determine which signals your phone accepts.

To set the roaming mode:

1. Press **MENU** > **Settings** > **Others** > **Roaming** > **Roaming Mode**.
2. Select an option:
  - **Sprint Only** to access only the Nationwide Sprint Network and prevent roaming on other networks.
  - **Automatic** to seek service on the Nationwide Sprint Network. When Sprint service is unavailable, the phone searches for an alternate service.

When the roaming mode is set to Automatic, you can specify which services are available while roaming.

1. Press **MENU** > **Settings** > **Others** > **Roaming** > **Roaming Settings**.
2. Highlight each service you want to enable when roaming and press **MENU**:
  - **Domestic Voice** to access voice service while roaming domestically.
  - **Domestic Data** to access data service while roaming domestically.
  - **International Voice** to access voice service while roaming internationally.
  - **International Data** to access data service while roaming internationally.
3. Press **DONE** (left softkey) > **YES** (left softkey).

**Note:** Data service is not available without the voice service for both domestic and international settings. Enabling data service automatically enables its voice service and disabling voice service automatically disables its data service.

## Roaming Guards

Your phone has two ways of alerting you when you are roaming off the Nationwide Sprint Network: the onscreen roaming icon and Roaming Guards. Roaming Guards make it easy to manage your roaming by requiring an extra step before you can place calls, answer calls, or access data services (such as messaging) while roaming. (This extra step is not required when

you are using the Nationwide Sprint Network.) Roaming Guards can be configured separately for domestic and international usage.

To turn Roaming Guards on or off:

1. Press **MENU** **OK** > **Settings** > **Others** > **Roaming** > **Roaming Guards** > **Domestic** or **International**.
2. Highlight each service you want to enable Roaming Guards for and press **MENU** **OK**.
  - **Voice** to display a prompt that will require you to respond anytime you attempt to access voice service while roaming in the selected region (domestic or international).
  - **Data** to display a prompt that will require you to respond when you attempt to access data service while roaming in the selected region (domestic or international). The prompt will not appear again while you are in the data session you allowed.
  - **Outgoing SMS** to display a prompt that will require you to respond anytime you attempt to send a text message while roaming internationally.
3. Press **DONE** (left softkey).

**Note:** Roaming Guards are turned on by default on your phone.

To place roaming calls with Roaming Guards on:

1. From standby mode, dial the area code followed by the seven-digit number and press **TALK**.
2. Read the message and press **1**.

To answer incoming roaming calls with Roaming Guards on:

1. Press **TALK**.
2. Read the message and press **1**.

To access data services while roaming with Roaming Guards on:

- ▶ When a notification appears informing you that data roam charges may apply, press **ROAM** (left softkey) to connect.

To send a text message while roaming with Roaming Guards on:

- ▶ When a notification appears informing you that data roam charges may apply, select **Send Now**. You can select **Auto Send Later** to send the message automatically when you return to Sprint coverage, or you can simply save the message by selecting **Save**.

**Note:** You can turn a Roaming Guard off by selecting **Never Ask** when the message is displayed.

# Security Settings

The Security settings menus let you set phone security, lock code, and more.

[Lock Your Phone](#)

[Limit Use](#)

[Delete Phone Content](#)

[Reset Your Phone and Phone Content](#)

[Security Features for Data Services](#)

## Lock Your Phone

When your phone is locked, you can only make calls to 911 and Sprint Customer Service.



1. Press  > **Settings** > **Lock Phone**.
2. Enter your lock code.
3. Select **Lock Now**.

**Tip:** The first time you access the Lock Phone menu, you will be advised to change the default lock code by pressing **CHANGE** (left softkey). Enter and re-enter your new lock code to proceed. For details, see [Change the Lock Code](#).

## Unlock Your Phone

1. From standby mode, press **UNLOCK** (left softkey).
2. Enter your lock code.

## Change the Lock Code

1. Press  > **Settings** > **Lock Phone** and enter your lock code.
2. Select **Change Lock Code**.
3. Enter your new lock code.
4. Re-enter your new lock code. (You will be prompted to create a lock code hint to help you remember your new lock code.)
5. If you want to create a lock code hint, select **YES** (left softkey). Enter a hint and press .

– or –

Select **NO** (right softkey) to return to the previous menu.

To edit or delete a lock code hint:

1. Press **MENU OK** > **Settings** > **Lock Phone** and enter your lock code.
2. Select **Lock Code Hint**.
3. Edit the hint and press **MENU OK**.

– or –

Delete the hint by pressing **BACK** and press **MENU OK**.

**Tip:** If you can't recall your lock code, try using the last four digits of your wireless phone number or check your lock code hint. If this doesn't work, call Sprint Customer Service at **1-888-211-4727**.

## *Limit Use*

This feature allows you to limit the use of certain functions on the phone.

### *Activate the Limit Use Feature*

1. Press **MENU OK** > **Settings** > **Limit Use** > **On/Off** > **On**.
2. Enter your new code.
3. Re-enter your new code.

The next time you try to access this setting, you will be required to enter your Limit Use code.

### *Change the Limit Use Code*

1. Press **MENU OK** > **Settings** > **Limit Use** and enter your limit use code.
2. Select **Change Limit Use Code**.
3. Enter your new code.
4. Re-enter your new code.

### *Restrict Voice Calls and Messages*

1. Press **MENU OK** > **Settings** > **Limit Use** and enter your limit use code.
2. Select **Restriction**.
3. Read the message and press **CONTINUE** (left softkey).
4. Select an option:
  - **Voice Calls** to restrict incoming and outgoing voice calls except those placed to 911 or Sprint Customer Service.
  - **Messages** to restrict sending messages except to designated recipients.



5. Select **On/Off > On**. Read the message and press **OK** (left softkey).

**Note:** If you select **On**, you cannot add, edit, and delete any **Contacts** or **Group** entries.



6. Select **Allowed Contacts > All Contacts** or **Choose Contacts**.
  - If you select **Choose Contacts**, select **<Add Contact>**, and then choose a member from the list. If you want to remove a member from the list, highlight the member and press **REMOVE** (left softkey).

### *Restrict Web, Camera, and Location Mode*

1. Press  > **Settings > Limit Use** and enter your limit use code.
2. Select **Restriction**.
3. Read the message and press **CONTINUE** (left softkey).
4. Select an option:
  - **Web** to prevent using the browser.
  - **Camera/Camcorder** to disable the camera and camcorder function.
  - **Force Location On** to prevent turning the Location function off. See [GPS Services](#).
5. Select **On**.

### *Delete Phone Content*

You can quickly and easily delete all the content that you have created or stored in your phone.



1. Press  > **Settings > Reset/Delete** and enter your lock code.
2. Select **Delete Stuff**.
3. Highlight an option and press .
  - **Messages** to delete all messages.
  - **Call Logs** to delete all call history from the phone.
  - **Browser Cookies and Cache** to delete all Web cookies and all Web cache memory saved in the phone.
  - **Downloaded Content** to delete all data downloaded to your phone.
  - **Contacts** to delete all of your Contacts including speed dial numbers saved in your Contacts.
  - **Voice Memo** to delete all voice data and call memos saved in the phone.

- **My Photos & Videos** to delete all pictures and videos stored in My Photos & Videos.
- **File Manager(In Phone)** to delete all files saved in File Manager.
- **All Stuff** to delete all user-added data.

4. Read the message and press **DELETE** (left softkey).

## *Reset Your Phone and Phone Content*

This option lets you clear different types of personal information stored on your phone, reset your phone to factory settings, or both.

1. Press  > **Settings** > **Reset/Delete**.
2. Enter your lock code.
3. Highlight an option and press .
  - **Reset Settings** to restore all the factory defaults, including ringer types and display settings. Contacts, History, Calendar, and Messaging are not affected.
  - **Reset Phone** to reset all settings and erase all data on your phone.
4. Read the message and press the left softkey (**RESET SETTINGS** or **RESET PHONE**).

## *Security Features for Data Services*

### *Enable Data Services*

Although your phone's data services are turned off by default, you may enable them at any time.

To enable data services:

1. Press  > **Settings** > **Others** > **Data Settings** > **Data** > **On**. (A message is displayed.)
2. Press **YES** (left softkey) to enable data services.

**Note:** If Direct Connect services are enabled on your phone, this setting is set to **On** automatically and is not displayed.

### *Disable Data Services*

You can disable data services again without turning off your phone; however, you will not have access to all data services, including Web and messaging. Disabling data services will avoid any charges associated with these services. While signed out, you can still place or receive phone calls, check voicemail, and use other voice services.

To disable data services:

1. Press  > **Settings** > **Others** > **Data Settings** > **Data** > **Off**.

2. Read the disclaimer and press **DISABLE** (right softkey) to sign out.

### *Net Guard*

When you first connect to the Web, the Net Guard will be displayed to confirm that you want to connect. The Net Guard helps you avoid accidental connections. You can disable the Net Guard in the future by selecting **Auto-Connect** when you see Net Guard displayed.

To change your Net Guard settings:

- ▶ Press  > **Settings** > **Others** > **Data Settings** > **Net Guard**.
  - **On** to activate the Net Guard.
  - **Off** to deactivate the Net Guard.

**Note:** When enabled, Net Guard appears only once as long as you have not turned the phone off and on.

If Direct Connect services are enabled on your phone, this setting is set to Off automatically and is not displayed.

# History

---

History keeps track of the calls placed, received, and missed on your phone.

[View History](#)

[History Options](#)

[Make a Call From History](#)

[Save the Information in Your History](#)

[Delete History](#)

## View History

History is a list of the last 60 incoming, outgoing, or missed phone calls and Direct Connect calls including Call Alerts. History makes redialing fast and easy. It is continually updated as new numbers or entries are added to the beginning of the list and the oldest entries are removed from the bottom of the list.

Each entry contains the phone number (if available) and Contacts entry name (if the number is in your Contacts). Duplicate calls (calls from the same number) may appear only once on the list.

[The History List](#)

[History Icons](#)

[History Thread](#)

[History Details](#)

## The History List

▶ Press  > **History**.



















**Shortcut:** From standby mode, press  or the call list button to display your recent calls.

**Tip:** From standby mode, press the DC button to display your Direct Connect (including Call Alert) call history only.

**Note:** History records only calls that occur while the phone is turned on. If a call is received while your phone is turned off, it will not be included in History.

## History Icons



You can determine if an entry was an incoming, outgoing, or missed call from the icons shown below.

	Incoming	Outgoing	Missed
Phone Call			
Direct Connect Call			
Call Alert			
Group Connect Call			
TeamDC Call			
Group Connect Invite			

## History Thread

The History thread screen shows all history for a selected entry. You can also keep track of all the messages you have sent and received for the selected entry.

To display a History thread:

1. Press  > **History**.
2. Highlight an entry and press .

## History Details

To display History details:

1. Press  > **History**.
2. Highlight an entry from the list and press . The History thread is displayed.
3. Highlight an entry and press .

An onscreen menu may also be available according to the type of call. See [History Options](#).



## History Options

You may see several menu items on the onscreen menu. Press **OPTIONS** (right softkey) for additional options.

- **Call** to call the selected entry.
- **Send Message** to send a message to the selected entry.

- **New Group** to create a new Group entry. See [Create a Group Entry](#).
- **Contact Details** to display information about the entry if it has already been saved in your Contacts.
- **Save Contact** to save a phone number. See [Save a Number From History](#).
- **Group Details** to display information about the group if it has already been saved in your Contacts.
- **Save Group** to save a Group entry. See [Save a Group From History](#).
- **Delete** to delete the entry.
- **Delete All** to delete all History entries. See [Delete History](#).
- **Prepend** to add numbers to the beginning of the selected number.
- **Allow DC Calls/Block DC Calls** to allow or block a phone number for Direct Connect calls. See [Direct Connect Permissions](#).
- **Call Alert** to send an alert to someone that you'd like to talk with using a Direct Connect call. See [Send a Call Alert](#).
- **Recent DC's** to display the Direct Connect call history.
- **Rename** to change an entry's current name to Caller ID name.
- **Remove Me** to remove yourself from the TeamDC group. See [Remove Yourself from a TeamDC Group](#).

## *Make a Call From History*

1. Press  > **History**.
2. Highlight an entry and press .

**Note:** You cannot make calls from History to entries identified as **No Caller ID**, **Private (Restricted ID)**, or **Unavailable ID**.

## *Save the Information in Your History*



You can store the information which appears in your History into your Contacts.

[Save a Number From History](#)

[Save a Group From History](#)

[Make a New Group Entry From History](#)



## Save a Number From History

1. Press  > **History**.
2. Highlight an entry and press **OPTIONS** (right softkey) > **Save Contact**.
3. Select **New Entry** or **Existing Entry**.
4. If **New Entry** was selected, select a number type, and then enter the new entry name.  
– or –  
If **Existing Entry** was selected, select an existing entry to which you want to save the number, and then highlight a number type and press .
5. Press **DONE** (left softkey) to save the entry.

## Save a Group From History

1. Press  > **History**.
2. Highlight a group entry and press **OPTIONS** (right softkey) > **Save Group**.
3. Enter a group name and use the keypad to complete or edit the group entry.
4. Press **SAVE** (left softkey).

## Make a New Group Entry From History

1. Press  > **History** > **OPTIONS** (right softkey) > **New Group**.
2. Read the message and press **START** (left softkey).
3. Highlight an entry you want to add to a group and press . A check mark will appear in the box next to the selected entry.

**Tip:** Press **OPTIONS** (right softkey) > **Enter New Address** or **Contacts** to enter a new phone number or address or to select an entry from your history.

**Note:** Each group entry can contain up to 40 members for sending messages, or up to 20 members for making Direct Connect group calls.

4. When you have selected all the entries you want to add, press **CONTINUE** (left softkey).
5. Enter a group name and press  > **SAVE** (left softkey).

## Delete History

You can delete individual or all entries in your History.

1. Press  > **History**.

2. Highlight an entry you wish to delete and press **OPTIONS** (right softkey) > **Delete**.
3. Select **Delete All** to delete all entries.
4. If you are certain you want to delete one or all entries from History, press **DELETE** (left softkey).



# Contacts

---

Your phone's Contacts help you stay in touch with family, friends, and colleagues by keeping track of all their contact information. This section explains how to use your phone's Contacts.

[About Contacts](#)

[View Contacts](#)

[Create a New Contacts Entry](#)

[Edit a Contacts Entry](#)

[Find Contacts Entries](#)

[Use Contacts Information in Other Applications](#)

[Assign Speed Dial Numbers](#)

[Secret Contacts Entries](#)

[Dial Sprint Services](#)

[Sprint Mobile Sync](#)

## About Contacts

There are three types of Contacts entries:

- **Personal Contacts Entry** – An entry for an individual. Your phone can store up to 600 personal Contacts entries. Each entry can contain up to seven phone numbers (including direct Connect numbers), and three email addresses, IM addresses, and Web addresses.
- **Group Connect Entry** – An entry that contains more than one personal Contacts entry. Your phone can store up to 25 group connect entries. Each group entry can contain up to 40 members for sending messages, or up to 20 members for making Direct Connect group calls.
- **TeamDC Entry** – An entry created and managed online, which contains up to 35 personal Contacts entries including the creator. Once created, the TeamDC entry is distributed to the members via server and only the creator or an account administrator may modify the entry. Your phone can store up to 40 TeamDC entries.

## View Contacts

Access your Contacts entries currently stored in your phone.

The Contacts List

Contacts Details

View History From Contacts

## *The Contacts List*

1. In standby mode, press **CONTACTS** (right softkey). You will see the Contacts list.
2. Highlight a personal entry to show the entry's main phone number, or highlight a group entry to show how many members it has.

## *Contacts Details*

1. In standby mode, press **CONTACTS** (right softkey).
2. Highlight an entry and press  to show the details.

**Tip:** Highlight any data field and press  on the details screen. Menu options for that field will appear, if available.

## *View History From Contacts*

You can view the history of a selected Contacts entry from the Contacts list.

1. In standby mode, press **CONTACTS** (right softkey).
2. Highlight an entry and press **OPTIONS** (right softkey) > **Contact History**.

## *Create a New Contacts Entry*

Add new Contacts entries to your Contacts to build it up.

**Note:** Your Contacts also stores TeamDC entries, but a user must create TeamDC entries online. See [Set Up a TeamDC Group](#).

Create a Personal Entry

Create a Group Entry

Save a Number Using the Phone Keypad

## *Create a Personal Entry*

1. In standby mode, press **CONTACTS** (right softkey) > **Add New...** > **New Contact**.
2. Enter a name for the new entry and press the navigation key down.
3. Enter the phone number or Direct Connect number and press . See [Your Direct Connect Number](#) for information on Direct Connect numbers.

4. Highlight a number type for the entry (**Mobile, Mobile+DC, Home, Work, DC Only, Pager, Fax, or Other**) and press .
5. Press **DONE** (left softkey).

After you have saved the number, the new Contacts entry is displayed.

**Tip: ICE - In Case of Emergency**

To make it easier for emergency personnel to identify important contacts, you can list your local emergency contacts under “ICE” in your phone’s Contacts list. For example, if your mother is your primary emergency contact, list her as “ICE-Mom” in your Contacts list. To list more than one emergency contact, use “ICE1-\_\_\_,” “ICE2-\_\_\_,” etc.

## *Create a Group Entry*

You can create a group by assigning personal Contacts entries as members and then naming the new group. Each group entry can contain up to 40 members for sending messages, or up to 20 members for making Direct Connect group calls. Currently, Sprint phones do not support Group Connect calls with Nextel or PowerSource phones. When creating a group entry, please make sure to include only users with Sprint phones.

1. In standby mode, press **CONTACTS** (right softkey) > **Add New... > New Group**.
2. Read the message and press **START** (left softkey).
3. Highlight an entry you want to add to a group and press . A check mark will appear in the box next to the selected entry.

**Tip:** Press **OPTIONS** (right softkey) > **Enter New Address** or **Recent History** to enter a new phone number or address or to select an entry from your history.

**Note:** When creating a group for Direct Connect group calls, you must select an entry’s DC-capable number. If you select a non-DC-capable number, the name will be added to the list, but Group Connect calls will not go through to that group member.

4. When you have selected all the entries you want to add, press **CONTINUE** (left softkey).
5. Enter a group name and press  > **SAVE** (left softkey).

## *Save a Number Using the Phone Keypad*

You can save a phone number to Contacts directly from the phone keypad.

1. From standby mode, enter a phone number or Direct Connect number.
2. Press **OPTIONS** (right softkey) > **Save**. (If this is the first time you are saving an entry to Contacts, skip to step 4.)
3. Select **New Entry** or **Existing Entry**.
4. If you chose **New Entry**, select a number type, and then enter the new entry name.

– or –

If you chose **Existing Entry**, select an entry to which you want to save the number, and then highlight a number type and press .

5. Press **DONE** (left softkey) to save the entry.

## *Edit a Contacts Entry*

Once you've added a Contacts entry, you can add or edit the information in the entry.

[Edit a Contacts Entry](#)

[Delete a Contacts Entry](#)

[Add a Number to a Personal Entry](#)

[Assign a Ringer to a Personal Entry](#)

[Assign a Picture to a Personal Entry](#)

[Add Members to a Group Entry](#)

[Remove Members From a Group Entry](#)

## *Edit a Contacts Entry*



1. In standby mode, press **CONTACTS** (right softkey).
2. Highlight the entry you want to edit and press **OPTIONS** (right softkey) > **Edit Contact** or **Edit Group**.
3. Highlight the information you wish to edit.
4. Add or edit the information and press .
5. Press **DONE** (left softkey) or **SAVE** (left softkey) to save your changes.

## *Delete a Contacts Entry*

1. In standby mode, press **CONTACTS** (right softkey).
2. Highlight an entry or a group you want to delete.
3. Press **OPTIONS** (right softkey) > **Delete Contact** or **Delete Group**.
4. Press **DELETE** (left softkey).



## *Add a Number to a Personal Entry*

1. In standby mode, press **CONTACTS** (right softkey).

2. Highlight the entry you want to add a number to and press **OPTIONS** (right softkey) > **Edit Contact** > **<Add Number>**.
3. Enter the new number and press .
4. Highlight a label for the number and press .
5. Press **DONE** (left softkey) to save the new number.

## *Assign a Ringer to a Personal Entry*





Assign a ringer to a Contacts entry so that you can identify the caller by the ringer. See [Ringers](#).

1. In standby mode, press **CONTACTS** (right softkey).
2. Highlight an entry and press .
3. Select **Set Ringers** > **Incoming Calls** or **Message**.
4. Select **Change**.
5. Highlight a ringer category, such as **Default Ringer**, **My Videos**, **Downloaded**, **Preloaded Ringers**, or **No Ringer** and then press .
6. Highlight a ringer and press .

**Tip:** If you select **Downloaded** > **Get New** in step 5, you can purchase and download new ringers right from your phone. For details, see [Get New Ringers and Download Games, Ringers, and More](#).

## *Assign a Picture to a Personal Entry*

Assign a picture to display each time a certain contact calls you.

1. In standby mode, press **CONTACTS** (right softkey).
2. Highlight an entry and press .
3. Highlight  and press .
4. Select **Choose Photo**.
5. Select a photo category and press .
6. Select an image and press  to assign it.

## *Add Members to a Group Entry*

You can add a group member to an existing Group.

1. In standby mode, press **CONTACTS** (right softkey).

2. Highlight the group you want to add members to and press **OPTIONS** (right softkey) > **Edit Group** > **Add More**.
3. Read the message and press **START** (left softkey).
4. Highlight an entry you want to add and press .
  - If the entry has more than one number, select a number or numbers. Each selected number will be added as a separate entry to the group.
5. Repeat step 4 to add additional members.
6. Press **CONTINUE** (left softkey) > **SAVE** (left softkey).

### *Remove Members From a Group Entry*

1. In standby mode, press **CONTACTS** (right softkey).
2. Highlight the group you want to remove members from and press **OPTIONS** (right softkey) > **Edit Group**.
3. Highlight a member and press **OPTIONS** (right softkey) > **Remove from Group** > **YES** (left softkey).
4. Repeat step 3 to remove additional members.
5. Press **SAVE** (left softkey).

### *Find Contacts Entries*

You can easily search the information stored in your Contacts.

#### Find an Entry From Contacts

#### Find an Entry Using the Phone Keypad

### *Find an Entry From Contacts*

1. In standby mode, press **CONTACTS** (right softkey).
2. Scroll through all the entries.  
  
– or –  
  
Enter the first few letters of any part of an entry's name. Contacts with matching letters are listed. (The more letters you enter, the more your search narrows.)
3. Highlight an entry and press  to dial the number displayed. (Press the navigation key left or right to display other listed numbers.)  
  
– or –

Highlight an entry and press  to display the details.

## *Find an Entry Using the Phone Keypad*

You can search Contacts entries for the numbers that contain a specific string of numbers.

1. Enter four or more digits of the number in standby mode. (The more numbers you enter, the more specific the search becomes.)
2. All Contacts entries matching the entered numbers will be displayed.
3. Highlight an entry and press .



– or –

Highlight an entry and press  to display further options available.

## *Use Contacts Information in Other Applications*

You can use saved Contacts information in other applications.

To copy information into a message:

1. In standby mode, press **CONTACTS** (right softkey).
2. Highlight an entry and press .
3. Highlight the information you want to copy, such as phone numbers, email addresses, URLs, or street addresses, and press .
4. Select **Share > Message**.

After you select one or more recipients, the text entry screen for the type of message specified will open, and the selected text will appear in the body of the message.

**Note:** For more information about messaging, see [Messaging](#).

To copy address information into a Sprint Navigation application:

1. In standby mode, press **CONTACTS** (right softkey).
2. Highlight an entry and press .
3. Highlight an address and press .
4. Highlight an option and press 
  - **Navigate** to get directions to the street address using Sprint Navigation.
  - **Map** to display the address on a map.

**Note:** For more information about your phone's navigation features, see [GPS Navigation](#).



## Assign Speed Dial Numbers

Your phone can store up to 98 phone numbers or Direct Connect numbers in speed dial locations. (See [Call Using a Speed Dial Number](#) and [Make a Direct Connect Call Using a Speed Dial Number](#).)

1. Add a number to a new or to an existing Contacts entry. See [Add a Number to a Personal Entry](#), if the number is not in your Contacts.

– or –

In standby mode, press **CONTACTS** (right softkey), highlight an entry and press .

2. Highlight the number and press **OPTIONS** (right softkey) > **Set Speed Dial**.
3. Highlight an available speed dial location and press .
4. Press  to return to the Contacts menu.

**Tip:** To replace a current assignment, select a location and press **REPLACE** (left softkey).

To check speed dial assignments:

1. In standby mode, press **CONTACTS** (right softkey).
2. Press **OPTIONS** (right softkey) > **Settings** > **Speed Numbers**.

## Secret Contacts Entries

When you make an entry secret and hide it, that entry is not displayed in your Contacts. In History, a telephone number is displayed but the Contacts entry's name is not. You cannot make TeamDC entries secret.

To set or unset an entry secret:

1. In standby mode, press **CONTACTS** (right softkey).
2. Highlight an entry and press **OPTIONS** (right softkey) > **Set as Secret** or **Set as Not Secret**.

To hide or show secret entries:

1. In standby mode, press **CONTACTS** (right softkey).
2. Press **OPTIONS** (right softkey) > **Settings** > **Hide Secret** or **Show Secret**.
3. Enter the four-digit lock code.

**Tip:** If you can't recall your lock code, try using the last four digits of your wireless phone number. If this doesn't work, call Sprint Customer Service at **1-888-211-4727**.



## Dial Sprint Services













Your Contacts list is preprogrammed with contact numbers for various Sprint services.

To dial a service from your Contacts:

1. In standby mode, press **CONTACTS** (right softkey).
2. Press **OPTIONS** (right softkey) > **Settings** > **Services**.
3. Select **Hear Minutes** (Account Info.), **Customer Solution** (Service), **Directory Assistance** (Sprint 411), **Sprint Operator**, **Hear Balance**, **Voicemail**, **Community Information**, **Non Emergency Services**, **Traffic Information**, **Carrier Repair Service**, **TRS Relay for TTY**, **Call Before You Dig**, or **Emergency**.
4. Press .

To dial a service from standby mode using your keypad:

► Dial the appropriate service number:

- Account Info. -   
- Customer Service -   
- Sprint 411 -    
- Sprint Operator -  

## Sprint Mobile Sync

You can add and edit all your contacts and groups, including TeamDC groups, online using the Sprint Mobile Sync service. With Sprint Mobile Sync you can:

- **Add and edit contacts and groups.** Use your computer to easily add, edit, and manage contacts and groups, and set up and manage TeamDC groups.
- **Synchronize and back up your contacts.** Save all the contacts information from your phone in a secure location, and automatically synchronize new information from the computer to the phone and from the phone to the computer.
- **Transfer contacts to a new phone.** When you activate a new phone, Sprint Mobile Sync sends your existing contact information to the phone upon activation.
- **Erase contact information from a lost phone.** If your phone is lost or stolen, Sprint Mobile Sync can remotely remove all the contact information. You can then send the information to your replacement phone.

- **Import and export contacts with online address books.** Import or export contact information from or to Outlook, or other compatible databases.

### *Prepare Your Phone for Sprint Mobile Sync Service*

Once your phone makes itself available to the Mobile Sync service, it will display a message on the screen and prompt you to activate the service. Follow the onscreen instructions to activate the service. (You will see a message when the process is complete.)

### *Activate Sprint Mobile Sync*

1. Press  > **Tools** > **Mobile Sync**.
2. Follow the onscreen instructions to complete activation.

### *Access Sprint Mobile Sync Online*

1. Sign on to your **MySprint** page at [sprint.com](http://sprint.com).
2. Click **MyOnline Tools** > **Sprint Mobile Sync** > **My Contacts**.
3. Follow the onscreen instructions to add, edit, and manage all your contact information

# Messaging

---

Send your messages to your family and friends with Text Messaging (SMS) and Multimedia Messaging (MMS). You can also set up an Email account on your phone.

## Text Messaging and Multimedia Messaging

### Email

## Text Messaging and Multimedia Messaging

With messaging, you can send and receive messages between your phone and another messaging-ready phone. When you receive a new message, it will automatically display on your phone's screen.

In addition, messaging includes a variety of preset messages, such as "The meeting has been cancelled," that make composing messages fast and easy. Use your phone to customize your own preset messages (up to 50 characters).

There are two types of messaging, Text Messaging (SMS) and Multimedia Messaging (MMS).

Text messages can be composed of up to six segments of 160 (140 in Spanish) characters each, for a total of 960 (840 in Spanish) characters per text message. The current segment and total segment count is displayed at the top of each segment. For example, (5/6) at the top of a segment would indicate you are viewing segment five of a six-segment message.

Multimedia messages consist of both text and multimedia files, such as pictures, videos, or voice recordings. Outgoing multimedia messages can be up to 1 MB with up to 1000 text characters.

## Compose Messages

### Access Messages

### Threaded Messaging

## Compose Messages

1. Press  > **Messaging**.

**Shortcut:** Press **MESSAGING** (left softkey) in standby mode.

2. Press **Send Message**.
3. Select a recipient from the list or from the following options:
  - **Go to Contacts** to select a recipient from your Contacts. (Qualifying Contacts entries must contain a phone number or an email address.)

- **MULTIPLE** (left softkey) to select multiple recipients. Press **CONTINUE** (left softkey) when you have finished selecting and entering recipients. (You may include up to 40 recipients per message.)
  - **NEW ADDRESS** (right softkey) to enter a recipient's phone number or email address directly. Press **CONTINUE** (left softkey) to proceed.
4. Compose a message.
    - Press **OPTIONS** (right softkey) to select additional options.
  5. Select **<Add Attachment>** and select a category of files you would like to attach (**Picture, Video, Voice, Audio, or File Manager**).
  6. Select a location where your file is stored. (You can also choose to take a new picture or video, or to record a new voice or audio clip.)
  7. Select files you would like to attach.
  8. Review your message and press **SEND** (left softkey).

## *Access Messages*

To read a message:

- ▶ When you receive a message, your phone will display a notification message. Use your navigation key or select **View**.

To reply to a message:

1. While the message is displayed, press **REPLY** (left softkey).
  - Select **Reply to Sender**, or select **Reply All** if you are replying to an MMS message with multiple recipients.
2. Compose a reply and press **SEND** (left softkey).

## *Threaded Messaging*

Threaded messaging lets you follow a chain of messages to and from a particular contact.

To display the thread list:

- ▶ In standby mode, press **MESSAGING** (left softkey) > **Messages**.

You will see a thread list. Each thread has an entry's name (if saved in Contacts), a phone number, or an email address. You will also see the number of unread messages, if any, for each thread.

## View Messages

Highlight a thread and press  to display the messages sent to and received from a particular contact, in reverse chronological order. Failed, pending, and draft messages are also listed.

Highlight a message to see details for that message.

- **Me** - Message you sent.
- **Me (Failed)** - Message you did not send successfully.
- **Me (Pending)** - Message you have not sent yet because your phone has no network connection. The message will be sent automatically when your phone reconnects to the network.
- **Me (Draft)** - Message you saved as a draft. Only one draft can be saved in each thread, and that draft appears at the top of the thread.



## Message Details

Highlight a message and press  to display the message details and view the entire message.

You can select certain information from a message and automatically save it or use it in a related application. See [Simple Data Exchange](#).

## Threaded Messaging Options

When you are viewing a messaging thread list, a message thread, or a message details screen, you can choose from among the following options. (Options will vary according to screen.)

- ▶ Press  or  to make a call.
- ▶ Press **SEND MESSAGE** (left softkey) to send a message to the entry.
- ▶ Press **REPLY** (left softkey) to reply to a message.
- ▶ Press **SEND** (left softkey) to send a draft message.
- ▶ Press **RESEND** (left softkey) to resend a failed message.
- ▶ Select a message, press **OPTIONS** (right softkey) and select an option:
  - **Forward** to forward the selected message.
  - **Call Alert** to send a Call Alert.
  - **Send Invite** to send an Invite.
  - **Lock** to lock the selected message.

- **Unlock** to unlock the selected message.
- **Unlock All** to unlock all messages.

**Note:** Messages are automatically deleted starting with the oldest. To save messages, lock them.

- **Delete** to delete the selected message.
- **Delete All** to delete all messages.
- **Call** to dial the phone number appearing in the selected message.
- **Launch** to open the URL appearing in the selected message.
- **Save Number** to save the phone number appearing in the selected message.
- **Save Email** to save the email address appearing in the selected message.
- **Manage Text Blocking** to block text messages from specific phone numbers or email addresses.
- **Settings** to display the Messaging Settings menu.
- **Combine/Uncombine** to display segmented messages as one message or vice versa.

## *Email*

Messaging allows you to stay connected 24 hours a day anywhere on the Nationwide Sprint Network.

### *Get Started With Email*

1. Press  > **Web**.
2. From the SprintWeb<sup>SM</sup> home page, select **Messaging > Email**.
3. Select **Yahoo! Mail**, **AOL & AIM Mail**, or **MSN Hotmail**.
4. Use your keypad to enter the required sign-in information for the selected provider, such as user name, email address, or password, and select **Sign In**. (Your mailbox for the selected provider will be displayed.)
5. Follow the onscreen instructions to read, reply to, compose, and send messages and manage your email account.

# Calendar & Tools

---

Learn how to use many of your phone's productivity-enhancing features.

[Calendar](#)

[Alarm](#)

[Bluetooth](#)

[microSD Card](#)

[Voice Services](#)

[Calculator](#)

[World Clock](#)

[Countdown Timer](#)

[Stopwatch](#)

## Calendar

Use Calendar to create and manage events, meeting, and appointments. Your Calendar helps organize your time and reminds you of important events.

[Add an Event to the Calendar](#)

[Add a To Do List Item to the Calendar](#)

[Calendar Alerts](#)







[View Events](#)

[Delete Events](#)

### *Add an Event to the Calendar*

Your Calendar helps organize your time and reminds you of up to 100 important events.

1. Press  > **Tools** > **Calendar**.
2. Highlight a day to which you would like to add an event and press **OPTIONS** (right softkey) > **Add Schedule**.
3. Enter a description and press .

4. Select a category for the event (Appointment, Meeting, etc.) by highlighting the category field and pressing .
5. Select a priority for the event by highlighting the priority field and pressing .
6. Select a start and end time for the event by highlighting the start and end time fields and pressing .
7. Highlight the location field and enter a location for the event and press .
8. Select a ringer type for the alarm by highlighting the ringer field and pressing .
  - To download ringers, select **Downloaded > Get New**.
9. Select an alarm time by highlighting the alarm time field and pressing .
10. Select a repeat status for the alarm by highlighting the repeat field and pressing .
  - If you chose **Specific Period**, set a start and end date for the repeat status and press **OK** (left softkey).
  - If you chose **Weekly**, select the check box for each day of week you wish to set and press **DONE** (left softkey).
11. Press **SAVE** (left softkey).





**Tip:** To change the calendar display views, press the left softkey (**MONTH** or **WEEK**) repeatedly to toggle between monthly and weekly views.

**Tip:** On the weekly view, press the navigation key up or down to display the previous week or the next week, respectively.



**Tip:** Press **OPTIONS** (right softkey) > **Settings > Holiday/Weekday** to enter holidays and weekdays.

## *Add a To Do List Item to the Calendar*

Your phone can store and manage up to 40 To Do list items.

1. Press  > **Tools > Calendar**.
2. Highlight a day to which you would like to add a To Do list item and press **OPTIONS** (right softkey).
3. Press the navigation key right and select **Add To Do**.
4. Enter a description and press .
5. Select a category for the item by highlighting the category field and pressing .
6. Select a priority for the item by highlighting the priority field and pressing .



7. Select a time and date for the item by highlighting the time and date field and pressing .
8. Select a status for the item by highlighting the status field and pressing . When you add an item, set it to **Needs Action**.
9. Press **SAVE** (left softkey).

## Calendar Alerts

If you have an event on the Calendar, your phone alerts you by a ringing or vibrating alarm and displays a summary of the event.



To respond to the alarm, select an available onscreen menu or press the appropriate softkey:

- ▶ Press **SNOOZE** (left softkey) or **Snooze** to stop the alarm and start snooze mode (if applicable).
- ▶ Press **DISMISS** (right softkey) to clear the alarm (if applicable).
- ▶ Select **View** to display the event detail screen.



**Tip:** To change the alarm settings, press **OPTIONS** (right softkey) > **Settings** > **Alarm** to set the snooze options.

## View Events

**Tip:** Days with scheduled events are indicated by small colored rectangles just below the date. A rectangle's color depends on the repeat status for an event.

1. Press  > **Tools** > **Calendar**.
2. Highlight the day for which you would like to view events and press . The day's event list is displayed.  
  
– or –  
  
Press **OPTIONS** (right softkey) > **Schedule List** or **To Do List**.
3. Highlight an event and press . The event's details are displayed. You can edit the event on this screen.

## Delete Events

1. Press  > **Tools** > **Calendar**.
2. Highlight the day from which you would like to delete an event and press .  
  
– or –  
  
Press **OPTIONS** (right softkey) > **Schedule List** or **To Do List**.













3. Highlight an event and press **OPTIONS** (right softkey) > **Delete**.
4. Highlight an option and press .
  - **This** to delete the highlighted event.
  - **Select** to delete multiple events.
  - **All on This List** to delete all events on the list.
  - **All Completed Events** to delete completed To Do List items.
5. Press **YES** (left softkey).

To delete old events or all events:

- ▶ Press  > **Tools** > **Calendar** > **OPTIONS** (right softkey) > **Delete Memory** > **Delete Old** (or **Delete All**) > **YES** (left softkey).

## Alarm

Your phone comes with a built-in alarm that has multiple alarm capabilities.

1. Press  > **Tools** > **Alarm**.
2. Highlight an alarm number and press .
3. Turn the alarm on or off by highlighting the alarm field and pressing .
  - Highlight **On** or **Off** and press .
4. Enter a description for the alarm by highlighting the description field and pressing .
5. Select a time for the alarm by highlighting the time field and pressing .
6. Select a repeat status for the alarm by highlighting the repeat field and pressing .
7. Select a ringer option for the alarm by highlighting the ringer field and pressing .
8. Select a volume level for the alarm by highlighting the volume field and pressing .
9. Select a ringer length for the alarm by highlighting the ringer length field and pressing .
10. Select a snooze interval for the alarm by highlighting the snooze interval field and pressing .
11. Select the number of times the snooze should repeat by highlighting the snooze time field and pressing .
12. Press **SAVE** (left softkey).

**Tip:** Press **ON** or **OFF** (left softkey) to toggle the alarm on and off.

## *Bluetooth*

Bluetooth® is a short-range communications technology that allows you to connect wirelessly to a number of Bluetooth devices, such as headsets and hands-free car kits, and Bluetooth-enabled handhelds, computers, printers, and wireless phones. The Bluetooth communication range is usually approximately 30 feet.

[Turn Bluetooth On and Off](#)

[Make Your Phone Discoverable](#)

[Bluetooth Menu](#)

[Pair Bluetooth Devices](#)

[View the Trusted Devices List](#)

[Send Items via Bluetooth](#)

### *Turn Bluetooth On and Off*

By default, your phone's Bluetooth feature is turned off. Turning Bluetooth on enables your phone's Bluetooth functions.

1. Press  > **Tools** > **Bluetooth** > **On/Off**.
2. Press **ON** (left softkey) to enable Bluetooth. Press **OFF** (left softkey) to disable Bluetooth.

### *Make Your Phone Discoverable*

To make your phone discoverable (allowing other Bluetooth devices to detect it), you must set your phone's visibility to other than **Hidden**.

1. Press  > **Tools** > **Bluetooth** > **Visibility**.
2. Select **Visible for 3 min** or **Always visible**. If you select **Always visible**, your phone will be discoverable by all in-range Bluetooth devices until you change the setting. If you select **Visible for 3 min**, your phone will return to hidden mode after three minutes.

### *Bluetooth Status Indicators*

The following icons show your Bluetooth connection status at a glance:



Bluetooth feature is on.



Your phone is visible to other Bluetooth devices.



Your phone is connected to a Bluetooth device.



Your phone is connected to or communicating with a Bluetooth device via Hands-free Profile (HFP).



Your phone is connected to or communicating with a Bluetooth device via Advanced Audio Distribution Profile (A2DP).

The above icons will blink while your phone is communicating with a Bluetooth device.

## *Bluetooth Menu*

The **Bluetooth** menu allows you to set up many of the characteristics of your phone's Bluetooth service, including:

- Setting your phone's visibility (or "discoverability") for other Bluetooth devices.
- Adding a new Bluetooth device to your phone.
- Displaying your Bluetooth trusted devices list.
- Displaying your phone's Bluetooth information.

To access the Bluetooth menu:

- ▶ Press > **Tools** > **Bluetooth** to select from following options:
  - Select **On/Off** to enable or disable Bluetooth.
  - Select **Visibility** > **Hidden**, **Visible for 3 min**, or **Always visible** to set your Bluetooth visibility.
  - Select **Add New** to add a new Bluetooth device.
  - Select **Trusted Devices** to display a list of trusted Bluetooth devices.
  - Select **My Bluetooth Info** to display your phone's Bluetooth name, address, class, and supported profiles.

## *Pair Bluetooth Devices*

The Bluetooth pairing process allows you to establish trusted connections between your phone and another Bluetooth device. When devices are paired, a passkey (PIN) is shared between devices, allowing for fast, secure connections while bypassing the discovery and authentication process.

1. Press > **Tools** > **Bluetooth** > **Add New**.
2. Select the device you wish to pair with and press .
3. Enter the passkey and press .

4. (Optional) Edit the device name and press **SAVE** (left softkey).

**Note:** Due to different specifications and features of other Bluetooth compatible devices, display and operations may be different, and functions such as transfer or exchange may not be possible with all Bluetooth compatible devices.

## *View the Trusted Devices List*

This list displays a list of devices which are paired with your device and set as trusted devices.

- ▶ Press  > **Tools** > **Bluetooth** > **Trusted Devices**.

### *Trusted Devices List Menu*

Once you have created trusted devices, several options are available from the Trusted Devices list.

### *Left Softkey Menus*



1. Press  > **Tools** > **Bluetooth** > **Trusted Devices**.
2. Highlight a device and press the available left softkey options:
  - **CONNECT...** to connect to the selected Bluetooth device, if not connected (for headsets, hands-free and other devices, excluding computers, PDAs, phones, or printers).
  - **TRANSFER...** to send data saved on your phone to the selected Bluetooth device (for computers, PDAs, or phones). See [Send Items via Bluetooth](#).
  - **PRINT...** to print pictures using the selected Bluetooth-enabled printer.

### *Options Menu*

1. Press  > **Tools** > **Bluetooth** > **Trusted Devices**.
2. Highlight a device and press **OPTIONS** (right softkey) to display the following options:
  - **Add New** to add a new Bluetooth device.
  - **Delete** to delete the selected device from the list.
  - **Delete All** to delete all devices from the list.
  - **Auto-Accept** to configure your phone's accessibility to other Bluetooth devices.
  - **View/Edit Info** to view or edit the information of the selected device.
  - **Help** to display the Trusted Devices list help.

## Send Items via Bluetooth

Depending on your paired devices' settings and capabilities, you may be able to send pictures or videos, Contacts information, or other items using a Bluetooth connection.

1. Press  > **Tools** > **Bluetooth** > **Trusted Devices**.
2. Select the device from the Trusted Devices list and press **TRANSFER...** (left softkey).
3. Select an item (**Contacts**, **Photos / Videos**, **Music**, **Files**, or **Calendar Events**) and press .
4. Follow the onscreen instructions to select items to send.
5. Read the message and press **SEND** (left softkey).

## microSD Card

Your phone is equipped with a preinstalled 1GB microSD™ (Secure Digital) memory card and its adapter to expand the phone's available memory space. It allows you to store images, videos, music, and voice data in your phone.

**Note:** Be sure to use only recommended microSD cards (up to 32 GB). Using non-recommended microSD cards could cause data loss and damage your phone.

[Remove or Insert the microSD Card](#)

[microSD Card Settings](#)

[microSD Card Folders](#)

[File Manager](#)

[Connect Your Phone to Your Computer](#)

## Remove or Insert the microSD Card

Your phone comes with the microSD card preinstalled.

**Note:** You can easily damage the microSD card by improper operation. Please be careful when inserting, removing, or handling it.

### Remove the microSD Card

1. Remove the battery cover and the battery. (The battery must be removed in order to remove the microSD card.)
2. Slide the SD card holder in the direction of the arrow to unlock it (①).
3. Raise the card and the card holder with your fingers (②).

- Gently pull out the card from the holder (3).

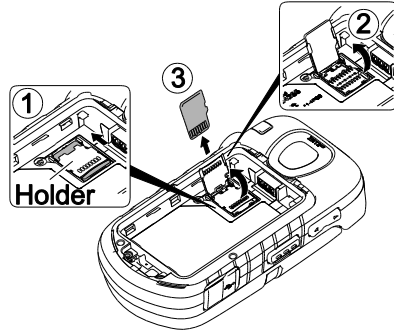

- Replace the card holder and lock it (4).

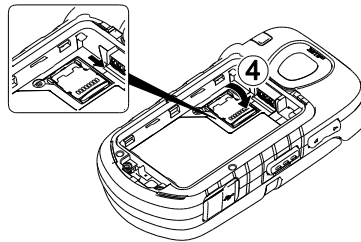

- Place the battery back into its compartment and replace the battery cover.

### *Insert the microSD Card*

- Remove the battery cover and the battery.
- Slide the card holder in the direction of the arrow to unlock it (1).
- Raise the card holder with your finger (2).
- Insert a microSD card into the holder. Make sure to check the position of the gold terminals (3).

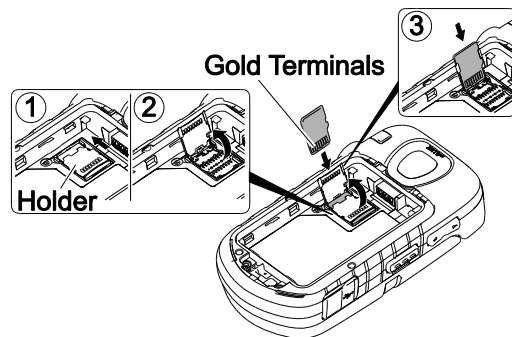

- Gently press the card and the card holder (4), and then slide the holder in the direction of the arrow to lock it (5).

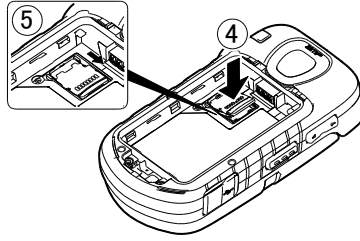

6. Place the battery back into its compartment and replace the battery cover.

**Note:** Make sure your battery is fully charged before using the microSD card. Your data may become damaged or unusable if the battery runs out while using the microSD card.

## *microSD Card Settings*

### *Create Folders in the microSD Card*

The following steps allow your phone to create default folders for storing files in your microSD card.

- ▶ Press **MENU** > **Tools** > **Memory Storage** > **Create Folders**. (The phone will create the microSD's default folders: **DCIM**, **VIDEO**, **MUSIC**, **VOICE**, **SD\_PIM**, **BLUETOOTH**, and **OTHER**.)

### *View Memory*

Your phone allows you to review the memory allocation of both your internal storage area and that of the microSD card.

1. Press **MENU** > **Tools** > **Memory Storage** > **Memory Info**.
  - The Memory Info page is divided into two sections: In Phone and Memory Card.
2. Press your navigation key down to display memory in the microSD card.

### *Format the microSD Card*

Formatting a microSD card permanently removes all files stored on the card.

1. Press **MENU** > **Tools** > **Memory Storage**.
2. Highlight **Format Memory Card** and press **MENU**. (A warning will be displayed.)
3. If you are sure you wish to remove all the files from your microSD card, press **YES** (left softkey).

**Note:** The formatting procedure erases all the data on the microSD card, after which the files **CANNOT** be retrieved. To prevent the loss of important data, please check the contents before you format the card.

### *Back Up Your Contacts Data to the microSD Card*

You can easily back up your phone's Contacts data to the microSD card.





1. Press  > **Tools** > **Memory Storage** > **Save Contacts**. (You will see a confirmation message.)
2. Press **YES** (left softkey) to proceed. (Please wait while the system creates your data.)

## *microSD Card Folders*

### *Display Your microSD Card Folders*

All the files stored in your microSD are accessible through your microSD card folders.



1. Press  > **Tools** > **Memory Storage** > **File Manager** > **Memory Card**.
2. Highlight a folder and press .
3. To view or play a file, highlight it and press  or the appropriate softkey.

**Note:** For information on file and folder options available through File Manager, see [File Manager](#).

## *File Manager*

File Manager allows you to view, copy, move, and perform other housekeeping operations on files such as pictures, videos, music, and applications stored in your phone or on the microSD card.

### *Access File Manager*

1. Press  > **Tools** > **Memory Storage** > **File Manager**.
2. Highlight an option and press 
  - **In Phone** to access files stored in your phone's memory.
  - **Memory Card** to access files stored on the memory card.

**Note:** All unknown or unsupported file types are displayed as **?** or **!**.

### *Open Files in File Manager*

1. Press  > **Tools** > **Memory Storage** > **File Manager** > **In Phone** or **Memory Card**.
2. Highlight a folder and press .
3. Highlight an item and press .

### *File Manager Options*

When viewing files or folders in File Manager, press **OPTIONS** (right softkey) to display available options. Highlight an option and press  to select it.

- **Move** to move a file from the current folder to another folder in your phone or in the memory card.

- **Move to Card/Move to Phone** to move a file from one storage area to another.
- **Copy** to copy a file from the current folder to another folder in your phone or in the memory card.
- **Copy to Card/Copy to Phone** to copy a file from one storage area to another.
- **Delete** to delete a file or folder from File Manager.
- **Import** to import a Contacts file or a calendar file.
- **Sort by** to sort folder contents by name, date, or size.
- **Properties** to view the properties of the selected file.
- **Rename** to change the name of a selected file.

**Note:** You may not be able to use the file if you change the file name extension.

- **Assign** to set images as your screen saver or picture ID for Contacts entries.
- **Send via Bluetooth** to send a file to another Bluetooth device.
- **Send Media** to send a file by attaching it to a message.
- **Print** to print an image using a Bluetooth-enabled printer.
- **Use Bluetooth** to play an audio file through a Bluetooth device.
- **Create Folders** to create preset folders on the memory card. See [Create Folders in the microSD Card](#).
- **List/Thumbnail** to switch between list view and thumbnail view.
- **Memory Info** to view the used and available memory space.
- **Go to Card/Go to Phone** to switch from one storage area to another.
- **Play/Listen/View** to play a video, listen to audio, or view a picture.

## *Connect Your Phone to Your Computer*

Before using your phone's mass storage capabilities, you need to prepare your phone's data services to synchronize with your desktop or laptop computer. Once you have connected the phone to the computer, you can transfer your data to or from the microSD card.

1. Press  > **Tools** > **Memory Storage** > **Connect to PC**. (You will see a confirmation message.)

2. Press **OK** (left softkey) to continue.
3. Connect your phone to your computer using a compatible USB cable. (Wait for the connection to be completed. When connected, the host computer will automatically detect your phone.)

To remove the connection:

- ▶ When you have finished transferring data, click the USB device icon in your computer's notification area, and follow the onscreen instructions to safely unplug the USB cable. (The process may vary depending on your computer.)

– or –

Press **EXIT** (left softkey) > **YES** (left softkey).

### *Important Connection Information*

- To avoid loss of data, **DO NOT** remove the USB cable, the microSD card, or the battery while files are being accessed or transferred.
- **DO NOT** use your computer to change or edit folder or file names on the microSD card, and do not attempt to transfer large amounts of data from the computer to the microSD card. Doing so may cause the microSD card to fail.
- **DO NOT** turn off or restart your computer, or put it into standby mode, while using a mass storage device. Doing so will result in loss or damage of data.
- While you are connected to the computer, your phone's screen will display "Phone Off." You cannot make or receive calls.
- If you connect a mass storage device to a peripheral device, your device may not work properly.

## *Voice Services*

Your phone's voice services let you place calls using your voice, store voice reminders, and record memos right on your phone. This section includes easy-to-follow instructions for using voice-activated features and managing voice memos.

### [Automatic Speech Recognition \(ASR\)](#)

#### [Manage Voice Memos](#)

### *Automatic Speech Recognition (ASR)*

You can use your phone's built-in automatic speech recognition (ASR) software to dial a phone number or to launch phone functions. All you have to do is to talk into the phone, and ASR will recognize your voice and complete tasks by itself.

## Activate ASR

- ▶ From standby mode, press and hold  , , or the external speaker button.

**Tip:** You can also activate ASR and use certain features with the phone closed. Press and hold the external speaker button while in standby mode, and follow the voice prompts.

The phone prompts you to say the name of the command you want to use. To complete your task, simply follow the voice prompts.



Available ASR commands include:

- **Call** <Name or #> to call an entry in your Contacts list or a spoken phone number. See [Make a Voice Call Using ASR](#) for details.
- **Send Message** <Name or #> to send a message to an entry in your Contacts list or to a spoken phone number. See [Send a Message Using ASR](#) for details.
- **Lookup** <Name> to display the detail screen of an entry in your Contacts list. See [Display a Contacts Entry's Information Using ASR](#) for details.
- **Go To** <Menu> to jump directly to menu items or applications. See [Open Menus Using ASR](#) for details.
- **Check** <Item> to check your phone's status. See [Check Phone Status Using ASR](#) for details.

**Tip:** Use ASR in a quiet environment so it can accurately recognize your commands.

**Tip:** During ASR operation, press **TUTORIAL** (left softkey) or **HELP** (left softkey) to get instructions for using the software.

## Make a Voice Call Using ASR

1. Press and hold  , , or the external speaker button.
2. When you hear "Say a command," say "**Call**."
3. When you hear "Say the name or number," say a name or a phone number.
4. When you hear "Which location?," say a number type (for example, "Mobile").

**Tip:** You can skip steps 3 and 4 by saying a name and location after "Call" without pausing (for example, "**Call John Jones mobile**").



**Note:** If ASR does not recognize the name, it will find the most likely matches and display a list of up to three names or numbers. You will hear "Did you say Call?" followed by the name or number. You can confirm by saying "Yes." Say "No" to change the selection.

## Send a Message Using ASR

1. Press and hold  , , or the external speaker button.



2. When you hear “Say a command,” say “**Send Message.**”
3. When you hear “Say the name or number,” say a name or a phone number.
4. When you hear “Which location?,” say a number type (for example, “Mobile”). The phone displays the text entry screen. See page [Messaging](#) for how to compose a message.

### *Display a Contacts Entry’s Information Using ASR*

1. Press and hold , , or the external speaker button.
2. When you hear “Say a command,” say “**Lookup.**”
3. When you hear “Say the name,” say a Contacts entry’s name. The phone displays the detail screen for that Contacts entry.

### *Open Menus Using ASR*

You can jump directly to many menu items or applications by saying “Go to” followed by a menu option.



1. Press and hold , , or the external speaker button.
2. When you hear “Say a command,” say “**Go To.**”
3. When you hear “Which shortcut?,” say an application name (for example, “Messaging”).
4. The phone opens the selected menu.

**Tip:** Say “**More options**” to display additional application names.

### *Check Phone Status Using ASR*

You can use ASR to obtain information about your phone:

- **Status** (all of the following except My Phone Number)
- **Time**
- **Signal Strength**
- **Network**
- **Battery**
- **My Phone Number**

1. Press and hold , , or the external speaker button.
2. When you hear “Say a command,” say “**Check.**”
3. When you hear “Which status item?,” say a command.

## ASR Settings

To change ASR confirmation:

1. Press and hold **TALK**, **SPEAKER**, or the external speaker button.
2. Press **SETTINGS** (right softkey) > **Confirmation**.
  - **Automatic** to ask for confirmation only when the system is not sure what you said.
  - **Always Confirm** to always ask for confirmation.
  - **Never Confirm** to never ask for confirmation.

To adapt the system to your voice:

1. Press and hold **TALK**, **SPEAKER**, or the external speaker button.
2. Press **SETTINGS** (right softkey) > **Adaptation** > **Adapt Voice**.
3. Press **START** (left softkey) and repeat each word, phrase, or telephone number you hear.

To reset the adaptation:

1. Press and hold **TALK**, **SPEAKER**, or the external speaker button.
2. Press **SETTINGS** (right softkey) > **Adaptation** > **Reset Voice** > **YES** (left softkey).

To change the ASR mode:

1. Press and hold **TALK**, **SPEAKER**, or the external speaker button.
2. Press **SETTINGS** (right softkey) > **Audio Modes**.
3. Highlight an option and press **MENU OK**.
  - **Expert Mode** to sound a beep only.
  - **Prompt Mode** to prompt for required information.
  - **Readout Mode** to prompt for required information and to read the text displayed on the main screen.

To change the ASR dialing region:

1. Press and hold **TALK**, **SPEAKER**, or the external speaker button.
2. Press **SETTINGS** (right softkey) > **Dialing Region**.
3. Highlight an option and press **MENU OK**.

- **North America** to recognize only numbers valid in North America.
- **Other** to recognize any number regardless of location.

To display the ASR software version:

1. Press and hold **TALK**, **SPEAKER**, or the external speaker button.
2. Press **SETTINGS** (right softkey) > **About**.

## Manage Voice Memos

Use your phone's Voice Memo to record brief memos to remind you of important events, phone numbers, or grocery list items and to record call memos of the other party's voice during a phone call.

**Note:** You can store up to 600 memos on your phone. Maximum recording time depends on the available memory space on your phone.

### Record Voice Memos

To record an audio memo:

1. Press **MENU OK** > **Tools** > **Voice Services** > **Voice Memo** > **Record**.
2. Start recording after the beep.
3. To end the recording, press **BACK**, **END**, or **STOP** (right softkey).

To record the other party's voice during a phone call:

1. During a call, press **OPTIONS** (right softkey) > **Voice Memo**.
2. Start recording after the beep.

**Note:** Only the other party's voice is recorded during this process.

3. To stop recording, press **BACK** or **STOP** (left softkey).

### Play Voice Memos

To play one or all memos:

1. Press **MENU OK** > **Tools** > **Voice Services** > **Voice Memo** > **List**.
2. Select **In Phone** or **Memory Card**.
3. Highlight the memo you want to play and press **MENU OK**.

– or –

Press **OPTIONS** (right softkey) > **Play** > **All** to play all memos continuously.

To play multiple memos:

1. Press **MENU** > **Tools** > **Voice Services** > **Voice Memo** > **List**.
2. Select **In Phone** or **Memory Card**.
3. Press **OPTIONS** (right softkey) > **Play** > **Multiple** and select memos you want to play.
4. Press **PLAY** (left softkey).

### *Voice Memo Options*



Your phone offers several options for managing voice memos you have recorded.

1. Press **MENU** > **Tools** > **Voice Services** > **Voice Memo** > **List**.
2. Select **In Phone** or **Memory Card**.
3. Highlight a memo and press **OPTIONS** (right softkey) to display available voice memo options:
  - **Play** to play selected memos or all memos.
  - **Speaker On** or **Speaker Off** to activate or deactivate the speakerphone mode.
  - **Edit Title** to edit the title of a memo.
  - **Properties** to display information about a memo.
  - **Type Filter** to filter only audio memos, only call memos, or to display all memos.
  - **Sort by** to sort memos by time recorded, name, or file size.
  - **Go to Time** to set the point from which the memo starts playing.
  - **Go to Card/Go to Phone** to switch between memos recorded on the memory card and to the In Phone folder.
  - **Send Media** to send a memo by attaching it to a message.
  - **Send via Bluetooth** to send memos via Bluetooth.
  - **Copy to Card/Copy to Phone** to copy selected memos to the memory card or to the In Phone folder.
  - **Move to Card/Move to Phone** to move selected memos to the memory card or to the In Phone folder.
  - **Delete** to delete either selected memos or all memos. Select from **This**, **Multiple**, or **All**.

## *Calculator*

Your phone comes with a built-in calculator.



1. Press  > **Tools** > **Calculator**.
2. Enter numbers using your keypad.
  - Press the appropriate key for an arithmetic option (**+** **-** **x** **÷**).
  - Press the left softkey to enter a decimal point.
  - Press **CLEAR** (right softkey) to clear all numbers.
3. Press  for the total.

## World Clock



To view the time in different locations:

1. Press  > **Tools** > **World Clock**.
2. Press the navigation key left or right to scroll through different time zones.

**Note:** Press **OPTIONS** (right softkey) > **Standard** or **Summer** to change between daylight saving time and standard time.

## Countdown Timer

This feature allows you to use your phone as a countdown timer to alert you when a specified period of time has elapsed. You can set up to five timers.

1. Press  > **Tools** > **Countdown**.
2. Highlight a countdown timer number and press .
3. Highlight a setting and press 
  - **Time** to enter the length of the countdown.
  - **Alarm** to set the countdown alarm to on or off.
4. Press **SAVE** (left softkey).

**Tip:** Press **ON** or **OFF** (left softkey) to toggle the countdown alarm on and off.

## Stopwatch

You can record split times or lap times with the built-in stopwatch.

1. Press  > **Tools** > **Stopwatch**.
2. Press **MODE** (left softkey) to select split timing or lap timing.
3. Press **START** (right softkey) to start the stopwatch.

4. Press **SPLIT** or **LAP** (left softkey) to record the time.
5. Press **STOP** (right softkey) to stop timing.
6. Press **RESET** (left softkey) to reset the stopwatch to zero.

# Camera

---

You can use the camera or camcorder to take and share pictures and videos. Your phone comes with a 3.2 megapixel camera with an autofocus feature that lets you capture sharp pictures and videos.

[Take Pictures](#)

[Record Videos](#)

[Store Pictures and Videos](#)

[Send Pictures and Videos](#)

[Print Pictures](#)

## Take Pictures

Taking pictures with your phone's built-in camera is as simple as choosing a subject, pointing the lens, and pressing a button.

[Take a Picture](#)

[Assign Pictures](#)



[Camera Mode Options](#)

[Camera Settings](#)

## Take a Picture

1. Press  > **Photos & Videos** > **Camera** to activate camera mode. Additional camera options are available. See [Camera Mode Options](#) for more information.

**Shortcut:** To activate camera mode, you can also press and hold the camera key (.

2. Using the phone's main screen as a viewfinder, aim the camera lens at your subject.
3. Press , , or **CAPTURE** (left softkey) until the shutter sounds. The picture will automatically be saved in the selected storage area. See [Store Pictures and Videos](#).
  - To return to camera mode to take another picture, press **CAMERA** (left softkey) or .
4. Press **OPTIONS** (right softkey) for more options.
  - **Send** to send your picture in a message. See [Send Pictures and Videos](#).
  - **Assign** to assign the picture. See [Assign Pictures](#).

- **Delete** to delete the picture you just took.
- **Print** to print the picture. You can choose whether to print using a PictBridge- or Bluetooth-enabled printer.
- **Review Media** to go to the In Phone folder or memory card folder to review your saved pictures.
- **Details/Edit** to edit your picture or display details relating to your pictures.

## Assign Pictures

Assign a picture as a screen saver or as a picture ID.

1. Take a picture. See steps 1-3 on [Take Pictures](#).
2. With the picture displayed, press **OPTIONS** (right softkey) > **Assign**, and select an option.
  - **Picture ID** to assign the picture to a Contacts entry as well as to unsaved phone numbers, or to private and unknown phone numbers. See [Select a Picture ID](#).
  - **Screensaver** to assign the picture as a screen saver.

**Tip:** You can also assign pictures from the [My Photos & Videos](#) menu. See [In Phone and Memory Card Folder Options](#).



## Camera Mode Options

Press **OPTIONS** (right softkey) in camera mode to display additional camera options:

- **Picture Mode** to select a picture mode from **Normal**, **Beach/Snow**, **Scenery**, **Mirror Image**, or **Night/Dark**.
- **Flash** to select an option from the following:
  - **Off** to prevent flash from firing.
  - **On This Shot** to fire flash only for the current shot.
  - **On Always** to fire flash for all shots.
  - **Auto** to automatically fire flash when the light level is too low for an available light shot.
- **Zoom** to zoom in on a subject. See [Zoom](#).
- **Self-Timer** to activate the camera's timer. See [Self-timer](#).
- **Fun Tools** to select an option from the following:

- **Multiple Shots** to take multiple shots. See [Multiple Shots](#).
- **Fun Frames** to select your favorite fun picture frame to decorate your picture (displayed only when the resolution setting is 0.3M or 0.1M).
- **Color Tone** to select a wide variety of color tones for the picture.
- **Image Controls** to adjust settings for **Brightness**, **White Balance**, **Sharpness**, or **Contrast**.
- **Camera Settings** to adjust **Resolution**, **Quality**, and other settings. See [Camera Settings](#).
- **Review Media** to go to the In Phone folder or memory card folder to review your saved pictures.
- **Camcorder Mode** to switch to video mode. See [Record Videos](#).
- **Key Guidance** to show keypad shortcuts in camera mode.
- **User Settings** to provide convenient access to your favorite settings.

### *Self-timer*

1. From camera mode, press **OPTIONS** (right softkey) > **Self-Timer**.
2. Highlight a delay time (**5 Seconds** or **10 Seconds**) and press .
3. Press  or **START** (left softkey) when you are ready to start the timer. (A countdown is displayed in the middle of the screen and your phone will beep during the countdown.)
4. Get ready for the picture. (When the timer is down to three seconds, the tone of the beep will change.)

To cancel the self-timer after it has started:



- ▶ Press **CANCEL** (right softkey) or .



### *Multiple Shots*

This feature allows you to take three, six, or nine shots in a continuous sequence. When you take multiple shots, the  icon will be displayed on the upper left corner of the screen.

1. From camera mode, press **OPTIONS** (right softkey) > **Fun Tools** > **Multiple Shots**.



**Note:** When taking multiple shots, the resolution is temporarily set to **0.1M (240x320)**.

2. Highlight an option and press .
3. Highlight the duration of the interval between shots (**Normal** or **Fast**) and press .

4. Press , , or **CAPTURE** (left softkey) to take the pictures. (The screen will display up to nine thumbnail pictures.)

## *Zoom*

This feature allows you to zoom in on an object when you take a picture. You can adjust the zoom from 1x to 12x.

1. From camera mode, press the navigation key right to zoom in or left to zoom out.  
– or –  
From camera mode, press the volume button up to zoom in or down to zoom out.
2. Press , , or **CAPTURE** (left softkey) to take a picture.

## *Camera Settings*

1. From camera mode, press **OPTIONS** (right softkey) > **Camera Settings**.
2. Highlight an option and press :
  - **Resolution** to select a picture's file size from **3.2 M (1536x2048)**, **2.0M (1200x1600)**, **1.3M (960x1280)**, **0.3M (480x640)**, or **0.1M (240x320)**.
  - **Quality** to select the picture quality setting (**Fine**, **Normal**, or **Economy**).
  - **Shutter Sound** to select a shutter sound (**Default**, **"Say Cheese,"** or **"Ready"**).
  - **Status Bar** to display or hide status indicators and softkeys. These can be revealed or hidden by pressing the navigation key up or down.
  - **Auto Save to** to select the storage area for the pictures. See [Set Storage Options](#).
  - **Auto Review to** to select whether or not the picture is displayed for review after you take a picture.

## *Record Videos*

In addition to taking pictures, you can record, view, and send videos to your friends and family with your phone's built-in video camera.

[Record a Video](#)

[Camcorder Mode Options](#)

[Camcorder Settings](#)

## *Record a Video*





1. Press  > **Photos & Videos**.

**Shortcut:** Press  to access the **Photos & Videos** menus.

2. Press **Camcorder** > **Video Mail** or **Long Video** to activate camcorder mode. Additional video options are available. See [Camcorder Mode Options](#) for more information.

**Note:** Video Mail is limited to 50 seconds if **Quality** is set to **Fine** and 70 seconds if set to **Normal**. See [Camcorder Settings](#).

**Note:** The length of a Long Video will vary depending on the quality settings and storage type used (phone or memory card).

3. Using the phone's main screen as a viewfinder, aim the camera lens at your subject.
4. Press **RECORD** (left softkey), , or  to begin recording.
5. Press  or **STOP** (right softkey) to stop recording. The video will automatically be saved in your designated storage area.
  - To return to camcorder mode to take another video, press **CAMCORDER** (left softkey) or .
6. Press **OPTIONS** (right softkey) for more options:
  - **Play** to play the video you just took.
  - **Send** to send your video in a message. See [Send Pictures and Videos](#).
  - **Assign** to assign the video. Select an option and press .
  - **Delete** to delete the video you just took.
  - **Review Media** to go to the In Phone folder or memory card folder to review your saved videos.
  - **Details/Edit** to edit or display details relating to your videos.

## *Camcorder Mode Options*

Several options are available from camcorder mode.

Press **OPTIONS** (right softkey) to display additional options:

- **Video Mode** to select a camcorder mode from **Normal**, **Beach/Snow**, **Scenery**, **Mirror Image**, or **Night/Dark**.
- **Video Light** to turn on the video light. The video light turns on once this option is set to **On**.
- **Zoom** to zoom in on an object. You can adjust the zoom from 1x to 12x.
- **Self-Timer** to activate the timer function. See [Self-timer](#) for details.

- **Color Tone** to select from a wide variety of color tones for your video.
- **Image Controls** to adjust settings for **Brightness**, **White Balance**, and **Contrast**.
- **Video Settings** to adjust your settings. See [Camcorder Settings](#) for details.
- **Review Media** to go to the In Phone folder or memory card folder to review your saved videos.
- **Camera Mode** to switch to camera mode (if applicable).
- **Video Mail Mode/Long Video Mode** to select a video length.
- **Key Guidance** to indicate the key functions in camcorder mode.
- **User Settings** to provide convenient access to your favorite settings.

## *Camcorder Settings*

1. From camcorder mode, press **OPTIONS** (right softkey) > **Video Settings**.
2. Select an option and press .
  - **Resolution** to select video resolution from **QCIF (176x144)** or **Sub-QCIF (128x96)**.
  - **Quality** to select video quality from **Fine** or **Normal**.
  - **Silent Movie** to select **On** to record without sound. Select **Off** to deactivate this feature.
  - **Cue Sound** to select a cue sound (**Default**, **“Action & Cut,”** or **“Ready & Stop”**).
  - **Auto Save to** to select the storage area for the videos. See [Set Storage Options](#).
  - **Auto Review** to select whether or not the video is displayed for review after you finish recording.

## *Store Pictures and Videos*

Your phone’s picture and video storage area is called **My Photos & Videos**. There are two types of folders in My Photos & Videos:

- **In Phone** – See [In Phone Folder](#).
- **On Memory Card** – See [On Memory Card Folder](#).

### [Set Storage Options](#)



[In Phone Folder](#)

[On Memory Card Folder](#)

[In Phone and Memory Card Folder Options](#)

[Review Pictures and Videos in the Assigned Media Folder](#)

## Set Storage Options

1. Press  > **Photos & Videos** > **Other Settings** > **Auto Save to**.
2. Select **In Phone**, **On Memory Card** or **Switch w/Card**. (**Switch w/Card** stores pictures and videos to the memory card when the card is installed.)

### *In Phone Folder*

Your phone's internal storage area is called the **In Phone** folder. From the In Phone folder, you can view all the pictures and videos you have stored there, delete files, and access additional options.

To review your stored pictures and videos in the In Phone folder:

- ▶ Press  > **Photos & Videos** > **My Photos & Videos** > **In Phone**.

### *On Memory Card Folder*

You can save pictures and videos directly to the memory card using your phone's photo and video settings.

To review your stored pictures and videos on the memory card:

- ▶ Press  > **Photos & Videos** > **My Photos & Videos** > **On Memory Card**.

### *In Phone and Memory Card Folder Options*

When you are viewing the In Phone or On Memory Card folder, press **SEND** (left softkey) to send your pictures and videos (See [Send Pictures and Videos](#).), or **OPTIONS** (right softkey) to display the following options:



- **Select Multiple** to select multiple pictures and videos.
- **Slideshow** to view your pictures in slideshow mode (only available when you save two or more pictures to the folder).
- **Assign** to assign the picture or video. Select an option and press .
- **Delete** to delete pictures and videos. Select **This**, **Selected**, or **All**.

**Note:** Deleting data will free up memory space in your phone to enable you to take more pictures and videos.

- **Print** to print pictures. You can choose whether to print using a PictBridge- or Bluetooth-enabled printer.
- **Copy/Move to Card** to copy or move pictures and videos from your phone to your memory card.
- **Copy/Move to Phone** to copy or move pictures and videos from the memory card to your phone.
- **Copy/Move** to copy or move pictures and videos from a memory card folder to another memory card folder.
- **Details/Edit** to edit or display details relating to your pictures or videos.
  - **Text Caption** to edit the selected picture's or video's caption.
  - **Special Effects** (for pictures) to select from **Fun Frames**, **Color Tone**, **Fun Stamps**, or **Rotate**.
  - **Resize** (for pictures) to resize the selected picture. Select **2.0M (1200x1600)**, **1.3M (960x1280)**, **0.3M (480x640)**, or **0.1M (240x320)**. (Some options may not be available depending on the size of picture you have.)
  - **Trimming** (for pictures) to crop the selected picture.
  - **Photo Info** or **Video Info** to display information such as the picture's or video's caption, time/date, and size.
  - **Full Screen** (for pictures) to display the selected picture in full screen view.
  - **Display Size** (for videos) to change the display size (**Actual Size** or **Full Screen**).

## *Review Pictures and Videos in the Assigned Media Folder*

The Assigned Media folder automatically stores copies of pictures or videos assigned as picture IDs or screen savers on your phone. See [Assign Pictures](#).

1. Press  > **Tools** > **Assigned Media**.
2. Use your navigation key to view and scroll through the pictures and videos. (To switch a picture or video from thumbnail view to expand view mode, highlight a picture or video and press .)

## *Send Pictures and Videos*

Once you have taken a picture or a video, you can use the messaging or Bluetooth capabilities of your phone to instantly share it with family and friends as an attachment.

### [Send Pictures and Videos Using the Messaging Feature](#)

## Send Pictures and Videos Using the Bluetooth Feature

### *Send Pictures and Videos Using the Messaging Feature*

1. Press **MENU**  > **Photos & Videos** > **My Photos & Videos** > **In Phone** or **On Memory Card**.
2. Select your pictures or videos to send.
  - Press **OPTIONS** (right softkey) > **Select Multiple** to select multiple pictures or videos.
3. Press **SEND** (left softkey) > **Contact**.
4. Select the recipient from the list or from the following options:
  - **Go to Contacts** to select a recipient from your Contacts. (Qualifying Contacts entries must contain a wireless phone number or an email address.)
  - **MULTIPLE** (left softkey) to select multiple recipients. Press **CONTINUE** (left softkey) when you have finished selecting and entering recipients. (You may include up to 40 recipients per message.)
  - **NEW ADDRESS** (right softkey) to enter a recipient's wireless phone number or email address directly. Press **CONTINUE** (left softkey) to proceed.
5. Compose a message.
6. Confirm the recipients, message, and pictures or videos. (You may also select additional options by pressing the right softkey. Follow the onscreen instructions to add available options.)
7. Press **SEND** (left softkey) to send the pictures and videos.

### *Send Pictures and Videos Using the Bluetooth Feature*

1. Follow steps 1 and 2 of [Send Pictures and Videos Using the Messaging Feature](#).
2. Press **SEND** (left softkey) > **Bluetooth**.
3. Select a device and press **MENU** .
4. Read the message and press **SEND** (left softkey).
5. Follow the instructions on the screen to proceed.

## *Print Pictures*

### [Print Pictures From Your Phone](#)

### [Digital Print Order Format \(DPOF\)](#)

## Print Pictures From Your Phone

Your phone is PictBridge compatible, allowing you to print directly from your phone without connecting to a computer. You can also print your pictures using Bluetooth.

**Note:** Make sure your battery is fully charged before printing your pictures.

To print pictures using a PictBridge-enabled printer:

1. Press  > **Photos & Videos** > **My Photos & Videos** > **In Phone** or **On Memory Card**.
2. Highlight pictures to print and press **OPTIONS** (right softkey) > **Print** > **PictBridge**.
  - Press **OPTIONS** (right softkey) > **Select Multiple** to select multiple pictures.
3. Connect your phone to the PictBridge-enabled printer using a compatible USB cable. (Wait until the connection is completed.)

**Note:** You may not be able to print pictures that you cannot display on your phone.

**Note:** While you are connected to the printer, your phone's screen will display "Phone Off." You cannot make or receive calls during this time.

4. Set the printer settings using your navigation key.
  - **Type:** You can select the print mode from **Default Printer**, **Standard Print**, or **Index Print**.
  - **Copies:** You can set the number of copies from **Single**, **Doubles**, or **Manual** (up to ten per picture).
  - **Size:** You can set the print size from **Default Printer**, **4"x6"**, **5"x7"**, **8"x10"**, or **Letter**. (Print sizes may vary according to the type of printer you have.)
  - **Date:** You can imprint the date on your pictures. Select **On** or **Off**. (Date stamping may not be available depending on the type of printer you have.)
5. When you have finished selecting the printer settings, press **PRINT** (left softkey).
6. When printing is finished, press .
7. Press **YES** (left softkey). Follow the instructions on the display to unplug the USB cable from the phone.

To print pictures using a Bluetooth-enabled printer:

1. Press  > **Photos & Videos** > **My Photos & Videos** > **In Phone** or **On Memory Card**.
2. Highlight a picture to print and press **OPTIONS** (right softkey) > **Print** > **Bluetooth**.
  - Press **OPTIONS** (right softkey) > **Select Multiple** to select multiple pictures.

3. Select the printer and press .
4. Follow steps 4-7 of [To print pictures using a PictBridge-enabled printer:](#).

**Tip:** You can also add a border and caption to your picture on the **Print Setting** screen.

**Note: Printer Error Messages** - From time to time you may encounter printing problems. Your phone will display any printer error messages informing you of the specific problems encountered. Please refer to the user's guide that came with your printer for descriptions, explanations, and possible resolutions for any error messages.

## *Digital Print Order Format (DPOF)*

Digital Print Order Format (DPOF) lets you set up digital print orders in advance, including options such as which pictures to print, number of prints, and index print settings.

1. Press  > **Tools** > **Memory Storage** > **DPOF Print Order**.
2. Select **Standard Print** (to print individual pictures) or **Index Print** (to print an index sheet of thumbnail images).
3. Press **OPTIONS** (right softkey) and select an option:
  - **Select Picture** to select a picture or pictures to print (up to 99).
  - **Photo Info** to display picture information.
  - **Unselect Picture** to cancel a picture selection.
  - **Set No. of Copies** to select the number of copies (up to 99 per picture) to print.
4. Press **SAVE** (left softkey) to save your settings. (If prompted, select whether to print the date on your pictures.)

### *Review DPOF Print Order Settings*

- ▶ Press  > **Tools** > **Memory Storage** > **DPOF Print Order** > **Order Summary**. (The selected print options will be displayed.)

### *Clear a DPOF Print Order*

- ▶ Press  > **Tools** > **Memory Storage** > **DPOF Print Order** > **Clear Order**.

# Web and Data

---

Your phone's data capabilities let you wirelessly access the Internet. This section addresses your phone's data connections and the built-in Web browser.

## Data Services

### Browser

### Download Games, Ringers, and More

## Data Services

With your Sprint service, you are ready to start enjoying the advantages of data services. This section will help you learn the basics of using your data services, including managing your user name, launching a data connection, and navigating the Web with your phone.

### Your User Name

#### Launch a Web Connection

#### Data Connection Status and Indicators

### Your User Name

When you buy your phone and sign up for service, you're automatically assigned a user name, which is typically based on your name and a number, followed by "@sprintpcs.com." (For example, the third John Smith to sign up for Sprint data services might have jsmith003@sprintpcs.com as his user name.)

When you use data services, your user name is submitted to identify you to the Nationwide Sprint Network. Your user name will be automatically programmed into your phone. You don't have to enter it.

#### Find Your User Name

If you aren't sure what your user name is, you can easily find it on your phone.

- ▶ Press  > **Settings** > **Phone Info** > **Phone#/User ID**.

#### Update Your User Name

If you choose to change your user name and select a new one online, or make any changes to your services, you must then update the profile on your phone.

- ▶ Press  > **Settings** > **Others** > **Data Settings** > **Update Data Profile**. (To cancel, press  before completing the update.)

## Launch a Web Connection

Launching a Web connection is as simple as opening the browser on your phone.

- ▶ Press  > **Web**. (Your data connection starts and you see the SprintWeb<sup>SM</sup> home page.)

**Note:** If Net Guard is enabled and displayed (see [Net Guard](#)), press **YES** (left softkey) to continue and launch the Web.

While connecting, you may see an animation before the home page appears.

**Tip:** To change the default launch page to the last page you viewed, press **Options** (right softkey) and select **Browser settings > Startup page > Use the last page I visited > Confirm** (left softkey).

## Data Connection Status and Indicators

Your phone displays the current status of your data connection through indicators at the top of the screen. The following symbols are used:



Your phone is within the Sprint data network service area. This icon animated while your phone is transferring data (for example, when you are opening a Web page).



Your phone is within the Sprint data network service area, but you are not transferring data (for example, when you are viewing a Web page that has already been opened), or you are signed out or disconnected from the data network.



Your phone is outside of the Sprint data network service area.

## Browser

Your phone's Web browser gives you access to websites on the go, using data connections.

### [Learn to Navigate the Web](#)

#### Browser Menu

### *Learn to Navigate the Web*

Navigating through menus and websites during a data session is easy once you've learned a few basics.

**Note:** Before you access the SprintWeb<sup>SM</sup> home page, you may be asked to enter your ten-digit wireless phone number and press . Entering your phone number is not required for access to other Web pages.

## Softkeys

During a data session, the bottom line of your phone's display screen contains one or more softkeys. These keys are shortcut controls for navigating around the Web, and they correspond to the softkeys directly below the phone's display screen.

**Tip:** Depending on which websites you visit, the labels on the softkeys may change to indicate their function.

To use softkeys:

- ▶ Press a softkey. (If an additional pop-up menu is displayed when you press the softkey, select the menu items using your keypad [if they're numbered], or by highlighting the option and pressing .)

## Scrolling

As with other parts of your phone's menu, you'll have to scroll up and down to see everything on some websites.

To scroll line by line through websites:

- ▶ Press the navigation key up or down.

## Selecting

Once you've learned how to use softkeys and scroll, you can start navigating the Web.

To select onscreen items:

- ▶ Use the navigation key to highlight an item, and then press the left softkey (or press .

**Tip:** You'll find that the left softkey is used primarily for selecting items. This softkey is often labeled "GO."

**Tip:** If the items on a page are numbered, you can use your keypad (number keys) to select an item.

Links, which are displayed as underlined text, allow you to jump to Web pages, select special functions, or even place phone calls.

To select links:

- ▶ Highlight the link and press the appropriate softkey.

## Go Back

To go back one page:

- ▶ Press  on your phone.



**Tip:** You can also use  for deleting text (like a BACKSPACE key) when you are entering text.

## Go Home

To return to the home page from any other page:

- ▶ Press and hold .

## Browser Menu

Although the SprintWeb<sup>SM</sup> home page offers a broad and convenient array of sites and services for you to browse, not all sites are represented, and certain functions, such as going directly to specific websites, are not available. For these and other functions, you will need to use the browser menu. The browser menu offers additional options to expand your use of the Web on your phone.

### Open the Browser Menu

You may open the browser menu anytime you have an active data session, from any page you are viewing.

- ▶ From any open Web page, press **Navigation** (left softkey). Use a navigation key for the following operations.

To open a specific page:

- ▶ Highlight a text input field on the top, enter a URL and press .

To open a new window:

- ▶ Highlight a page icon labeled **Open a new page** and press .

To switch windows:

- ▶ Highlight a page icon you want to display and press .

To close a window:

- ▶ Highlight a cross mark on the top right of a page icon you want to close and press .

To go back a page:

- ▶ Highlight  and press .

To go forward a page:

- ▶ Highlight  and press .



To reload a page:

- ▶ Highlight  and press .

### *Open the Browser Options:*

- ▶ From any open Web page, press **Options** (right softkey).

Options available within the browser menu include:

-    to change the display font size on the Web page.
- **Search the web** to launch a Web search.
- **Add this page to bookmarks** to store the address of the currently viewed Web page.
- **View all bookmarks** to display a bookmark list.
- **View browsing history** to display a list of the Web pages visited.
- **Send this page to a friend** to send a URL of the currently viewed Web page.
- **Overview mode** to display the entire web page.
- **Browser settings**
  - **Startup page** to change the default launch page.
  - **Automatic overview mode** to change the default view to overview mode.
  - **Default zoom size** to select the zoom value.
  - **Do not show images/Show images** to display or hide the images on the Web page.
  - **Icon row** to display or hide the area showing icons.
  - **Popups** to allow or block the popups.
  - **Clear private data** to delete the cookies, cache, history, or stored passwords.
  - **Advanced**
    - **Page information** to display information about the currently viewed page.
    - **Browser information** to display information about the browser.
    - **Disable Javascript/Enable Javascript** to disable or enable Java scripting.
    - **Disable Error Log/Enable Error Log** to set whether to save error logs (text files useful for debugging browser errors). To display the error log, select the **View error log** option from the submenu (available only when the error log is enabled).

- **Do not send referrer header/Send referrer header** to set whether to send HTTP URL referrer information.
- **Turn off redirect prompt/Turn on redirect prompt** to set whether to display a prompt when your data is being redirected.
- **Root certificate** to display the certifications.
- **Disable virtual mouse/Enable virtual mouse** to activate or deactivate the virtual mouse.
- **Virtual mouse** to set the speed of the virtual mouse.
- **Reset browser** to reset all browser settings.

## *Download Games, Ringers, and More*

You have access to a dynamic variety of downloadable content, such as games, ringers, screen savers, and other applications. (Additional charges may apply.) Follow the basic steps below to access and download these items.

### *Access the Download Menus*

1. Press  > **My Stuff**.
2. Select a download category (**Games, Ringers, Screen Savers, or Applications**), and then select **Get New**.

– or –

Select **Call Tones**. (The browser will start and take you to the corresponding download menu.)

– or –

1. From the SprintWeb<sup>SM</sup> home page, select **Downloads**, and then select **Sprint Downloads**.
2. Select a download category (**Call Tones, Games, Ringers, Screen Savers, or Applications**) to go to the corresponding download menu. For more information on navigating the Web, see [Learn to Navigate the Web](#).

### *Select an Item to Download*

You can search for available items to download in a number of ways:

- **Featured** displays a selection of featured items.

- **Categories** allows you to narrow your search to a general category. (There may be several pages of available content in a list. Select **Next 9** to view additional items.)
- **Search** allows you to use your keypad to enter search criteria to locate an item. You may enter an entire word or title or perform a partial-word search.

### *Download an Item*

Once you've selected an item you wish to download, highlight it and press . You will see a summary page for the item including its title, the vendor, the download details, and the cost. Links allow you to view the **License Info** page, which outlines the price, license type, and length of license for the download, and the **Terms of Use** page, which details the Premium Services Terms of Use and your responsibility for payment.

To download a selected item:

1. From the information page, use your navigation key to move the cursor over **Buy**. When the cursor changes from an arrow into a hand, press . The item will download automatically. When you see the **NEW DOWNLOAD** screen, you have successfully downloaded the item to your phone. (When you download a call tone, you will not see the **NEW DOWNLOAD** screen. Instead, you will see a screen giving you the option to set the downloaded call tone as your default.)

**Note:** If you have not previously purchased an item, you will be prompted to create your purchasing profile.

2. Select an option to continue:
  - Select a menu such as **Run/Open/Listen/View/Play** to start the downloaded item. Your data session will end, and your phone will redirect you to the appropriate phone menu screen.
  - Select **Assign** to assign a ringer or screen saver to a phone function.
  - Select **Settings** to configure downloaded games or applications.
  - Select **Shop** to browse for other items to download.
  - Press  to quit the browser and return to standby mode.

### *My Content Manager*

Whether you purchase your content from your phone or from your online account management page at [sprint.com](http://sprint.com), **My Content Manager** stores all of your purchases and you may download them to your phone from there.



**My Content Manager** is a storage area on the Nationwide Sprint Network that allows you to store all your purchased files. The files remain in My Content Manager until their license terms have expired—even after you have downloaded the content to your phone. This provides you

with a convenient place to access information about your downloaded files without having to store the information in your phone's memory.

To access My Content Manager:

1. From the SprintWeb<sup>SM</sup> home page, select **Categories > Downloads > My Content Manager**. (You will see a list of your purchased items.)
2. Highlight a category and press . (You will see your downloads for that category.)

To download purchased content from My Content Manager:

1. From the **My Content Manager** display, highlight the item you wish to download, and press . (You will see the information page for the selected item.)
2. Highlight **Download** and press . The item will download automatically. When you see the **NEW DOWNLOAD** screen, you have successfully downloaded the item to your phone. (When you download a call tone, you will not see the **NEW DOWNLOAD** screen. Instead, you will see a screen giving you the option to set the downloaded call tone as your default.)
3. Select an option to continue:
  - Select a menu such as **Run/Open/Listen/View/Play** to start the downloaded item. Your data session will end, and your phone will redirect you to the appropriate phone menu screen.
  - Select **Assign** to assign a ringer or screen saver to a phone function.
  - Select **Settings** to configure downloaded games or applications.
  - Select **Shop** to browse for other items to download.
  - Press  to quit the browser and return to standby mode.

**Tip:** You can also access My Content Manager through the phone's main menu. Go to **My Stuff > [Games, Ringers, Screen Savers, Applications, or IM & Email] > My Content Manager**. The browser will open and take you to the corresponding content.

For complete information and instructions on downloading **Games, Ringers, Screen Savers, and Applications**, visit the Digital Lounge at [sprint.com](http://sprint.com).

# GPS Navigation

---

Your phone's built-in GPS capability gives you access to a number of location-based services.

[GPS Services](#)

[GPS Navigation](#)



[Sprint Family Locator](#)



## GPS Services

Before using any of the location-based services, you must turn on your phone's location mode.

### Activate Location Mode

To enable your phone's Location feature:

1. Press  > **Settings** > **Others** > **Location** > **On/Off**. (You will see the Location disclaimer.)
2. Read the disclaimer and press .
3. Select **On**.

When the Location feature is on, your phone's standby screen will display the  icon. When Location is turned off, your phone will display the  icon.

To send the GPS log to other devices:

1. Press  > **Settings** > **Others** > **Location** > **NMEA Output**.
2. Select **Bluetooth** or **USB**.

**Note:** Turning Location on will allow the network to detect your position using GPS technology, making some Sprint applications and services easier to use. Turning Location off will disable the GPS location function for all purposes except 911, but will not hide your general location based on the cell site serving your call. No application or service may use your location without your request or permission. GPS-enhanced 911 is not available in all areas.

## GPS Navigation

Sprint Navigation gives you turn-by-turn directions onscreen and over speakerphone.

**Note:** Depending on your service plan, Sprint Navigation may require a monthly subscription. Contact Sprint for information and pricing.

## Register Sprint Navigation

Before you can use Sprint Navigation, your phone and service must be registered.

1. Press  > **Maps** > **Sprint Navigation**.
2. Follow the onscreen instructions to enter and submit the required information.

## Use Sprint Navigation

1. Press  > **Maps** > **Sprint Navigation**.
2. Select an option and follow the onscreen instructions to get directions or view maps.
  - **Drive To** lets you enter an address (vocally or using the keypad) or select from categories such as **My Favorites**, **Recent Places**, or **Businesses** to search for turn-by-turn directions.
  - **Search** provides a categorized list of locations such as **Gas Stations**, **Grocery Stores**, and **Hospitals** to help find local businesses and services.
  - **Maps & Traffic** lets you view maps and get traffic information for your current location or for any other location (same categories as **Drive To**).
  - **Share & More** provides access to additional services such as **Share Address**, **Record Location**, and **Preferences**.

**Note:** For more information about Sprint Navigation, visit [sprint.com/navigation](http://sprint.com/navigation).

## Sprint Family Locator

Sprint Family Locator uses GPS technology to locate your child's phone and display the location on an interactive map.

**Note:** Sprint Family Locator service requires an additional monthly fee. Visit [sprint.com/familylocator](http://sprint.com/familylocator) for complete details.

## Sign Up for Sprint Family Locator

1. Press  > **Maps** > **Sprint Family Locator**.
2. Follow the onscreen instructions to enter and submit the required information.

**Note:** You can also sign up for Sprint Family Locator online at [sprint.com/familylocator](http://sprint.com/familylocator).

## Use Sprint Family Locator

1. Press  > **Maps** > **Sprint Family Locator**.
2. Enter the parent phone number and password to sign in to your account.

3. Select a phone to locate from the available child phone list.
4. When you are finished, select **Sign Out**.

**Note:** You may also use Sprint Family Locator with any computer with an Internet connection. Visit [sprint.com/familylocator](http://sprint.com/familylocator) for complete details.



# Copyrights

---

©2011 Sprint. SPRINT and the logo are trademarks of Sprint. KYOCERA is a registered trademark of Kyocera Corporation. Other marks are the property of their respective owners.

This product contains NetFront Browser of ACCESS CO., LTD. ACCESS and NetFront are trademarks or registered trademarks of ACCESS CO., LTD. in Japan and other countries. This software is based in part on the work of the Independent JPEG Group.

The Bluetooth word mark and logos are owned by the Bluetooth SIG, Inc. and any use of such marks by Kyocera Corporation is under license. Other trademarks and trade names are those of their respective owners.

T9<sup>®</sup> is a registered trademark of Nuance Communications, Inc. and its affiliates in the United States and other countries. Copyright © 2011 Nuance Communications, Inc. All rights reserved.



microSD and microSDHC Logos are trademarks of SD-3C, LLC.

# Index

---

- 3-Way Calling, 30
- Abbreviated Dialing, 20, 22
- Activation, 1, 2
- Airplane Mode, 31, 32
- Alarm, 89
- Answering Calls, 25
- Applications
  - Downloading, 122
- Auto-Answer, 31
- Automatic Speech Recognition (ASR), 21, 98
- Backlight, 50, 51
- Battery
  - Capacity, 9
  - Install, 2
- Bluetooth, 90
  - Sending Items, 93
- Browser Menu, 120
- Calculator, 103
- Calendar, 86
- Call
  - Answering, 20, 25
  - Forwarding, 29, 30
  - Making, 20
- Call Alerts
  - Preset Text Feature, 43
  - Replying, 44, 46, 47
  - Sending, 43, 46
- Call Answer Mode, 25, 31
- Call Waiting, 29, 30
- Callback Number, 56
- Caller ID, 29
- Camera, 106
- Clock
  - World Clock, 104
- Contacts, 72
  - Assigning a Picture, 76
  - Assigning a Speed Dial, 79
  - Creating an Entry, 38, 73
  - Deleting an Entry, 75
  - Dialing From, 21

- Editing an Entry, 72, 75
- Making a DC Call From, 39
- Secret Entries, 79
- Countdown Timer, 104
- Data Services
  - Enabling/Disabling, 65
  - Launching, 117, 118
  - Password, 4
  - Security Features, 65
  - User Name, 117
- Deleting Phone Content, 64
- Dialing
  - From Contacts, 21
  - With Pauses, 23
- Direct Connect
  - Activate, 36
  - Call Alerts, 35, 43, 46
  - Direct Connect Numbers, 35, 36, 73
  - Group Connect, 35, 44
  - Making DC Calls (Phone Closed), 38, 40
  - TeamDC, 35, 47
- Display Settings, 50
- Download
  - Ringer, 55
- DPOF, 116
- Emergency Call, 24
- Enter Text, 6, 15
- File Manager, 96
- Finding
  - Phone Number, 78
- Font Size, 52
- Games
  - Buying and Downloading, 117, 122
- GPS Navigation, 125, 128
- GPS Services, 125
- Greeting, 52
- Headset, 58
- Hearing Aid Device
  - Compatibility (HAC) Mode, 33
- History, 67
  - Making a DC Call From, 38, 39
  - Saving a Number From, 69, 70
- Icon indication, 10, 67, 90
- Key Functions, 7

- Keyguard, 58
- Language, 50, 53
- Limit Use, 63
- Location, 125
- Lock Code, 62
- Making Calls, 20
  - From Contacts, 20, 21
  - From History, 69, 70
  - Using ASR, 100
- Messaging, 82
  - Settings, 56
  - Thread, 83
- microSD Card, 93
  - Creating Folders, 95, 97
  - Formatting, 95
- Missed Calls, 20, 27
- Multiple Shots, 108
- My Content Manager, 123
- Net Guard, 66, 118
- Phone (illus.), 7
- Phone Number
  - Display, 6, 14, 36, 38
  - Finding, 78
  - With Pauses, 20, 23
- PictBridge, 115
- Pictures
  - Assigning, 106, 107, 113
  - Storing, 111
  - Taking, 106
- Plus (+) Code Dialing, 20, 22
- Power Save Mode, 52
- Preset Messages, 57
- Resetting, 65
- Ringers
  - Assigning, 54
  - Downloading, 54, 55, 76
- Roaming, 59
- Roaming Guards, 60
- Saving
  - Number From History, 70
- Security, 62
- Self-timer, 107, 108, 110
- Signature, 56, 57
- Speed Dialing, 20, 22, 79

- Assigning Numbers, 22, 40, 72, 79
- Sprint Family Locator, 126
- Sprint Mobile Sync, 44, 72, 80
- Sprint Service
  - Account Passwords, 1, 4
  - Dialing, 72, 80
  - Operator Services, 5
  - Sprint 411, 5
- Stopwatch, 104
- TeamDC
  - Making TeamDC Calls, 47, 48
  - Setting Up Groups, 47, 48, 73
  - Updating Groups, 47, 48
- To Do, 87
- TTY Use, 31, 32
- Turn Your Phone On and Off, 6, 9
- Unlocking Your Phone, 62
- User Name, 117
- Vibration, 55
- Videos
  - Options, 110
  - Recording, 106, 108, 109
- Voice Guide, 55
- Voice Memos, 98, 102
- Voicemail
  - Set Up, 1, 3, 4
  - Setting Up, 27
  - While Roaming, 59
- Volume, 53
- Web, 117
- World Clock, 86, 104
- Zoom, 109