

User Guide

Table of Contents

Get Started	1
Your Phone at a Glance.....	1
Set Up Your Phone.....	3
Charge the Battery.....	3
Your SIM Card.....	4
Charge the Battery Wirelessly	6
Turn Your Phone On and Off	6
Turn Your Screen On and Off.....	7
Setup Wizard.....	8
Set Up Voice Mail	9
Phone Basics.....	11
Touchscreen Navigation	11
Function Buttons.....	13
Your Home Screen	13
Home Screen Overview.....	13
Extended Home Screens.....	15
Manage the Home Screens	15
Weather	17
Dura Grid.....	18
Launcher Screens.....	18
Status Bar.....	19
Notifications Panel.....	19
Quick Settings	20
Enter Text.....	21
Touchscreen Keyboards.....	21
Google Keyboard.....	21
Gesture Typing.....	24
Google Voice Typing	24
Copy and Paste Text.....	25
Phone Calls	27

Make Phone Calls.....	27
Call Using the Phone Dialpad	27
Call from Recents	28
Call from Contacts	28
Call Using a Speed Dial Number	28
Call Emergency Numbers	28
Call Numbers with Pauses.....	29
Call Using the Plus (+) Code.....	29
Receive Phone Calls.....	30
Voice Mail	30
Review Voice Mail	31
Compose and Send a Voice Message	31
Configure Voice Mail Settings.....	32
Voice Mail (Traditional)	32
Set Up Voice Mail	32
Voice Mail Notification	33
Retrieve Your Voice Mail Messages	33
Phone Call Options.....	33
In-call Options.....	33
Caller Name ID	34
Call Waiting	34
3-Way Calling	34
Call Forwarding	35
Set Up Speed Dialing.....	35
Recent Calls	36
Call Settings	37
Assisted Dialing	37
Call Rejection	38
Video Calling	39
Phone Ringtone.....	39
Vibrate When Ringing.....	39
Voice Mail.....	39
Dial Pad Touch Tones	39

Quick Responses.....	40
TTY Mode.....	40
Power Key Ends Call	41
Voice Privacy.....	41
DTMF Tones.....	41
Additional Settings	41
Hearing Aids.....	41
Auto Answer	41
Call Timer	42
Push To Talk Plus (PTT+).....	42
Contacts.....	44
Contacts List.....	44
Add a Contact.....	45
Save a Phone Number.....	46
Edit a Contact	46
Add a Group Contact	50
Edit a Group Contact	51
ICE (In Case of Emergency)	52
Synchronize Contacts	52
Share a Contact.....	53
Accounts and Messaging	54
Gmail / Google.....	54
Create a Google Account.....	54
Sign In to Your Google Account.....	55
Access Gmail.....	55
Send a Gmail Message	55
Read and Reply to Gmail Messages.....	56
Gmail Account Settings	56
Delete a Gmail Account	57
Email	57
Add an Email Account	57
Add a Corporate Account.....	58
Compose and Send Email	58

View and Reply to Email.....	59
Manage Your Email Inbox.....	59
General Email Settings.....	59
Email Account Settings.....	60
Delete Email Accounts.....	60
Message+.....	60
Save and Resume a Draft Message.....	61
Social Networking Accounts.....	61
YouTube.....	61
Hangouts.....	62
Apps and Entertainment.....	63
Google Play Store App.....	63
Find and Install an App.....	63
Google Play Store Options.....	64
Request a Refund for a Paid App.....	64
Open an Installed App.....	65
Uninstall an App.....	65
Google Maps.....	66
Music.....	68
Play Music.....	68
Back Up Your Downloaded Music Files.....	69
Web and Data.....	70
Wi-Fi.....	70
Turn Wi-Fi On and Connect to a Wireless Network.....	70
Check the Wireless Network Status.....	71
Connect to a Different Wi-Fi Network.....	71
The Wi-Fi Settings Menu.....	71
Data Services.....	72
Launch a Web Connection.....	73
Data Connection Status and Indicators.....	73
Virtual Private Networks (VPN).....	73
Prepare Your Phone for VPN Connection.....	74
Install Security Certificates.....	74

Add a VPN Connection	74
Connect to or Disconnect from a VPN	74
Browser	75
Launch Chrome	75
Learn to Navigate Chrome	75
Chrome Menu	76
Select Text on a Web Page	77
Manage Bookmarks	78
Mobile Hotspot	79
Tethering	81
Camera and Camcorder	82
Use the Camera App	82
Open or Close the Camera App	82
Viewfinder Screen	82
Take a Picture or Record a Video	83
Review Screen	84
Underwater Mode	85
Camera and Camcorder Settings	85
View Pictures and Videos Using Photos	86
Open or Close Photos	87
View Pictures and Videos	87
Zoom In or Out on a Picture	88
Work with Pictures	88
Picture Options Menu	88
Edit a Picture	88
Share Pictures and Videos	89
Send Pictures or Videos by Email/Gmail	89
Send Pictures or Videos by Message+	90
Send Pictures or Videos Using Bluetooth	90
Share Videos on YouTube	90
Tools and Calendar	92
Calendar	92
Add an Event to the Calendar	92

Invite Guests to Your Calendar Event	93
Calendar Event Alerts	94
View Calendar Events	95
Edit Calendar Events	96
Erase Calendar Events	96
Show or Hide Calendars	96
Synchronize Calendars with Your Phone	97
Clock	97
World Clock	97
Alarm	98
Timer	99
Stopwatch	100
Calculator	100
Flashlight	100
Sound Recorder	101
Voice Services	102
Text-to-Speech	102
Voice Search	102
Eco Mode	103
Bluetooth	104
Turn Bluetooth On or Off	104
The Bluetooth Settings Menu	104
Change the Phone Name	104
Connect a Bluetooth Headset or Car Kit	105
Reconnect a Headset or Car Kit	106
Disconnect or Unpair from a Bluetooth Device	106
Send and Receive Information Using Bluetooth	106
Supported Bluetooth Profiles	108
Near Field Communication (NFC) Technology	109
Turn NFC On or Off	109
Android Beam	109
microSD Card	110
Insert or Remove a microSD Card	110

View the microSD Card Memory	112
Format the microSD Card	112
Unmount the microSD Card	113
Use the Phone's microSD Card as a Media Device	113
File Commander	113
Supported Formats	114
Outdoor Report	114
Update Your Phone	115
Settings.....	116
Airplane Mode.....	116
Wi-Fi Settings	116
Bluetooth Settings.....	116
Mobile Hotspot.....	116
Data Usage Settings	116
Advanced Calling Settings	118
More Settings.....	118
NFC Settings	118
Android Beam.....	118
Tethering Settings.....	118
VPN Settings	118
Cellular Networks Settings.....	118
Emergency Alerts	120
Call Settings	121
Display Settings	121
Brightness level	121
Adaptive brightness	121
Wallpaper	121
Sleep	121
Daydream.....	122
Font Size	122
When Device is Rotated	122
Key Backlight.....	122
Cast.....	123

Display Battery Percentage	123
Display Quick Settings	123
Sound & notification Settings	123
Volumes	123
Also vibrate for calls.....	123
Do Not Disturb	124
Phone Ringtone.....	124
Vibration Pattern.....	124
Vibrate Intensity.....	125
Default Notification Ringtone	125
Other Sounds	125
Cast.....	125
Persistent Alerts	125
When Device is Locked	126
App Notifications.....	126
Notification Access	126
Do Not Disturb Access.....	126
Programmable Key	126
Application Manager	127
Storage Settings	127
Your Phone's Memory	127
SD Card.....	128
USB Drive.....	128
Battery Settings	128
Tap & Pay.....	129
Location Settings	129
Lock Screen Settings	130
Security Type.....	130
Fingerprint	132
Make Pattern Visible.....	132
Automatically Lock.....	132
Power Key Instantly Locks.....	133
Secure Start-up	133

Local Wipe.....	133
Smart Lock	133
Lock Screen Message	134
Lock Screen Wallpaper.....	134
Show Instructions	134
Security Settings.....	134
Encryption	134
Set Up SIM Card Lock	135
Make Passwords Visible	136
Device Administrators.....	136
Unknown Sources.....	136
Credential Storage.....	136
Advanced	137
Accounts Settings	137
Language & Input Settings.....	138
Language Settings.....	138
Spell Checker	138
Personal Dictionary.....	139
Current Keyboard	139
Google Keyboard Settings.....	139
Google Voice Typing Settings.....	141
Text-to-Speech Settings	141
Pointer Speed.....	141
Backup & Reset Settings	142
Backup and Restore	142
Network Settings Reset	142
Reset Settings	142
Factory Data Reset.....	143
Date & Time Settings	143
Accessibility Settings	143
Services.....	143
Vision.....	144
Display.....	145

Hearing.....	146
Mobility	146
Others.....	147
Printing	147
About Phone	147
System Updates	148
Cleaning and Drying Procedures	149
Precautions.....	149
Cleaning the Phone	150
Cleaning Your Phone.....	150
Alternate Cleaning Procedure	154
Drying Your Phone	155
Kyocera Tested Products.....	157
Mild Dish Detergents	157
Alcohol.....	157
Sanitizer Wipes.....	157
Notes	158
Copyright & Trademarks	159

Get Started

The following topics give you all the information you need to set up your phone and service the first time.

Your Phone at a Glance

The following illustration outlines your phone's primary external features and keys.



Key Functions

- **Proximity/Light sensor** detects how close an object is to the surface of the screen. This is typically used to detect when your face is pressed up against the screen, such as during a phone call.
- **Touchscreen** displays all the information needed to operate your phone. Use finger gestures to navigate and interact with items on the screen. In Underwater mode, the touch operation will be disabled.
- **Recent button** displays thumbnail images of apps you have recently accessed.
- **Speakers** let you hear different ringtones and sounds. The speakers also let you hear the caller's voice in speakerphone mode.
- **Back button** lets you return to the previous screen, or close a dialog box, options menu, the Notifications panel, or onscreen keyboard.
- **Home button** returns you to the Home screen. Press and hold to open the Google search app.
- **Earpiece** lets you hear the caller and automated prompts.
- **Front camera** takes pictures and records videos while facing the screen, and allows you to video conference.
- **LED indicator** displays a phone notification, charging status, or alert.
- **Secondary microphone** suppresses background noise improving audio quality for the other party during voice calls. In speakerphone mode, it is used as a main microphone.
- **Headset jack** allows you to plug in an optional headset for convenient, hands-free conversations or for listening to music.
- **Speaker button** lets you place or receive calls in speakerphone mode or turn the speakerphone on and off during a call.
- **Primary microphone** transmits your voice for phone calls and is used for voice-activated functions. It is disabled in speakerphone mode.
- **Charger/USB port** allows you to connect the phone and the micro-USB cable for use with the charger adapter, or other compatible accessories.

CAUTION! Inserting an accessory into the incorrect jack may damage the phone.

- **Volume button** allows you to adjust the ringtone or media volume when you are not on a call, or adjust the voice volume during a call.

- **PTT/Programmable button** allows you to assign a frequently used function for quick access. By installing PTT application, this key can also act as a PTT key. See [Programmable Key](#).
- **Power button** lets you turn the phone on or off or turn the screen on or off, restart the phone, switch your phone to Airplane mode, or capture screenshots.
- **SIM/microSD slots** (internal) allow you to insert a SIM card and a microSD card.

Note: microSD cards are sold separately.

- **Camera button** lets you activate the front camera, the back camera or the wide view camera.
- **Back camera** lets you take pictures and videos.
- **Flash** helps illuminate subjects in low-light environments when taking a picture or recording a video. It can also work as an LED flashlight. See [Flashlight](#).
- **Wide view camera** lets you take pictures and videos in widescreen.
- **Charging contacts** allow you to connect to a multi-bay battery charger that can charge multiple phones simultaneously.

Set Up Your Phone

You need to charge the battery to begin setting up your phone.

Charge the Battery

Fully charge the battery before powering on the phone.

Important: Unplug the AC adapter from the electrical outlet when not in use to reduce the environmental impact of charging.

1. Open the cover to the Charger/USB port on the bottom of the phone.
2. Plug the smaller end of the USB cable into the phone's Charger/USB port.
3. Plug the other end of the USB cable into the AC adapter, and then plug the adapter into an electrical outlet. Be sure to use the AC adapter that came with your phone.

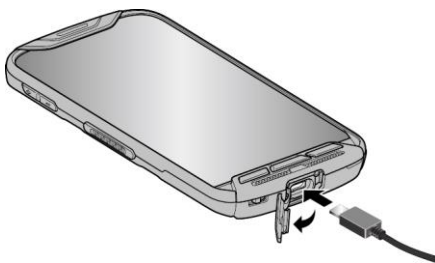

4. When charging is complete, remove the cable from the port and close the cover. Press around the edges of the cover to ensure that it is securely closed.

Warning: Be sure all ports and covers are properly sealed to maintain the phone's waterproof capability.



Your SIM Card

Your phone comes with a preinstalled SIM card. If you need to reinstall your SIM card, follow the instructions below.

1. Remove the back cover by inserting your fingernail in the slit on the bottom of your phone and pulling away from the phone.

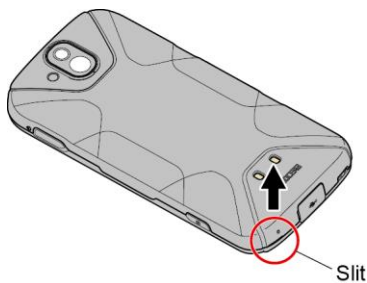

2. Open the SIM/microSD slot cover, as shown.



3. Push the SIM card gently with your finger. The card rejects itself. Pull out the original SIM card from the slot.

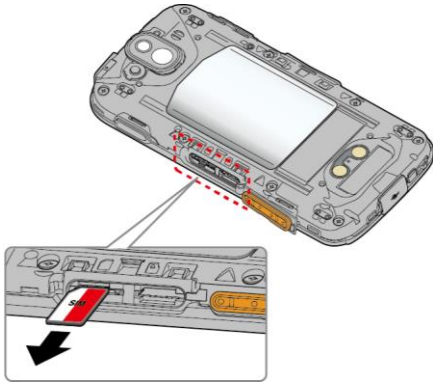

4. Carefully insert the new SIM card into the SIM card slot on the left, with the gold contacts facing down and the cut off corner on the top left.

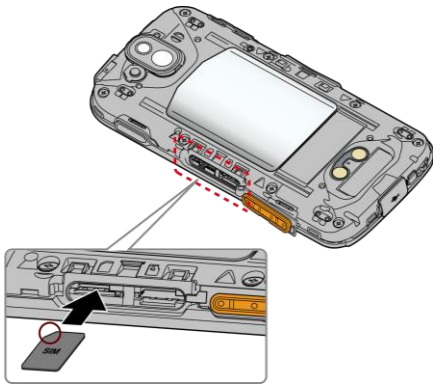

5. Securely close the SIM/microSD slot cover.

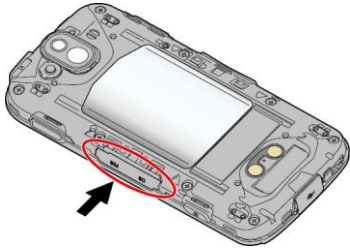

Warning: Be sure the SIM/microSD slot cover is properly sealed to maintain the phone's waterproof capability.

6. Replace the back cover. Press around the edges and center to ensure a proper fit.

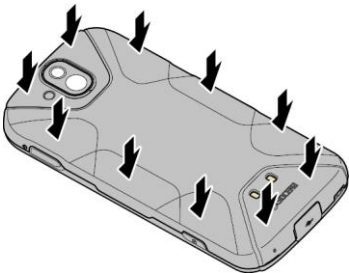

Warning: Be sure all ports and covers are properly sealed to maintain the phone's waterproof capability.

Charge the Battery Wirelessly

Your phone supports Qi and works with Qi-enabled chargers. Follow the steps below to charge the battery using a wireless charger (sold separately).

1. Locate the charging area on your wireless charger by referring to the charger documentation.
2. Place your phone in contact with the charger, ensuring that the charging area of your phone touches the charging area of your wireless charger.



Before starting wireless charging, please note the following:

- If the charging areas are not touching, the charging results will be poor.
- Make sure there is nothing between your phone and wireless charger.
- Your phone may become hot while charging the battery.
- If charging doesn't start after positioning your phone correctly, please use the AC adapter that came with your phone.

For more information on wireless charging, see your wireless charger documentation.

Turn Your Phone On and Off

The instructions below explain how to turn your phone on and off.

Turn Your Phone On

- ▶ Press and hold the **Power button** until the screen lights up.

Turn Your Phone Off

1. Press and hold the **Power button** until the phone options are displayed.
2. Tap **Power off** > **OK** to turn the phone off.

Restart Your Phone

1. Press and hold the **Power button** until the phone options are displayed.
2. Tap **Restart** > **OK** to restart the phone.

Hard Reset

- ▶ Press and hold the **Power button** for about ten seconds. The phone shuts down and automatically starts up.

Turn Your Screen On and Off

Your phone allows you to quickly turn the screen off when not in use and to turn it back on when you need it.

Turn the Screen Off When Not in Use

- ▶ To quickly turn the screen off, press the **Power button**. Pressing the **Power button** again or receiving an incoming call will turn on your phone screen.

To save battery power, the phone screen automatically turns off after a certain period of time when left idle. You will still be able to receive messages and calls while the phone screen is off.





Note: For information on how to adjust the time before the screen turns off, see [Sleep](#).

Turn the Screen On and Start with Swipe

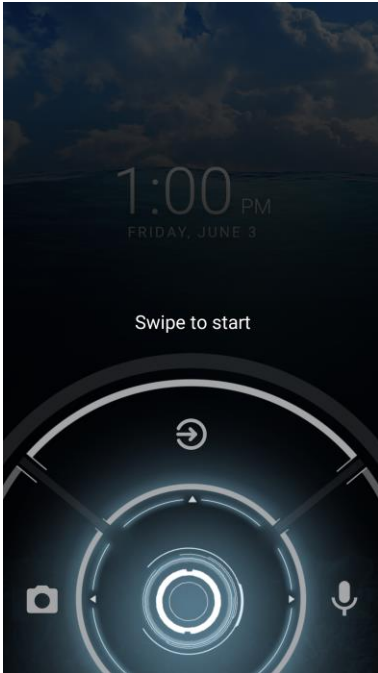
1. To turn the screen on, press the **Power button**. The below screen appears by default.

Note: To set up a screen lock for security, see [Lock Screen Settings](#).



2. On the screen, swipe  toward:
 -  to access the Home screen or the screen displayed before it was turned off.
 -  to launch the Camera app.
 -  to launch the voice search function.

Setup Wizard

Your phone has a Setup Wizard to set up your phone quickly and easily. When you turn on your phone for the first time, the Setup Wizard starts automatically.

The Setup Wizard consists of the following sections:

- Language Selection
- Phone Activation
- Set Up Wi-Fi
- Protect your phone
- Google services
- Email accounts

Follow the onscreen instructions to quickly set up your phone.

Language Selection

- ▶ Select your language from **English, Español, 简体中文, 繁體中文, 한국어** or **Tiếng Việt** and tap **NEXT**.

Phone Activation

Confirmation screen appears if you have not inserted your SIM card yet or it may be inserted incorrectly. Follow the instructions onscreen.

Set Up Wi-Fi

Select a network if you want to connect to Wi-Fi. Follow the instructions onscreen.

Protect your phone

Choose the device protection features from the list. Follow the instructions onscreen.

Google services

Instruction screen about Google appears. Follow the instructions onscreen.

Email accounts

Choose the type of email accounts you want to set up and configure them. Follow the instructions onscreen.

Set Up Voice Mail

Your phone comes with the Voice Mail application. Voice Mail allows you to manage your Voice Mail directly from your phone rather than calling in to your Voice Mail. Voice Mail displays a list of your messages and allows you to choose which message(s) to listen or delete. You can also choose the traditional Voice Mail service. See [Voice Mail \(Traditional\)](#).

Note: Voice Mail is a subscription based service.

Set Up Voice Mail

1. From the Home screen, tap **Apps**  > **Voice Mail**.
2. Read the message and tap **Continue**.
3. Terms & Conditions may appear. Read it and tap **Accept**, if you agree to it.
4. Tap **Continue** and follow the onscreen instructions for setting language, password, greetings, etc.

Set Up Traditional Voice Mail

1. From the Home screen, tap **Apps**  > **Phone** > **DIALPAD**.

2. Touch and hold **1** or dial ***86** and then tap .
3. When you hear the greeting, tap **#** to interrupt, and follow the prompts.

Phone Basics

Your phone is packed with features that simplify your life and expand your ability to stay connected to the people and information that are important to you. The following topics will introduce the basic functions and features of your phone.

Touchscreen Navigation

Your phone's touchscreen lets you control actions through a variety of tap gestures.

Tap

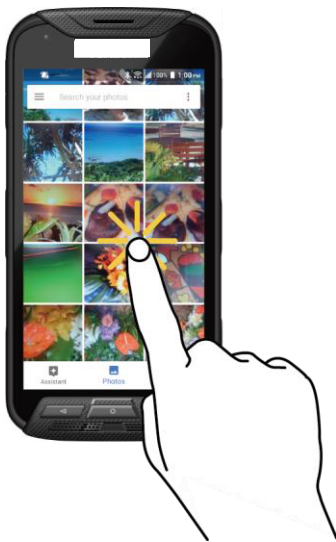

Tap the screen with your finger to select or launch a menu, option, or application. A light tap works best.

Touch and Hold

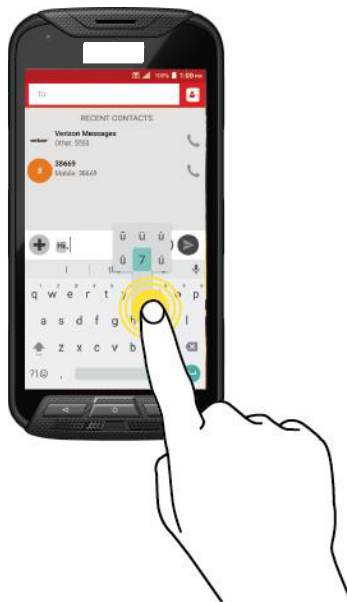

To open the available options for an item (for example, a keyboard), touch and hold the item.

Drag



Touch and hold your finger before you start to move it. Do not release your finger until you have reached the target position.

Swipe or Slide

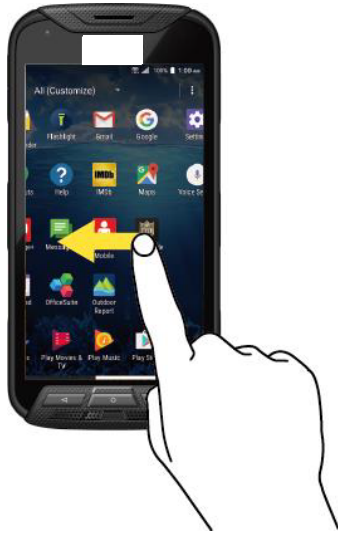

To swipe or slide means to quickly drag your finger vertically or horizontally across the screen.

Flick

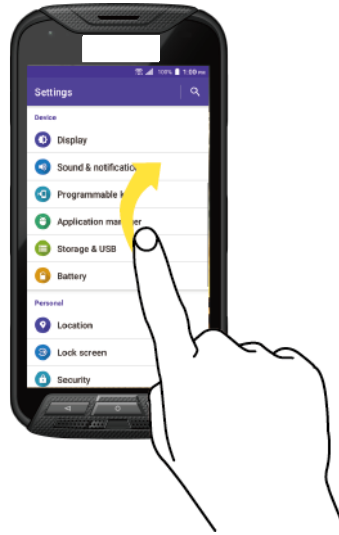

Flicking the screen is similar to swiping, except that you need to swipe your finger in light, quick strokes.

Pinch and Spread



Pinch the screen using your thumb and forefinger to zoom out, or spread the screen to zoom in when viewing a picture or a Web page. (Move fingers inward to zoom out and outward to zoom in.)

Rotate

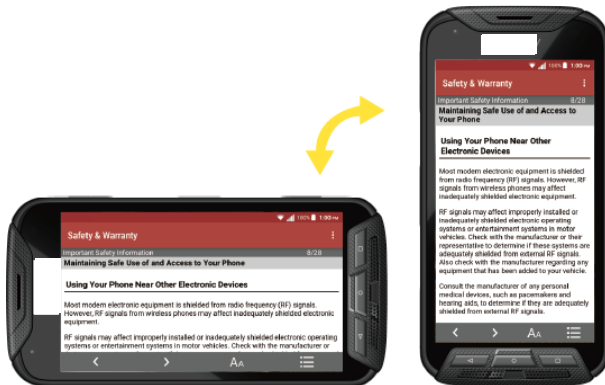

For most screens, you can automatically change the screen orientation from portrait to landscape by turning the phone sideways. When entering text, you can turn the phone sideways to bring up a bigger keyboard. See [Touchscreen Keyboards](#).

Note: **Rotate the contents of the screen** needs to be selected for the screen orientation to automatically change. From the Home screen, tap **Apps**  **> Settings > Display > When device is rotated.**

Function Buttons

Just below the touchscreen, you will find a row of three buttons that let you perform specific functions.



- **Back button** (◀) - Tap to return to the previous screen, or close a dialog box, options menu, the Notifications panel, or onscreen keyboard.
- **Home button** (○) - Tap to open the Home screen.
- **Recent button** (□) - Tap to open a list of thumbnail images of screens you have worked with recently. To open one, tap it. To remove a screen from the list, swipe it left or right or tap on the X.

Your Home Screen

The Home screen is the starting point for your phone's applications, functions, and menus. You can customize your Home screen by adding application icons, shortcuts, folders, widgets, wallpapers and more.

Home Screen Overview

The following illustration describes the basics of the Home screen.



- **Status Bar:** Displays the time, notification icons, and phone status icons. Slide down to display the Notifications panel. See [Status Bar](#).
- **Widget:** Allows users to access various useful programs.
- **Google Search Widget:** Allows you to enter text or spoken keywords for a quick search on the phone or on the Internet. Tap to enter text or tap  to speak your keyword.
- **Folder:** Allows you to organize screen items. You can store multiple application icons as a group. See [Use Folders](#).
- **Screen Position Indicator:** Indicates where you are among the Home screens. Tap an icon to select a Home screen.
- **Favorites Tray:** Contains up to five icons and appears on every Home screen. You can customize these icons except the Apps icon in the center of the tray.
- **Apps:** Displays all of your apps.
- **Shortcut:** Allows you to quickly launch applications.

Tip: Press Home button to return to the main Home screen from any other screen.

Tip: You can access the icon glossary tutorials by tapping **Apps**  > **Help**.

Extended Home Screens

The Home screen extends beyond the initial screen. In addition to the main Home screen, your phone can have up to ten extended Home screens to provide more space for adding icons and widgets.

- ▶ On the Home screen, swipe across the screen to move from the main Home screen to an extended Home screen.

– or –

On the screen position indicator, tap Home button to access the main Home screen, or tap  to access each extended Home screen.

Manage the Home Screens

Learn how to customize the Home screens.

Add or Reduce the Home Screens

You can have between three to eleven Home screens.

1. Touch and hold any empty area on the Home screen to display the Home screen thumbnails.
2. The following options are available:
 - Tap a thumbnail to access the Home screen.
 - Tap  to add a new Home screen.
 - Touch and hold a thumbnail and drag it to rearrange the positions of the Home screens. Release the thumbnail where you want to place it.
 - Touch and hold a thumbnail, drag it to "**REMOVE**" and release it when it turns red to remove the Home screen.
 - Tap the Home icon at the top of each screen to set that screen as the main Home screen.

Add App Shortcuts or Widgets to the Home Screen

1. Touch and hold any empty area on the Home screen.
2. Tap **APPS** or **WIDGETS**.
3. Slide the screen to find the item you want to add to the Home screen.
4. Touch and hold the item and move your finger to one of the Home screen thumbnails displayed at the top of the screen.

5. When you find the position to place the item, release your finger.

Tip: You can also select a Home screen thumbnail where you want to place the item and then simply tap the item.

Move or Remove Items on the Home Screen

- ▶ Touch and hold the item you want to move or remove from the Home screen.
 - To move the item, drag it to a new area and release it.
 - To remove the item, drag it to "**REMOVE**" at the top of the screen and release it.

Favorites Tray

The favorites tray takes up to five icons and appears on every Home screen. You can replace those icons except the Apps icon in the center of the tray.

To add a new icon to the favorites tray:

1. Remove the current icon on the tray. See [Move or Remove Items on the Home Screen](#).
2. Touch and hold an app icon and drag it to the favorites tray.
3. Release your finger.

Use Folders

You can place up to 16 app icons in a folder. Drop an app icon over another on the Home screen, and the two icons will be placed in a new folder.

To create a folder:

1. Touch and hold an app icon and drag it over another on the Home screen.
2. Release your finger. Both icons are in a newly created folder.
3. Tap the folder > **Unnamed Folder**. The keyboard opens and you can name the folder. To rename it, tap the name.

To add app icons to a folder:

- ▶ Touch and hold an app icon, drag it over a folder and release your finger.

– or –

1. Tap a folder on the Home screen.
2. Tap **+** and select the icons you want to add to the folder.
3. Tap **OK**.

Change the Wallpaper

1. Touch and hold any empty area on the Home screen and then tap **WALLPAPERS**.

– or –

From the Home screen, tap **Apps**  > **Settings** > **Display** > **Wallpaper**.

2. Tap **Pick image** to use your own image, or browse through the preset choices.
3. Tap **SET WALLPAPER** or **Set Wallpaper**.



Weather

Your Weather widget can display a large quantity of weather information.



Retrieve the Current Location Information

1. Tap **Tap to start** on the widget.
2. Read the message and tap **OK** to enable data connection.
3. Your phone will display the weather forecast for your current location.

Add a Location

1. Tap the weather image on the widget and then tap  > .
2. Enter a location in the Search location field and tap . The matching location(s) will be listed.
3. Tap the location you want to add to the location list.
4. Tap the added location to access the details screen.

Delete a Location

1. Tap the weather image on the widget and then tap  > .
2. Select the check box next to the location you want to delete.
 - Tap **SELECT ALL** to select all the locations.
3. Tap **DONE**.

Configure the Settings

1. Tap the weather image on the widget and then tap .
2. The following options are available:

- **Temperature scale:** Select Fahrenheit or Celsius.
- **Refresh time:** Select the frequency of auto update.
- **When launching:** Update the weather information when the application is opened.
- **When the current location changes:** Update the weather information when your current location changes. Data usage may increase when this is on.



Dura Grid

The Dura Grid widget offers popular settings and apps uniquely designed with high contrast, large icons for easy access with gloved hands or while on the move. The Dura Grid widget can also be customized with most frequently used apps and settings and is available in a three, six or nine-position layout.

Access the Six-position Dura Grid Widget

1. From the main Home screen, swipe to the right.
2. Tap on individual icons to turn them on or to adjust settings.

Change an Icon on the Dura Grid Widget

1. Tap  **EDIT** on Dura Grid.  appears in the right hand corner of each of the icons.
2. Tap the setting or feature to be changed. The icon disappears.
3. Tap **Add** and tap on an icon from the **SETTINGS** or **APPS** tabs.
4. Tap  **DONE**.





Add a Three or Nine-position Dura Grid Widget to the Home Screen

1. Touch and hold any empty area on the Home screen.
2. Tap **WIDGETS** and slide the Widgets screen to find the three or nine-position Dura Grid widget.
3. Touch and hold the Dura Grid widget and move your finger to one of the Home screen thumbnails displayed at the top of the screen.
4. When you find the position you prefer, release your finger.



Launcher Screens

You can access all your apps on your phone from the launcher screens. You can also customize the view of your launcher screens.

Access the Launcher Screens

1. From the Home screen, tap **Apps** .
2. Following options are available:
 - Tap  > **All (Customize)** to customize the order of apps. See [Rearrange Your Apps on the Launcher Screens](#) to follow.
 - Tap  > **All (Alphabetical)** to reset the order of apps in alphabetical order.
 - Tap  > **Frequently used** to display the apps you have used most frequently.
 - Tap  > **Downloads** to display the apps downloaded on your phone.

Rearrange Your Apps on the Launcher Screens

1. From the Home screen, tap **Apps**  >  > **Edit**.
2. Touch and hold an app, drag it to a new position and release it. To move it to another screen, drag the app to another screen and release it on the screen you want to place it.
3. Tap **OK**.

Status Bar

The status bar at the top of the screen provides phone and service status information on the right side and notification alerts on the left.

To see the descriptions of the icons displayed on the status bar:

- ▶ From the Home screen, tap **Apps**  > **Help** > **Icon glossary**.

Notifications Panel

You can open the Notifications panel to view the list of notifications you received, Wi-Fi connection status, and more.

To open the Notifications panel:

- ▶ Slide the status bar down to the bottom of the touchscreen.

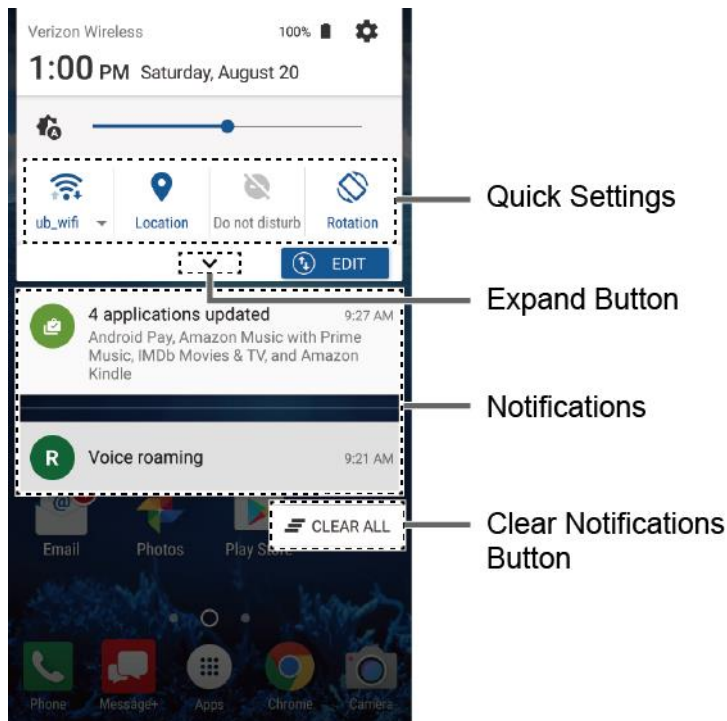

- When you are finished with a notification, swipe it away to the left or right.
- To clear all notifications, tap  **CLEAR ALL** at the very bottom of the notifications list.

Tip: You can control what notifications show on your screen when your phone is locked.

- To open the main Settings app, tap the settings icon . For details, see [Settings](#).

To close the Notifications panel:

- ▶ Swipe up from the bottom of the screen.
- or –
- Tap **Back** .

Quick Settings

The quick settings screen enables you to quickly access useful menu items. Tap  to expand the Quick Settings panel.

Note: You can only add up to 8 entries in Quick Settings panel.

1. Slide the status bar down to the bottom of the touchscreen.
2. Tap on a quick setting panel icon to enable or disable the feature:
 - **Wi-Fi** to enable or disable the Wi-Fi function.

- **Location** to enable or disable the location feature.
 - **Do not disturb** to change the sound and notification settings. You can switch between **Vibrate**, **Alarms only**, **Total silence**, or **Priority only**.
 - **Rotation** to enable or disable the auto-rotate screen feature.
 - **Eco Mode** to enable or disable the Eco Mode feature.
 - **Hotspot** to turn Hotspot feature on or off.
 - **Airplane** to enable or disable the Airplane Mode.
 - **Bluetooth** to enable or disable the Bluetooth function.
 - **NFC** to enable or disable the NFC feature.
 - **Flashlight** to turn the flashlight on or off.
- To change the positions of items, tap  **EDIT**. Touch and hold the item you want to move, and then drag it to a different location and release your finger. Tap **OK**.
 - To adjust the screen brightness, tap and drag the little knob on the brightness slider left or right.

Enter Text

You can type on your phone using one of the available touchscreen keyboards or using your voice.

Touchscreen Keyboards

The keyboard appears automatically onscreen when you tap a text entry field, and they can be used in either portrait or landscape mode.

Google Keyboard

Google Keyboard offers a traditional QWERTY keyboard setup for entering text by tapping keys (like on a computer), along with enhancements and options that allow you to enter text faster and more accurately, such as continuous key input, personalized usage dictionaries, and more.

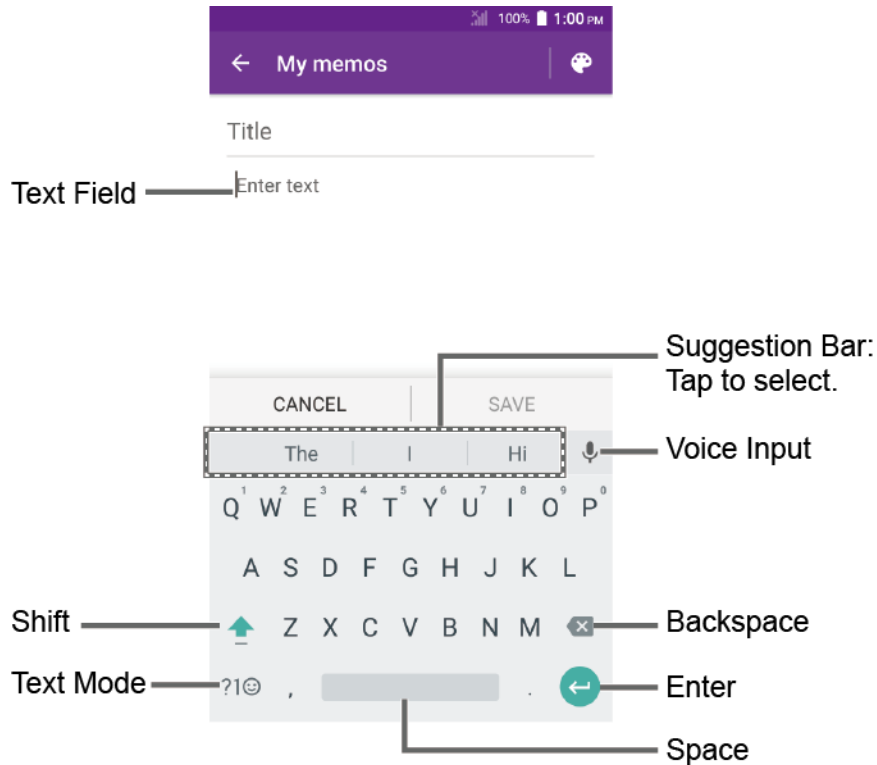

Google Keyboard Overview



Note: Key appearance may vary depending on the selected application or text field.





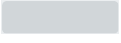



Some of the keys on the Google Keyboard are given below:

Key	Description
	Shift: Tap to toggle between lower case and upper case.
	Caps lock: Double-tap the lower case or upper case shift key.
	Text mode: Tap to toggle between the Alphabet keyboard and Number & Symbol keyboard.
	Voice input mode: Tap to enter text using your voice.
	Backspace: Tap to delete a character. Touch and hold to delete multiple characters.
	Enter: Tap to confirm your entry or move to a new line.
	Next: Tap to go to the next text entry field.

Key	Description
	Alternate: Tap to toggle between the default Number & Symbol keyboard and additional Number & Symbol keyboard.
	Go: Tap to go to a Web address.
	Space: Tap to insert a space. Touch and hold to select the input method.



Text Mode



ABC mode is primarily used for entering letters while Number & Symbol mode for numbers and symbols.

- ▶ Tap  to select ABC mode. Tap  to select Number & Symbol mode.
 - In ABC mode, tap  to alter the capitalization:
 -  (Unshifted) to enter all letters in lowercase.
 -  (One-character-shifted) to capitalize only the first letter of a word.
 - You can select the caps lock by double-tapping or  or  to make all letters in uppercase.
 -  (Caps lock) to enter all letters in uppercase.
 - In Number & Symbol mode, tap  to display more symbols.
 - Some keys have alternate characters. In either mode, if a key displays an extra character at the upper right corner, touch and hold the key to enter the character. Or, touch and long hold a key to call up a list of all the characters available on that key, and slide your finger to the character you want to enter on the list.

Add a Word to the User Dictionary

You can use the user dictionary option to add new words to the dictionary.

1. From the Home screen, tap **Apps**  > **Settings** > **Language & input** > **Personal dictionary**.
2. Select a language.
3. Tap .

4. Type the word you want to add.
5. Type the shortcut to bring up the typed word if you want, and tap .
6. Press . A list of words you have added to the dictionary is displayed.
 - Tap a word to edit it.
 - Tap a word >  to delete it.

For more information about the Google Keyboard settings, see [Google Keyboard Settings](#).

Gesture Typing

The gesture typing lets you enter words by drawing a path from letter to letter in one continuous motion.



Example: dog
Place your finger on the key with the first letter of the word and glide to the following letters. Lift your finger after the last letter.



Example: cool
For double letters, circle the letter.

To enable the Gesture Typing input feature:

1. From the Home screen, tap **Apps**  > **Settings** > **Language & input**.
2. Tap **Google Keyboard** > **Gesture Typing**.
3. Tap **Enable gesture typing** to on.

Google Voice Typing

Google voice typing uses Google voice recognition to convert speech to text.

If the Google Keyboard does not display the microphone icon , the voice input feature is not enabled.

To enable the voice input feature:

1. From the Home screen, tap **Apps**  > **Settings** > **Language & input**.
2. Tap **Current Keyboard** > **CHOOSE KEYBOARDS**.
3. Tap **Google voice typing** to on.

To enter text by speaking:

1. Tap the microphone icon  on the keyboard.
2. If you see **Speak now**, say the text you wish to enter into the microphone. If you see **Tap to pause**, Google Voice Typing recognizes your voice.
3. Confirm the text you wish to enter is displayed. Tap the microphone icon again to continue entering.

For more information about the settings of Google voice typing, see [Google Voice Typing Settings](#).

Copy and Paste Text

In applications that require text entry, such as Message+, use the copy and paste functions to copy and paste text from one application to another.

To copy and paste the text:

1. Open the application or received message that you want to copy text from.
2. Touch and hold the text body. Selection tabs appear and the currently selected words or characters are highlighted. Drag the tabs to expand or reduce the range of the selected text.

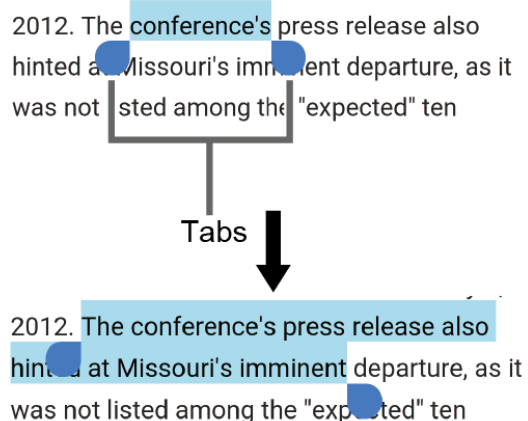

Tip: Tap **SELECT ALL** to select all the text.

3. Tap **COPY**.
4. Open the application into which you want to paste the text.

5. Touch and hold the text box where you want to paste the text to, and tap **PASTE**.
 - If you want to add the selected text to the current text, place a cursor to the position where you want to insert the selected words or characters. Touch and hold the text box, and tap **PASTE**.

Phone Calls

With the _____ network and your phone's calling features, you can enjoy clear phone calls across the country.

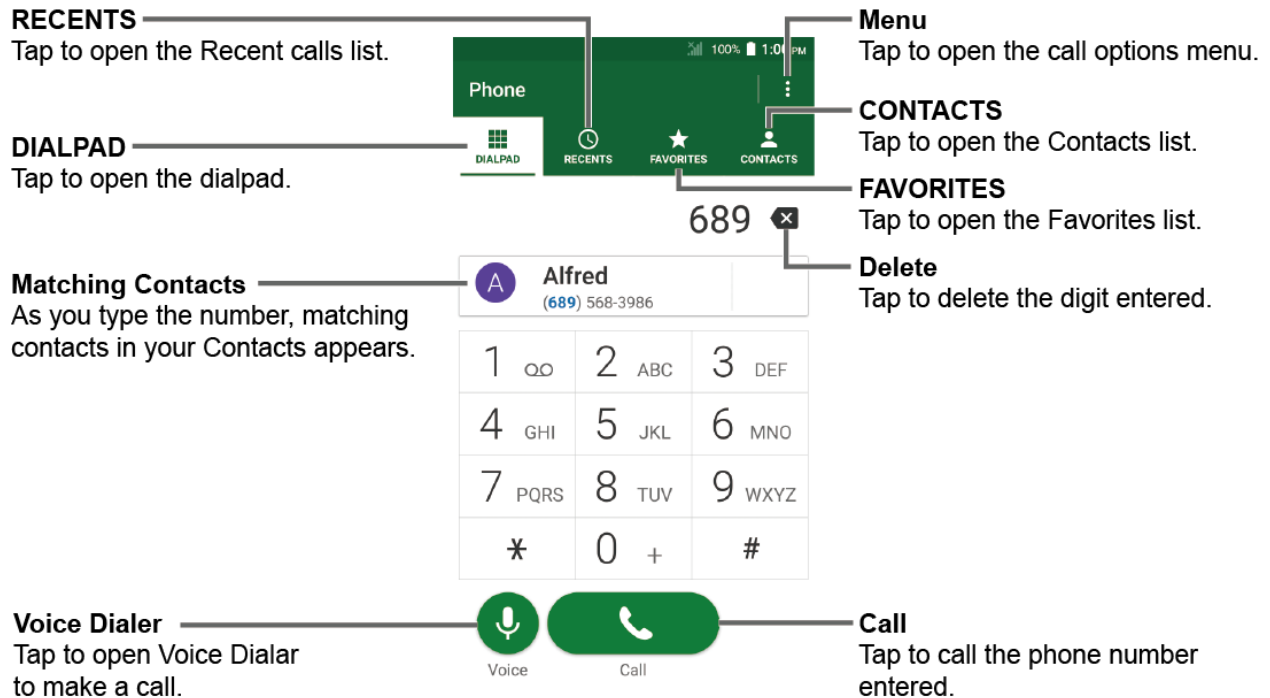

Make Phone Calls

There are several convenient ways to place calls from your phone.



Call Using the Phone Dialpad

The most "traditional" way to place a call is by using the phone dialpad.

1. From the Home screen, tap **Phone** > **DIALPAD** to display the dialpad.
2. Tap the number keys on the dialpad to enter the phone number.
3. Tap  to call the number.
4. To end the call, tap .
 - For additional options, tap  and select an option.



Call from Recents

The Recent calls list lets you quickly place calls to recent incoming, outgoing, or missed numbers.

1. From the Home screen, tap **Phone** > **RECENTS** to display the recent calls list.
2. Tap the phone icon  next to the number or contact to place a call.
 - For additional options, tap the name or number.

Call from Contacts

You can place phone calls directly from entries in your contacts list.

1. From the Home screen, tap **Phone**.
2. Tap **CONTACTS** to display your contacts list.
 - Tap  to search your contacts.
3. Tap the contact you want to call.
4. Tap .
 - For additional information on Contacts, see [Contacts](#).

Call Using a Speed Dial Number

Speed dialing lets you numbers that you call frequently more easily. See [Set Up Speed Dialing](#) for information on assigning speed dial numbers.

1. From the Home screen, tap **Phone** > **DIALPAD**.
2. For speed dial numbers 2-9, touch and hold the number on the dialpad.
– or –

For speed dial numbers 10-99, tap the first digit and then touch and hold the second digit on the dialpad.

Call Emergency Numbers

You can place calls to 911 even if the phone screen is locked or your account is restricted.

To call the 911 emergency number:

1. From the Home screen, tap **Phone** > **DIALPAD**.
2. Enter **911** and tap .

To call the 911 emergency number when the screen is locked:

1. Tap **EMERGENCY CALL** on the screen.
2. Enter **911** and tap .

Enhanced 911 (E911) Information

This phone features an embedded Global Positioning System (GPS) chip necessary for utilizing E911 emergency location services where available.

When you place an emergency 911 call, the GPS feature of your phone seeks information to calculate your approximate location. Depending on several variables, including availability and access to satellite signals, it may take up to 30 seconds or more to determine and report your approximate location.



Important: Always report your location to the 911 operator when placing an emergency call. Some designated emergency call takers, known as Public Safety Answering Points (PSAPs), may not be equipped to receive GPS location information from your phone.

Call Numbers with Pauses

You can dial phone numbers with pauses for use with automated systems, such as Voice Mail or credit card billing numbers.

There are two types of pauses available on your phone:

- **Add 2-sec pause:** Automatically sends the next set of numbers after two seconds.
- **Add wait:** Sends the next set of numbers when you tap **YES** in the pop-up window.

1. From the Home screen, tap **Phone > DIALPAD**.
2. Enter all or part of a number.
3. Tap  > **Add 2-sec pause** or **Add wait**.
4. Enter additional numbers.
5. Tap  to dial the number.

Call Using the Plus (+) Code

When placing international calls, Plus Code Dialing automatically enters the international access code for your location (for example, 011 for international calls made from the U.S.).

1. From the Home screen, tap **Phone > DIALPAD**.
2. Touch and hold **0** until you see a "+" on the display screen.

3. Enter the country code and phone number, and then tap . The phone automatically prepends the access code for international dialing, followed by the country code and phone number.

Receive Phone Calls

The following information lets you know how to answer incoming calls, mute the ringtone on incoming calls, reject incoming calls, and more.

When you receive a phone call from a contact, the Incoming call screen appears and displays the caller ID icon, name, and phone number of the calling party. When you receive a phone call from someone who is not stored in Contacts, only the default caller ID icon and phone number appear on the Incoming call screen.

Note: If your phone is turned off, all calls automatically go to Voice Mail.

Answer an Incoming Call

- ▶ On the Incoming call screen, swipe .

Mute the Ringing Sound

To mute the ringtone without rejecting the call:

- ▶ Press the volume button down.

Send an Incoming Call to Voice Mail

- ▶ Swipe  to send the call to your Voice Mail inbox.

Reject a Call and Send a Text Message

You can reject an incoming call and automatically send a text message to the caller.

- ▶ Swipe  to ignore the call and send a message to the caller.

Note: You can edit the preset text messages through the Call settings menu. See [Quick Responses](#).





Voice Mail

Your phone comes with the Voice Mail application. Voice Mail allows you to manage your Voice Mail directly from your phone rather than calling to your Voice Mail box. Voice Mail displays a list of your messages and allows you to choose which message(s) to listen to or delete. Or you can choose the traditional Voice Mail service.

You must subscribe to Voice Mail before using this feature. As a subscription based service, there is a charge for using Voice Mail. See [Set Up Voice Mail](#) on page 9 for setting it up.

Review Voice Mail

Voice Mail lets you easily access and select which messages you want to review.



1. From the Home screen, tap **Apps**  > **Voice Mail**.
2. From the Voice Mail inbox, tap a message. The following options may be available while reviewing a Voice Mail message:
 - Tap **Play** to start playing.
 - Tap **Stop** to stop playing.
 - The bar  provides a visual timeline for the current message. Drag the bar to rewind or fast-forward the message.
 - Tap **Pause** to pause the playback. Tap **Play** to resume.
 - Tap **Speaker** to turn the speakerphone on or off during playback.
 - Tap **Delete** to delete the current Voice Mail message.
 - Tap **Call Back** to call the number from which the message came.
 - Tap **Save** to move the message to the saved Voice Mail folder. Tap  > **View Saved Voice Mail on the Inbox** screen to view the saved messages.
 - Tap **Add Note** to add a note to the message.
 - Tap **View Note** to display the attached note.
 - Tap  to display the option menu.
 - **Reply** to reply to the message via text or voice message. This feature is a part of the Premium Voice Mail service.
 - **Forward** to forward the message. This feature is a part of the Premium Voice Mail service.
 - **Mark as Heard** to mark the message as heard.
 - **Add to Contacts** to store the sender information to Contacts.
 - **Contacts details** to display the sender information saved in Contacts.

You may see more options such as **Play All Unheard Message**, **Sort By**, **View Saved Voice Mail** and **Settings** by tapping  on the inbox screen.

Compose and Send a Voice Message

Record a voice message and send it as an attachment.

Note: This feature is a part of the Premium Voice Mail service.



1. From the Home screen, tap **Apps**  > **Voice Mail** >  > **Compose**.
2. Tap **Record** to start recording.
3. Tap **Stop** to stop recording.
4. Tap **Play** to review the recorded message.

Press  > **Discard** to discard the current message.

5. Tap **Text Message** or **Email** and send the voice message as an attachment.

Configure Voice Mail Settings

You can access the settings for notifications and greetings as well as the store location of the messages.

1. From the Home screen, tap **Apps**  > **Voice Mail** >  > **Settings**.
2. Select an option:
 - **Notifications** to display the notification when you receive Voice Mail messages.
 - **Choose ringtone** to select a ringtone to play when you receive Voice Mail messages.
 - **Vibrate** to select the vibration behavior when you receive Voice Mail messages.
 - **Set Voice Mail Greeting** to create a greeting to answer the Voice Mail messages.
 - **Set Caller Dependent Greetings** to create personalized greetings for each caller. This feature is a part of the Premium Voice Mail service.
 - **Saved Voice Mail Location** to view the location where the Voice Mail messages are stored.
 - **Storage for Saved Voice Mail** to select where to store the Voice Mail messages.

Voice Mail (Traditional)

In addition to [Voice Mail](#), you can also access your Voice Mail regularly through the Voice Mail application.

Set Up Voice Mail

You should set up your Voice Mail and personal greeting as soon as your phone is activated. Always use a password to protect against unauthorized access. Your phone automatically transfers all unanswered calls to your Voice Mail, even if your phone is in use or turned off. See [Set Up Voice Mail](#) for setting it up.

Voice Mail Notification

There are several different ways your phone may alert you to a new Voice Mail message.

- By sounding the assigned notification sound.
- By vibrating the phone.
- By displaying  within the Notifications area of the Status bar when new Voice Mail Messages are received.

Retrieve Your Voice Mail Messages

You can review your messages directly from your wireless phone (using either traditional Voice Mail or Voice Mail) or from any other touch-tone phone.

Use Your Phone to Access Your Messages

1. From the Home screen, tap **Phone > DIALPAD**.
2. Touch and hold **1** or dial ***86** and then tap . If prompted, enter your Voice Mail password.
3. If you hear a greeting, tap **#** to interrupt, and follow the prompts.

Use Another Phone to Access Messages

1. Dial your wireless phone number.
2. If you hear a greeting, press **#** to interrupt, and follow the prompts.

Phone Call Options

Your phone application provides many useful features and options to help you make the most of your calling experience.

In-call Options

While you're on a call, you will see a number of onscreen options. Tap an option to select it.

- **Add call:** Tap to initiate a 3-way call.
- **End:** End the current call.
- **Dialpad/Hide:** Toggle the appearance of the onscreen dialpad to enter additional numbers such as an extension or access code.
 - For example: When you call your bank's toll-free number, use your dialpad to enter your account number and PIN.
- **Mute:** Mute or unmute the microphone during an active call.

- **Speaker:** Turn the speaker on or off.

Warning: Because of higher volume levels, do not place the phone near your ear during speakerphone use.

- **Bluetooth:** Route the phone's audio through a connected Bluetooth headset or through the speaker.
- **Camera:** Tap to initiate camera and your device starts to make video calls.
- **One-way:** Tap to switch the function between 1-way or 2-way during video calls.

Caller Name ID

Caller Name ID identifies a caller before you answer the phone by displaying the number of the incoming call. If you do not want your number displayed when you make a call, follow these steps.

1. From the Home screen, tap **Phone > DIALPAD**.
2. Enter ***67**.
3. Enter a phone number.
4. Tap .

Call Waiting

When you're on a call, Call Waiting alerts you to incoming calls by sounding beeps. Your phone screen informs you that another call is coming in and displays the caller's phone number (if available).

To respond to an incoming call while you're on a call:

- ▶ Swipe . This puts the first caller on hold and answers the second call.

To switch back to the first caller:

- ▶ Tap **Swap call**.

Note: For those calls where you don't want to be interrupted, you can temporarily disable Call Waiting by entering ***70** before placing your call. Call Waiting is automatically reactivated once you end the call.

3-Way Calling

With 3-way calling, you can talk to two people at the same time. When using this feature, the normal airtime rates will be charged for each of the two calls.

1. Enter a number on the dialpad and tap  (or place a call from recent calls or contacts).

2. Once you have established the connection, tap **Add call**, and dial the second number (or place the call from Recents or Contacts). This puts the first caller on hold and dials the second number.
3. When you're connected to the second party, tap **Merge calls**. Your conference call is now in session.
4. To end the 3-way call, tap .

Note: If one of the parties you called hangs up during your call, you and the remaining party stay connected. If you initiated the call and are the first to hang up, all parties are disconnected.

Call Forwarding

Call Forwarding lets you forward all your incoming calls to another phone number – even when your phone is turned off. You can continue to make calls from your phone when you have activated Call Forwarding.

Note: You may be charged a higher rate for calls you have forwarded.

To activate Call Forwarding:

1. From the Home screen, tap **Phone > DIALPAD**.
2. Enter ***72**.
3. Enter the area code and phone number to which you want your calls forwarded.
4. Tap . You will see the message if the call forwarding is activated.
5. Confirm the message and tap **Forward Calls** to forward your call or tap **Cancel** to cancel forwarding.

To deactivate Call Forwarding:

1. From the Home screen, tap **Phone > DIALPAD**.
2. Enter ***73**.
3. Tap .

Set Up Speed Dialing

You can store up to 98 numbers in your phone's speed dial memory.

To assign a speed dial number to a contact:

1. From the Home screen, tap **Phone > DIALPAD >  > Speed dial setup**.

2. Tap **Add speed dial** next to the location number you want to assign a number to.
3. Select a contact. If the contact has more than one number, select a number.

To remove a number from a speed dial location:

1. From the Home screen, tap **Phone > DIALPAD >  > Speed dial setup.**
2. Tap the assigned contact you want to remove and tap **Remove > OK.**

To replace a number in a speed dial location:

1. From the Home screen, tap **Phone > DIALPAD >  > Speed dial setup.**
2. Tap the assigned contact you want to replace and tap **Replace.**
3. Select a contact. If the contact has more than one number, select a number.

Recent Calls

The Recents tab of the Phone application lists up to 500 recent incoming, outgoing, and missed calls.

View Recent Calls





- ▶ From the Home screen, tap **Phone > RECENTS.**
 - You can determine if an entry was an incoming, outgoing, or a missed call from the icons shown below.

 = Incoming Call

 = Outgoing Call

 = Missed Call

Recent Calls Options

1. From the Home screen, tap **Phone > RECENTS.**
2. Tap an entry to view the contact.
 - Tap  to call the number.
 - Tap  to send a text message.
 - Tap  to add the number to Contacts.
 - Tap  > **Delete from recent call** to delete the call.

- Tap  > **Edit number before call** to edit the number before calling.

Filter Recent Calls

1. From the Home screen, tap **Phone > RECENTS**.
2. Tap  > **Filter by**.
3. Select **All calls**, **Missed calls**, **Outgoing calls**, **Incoming calls**, **Voice calls**, or **Video calls**.

Clear Recent Calls

Use the menu option to clear your recent calls.

1. From the Home screen, tap **Phone > RECENTS**.
2. Tap  > **Delete recent calls**.
3. Tap the check box next to the calls you want to delete or tap **SELECT ALL**.
4. Tap **OK > OK**.



Call Settings

Your phone's Call settings menu lets you configure your settings for the phone application.

Assisted Dialing

Assisted dialing allows easy dialing of international calls while roaming in another countries.

Your default reference country is set to the United States.

1. From the Home screen, tap **Phone >  > Call settings > Assisted dialing**.
2. Tap **Assisted dialing** to turn on.
3. Tap **Reference country**.
4. To modify the settings, tap  to the right of the country name and edit the settings.



When placing international calls from outside the United States or Canada, set the Assisted dialing as follows.

1. From the Home screen, tap **Phone >  > Call settings > Assisted dialing**.
2. Tap **Assisted dialing** to turn on.
3. Tap **Current country**.



4. To modify the settings, tap  and edit the settings.

Call Rejection

You can set your phone to reject incoming calls.

1. From the Home screen, tap **Phone** >  > **Call settings** > **Call rejection**.
2. Tap **Call rejection** to turn on.
3. Tap **Rejection list** and specify the numbers you want to reject. Following options are available:
 - Tap **Unknown number** to turn on.
 - Tap , select **Contacts** or **Recent calls**, and select a number.
 - Tap  > **New**, enter a number, and tap **SAVE**.

To delete an item from the call rejection list:

1. From the Home screen, tap **Phone** >  > **Call settings** > **Call rejection** > **Rejection list**.
2. Tap  and select the item you want to remove from the list.
3. Tap **DONE**.

To manage the call rejection list from Contacts:

1. From the Home screen, tap **Apps**  > **Contacts**. Tap the **CONTACTS** tab, if necessary.
2. Tap a contact to display the detailed screen and touch and hold a number.
3. Tap an option:
 - **Allow call:** The number will be removed from the call rejection list.
 - **Reject call:** The number will be added to the call rejection list.

To add an item to the rejection list from Recent calls:

1. From the Home screen, tap **Phone** > **RECENTS**.
2. Tap an entry to display the detailed screen.
3. Tap  > **Add to reject call list** > **Reject call**.

Video Calling

You can make calls over Wi-Fi or mobile network by allowing Internet calling on your phone.

1. From the Home screen, tap **Phone** >  > **Call settings**.
2. Tap **Video calling** to turn on.

Phone Ringtone

Assign a ringtone to your incoming calls.

1. From the Home screen, tap **Phone** >  > **Call settings** > **Phone ringtone**.
2. If prompted, select an app to use and make your desired selection.
3. Select the file or tap **OK** to assign the ringtone.

Vibrate When Ringing

Set your phone to ring and vibrate simultaneously.

1. From the Home screen, tap **Phone** >  > **Call settings**.
2. Tap **Vibrate when ringing** to turn on.

Voice Mail

You can configure the Voice Mail settings.

1. From the Home screen, tap **Phone** >  > **Call settings** > **Voice Mail**.
2. Configure the following settings:
 - **Service** to select the Voice Mail service provider.
 - **Voice Mail number** to configure the Voice Mail number if necessary.
 - **Sound** to select the sound to ring for a new Voice Mail message.
 - **Vibrate** to select whether the phone responds with vibration to a new Voice Mail message.





Dial Pad Touch Tones

Play tones when using the dialpad.

1. From the Home screen, tap **Phone** >  > **Call settings**.
2. Tap **Dial pad touch tones** to turn on.

Quick Responses

You can add, delete, or modify the preset text messages to send when you select to reject an incoming call and send a text message. Your phone can register up to seven messages.

1. From the Home screen, tap **Phone** >  > **Call settings** > **Quick responses**.
2. Following options are available:
 - To edit a message, tap a message, edit it, and tap **OK**.
 - To add a new message, tap , enter text, and tap **OK**.
 - To delete a message, tap  > **Delete**, select a message, and then tap **DONE**.
 - To restore the default messages, tap  > **Reset to default**.

TTY Mode

A TTY (teletypewriter, also known as a TDD or Text Telephone) is a telecommunications device that allows people who are deaf, hard of hearing, or who have speech or language disabilities, to communicate by telephone.

Your phone is compatible with select TTY devices. Please check with the manufacturer of your TTY device to ensure that it supports digital wireless transmission. Your phone and TTY device will connect using a special cable that plugs into your phone's headset jack. If this cable was not provided with your TTY device, contact your TTY device manufacturer to purchase the connector cable.

To turn TTY Mode on or off:

1. From the Home screen, tap **Phone** >  > **Call settings** > **TTY mode**.
2. Tap **TTY Full**, **TTY HCO**, or **TTY VCO** to turn TTY mode on.

– or –

Tap **TTY Off** to turn TTY mode off.

Note: When enabled, TTY mode may impair the audio quality of non-TTY devices connected to the headset jack.

Warning: 911 Emergency Calling

It is recommended that TTY users make emergency calls by other means, including Telecommunications Relay Services (TRS), analog cellular, and landline communications. Wireless TTY calls to 911 may be corrupted when received by public safety answering points (PSAPs), rendering some communications unintelligible. The problem encountered appears related to TTY equipment or software used by PSAPs. This matter has been brought to the

attention of the FCC, and the wireless industry and the PSAP community are currently working to resolve this.

Power Key Ends Call

Set your phone to end call by pressing the Power button.

1. From the Home screen, tap **Phone** >  > **Call settings**.
2. Tap **Power key ends call** to turn on.

Voice Privacy

You can enable the enhanced privacy mode.

1. From the Home screen, tap **Phone** >  > **Call settings**.
2. Tap **Voice privacy** to turn on.

DTMF Tones

Follow the steps below if you need to change the DTMF tones.

1. From the Home screen, tap **Phone** >  > **Call settings** > **DTMF tones**.
2. Select **Normal** or **Long**.

Additional Settings

Caller ID

1. From the Home screen, tap **Phone** >  > **Call settings** > **Additional settings**.
2. Tap **Caller ID**.
3. Select from **Network default**, **Hide number**, or **Show number**.

Note: **Additional settings** is only available on GSM networks.

Hearing Aids

Set to turn on hearing aid compatibility.

1. From the Home screen, tap **Phone** >  > **Call settings**.
2. Tap **Hearing aids** to turn on.

Auto Answer

Select when to answer incoming calls automatically with the headset.

1. From the Home screen, tap **Phone** >  > **Call settings** > **Auto answer**.

2. Select **Hands free** or **Speakerphone**.
3. Select the delay time to automatically answer the phone.

Call Timer

To view the call timer and call duration:

1. From the Home screen, tap **Phone** >  > **Call settings**.
2. Tap **Call timer**.

To reset the call timer:

1. From the Home screen, tap **Phone** >  > **Call settings**.
2. Tap **Call timer**.
3. Touch and hold the item you want to reset and tap **OK**.

Push To Talk Plus (PTT+)

With PTT+, you can quickly and reliably connect to an individual or group instantly with a push of a button.



Note: This service requires a subscription.

Note: By installing PTT application, the Programmable button will be a dedicated PTT button.

Set Up PTT+

1. Download and install the PTT+ app from Play Store. See [Google Play Store App](#) for details.
2. Tap the installed app to open it.
3. Read Terms & Conditions and tap .
4. Tap **Yes** to confirm the activation.
5. Tap **View tutorial** to display the tutorials to learn how to start using the PTT+ app or **Skip tutorial**.

Create a PTT+ Contact



1. From the Home screen, tap **Apps**  > **Push To Talk+** > **Contacts**.
2. Tap  at the bottom of the screen.
3. Tap **New Contact** and manually enter the contact's information.

- or -

Tap **Import Contact**, select the contact source, and select the contact.

4. Tap .

Make a PTT+ Call

1. From the Home screen, tap **Apps**  > **Push To Talk+** > **Contacts**.
2. Tap the check box next to the contact you want to call on the contact list and tap .
3. Touch and hold the on-screen PTT+ button and speak after the chirp tone. A PTT+ call is started when the button turns red. While holding the button, your voice can be heard by the other person on the call.
4. Release the PTT+ button to allow other people on the call to take the floor and speak.
5. Tap **End Call** button to end the conversation.

- or -

The call will end automatically if no one takes the floor for a period of time.

For more information on PTT+, visit







business.com/content/b2b/en/solutions/mobility/push-to-talk-plus.html.

Contacts

The Contacts application lets you store and manage contacts from a variety of sources, including contacts you enter and save directly in your phone as well as contacts synchronized with your Google Account, your PC, and compatible email programs.



Contacts List

Scroll through the list to view all your contacts. To see a specific entry, tap it.

- ▶ From the Home screen, tap **Apps**  > **Contacts**.
 - **FAVORITES:** Tap to display your favorite contacts.
 -  **Add new favorite:** Tap to add a new favorite contact. See [Add a Contact to Favorites](#).
 - **CONTACTS:** Tap to display the individual contacts.
 -  **Add new contact:** Tap to add a new individual contact. See [Add a Contact](#).
 - **GROUPS:** Tap to display the group contacts.
 -  **Add new group:** Tap to add a new group contact. See [Add a Group Contact](#).
 -  : Tap to search a contact.
 -  : Tap to display the contacts list options. See [Contacts List Options](#) to follow.

Tip: You will see letters in alphabetical order when you drag the slider on the right of the screen. Release your finger to display the entries starting with a specific letter when you see it.



Contacts List Options

- ▶ From the Home screen, tap **Apps**  > **Contacts** > .
- **Cloud:** Displays the contacts in the Cloud app.
- **Share:** Shares contacts using Cloud, Android Beam, Bluetooth, Drive, etc.
- **Delete:** Allows you to select and delete the contacts.
- **Import/export:** Imports/exports contacts from/to the SIM card or microSD card, or shares your visible contacts.



- **Contacts to display:** Selects contacts to be displayed on Contacts. See [Display Options](#) to follow.
- **Settings:** Opens the display settings screen. You can select how your contacts are displayed. See [Display Options](#) to follow.

Display Options

Select which contacts to be displayed on Contacts.



1. From the Home screen, tap **Apps**  > **Contacts** >  > **Contacts to display**.
2. Select an account to display its contacts or select one of the following options:
 - **All contacts:** Displays all the contacts you've saved.
 - **Phone:** Displays the contacts saved in the phone.
 - **SIM:** Displays the contacts saved in the SIM card.
 - An account (for example, **Google**) to display only its contacts.
 - **Customize:** Allows you to display the selected types of contacts of the selected accounts.

You can also select how your contacts will be displayed.

1. From the Home screen, tap **Apps**  > **Contacts** >  > **Settings**.
2. Set the following options:
 - **Position of index tab:** Chooses the position to place the index tab.
 - **Sort by:** Selects how your contacts are sorted.
 - **Name format:** Selects how your contact's names are displayed.
 - **Accounts:** Selects to open the account settings.

Add a Contact

Enter details such as name, phone numbers, email addresses, mailing addresses, and more.

1. From the Home screen, tap **Apps**  > **Contacts** > **CONTACTS** > .
2. You may be prompted to select an account to save your new contact to. Select one of the following options:
 - Select an account from the displayed list.
 - **Phone:** Stores your contact to your phone.

- **SIM:** Stores your contact to the SIM card.
 - **ADD NEW ACCOUNT:** Adds a new account.
3. Use the keyboard to enter as much information as you want.
 - Tap the location/account above name and select an option to change where to save the contact to.
 - Tap **CHANGE** to assign a picture to the contact. See [Assign a Stored Picture to a Contact](#) or [Assign a New Picture to a Contact](#).
 - **Name**
 - **Phone**
 - **Email**
 - **ADD ANOTHER FIELD:** Tap to include additional information such as **DATE**, **Company**, **Notes**, **IM**, etc.

Note: To select a type (label) for a phone number, email address, or postal address (such as **Mobile**, **Home**, **Work**, etc.), tap ▼ to the right of the field and select the appropriate type.

4. When you have finished adding information, tap **SAVE**.

Save a Phone Number

You can save a phone number to Contacts directly from the phone dialpad.

1. From the Home screen, tap **Apps**  > **Phone** > **DIALPAD**.
2. Enter a phone number and tap **Add to contacts**.
3. To add the number to an existing contact, tap the contact, select a number type for the new number, and then tap **OK**.

– or –



To add the number as a new contact, tap **Create new contact**, enter the name and any additional information, and then tap **SAVE**. See [Add a Contact](#).

Edit a Contact

Once you've added a contact, you can add or edit any of the information in the entry, assign a caller ID picture, customize with a unique ringtone, and more.

Add or Edit Information for a Contact



Follow the instructions to add or edit information for an existing contact.

1. From the Home screen, tap **Apps**  > **Contacts** > **CONTACTS**.
2. Tap a contact to display it, and tap .
3. Tap any field you want to change or add. See [Add a Contact](#).
4. Add or edit the information, and then tap **SAVE**.

Note: To select a type (label) for a phone number, email address, or postal address (such as **Mobile, Home, Work, etc.**), tap ▼ to the right of the field and select the appropriate type.



Assign a Stored Picture to a Contact

Follow the instructions to assign a picture stored in your phone's internal memory or SD card to a contact.

1. From the Home screen, tap **Apps**  > **Contacts** > **CONTACTS**.
2. Tap a contact to display it, and tap .
3. Tap **CHANGE** to the right of the contact icon.
4. Tap **Choose photo** and select a location.
5. Tap a picture to select it.
 - You may be prompted to size the picture for use with contacts. Drag the square to frame the portion of the picture to use. Tap and drag the side of the square to resize the square and complete the action.
6. Tap **SAVE** to save the contact.

Assign a New Picture to a Contact



Follow the instructions to take a new picture and assign it directly to an existing contact.

1. From the Home screen, tap **Apps**  > **Contacts** > **CONTACTS**.
2. Tap a contact to display it, and tap .
3. Tap **CHANGE** to the right of the contact icon.
4. Tap **Take new photo**.

5. Tap  to take a picture.
 - You may be prompted to size the picture for use with contacts. Drag the square to frame the portion of the picture to use. Tap and drag the side of the square to resize the square and complete the action.
6. Tap **SAVE** to save the contact.



Assign a Phone Ringtone to a Contact

Know who's calling without looking at your phone by assigning a specific ringtone to a contact.

1. From the Home screen, tap **Apps**  > **Contacts** > **CONTACTS**.
2. Tap a contact to display it, and tap  > **Set phone ringtone**.
3. If prompted, select an app to use.
4. Tap a ringtone from the available list. The ringtone briefly plays when selected.
5. Tap **OK** to assign the ringtone.

Assign a Message Ringtone to a Contact

Know the sender of the new message from a specific ringtone.

1. From the Home screen, tap **Apps**  > **Contacts** > **CONTACTS**.
2. Tap a contact to display it, and tap  > **Set message ringtone**.
3. If prompted, select an app to use and select a ringtone.
4. Tap a ringtone from the available list. The ringtone briefly plays when selected.



- or -

Tap  and select a saved sound file.

5. Tap **OK** to assign the ringtone.

Assign a Vibration to a Contact



You can assign a specific vibration pattern to a contact.

1. From the Home screen, tap **Apps**  > **Contacts** > **CONTACTS**.
2. Tap a contact to display it, and tap  > **Set vibration pattern**.
3. If prompted, select an app to use.



4. Tap an available vibration. The phone vibrates when selected.
5. Tap **OK** to assign the vibration.

Add a Contact to Favorites

The Favorites tab of the Phone menu is a listing that can help you quickly access your most used or preferred contacts entries.

1. From the Home screen, tap **Apps**  > **Contacts** > **CONTACTS**.
2. Tap a contact.
3. Tap . The icon changes to  when the contact is added to Favorites.

– or –

1. From the Home screen, tap **Apps**  > **Contacts** > **FAVORITES**.
2. Tap  and select the check box next to the contact(s) that you want to add to your Favorites list.
3. Tap **DONE**.



Add a Contact Widget to the Home Screen

You can add the contact widget to your home screen.

1. From the Home screen, tap **Apps**  > **Contacts** > **CONTACTS**.
2. Tap a contact to display it and then tap  > **Add shortcut to Home screen**.

Delete Single or Multiple Contacts

You can delete contacts from the contacts details page.



1. From the Home screen, tap **Apps**  > **Contacts** > **CONTACTS**.
2. Tap  > **Delete**, select the check box next to the contact(s) you want to delete, or tap **SELECT ALL**.
3. Tap **DONE** and then tap **OK** to confirm the deletion.

- or -

Tap a contact to display it, and tap  > **Delete** > **OK**.



Join Contacts

You can merge the contact you wish to join with the primary listing.

1. From the Home screen, tap **Apps**  > **Contacts** > **CONTACTS**.
2. Select the contact you want to appear as the primary listing.
3. Tap  > **Merge**.
4. Choose the contact you wish to join.



Separate Contacts

You can separate the merged contact into multiple contacts.

1. From the Home screen, tap **Apps**  > **Contacts** > **CONTACTS**.
2. Select the merged contact you edited before.
3. Tap  > **Separate** > **OK**.

Copy/Move Contacts



You can copy/move the contact you want.

1. From the Home screen, tap **Apps**  > **Contacts** > **CONTACTS**.
2. Select the contact you want to copy/move.
3. Tap  > **Copy/Move contact**.
4. Tap **Copy** or **Move**.
5. Select the destination you want to copy/move to.

Add a Group Contact

Create a group contact with your individual contact entries in Contacts.



Note: In order to create a group contact, you may first sync your phone with a Google or corporate account. See [Synchronize Contacts](#) for instructions on how to sync your phone to an account.

1. From the Home screen, tap **Apps**  > **Contacts** > **GROUPS** > .
2. Select the account in which you want to create a group contact.
3. Enter the group's name.
4. Tap **Add/remove contacts** and tap the entries you want to add.
5. Tap **DONE** > **SAVE**.

Edit a Group Contact



Manage the group contacts that you have created.

Add or Remove a Group Contact Entry, or Rename a Group

1. From the Home screen, tap **Apps**  > **Contacts** > **GROUPS**.
2. Tap a group contact and tap .
3. The following options are available:
 - Tap the group's name to rename it.
 - Tap **Add/remove contacts** to add an entry to the group.
 - Tap **Add/remove contacts** and tap the entries you want to remove from the group.
4. Tap **DONE**.
5. Tap **SAVE**.



Assign a Ringtone to a Group Contact

You can assign a ringtone to a group contact.

1. From the Home screen, tap **Apps**  > **Contacts** > **GROUPS**.
2. Tap a group contact to display it and then tap  > **Ringtone**.
3. Select a ringtone to use.
4. Tap **OK** > **SAVE**.

Assign a Vibration Pattern to a Group Contact

You can assign a vibration pattern to a group contact.

1. From the Home screen, tap **Apps**  > **Contacts** > **GROUPS**.
2. Tap a group contact to display it and then tap  > **Vibration pattern**.
3. Select a vibration pattern to use.
4. Tap **OK** > **SAVE**.

Delete a Group Contact



1. From the Home screen, tap **Apps**  > **Contacts** > **GROUPS**.

2. Tap a group you want to delete, and tap  > **Delete**.
3. Tap **OK**.



ICE (In Case of Emergency)

Registering ICE information might help rescue workers, such as paramedics, police and hospital personnel identify your primary contact. You can register up to three contacts.

To register an ICE contact:

1. From the Home screen, tap **Apps**  > **Contacts** > **GROUPS**.
2. Tap **In case of emergency** >  > **Add/remove contacts**.
3. Tap the entry you want to register and tap **DONE** > **SAVE**.



To remove an ICE contact:

1. From the Home screen, tap **Apps**  > **Contacts** > **GROUPS**.
2. Tap **In case of emergency** >  > **Add/remove contacts**.
3. Tap the entry you want to remove and tap **DONE** > **SAVE**.

Synchronize Contacts

Syncing data from your managed accounts lets you add and manage new or existing contacts from your online or remote accounts to your phone. Prior to syncing, you must have an active Google or corporate account with associated contacts, and be signed into your account with the phone.

With syncing, any contacts (with phone numbers, email addresses, pictures, etc.) are updated and synced with your phone.



1. From the Home screen, tap **Apps**  > **Contacts**.
2. Tap  > **Settings** > **Accounts**.
3. Tap an account type such as **Corporate**, **Email**, **Google**, etc.
4. Tap the account you want to sync your contacts with.
5. Tap the **ON/OFF** switch next to **Contacts** to turn contacts sync on or off.

Your Contacts then reflects any updated contact information.

- This update process works both ways. For example, any changes on the phone are updated to your account contacts list after sync.

Share a Contact

You can quickly share contacts using Bluetooth, Email, Gmail, or text messaging.

1. From the Home screen, tap **Apps**  > **Contacts** > **CONTACTS**.
2. Tap a contact to display it, and tap  > **Share**.
3. In the **Share contact via** menu, select a method and follow the onscreen instructions.

Accounts and Messaging

With _____ service and your phone's messaging capabilities, you have the opportunity to share information through many different channels and accounts, including Gmail (Google), personal and corporate email, text and multimedia messaging, and social networking accounts.

Gmail / Google

You will need a Google Account to access several phone features such as Gmail, Google+, and the Google Play Store applications. Before you are able to access Google applications, you must enter your account information. These applications sync between your phone and your online Google Account.

Create a Google Account

If you do not already have a Google Account, you can create one online or using your phone.

Note: Although you need a Gmail account to use certain features on your phone, such as Google Play Store, you do not need to use Gmail as the default account for your phone.

Create a Google Account Online

1. From a computer, launch a Web browser and navigate to google.com.
2. On the main page, click **Sign in > Create account**.
3. Follow the onscreen prompts to create your free account.

Create a Google Account Using Your Phone

1. From the Home screen, tap **Apps**  > **Settings** > **Accounts** > **Add account** > **Google**.
2. Tap **Or create a new account**.
3. Enter your first name and last name, and tap **NEXT**.
4. Enter a desired username and tap **NEXT**.
5. When prompted, enter and reenter a password and tap **NEXT**.
6. Select if you set up recovery options now.

Note: When setting up a new Google Account, either on your phone or online, you are recommended to add a secondary phone number or email address. Enter a second phone number or email address from which you currently send and receive message or email. This number or address is used to authenticate your account should you ever encounter problems or forget your password. It is strongly encouraged for Android users so you can regain access to Google Mobile™ services and purchases on your phone.



7. Follow the onscreen prompts to create your free account.

Sign In to Your Google Account



If you have a Google Account but have not yet signed in with your phone, follow these instructions.

1. From the Home screen, tap **Apps**  > **Settings** > **Accounts** > **Add account** > **Google**.
2. Enter your email address, and tap **NEXT**.
3. Enter the password, and tap **NEXT**.
4. Read the message, and tap **ACCEPT**.
5. Select the backup options, if prompted, and tap **NEXT**.
6. Select if you save your credit card information now to enable purchases at Google Play Store.
7. Select the items you would like to sync with your phone, if necessary. Your account is displayed in **Google** under Accounts in the Settings menu.

Access Gmail

1. From the Home screen, tap **Apps**  > **Gmail**.
2. Do any of the following:
 - View more email messages: If the screen is full, swipe your finger up the screen to view more messages and conversations.
 - Read a new email message: Tap the unread message or the conversation with an unread message (just-arrived items display in bold).
 - Select messages and conversations: Touch and hold the email or conversation.
 - View the inbox of your other Gmail account: If you have more than one Google account set up on your phone, tap  at the top left of the screen and then choose an account to view.

Send a Gmail Message





1. From the Home screen, tap **Apps**  > **Gmail**.
2. In any folder, tap .
3. Enter the message recipient's email address in the **To** field.

4. If you want to send a carbon copy (CC) or a blind carbon copy (BCC) of the email to other recipients, tap  on the right side of the **To** field.
5. Enter the subject and then compose your message.

Note: If you want to add a file as attachment, tap , select **Attach file** or **Insert from Drive** and then locate and choose the file you want to attach.

6. After composing your message, tap .



Read and Reply to Gmail Messages

1. From the Home screen, tap **Apps**  > **Gmail**.
2. Tap a message to display it.
3. To reply to or forward a message:
 - Tap  to reply to the message.
 - Tap  > **Reply all** to reply to all recipients.
 - Tap  > **Forward** to forward the message.

Tip: You can also select from the reply options displayed below the email.

4. After composing your message, tap .

Gmail Account Settings



1. From the Home screen, tap **Apps**  > **Gmail**.
2. Tap  at the top left of the screen to display menu.
3. Tap **Settings** > **General settings**.
4. Configure the following settings:

Note: Depending upon the email account type, the available options may vary.

- **Gmail default action:** Select whether you want delete or archive to be the default option.
- **Conversation view:** Check to turn Conversation view on.
- **Swipe actions:** Check to archive a conversation when you swipe it.
- **Sender image:** Check to display an image of the sender in conversation list.
- **Reply all:** Check to display the Reply all option as default.

- **Auto-fit messages:** Check to shrink the messages to fit the screen and allow zooming.
- **Auto-advance:** Choose which screen to show after you delete a message.
- **Confirm before deleting:** Check to display a confirmation before deleting a message.
- **Confirm before archiving:** Check to display a confirmation before archiving a message
- **Confirm before sending:** Check to display a confirmation before sending a message.

Delete a Gmail Account

1. From the Home screen, tap **Apps**  > **Settings** > **Accounts** > **Google**.
2. Tap the account you want to delete.
3. Tap  > **Remove account**.
4. Tap **REMOVE ACCOUNT**.

Email

Use the Email application to send and receive email from your webmail or other accounts, using POP3 or IMAP, or access your Exchange ActiveSync account for your corporate email needs.

Add an Email Account

1. From the Home screen, tap **Apps**  > **Settings** > **Accounts** > **Add account** > **Email**.

– or –

From the Home screen, tap **Apps**  > **Email**, if you have not set up any email account yet.

2. Tap a desired account.
3. Enter your email address and password and tap **NEXT**.
4. Enter any other necessary information and follow the onscreen instructions.

Important: If the account type you want to set up is not in the phone database, you will be asked to enter more details. You should get all pertinent information for the email account, such as incoming and outgoing server settings, before you proceed.

Add a Corporate Account

If you synchronize your phone with your corporate account, you can read, manage, and send email in the same easy way as with a POP3/IMAP account. However, you can also access some powerful Exchange features.

Note: Before setting up a Microsoft® Exchange ActiveSync® account, contact your company's Exchange Server administrator for required sign-in information.

1. From the Home screen, tap **Apps**  > **Settings** > **Accounts** > **Add account** > **Corporate**.

– or –



From the Home screen, tap **Apps**  > **Email**, if you have not set up any email account yet, and tap **Exchange**.



2. Enter your email address and your password and then tap **NEXT**. Consult your network administrator for further details:
3. Configure the account options as necessary and tap **NEXT**.
4. Follow the onscreen instructions.

Note: You can have multiple corporate email (Microsoft Exchange ActiveSync) accounts active on your phone.



Compose and Send Email

Compose and send email messages using any account you have set up on your phone. Increase your productivity by attaching files such as pictures, videos and documents to your email messages.







1. From the Home screen, tap **Apps**  > **Email**.
2. On the email account Inbox, tap .
3. Tap fields to compose your message:
 - Tap the **To** field and enter the recipient's email address or tap  to add recipients.
 - To send a carbon copy (Cc) or a blind carbon copy (Bcc) of the email to other recipients, tap at the right of the **To** field.
 - Tap the **Subject** field and enter the email subject. Tap the exclamation point to set a priority.
 - Tap the text entry field and compose your email.

- To add an attachment, tap  > **Pictures, Take picture, Videos, Record video, Audio, or Others.**
- 4. Tap  to send the message.
 - To save the current email as a draft, tap  > **Save draft.**

View and Reply to Email

1. From the Home screen, tap **Apps**  > **Email.**
2. On the email account Inbox, tap a message to view it.
3. Tap  (Reply) or  (Reply all) to reply to the message.

Manage Your Email Inbox

1. From the Home screen, tap **Apps**  > **Email.**
2. You have the following options:
 - Tap  at the top of the screen to select a different email account.
 - Tap  to search an email.
 - Tap  > **Settings** to display the email settings.
 - Tap  to compose a new email message.
 - Swipe down on the screen to refresh your email box.
 - Tap  to show all folders.

Refresh an Email Account



- ▶ While in the account you want to synchronize, swipe down on the screen.

Delete Email Messages

- ▶ On the email account Inbox, swipe an email message left or right.
- or –
1. On the email account Inbox, touch and hold the message you want to delete.
 2. Tap  > **OK.**



General Email Settings

You can edit the general settings of your email.



1. From the Home screen, tap **Apps**  > **Email** >  > **Settings**.
2. Tap **General settings**.
3. Tap the item you want to edit.

Email Account Settings

You can edit settings for your individual email accounts, such as email address and password, name display and signature, frequency of retrieval, and more.



1. From the Home screen, tap **Apps**  > **Email** >  > **Settings**.
2. Select the email account you want to edit.

Delete Email Accounts

1. From the Home screen, tap **Apps**  > **Email**.
2. Tap  > **Settings**.
3. Tap  and select the checkbox(es) next to the account(s) you want to delete.
4. Tap **DONE** > **REMOVE ACCOUNT(S)**.

Message+

Message+ provides an improved text and multimedia (i.e., picture and video) messaging experience. You can send and receive text and multimedia messages seamlessly from your phone, tablet, or the web using your primary phone number.

1. From the Home screen, tap **Apps**  > **Message+**.
2. On the Messaging screen, tap . The Compose screen opens.
3. Enter a phone number in the **To** field.
 - As you type, any matching phone numbers from your contacts list are displayed. Tap a match to enter that number.
 - If you're sending the message to several recipients, separate the phone numbers with a semicolon.

Tip: You can type a name saved in your Contacts to call up the phone number, or tap  to access your Contacts.

4. If you add multiple recipients in the **To** field, select how you want them to reply to the message: **Just Me** to reply to you only or **Group** to replay all.
5. Tap the text entry field next to  and compose your message.

Tip: Tap  to display the menus for adding a postcard, picture, audio recording, etc.

6. When you finish composing the message, tap .



Save and Resume a Draft Message

You can save the message and send it later.

To save a message as draft:

- ▶ While composing a message, press  until you go back to the messaging list screen. The text "Message saved as draft." briefly appears and your message is saved as draft.

To resume composing the message:

1. From the Home screen, tap **Apps**  > **Message+**.
2. On the messaging list screen, tap the message with "Draft" in red.
3. When you finish editing the message, tap  to send it.

For more information on Message+, visit

[com/wcms/consumer/products/](http://com/wcms/consumer/products/messages.html) messages.html.

Social Networking Accounts

Stay in touch while on the go with all your social networking accounts.

YouTube

YouTube™ is a video sharing website on which users can upload and share videos. The site is used to display a wide variety of user-generated video content, including movie clips, TV clips, and music videos, as well as video content such as video blogging, informational shorts and other original videos.

Open YouTube

- ▶ From the Home screen, tap **Apps**  > **YouTube**.

Note: **Terms of Service** may appear. Tap **ACCEPT**, if you agree to the Terms of Service.

Watch YouTube Videos

1. On the YouTube screen, tap a video.
2. Tap the screen to show the progress bar at the bottom. Tap the screen while the bar is displayed to pause/play the video. Move the slider on the bar to the left or right to rewind or fast-forward the video.

Search for Videos

1. On the YouTube screen, tap  on the screen to open the search box.
2. Enter the keyword to search. Search results appear below the status bar.
3. Tap a video to watch it.

Hangouts

Hangouts is an application for instant messaging offered by Google.

1. From the Home screen, tap **Apps**  > **Google** > **Hangouts**.
2. If you have already signed in to a Google account, the Hangouts screen is displayed.

– or –

Tap **Or create a new account** to create a new Google account, or sign in to an existing Google account.

3. Follow the onscreen instructions.

Apps and Entertainment

All your phone's features are accessible through the Apps list.

Google Play Store App

Google Play™ is your digital content destination to discover Android apps, books, movies, music and much more. Choose from a wide variety of free and paid content ranging from productivity apps and games to bestselling books and blockbuster movies and music. When you find what you want, you can easily download and install it on your phone.

To access the Google Play Store app, you must first connect to the Internet using your phone's Wi-Fi, 4G LTE, or data connection and sign in to your Google Account. See [Web and Data](#) and [Sign In to Your Google Account](#).

Find and Install an App

When you install apps from the Google Play Store app and use them on your phone, they may require access to your personal information (such as your location, contact data, and more) or access to certain functions or settings of your phone. Download and install only apps that you trust.

1. From the Home screen, tap **Apps**  > **Play Store**.
2. When you open the Google Play Store app for the first time, the Terms of Service window will appear. Tap **ACCEPT** to continue.
3. Find an app you want and tap it to open its details screen.

Note: Your Google Play Store app will update automatically when available.

4. Tap an app to read a description about the app and user reviews.
5. Tap **INSTALL** (for free applications) or the price button (for paid applications).

Note: If you have not set up your payment method on your Google account, you are prompted to enter your billing information to set it up.

6. The subsequent screen notifies you whether the app will require access to your personal information or access to certain functions or settings of your phone. If you agree to the conditions, tap **ACCEPT** to begin downloading and installing the app.

If you selected a paid application, after tapping **ACCEPT**, follow the onscreen instructions to add a payment method and complete your purchase.

Warning: **Read the notification carefully!** Be especially cautious with applications that have access to many functions or a significant amount of your data. Once you



tap **ACCEPT** on this screen, you are responsible for the results of using this item on your phone.

Google Play Store Options

Some convenient options are available with the Google Play Store app. Available options may vary.

- ▶ In the Google Play Store app, tap  on the top left of the screen to display the following options:

Tip: You can also touch and hold the left end of the screen and slide it to the right to display the options.

- The account name you are currently logged in to the Google Play Store app is displayed. To log in with another account stored on your phone, tap  next to the account name and select an account.
- Touch the empty area on the right side of the options screen to return to the Google Play Store homepage.
- **Apps & Games** displays the Apps Home screen.
- **My apps & games** displays the lists of apps installed on your phone.
- **Entertainment** displays the Entertainment Home screen.
- **Account** allows you to manage your account.
- **Redeem** allows you to redeem Google Play Store gift card and promotional code.
- **Wishlist** displays the apps you have bookmarked. To bookmark an app, tap the bookmark icon  on the apps detailed screen.
- **People** displays a list of person resources, each of which represents a Google+ user.
- **Settings** to manage settings for Google apps and services.

Note: Tap **Help & Feedback**, **Parent Guide** or **About Google Play** for additional options.

Request a Refund for a Paid App

If you are not satisfied with an app, you can ask for a refund within 15 minutes of the purchase, unless otherwise stated by the app developer. Your account is not charged and the app is uninstalled from your phone.



If you change your mind, you can install the app again, but you can't request a refund a second time.

1. From the Home screen, tap **Apps**  > **Play Store**.

2. Tap  on the top left of the screen, or touch and hold the left end of the screen and slide it to the right, and tap **My apps & games**.
3. Tap the app to uninstall for a refund. The details screen for the app opens.
4. Tap **Refund**. Your app is uninstalled and the charge is cancelled.

Open an Installed App



There are options for opening an installed app.

- ▶ On the status bar, check if you see the  icon. If you see the  icon, open the Notifications panel, and then tap the app to open it.

– or –



1. From the Home screen, tap **Apps** .
2. Locate the app and tap the icon.

– or –



1. From the Home screen, tap **Apps**  > **Play Store**.
2. Tap  on the top left of the screen, or touch and hold the left end of the screen and slide it to the right, and tap **My apps & games**.
3. Locate the app and tap the icon.
4. Tap **OPEN**.

Uninstall an App

You can uninstall any app that you have downloaded and installed from the Google Play Store app.

1. From the Home screen, tap **Apps**  > **Play Store**.
2. Tap  on the top left of the screen, or touch and hold the left end of the screen and slide it to the right, and tap **My apps & games**.
3. Tap the app you want to uninstall, and tap **UNINSTALL**.
4. When prompted, tap **OK** to remove the app from your phone.

– or –

1. From the Home screen, tap **Apps**  > **Settings** > **Application manager**.
2. Tap  to display the drop-down list, and tap **Downloaded**.

3. Tap the app you want to uninstall, and tap **DISABLE > DISABLE APP**.
4. When prompted, tap **OK** to remove the app on your phone.

Google Maps

Use the Google Maps app to determine your location, find directions, browse local businesses and attractions, rate and review places, and more.

Enable Location Services on Your Phone

Before using any location-based services, you must enable your phone's GPS location feature. See [Location Settings](#).

Open Google Maps

- From the Home screen, tap **Apps**  > **Maps**.

Note: When you open the Google Maps apps for the first time, the Welcome to Google Maps screen will appear. Tap **ACCEPT & CONTINUE** if you agree to the Terms of Service and Privacy Policy.

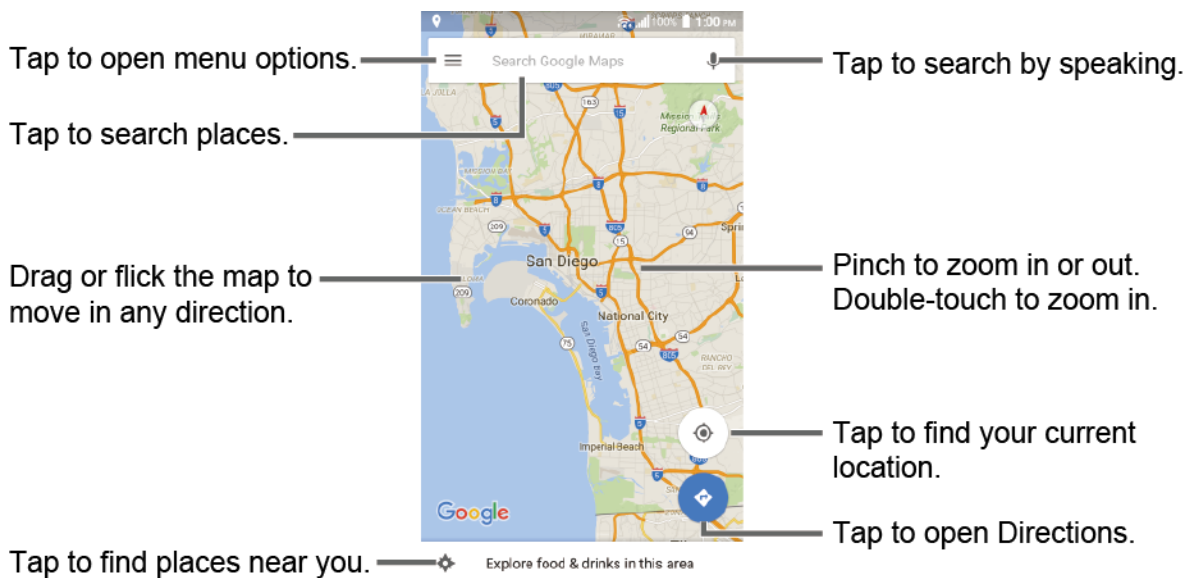

Find Your Current Location

Note: Don't forget to set your location sources.

On the Google Maps screen, tap . A blinking blue arrow indicates your current location on the map. This feature is available when the location setting is enabled. See [Location Settings](#).

Search Maps

1. On the Google Maps screen, tap inside the Search bar at the top of the screen.

2. Type the place that you want to search. You can enter an address, a city, or type of establishment.

Tip: Tap  to enter the location by speaking.

3. Tap a matching result on the drop-down list, or tap  on the keyboard. A red marker appears on the map to indicate the location together with a label at the bottom of the screen.
4. Tap the marker or the label to open the menu for the location.

Add Map Layers

Layers allow you to view locations and additional info overlaid on the map. Some of the layers are available in selected areas only.

- ▶ On the Google Maps screen, tap  on the top left of the screen, or touch and hold the left end of the screen and slide it to the right:
 - **Traffic:** Provides real-time traffic information. The colors on the roads indicate the traffic conditions.
 - **Public Transit:** Provides available transit information.
 - **Bicycling:** Provides possible cycling routes.
 - **Satellite:** Provides the hybrid view of road labels overlaid on a satellite image.
 - **Terrain:** Provides a shaded relief view of topographic features.
 - **Google Earth:** Launches the Google Earth app and displays your location in Google Earth.



Note: Tap **Tips & tricks**, **Settings**, **Help** or **Send feedback** for additional options.

Get Directions

1. On the Google Maps screen, tap .
2. Specify the starting point and the destination:

Tip: To display your Home and Work as options, tap  at the top left of the Google Maps screen, select **Your places**, and then enter their addresses.

- The starting point is set to your current location as default. To change it, tap **Your location** and type a new point in the **Choose starting point** field or select a point from the list.

- Tap **Choose destination** and type your destination or select a destination from the list.
 - Tap  to switch the starting point and the destination.
3. Select the method to get to the destination (by car, by public transit, or by foot).
 - You may tap  or **OPTIONS** to configure available settings options.
 4. Tap the result to see the details.

Music

You can play digital audio files saved on the phone or the storage card using music apps. See [Use the Phone's microSD Card as a Media Device](#) for copying files.

Play Music

Access the Play Music app to enjoy your favorite music.

Access the Play Music App



1. From the Home screen, tap **Apps**  > **Play Music**. The Google Play Music screen appears.



Note: If you have signed up for Google Music™, the first time you open the Play Music application you will be prompted to select the account whose online music library you want to access from the Google Play Music application. Follow the onscreen instructions to continue.

2. Tap  on the top left of the screen, or touch and hold the left end of the screen and slide it to the right, to display the screen options.
 - **Listen Now:** Your starting point to play music. See [The Listen Now Screen](#) to follow.
 - **Top charts:** Displays Google Play Music best hit charts.
 - **New releases:** Displays Google Play Music newly released music.
 - **Music library:** Your music is sorted by **PLAYLISTS, STATIONS, ARTISTS, ALBUMS, SONGS** and **GENRES**.
 - **Browse stations:** Allows you to download radio stations to your device to listen.
 - **Downloaded only:** Allows you to show only the downloaded music on your device. Tap the switch to turn the feature on or off.
 - **Settings:** Allows you to change your settings on the Google Play Music.
 - **Help & Feedback:** Displays Google Play Music help page.

The Listen Now Screen

Learn the basics to use the Play Music application.

- ▶ Tap **Shuffle all** to play the music on your phone in shuffle mode.
- ▶ Tap an album image and then tap a song in the album to play it.
- ▶ Tap  for available options.
- ▶ Tap  to search for music.

The label of the currently played song appears at the bottom of the screen when you play music. Simply tap  or  on the label or tap the label to display a screen with more control menus to manage.

Back Up Your Downloaded Music Files

recommends you back up your downloaded music files to your computer. Although the downloaded files can only be played on your phone and on your account, backing them up to your computer lets you access the files in case your microSD card is lost or damaged, or if you install a new microSD card. See [microSD Card](#).

1. Connect your phone to your computer using a USB cable.
2. Use your computer to navigate to the microSD card's Music folder.
3. Select and copy the music files to a folder on your computer's hard drive.

Web and Data

Your phone's data capabilities let you wirelessly access the Internet or your corporate network through a variety of connections, including Wi-Fi, 4G LTE, 4G, 3G, 2G, and Virtual Private Networks (VPN).

The following topics address your phone's data connections and the built-in Web browser. Additional data-related features can be found in [Accounts and Messaging](#), [Apps and Entertainment](#), and [Tools and Calendar](#).

Wi-Fi

Wi-Fi provides wireless Internet access. To use your phone's Wi-Fi, you need access to a wireless access point or "hotspot."

The availability and range of the Wi-Fi signal depends on a number of factors, including infrastructure and other objects through which the signal passes.

Turn Wi-Fi On and Connect to a Wireless Network

Use the Wireless & networks setting menu to enable your phone's Wi-Fi radio and connect to an available Wi-Fi network.

1. From the Home screen, tap **Apps**  > **Settings**.
2. Tap **Wi-Fi**.
3. Tap the **ON/OFF** switch to turn Wi-Fi on. The network names of detected Wi-Fi networks are displayed.
4. Tap a Wi-Fi network to connect. If you selected an open network, you will be automatically connected to the network. If you selected a network that is secured with a password, enter the password and then tap **CONNECT**.

Depending on the network type and its security settings, you may also need to enter more information or choose a security certificate.

When your phone is connected to a wireless network, the Wi-Fi icon  appears in the status bar and tells you the approximate signal strength. (The above icon indicates maximum signal strength.)

Note: The next time your phone connects to a previously accessed secured wireless network, you will not be prompted to enter the password again, unless you reset your phone to its factory default settings or you instruct the phone to forget the network.

Note: Wi-Fi networks are self-discoverable, which means no additional steps are required for your phone to connect to a Wi-Fi network. It may be necessary to provide a user name and password for certain closed wireless networks.

Check the Wireless Network Status



Check the status of your current wireless network, including speed and signal strength, through the Wi-Fi settings menu.

1. From the Home screen, tap **Apps**  > **Settings** > **Wi-Fi**.
2. Tap the wireless network that the phone is currently connected to. You will see a message box showing the Wi-Fi network name, status, speed, signal strength, and other details.

Note: If you want to remove the phone's wireless network settings, tap **FORGET** on this window. You need to enter the settings again if you want to connect to this wireless network.

Connect to a Different Wi-Fi Network



Use the Wireless & networks settings menu to scan for and connect to a different Wi-Fi network.

1. From the Home screen, tap **Apps**  > **Settings** > **Wi-Fi**.
 - Detected Wi-Fi networks are displayed in the Wi-Fi networks section. To manually scan for available Wi-Fi networks, tap  > **Refresh**.
2. Tap another Wi-Fi network to connect to it.

Note: If the wireless network you want to connect to is not in the list of detected networks, tap  > **Add network**. Enter the wireless network settings and tap **SAVE**.

The Wi-Fi Settings Menu

The Wi-Fi settings menu lets you turn Wi-Fi on or off, set up and connect to available Wi-Fi networks, and configure advanced Wi-Fi options.

- ▶ From the Home screen, tap **Apps**  > **Settings** > **Wi-Fi**.
 - Tap  for the following menus:
 - **Add network** to add a new Wi-Fi network.
 - **Saved networks** to display the connected Wi-Fi network.
 - **Refresh** to manually scan for available Wi-Fi networks.
 - **Request via NFC** to request the Wi-Fi details from another device using the NFC feature. See [Turn NFC On or Off](#) for enabling NFC.

- **Wi-Fi Direct** to use a peer-to-peer Wi-Fi connection. The Wi-Fi client and the hotspot operation will be disabled while Wi-Fi direct is enabled.
- **Advanced** to configure advanced Wi-Fi settings, which include:
 - **Show Wi-Fi pop-up** to notify you that Wi-Fi is available when you launch apps.
 - **Wi-Fi notifications** to notify whenever a public network is available.
 - **Avoid bad Wi-Fi connections** to avoid a Wi-Fi network unless it has a good Internet connection.
 - **Keep Wi-Fi on when screen is off** to stay connected to Wi-Fi when the screen goes to sleep to manage mobile data usage.
 - **Wi-Fi frequency band** to specify the frequency band for Wi-Fi.

Note: Wi-Fi Direct cannot be used if you select to use only the 5 GHz frequency band.

- **Install certificates** to install the certificates for communicating via Wi-Fi.
- **WPS Push Button** to set up a Wi-Fi Protected Setup connection by pressing the set up button on the router.
- **WPS Pin Entry** to set up a Wi-Fi Protected Setup connection by entering the PIN on your router.
- **MAC address** to display the Media Access Control (MAC) address of your phone when connected to a Wi-Fi network.
- **IP address** to display the Internet Protocol (IP) address assigned to your phone by the Wi-Fi network you are connected to (unless you used the IP settings to assign it a static IP address).
- **Help** to access the help menus for Wi-Fi.

Data Services

The following topics will help you learn the basics of using your data services, including managing your user name, launching a data connection, and navigating the Web with your phone.

Important: Certain data services requests may require additional time to process. While your phone is loading the requested service, the touchscreen may appear unresponsive when in fact they are functioning properly. Allow the phone some time to process your data usage request.

Launch a Web Connection













Launching a Web connection is as simple as opening the browser on your phone.

- ▶ From the Home screen, tap **Apps**  > **Chrome**.

Note: The Chrome browser automatically launches when a Web link is tapped from within either an email or text message.

Data Connection Status and Indicators

Your phone displays the current status of your data connection through indicators at the top of the screen. The following symbols are used:

Icon	Description
 	Your phone is connected to the high-speed 4G LTE network.
 	Your phone is connected to the 3G network.
 	Your phone is connected to the 1X network.
 	Your phone is connected to the EDGE network.
 	Your phone is connected to the HSPA network.
 	Your phone is connected to the GPRS network.

When the arrows are animated, your phone is transferring data (for example, when you are opening a Web page); when the arrows are gray, your phone is connected to the network but is not currently transferring data (for example, when you are viewing a Web page that is completely open). In either state, you can receive incoming calls.

If you do not see an indicator, your phone does not have a current data connection. To launch a connection, see [Launch a Web Connection](#).

Virtual Private Networks (VPN)

From your phone, you can add, set up, and manage virtual private networks (VPNs) that allow you to connect and access resources inside a secured local network, such as your corporate network.

Prepare Your Phone for VPN Connection

Depending on the type of VPN you are using at work, you may be required to enter your login credentials or install security certificates before you can connect to your company's local network. You can get this information from your network administrator.

Before you can initiate a VPN connection, your phone must first establish a Wi-Fi or data connection. For information about setting up and using these connections on your phone, see [Launch a Web Connection](#) and [Turn Wi-Fi On and Connect to a Wireless Network](#).

Install Security Certificates

Your network administrator may instruct you to download and install security certificates to connect to the network.

1. Download and install the certificates needed to access your local network into a microSD card. Your network administrator can tell you how to do this.
2. Insert the microSD card into your phone. See [Insert or Remove a microSD Card](#).
3. From the Home screen, tap **Apps**  > **Settings** > **Security** > **Install from SD card**, and install the necessary security certificates.

Add a VPN Connection

Use the Wireless & networks settings menu to add a VPN connection to your phone.

1. From the Home screen, tap **Apps**  > **Settings** > **More** > **VPN** > **Basic VPN**.

Note: Tap **Advanced IPsec VPN** to access the KeyVPN app.



2. If you are asked to set up a screen lock, tap **OK** and set up a required type of lock. To set up a screen lock, see [Security Type](#).
3. Tap  and enter the information for the VPN you want to add.
 - Information may include Name, Type, Server address, PPP encryption (MPPE), and advanced options.
 - Set up all options according to the security details you have obtained from your network administrator.
4. Tap **SAVE**.

The VPN is then added to the VPNs section of the VPN settings screen.

Connect to or Disconnect from a VPN

Once you have set up a VPN connection, connecting and disconnecting from the VPN is easy.

Connect to a VPN

1. From the Home screen, tap **Apps**  > **Settings** > **More** > **VPN** > **Basic VPN**.
2. In the VPNs section, tap the VPN that you want to connect to.
 - Tap  > **Always-on VPN** to select a VPN profile to always remain connected to.
3. When prompted, enter your login credentials, and then tap **CONNECT**. When you are connected, a VPN connected icon appears in the notification area.
4. Open the Web browser to access resources such as intranet sites on your corporate network. For more information about browsing the Web, see [Learn to Navigate Chrome](#).

Disconnect from a VPN

1. Slide the status bar down to open the Notifications panel.
2. Tap the VPN connection to return to the VPN settings screen, and then tap the VPN connection to disconnect from it.

When your phone has disconnected from the VPN, a VPN disconnected icon briefly appears in the notification area.

Browser

Your phone's Web browser gives you full access to both mobile and traditional websites on the go, using data services or Wi-Fi data connections.

Launch Chrome

Launching Chrome is as easy as tapping an icon.

- ▶ From the Home screen, tap **Apps**  > **Chrome**.

Learn to Navigate Chrome

Navigating through menus and websites during a data session is easy once you have learned a few basics.

Scrolling

As with other parts of your phone's menu, you'll have to drag up and down to see everything on some websites.

To scroll through a website's page:

- ▶ In a single motion, touch and drag across or up and down a page.

Selecting

To select onscreen items or links:

- ▶ Scroll across a page, and then tap an item or onscreen link.

Links, which are displayed as underlined text, allow you to jump to Web pages, select special functions, or even place phone calls.

Pinching and Zooming

Zooming in and out on a Web page can be done without the need of an onscreen zoom tool. Just use your fingers to pinch in or spread out on the screen.

To zoom in:

1. Place your thumb and index finger on the screen.
2. Expand them outward (spread) to zoom in.

To zoom out:

1. Place your thumb and index finger on the screen.
2. Bring them together (pinch) to zoom out.

Go Back

To go back one page:

- ▶ Press  on your phone. Repeat this process to keep going back through your Web page history of recently visited pages.

Go to a Specific Website

1. Tap the search/address field at the top of the browser window and enter a new Web address.
 - As you enter the address, possible matches are displayed within an onscreen list. Tap an entry to launch the desired website.

Tip: You can also enter a search term into the field to perform a Web search.

2. Tap  on the keyboard to launch the new page.

Chrome Menu





The Chrome menu offers additional options to expand your use of the Web on your phone.

Open the Chrome Menu

The Chrome menu may be opened anytime you have an active data session, from any page you are viewing.

- ▶ From the Home screen, tap **Apps**  > **Chrome** > .

Options available within the Chrome menu may include:

-  : Returns you to the previously viewed page.
-  : Adds the currently viewed page to a bookmark.
-  : Show an information of the currently viewed page.
-  : Reloads the currently viewed page.
- **New tab**: Opens a new page as a new tab.
- **New Incognito tab**: Opens a new incognito page. Those pages you view in incognito tab will not appear in your browser history or search history, and they will not leave other traces, like cookies, on your phone after you close all open incognito tabs. Any bookmarks you create will be preserved.
- **Bookmarks**: Allows you to access and manage your bookmarks.
- **Recent tabs**: When you sign in Chrome, allows you to refer to the open tabs, bookmarks, and omnibox data from other devices logged in with the same account.
- **History**: Displays the browsing history.
- **Share...**: Allows you to share the current Web page via Bluetooth, Gmail, Message+, etc.
- **Print...**: Provides the printing options.
- **Find in page**: Searches the current Web page for a word.
- **Add to Home screen**: Creates a shortcut icon of the current page on the Home screen.
- **Request desktop site**: Displays the PC site of the current Web page.
- **Settings**: Lets you configure and manage your Chrome settings.
- **Help & feedback**: Opens a support page for Chrome.

Note: The Chrome menu options may vary depending on the version installed on your phone.

Select Text on a Web Page

You can highlight text on a Web page and copy it, search for it, or share it.

1. Scroll to the area of the Web page containing the text you want to select.
2. Touch and hold the text you want to copy. Drag the tabs to expand or reduce the range of the selected text. Any selected text will appear highlighted.

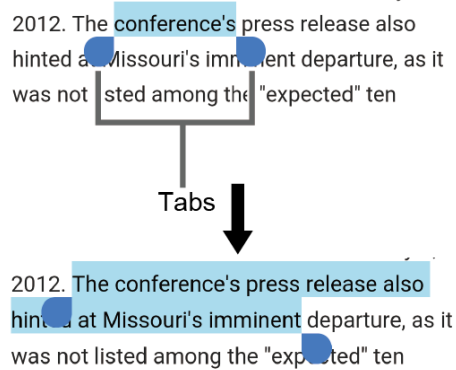

3. Select an option:
 - **COPY** to copy the selected text.
 - **SHARE** to share the selected text via Bluetooth, Gmail, Message+, etc.
 - **SELECT ALL** to select all the text on the Web page.
 - Tap  for the following menus:
 - **WEB SEARCH** to launch a Web search for the selected text.
 - **ASSIST** to launch Now on tap to search using Google.



Manage Bookmarks

Make browsing easier by setting up and using custom bookmarks.

View Bookmarks

- ▶ From the Home screen, tap **Apps**  > **Chrome** >  > **Bookmarks**.

Create Bookmarks





1. From the Home screen, tap **Apps**  > **Chrome**.
2. Open the Web page you want to bookmark.
3. Tap  > .

Edit Bookmarks

1. From the Home screen, tap **Apps**  > **Chrome** >  > **Bookmarks**.

2. Touch and hold the bookmark you want to edit and tap .

– or –

1. From the Home screen, tap **Apps**  > **Chrome**.
2. Tap  >  on the Web page you want to edit the bookmark of.
3. Edit the bookmark. Tap  to remove the bookmark.

Mobile Hotspot



Mobile Hotspot allows you to turn your phone into a Wi-Fi hotspot. The feature works best when used in conjunction with data services.

Turn Mobile Hotspot On

Note: Use of this service requires a subscription. Follow the onscreen instructions to subscribe this service.

1. From the Home screen, tap **Apps**  > **Settings** > **Mobile Hotspot**.
2. Tap the **ON/OFF** switch next to **Mobile Hotspot** to turn it on.
 - If your phone's mobile data access is not enabled, you will be prompted to turn it on. Follow the onscreen instructions.
 - The first time you turn it on, you will be prompted to set up Mobile Hotspot.
3. Follow the onscreen instructions.

Set up Mobile Hotspot

1. From the Home screen, tap **Apps**  > **Settings** > **Mobile Hotspot** > **Set up Mobile Hotspot**.
2. Tap **Set up Mobile Hotspot**.
3. Edit the **Network SSID** (Service Set Identifier) field and then create a new Network SSID name.
4. Tap  in the Security field and verify the security level is set to **WPA2 PSK**.
5. Edit the **Password** field and then enter a new password.
6. Tap  in the Broadcast channel field and select the channel number from the list.
7. Tap **SAVE**.



8. Confirm the Hotspot active icon  appears at the top of the screen.

Note: The best way to keep using the phone as a hotspot is to have it connected to a power supply.

Tip: Once Mobile Hotspot has been turned on, your SSID and password will be displayed under "Mobile Hotspot."

Mobile Hotspot Settings

To set the timer for turning Mobile Hotspot off:

1. From the Home screen, tap **Apps**  > **Settings** > **Mobile Hotspot** >  > **Advanced** > **Timeout settings**.
2. Select a timer option.

To limit maximum connections:

1. From the Home screen, tap **Apps**  > **Settings** > **Mobile Hotspot** > **Set up Mobile Hotspot**.
2. Select the number of devices you will allow to connect.

To change the Mobile Hotspot network SSID or password:

1. From the Home screen, tap **Apps**  > **Settings** > **Mobile Hotspot** > **Set up Mobile Hotspot**.
2. Tap the Security field and select **WPA2 PSK**.
3. With security enabled, delete the previous network SSID or password and enter a new one into the field.
4. Tap **SAVE** to store the new settings.

Note: The more complex the password, the harder it will be for intruders to break your security. It is recommended that you not use names, birthdays, or other personal information.

Connect to Mobile Hotspot

1. Enable Wi-Fi (wireless) functionality on your target device (laptop, media device, etc.).
2. Scan for Wi-Fi networks from the device and select your phone's hotspot from the network list.
3. Select this device and follow the onscreen instructions to enter the passkey (provided on the Mobile Hotspot page).
4. Launch your web browser to confirm you have an Internet connection.

Note: You need to insert a nano SIM card in your phone to share your phone's data connection with other devices using USB/Bluetooth tethering and Mobile Hotspot for Internet access.

Note: Using both data service and Mobile Hotspot drains your phone's battery at a much faster rate than when using any other feature combination.

Tethering

You can share your phone's Internet connection via a USB cable or Bluetooth.

USB Tethering

You can tether your phone to your computer with a USB cable and share your phone's Internet connection with your computer.

1. From the Home screen, tap **Apps**  > **Settings** > **More** > **Tethering**.
2. Tap the **ON/OFF** switch next to **USB tethering** to turn it on.

Note: Use of this service requires a subscription. Follow the onscreen instructions to subscribe this service.

Bluetooth Tethering

You can share your phone's Internet connection with Bluetooth devices via Bluetooth.

1. From the Home screen, tap **Apps**  > **Settings** > **More** > **Tethering**.
2. Tap the **ON/OFF** switch next to **Bluetooth tethering** to turn it on.
3. Pair your phone with a Bluetooth device. If they are already paired, establish their connection. See [Connect a Bluetooth Headset or Car Kit](#) or [Reconnect a Headset or Car Kit](#) for details.

Camera and Camcorder

You can use the camera or camcorder to take and share pictures and videos. Your phone comes with an 13.0 megapixel back camera and 5.0 megapixel front camera with an autofocus feature that lets you take sharp pictures and videos.

Use the Camera App

The following topics teach you how to take pictures and record videos.

Open or Close the Camera App

The first step to take a picture or record a video is to open the camera app.

Open the Camera App

- ▶ Press and hold the camera button on the lower right side of the phone.
- or –
- From the Home screen, tap **Apps**  > **Camera**.

Close the Camera App

- ▶ On the camera screen, press Home button or Back button .

Viewfinder Screen

The viewfinder screen lets you view your subject and provides controls and options for taking pictures or recording videos.

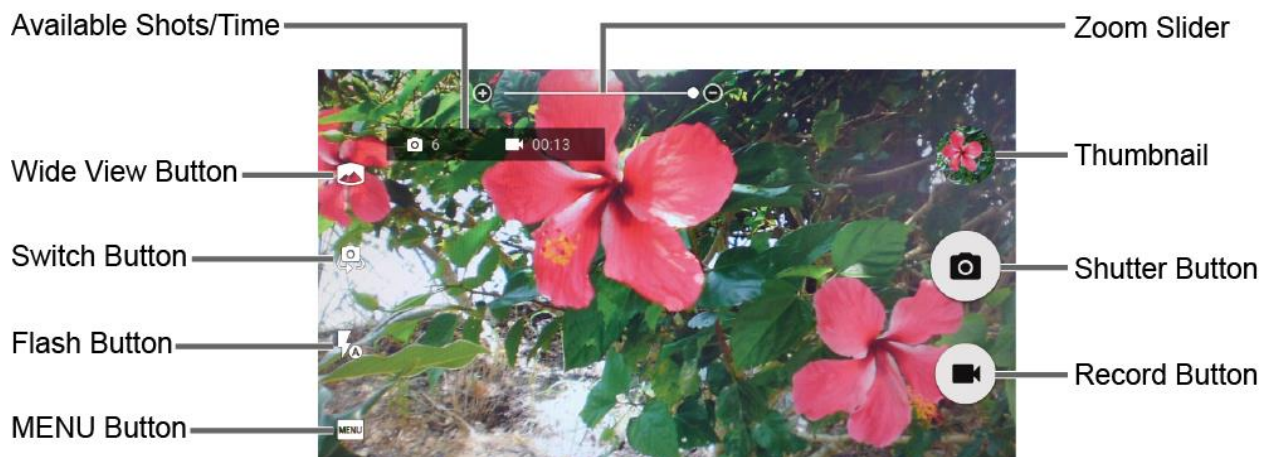

- **Zoom Slider**: Adjusts your zoom level.
- **Thumbnail**: Displays the thumbnail of the latest image. Tap to view and manage.

- **Shutter Button:** Takes a picture.
- **Record Button:** Records a video.
- **MENU Button:** Opens the camera and camcorder settings menu. For more information, see [Camera and Camcorder Settings](#).
- **Flash Button:** Helps illuminate subjects in low-light environments.
- **Switch Button:** Switches between the back camera and the front camera.
- **Wide View Button:** Switches between the back camera and the wide view camera.
- **Available Shots/Time:** Displays remaining shots/time with the current settings. This setting appears only if the available memory drops below 500 MB.

Take a Picture or Record a Video

You can record high quality images with your phone's camera and camcorder.

1. Press and hold the camera button on the lower right side of the phone.

– or –



From the Home screen, tap **Apps**  > **Camera**.

2. Do the following to change the settings:
 - Tap  to switch between the front camera and the back camera.
 - Tap **MENU** to change the camera and camcorder settings as desired. See [Camera and Camcorder Settings](#).
 - Pinch or spread to display the slider and zoom in or out on the slider, to zoom in or out on your subject. You can also press the Volume button up or down to zoom in or out.
 - Tap any point to focus the area.
3. Frame your subject on the screen.

Tip: Hold the phone vertically when taking portrait shots or hold the phone horizontally when taking landscape shots.

4. Tap , or press the camera button, to take a picture.

– or –

Tap  to record a video. Tap  or  to pause or resume recording. To stop recording, tap .

5. Choose what you want to do with the image you've just taken or recorded. See [Review Screen](#) to follow.

Review Screen

After taking a picture or video, tap the thumbnail image to see the item in the review screen. From there, you can instantly share your photos or videos (see [Share Pictures and Videos](#)) or tap the Photos icon to edit your photos or replay your videos (see [View Pictures and Videos Using Photos](#)).

To review the image:

- ▶ Tap the thumbnail image on the screen.

To display options for the displayed image:

- ▶ Tap the image to display available options.

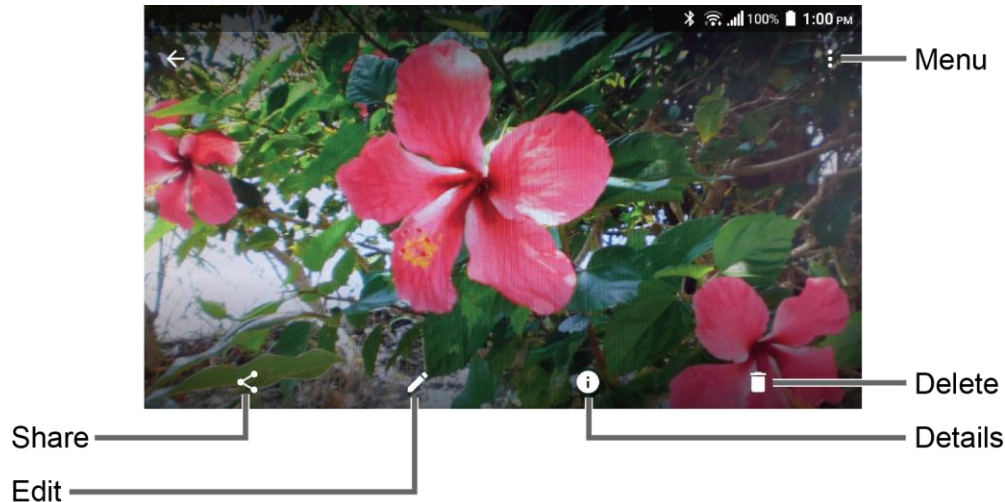

- **Menu:** Displays available menus for the image. Available menus may vary:
 - **Slideshow:** Starts the slideshow of the pictures stored in the Photos application.
 - **Use as:** Sets the picture as the contact photo or wallpaper.
 - **Print:** Prints the selected picture.
- **Delete:** Deletes the currently displayed image. Tap **DELETE** to confirm the deletion.
- **Details:** Shows the details of the picture.
- **Edit:** Displays the editing options. For details, see [Edit a Picture](#).
- **Share:** Displays available applications to share your image.

Underwater Mode

You can take a picture or record video also in the water. Your phone is immersible in water for up to 30 minutes at a depth not exceeding two meters (about 6.56 f).

1. From the Home screen, tap **Apps**  > **Camera** > **MENU** > **Mode** > **Underwater**.

Tip: When “Underwater detection” is set to on, your Camera will change automatically to Underwater Mode.

2. In Underwater Mode, the following physical keys are used instead of touch screen icons.
 - **Camera button** to take a picture.
 - **PTT/Programmable button** to start/stop recording a video.
 - **Speaker button** to open or close the menu screen.
 - **Volume button** up/down to zoom in/out or scroll through the options.

Warning: Before immersing your phone in the water, make sure all ports and covers are properly seated, with no foreign objects obstructing the seals, to maintain the waterproof capability. The phone should never be used under water with broken or open SIM/microSD slot cover.

Note: After using your phone in the Underwater Mode, immediately rinse the phone gently in clean fresh water. The phone should be dried using a very specific procedure. See [Drying Your Phone](#).

Camera and Camcorder Settings

You can adjust the settings of your camera and camcorder by tapping **MENU** on the viewfinder screen. Some options are available for the back camera or camcorder only.

- **Auto:** Takes a picture using the recommended settings.
- **Manual:** Customizes settings for taking photos and videos.
- **Mode:** Select from **Effect**, **Panorama**, **Underwater**, **Slow motion**, **Time lapse**, **Night**, **view** or **Sports**.
 - **Effect:** Adds an effect to the picture.
 - **Panorama:** Takes a panorama picture as you pan the phone sideways.
 - **Underwater:** Allows you to take a picture under water.
 - **Slow motion:** Records a video or view in slow motion.
 - **Time lapse:** Selects the time lapse recording setting from 1s, 2s, 3s, 5s, or 10s.

- **Night view:** Takes a picture or records a video with the night effect.
- **Sports:** Takes a picture or records a video of sports action.
- **Size:** Select from **16:9**, **4:3**, **1:1**, or **MMS**.
- **HDR:** Takes a series of pictures at different exposure levels and combines them into a single image (back camera only). Select **On**, **Off** or **Auto**. Select **Save original photo** check box to save the original image.
- **Image stabilization:** Select **On** or **Off**.
- **Grid:** Select from **On** or **Off**.
- **Self timer:** Select from **Off**, **2 sec.**, **5 sec.**, or **10 sec.**.
- **Other settings:**
 - **Add location:** Stores the location information of the image. Select **On** or **Off**.
 - **Shutter sound:** Select **On** or **Off**.
 - **Camera key:** Select a function to assign to the camera key from **Photo** or **Video**.
 - **Audio recording:** Select **Unmute** or **Mute**.
 - **Storage:** Select where to store your pictures and videos from **Phone** or **SD card** (only available when the microSD card is inserted).
 - **Underwater detection:** Select **On** or **Off**.
 - **Reset settings:** Restores all the camera and camcorder settings to original state. Tap **RESET** to confirm.
 - **Help:** Displays the help information for camera.

Note: Available options may vary according to the subject and shooting/recording mode.

View Pictures and Videos Using Photos

Using the Photos application, you can view pictures and watch videos that you've taken with your phone's camera, downloaded, or copied onto your microSD card or phone's internal memory.

For pictures that are on your microSD card or phone's internal memory, you can do basic editing such as rotating and cropping. You can also easily assign a picture as your contact picture or wallpaper and share pictures with your friends.

Open or Close Photos

Open the Photos App

- ▶ From the Home screen, tap **Apps**  > **Photos**.

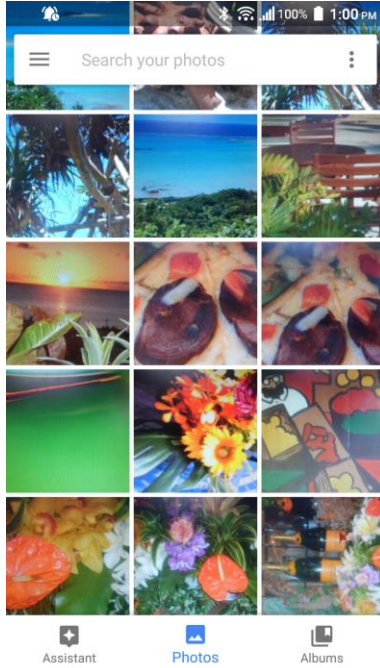

To view pictures and videos organized by category (Photos, Albums, etc.) or other applications, tap  and select an item.

When viewing pictures in Photos, scroll left or right to view more albums. Simply tap an album to view the pictures or videos in that album.

Note: Depending on the number of pictures stored, it may take some time for Photos to load all your albums on the screen.



Close the Photos App

- ▶ While in the Photos screen, press Home button.

View Pictures and Videos

After selecting an album, you can browse through the pictures and videos in grid view. Tap a picture or video to view.

1. From the Home screen, tap **Apps**  > **Photos**.
2. Tap an image to view a picture or video.

- For playing the video, tap . Tapping the other areas of the screen will display the control options. Tap  to pause the video, or drag the dot on the timeline to rewind or forward the video.

Zoom In or Out on a Picture

There are two ways you can zoom in or out on a picture.

- ▶ Tap the screen twice quickly to zoom in, and then tap the screen twice quickly again to zoom out.

– or –

Pinch the screen using your thumb and forefinger to zoom out or spread the screen to zoom in.

Work with Pictures

You can manage your pictures.

Picture Options Menu

Various options are available while viewing a picture. For details, see [Review Screen](#).

Edit a Picture



Your phone has a built in editing tool and you can alter your pictures easily.

1. Tap a picture and tap .





2. Tap a thumbnail for the labeled effect.
 - **Effect:** Displays options to **Auto**, **Light**, **Color**, **Pop**, or **Vignette**.
 - **Auto:** Optimizes the picture quality automatically.
 - **Light:** Displays the brightness slider.
 - **Color:** Displays the slider to adjust the saturation.
 - **Pop:** Displays the level correction slider.
 - **Vignette:** Displays the slider to adjust the vignette.
3. When finished, tap .

Rotate and Save a Picture

1. Tap the picture you want to rotate.
2. Tap  >  > .

Crop a Picture

1. Tap the picture you want to crop.
2. Tap  > . A crop box appears on the picture.
3. To adjust the crop box size, touch and hold the edge of the box, and drag your finger inward or outward to resize the crop box.
4. To move the crop box to the part of the picture that you want to crop, drag the crop box to the desired position.
5. Tap  to apply the changes to the picture.

The cropped picture is saved in the album as a copy. The original picture remains unedited.

Share Pictures and Videos

The Photos application lets you send pictures and videos using email or multimedia messages. You can share pictures on your social networks. You can also send them to another phone or your computer using Bluetooth. You can see some of the examples to share your pictures and videos below.

Send Pictures or Videos by Email/Gmail

You can send several pictures, videos, or both in an email or Gmail message. They are added as file attachments to your email.



1. Touch and hold the picture or video to place a check mark on it. Tap multiple pictures and videos to select them.
2. Tap  > **Gmail** or **Email**.
3. Compose your message and send a message.

Note: If you have multiple accounts, the default account will be used.

For more information about sending email and Gmail, see [Compose and Send Email](#) or [Send a Gmail Message](#).

Send Pictures or Videos by Message+

You can send pictures and videos using the Message+ app. Although you can send several pictures or videos, it may be better to just send one at a time, especially if the files are large in size.

1. Touch and hold the picture or video to place a check mark on it. Tap multiple pictures and videos to select them.
2. Tap  > **Message+**.
3. Compose your message and then tap .

For more information about multimedia messages, see [Message+](#).

Send Pictures or Videos Using Bluetooth

You can select several pictures, videos, or both and send them to another phone or your computer using Bluetooth.

1. Touch and hold the picture or video to place a check mark on it. Tap multiple pictures and videos to select them.
2. Tap  > **Bluetooth**.
3. You'll be asked to turn on Bluetooth on your phone and connect to the receiving Bluetooth device so the files can be sent. For more information, see [Bluetooth](#).

Share Videos on YouTube

You can share your videos by uploading them to YouTube™. Before you do this, you must create a YouTube account and sign in to that account on your phone.

1. Touch and hold the video to place a check mark on it. Tap multiple videos to select them.
2. Tap  > **YouTube**.

3. Enter the prompted information, such as title, description and tags, and select a privacy option.
4. Tap .

Tools and Calendar

Learn how to use many of your phone's productivity-enhancing features.



Calendar

Use Calendar to create and manage events, meetings, and appointments. Your Calendar helps organize your time and reminds you of important events. Depending on your synchronization settings, your phone's Calendar stays in sync with your Calendar on the Web, or the corporate calendar.

Add an Event to the Calendar

Add events to your calendar directly from the Calendar application.

Add an Event

1. From the Home screen, tap **Apps**  > **Calendar**.
2. On any Calendar view, tap .
3. If you have multiple calendars, select a calendar to add the event to.

Note: You can create multiple Google Calendars only in Google Calendar on the Web. After creating them in Google Calendar on the Web, you'll be able to see them in the Calendar application on your phone. For more information about creating and managing multiple Google Calendars, visit the Google website: calendar.google.com.



Note: If you have synchronized your phone with an Exchange ActiveSync account or Outlook on your computer, you can also select these calendars.

4. Enter the event name.
5. Enter the event location.
6. Specify the date and time of the event:
 - If there is a time frame for the event, tap the **From** and **To** dates and times to set them.
 - If the event is a special occasion such as a birthday or an all-day event, set the **From** and **To** dates, and then select the **All day** check box.
 - To change the time zone, tap the time zone field and select an option from the displayed list or type a country name.

7. Enter email addresses to invite guests to your event and add the event descriptions. See [Invite Guests to Your Calendar Event](#).
8. If the event occurs on a regular basis, tap the **Repetition** field and set the frequency.
9. Set the event reminder time and select how you are notified.
 - If you do not want any reminder, tap  next to the **Reminders** field.
 - Tap **Add reminder** to add another reminder.
10. Select your status to be displayed on your calendar.
11. Set the privacy status of this event.
12. Tap **DONE**.

Add a Task

Note: The task feature is available for Exchange ActiveSync accounts only.

1. From the Home screen, tap **Apps**  > **Calendar**.
2. On any Calendar view, tap  > **TASK**.
3. If you have multiple calendars, select a calendar to add the task to.
4. Enter the title of the task.
5. Enter the description.
6. Set the due date of the task.
 - Select the **No due date** check box if the task has no due date.
7. If the task occurs on a regular basis, tap the **Repetition** field and set the frequency.
8. Set the date and time to remind the task.
 - Select the **No reminder** check box if you do not want any reminder for the task.
9. Set the priority of the task.
10. Tap **DONE**.

Invite Guests to Your Calendar Event

If you want to invite guests to your event, you need to create and add the event.

An email invitation will be sent to your guests using your account.

1. Open Calendar and create a new event. Tap the Calendar field and then select your calendar. See [Add an Event to the Calendar](#).
2. Add details about the event, such as date and time, location, and more.
3. In the **Guests** field, enter the email addresses of everyone you want to invite to the event. Separate multiple addresses with commas.
4. Add the description of the event to be displayed on the email to your guests.
5. Tap **DONE** to add the event to your calendar.

People whom you have sent invitations to will receive it by email and in Calendar.

Calendar Event Alerts

When your phone is turned on and you have an event alarm scheduled, your phone alerts you and displays the event summary. There are several ways your phone alerts you to scheduled events:

- By playing the assigned ringtone or vibration type.
- By showing  on the status bar.
- By showing the Pop-up notification screen.

Event Reminders





If you have set at least one reminder for an event, the upcoming event icon  will appear in the notifications area of the status bar to remind you of the upcoming event.

To view, dismiss, or snooze the reminder:

1. Slide the status bar down to open the Notifications panel.

Note: If you have other pending event reminders, these events will also appear on the screen.

2. Do one of the following:
 - Tap **SET SNOOZE DURATION** to set the snooze interval.
 - Tap **SNOOZE** under the event name to postpone the event reminder for five minutes.
 - Tap **DISMISS** to dismiss the reminder.
 - Tap the event name to access the reminder settings.
 - View or edit the reminder settings.
 - Tap  to assign a color to the event.

- Tap  to share the event.
- Tap  to access the settings screen of the event.
- Tap  > **OK** to delete the event.
- Press  to keep the reminder pending in the notifications area of the status bar.







To set reminder settings:



- ▶ On any Calendar view, tap  > **Settings** > **General settings**, and set the items under **Notifications & reminders**.

View Calendar Events

You can display the Calendar in yearly, monthly, weekly, daily, agenda or task view. To change the Calendar view, tap  displayed at the upper left corner, and tap **Year**, **Month**, **Week**, **Day**, **Agenda**, or **Task**.



The color of the events indicates the type of calendar that includes the event. To find out what each color represents, tap  > **Calendars to display**.

- **Year:** Year view displays the calendar of this year.
 - Tap on each month to view the month view.
 - Tap  or , or slide right or left across the screen, to view earlier or later years.
- **Month:** Month view displays markers on days that have events.
 - Tap the today icon on the top right to highlight the current day.
 - Tap a day to view the events of that day.
 - Tap  or , or slide right or left the screen, to view earlier or later months.
- **Week:** Week view displays a chart of the events of one week.
 - Touch and hold on a time slot to create a new event at that time.
 - Tap an event to view its details.
 - Tap  or , or slide right or left across the screen, to view earlier or later weeks.
- **Day:** Day view displays a list of the events of one day.
 - Touch and hold on a time slot to create a new event at that time.
 - Tap an event to view its details.

- Tap  or , slide right or left across the screen to view earlier or later days.
- **Agenda:** Agenda view shows a list of all your events in chronological order.
- **Task:** Task view shows a list of all your tasks in chronological order.



Edit Calendar Events

Edit your calendar events to keep your calendar up to date.

1. From the Home screen, tap **Apps**  > **Calendar**.
2. Open the calendar event details:
 - In **Agenda**, **Day**, and **Week** views, tap the calendar event you want to edit.
 - In **Month** view, tap the date where the calendar event occurs, and then tap the calendar event.
3. Tap . If it is a recurring event, select **Change only this event**, **Change all events in the series**, or **Change this and all future events**.
4. Modify the event and tap **DONE**.

Erase Calendar Events

It's easy to erase scheduled events from your calendar.

1. From the Home screen, tap **Apps**  > **Calendar**.
2. Open the calendar event details:
 - In **Agenda**, **Day**, and **Week** views, tap the calendar event you want to delete.
 - In **Month** view, tap the date where the calendar event occurs, and then tap the calendar event.
3. Tap .
4. If the calendar event is recurring, select **Only this event**, **This and future events**, or **All events in the series**.
5. Tap **OK**.

Show or Hide Calendars

If you have more than two calendars available, you can choose to show or hide a calendar from your current view.

1. From the Home screen, tap **Apps**  > **Calendar**.

2. In any Calendar view, tap  > **Calendars to display**, and then select or clear a calendar to show or hide it.



Synchronize Calendars with Your Phone

You can choose which Google Calendars to keep synchronized on your phone or which ones to stop synchronizing.

Synchronize a Google Calendar

1. From the Home screen, tap **Apps**  > **Settings** > **Accounts**.
2. Tap the account you want to sync with.
3. Tap **Calendar** to turn on.

- or -

1. From the Home screen, tap **Apps**  > **Calendar**.
2. Tap  > **Calendars to display** > **CALENDARS TO SYNC**.
3. Tap the **ON/OFF** switch next to the Google Calendar you wish to synchronize.
4. Tap **OK**.

Synchronize a Corporate Calendar





If you have set up a corporate account on your phone, you can also synchronize corporate calendar events on your phone. Calendar events on your corporate account will also show in Calendar if you chose to synchronize with the Exchange ActiveSync Server.

Clock



The Clock application functions as a world clock that shows the date and time. You can also use it to turn your phone into an alarm clock, a countdown timer, or a stopwatch.

World Clock

You can add the time from around the globe on the World Clock screen.

1. From the Home screen, tap **Apps**  > **Clock**.
2. Tap **WORLD CLOCK** > , and select the check box next to the city you want to display on the Clock screen.
3. Press  or tap  in the top-left corner of the screen to confirm.
 - The selected cities will be displayed at the top of the city list.

World Clock Settings

1. From the Home screen, tap **Apps**  > **Clock** > .
2. The following options are available:
 - **Style:** Select the style of the clock to display. Choose from: **Analog** or **Digital**.
 - **Automatic home clock:** Check to add a clock with your home time to the screen while traveling in a different time zone.
 - **Home time zone:** Select the time zone for your home time.



Alarm

You can use your phone as an alarm clock. Simply tap the **ON** or **OFF** icon next to an alarm to turn it on or off.

Set an Alarm

1. From the Home screen, tap **Apps**  > **Clock**.
2. Tap the **ALARM** tab to display the Alarms screen, if necessary.

Note: When you first open the alarms, three alarms are set up by default and ready for you to customize. These alarms are turned off by default.



3. Tap an existing alarm time to change the settings.
– or –
Tap  to add a new alarm.
4. Set the time to set off the alarm and tap **OK**. You will see the **ON** icon displayed next to the time you have set.
5. Tap **Add label** to add a description to the alarm.
6. To set the alarm on a regular basis, select the **Repeat** check box and select the day(s) of the week to repeat the alarm.
7. Tap  to select a ringtone that will play as an alarm.
8. Select the **Vibrate** check box to add a vibration feature to the alarm.

Delete an Alarm

1. From the Home screen, tap **Apps**  > **Clock**.
2. Tap the **ALARM** tab to display the Alarms screen, if necessary.







3. Tap **DELETE** on the alarm you want to delete.

Alarms Settings

1. From the Home screen, tap **Apps**  > **Clock** > .
2. The following options are available:
 - **Alarm volume:** Set the volume of the alarm.
 - **Snooze length:** Set the interval between the snoozes.
 - **Silence after:** Select the duration of the alarm to sound.
 - **Key behavior:** Select the behavior of the RECENT/HOME/BACK/CAMERA/Volume key when pressed while the alarm sounds. Choose from: **Silence**, **Snooze**, **Dismiss**, or **Do nothing**.
 - **Default alarm sound:** Select the default alarm sounds.
 - **Start week on:** Select the day that the week starts on the alarm.





Timer

You can use your phone as a countdown timer.

1. From the Home screen, tap **Apps**  > **Clock**.
2. Tap the **TIMER** tab to display the Timer screen, if necessary.
3. Set the countdown time and tap  to start the countdown.
4. The following options are available:
 - **Add label** to add a description to the timer.
 -  to stop the countdown.
 -  to resume the countdown.
 - **+1 MIN** to add an extra minute to the remaining time.
 - **-1 MIN** to subtract a minute from the timer.
 - **RESET** to return to the start of the countdown.
 -  to delete the timer.
 -  to add a new timer.



Stopwatch

You can use your phone as a stopwatch.

1. From the Home screen, tap **Apps**  > **Clock**.
2. Tap the **STOPWATCH** tab to display the Stopwatch screen, if necessary.
3. Tap  to start the stopwatch.
4. The following options are available:
 - **LAP** to record the lap time.
 -  to stop timing.
 -  to resume timing.
 - **SHARE** to share the recorded time via Message+, Bluetooth, etc.
 - **RESET** to reset the stopwatch.

Calculator

Your phone has a convenient calculator that lets you perform basic mathematical equations.

1. From the Home screen, tap **Apps**  > **Calculator**.
2. Enter numbers by tapping the onscreen keys.
3. Tap **DEL** to clear a number. Touch and hold to clear an entire number.
 - To access more advanced features, flick the screen left.
4. Press  to close the calculator.

Flashlight

Your phone's camera flash can work as a flashlight.

Warning: Do not shine the flashlight into anyone's eyes, as doing so may compromise their vision and cause an accident.







1. From the Home screen, tap **Apps**  > **Flashlight**.
2. Tap the **ON/OFF** switch to turn on or off.
3. The following options are available:
 - **Blink speed:** Set the blink speed of Flashlight.

- **Brightness:** Set the Flashlight brightness.
- **Light time setting:** Set the Flashlight interval. Select from **1minute**, **3minutes**, **5minutes**, **10minutes**, or **Never turn off**. Tap  at the top left of the screen to display menu.

Sound Recorder

The Sound Recorder app lets you record sound and save it as an audio file on your phone or the inserted microSD card.





Record Sound

1. From the Home screen, tap **Apps**  > **Sound Recorder**.
2. Tap  > **File format** to select the format type. Select **Normal** or **High quality**.
3. Tap  > **Storage** to select where to save the recorded data. Select **Phone** or **SD card**.
4. Tap  to start recording.
 - Tap  to pause recording. Tap  to resume recording.
5. Tap  to stop recording.



Play Audio Data

1. On the screen where you finished recording, tap .



– or –

From the Home screen, tap **Apps**  > **Sound Recorder** >  and then tap a file.
2. The following options are available:
 - Drag the bar to rewind or fast-forward the data.
 - Tap  to display the list of the stored files. See [Stored Sound List Options](#) to follow.
 - Tap  > **Share** to share the file via **Bluetooth**, **Gmail**, **Message+**, etc.
 - Tap  > **Delete** > **OK** to delete the file.

Stored Sound List Options

1. From the Home screen, tap **Apps**  > **Sound Recorder**.
2. Tap  to display the list of the stored files.

3. The following options are available:

- Tap  to delete a file or files. Tap a file or files to select the file(s) you want to delete and tap **OK**. To select all files on the list, tap **SELECT ALL**.
- Tap  next to each file:
 - **Share** to share the file via **Bluetooth**, **Gmail**, **Message+**, etc.
 - **Delete** to delete the file.
 - **Edit file name** to rename the file.
 - **Details** to display the information about the audio file.

Voice Services

Your phone's voice services let you place calls using your voice, convert text into speech, and more.

Text-to-Speech

Your phone can convert text into speech in certain downloaded applications. You may select the language you hear or adjust its speed.

1. From the Home screen, tap **Apps**  > **Settings** > **Language & input**.

– or –

From the Home screen, tap **Apps**  > **Settings** > **Accessibility**.

2. Tap **Text-to-speech output**. The **Default language status** section shows if the selected default system language is supported by the Text-to-speech system or not.
3. Select your preferred engine. Tap  next to the selected engine to configure the settings.
4. Tap **Speech rate** and select a speed.
5. Tap **Speech pitch** and select the tone of the spoken text.
6. Tap **Listen to an example** to play a short demonstration of the set speech synthesis.

Voice Search

Voice Search allows you to find information on the web as well as items and information on your phone by speaking your search terms.

1. Tap  on the Google search bar.





– or –

From the Home screen, tap **Apps**  > **Voice Search**.

2. Speak clearly into the phone's microphone when you see **Listening...** on the screen. If an error occurs, try again.
3. Tap a matching item from the onscreen list.

Eco Mode

The Eco Mode allows you to save battery life while using your phone.

1. From the Home screen, tap **Apps**  > **Eco Mode**.
2. Tap an option to enable or disable the Eco Mode:
 - **ON:** Enables the Eco Mode. The Eco Mode On icon  appears on the status bar when selected.
 - **OFF:** Disables the Eco Mode.
3. Tap  to configure the following options. Tap the following items to place or clear a check mark in the adjacent checkbox:
 - **Sleep** to sleep after 15 seconds. Tap  to change the time to elapse before entering sleep mode.
 - **Brightness** to decrease the display brightness. Tap  to change the Brightness settings.
 - **Auto-rotate screen** to turn off automatic screen rotation.
 - **Wi-Fi** to set it OFF.
 - **Bluetooth** to disable it.
 - **Location access** to disable it.
 - **NFC (Reader/Writer, P2P)** to disable it.
 - **CPU clock restriction** to restrict it.
 - **Data Communication** to disable mobile data communication.
 - **Exchange account** to disable Sync settings in Exchange account.

Note: Tap  > **Auto set** to set the time of the day and battery level at which eco mode turns on automatically.

Configured settings in the Eco Mode are automatically reflected in the respective Settings menu, and vice versa.

Bluetooth

Bluetooth is a short-range communications technology that allows you to connect wirelessly to a number of Bluetooth devices, such as headsets and hands-free car kits, and Bluetooth-enabled handhelds, computers, printers, and wireless phones. The Bluetooth communication range is usually approximately 30 feet.

Turn Bluetooth On or Off

Use the settings menu to enable or disable your phone's Bluetooth capabilities.

1. From the Home screen, tap **Apps**  > **Settings** > **Bluetooth**.
2. Tap the **OFF** icon next to **Bluetooth** to turn Bluetooth on.



– or –

Tap the **ON** icon next to **Bluetooth** to turn Bluetooth off.

Note: Turn off Bluetooth when not in use to conserve battery power, or in places where using a wireless phone is prohibited, such as aboard an aircraft and in hospitals.

The Bluetooth Settings Menu

The Bluetooth settings menu gives you access to information and controls for your phone's Bluetooth feature.

- ▶ From the Home screen, tap **Apps**  > **Settings** > **Bluetooth**.
 - Tap  for the following menus:
 - **Refresh** to search for other visible in-range Bluetooth devices.
 - **Rename this device** to rename your phone for Bluetooth access.
 - **Show received files** to view all files you have received via Bluetooth.
 - **Save to** to select the location to store the files to be received via Bluetooth.
 - **Help** to access the help menus for Bluetooth.

Change the Phone Name

The phone name identifies your phone to other devices.

1. From the Home screen, tap **Apps**  > **Settings** > **Bluetooth**.
2. If Bluetooth is not switched on, tap the **OFF** icon to turn Bluetooth on.

3. Tap  > **Rename this device**.
4. Enter the name for your phone in the dialog box, and then tap **RENAME**.



Connect a Bluetooth Headset or Car Kit

You can listen to music over a Bluetooth stereo headset, or have hands-free conversations using a compatible Bluetooth headset or car kit. It's the same procedure to set up stereo audio and hands-free devices.

To listen to music with your headset or car kit, the headset or car kit must support the A2DP Bluetooth profile.

Important: Perform the pairing process at a secure location.

Important: It is recommended to use a passcode of at least eight digits for pairing with a device without a pre-defined PIN.

1. From the Home screen, tap **Apps**  > **Settings** > **Bluetooth**.
2. If Bluetooth is not switched on, tap the **OFF** icon to turn Bluetooth on. Your phone will show a list of nearby Bluetooth devices.
3. If you don't see your device listed, tap  > **Refresh**. Your phone will start to scan for Bluetooth devices within range.
 - Make sure that the headset is discoverable, so that your phone can find the headset. Refer to the instructions that came with the headset to find out how to set it to discoverable mode.
4. When you see the name of your headset displayed on the **Available devices** list, tap the name. Your phone then automatically tries to pair with the headset.
5. If necessary, tap **PAIR** or enter the passcode supplied with your headset.
 - Tap  next to the paired device to display the information of the device. To change the name, edit the name and then tap **OK**.

The pairing and connection status is displayed below the hands-free headset or car kit name in the Bluetooth devices section. When the Bluetooth headset or car kit is connected to your phone, the Bluetooth paired icon  is displayed in the status bar. Depending on the type of headset or car kit you have connected, you can then start using the headset or car kit to listen to music or make and receive phone calls.

Note: Due to different specifications and features of other Bluetooth-compatible devices, display and operations may be different, and functions such as transfer or exchange may not be possible with all Bluetooth-compatible devices.

Reconnect a Headset or Car Kit

When you have paired a headset with your phone, you should be able to reconnect it automatically by turning on Bluetooth on your phone and then turning on the headset. However, sometimes you will need to reconnect manually, for example if you have been using your headset with another Bluetooth device.

1. From the Home screen, tap **Apps**  > **Settings** > **Bluetooth**.
2. If Bluetooth is not switched on, tap the **OFF** icon to turn Bluetooth on.
3. Make sure that the headset is discoverable.
4. Tap the headset's name in the Paired devices list.
5. If prompted to enter a passcode, try 0000 or 1234, or consult the headset or car kit documentation to find the passcode.
6. If you still cannot reconnect to the headset or car kit, follow the instructions in [Disconnect or Unpair from a Bluetooth Device](#) to follow, and then follow the instructions in [Connect a Bluetooth Headset or Car Kit](#).

Disconnect or Unpair from a Bluetooth Device



You can manually disconnect or unpair from a Bluetooth device through the Bluetooth settings menu.

Disconnect a Bluetooth Device

1. From the Home screen, tap **Apps**  > **Settings** > **Bluetooth**.
2. On the **Paired devices** list, tap the device to disconnect.
3. Tap **OK**.

Unpair from a Bluetooth Device

You can make your phone forget its pairing connection with another Bluetooth device. To connect to the other device again, you may need to enter or confirm a passcode again.

1. From the Home screen, tap **Apps**  > **Settings** > **Bluetooth**.
2. On the **Paired devices** list, tap  next to the device to unpair.
3. Tap **FORGET**.



Send and Receive Information Using Bluetooth

You can use Bluetooth to transfer information between your phone and another Bluetooth-enabled device such as a phone or notebook computer. The first time you transfer information

between your phone and another device, you need to enter or confirm a security passcode. After that, your phone and the other device are paired, and you will not need to exchange passcodes to transfer information in the future.

Send Information from Your Phone to Another Device

You can send the following types of information, depending on the device you are sending to:

- Images and videos
 - Contacts
1. Set the receiving device to discoverable mode. You may also need to set it to "Receive Beams" or "Receive Files". Refer to the device's documentation for instructions on receiving information over Bluetooth.
 2. On the phone, open the application that contains the information or file you want to send.
 3. Follow the steps for the type of item you want to send:
 - **Picture or video** (in Camera): After taking a picture or video, tap the thumbnail and then tap  > **Bluetooth**.
 - **Pictures and videos** (in Photos): On the Albums screen, tap an album. Touch and hold a picture or video to place a check mark on it. Tap multiple pictures and videos to select them. Tap  > **Bluetooth**.
 - **Contacts**: Display a contact and tap  > **Share** > **Bluetooth**.
 4. If you are prompted to turn on Bluetooth, tap **Turn on**.
 5. Tap the name of the receiving device.
 6. If prompted, accept the connection on the receiving device, and enter the same passcode on both your phone and the other device, or confirm the auto-generated passcode.
 7. On the receiving device, accept the file.

Receive Information from Another Device

Your phone is capable of receiving a wide variety of file types with Bluetooth, including pictures, videos, or contacts.

1. From the Home screen, tap **Apps**  > **Settings** > **Bluetooth**.
2. If Bluetooth is not switched on, tap the **OFF** icon to turn Bluetooth on.
3. Tap your phone name to make your phone visible to unpaired devices.

4. On the sending device, send one or more files to your phone. Refer to the device's documentation for instructions on sending information over Bluetooth.
5. If prompted, enter the same passcode on both your phone and the other device, or confirm the auto-generated passcode. A Bluetooth authorization request is displayed on your phone. Tap **OK**.
6. When your phone receives a file transfer request notification, slide down the Notifications panel, tap the notification, and then tap **ACCEPT**.
7. When a file is transferred, a notification is displayed. To open the file immediately, slide down the Notifications panel, and then tap the relevant notification.

Supported Bluetooth Profiles

Following Bluetooth profiles are supported.

- **HSP:** Headset Profile
- **HFP:** Hand-free Profile
- **SPP:** Serial Port Profile
- **OPP:** Object Push Profile
- **PBAP:** Phone Book Access Profile
- **AVRCP:** Audio Video Remote Control Profile
- **GOEP:** Generic Object Exchange Profile
- **MAP:** Message Access Profile
- **HID:** Human Interface Device Profile
- **PAN:** Personal Area Networking Profile
- **A2DP:** Advanced Audio Distribution Profile
- **GATT:** Generic Attribute Profile
- **AVDTP:** Audio/Video Distribution Profile
- **AVCTP:** Audio/Video Control Transport Protocol Profile
- **GAVDP:** Generic Audio/Video Distribution Profile
- **HOGP:** HID over GATT Profile
- **DID:** Device ID Profile

Near Field Communication (NFC) Technology

NFC (Near Field Communication) technology is a short-range, wireless technology that lets you quickly and wirelessly exchange information between your phone and other NFC-enabled smartphones, smart accessories, and NFC-enabled access points. You can also use NFC technology to save, view, create, or change smart tags.

Depending on the applications that you have added to your phone, you might be able to use your phone as a transit pass or as an access pass, by tapping the back of your phone against an NFC-enabled access point, subject to applicable terms and conditions from the particular vendor.

Turn NFC On or Off

Use the settings menu to enable or disable your phone's NFC capabilities.

1. From the Home screen, tap **Apps**  > **Settings** > **More**.
2. Tap the **OFF** icon next to **NFC** to turn NFC on. If a security reminder appears, read it and tap **OK**.

– or –

Tap the **ON** icon next to **NFC** to turn NFC off.

The NFC Settings Menus

- ▶ From the Home screen, tap **Apps**  > **Settings** > **More** > **NFC**.
 - **Prompt for allowing NFC handovers:** Displays prompts for asking your permission to use other technologies such as Wi-Fi or Bluetooth for data exchange.
 - **Security reminders about NFC:** Displays reminders for using the NFC feature.
 - **Allow sharing of Wi-Fi info:** Lets you send Wi-Fi credentials to other devices for easy sign-in.

Android Beam

With Android Beam you can beam app content such as Browser pages, YouTube videos, and Contacts entries, to another NFC-capable device by holding the devices close together.

To turn Android Beam on or off:

1. From the Home screen, tap **Apps**  > **Settings** > **More**.
2. Tap the **OFF** icon next to **NFC** to turn NFC on, if it is off.
3. Tap **Android Beam**.

4. Tap the **OFF** icon to turn Android Beam on.

– or –

Tap the **ON** icon to turn Android Beam off.

To share app contents:

1. With Android Beam turned on, display the contents you want to share on your screen.
2. Bring your phone close to another NFC-enabled device, typically back to back aiming the NFC antenna, and then tap your screen. The app determines what gets beamed.



microSD Card

A microSD™ card is an optional accessory that allows you to store images, videos, music, documents, and voice data on your phone. Your phone supports a microSD card up to 200 GB.

Insert or Remove a microSD Card

Inserting a compatible microSD card into your phone will increase the storage capacity.

Note: microSD cards are sold separately.

To insert a microSD card:

1. If your phone is on, turn it off.
2. Remove the back cover by inserting your fingernail in the slit on the bottom of your phone and pulling away from the phone.

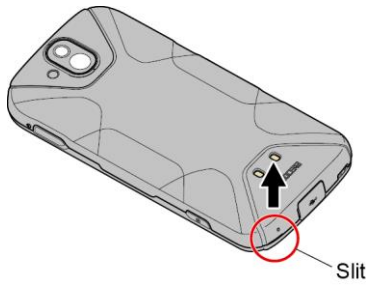

3. Open the SIM/microSD slot cover and insert a microSD card into the slot on the right with the gold terminals facing down. Gently push the card into the slot until it snaps into place.

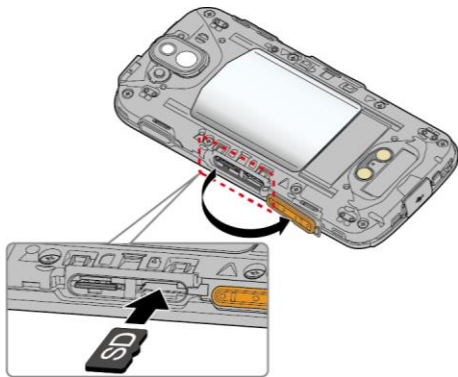

4. Securely close the SIM/microSD slot cover.

Warning: Be sure the SIM/microSD slot cover is properly sealed to maintain the phone's waterproof capability.

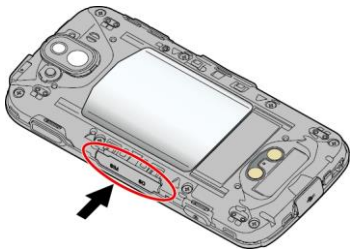

5. Replace the back cover. Press around the edges to ensure a proper fit.

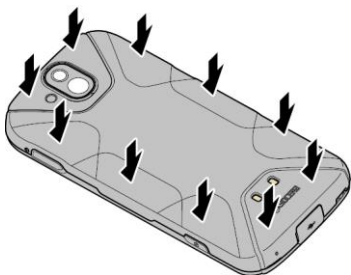

To remove a microSD card:

1. If your phone is on, turn it off.
2. Remove the back cover by inserting your fingernail in the slit on the bottom of your phone.
3. Locate and open the SIM/microSD slot on the side of the phone.
4. Push the microSD card so the card is partly ejected.
5. Securely close the SIM/microSD slot cover.

Warning: Be sure the SIM/microSD slot cover is properly sealed to maintain the phone's waterproof capability.

6. Replace the back cover. Press around the edges to ensure a proper fit.

Note: You can easily damage the microSD card by improper operation. Please be careful when inserting, removing, or handling the microSD card.

Note: Make sure your battery is fully charged before using the microSD card. Your data may become damaged or unusable if the battery runs out while using the microSD card.



View the microSD Card Memory

The Storage settings menu gives you access to your microSD card memory information.

1. With the microSD card installed, tap **Apps**  > **Settings** > **Storage & USB** > **SD card**.
2. The information of the SD card is displayed.

Format the microSD Card

Formatting a microSD card permanently removes all files stored on the card.

1. From the Home screen, tap **Apps**  > **Settings** > **Storage & USB**.
2. Tap **SD card** >  > **Settings** > **Format** or **Format as internal** > **ERASE & FORMAT** > **OK**.
 - **Format:** Select to use as portable storage.
 - **Format as internal:** Select to use as internal storage for this device only. After formatting, the SD card will only work in this device.

Note: The formatting procedure erases all the data on the microSD card, after which the files CANNOT be retrieved. To prevent the loss of important data, please check the contents before you format the card.

Unmount the microSD Card

Unmount the microSD card to prevent corrupting the data stored on it or damaging the microSD card.

1. From the Home screen, tap **Apps**  > **Settings** > **Storage & USB**.
2. Tap the eject icon .

Use the Phone's microSD Card as a Media Device



You can connect your phone as a media device to your computer.

1. Connect the phone to your computer using the supplied USB cable.
2. Swipe down from the top of the screen to open the Notifications panel.
3. Tap the USB connection notification > **File Transfer (MTP)**.
4. On your computer, the connected phone is recognized as a portable media device. Navigate to the device and select **SD card**.
5. Manage the data as you wish, unmount the phone as required by your computer's operating system to safely remove your phone, and disconnect the phone from the computer.

File Commander

With the File Commander application, you can manage the contents stored in the phone or on the microSD card (optional) quickly and easily.

To open the File Commander:

1. From the Home screen, tap **Apps**  > **File Commander**.
2. The following options are available.
 - **Pictures:** Stores still image files.
 - **Music:** Stores the audio files.
 - **Videos:** Stores video files.
 - **Documents:** Stores document files.
 - **Downloads:** Stores downloaded files.
 - : Adds a new category.
 - **Internal storage:** Displays the current status of the internal storage.

- **SD card:** Displays the current status of the microSD card.

To manage the contents (available options may vary):

- ▶ Tap a folder or file to access it. You can search or sort in the folder and file lists.
- ▶ Tap  for available options.

Supported Formats

Following image, video and audio formats are supported by the phone.

Image	Video	Audio	
• BMP	• H.263	• AAC	• MP3
• WBMP	• H.264	• AAC+	• Volbis
• GIF	• H.265	• eAAC+	• PCM (WAVE)
• JPEG	• MPEG-4	• AMR-WB	• Opus
• PNG	• VP8	• AMR-NB	• QCELP
• WEBP	• VP9	• FLAC	• EVRC
		• MIDI	

Outdoor Report

The Outdoor Report offers useful apps which provide important and interesting information for your outdoor activities. It also has shortcut buttons to access handy tools, such as compass, barometer or altimeter.

1. From the Home screen, tap **Apps**  > **Outdoor Report**.
2. Tap **NEXT** on the welcome screen and follow the on-screen prompts.
3. The following information is available:
 - **WEATHER:** Displays the weather information in 6 hour increments.
 - **SUNRISE/SUNSET:** Displays the current position of the Sun and the Moon.
 - **SOLUNAR:** Displays the peak activities of animals and wildlife according to the Moon phases.
 - **TIDE:** Displays the tide level according to the Moon phases.
 - **FISH INDEX:** Displays the peak activities of fish according to the Moon phases.

- **COMPASS:** Displays detailed Compass information.
- **BAROMETER/ALTIMETER:** Displays detailed Barometer/Altimeter information.
- **BAROMETER WEATHER:** Displays detailed Barometer weather information.
- **IMAGE:** Select the image to use on the screen.

Update Your Phone

From time to time, updates may become available for your phone. You can download and apply updates through the System update menu.

- ▶ From the Home screen, tap **Apps**  > **Settings** > **System updates**.
 - **Check for new system update:** Checks if there is any update for your phone.
 - **Show system update history:** Checks the update history.

Settings

The following topics provide an overview of items you can change using your phone's **Settings** menus.



Airplane Mode

Airplane Mode allows you to use many of your phone's features, such as Photos, Camera, and Music, when you are on an airplane or in any other area where making or receiving calls or data is prohibited. When you set your phone to Airplane Mode, it cannot send or receive any calls or access online information.

To quickly turn Airplane Mode on or off:

- ▶ Press and hold the Power button, and then tap **Airplane mode**. While in Airplane Mode, the status bar will display .

To turn Airplane Mode on or off in Settings:

1. From the Home screen, tap **Apps**  > **Settings**.
2. Tap the **OFF** icon to turn Airplane Mode on. If the **ON** icon is displayed, Airplane Mode is turned on and the status bar will display .

Wi-Fi Settings

The Wi-Fi settings menu lets you turn Wi-Fi on or off, set up and connect to available Wi-Fi networks, and configure advanced Wi-Fi options. For more information about the Wi-Fi settings, see [Wi-Fi](#).

Bluetooth Settings

Your phone's Bluetooth capabilities let you use wireless headsets, send and receive pictures and files, and more. For details on your phone's Bluetooth settings, see [The Bluetooth Settings Menu](#).

Mobile Hotspot

Mobile Hotspot allows you to turn your phone into a Wi-Fi hotspot. For details on your phone's Mobile Hotspot settings, see [Mobile Hotspot](#).

Data Usage Settings

The Data usage menu lets you view your phone's data usage and restrict hotspot usage.

Turn Mobile Data On or Off

1. From the Home screen, tap **Apps**  > **Settings** > **Data usage**.
2. Tap the **ON/OFF** switch next to **Mobile data access** to turn it on or off.

Limit Mobile Data Usage

You can set a limit to your data usage in case you don't have an unlimited data plan.

Warning: The usage displayed is measured by your phone. Your carrier's data usage accounting may differ and the usage in excess of your data limit plan can result in charges. The data usage limit set in this menu is not guaranteed to prevent additional charges.

1. From the Home screen, tap **Apps**  > **Settings** > **Data usage**.
2. Tap the **ON/OFF** switch next to **Limit Mobile data usage** to turn it on. Read the message and tap **OK**.
3. Drag the red tab vertically to set the limit you want.

– or –

Tap the red line, select the limit by scrolling the value and then tap **SET**.

- When your data usage reaches the limit, mobile data will be turned off automatically.

Alert About Data Usage

Your phone will warn you with an alert when the mobile data usage reaches a set level.



1. From the Home screen, tap **Apps**  > **Settings** > **Data usage**.
2. Tap the **ON/OFF** switch next to **Alert me about data usage** to turn it on. Read the message and tap **OK**.
3. Drag the gray tab vertically to set the level you receive a warning.

– or –

Tap the gray line, select the limit by scrolling the value and then tap **SET**.

- When your data usage reaches the set level, your phone will alert you.

Data Usage Options

1. From the Home screen, tap **Apps**  > **Settings** > **Data usage**.
2. Tap  for the following options:

- **Restrict/Allow background data** to restrict or allow background data usage.
- **Show/Hide Wi-Fi** to display or hide Wi-Fi usage.
- **Network restrictions** to set a Wi-Fi network as a metered connection.
- **Display in MB/GB** to display the memory in MB or GB.
- **Cellular networks** to configure cellular network settings.
- **Help** to access the help menus for Data usage.

Advanced Calling Settings

Advanced calling allows you to use HD Voice and Video calling of your phone's features.

More Settings

The Settings menu provides access to additional wireless and network options, such as mobile networks, VPN, roaming, NFC, and more.

NFC Settings

The NFC (Near Field Communication) settings menu lets you turn NFC on or off. For more information about the NFC settings, see [Near Field Communication \(NFC\) Technology](#).

Android Beam

Android Beam uses the NFC technology. For more information about the Android Beam settings, see [Android Beam](#).

Tethering Settings

Use the settings menu to configure your tethering settings, which allow you to share your phone's Internet connection using USB/Bluetooth tethering. For details on your phone's tethering settings, see [Tethering](#).

VPN Settings

A virtual private network (VPN) is a network that uses a public telecommunication infrastructure, such as the Internet, to provide remote offices or individual users with secure access to their organization's network. For more information about the VPN settings, see [Virtual Private Networks \(VPN\)](#).

Cellular Networks Settings

The Cellular networks options let you enable your phone's mobile data access, set your preferred network mode, and select network operators for international use.

Data Roaming Access

You can select the way in which your phone uses the data service while you are outside the US.

1. From the Home screen, tap **Apps**  > **Settings** > **More** > **Cellular networks** > **Data roaming access**.
2. Read the message carefully and select an option:
 - **Deny data roaming access:** Select if you never use data while you are roaming outside the US.
 - **Allow access only for this trip:** Select if you use data only on this occasion.
 - **Allow access for all trips:** Select if you use data while you are roaming outside the US.
3. Tap **OK**.

Roaming

You can view your roaming status.

1. From the Home screen, tap **Apps**  > **Settings** > **More** > **Cellular networks** > **Roaming**.
2. Tap **OK**.

Network Mode

You can select your preferred network mode with this menu.

1. From the Home screen, tap **Apps**  > **Settings** > **More** > **Cellular networks** > **Network mode**.
2. Select a network mode from **Global**, **LTE/CDMA**, or **LTE/GSM/UMTS**.

Signal Strength

You can view the type and the strength of the signal your phone is receiving.

- ▶ From the Home screen, tap **Apps**  > **Settings** > **More** > **Cellular networks** > **Signal strength**.

System Select



You can select how your phone roams in the CDMA network.

1. From the Home screen, tap **Apps**  > **Settings** > **More** > **Cellular networks** > **System select**.
2. Select a roaming mode.



Access Point Names

You can edit existing access points or add a new point.

To edit an existing access point:

1. From the Home screen, tap **Apps**  > **Settings** > **More** > **Cellular networks** > **Access Point Names**.
2. Tap  next to an access point you want to edit.
3. Edit the necessary fields and tap  > **Save**.

To restore the default settings:

1. From the Home screen, tap **Apps**  > **Settings** > **More** > **Cellular networks** > **Access Point Names**.
2. Tap  > **Reset to default** > **CONTINUE**.



Emergency Alerts

Your phone is compatible with the federally supervised cell phone alert services to send out broadcast SMS messages for public warning:

To display the Emergency Alerts:

- ▶ From the Home screen, tap **Apps**  > **Settings** > **More** > **Emergency Alerts**.

To configure the Emergency Alerts settings:

1. From the Home screen, tap **Apps**  > **Settings** > **More** > **Emergency Alerts** >  > **Settings**.
2. Following options are available:
 - **Presidential:** Receives an emergency presidential alert. (Presidential is always grayed out [not selectable] and cannot be excluded.)
 - **Extreme Alert:** Receives emergency alerts in an extreme emergency situation (an extraordinary threat to life or property).
 - **Severe Alert:** Receives emergency alerts in a severe emergency situation (a significant threat to life or property).
 - **Amber:** Receives alerts related to missing or endangered children.
 - **Help:** Displays the help information for Emergency Alerts.

- **Cellbroadcast Message:** Receives cellbroadcast message other than Emergency Alerts.
- **Notifications:** Receives notifications when you receive an emergency alert.
- **Sound:** Plays a sound when you receive an emergency alert.
- **Vibrate:** Vibrates your phone when you receive an emergency alert.
- **Alert reminder:** Sets how often your phone alerts you: Choose from **Once**, **Every 2 minutes**, **Every 15 minutes**, or **Off**.
- **Emergency notification preview:** Plays a sample emergency alert tone. Tap **STOP** to stop the sound.
- **Speak alert message:** Uses the text-to-speech feature to read out the emergency alert messages.



Call Settings

Your phone's Call settings menu lets you configure your Voice Mail options and a number of other settings for the phone application. See [Call Settings](#) for details.

Display Settings

Adjusting your phone's display settings not only helps you see what you want, but it can also help increase battery life.

Brightness level

1. From the Home screen, tap **Apps**  > **Settings** > **Display**.
2. Drag left or right the brightness slider next to  to adjust the screen brightness.

Adaptive brightness

Adjust your screen's brightness to suit your surroundings.

1. From the Home screen, tap **Apps**  > **Settings** > **Display**.
2. Tap the **ON/OFF** switch next to **Adaptive brightness** to turn it on or off.

Wallpaper

Select and assign your phone's background wallpaper. See [Change the Wallpaper](#).

Sleep





Select the delay time before the screen automatically turns off.

1. From the Home screen, tap **Apps**  > **Settings** > **Display** > **Sleep**.

2. Select a time to elapse before entering sleep mode.

Daydream

You can set a screen saver to your phone.

1. From the Home screen, tap **Apps**  > **Settings** > **Display** > **Daydream**.
2. If Daydream is not switched on, tap the **OFF** icon to turn it on.
3. Tap one of the below options:
 - **Clock** to display the phone's analog or digital clock. Tap  next to it and tap **Style** to select the clock style or select the **Night mode** option.
 - **Photos** to display the images as a slide show. Tap  next to it and select the images to display.
 - To see the preview, tap  > **Start now**.

Font Size

Choose the font size of the screen as you like.

1. From the Home screen, tap **Apps**  > **Settings** > **Display** > **Font size**.
2. Select your favorite size.

When Device is Rotated

Your phone is capable of automatically changing the orientation of some onscreen content. With this feature, you can view the screen in either portrait or landscape orientation by turning the phone sideways. By default, the screen orientation automatically changes when the phone is rotated.

To deactivate the Auto-rotate screen feature:

1. From the Home screen, tap **Apps**  > **Settings** > **Display**.
2. Tap **When device is rotated** > **Stay in portrait view**.



Key Backlight

Select the delay time before the key backlight automatically turns off.

1. From the Home screen, tap **Apps**  > **Settings** > **Display** > **Key backlight**.
2. Select a time to elapse before turning it off.

Cast

You can connect your phone to devices that support Miracast to share the displayed images via Wi-Fi connection.

1. From the Home screen, tap **Apps**  > **Settings** > **Display** > **Cast**.
2. If Wireless display is not switched on, tap  and select the **Enable wireless display** check box to turn it on. Available devices will be displayed.
3. Select a device you want to connect to from the list.

Note: For more information about wireless display, see the documentation that comes with the Miracast-certified device you wish to use with your phone.

Display Battery Percentage

Set your phone to display the battery percentage on the status bar.

1. From the Home screen, tap **Apps**  > **Settings** > **Display**.
2. Tap **Display battery percentage** to turn on.

Display Quick Settings

Set to enable or disable your phone to display the quick settings panel.

1. From the Home screen, tap **Apps**  > **Settings** > **Display**.
2. Tap **Display quick settings** to turn on.

Sound & notification Settings

The Sound & notification settings menu lets you control your phone's audio, from ringtones and alerts to tap tones and notifications.

Volumes

Configure your phone's volume settings.

1. From the Home screen, tap **Apps**  > **Settings** > **Sound & notification**.
2. Use the sliders to set the volume level for **Media volume**, **Alarm volume**, **Ring volume**, or **Notification volume**.

Tip: You can adjust the ring volume in standby mode (or the hearing volume during a call) using the volume button on the left side of your phone.

Also vibrate for calls

Set your phone to ring and vibrate simultaneously.

1. From the Home screen, tap **Apps**  > **Settings** > **Sound & notification**.
2. Tap **Also vibrate for calls** to turn on.



Do Not Disturb

Set the notification function.

1. From the Home screen, tap **Apps**  > **Settings** > **Sound & notification** > **Do not disturb**.
2. Tap the **ON/OFF** switch to turn on.
3. The following options are available:
 - **Settings** to choose whether to silence your device using **Priority only**, **Alarms only**, **Total silence**, or **Vibrate**.
 - **Priority only allows** to set your priority notification that will make a sound or vibrate based on your current settings.
 - **Automatic rules** to set up rules so that your device is automatically silenced during certain times.

Phone Ringtone

Assign a ringtone to your incoming calls.

1. From the Home screen, tap **Apps**  > **Settings** > **Sound & notification** > **Phone ringtone**.
2. If prompted, select an app to use and make your desired selection.
3. Tap a ringtone from the available list. The ringtone briefly plays when selected.
– or –
Tap  and select a sound data.
4. Tap **OK** to assign the ringtone.

Vibration Pattern

Select a vibration pattern.

1. From the Home screen, tap **Apps**  > **Settings** > **Sound & notification** > **Vibration pattern**.
2. Tap a vibrate pattern from the available list. Your phone briefly vibrates when selected.
3. Tap **OK** to assign the vibrate pattern.

Vibrate Intensity

Select your phone's vibration intensity.

1. From the Home screen, tap **Apps**  > **Settings** > **Sound & notification** > **Vibrate intensity**.
2. Tap a vibrate intensity from the list.
3. Tap **OK**.

Default Notification Ringtone

Select a sound for notifications.

1. From the Home screen, tap **Apps**  > **Settings** > **Sound & notification** > **Default notification ringtone**.
2. If prompted, select an app to use and make your desired selection.
3. Tap a notification sound from the available list. The sound briefly plays when selected.

– or –

Tap  and select a sound data.

4. Tap **OK** to assign the sound.

Other Sounds

Set your phone's notification tone feature with various options.

1. From the Home screen, tap **Apps**  > **Settings** > **Sound & notification** > **Other sounds**.
2. Make your desired selection.

Cast

You can connect your phone to devices that support Miracast to share the displayed images via Wi-Fi connection. See [Cast](#) for details.

Persistent Alerts

Set alerts, such as beep, vibration, or LED blinking for notifications.

1. From the Home screen, tap **Apps**  > **Settings** > **Sound & notification** > **Persistent alerts**.
2. Tap the **ON/OFF** switch to turn on or off.
3. Select the check box of the following:

- **Audible tone** to beep when notification is on the notification bar.
- **Vibrate** to vibrate when notification is on the notification bar.
- **Blink LED** to blink the LED indicator when notification is on the notification bar.
- **Repeat interval** to set the reminder interval.
- **App notifications** to modify the notification settings individually for apps.

When Device is Locked

Your phone is capable of showing the notifications on the screen when the phone is locked.

1. From the Home screen, tap **Apps**  > **Settings** > **Sound & notification** > **When device is locked**.
2. Make your desired selection.

App Notifications

You can modify the notification settings individually for apps.

1. From the Home screen, tap **Apps**  > **Settings** > **Sound & notification** > **App notifications**.
2. Tap apps you want to modify the notification settings.

Notification Access

You can control which apps have access to read your notifications.

1. From the Home screen, tap **Apps**  > **Settings** > **Sound & notification** > **Notification access**.
2. You will see a list of apps that can access your notifications.

Do Not Disturb Access

You can control which apps have access to **Do not disturb**.

1. From the Home screen, tap **Apps**  > **Settings** > **Sound & notification** > **Do Not Disturb access**.
2. You will see a list of apps that can access **Do Not Disturb**.

Programmable Key

You can assign a function to your programmable button.

1. You may press and hold the programmable button on the side of the phone.

– or –

From the Home screen, tap **Apps**  > **Settings** > **Programmable key** > **Programmable key**.

2. Tap **Do nothing** if you do not want to assign any function to the button.



– or –

Select a function you want to assign to the button. The assigned function works when you press and hold the button.

Tip: You can set the Programmable button to wake up your phone by tapping the **ON/OFF** switch next to **Wake up device**.

Application Manager

This menu lets you view and manage the applications on your phone.

1. From the Home screen, tap **Apps**  > **Settings** > **Application manager**.
2. Tap  for the following options:
 - **All apps** to display all applications on your phone.
 - **Downloaded** to display the downloaded applications.

Tip: Additional options may be available by tapping .

3. Tap an application to access the details and manage it.

Storage Settings

The Storage settings menu lets you manage the storage on your phone and provides options for your microSD card.

Your Phone's Memory

You can see the availability of the storage space on your phone.

- ▶ From the Home screen, tap **Apps**  > **Settings** > **Storage & USB**.
 - View your phone's total space and the space used by specific features under Internal storage.
 - You may tap an itemized category for additional details.

SD Card

The SD card options let you view the card's size and available space, unmount the card for data protection, and format (erase) the SD card. See [microSD Card](#).

USB Drive

The USB drive options are available when your phone is connected to an external device using a USB cable.

View the USB Storage Memory

1. From the Home screen, tap **Apps**  > **Settings**.
2. Tap **Storage & USB** to see the information of the USB drive.

Unmount the USB Storage

Unmount the USB storage so that you can safely remove it.

1. From the Home screen, tap **Apps**  > **Settings** > **Storage & USB**.
2. Tap  next to **USB drive**.



Erase the Data on the USB Storage

Warning: You cannot retrieve the data once deleted.

1. From the Home screen, tap **Apps**  > **Settings** > **Storage & USB** > **USB drive**.
2. Tap  > **Settings** > **Format as internal** > **ERASE & FORMAT** > **OK**.

Battery Settings

Monitor your phone's battery usage through this settings menu. View which functions are consuming your battery's charge and at what percentage.

- ▶ From the Home screen, tap **Apps**  > **Settings** > **Battery**.
 - Tap on the graph image on the screen to see the history details of the battery usage.
 - Tap other displayed items to access their Use details screens. Additional options may be available.
 - Tap  to refresh the displayed information.
 - Tap  for the following menus:
 - **Battery optimization** to reduce the energy needs of your app.

- **Battery charging tone** to sound a notification tone when the USB cable is plugged into the phone's USB data/port.
- **Battery charged tone** to sound a notification tone when the battery is fully charged.
- **Display battery percentage** to display the remaining battery level in percentage next to the battery icon on the status bar.

Tap & Pay

When NFC is turned on, you can use the Tap & pay feature to pay for items just by touching your phone to a reader at a register. If your phone doesn't have a default app, you can browse Google Play for payment apps. See [Turn NFC On or Off](#) for enabling NFC.

1. From the Home screen, tap **Apps**  > **Settings** > **Tap & pay** > **Payment default**.
2. Select an app to use.

Location Settings

The location services settings menu lets you decide whether you allow your phone to collect and use the location information.

Important: Your wireless phone can determine its (and your) physical, geographical location ("Location Information") and can associate Location Information with other data. Additionally, certain applications, services and programs are capable of accessing, collecting, storing and using Location Information and disclosing Location Information to others. You should use caution when determining whether or not Location Information should be made available to others and you should review any applicable third party privacy policies before providing access. To limit potential unauthorized access to your Location Information, Wireless phones are preset to E911 only, which will only allow emergency response personnel to locate you if you dial 9-1-1 from your phone. Other wireless devices (such as Broadband Data Cards or devices without a keypad or user interface) may or may not have such limitations and location settings available. By enabling location settings you are permitting third party access to Location Information through software, widgets or peripheral components you choose to download, add or attach to your wireless device or through web access, messaging capabilities or other means and you are authorizing Wireless to collect, use and disclose your Location Information as appropriate to provide you with any location services that you enabled.

1. From the Home screen, tap **Apps**  > **Settings** > **Location**.
2. Tap the **OFF** icon.

3. Read the message in the **Location consent** dialog box and, if you agree to it, tap **AGREE**.
4. The following options are available:
 - **Mode** to select the method your phone uses to determine your location.
 - **High accuracy:** Uses GPS, Wi-Fi, and cellular networks to determine your location.
 - **Battery saving:** Uses only Wi-Fi and cellular networks to determine your location.
 - **Device only:** Uses only GPS to determine your location.

Lock Screen Settings

The lock screen settings menus allow you to lock your phone's screen and enhance the security feature through various options.

Security Type

You can increase the security of your phone by creating a screen lock.

In order from no secure to most secure, the available options are:

- **None** – No security
- **Swipe** – No security
- **Pattern** – Medium security
- **PIN** – Medium to high security
- **Password** – High security
- **Fingerprint** – Medium security

Important: Highest security level protection (password protection) and frequent change of password are recommended to protect your phone and data from unauthorized access.

Use Pattern

1. From the Home screen, tap **Apps**  > **Settings** > **Lock screen** > **Screen lock type** > **Pattern**.
2. Draw the screen unlock pattern by connecting at least four dots in a vertical, horizontal, or diagonal direction. Lift your finger from the screen when finished.
3. The phone records the pattern. Tap **CONTINUE**.

4. When prompted, draw the screen unlock pattern again, and then tap **CONFIRM**.
5. Choose how do you want notifications displayed when your phone is locked and tap **DONE**.

To unlock the screen with Pattern:

- ▶ Draw the pattern on the locked screen.

Note: Tap **Make pattern visible** to **OFF** if you do not want the unlock pattern to display on the screen when you draw it.

Use PIN

1. From the Home screen, tap **Apps**  > **Settings** > **Lock screen** > **Screen lock type** > **PIN**.
2. Enter a PIN, tap **CONTINUE**, re-enter your PIN, and tap **OK** to save the setting.

To unlock the screen with PIN:

- ▶ Enter the PIN and tap **OK** on the locked screen.

Use Password

1. From the Home screen, tap **Apps**  > **Settings** > **Lock screen** > **Screen lock type** > **Password**.
2. Enter a password, tap **CONTINUE**, enter your password again, and tap **OK** to save the setting.

To unlock the screen with Password:

- ▶ Enter the password and tap  on the locked screen.

Disable the Screen Lock

1. From the Home screen, tap **Apps**  > **Settings** > **Lock screen** > **Screen lock type**.
2. Confirm your pattern, PIN, or password.
3. Tap **None** or **Swipe**.

Use Swipe

There is no security using the Swipe option.

- ▶ From the Home screen, tap **Apps**  > **Settings** > **Lock screen** > **Screen lock type** > **Swipe**.

See [Turn the Screen On and Start with Swipe](#) for starting with Swipe.

Fingerprint

Enabling this option requires you to touch the fingerprint sensor when unlocking the screen with the Fingerprint feature.

Note: If you fail fingerprint authentication five times, input your backup PIN, pattern, or password.

Note: Fingerprint cannot be used to unlock the screen after restarting the phone. You must use your backup method, such as pattern, PIN, or password.

Note: The fingerprint sensor is on the Power button. Before using the Fingerprint sensor, make sure the sensor is clean and dry.

Note: The fingerprint recognition performance depends on your usage. The phone may have an issue in registering or recognizing fingerprints that have scars or worn down ridges, or if you have scratches on the sensor surface.

Tip: To improve fingerprint recognition performance, register the fingerprints that are mostly used to perform task on a phone.

1. From the Home screen, tap **Apps**  > **Settings** > **Lock screen** > **Fingerprint**.
2. Read the message and tap **CONTINUE**.
3. Select your backup screen lock method.
4. Read the message and tap **NEXT**.
5. Touch the tip of your finger on the sensor and lift after you feel a vibration. Repeat it 20 times.
6. If required, name the fingerprint and tap **DONE**.

Make Pattern Visible

You can hide the trace of your pattern as you draw it. This setting appears only when you set **Screen lock type** to **Pattern**.

1. From the Home screen, tap **Apps**  > **Settings** > **Lock screen**.
2. Tap **Make pattern visible** to turn on.

Automatically Lock

Set the delay time the screen lock feature activates after it goes to sleep. This setting appears only when you set one of the lock settings.

1. From the Home screen, tap **Apps**  > **Settings** > **Lock screen** > **Automatically lock**.
2. Select a time to elapse before locking the screen.

Power Key Instantly Locks

Activate the screen lock feature by pressing the Power button. This setting appears only when you set one of the lock settings.

1. From the Home screen, tap **Apps**  > **Settings** > **Lock screen**.
2. Tap **Power key instantly locks** to turn on.

Secure Start-up

Set further protect your phone by requiring your **Pattern**, **PIN**, or **Password** before it starts up.

1. From the Home screen, tap **Apps**  > **Settings** > **Lock screen** > **Secure start-up**.
2. Select from **Require pattern (PIN, password) to start device** or **No thanks**.

Local Wipe

Your phone will be reset once the number of password attempts reaches the number specified here. This setting appears only when you set one of the lock settings.

1. From the Home screen, tap **Apps**  > **Settings** > **Lock screen** > **Local wipe**.
2. Select the number of password attempts.

Smart Lock

You can automatically sign you into your app using credentials.

1. From the Home screen, tap **Apps**  > **Settings** > **Lock screen** > **Smart Lock**.
2. The following options are available:
 - **Trusted devices:** Allows you to add a trusted device to keep this device unlocked when connected.
 - **Trusted places:** Allows you to add a trusted place to keep this device unlocked when you stay in there.
 - **Trusted face:** Allows you to set up Face matching as an option to unlock this device.
 - **Trusted voice:** Allows you to have your phone unlock when you do a search with "Ok Google."
 - **On-body detection:** Allows you to keep your phone unlocked while it's on you.

Note: The settings available may vary depending on your phone and version of Android.

Lock Screen Message

You can display the desired message on the locked screen.

1. From the Home screen, tap **Apps**  > **Settings** > **Lock screen** > **Lock screen message**.
2. Enter the message into the provided field and tap **SAVE**.

Lock Screen Wallpaper

You can select the wallpaper for the locked screen.

1. From the Home screen, tap **Apps**  > **Settings** > **Lock screen** > **Lock screen wallpaper**.
2. Select from **Same as Home screen** or **Use another image** and select from **Pick image** or others.

Show Instructions

You can display the instruction on the locked screen.

1. From the Home screen, tap **Apps**  > **Settings** > **Lock screen** > **Show instructions**.
2. Tap **Show instructions** to turn on.

Security Settings

The security settings menus let you set encryption options, password visibility, administrator settings, and credential storage options.

Encryption

You can encrypt the data in your phone and the SD card installed in your phone. You need to enter the PIN or password for the screen lock for the operation. To set up a PIN or password, see [Security Type](#).

Warning: Refrain from using the phone, including removing the SD card during the encryption and decryption processes as some or all of your data will be lost if the encryption and decryption processes are interrupted.

Phone

You can encrypt and decrypt the data in your phone, such as Contacts, Calendar, Email, settings values, personal data, etc.

1. Charge the battery first.



2. With your phone connected to the power source, on the Home screen, tap **Apps**  > **Settings** > **Security** > **Phone**.
3. Read the message and tap **Next**.
4. Enter the PIN or password and tap **Next**.
5. Read the message and tap **Encrypt**. The encryption process starts.

To decrypt the data in your phone:

1. Charge the battery first.
2. With your phone connected to the power source, on the Home screen, tap **Apps**  > **Settings** > **Security** > **Phone**.
3. Read the message and tap **Next**.
4. Enter the PIN or password and tap **Next**.
5. Read the message and tap **Decrypt**. The decryption process starts.

SD Card

You can set your phone to encrypt the data each time it is added to the SD card inserted in your phone.

1. From the Home screen, tap **Apps**  > **Settings** > **Security** > **SD card**.
2. Read the message, select **Encrypt all files** or **Encrypt new files only** and tap **NEXT**.
3. Enter a PIN or password and tap .
4. Read the message and tap **ENCRYPT**. The data to be saved in the SD card will be encrypted.
 - Read the message and tap **CANCEL** to cancel the setting.

Set Up SIM Card Lock

You can configure your SIM card lock settings.

To lock the SIM card with a PIN:

1. From the Home screen, tap **Apps**  > **Settings** > **Security** > **Set up SIM card lock**.
2. Tap **Lock SIM card** to turn on.
3. Enter your SIM PIN and tap **OK**.

To change the SIM PIN:

1. From the Home screen, tap **Apps**  > **Settings** > **Security** > **Set up SIM card lock** > **Change SIM PIN**.
2. Enter your current SIM PIN and tap **OK**.
3. Enter a new SIM PIN, tap **OK**, re-enter the new SIM PIN, and tap **OK**.

Make Passwords Visible

You can hide your password or PIN as you type it.

1. From the Home screen, tap **Apps**  > **Settings** > **Security**.
2. Tap **Make passwords visible** to turn on.

Device Administrators

You can enable or disable the authority to be a device administrator of certain applications. If disabled, you will typically lose some functionality in those applications, such as the ability to sync new email or calendar events to your phone.

1. From the Home screen, tap **Apps**  > **Settings** > **Security** > **Device administrators**.
2. Tap an application you want to enable or disable the authority to be a device administrator and tap **ACTIVATE** or **DEACTIVATE**.

Unknown Sources

Follow the steps below to allow installation of non-Play Store applications.

1. From the Home screen, tap **Apps**  > **Settings** > **Security**.
2. Tap **Unknown sources** to turn on.

Credential Storage

These options let you control how your phone accesses and stores secure certificates, passwords, and other credentials.

Storage Type

You can see the supported credentials storage type.

- ▶ From the Home screen, tap **Apps**  > **Settings** > **Security**. You will see the type under **Storage type**.

Trusted Credentials

You can see the trusted credentials on your phone's system.

1. From the Home screen, tap **Apps**  > **Settings** > **Security** > **Trusted credentials**.

2. Tap an item to read the information.

Install from SD Card

You can install encrypted certificates from the SD card.

1. From the Home screen, tap **Apps**  > **Settings** > **Security** > **Install from SD card**.
2. Tap an available certificate.
3. Follow the onscreen instructions.

Clear Credentials

You can remove all the credentials on your phone.

- ▶ From the Home screen, tap **Apps**  > **Settings** > **Security** > **Clear credentials** > **OK**.

Advanced

You can configure the advanced security settings.

Trust agents

Manage trust agents for features like Smart Lock.

1. From the Home screen, tap **Apps**  > **Settings** > **Security** > **Trust agents**.
2. Tap the **ON/OFF** switch to turn on or off.

Screen pinning

Turn on to keep your current screen in view on your phone.

1. From the Home screen, tap **Apps**  > **Settings** > **Security** > **Screen pinning**.
2. Tap the **ON/OFF** switch to turn on or off.

Apps with usage access

Manage what apps have access to app-usage data on your device.

1. From the Home screen, tap **Apps**  > **Settings** > **Security** > **Apps with usage access**.
2. Tap an app > Tap **Permit usage access** to turn on.



Accounts Settings

Add and manage all your email, social networking, and picture and video sharing accounts.

Set Up a New Account

1. From the Home screen, tap **Apps**  > **Settings** > **Accounts** > **Add account**.
2. Tap an account type such as **Corporate**, **Email**, **Google**, etc.
3. Follow the instructions on the screen to set up an account.
 - Depending on the account type, you may need to enter an email address or user address, password, domain name, or other information. For Corporate accounts, contact your server administrator to determine what information you will need.

Manage Existing Accounts

1. From the Home screen, tap **Apps**  > **Settings** > **Accounts**.
2. Tap an account type such as **Corporate**, **Email**, **Google**, etc.
3. Manage the settings or select an account. Available settings menus vary according to the account type.
 - Tap the **ON/OFF** switch next to the item to sync.
 - Tap  > **Sync now** to sync immediately.
 - Tap  > **Remove account** > **REMOVE ACCOUNT** to delete the account from your phone.

Language & Input Settings

Your phone's language and input settings let you select a language for the phone's menus and keyboards, select and configure keyboard settings, configure speech input settings, and more. For details, see [Enter Text](#).

This menu also provides the settings when using voice functions. See [Text-to-Speech](#).

Language Settings

The language settings menu lets you select an onscreen language and add custom words to your phone's user dictionary.

1. From the Home screen, tap **Apps**  > **Settings** > **Language & input** > **Language**.
2. Select an available language.

Spell Checker

This feature allows you to spell check text as you type it.

1. From the Home screen, tap **Apps**  > **Settings** > **Language & input** > **Spell checker**.

2. Tap the **ON/OFF** switch to turn on.
3. Tap **Language** and choose which language to use for spell-checking.
4. Tap  to configure the settings.

Personal Dictionary

You can use the user dictionary option to add new words to the dictionary. See [Add a Word to the User Dictionary](#).

Current Keyboard

You can select the default method you will use when accessing the keyboard. See [Touchscreen Keyboards](#).

Google Keyboard Settings

You can customize the Google Keyboard settings as you like.

1. From the Home screen, tap **Apps**  > **Settings** > **Language & input** > **Google Keyboard**.
2. Choose from the following options.

Languages

Tap to select the input language. The dictionary for the selected language will be enabled.

Preferences

- **Theme:** Change your keyboard theme.
- **Show key border:** Check to display a key border on the keyboard.
- **One handed mode:** Select the keyboard layout mode from **Disable**, **Right handed mode**, or **Left handed mode**.
- **Custom input styles:** Change your keyboard language and layout.
- **Long press for symbols:** Check to activate the input mode to access hidden symbols by long pressing keys.
- **Keyboard height:** Set the keyboard height range from **Short** to **Tall**.
- **Sound on keypress:** Check to activate a clicking sound when a key is tapped.
- **Volume on keypress:** Set the volume of tone when a key is tapped.
- **Vibrate on keypress:** Check to activate vibration when a key is tapped.
- **Vibration strength on keypress:** Set the vibration strength when a key is tapped.

- **Popup on keypress:** Check to display a larger image of the key above it when you tap it.
- **Voice input key:** Check to display the voice input key on the keyboard.
- **Key long press delay:** Set the delay time to change a word when a key is long pressed.

Text correction

- **Show correction suggestions:** Tap to select when correction suggestions are displayed.
- **Auto-correction:** Tap to allow the space bar and punctuation to automatically correct mistyped words.
- **Next-word suggestions:** Check to predict words based on the texts you have entered.
- **Auto capitalization:** Check to capitalize the first word of each sentence on the texts you have entered.
- **Block offensive words:** Check to avoid potentially offensive words will be suggested.
- **Suggest Contact names:** Use names from Contacts for suggestions and corrections.
- **Personalized suggestions:** Learn from Google apps and services and your typed data to improve suggestions.
- **Double-space period:** Tap to allow the space bar to insert a period and a space by double tapping.

Gesture Typing

- **Enable gesture typing:** Check to input a word by sliding through the letters.
- **Show gesture trail:** Check to display the path when you slide through the letters while using the gesture typing.
- **Enable gesture delete:** Check to delete a word by sliding left the delete key while using the gesture typing.
- **Enable gesture cursor control:** Check to move cursor by sliding across space bar while using the gesture typing.

Dictionary

Tap to add your own words to your personal dictionary. You can also add words to your personal dictionary as you're using the keyboard.

Advanced

Tap to open the settings for expert users.

Google Voice Typing Settings

You can customize the Google voice typing settings as you like.

1. From the Home screen, tap **Apps**  > **Settings** > **Language & input** > **Google voice typing**.
2. Configure the following options:
 - **Languages:** Tap to select the language to use for Google voice typing.
 - **"Ok Google" detection:** Launches Google voice search by saying "Ok Google" on the Google search screen.
 - **Hands-free:** Allow Bluetooth and wired headset requests when the phone is locked.
 - **Speech output:** Choose options for speech output.
 - **Offline speech recognition:** Tap to download the speech recognition data for offline use.
 - **Block offensive words:** Check to replace recognized offensive words in transcriptions with [*] when entering text by speaking.
 - **Bluetooth headset:** Check to record audio through Bluetooth headset if available.

Text-to-Speech Settings

Your phone can convert text into speech in certain downloaded applications. You may select the language you hear or adjust its speed. See [Text-to-Speech](#).

Pointer Speed

Change the pointer speed.

1. From the Home screen, tap **Apps**  > **Settings** > **Language & input** > **Pointer speed**.
2. Use the slider to set the speed and tap **OK**.

Backup & Reset Settings

Your phone's Backup & reset menus let you back up your phone's data and settings to Google servers before resetting your phone to the original factory settings.

The Factory data reset erases all data from the phone's application storage, including:

- Your Google Account
- All other email and social networking accounts
- System and application data and settings
- Downloaded applications

Backup and Restore

Back up your phone's data and settings before resetting your phone.

To set your backup and restore options:

1. From the Home screen, tap **Apps**  > **Settings** > **Backup & reset**.
2. Select your backup and restore options.
 - **Back up my data:** Check to back up your app data, Wi-Fi passwords, and other settings to Google servers.
 - **Backup account:** Tap to set a Google Account for your phone backup.
 - **Automatic restore:** Check to restore backed up settings and data when reinstalling an application after a factory data reset.

Network Settings Reset

The network settings will be reset to default including Wi-Fi settings, cellular data, and Bluetooth settings.

1. From the Home screen, tap **Apps**  > **Settings** > **Backup & reset** > **Network settings reset**.
2. Read the information and tap **NETWORK RESET**.
3. Read the network settings reset information and tap **RESET SETTINGS**.

Reset Settings



The system settings on your phone will be reset to default except the security, language and account settings.

1. From the Home screen, tap **Apps**  > **Settings** > **Backup & reset** > **Reset settings**.

2. Read the information and tap **RESET SETTINGS**.
3. Read the information and tap **OK**.

Factory Data Reset

All the data in your phone's internal storage will be reset to default.

Tip: Before performing a factory data reset on your phone, you may want to unmount the microSD card to avoid losing any data you may have stored on it. From the Home screen, tap **Apps**  > **Settings** > **Storage & USB** >  to unmount the storage card.

1. From the Home screen, tap **Apps**  > **Settings** > **Backup & reset** > **Factory data reset**.
2. Read the factory data reset information, select the **Erase SD card** check box if necessary, and tap **RESET PHONE**.
3. Tap **ERASE EVERYTHING**. Your phone will power down and reset itself, which may take up to 10 minutes.

Date & Time Settings

Use the Date & Time settings menu either to automatically use the network-provided date and time or manually set these values, as well as select time and date format options.

1. From the Home screen, tap **Apps**  > **Settings** > **Date & time**.
2. Tap **Automatic date & time** to turn off if necessary.
3. Tap **Automatic time zone** to turn off if necessary.
4. Tap **Set date**. Adjust the date, month, and year by scrolling each value. Tap **OK** when finished.
5. Tap **Set time**. Adjust the hour and minute, and select AM or PM by scrolling each value. Tap **OK** when finished.
6. Tap **Select time zone**, and then select a time zone from the onscreen list. Scroll down the list to view additional time zones.
7. Tap **Use 24-hour format** to turn on to use the 24-hour format.

Accessibility Settings

The Accessibility menu lets you enable and manage accessibility-related applications.

Services

This menu provides you with the list of accessibility-related applications.

Support & Protection

Support & Protection protects your mobile device from threats posed by malicious websites.

1. From the Home screen, tap **Apps**  > **Settings** > **Accessibility** > **Support & Protection**.
2. To turn it on, tap the **OFF** icon, read the confirmation message and tap **OK**.

TalkBack

TalkBack provides spoken feedback to help visually impaired users.

1. From the Home screen, tap **Apps**  > **Settings** > **Accessibility** > **TalkBack**.
2. To turn it on, tap the **OFF** icon, read the confirmation message and tap **OK**.
3. Tap **SETTINGS** to configure its settings.

Note: When TalkBack is turned on, you need to double tap or slide with two fingers, instead of single tap or slide with one finger, to operate the touchscreen.

Switch Access

Switch Access allows you to control your device using configurable key combinations. You can move focus to clickable items and select them.

1. From the Home screen, tap **Apps**  > **Settings** > **Accessibility** > **Switch Access**.
2. To turn it on, tap the **OFF** icon, read the confirmation message and tap **OK**.
3. Tap **SETTINGS** to configure its settings.

Vision

Magnification Gestures

You can zoom in and out by triple-tapping the screen.

1. From the Home screen, tap **Apps**  > **Settings** > **Accessibility** > **Magnification gestures**.
2. Read the information and tap the **OFF** icon to enable the feature.

Font Size

Select the font size on the screen.

1. From the Home screen, tap **Apps**  > **Settings** > **Accessibility** > **Font size**.

2. Select from **Small, Normal, Large, MagniFont**.

High Contrast Text

Sets the high contrast text function on or off.

1. From the Home screen, tap **Apps**  > **Settings** > **Accessibility**.
2. Tap **High contrast text** to turn on.

Auto-Rotate Screen

1. From the Home screen, tap **Apps**  > **Settings** > **Accessibility**.
2. Tap **Auto-rotate screen** to turn on.

Speak Passwords

Let your phone speak the password you enter.

1. From the Home screen, tap **Apps**  > **Settings** > **Accessibility**.
2. Tap **Speak passwords** to turn on.

Text-to-speech Output

See [Text-to-Speech](#).

Display

Color Inversion

Set the display color inversion on or off.

1. From the Home screen, tap **Apps**  > **Settings** > **Accessibility**.
2. Tap **Color inversion** to turn on.

Color Correction

Set the display color correction on or off, and select color correction mode.

1. From the Home screen, tap **Apps**  > **Settings** > **Color correction**.
2. Tap the **ON/OFF** switch to turn on.
3. Tap **Correction mode** to select the mode option.

Hearing

Captions

You can customize the language and the style of the displayed captions.

1. From the Home screen, tap **Apps**  > **Settings** > **Accessibility** > **Captions**.
2. Configure the following settings:
 - **Standard options:** Set the standard option for caption, such as **Language**, **Text size**, and **Caption style**.
 - **Custom options:** Set the custom option for texts, background color, or display.

Mono Audio

Set the Mono audio on or off.

1. From the Home screen, tap **Apps**  > **Settings** > **Accessibility**.
2. Tap **Mono audio** to turn on.

Sound Balance

Adjust the sound balance.

1. From the Home screen, tap **Apps**  > **Settings** > **Accessibility** > **Sound balance**.
2. Use the slider to set the sound balance and tap **OK**.

Mobility

Touch & Hold Delay

Set the delay time when the screen recognizes the touch and hold operation.

1. From the Home screen, tap **Apps**  > **Settings** > **Accessibility** > **Touch & hold delay**.
2. Select **Short**, **Medium**, or **Long**.

Persistent Alerts

Select options for the Persistent alerts.

1. From the Home screen, tap **Apps**  > **Settings** > **Accessibility** > **Persistent alerts**.
2. Tap the **ON/OFF** switch to turn on or off.
3. Select the check box of the following:

- **Audible tone** to beep when notification is on the notification bar.
- **Vibrate** to vibrate when notification is on the notification bar.
- **Blink LED** to blink the LED indicator when notification is on the notification bar.
- **Repeat interval** to set the reminder interval.
- **App notifications** to modify the notification settings individually for apps.

Others

Power Key Ends Call

Set the Power button ends call function on or off.

1. From the Home screen, tap **Apps**  > **Settings** > **Accessibility**.
2. Tap the **ON/OFF** switch next to **Power key ends call** to turn on.

Accessibility Shortcut

With this feature on, you can quickly enable accessibility features.

1. From the Home screen, tap **Apps**  > **Settings** > **Accessibility** > **Accessibility shortcut**.
2. Read the information and tap the **OFF** icon to enable the feature.

Phone Options Shortcut

Press and hold the Power button and use shortcuts on phone options.

1. From the Home screen, tap **Apps**  > **Settings** > **Accessibility** > **Phone options shortcut**.
2. Tap the **ON/OFF** switch of **Screenshot** or **Accessibility** to turn on.

Printing

You can print the data on your phone.

1. From the Home screen, tap **Apps**  > **Settings** > **Printing**.
2. Select an available print service and follow the online instructions.

About Phone

The About phone menu lets you access important phone information including your phone number, battery status, and view legal information.

- ▶ From the Home screen, tap **Apps**  > **Settings** > **About phone**.
 - **Status:** Battery level, My phone number (under SIM status), IMEI (International Mobile Equipment ID), Up time, etc.
 - **Network:** Signal strength, Service state, IP address, etc.
 - **Hardware info:** Model number, Bluetooth address, Serial number, etc.
 - **Software info:** OS, Software version, Build number etc.
 - **Legal information:** Copyright, license and other legal informations.
 - **Compliance Information:** FCC ID etc.

System Updates

You can check for any software updates or the updates status of your phone. See [Update Your Phone](#).

Cleaning and Drying Procedures

Your phone may be cleaned using a mild dish detergent. It may also be cleaned using alcohol or sanitizer wipes. Please see the proper procedures below.

Precautions

- Remove all accessories, such as screen protector, phone case and cover, and strap. For details, refer to the instructions that came with your accessory.
- Before cleaning, be sure the headset jack cover, card slot cover, and charger/USB port cover are closed firmly to maintain the waterproof capability.
- Kyocera has tested cleaning products and determined they will not damage the surfaces of the phone when used properly. A table containing these products can be found at the end of this section. See [Kyocera Tested Products](#).
- Never apply or spray alcohol directly on the phone as it can lead to damage of the coating and could affect its waterproof capability.
- Never pour liquid detergent directly onto the phone as this may affect the sound quality. If your phone is exposed to a concentrated liquid detergent, rinse it immediately with fresh water.
- Do not expose your phone to water at high pressure, and avoid immersing the phone in water for more than 30 minutes to maintain the waterproof capability.
- Clean by hand only. Do not use a hard brush or sponge as this may damage the surface of the phone and affect phone's waterproof capability.
- Do not use a washing machine, ultrasonic cleaner, or dishwasher. Doing so may damage the phone and affect the waterproof capability.
- Remove all jewelry to avoid scratching the surface of the phone.
- Do not attempt to clean your phone in extreme cold or hot conditions. Water can penetrate the phone during a rapid temperature change. If the phone has been exposed to extreme temperatures, allow it to return to room temperature before cleaning.

Cleaning the Phone

Cleaning Your Phone

CAUTION! Be sure the headset jack cover, card slot cover, and charger/USB port cover are closed firmly to maintain the waterproof capability.

1. Turn off the phone.
2. Rinse the phone thoroughly under running water in order to remove dirt.

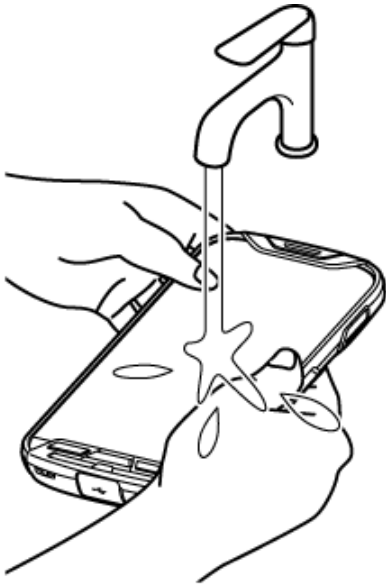

3. Add equal parts mild dish detergent and warm water and whip until it gets frothy. Using the froth, gently rub over the front and back parts of the phone in a circular motion.

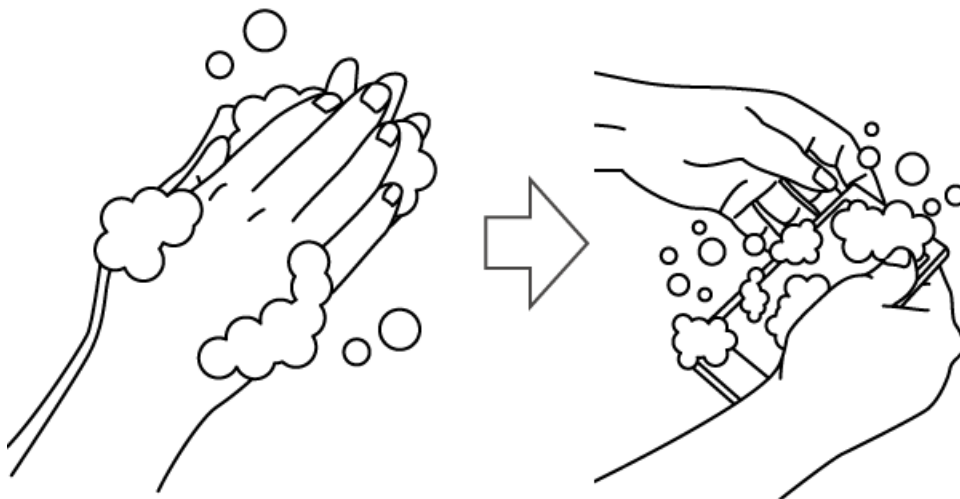

Note: Leave the back cover on while performing the cleaning procedure.

- Rinse both sides of the phone and all physical keys until there are no more bubbles left.

Note: Hold your phone below the faucet as shown below and rinse with low pressure tap water for more than 20 seconds for each part. Use only lukewarm water.

CAUTION! If detergent is left inside the phone, the audio quality as well as waterproof capability may deteriorate.

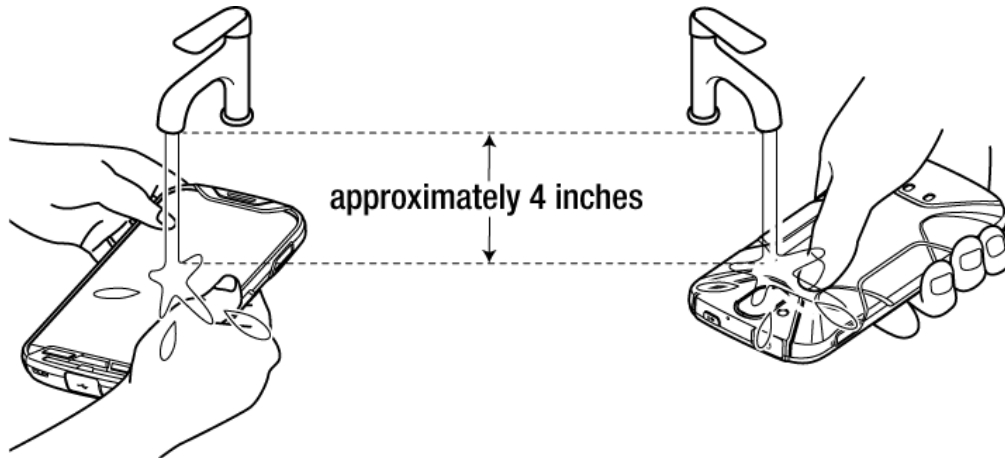

- Remove the back cover and rinse well back side of the phone and all physical keys until there are no bubbles left.

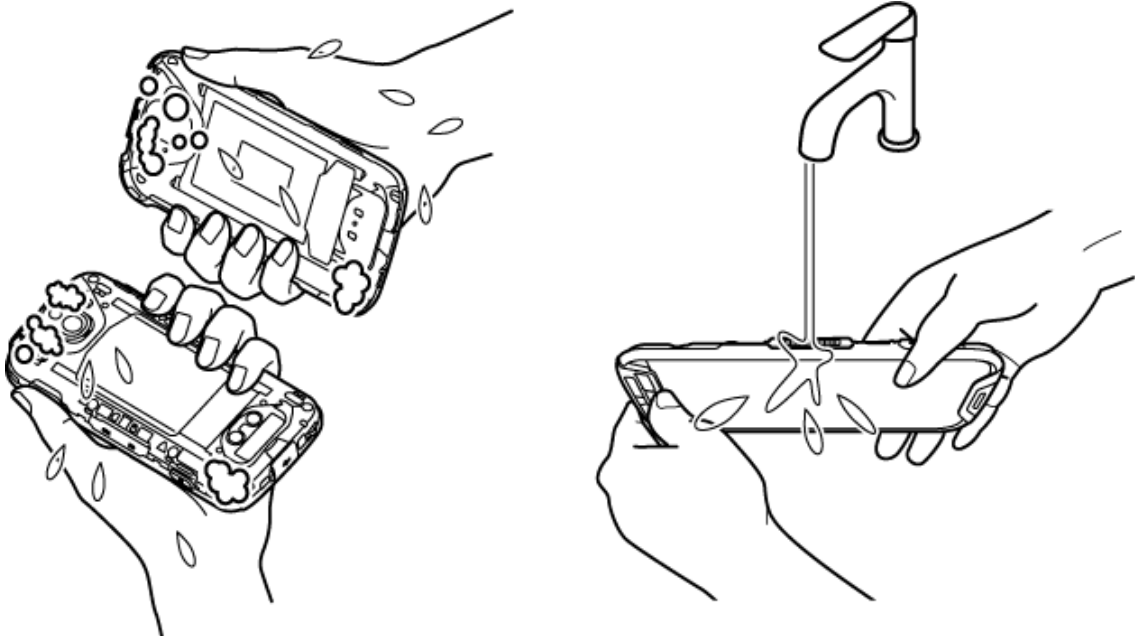

6. Rinse both sides of the back cover until there are no bubbles left.



7. Rinse the physical keys, speakers, microphones (2), earpiece, and pressure adjustment hole under running water and make sure all bubbles are removed.

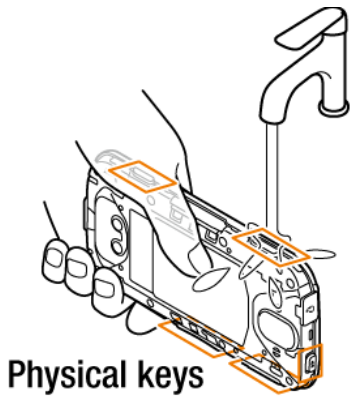

Physical keys

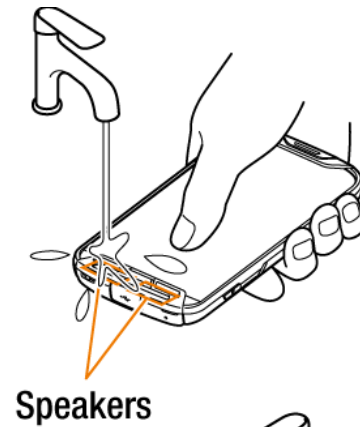

Speakers

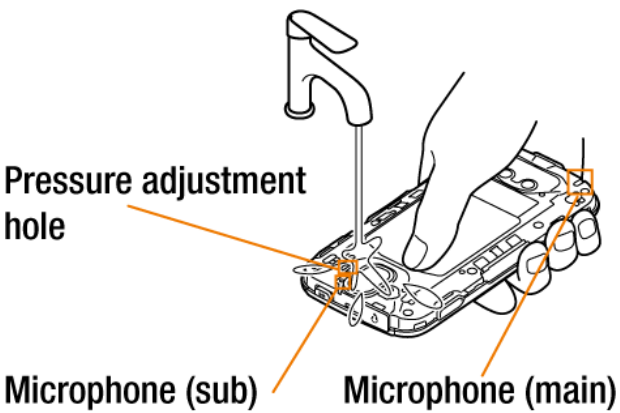

Pressure adjustment hole

Microphone (sub)

Microphone (main)

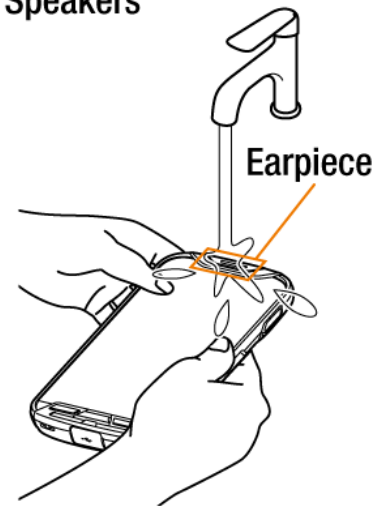

Earpiece

8. Put about 2 inches (5 cm) of water in a large bowl and gently rinse the phone by swirling it under water for about 10 seconds.

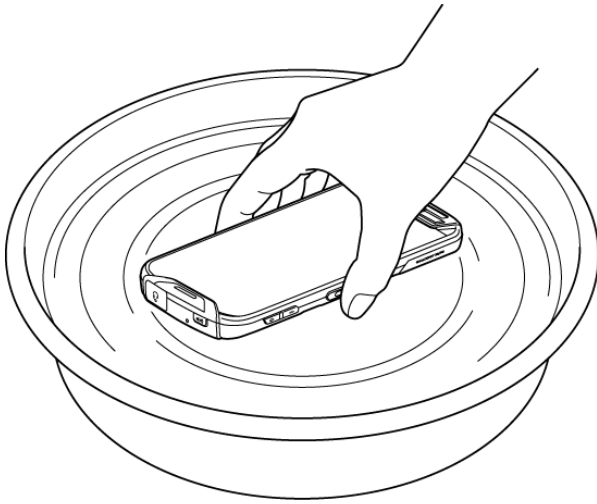

9. Dry your phone until you are sure there is no moisture left. See [Drying Your Phone](#) for details.

Note: Frequent and repeated cleaning will result in the surface gloss degradation, deformation, or discoloration of the phone.

Alternate Cleaning Procedure

1. Gently wipe the front and back of the phone with a lint-free cloth moistened with alcohol* or a sanitizer wipe.

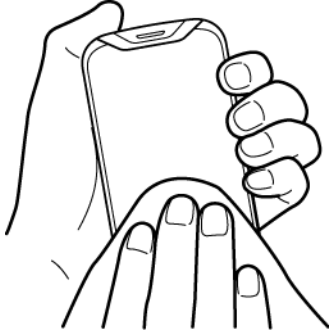

Note: Do not open the back cover while cleaning.

***Note:** Use only ethanol or isopropyl alcohol. See table at end of this section.

2. Remove any excess moisture with a dry lint-free cloth until it is completely dry.

Drying Your Phone

CAUTION! If your phone has been submerged in water, for example to use the camera in Underwater Mode, be sure to remove the back cover and rinse all surfaces of the phone thoroughly with clean, fresh water before drying.

1. Wipe down all outside surfaces of your phone with a clean lint-free cloth.

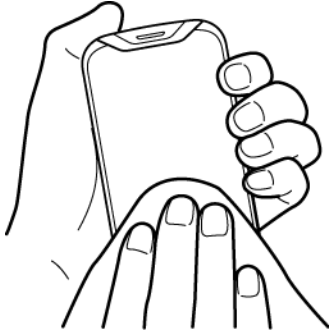

2. If not already done, remove the back cover and wipe the back side of the phone and the inside surface of the back cover.

3. Hold the phone firmly and gently shake it a few times to displace surface water.

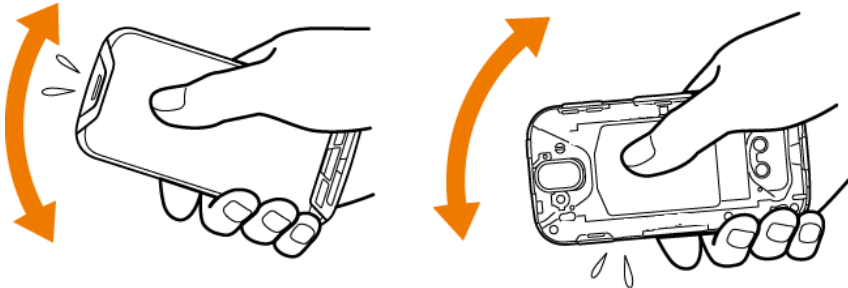

4. Pat with a clean dry cloth to remove moisture from speakers, microphones, earpiece, and pressure adjustment hole. Repeat patting each area about 20 times.

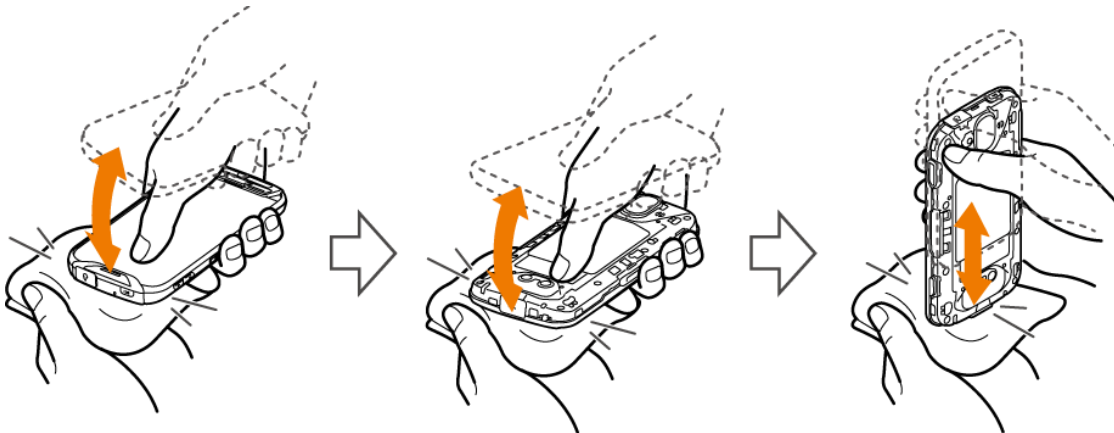

5. After removing all the water, leave back cover off to help with the drying process. Let the phone dry completely at room temperature.

CAUTION! Excessive heat may damage your phone; never use a hair dryer, an oven or any other appliance to dry out your phone.

Note: If your phone still retains some moisture, audio quality and speaker performance may be affected. Dry your phone completely before using it again.

Kyocera Tested Products

Mild Dish Detergents

Manufacturer	Brand	Product name
Seventh Generation	Seventh Generation	Dish Liquid, Free & Clear
		Dish Liquid Lemongrass & Clementine Zest
P&G	Dawn	Ultra Antibacterial Hand Soap Dishwashing Liquid, Apple Blossom Scent
		Ultra Dishwashing Liquid, Original Scent
		Dawn Platinum Power Clean Dishwashing Liquid, Refreshing Rain
Method Products	Method	Gel Dish Pump, Clementine
The Caldrea Company	Mrs. Meyer's	Clean Day Dish Soap, Lemon Verbena
		Dish Soap Basil
		Clean Day Dish Soap, Lavender
		Clean Day Liquid Dish Soap, Geranium
Colgate Palmolive	Palmolive	Ultra Palmolive Original
		Ultra Palmolive Oxy Power Degreaser
	Ajax	Ajax Triple Action Orange Dish Liquid & Hand Soap

Alcohol

- Ethanol (70% solution)
- Isopropyl Alcohol (70% solution)

Sanitizer Wipes

Manufacturer	Brand	Product name
Edgewell	Wet Ones®	Wet Ones® Antibacterial Hand Wipes
GOJO Industries, Inc.	Purell	Purell 9022-10 Sanitizing Hand Wipes
		Refreshing Sanitizing Wipes
		PURELL Hand Sanitizing Wipes Clean Refreshing Scent
Nice-Pak Products, Inc.	Sani-Hands®	Sani-Hands® Instant Hand Sanitizing Wipes
CleanWell Company	CleanWell	Cleanwell All Natural Hand Sanitizing Pocket Pack Wipes

Notes

- Instructions to perform tasks in this guide may change depending on the version of software or application on your phone.
- All screens in this guide are simulated. Actual displays may vary.
- Certain features, services and applications are network dependent and may not be available in all areas; additional terms, conditions and/or charges may apply. Contact your service provider about feature availability and functionality.
- All features, functionality and other specifications, as well as the information contained in this guide are based upon the latest available information and are believed to be accurate at the time of printing. Kyocera International, Inc. reserves the right to change or modify any information or specifications without notice or obligation.
- For warranty service information, please refer to the Safety and Warranty Information installed in the phone or call the following telephone number from anywhere in the continental United States and Canada: 1-800-349-4478.
- Fingerprint authentication technology does not guarantee completely accurate personal authentication and identification. Kyocera assumes no responsibility for any damages resulting from using your device by the third party or inability to use your device.

Copyright & Trademarks

© 2016 Kyocera Corporation. All rights reserved. KYOCERA is a registered trademark of Kyocera Corporation. All other trademarks are the property of their respective owners.

Android, Google Play, Google Maps, Gmail, YouTube and other marks are trademarks of Google Inc.

The Bluetooth® word mark and logos are registered trademarks owned by Bluetooth SIG, Inc. and any use of such marks by Kyocera Corporation is under license. Other trademarks and trade names are those of their respective owners.

Bluetooth QD ID (Qualified Design ID): XXXXX

PhotoSolid®, the image stabilization technology product, is a product of Morpho, Inc. "PhotoSolid®" is a registered trademark of Morpho, Inc.

"MovieSolid®", the motion video stabilizing technology product, is a product of Morpho, Inc. "MovieSolid®" is a registered trademark of Morpho, Inc.

"TrackSolid®", the automatic object tracking technology product, is a product of Morpho, Inc. "TrackSolid®" is a registered trademark of Morpho, Inc.

"Morpho HDR"™, the high dynamic range technology product, is a product of Morpho, Inc. "Morpho HDR"™ is a trademark of Morpho, Inc.

"QuickPanorama®", the panoramic image generation technology product, is a product of Morpho, Inc. "QuickPanorama®" is a registered trademark of Morpho, Inc.

"Morpho Rapid Effect"™, a visual effect technology product, is a product of Morpho, Inc. "Morpho Rapid Effect"™ is a trademark of Morpho, Inc.



The 'Qi' symbol is a trademark of the Wireless Power Consortium.



microSD, microSDHC and microSDXC Logos are trademarks of SD-3C, LLC.

Index

- 3-Way calling, 34
- Accessibility
 - settings, 143
- Account
 - create, 138
 - manage, 138
- Airplane Mode, 116
- Alarm, 98
- Android Beam, 109
- Application
 - settings, 127
- Application Launcher, 14
- Apps
 - add shortcuts to the Home screen, 15
- Back button, 2
- Backup, 142
- Backup & reset, 142
- Battery
 - charge, 3
 - charge wirelessly, 6
 - status information, 128
- Bluetooth, 104
 - change phone name, 104
 - connect, 105
 - disconnect, 106
 - receive information, 107
 - reconnect, 106
 - send information, 107
 - settings, 104
 - share pictures and videos, 90
 - supported profiles, 108
 - turn on or off, 104
 - unpair, 106
- Browser, 75
 - bookmarks, 78
 - Chrome menu, 77
 - launch, 73, 75
 - navigation, 75
 - select text on a Web page, 78
- Calculator, 100
- Calendar, 92
 - add a task, 93
 - add an event, 92
 - edit events, 96
 - erase events, 96
 - event alerts, 94
 - invite guests, 93
 - show or hide, 96
 - synchronize, 97
 - view events, 95
- Call
 - 3-Way calling, 34
 - additional settings, 41
 - answer, 30
 - Assisted dialing, 37
 - auto answer on headset, 41
 - Call Forwarding, 35
 - call rejection, 38
 - call timer, 42
 - Call Waiting, 34
 - Caller Name ID, 34
 - DTMF tones, 41
 - emergency numbers, 28
 - end, 145
 - from Contacts, 28
 - from the phone dialpad, 27
 - from the Recent calls list, 28
 - hearing aids, 41
 - make, 27
 - numbers with pauses, 29
 - options, 33
 - Plus (+) Code Dialing, 29
 - quick response, 40
 - receive, 30
 - recent calls (call log), 36
 - reject and send a message, 30
 - ringtone, 39
 - send to Voice Mail, 30
 - speed dial numbers, 28
 - TTY mode, 40

- vibrate, 39
- video calling, 39
- Voice Mail settings, 39
- voice privacy, 41
- Call Forwarding, 35
- Call Waiting, 34
- Caller Name ID, 34
- Camera
 - back, 3
 - button, 3
 - flash, 3
 - front, 2
 - settings, 85
 - take picture, 82
 - underwater mode, 85
- Cellular networks, 118
- Charger
 - port, 2
- Cleaning
 - alcohol, 155
 - mild dish detergent, 150
 - sanitizer wipe, 155
- Cleaning Procedure, 149
 - cleaning, 150
 - drying, 156
 - precautions, 149
 - tested products, 158
- Clock, 97
- Contacts, 44
 - add, 45
 - add to Favorites, 49
 - assign message ringtone, 48
 - assign new picture, 47
 - assign phone ringtone, 48
 - assign stored picture, 47
 - assign vibration, 48
 - delete, 49
 - edit, 46
 - edit group, 51
 - group, 50
 - ICE (in case of emergency), 52
 - list, 44
 - make call from, 28
 - save a phone number, 46
 - share, 53
 - synchronize, 52
- Data services, 72
 - connection status and indicators, 73
- Data usage settings, 116
- Date & Time, 143
- Display
 - adaptive brightness, 121
 - battery percentage, 123
 - brightness level, 121
 - cast, 123
 - daydream, 122
 - font size, 122, 144
 - key backlight, 122
 - quick settings, 123
 - settings, 121
 - sleep, 121
 - wallpaper, 17
 - when device is rotated, 122
- Drag, 11
- Drying, 156
- Dura Grid, 18
- Eco Mode, 103
- Email, 57
 - account settings, 60
 - add a corporate account, 58
 - add an account, 57
 - compose and send, 58
 - general settings, 59
 - manage inbox, 59
 - send pictures or videos, 89
 - view and reply, 59
- Emergency alerts, 120
- Emergency call, 28
- Factory data reset, 143
- Favorites Tray, 14, 16
- File Commander, 113
- Flashlight, 100
- Flick, 12
- Gmail
 - access, 55
 - account settings, 56
 - read and reply, 56
 - send, 55

- send pictures or videos, 89
- Google Account, 54
 - create, 54
 - sign in to, 55
- Google Keyboard, 21
 - text mode, 23
 - user dictionary, 23
- Google Maps, 66
- Google Play, 63
 - install apps, 63
 - open apps, 65
 - options, 64
 - Play Store, 63
 - refund, 64
 - uninstall apps, 65
- Google voice typing, 24, 141
- Hangouts, 62
- Headset jack, 2
- Home button, 2
- Home screen, 13
 - extended, 15
 - manage, 15
 - overview, 13
- Keyboard, 21
 - Gesture typing, 24
 - Google Keyboard, 21
 - Google Keyboard settings, 139
- Language, 138
- Language & input settings, 138
- Launcher screens, 18
- LED indicator, 2
- Light sensor, 2
- Location
 - settings, 129
- Message+, 60
 - draft message, 61
- Microphone
 - primary, 2
 - secondary, 2
- microSD card, 110
 - format, 112
 - insert, 110
 - remove, 112
 - unmount, 112
- use as a media device, 113
 - view the memory, 112
- Mobile hotspot, 79
- Music, 68
 - back up, 69
 - Play Music, 68
- NFC (Near field communication), 109
 - Android Beam, 109
 - tap & pay, 129
- Notification
 - icon, 19
 - panel, 19
- Outdoor Report, 114
- Phone
 - back up, 142
 - hard reset, 7
 - illustration, 1
 - information, 147
 - restart, 7
 - restore, 142
 - turn off, 7
 - turn on, 7
- Phone number
 - save to Contacts, 46
- Photos, 86
 - edit pictures, 88
 - open, 87
 - options, 88
 - share pictures and videos, 89
 - view pictures and videos, 87
 - zoom on a picture, 88
- Picture
 - view, 86
- Pinch, 12
- Play Music
 - play, 69
- Plus (+) Code Dialing, 29
- Power button, 3
- Print, 147
- Programmable button, 3, 126
- Proximity sensor, 2
- Push To Talk Plus (PTT+), 42
- Quick settings, 20
- Recent calls, 36

- clear, 37
- filter, 37
- view, 36
- Ringtone, 124
 - mute, 30
- Rotate, 12, 122
- Screen lock
 - fingerprint, 132
 - password, 131
 - pattern, 130
 - PIN, 131
 - swipe, 131
- Security, 130, 134
 - credential storage, 136
 - device administrators, 136
 - encryption, 134
 - make passwords visible, 136
 - screen lock, 130
 - SIM card lock, 135
 - unknown sources, 136
- Settings, 116
- Setup Wizard, 8
- SIM card
 - insert, 4
 - lock, 135
- Slide, 12
- Sound & Notification
 - also vibrate for calls, 123
 - app notifications, 126
 - do not disturb, 124
 - notification, 125
 - other sounds, 125
 - persistent alerts, 125
 - settings, 123
 - touch dialpad, 39
 - when device is locked, 126
- Sound Recorder, 101
- Speaker, 2
- Speaker button, 2
- Speed dialing, 28
 - set up, 35
- Spread, 12
- Status bar, 19
- Status icons, 19
- Stopwatch, 100
- Storage, 127
 - microSD, 112
 - phone, 127
 - USB, 128
- Swipe, 12
- TalkBack, 144
- Tap, 11
- Tap & pay, 129
- Tethering, 81
- Text
 - copy and paste, 25
 - enter, 21
- Text Messaging and MMS, 60
 - draft message, 61
 - send pictures or videos, 90
- Text-to-speech, 102
- Timer, 99
- Touch and hold, 11
- Touchscreen, 2
 - keyboards, 21
 - navigation, 11
 - turn off, 7
 - turn on and start, 7
- TTY mode, 40
- Update phone, 115
- USB
 - port, 2
- Vibrate
 - intensity, 125
 - pattern, 124
- Video
 - record video, 82
 - settings, 85
 - view, 86
- Virtual Private Networks (VPN), 74
 - add a connection, 74
 - connect or disconnect, 75
 - install security certificates, 74
 - prepare for a connection, 74
- Voice Mail, 9, 30
 - compose message, 31
 - review, 31
 - set up, 9

- settings, 32
- Voice Mail (Traditional), 9, 32
 - notification, 33
 - retrieve, 33
 - set up, 9
- Voice search, 102
- Volume button, 2
- Volumes, 123
- Wallpaper, 17
- Weather, 17

- Widget
 - add to the Home screen, 15
- Wi-Fi, 70
 - check status, 71
 - connect, 70, 71
 - settings, 71
 - turn on, 70
- World clock, 97
- YouTube, 61
 - share videos, 90