



Lingo
user guide



Tomorrow is rising.

Lingo / M1000 Generic User Guide

This manual is based on the production version of the Kyocera Lingo / M1000 phone. Software changes may have occurred after this printing. Kyocera reserves the right to make changes in technical and product specifications without prior notice. The products and equipment described in this documentation are manufactured under license from QUALCOMM Incorporated under one or more of the following U.S. patents:

4,901,307 5,109,390 5,267,262 5,416,797 5,506,865
5,544,196 5,657,420 5,101,501 5,267,261 5,414,796
5,504,773 5,535,239 5,600,754 5,778,338 5,228,054
5,337,338 5,710,784 5,056,109 5,568,483 5,659,569
5,490,165 5,511,073

The Kyocera Wireless Corp. ("KWC") products described in this manual may include copyrighted KWC and third party software stored in semiconductor memories or other media. Laws in the United States and other countries preserve for KWC and third party software providers certain exclusive rights for copyrighted software, such as the exclusive rights to distribute or reproduce the copyrighted software. Accordingly, any copyrighted software contained in the KWC products may not be modified, reverse engineered, distributed or reproduced in any manner not permitted by law.

Furthermore, the purchase of the KWC products shall not be deemed to grant—either directly or by implication, estoppel, or otherwise—any license under the copyrights, patents, or patent applications of KWC or any third party software provider, except for the normal, non-exclusive royalty-free license to use that arises by operation of law in the sale of a product.

Kyocera is a registered trademark of Kyocera Corporation. Brick Attack and Race 21 are trademarks of Kyocera Wireless Corp. QUALCOMM is a registered trademark of QUALCOMM Incorporated.

Openwave is a trademark of Openwave Systems Incorporated. eZiText is a registered trademark of Zi Corporation. TransFlash is a trademark of SanDisk Corporation. Bluetooth trademarks are owned by Bluetooth SIG, Inc. and used by Kyocera Wireless Corp. under license.

All other trademarks are the property of their respective owners.

Copyright © 2007 Kyocera Wireless Corp.
All rights reserved.

Ringer Tones Copyright © 2000-2007
Kyocera Wireless Corp.

Bluetooth® Certification

For information about Lingo / M1000 Bluetooth Certification visit the Bluetooth Qualification Program Web site at qualweb.bluetooth.org.

82-G1934-1EN, Rev. 001

FCC Notice

This device complies with part 15 of the FCC rules. Operation is subject to the following two conditions: (1) This device may not cause harmful interference, and (2) This device must accept any interference received, including interference that may cause undesired operation. To maintain compliance with FCC RF exposure guidelines, if you wear a handset on your body, use the Kyocera Wireless Corp. (KWC) supplied and approved universal pouch CV90-61344-03.

Other accessories used with this device for body-worn operations must not contain any metallic components and must provide at least 15 mm separation distance including the antenna and the user's body.

**THIS MODEL PHONE MEETS THE
GOVERNMENT'S REQUIREMENTS FOR
EXPOSURE TO RADIO WAVES.**

Your wireless phone is a radio transmitter and receiver. It is designed and manufactured to not exceed the emission limits for exposure to radio frequency (RF) energy set by the Federal Communications Commission of the U.S. Government. These limits are part of comprehensive guidelines and establish permitted levels of RF energy for the general population. The guidelines are based on standards that were developed by independent scientific organizations through periodic and thorough evaluation of scientific studies. The standards include a substantial safety margin designed to assure the safety of all persons, regardless of age and health. The exposure standard for wireless mobile phones employs a unit of measurement known as the Specific Absorption Rate, or SAR. The SAR limit set by the FCC is 1.6 W/kg.*

Tests for SAR are conducted using standard operating positions specified by the FCC with the phone transmitting at its highest certified power level in all tested frequency bands.

Although the SAR is determined at the highest certified power level, the actual SAR level of the phone while operating can be well below the maximum value. This is because the phone is designed to operate at multiple power levels so as to use only the power required to reach the network. In general, the closer you are to a wireless base station antenna, the lower the power output.

Before a phone model is available for sale to the public, it must be tested and certified by the FCC that it does not exceed the limit established by the government-adopted requirement for safe exposure. The tests are performed in positions and locations (e.g., at the ear and worn on the body) as required by the FCC for each model.

Body-worn measurements differ among phone models, depending upon availability of accessories and FCC requirements. While there may be differences between the SAR levels of various phones and at various positions, they all meet the government requirement for safe exposure.

The FCC has granted an Equipment Authorization for this model phone with all reported SAR levels evaluated as in compliance with the FCC RF emission guidelines. SAR information on this model phone is on file with the FCC and can be found under the Display Grant section www.fcc.gov/oe/fccid after searching on the FCC ID: OVFKWC-M1000-2X0.

Additional information on SAR can be found on the Cellular Telecommunications and Internet Association (CTIA) web-site at www.wow-com.com.

* In the United States and Canada, the SAR limit for mobile phones used by the public is 1.6 watts/kg (W/kg) averaged over one gram of tissue. The standard incorporates a substantial margin of safety to give additional protection for the public and to account for any variations in measurements.

Caution

The user is cautioned that changes or modifications not expressly approved by the party responsible for compliance could void the warranty and user's authority to operate the equipment.

Optimize your phone's performance

Use the guidelines in this guide to learn how to optimize the performance and life of your phone and battery.

Air bags

If you have an air bag, DO NOT place installed or portable phone equipment or other objects over the air bag or in the air bag deployment area. If equipment is not properly installed, you and your passengers risk serious injury.

Medical devices

Pacemakers—Warning to pacemaker wearers: Wireless phones, when in the 'on' position, have been shown to interfere with pacemakers. The phone should be kept at least six (6) inches away from the pacemaker to reduce risk.

The Health Industry Manufacturers Association and the wireless technology research community recommend that you follow these guidelines to minimize the potential for interference.

- Always keep the phone at least six inches (15 centimeters) away from your pacemaker when the phone is turned on.
- Do not carry your phone near your heart.
- Use the ear opposite the pacemaker.
- If you have any reason to suspect that interference is taking place, turn off your phone immediately.

Hearing aids—Some digital wireless phones may interfere with hearing aids. In the event of such interference, you may want to consult your service provider or call the customer service line to discuss alternatives.

Other medical devices—If you use any other personal medical device, consult the manufacturer of the device to determine if it is adequately shielded from external RF energy. Your physician may be able to help you obtain this information.

In health care facilities—Turn your phone off in health care facilities when instructed. Hospitals and health care facilities may be using equipment that is sensitive to external RF energy.

Potentially unsafe areas

Posted facilities—Turn your phone off in any facility when posted notices require you to do so.

Aircraft—FCC regulations prohibit using your phone on a plane that is in the air. Turn your phone off or switch it to Airplane Mode before boarding aircraft.

Vehicles—RF signals may affect improperly installed or inadequately shielded electronic systems in motor vehicles. Check with the manufacturer of the device to determine if it is adequately shielded from external RF energy.

Blasting areas—Turn off your phone where blasting is in progress. Observe restrictions, and follow any regulations or rules.

Potentially explosive atmospheres—Turn off your phone when you are in any area with a potentially explosive atmosphere. Obey all signs and instructions. Sparks in such areas could cause an explosion or fire, resulting in bodily injury or death. Areas with a potentially explosive atmosphere are often, but not always, clearly marked.

They include:

- fueling areas such as gas stations
- below deck on boats
- transfer or storage facilities for fuel or chemicals
- vehicles using liquefied petroleum gas, such as propane or butane
- areas where the air contains chemicals or particles such as grain, dust, or metal powders
- any other area where you would normally be advised to turn off your vehicle engine

Use with care

Use only in normal position (to ear). Avoid dropping, hitting, bending, or sitting on the phone.

Keep phone dry

Keep the phone dry. Damage can result if the phone gets wet. Water damage is not covered under warranty.

Resetting the phone

If the screen seems frozen and the keypad does not respond to keypresses, reset the phone by completing the following steps:

1. Remove the battery door.
2. Remove and replace the battery.

If the problem persists, return the phone to the dealer for service.

Accessories

Use only Kyocera-approved accessories with Kyocera phones. Use of any unauthorized accessories may be dangerous and will invalidate the phone warranty if said accessories cause damage or a defect to the phone.

Radio Frequency (RF) energy

Your telephone is a radio transmitter and receiver. When it is on, it receives and sends out RF energy. Your service provider's network controls the power of the RF signal. This power level can range from 0.006 to 0.6 watts.

In August 1996, the U.S. Federal Communications Commission (FCC) adopted RF exposure guidelines with safety levels for hand-held wireless phones. These guidelines are consistent with the safety standards previously set by both U.S. and international standards bodies in the following reports:

- ANSI C95.1 (American National Standards Institute, 1992)
- NCRP Report 86 (National Council on Radiation Protection and Measurements, 1986)
- ICNIRP (International Commission on Non-ionizing Radiation Protection, 1996)

Your phone complies with the standards set by these reports and the FCC guidelines.

E911 mandates

Where service is available, this handset complies with the Phase I and Phase II E911 Mandates issued by the FCC.

Hearing Aid Compatibility (HAC)

Some mobile phones and hearing devices (hearing aids and cochlear implants), when used together, result in buzzing, humming, or whining noises detected by the user. Some hearing devices are more immune than others to this interference noise, and phones also vary in the amount of interference they generate.

The wireless telephone industry has developed ratings for some of their mobile phones, to assist hearing device users in finding phones that may be compatible with their hearing devices. Not all phones have been rated. Phones that are rated have the rating on their box or a label on the box. The ratings are not guarantees and results will vary depending on the user's hearing device and hearing loss. If your hearing device happens to be vulnerable to interference, you may not be able to use a rated phone successfully. Trying out the phone with your hearing device is the best way to evaluate it for your personal needs.

M-Ratings—Phones rated M3 or M4 meet FCC requirements and are likely to generate less interference to hearing devices than phones that are not labeled. M4 is the better/higher of the two ratings.

T-Ratings—Phones rated T3 or T4 meet FCC requirements and are likely to be more usable with a hearing device's telecoil ("T Switch" or "Telephone Switch") than unrated phones. T4 is the better/higher of the two ratings. (Note that not all hearing devices have telecoils in them.)

Hearing devices may also be measured for immunity to this type of interference. Your hearing device manufacturer or hearing health professional may help you choose the proper rating for your mobile phone. The more immune your hearing aid is, the less likely you are to experience interference noise from mobile phones.

For more information about hearing aid compatibility, visit the FCC's Consumer & Governmental Affairs Bureau Web site at www.fcc.gov/cgb/dro.

Battery and charger specifications

Charger	Input	Output
CE90-R2233	100-240 VAC / 50/60 Hz	5V 350mA
CV90-G2926	100-240 VAC / 50/60 Hz	4.5V 1.2A
CV90-K0281	100-240 VAC / 50/60 Hz	4.5V 600mA
Standard Battery (5mm):		
CV90-N3344 3.7V / 900 mAh		

Kyocera Wireless Corp.
10300 Campus Point Drive
San Diego, CA 92121 USA
www.kyocera-wireless.com
To purchase accessories, visit
www.kyocera-wireless.com/store

TABLE OF CONTENTS

1	Getting started	1	Checking available memory	24	
	Phone battery	1			
	Phone overview	3			
	Main menu	10			
	Basic navigation	11			
	Guide conventions	11			
2	Basic functions	12	6	Web Browser	25
	Powering up	12		Launching Web Browser	25
	Making phone calls	12		Using Web menu options	25
	Answering phone calls	12		Searching for Web site	26
	Ending phone calls	13		Using bookmark	26
	Verifying your phone number	13		Checking Browser Alerts	26
	Activating voice dialing	13		Web Alert	26
	Taking a picture	13	7	Recent Calls	27
	Using custom menu	13		Call lists	27
				Call timers	28
3	Call features	14	8	Contacts	29
	Volume control	14		Viewing contacts list	29
	Hold Calls	14		Adding contacts	29
	Speed dial	14		Working with contacts	30
	1-Touch Dialing	14		Searching contacts	33
	Voice mail	15	9	Messages	34
	Data and fax calls	15		Text messages	34
	Roaming calls	15		Multimedia messages	36
	Emergency services	16		Erasing messages	38
	Airplane Mode	16		Working with messages	39
4	Text entry	17		Creating group lists	40
	QWERTY keypad	17		Message settings	40
	Number keypad	20	10	Camera	44
5	BREW Apps	23		Taking a picture	44
	Using BREW Apps	23		Camera mode options	44
	Downloading an application	23		Camera indicators and icons	45
	Opening an application	24	11	Media Gallery	46
	Viewing application details	24		Accessing folders	46
	Removing an application	24		Browsing camera pictures	46
	Disabling an application	24		Browsing images	47
				Browsing sounds	47
				Playback tools	47
			12	Tools & Games	48

Brick Attack	48
Race 21.	48
Voice Memo	48
Scheduler	49
Alarm Clock	51
Tip Calculator	52
Calculator	52
Timer	52
Stopwatch	53
Flashlight	53
13 Settings.	54
Menu options	54
Sounds	55
Alerts	56
Display	56
My Phone	58
Accessories	62
Network	63
Security.	65
14 Bluetooth® Wireless Technology	67
Turning Bluetooth on	67
Pairing	67
Using Bluetooth.	68
Bluetooth settings	68
15 Voice recognition.	69
Voice dial list	69
Voice commands.	69
Voice Command Settings.	70
16 Getting Help	71
Customer Support.	71
Qualified service	71
Phone accessories.	72
Product evaluation	72
17 Consumer Limited Warranty.	73
Index	75

1 GETTING STARTED

Phone battery

Installing the battery

To install the battery:

1. Hold the phone face down and locate the screw on the back cover.
2. Turn the screw to set the screw slot in vertical position to unlock the back cover.
3. Locate the groove on the left side of the phone and unsnap the hooks to remove the back cover.
4. Place the battery in the phone casing with the metal contacts of the battery touching those of the phone.
5. Replace the back cover by sliding the notches into the opening on the left side.
6. Snap the back panel into place.



7. Set the screw slot in horizontal position to lock the back cover.

Note: To remove the battery, make sure the phone is powered off.



Charging the battery



You must have at least a partial charge in the battery to make or receive calls.

To charge the battery:

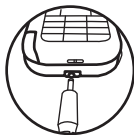
1. Connect the AC adapter to the jack on the bottom of the phone. Do not force the AC adapter into the jack.
2. Plug the adapter into a wall outlet.



The battery icon in the upper-right corner of the screen tells you whether the phone is:

- Charging (animated icon)
- Partially charged 
- Fully charged 

Warning: The battery does not charge if you use the phone while it is connected to an AC adapter.

Recharging the battery

You can safely recharge the battery at any time, even if it has a partial charge.

Caring for the battery

General safety guidelines

- Do not disassemble or open the battery.
- Do not crush, bend, deform, puncture, or shred the battery.
- Do not attempt to insert foreign objects into the battery.
- Do not immerse the battery or expose it to water or other liquids. Even if a battery appears to dry out and operate normally, internal parts can slowly corrode and pose a safety hazard.
- Always keep the battery between 15°C and 25°C (59°F and 77°F). Do not expose the battery to extremes of temperature, fire, or other hazards such as a cooking surface, iron, or radiator.
- Never use any damaged battery.
- Only use the battery for its intended phone.
- Only use the battery with a qualified charger. Use of an unqualified battery charger may present a risk of fire, explosion, leakage, or other hazard. If you are unsure about whether a charger is qualified, contact customer support.
- Do not short-circuit the battery or allow metallic conductive objects—such as keys, coins, or jewelry—to contact the battery's terminals.

- Replace the battery only with another qualified battery. Use of an unqualified battery may present a risk of fire, explosion, leakage, or other hazard. If you are unsure about whether a replacement battery is compatible, contact customer support.
- Promptly dispose of used batteries in accordance with local regulations and recycle if possible. Do not dispose as household waste.
- Supervise all battery usage by children.
- Avoid dropping the phone or battery. If the phone or battery is dropped, especially on a hard surface, an internal short-circuit can occur and pose a safety hazard. If you suspect battery damage, take it to a service center for inspection.
- Improper battery use may result in a fire, explosion, or other hazard.

Common causes of battery drain

- Playing games or using the Web.
- Taking pictures with the flash on.
- Keeping backlighting on.
- Operating in digital mode when far away from a base station or cell site.
- Using data cables or accessories.
- Operating when no service is available, or service is available intermittently.
- High earpiece and ringer volume settings.
- Repeating sound, vibration, or lighted alerts.
- Extensive use of flashlight option.

Phone overview

Getting to know your phone

The phone has two keypads—the number keypad and the QWERTY keypad.

Number keypad

1. External screen.
2. External **Camera** key activates camera mode.
3. **Volume** key to raise or lower speaker volume.
4. **Navigation** key scrolls through lists and text entry fields and accesses shortcuts from the home screen.
5. Left softkey accesses menus and functions.
6. **Speakerphone** key activates the speakerphone and answers incoming calls.
7. **Send/Talk** key starts or answers a call. Press once to activate voice command, twice to display the All Calls list, and three times to redial the last number dialed. Press and hold to access voice dial.
8. External number keypad for entering numbers, letters, or symbols.
9. * **Shift** key changes the text mode in text entry.
10. Jack for AC adapter (included) and data cable (sold separately).

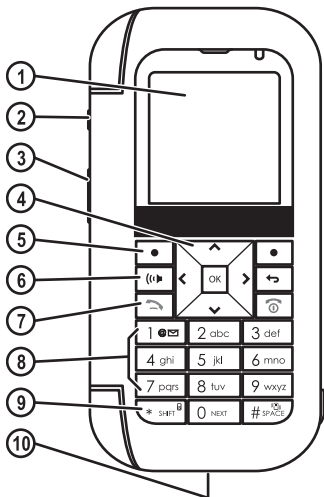

Number keypad continued

- External speaker.
- Indicator light shows missed alert when in red or incoming call when in green.
- OK** key selects a menu item or option.
- Right softkey accesses the contacts list and other menu options.
- Back** key erases characters in text entry and returns you to the previous screen.
- End/Power** key turns the phone on and off, ends a call or browser session, and returns you to the home screen.
- # Space** key enters a space during text entry. Press and hold to activate or deactivate Silent mode.
- Jack for hands-free headset only (sold separately).
- 0 Next** key cycles through word choices during text entry.

Warning: Inserting an accessory into the incorrect jack damages the phone.

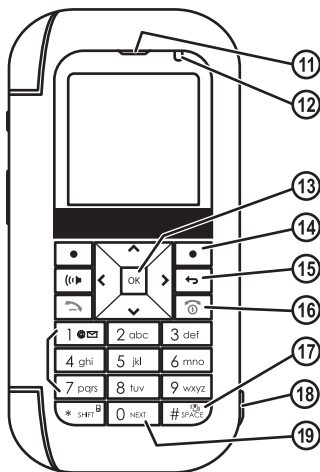

QWERTY keypad

When the flip is open, use the QWERTY keypad to enter numbers, letters and symbols.

1. Internal screen.
2. Internal speaker.
3. **Navigation** key scrolls through lists and text entry fields and accesses shortcuts from the home screen.
4. **Left softkey** accesses menus and functions.
5. **Send/Talk** key starts or answers a call. Press once to activate voice command, twice to display the All Calls list, and three times to redial the last number dialed. Press and hold to access voice dial.
6. **Internal Camera** key activates camera mode.
7. **Messages** key accesses the Messages menu.
8. **Symbol** key allows you to type symbol characters.
9. **Shift** key changes the text mode in text entry.
10. **Space** key enters a space during text entry.
11. **OK** key selects a menu item or option.
12. **Right softkey** accesses the contacts list and other menu options.
13. **End/Power** key turns the phone on and off, ends a call or browser session, and returns you to the home screen.
14. **Speakerphone** key activates the speakerphone and answers incoming calls.
15. **Back** key erases characters in text entry and returns you to the previous screen.
16. **Enter** key allows you to enter hard returns.

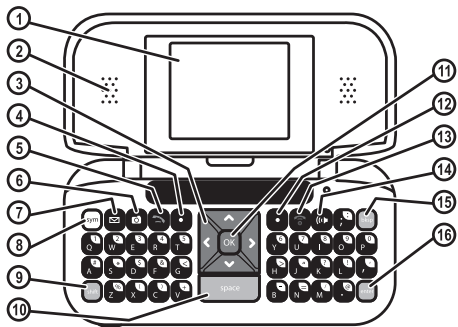

Back cover

1. Accessory eyelet (for optional straps and lanyards).
2. Camera flash and flash light.
3. Camera lens.
4. Back cover lock in unlocked status (If locked, the screw slot is in horizontal position).

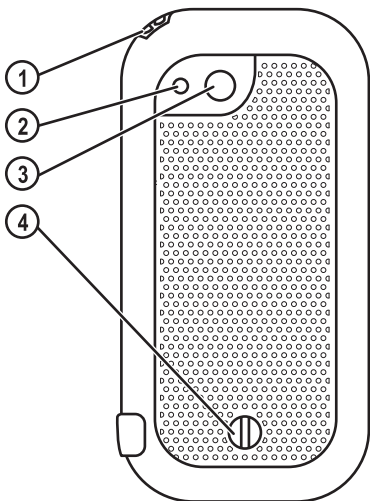

Common keys

The following keys are pressed frequently when you use your phone. Throughout this user guide, these keys are referred as follows:



Navigation key



Shift key (QWERTY keypad)



OK key



Left softkey (number keypad)



Left softkey (QWERTY keypad)



Right softkey (number keypad)



Right softkey (QWERTY keypad)



Talk/Send key (number keypad)



Talk/Send key (QWERTY keypad)



End/Power key (number keypad)



End/Power key (QWERTY keypad)



Back key (number keypad)



Back key (QWERTY keypad)



Speakerphone key (number keypad)



Speakerphone key (QWERTY keypad)



Camera key (QWERTY keypad)



Messages key (QWERTY keypad)



Symbol key (QWERTY keypad)

Screen icons

These icons may appear on your phone's screen.



The phone is operating in IS95 digital mode.



The phone is operating in Analog (FM) mode.



The phone is operating in IS2000 (1X) digital mode.



The phone is receiving a signal. You can make and receive calls. Fewer bars indicate a weaker signal.



A call is in progress.



The phone is not receiving a signal. You cannot make or receive calls.



The phone is roaming outside of its home service area.



High-speed (3G) data service is available and active on your phone. Check with your service provider for availability.



(blinking) The phone is sending high-speed data.



(blinking) The phone is receiving high-speed data.



High-speed data service is available, but the phone is dormant.



The battery is fully charged. The more black bars, the greater the charge.



The alarm clock is set.



The phone is in privacy mode or is accessing a secure Web site.



You have a text message.



You have a voice message.



New voice and text message.



New photo message.



New photo and voice message.



New photo and text message.



New photo, voice and text message.



The phone is set to light up instead of ring.



The phone is set to vibrate or to vibrate and then ring.



Position location is set to your service provider and to emergency services.



Position location is set to emergency services only.



The phone is in camera mode.

Screen icons continued



Camera flash mode is ready.



Camera zoom mode is ready.



Speakerphone is on.



Auto-Answer is on.



Bluetooth wireless technology is enabled (On).

Main menu

The contents of the main menu are as follows:

BREW Apps

MobileShop

Settings

Help

Web Browser

Launches the Browser

Recent Calls

All Calls

Incoming Calls

Outgoing Calls

Missed Calls

Erase Call Lists

Recent Calls Timer

All Calls Timer

Contacts

View All

Add New

View Groups

Speed Dial List

Voice Dial List

Messages

New Text Msg

New Picture Msg

Voicemail

Inbox

Browser Alerts

Sent

Outbox

Saved

Drafts

Msg Settings

Group Lists

Erase Messages

Camera

Launches the Camera

Media Galley

Camera Pictures

Images

Sounds

Tools & Games

Brick Attack

Race 21™

Voice Memo

Scheduler

Alarm Clock

Tip Calculator

Calculator

Timer

Stopwatch

Flashlight

Settings

Sounds

Alerts

Display

My Phone

Accessories

Network

Security

Bluetooth

On/Off

My Devices

Settings

Phone Info

Build Info

Icon Keys

Note: The menu items on your phone can change depending on the services provided. Check with your service provider.

Basic navigation

You press your phone keys to access the various menus and other features of your phone. Some of the basic frequently used keys are as follows:

- **Left softkey:** Select items that appear on the lower left of the display. At the home screen, you can select **Menu**.
- **Right softkey:** Select items that appear on the lower right of the display. At the home screen, you can select **Contacts**.
- **Navigation key:** Scroll through menus and options. You can access the following shortcuts from the home screen.
 - Press and hold left to launch **Web Browser**.
 - Press and hold right to record a voice memo.
 - Press and hold up to access the custom menu.
 - Press and hold down to view recent calls list.
- **OK key:** Select a menu item.
- **Back key:** Return to the previous menu level.
- **End/Power key:** Return to the home screen.

Guide conventions

In this guide the following conventions are used when describing phone features.

Select means to press the left or right softkey, or the **OK** key to select an item on the display. For example, “select **Menu**” tells you to press the left softkey at the home screen to access the main menu.

Press means to press a phone key. For example, “press the **Send** key to make a phone call” tells you to press the **Send** key on your phone.

Scroll means to press the **Navigation** key to move through a list on the display. For example, “scroll through your contacts list to choose a contact” means to press the **Navigation** key up or down to scroll through the list on the display.

The greater than symbol “>” tells you to select an option from a menu or list. For example, **Menu > Settings** means to:

1. Press the left softkey at the home screen to select **Menu**.
2. Scroll to the **Settings** option.
3. Press the **OK** key to select **Settings**.

2 BASIC FUNCTIONS

This section explains the basic functionality of your phone. For more detailed explanation of your phone's features please refer to the later chapters.

Powering up

To turn your phone on, press and hold the **End** key and wait until the phone display lights up. To turn your phone off, press and hold the **End** key until the phone turns off.

Making phone calls

Make sure you are in an area where a signal can be received. Look for the signal strength icon on the home screen. The more bars you see in this symbol, the stronger the signal. If there are no bars, move to where the signal strength is better.

When the phone has been idle for a while with no signal, it changes to power save mode. When you see “Power Save” on your phone's screen, press any key to return to normal operating mode.

You can make a phone call in one of the following ways.

Call using a number

At the home screen:

1. Enter a phone number.
2. Press the **Send** key.

Call using a contact

At the home screen:

1. Select **Contacts** to open your contacts list.
2. Highlight a contact and press the **Send** key.

Call using voice commands

You can use voice commands to call a contact from your voice dial list or to dial a phone number. For more information, see “Voice recognition” on page 69.

Redial a number

At the home screen:

1. Press the **Send** key twice to open your call history.
2. Highlight a phone number or contact and press the **Send** key.

Tip: To redial the last number called, received or missed, press the **Send** key three times.

Answering phone calls

When a call comes in, the phone rings, vibrates, or lights up. The phone number of the caller also appears if it is not restricted. If the number is stored in your contacts list, the contact name appears.

You can answer a phone call in one of the following ways.

Answer using earpiece

Press the **Send** key.

Answer using speakerphone

Press the **Speakerphone** key.

Answer using flip

You can set the phone to answer immediately when you open the flip. This feature does not apply to incoming data or fax calls.

See “Open to answer” on page 59.

Ending phone calls

Press the **End** key.

Verifying your phone number

To verify your phone number, select **Menu > Phone Info > Build Info**.

Activating voice dialing

At the home screen:

1. Press the **Send** key once.
2. Follow the prompts.

For more information, see “Voice recognition” on page 69.

Taking a picture

At the home screen:

1. Press and hold the **Camera** key to start the camera.
2. Focus on the image and select **Capture**.

For more information, see “Camera” on page 44.

Using custom menu

You can use the custom menu to quickly access your frequently used functions.

1. At the home screen, press and hold the up **Navigation** key to access the custom menu.
2. Select **Edit**.
3. Scroll through the list of options and press **OK** to select your desired option(s). A check mark appears next to each selected option. (You can press **OK** again to remove check marks.)
4. Select **Save** after checking all your desired option(s). Your selected options appear in the custom menu.
5. Scroll through the list of your selected functions in the custom menu and press **OK** to access your desired one.

3 CALL FEATURES

This chapter describes call features such as volume, holding calls, speed dialing and other features.

Volume control

You have several ways to control the volume of your phone.

Adjust volume during a call

To adjust the earpiece volume during a call, press the **Volume** key up or down.

Use the speakerphone

Your phone has a built-in speakerphone. To turn on the speakerphone, press the **Speakerphone** key.

The speakerphone icon appears on the home screen when the speakerphone is on.

To turn off the speakerphone, press the **Speakerphone** key.

Note: If you press the **Speakerphone** key during an incoming call, you answer the call.

Silence an incoming call

To silence the phone without answering the call, press the **End** key or select **Silence**.

To silence the phone and answer the call, press the **End** key and then press the **Send** key.

Note: In the absence of voicemail, this feature drops the call.

Hold Calls

The Hold Call feature allows you to place incoming calls on hold until you are ready to answer them. See “Hold Call” on page 59.

Speed dial

Use the speed dial feature to assign a one- or two-digit shortcut to a contact. Before you can use speed dialing, you must save a phone number as a contact and assign a speed dial location to it. See “Contact number” on page 30.

To call a contact that has a speed dial location:

1. Enter the one- or two-digit speed dial location.
2. Press the **Send** key.

1-Touch Dialing

The 1-touch dialing feature is the fastest way to speed dial a contact that has a speed dial location. See “1-Touch Dialing” on page 60.

Vicemail

Configure your voicemail

Before your phone can receive voicemail messages, you must set up a password and record a personal greeting with your service provider.

When you have set up your voicemail, all unanswered calls to your phone are automatically transferred to voicemail, even if your phone is in use or turned off.

1. With 1-touch dialing enabled, press and hold the 1 key.
2. Follow the system prompts to create a password and record a greeting.

Check voicemail

When a voice message is received, your screen displays “New Messages” along with the symbol at the top of your screen. The symbol flashes if the message is urgent. If you see “New Messages”:

1. Select Call, which initiates a call to your voicemail number.
2. Follow the system prompts to retrieve the message.

Note: To clear the screen without checking messages, select **Ignore**.

If you see only the voicemail message icon:

1. Select **Menu > Messages > Voicemail**.
2. If you have set up your voicemail, select **Call** to call your voicemail number.

3. Follow the system prompts to retrieve the message.

Set voicemail alert

You can set the phone to beep or vibrate every five minutes to remind you that you have voicemail.

See “Alerts” on page 41.

Data and fax calls

Your phone may be able to receive certain data or faxes. See “Data and fax calls” on page 63.

Roaming calls

Set roaming alert

You can set roaming alert if you want the phone to alert you when you roam outside of your home service area. See “Roaming alert” on page 64.

Roam Option

You can restrict your phone from making a call when roaming. See “Roam Option” on page 64.

Set roam ringer

You can set a ringer to indicate when an incoming call is subject to roaming charges. See “Roam Ringer” on page 55.

Set call guard

You can set the phone to warn you before you answer or place a call while roaming. See “Roam Call Alert” on page 65.

Emergency services

Call emergency service

You can call an emergency code, even if your phone is locked or your account is restricted.

When you call, your phone enters Emergency mode. This enables the emergency service exclusive access to your phone to call you back, if necessary. To make or receive regular calls after dialing the code, you must exit this mode.

To dial an emergency code:

1. Enter your 3-digit emergency code.
2. Press the **Send** key.

Note: Regardless of your 3-digit emergency code (911, 111, 999, 000, etc.), your phone operates as described.

Exit emergency services

When you have completed the emergency call:

1. Select **Exit**.
2. Select **Exit** again to confirm your choice.

Note: To determine who has access to your location, see “Location” on page 64.

Airplane Mode

While in an airplane, you can set your phone to Airplane Mode where your phone does not emit RF signals. See “Airplane Mode” on page 59.

4 TEXT ENTRY

You can enter letters, numbers, and symbols in contacts, text messages, and your banner with either QWERTY keypad (flip open) or the number keypad (flip closed).

QWERTY keypad

Text entry modes

With the flip open, enter text with the QWERTY keypad. The current text entry mode (and capitalization setting, when applicable) are indicated by icons.

The text entry screen has the following features:

1. The number of remaining characters you can enter. Allowed length of messages can vary depending on your service.
2. Text entry fields.
3. Current capitalization setting.
4. Current text entry mode.



There are six text entry modes:

(A) Case Change

a_bc Normal Alpha

eZi Rapid Entry

1@
2 Numbers and Symbols

&?! Add Symbol

☺ Add Smiley

Note: The mode you start in depends on the task you are doing. For example, when entering a phone number, you are in Numbers and Symbols mode. When entering a name for a contact, you are in Normal Alpha mode.

Enter numbers and symbols

- To enter a number or symbol while in Numbers and Symbols mode, press the appropriate key once.
- To enter a letter while in Numbers and Symbols mode, press the **Symbol** key once, then press the appropriate key.
- To change to and from Numbers and Symbols mode, press the **Symbol** key twice.

Enter word letter by letter

1. When entering text in Normal Alpha mode, press the appropriate key once. If your phone is set to Spanish, French, or Portuguese, accented letters are available.
2. To enter a number or symbol while in Normal Alpha mode, press the **S**ymbol key once, then press the appropriate key.
3. To change to and from Normal Alpha mode, press the **S**ymbol key twice.

Enter words quickly

When you press a series of keys in Rapid Entry mode, your phone checks its dictionary and guesses at the word you are trying to spell.

1. For each letter of the word you want, press the key once. For example, to enter the word “Wyoming” press the 2 > 6 > 9 keys.
2. If the word doesn’t match what you want, press 0 (next) to check other word matches.
3. When you see the word you want, press the # (pound) key.

Enter symbols

While entering text, you can enter many symbols with the keypad. To access extra symbols:

1. From the text entry screen select **O**ptions > **A**dd **S**ymbol.
2. Scroll up or down to view the list of symbols.
3. Press the number key corresponding to the symbol to enter it.

Enter smileys

1. From the text entry screen select **O**ptions > **A**dd **S**miley.
2. Scroll up or down to view the list of smileys.
3. Press the number key corresponding to the smiley to enter it.

Change default text entry mode

You can change the default text entry mode when creating a text message. This setting applies only to the message body screen, not the “To” screen. Select **M**enu > **M**essaging > **M**sg **S**ettings > **D**efault **T**ext and one of the following:

- **N**ormal **A**lpha enter text in letter by letter.
- **R**apid **M**ode enter text with word recognition.

Change modes

Sometimes you need to change modes. For example, to enter numbers in an email address while in normal alpha mode, you must change to Numbers and Symbols mode, enter the numbers, and then change back to Normal Alpha mode to complete the address.

To change text entry modes, press the **S**ymbol key twice, until the icon for the mode you want appears at the top of the screen. You can also select **O**ptions then select a different mode.

Capitalization

You can change capitalization at any time while entering text. Simply press the **S**hift key while in Normal Alpha mode.

Text entry quick reference

This table gives instructions for entering letters, numbers, and symbols.

To...	Do this...
Enter a letter	Use normal alpha mode and press a key until you see the letter you want. For more options, see “Text entry modes” on page 20.
Enter a number	Use numbers only mode and press a key until you see the letter you want. For more options, see “Text entry modes” on page 20.
Enter a symbol	In either normal alpha or numbers only mode, press 1 until you find the symbol you want. For more options, see “Text entry modes” on page 20.
Enter a smiley	Use the Add Smiley feature.
Enter a space	Press the Space key.
Erase a character	Press the Back key.
Erase all characters	Press and hold the Back key.
Move cursor right or left	Scroll left or right.
Move cursor up or down	Scroll up or down.
Change text entry modes	Press the Symb ol key twice.
Capitalize any letter	In Normal Alpha mode, press the Shift key to select uppercase if in lowercase or enter text if already in uppercase.
Lowercase any letter	In Normal Alpha mode, enter text if already in lowercase or press the Shift key to select lowercase if in uppercase.
Initial caps	In Normal Alpha mode, press the Shift key to select sentence case.
Select soft options on screen	Press the appropriate left or right softkey.

Number keypad

Text entry modes

When the flip is closed, enter text with the number keypad. The current text entry mode (and capitalization setting, when applicable) are indicated by icons.

The text entry screen has the following features:

1. The number of remaining characters you can enter. Allowed length of messages can vary depending on your service.

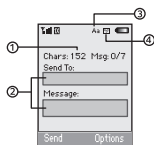

2. Text entry fields.
3. Current capitalization setting.
4. Current text entry mode.

There are six text entry modes:

 Case Change

 Normal Alpha

 Rapid Entry

 Numbers Only

 Add Symbol

 Add Smiley

Note: The mode you start in depends on the task you are doing. For example, when entering a phone number, you're in Numbers Only mode. When entering a name for a contact, you're in Normal Alpha mode.

Enter numbers

- To enter a number in Numbers Only mode, press a number key once.
- To enter a number in Normal Alpha or Rapid Entry mode, press and hold a number key until the number appears on the screen.

Enter words letter by letter

1. Press a key once for the first letter, twice for the second letter, and so on. If your phone is set to Spanish, French, or Portuguese, accented letters are available.
2. Wait for the cursor to move right and enter the next letter.

Note: To enter a space, press the # Space key.

Enter words quickly

When you press a series of keys in Rapid Entry mode, your phone checks its dictionary and guesses at the word you are trying to spell.

1. For each letter of the word you want, press the key once. For example, to enter the word "any" press the 2 > 6 > 9 keys.
2. If the word doesn't match what you want, press the 0 Next key to look at other word matches.

3. When you see the word you want, press the # Space key.

Enter symbols

While entering text in normal text mode, you can enter symbols by pressing the 1 key until you see the symbol you want. Using this method, you have access to the following symbols:

. @ ? ! - , & ; ' "

To access the full set of symbols:

1. From the text entry screen select **Options > Add Symbol**.
2. Scroll up or down to view the list of symbols.
3. Press the number key corresponding to the symbol to enter it.

Enter smileys

1. From the text entry screen select **Options > Add Smiley**.
2. Scroll up or down to view the list of smileys.
3. Press the number key corresponding to the smiley to enter it.

Change default text entry mode

You can change the default text entry mode when creating a text message. This setting applies only to the message body screen, not the “To” screen.

Select **Menu > Messaging > Msg Settings > Default Text** and one of the following:

- **Normal Alpha** to enter text in letter by letter.

- **Rapid Mode** to enter text with word recognition.

Change modes

Sometimes you need to change modes. For example, to enter numbers in an email address while in Normal Alpha mode, you must change to Numbers Only mode, enter the numbers, and then change back to Normal Alpha mode to complete the address.

To change text entry modes, press and hold the * **Shift** key until the icon for the mode you want appears at the top of the screen. You can also select **Options** then select a different mode.

Capitalization

You can change capitalization at any time while entering text. Simply press to choose upper or lower case while in normal alpha mode.

Text entry quick reference

This table gives instructions for entering letters, numbers, and symbols

To...	Do this...
Enter a letter	Use normal alpha mode and press a key until you see the letter you want. For more options, see “Text entry modes” on page 20.
Enter a number	Use numbers only mode and press a key until you see the letter you want. For more options, see “Text entry modes” on page 20.
Enter a symbol	In either normal alpha or numbers only mode, press 1 until you find the symbol you want. For more options, see “Text entry modes” on page 20.
Enter a smiley	Use the Add Smiley feature.
Enter a space	Press the # Space key.
Erase a character	Press the Back key.
Erase all characters	Press and hold the Back key.
Move cursor right or left	Scroll left or right.
Move cursor up or down	Scroll up or down.
Change text entry modes	Press and hold the * Shift key.
Capitalize any letter	In normal alpha mode, press the * Shift key. Choose uppercase.
Lowercase any letter	In normal alpha mode, press the * Shift key. Choose lowercase.
Initial caps	In normal alpha mode, press the * Shift key. Choose sentence case.
Select soft options on screen	Press the appropriate left or right softkey.

Your Kyocera phone has the added ability to download and manage applications through the BREW Apps menus.

BREW Apps provides you with the full range of applications and services from the Internet: Email, games, relevant news, and much more.

For more information about BREW Apps capabilities and application pricing, contact your service provider.

Using BREW Apps

You connect to the server, download applications, and then manage them as you like. When you choose an application, you can choose a demo, various limited use options, or the full version—all varying in price. If you choose a demo, BREW Apps notifies you when it has expired. If you choose a priced version, the amount goes to your phone bill. The MobileShop also notifies you if you're running out of memory. At that point, you can either disable an application or remove it completely.

With applications loaded, you can update to newer versions as they become available.

Downloading an application

To download an application:

1. At the home screen, select **Menu > BREW Apps > MobileShop > Catalog**. When connected to the server, a list of application types appears under the MobileShop menu.
2. Select an application type. A full list of applications of your selected type appears. New applications have an arrow on the left.
Note: Long titles scroll left as you highlight them.
3. Select an application. A list of usages appears. One or more usages may be available with the cost specified for each.
4. Select a usage. A confirmation message appears.
5. Select **Yes** to confirm. The application is downloaded to your phone.
Note: Download times vary.
6. To open the application now, select **Yes**. You can also select **No** to return to the BREW Apps menu, where you see a link to your new application.
Note: Your connection to the application server automatically ends after 30 seconds, unless you connect again to download more applications. Press the **End/Power** key to end the connection. Closing the flip does not end your connection.

Opening an application

Downloaded applications are stored under the BREW Apps menu. Each application comes with its own unique icon to help you identify it easily.

1. At the home screen, select **Menu** > **BREW Apps**.

Note: The BREW Apps icon always remains at the top of this menu. Downloaded applications are listed after.

2. Highlight and select the icon for the application you want to open.

Viewing application details

You can get information about the size of an application and how many uses it has left before it runs out.

1. At the home screen, select **Menu** > **BREW Apps** > **Settings** > **Manage Apps**.
2. Select the application you want details for.

Removing an application

To remove an application:

1. At the home screen, select **Menu** > **BREW Apps** > **Settings** > **Manage Apps**.
2. Select the application and **Remove**.
3. Select **Yes** to confirm your choice.

Note: If you remove an application, it is removed completely from your phone. If you want to use it again, you must pay for it again. If you want to free up space on your phone, we recommend you disable the application.

Disabling an application

If you are running out of memory and want to download more applications without completely removing those you have paid for, you can simply disable them. Thus, you can re-download an application to use it again without paying for it again.

1. At the home screen, select **Menu** > **BREW Apps** > **Settings** > **Manage Apps**.
2. Select the application and **Lock App**.
3. Select **Yes** to confirm your choice.

Note: The application is still listed in the BREW Apps menu. The icon looks like an empty box.

Checking available memory

The amount of available memory depends on the number of applications you downloaded.

1. At the home screen, select **Menu** > **BREW Apps** > **Settings** > **Manage Apps**. The amount of memory left shows at the bottom of the screen.
2. For more detailed memory information, select **System Info**.

6 WEB BROWSER

You can use your phone to browse the Internet if you have obtained phone Internet services from your service provider and if over-the-air Internet access is available in your area.

Note: You cannot receive incoming calls while you are using Web Browser.

Launching Web Browser

At the home screen:

1. Select **Menu > Web Browser**.

A message about airtime fees appears every time you start the browser.

For more information about how airtime is charged, contact your service provider.

2. Select **OK** to continue.

If this is the first time you have connected to the Internet, a message informs you that security is not yet enabled for your Web Browser.

3. Select **Yes** to enable security.

When you are connected, a browser home page appears. It has a list of bookmarks and some Web menu options at the bottom of the screen. The lock icon appears in a secure session. An underline and an arrow indicate that there is more text. Scroll down to view more text. Press the **Back** key to return to the previous screen.

4. To choose a site, highlight the link and select **Go**.
5. When you have finished using the Internet, press the **END** key to exit.

Using Web menu options

The following options may appear during a Web session.

- **Home** returns you to the main Web Browser window, or home page.
- **Mark Site** saves the current location as a bookmark for easy access.
- **Bookmarks** displays a list of your saved Web sites.
- **Setup** gives you options for changing how information is displayed.
 - **Show URL** displays the entire URL.
 - **About Openwave** displays information about your Web Browser version.
 - **Encryption** should not be used unless you are instructed to do so by your service provider.
 - **UP.Link** selects a different browser server. You can use this option if you have more than one Web Browser account.
 - **Restart** restarts the Web Browser.

Searching for Web site

How you search for a Web site depends on your service provider. For more information, contact your service provider.

Using bookmark

At the home screen:

1. Select **M**enu > **W**eb Browser.
2. Select **O**K to accept browser fees.
3. From your Web home page, select **B**ookmarks. A list of bookmarks appears.
4. Enter the number corresponding to the bookmark you want and press the **O**K key.

Checking Browser Alerts

Alerts received from a Web site are sent to your Browser Alerts folder. To check them:

1. Select **M**enu > **M**essages > **B**rowser Alerts.
This action launches the browser inbox.
2. Select **O**K to accept browser fees.
3. Select an alert and follow the prompts.

Web Alert

You can set a prompt to confirm the start or exit of the Web Browser.

Select **M**enu > **S**ettings > **N**etwork > **W**eb Alert and one of the following:

- **A**t **S**tart to set a prompt when you start a session.
- **A**t **E**nd to set a prompt when you end a session.
- **B**oth to set a prompt when you start or end a session.
- **N**o **P**rompts for no prompts.

Call lists

Details on the last 60 calls you made, received, or missed are stored in the Recent Calls list and are identified by the following icons:



Outgoing call



Incoming call



Missed call (flashing)

View recent calls

1. Select **Menu > Recent Calls** and one of the following:
 - **All Calls** to view all calls made or received.
 - **Incoming Calls** to view calls answered.
 - **Outgoing Calls** to view calls made.
 - **Missed Calls** to view calls received, but not answered.
2. Highlight a recent call.
3. Press the **Send** key to call the number or select **Options** and one of the following:
 - **Save** creates a new contact or **View** displays the contact's detail screen.

- **Send Text Msg** sends a text message to the number.
- **Send Picture Msg** sends a picture message to the number.
- **Erase Record** deletes the call from the call list.

Note: If the phone number is classified as “secret,” you must enter your four-digit lock code to access it.

Deal with missed calls

When you have missed a call, “Missed Call” appears on your screen unless the caller leaves a voicemail. You can do one of the following:

- To clear the screen, select **OK**.
- To view the call details, select **Calls** and press the **OK** key.
- To return the call, select **Calls** and press the **Send** key.

Set alert for missed calls

You can set an alert to beep every five minutes after you have missed a call. Select **Menu > Settings > Alerts > Missed Call Alert**. See “Other alerts” on page 56.

Erase call lists

You can erase your phone's call lists.

1. Select **Menu > Recent Calls > Erase Call Lists > All Calls, Incoming Calls, Outgoing Calls, or Missed Calls.**
2. Select **Yes.**

Call timers

View call timers

Select **Menu > Recent Calls** and one of the following:

- **Recent Calls Timer** tracks all calls you have made and received since you last reset this timer. To reset this timer to zero, select **Reset.**
- **All Calls Timer** tracks all calls you have made and received. You cannot reset this timer.

Time your calls

Your phone can alert with a short beep ten seconds before each minute passes during a call.

Select **Menu > Settings > Alerts > Minute Alert > Enabled.**

8 CONTACTS

Use your phone's contacts list to store information about a person or company. Each contact entry can have up to six phone numbers, two email addresses, two Web addresses, two street addresses, and a space for notes.

Viewing contacts list

To view existing contacts in your phone, open the flip and select **Menu > Contacts > View All**. Your contacts list is displayed alphabetically.

Tip: You can also select **Contacts** from the home screen to view the directory.

Scroll to highlight the contact you want and you can do one of the following:

- Press the **Send** key to call the highlighted contact.
- Press the **OK** key to view the highlighted contact's detail.
- Select **New** to add a new contact.
- Select **Options** to choose one of the following:
 - **Call** to make a call.
 - **Send Text Msg** to send a text message.
 - **Send Picture Msg** to send a picture message.
 - **View Contact** to view contact details.
 - **Edit Contact** to edit contact details.
 - **Erase Contact** to erase the contact.

- **Send as vCard** to send contact as a vCard.
- **Send All** to send all contact information.
- **Contacts Menu** to access your contacts.

Adding contacts

Add contact from home screen

To add a contact to your contacts list:

1. From the home screen, enter a phone number to save (including the area code).
2. Select **Save > Save New Contact**.
3. Enter a name for the contact. For more information, see “Text entry” on page 17.
4. Enter additional phone numbers, email addresses, Web addresses and note, if needed. Scroll up or down to move through the contact fields.
5. When you are done entering information, select **Save**.

Add contact from contacts menu

To add a contact to your contacts list:

1. Select **Menu > Contacts > Add New**.
2. Enter a name for the contact. When you are done, scroll down to move to the next field. For more information, see “Text entry” on page 17.
3. Enter a primary number for the contact.

4. Enter additional phone numbers, email addresses, Web addresses and note, if needed. Scroll up or down to move through the contact fields.
5. When you are done entering information, select **Save**.

Add code or extension

When you save the phone number of an automated service, you may include a pause to stop dialing. For example, a pause where you would wait to dial an extension.

1. From the home screen, enter a phone number.
2. Select **Options** and a type of pause:
 - **Time Pause** causes the phone to stop dialing for two seconds.
 - **Hard Pause** causes the phone to stop dialing until you select **Options > Release** while making the call.
3. Enter the remaining numbers and select **Save**.
4. Select **Save New Contact**.
5. Complete the contact and select **Save**.

Working with contacts

Contact details

To edit details of an existing contact:

1. Select **Menu > Contacts > View All**.
2. From the contacts list, select a contact.

3. At the contact's detail screen, select **Edit**.
4. Edit or add phone numbers, email addresses, Web addresses and notes. Scroll up or down to move through the contact fields.
5. When you are done entering information, select **Save**.

Contact name

To work on the name of an existing contact:

1. Select **Menu > Contacts > View All**.
2. From the contacts list, select a contact.
3. At the contact's detail screen, highlight the name.
4. Select **Options** and one of the following:
 - **Ringer** assigns a specific ringer to the contact.
 - **Picture** assigns a specific picture to the contact.
 - **Erase Contact** erases the entire contact.
 - **Send as vCard** sends the contact as a vCard.

Contact number

To work on the number of an existing contact:

1. Select **Menu > Contacts > View All**.
2. From the contacts list, select a contact.
3. At the contact's detail screen, highlight a contact number.

4. Select **Options** and one of the following:
- **Call** sends a call.
 - **Send Text Msg** sends a text message.
 - **Send Picture Msg** sends a picture message.
 - **Add Speed Dial** adds the number to your speed dial list.
 - **View Number** displays the number.
 - **Erase Number** erases the number from the contact.
 - **Secret** makes the number secret, hiding it from the screen until you enter the lock code. Secret numbers can be called without a lock code. For more information, see “Lock Phone” on page 65.
 - **Primary Number** makes this number the primary number for the contact.
 - **Send as vCard** sends the contact as a vCard.
 - **Add to Group** adds the number to the business, personal or custom group.
 - **Add Voice Dial** records a voice tag so you can call a contact using voice recognition.
 - **Erase Voice Dial** erases the voice tag associated with the number.
 - **Edit Voice Dial** re-records the voice tag.
 - **Prepend** displays the contact’s detail screen for you to change the number (adding an area code) or other data of the contact.

Contact email address

To work on the email address of an existing contact:

1. Select **Menu > Contacts > View All**.
2. From the contacts list, select a contact.
3. At the contact’s detail screen, highlight a contact email address.
4. Select **Options** and one of the following:
 - **Send Text Msg** sends a text message.
 - **Send Picture Msg** sends a picture message.
 - **View Address** displays the email address.
 - **Add to Group** adds the email address to the business, personal or custom group.
 - **Erase Address** erases email address from the contact.
 - **Secret** makes the address secret, hiding it from the screen until you enter the lock code.
 - **Send as vCard** sends the contact as a vCard.

Contact Web address

To work on the Web address of an existing contact:

1. Select **Menu > Contacts > View All**.
2. From the contacts list, select a contact.
3. At the contact’s detail screen, highlight a contact Web address.

4. Select **Options** and one of the following:
 - **Launch Web** launches the Web Browser and goes to Web address.
 - **Send Picture Msg** sends a picture message.
 - **View Web** displays the Web address.
 - **Erase Web** erases the Web address from the contact.
 - **Secret** makes the address secret, hiding it from the screen until you enter the lock code.
 - **Send as vCard** sends the contact as a vCard.

Contact street address

To work on the street address of an existing contact:

1. Select **Menu > Contacts > View All**.
2. From the contacts list, select a contact.
3. At the contact's detail screen, highlight a contact street address.
4. Select **Options** and one of the following:
 - **View Address** displays the street address.
 - **Erase Address** erases the street address from the contact.
 - **Secret** makes the address secret, hiding it from the screen until you enter the lock code.
 - **Send as vCard** sends the contact as a vCard.

Contact note

To work on the note of an existing contact.

1. Select **Menu > Contacts > View All**.
2. From the contacts list, select a contact.
3. At the contact's detail screen, highlight a note.
4. Select **Options** and one of the following:
 - **View Note** displays the note.
 - **Erase Note** erases the note from the contact.
 - **Secret** makes the note secret, hiding it from the screen until you enter the lock code.
 - **Send as vCard** sends the contact as a vCard.

Assign ringer to contacts

To assign a ringer:

1. Select **Menu > Contacts > View All**.
2. From the contacts list, select a contact.
3. At the contact's detail screen, highlight the contact name.
4. Select **Options > Ringer > Assign Ringer**.
5. Select a ringer from the list. (Scroll through the list to hear the different ringers.)

Assign picture to contacts

To assign a picture:

1. Select **Menu > Contacts > View All**.
2. From the contacts list, select a contact.

3. At the contact's detail screen, highlight the contact name.
4. Select **Options > Picture > Assign Picture** and one of the following:
 - **Camera Pictures** to select a picture from your **Camera Pictures** folder.
 - **Images** to select an image from either your **Saved images** or **Caller IDs**.
5. Scroll to select your desired picture.

Note: With **Mobile Phone Tools (MPT)** for Kyocera, you can transfer digital pictures to your phone. To purchase MPT or other accessories visit www.kyocera-wireless.com/store.

Assign number type

When you assign a number type, an icon is placed in front of the contact number to specify the type of number it is.

1. Select **Menu > Contacts > View All**.
2. From the contacts list, select a contact.
3. At the contact's detail screen, select **Edit**.
4. Scroll down twice to highlight the number type dropdown and press the **OK** key.
5. Select **General, Work, Home, Mobile, Pager** or **Fax**. The appropriate icon appears next to the number in your phone lists.
6. Select **Save**.

Send a vCard

To send contact information as a message:

1. Select **Menu > Contacts > View All**.
2. From the contacts list, select a contact.
3. At the contact's detail screen, highlight the contact name.
4. Select **Options > Send as vCard** and one of the following:
 - **via MMS Msg** (See "Create a multimedia message" on page 36.)
 - **via Bluetooth** (See "Bluetooth® Wireless Technology" on page 67.)

Searching contacts

To find a phone number or contact, you can search the contacts list, use the **Fast Find**, or check the **Frequent List**. See "Fast Find" on page 59 and "Frequent List" on page 59.

To search your contacts list, select **Menu > Contacts > View All, View Groups, Speed Dial List** or **Voice Dial List**.

You can also use the **Contacts** shortcut from the home screen to view the contacts list. To quickly get down the list, enter the first letter of the contact. You skip to that letter of the alphabet.

9 MESSAGES

This chapter describes how to send, receive, and erase messages from your phone. For information on voicemail messages, see “Voicemail” on page 15.

Note: The features and menus described in this chapter may vary depending on services available in your area. Check with your service provider for details and possible usage charges.

Text messages

You can only send text messages to phones capable of receiving them or to email addresses.

Create a text message

At the home screen:

1. Select **Menu** > **Messages** > **New Text Msg.**
2. At the **Send To** field, do one of the following to enter the recipient's phone number or email address:
 - Select **Options** > **Recent List**, **Contacts** or **Groups** to access your stored contacts.
 - Enter the phone number or email address manually. See “Text entry” on page 17.

You can message up to ten recipients at once. Use a comma or spaces to separate addresses. If you select stored contacts, this is done automatically. Scroll down to move to the next field when done.

3. At the **Message** field, enter the message.

4. Select **Send**.

Include QuickText and symbols

During text entry, you can insert prewritten text (QuickText), symbols or smileys.

1. From the text entry screen, select **Options** and one of the following.
 - **Insert QuickText** to insert prewritten text from a list.
 - **Add Symbol** to insert symbols. Press the corresponding number to select a symbol.
 - **Add Smiley** to insert smileys. Press the corresponding number to select a smiley.
2. Complete your message.
3. Select **Send**.

Use text message options

When you are ready to send a text message, you have several options for how and when you want it received.

1. After composing your message, select **Options** and one of the following:
 - **Add Address** returns you to **Send To** field to add another recipient.
 - **Save Message** saves the messages in your **Drafts** folder. This prevents the message from being deleted if you activate **Auto-Erase**.

- **Save QuickText** saves the message you composed as a pre written message.
 - **Settings > Request Receipt** alerts you when a recipient has received your message.
 - **Settings > Set Priority** labels the message as urgent.
 - **Settings > Callback Number** includes a callback number with the message. Select **OK** to include your own number or enter a different one.
 - **Settings > Send Later** schedules a time to send the message.
 - **Settings > Validity Period** allows you to set a defined expiration time limit for a message.
2. After setting options, press the **Back** key to return to the message window.
 3. Complete your message.
 4. Select **Send**.

Retrieve a text message

When a text message is received, your phone displays a notification and the message icon appears at the top of your screen. The message icon flashes if the message is urgent. Urgent messages are also marked in the **Inbox**.

Message notifications

If you see a message notification, select **Inbox** to view messages. Choose a message and select **View** to open it. To clear a message notification, select **Ignore**.

Note: If you receive a new message while you are reading a message, the one you are reading is replaced by the new one. The older message is in the **Inbox**.

Message icons

If you see the message icon, select **Menu > Messages > Inbox**. Choose a message and select **View** to open it.

View a text message

The options available when viewing a text message may vary. Check with your service provider.

1. Select **Menu > Messages > Inbox**.
2. Select **View** to read a message. If the message is long, scroll down to view the entire message.
3. Select **Reply** to create a response message or **Options** and one of the following:
 - **Erase** erases the message.
 - **Lock Msg** protects the message from the accidentally deleted.
 - **Forward** forwards the message.
 - **Reply with Copy** replies to the message with a copy of the original attached.

- Save Message saves the message.
- Save QuickText saves the message text as QuickText, which you can insert into other messages. Graphics and sounds are not saved.
- Sender displays the sender information.

Note: If a graphic is too large or incorrectly formatted, and is not received with the message, an icon appears.

Multimedia messages

You can only send multimedia messages to phones that are capable of receiving them or to email addresses.

Multimedia messages have a predetermined character and file size limit. When you reach the character and file size limit for a single multimedia message, you must edit the message to meet the size limitation.

Note: Multimedia messaging is not available on all phones. Check with your service provider.

Create a multimedia message

At the home screen:

1. Select **Menu > Messages > New Picture Msg.**
2. At the **To**, **CC** (to send a copy of the message), and **BCC** (to send a blind copy) fields, do one of the following to enter the recipient's phone number or email address. Scroll down to move to the next field when done.

- Select **Options > Recent List, Recent Calls, Contacts, or Groups** to access your stored contacts.
- Enter the phone number or email address manually. See "Text entry" on page 17.

Note: You can message up to ten recipients at once. Use a comma or spaces to separate addresses. (If you select stored contacts, your phone does this automatically.)

3. At the **Subject** field, enter a subject. Scroll down to move to the next field when done.
4. At the **Text** field, enter a message. Scroll down to move to the next field when done.
5. At the **Image** field, select **Options** and one of the following to attach a file:
 - **Take Picture** to instantly take a photo and attach it.
 - **Media Gallery** to attach an existing file from **Camera Pictures** or **Images**.
 Scroll down to move to the next field when done.
6. At the **Sound** field, select **Options** and one of the following to attach a file:
 - **Record Sound** to instantly record a sound and attach it.
 - **Media Gallery** to attach an existing file from **Saved Sounds, Ringers** or **Voice Memos**.
7. Select **Send**.

Use multimedia message options

When you are ready to send a multimedia message, you have several options for how and when you want it received.

1. While composing your message, select Options and one of the following:
 - **Insert Contacts** allows you to add contacts to your message.
 - **Quick Text** allows you to add prewritten text to your message.
 - **Save QuickText** allows you to save your message as prewritten text.
 - **Preview Message** plays your message.
 - **Save Message** saves the message to the draft folder.
 - **Add Address** adds additional recipients to your message.
 - **Message priority** labels the message as urgent.
2. After setting options, press the **Back** key to return to the message window if necessary.
3. Complete your message.
4. Select **Send**.

Retrieve a multimedia message

There are two modes for receiving a multimedia message on your phone: **Auto Retrieve** (default) and **Prompt**.

Auto retrieve mode

When a message is received, it is automatically downloaded onto your phone. A notification appears when a new message has been downloaded to your phone. Select one of the following:

- **View** opens the message.
- **Later** downloads and sends the message to the Inbox for you to view later.

Note: If a message is received during a call, the phone downloads the message approximately one minute after the last key is pressed.

Prompt mode

When a multimedia message is received, it is not automatically downloaded onto your phone. A notification appears when a new message is available for download. Select one of the following:

- **View** downloads and opens the message.
- **Erase** deletes the message.
- **Later** downloads and sends the message to the Inbox for you to view later.

Note: If a multimedia message is received during a call, the phone displays a notification after the call ends.

View a multimedia message

When a multimedia message is received, the message icon appears at the top of your screen. The message icon flashes if the message is urgent. All notifications or messages are stored in the Inbox regardless of your Auto Retrieve settings.

1. Select **Menu > Messages > Inbox**.
2. Select **View** to read a message. If the message is long, scroll down to view the entire message.
3. Select **Reply** to create a response message or **Options** and one of the following:
 - **Mute/Unmute** enables or disables silencing the message.
 - **Erase** deletes the message.
 - **Forward** forwards the message without showing the original address, graphic, sound, and text fields.
 - **Lock Msg** avoids erasing the message accidentally.
 - **Message Info** displays the message information (priority, sender, subject, time sent and received, and message size).
 - **Replay** plays the message again from the beginning.
 - **Done** exits the message.
 - **Save Picture** saves the picture embedded in the message.

- **Save Sound** saves the sound embedded in the message.
- **Save Address** extracts email addresses, phone numbers, and/or URLs from the sender information and message body.
- **Save QuickText** saves the text in the message to the QuickText list.
- **Call** calls the message sender.
- **Save Message** saves the message to the Saved Folder.

Note: The options available to you may vary. Check with your service provider.

Erasing messages

It is a good idea to erase old messages to free up memory in your phone.

You can erase messages and pages as you send or read them, erasing them one at a time, or erasing them all at once.

Erase a single message

At the home screen:

1. Select **Menu > Messages > Inbox, Sent, Outbox, Saved, or Drafts**.
2. Highlight the message you want to erase.
3. Select **Erase** or **Options > Erase** depending on your selected folder.
4. At the notification, select **Yes** to erase the message.

Erase all messages

At the home screen:

1. Select **Menu > Messages > Erase Messages > Inbox, Sent, Outbox, Saved Folder, Drafts Folder or All Messages.**
To erase messages from all folders, select **All Messages.**
2. At the notification, select **Yes** to erase the messages.

Working with messages

The following are some messaging tips.

Unable to send messages

You may not be able to send or receive messages if your phone's memory is nearly full, or if digital service is not available at the time. To free up memory, erase old messages.

See “Erasing messages” on page 38.

Appended messages

If you go over the character limit for a single message, the phone may automatically append an empty segment to your message to make space.

Important: Your service provider charges you for each message segment.

When you start a message, the maximum character limit appears once you are in the message entry field. This number counts down as you enter characters, until it reaches 0.

If you continue to enter text after this counter reaches 0, a message segment may be appended. When you reach the message size limit, you are prompted to edit the message or alerted that the message is being appended.

Note: Appended messages may not be available on all phones. Check with your service provider.

Receive incoming calls while creating messages

If you receive a call while creating a message, a notification appears. You can do the following:

- Select **Ignore** to return to the message creation screen without answering the call.
- Press the **Call** key to answer the call and save the created message to the Drafts folder.

Complete messages in Drafts folder

To continue composing a message in the Drafts folder:

1. Select **Menu > Messages > Drafts.**
2. Highlight the message you want to complete.
3. Select **Edit.**
4. Complete your message.
5. Select **Send.**

View messages in Sent folder

To view messages in the Sent folder, select **Menu > Messages > Sent.**

Scroll through the list of messages. One of the following indicators may appear next to each message:



The message has been received.



The message has been received and opened.



The message has been sent to more than one recipient



The message has never been sent or has not been sent since it was last modified. You can cancel delivery of the message.

View failed or pending messages

Failed or pending messages are stored in your Outbox folder. To view messages in the Outbox folder, select **Menu > Messages > Outbox**.

Your list of failed or pending messages will appear with the following symbols.



The message is pending and will be sent when possible. You can cancel delivery of the message.



The message cannot be sent because service is not available. An alert appears on your phone if the message cannot be sent.

Creating group lists

You can create and save a list of multiple recipients. Your phone stores five group lists with up to ten recipients per list.

1. Select **Menu > Messages > Group Lists > Create New**.
2. Enter a name for the group.
3. Select **Next**.
4. To enter the first recipient, select one of the following:
 - **Recent List** to select a number from your recent calls.
 - **New Address** to enter one or more recipient's address manually.
 - **Contacts List** to select a recipient from your contacts list.

Select **Options > Recent List** or **Contacts** if you need to enter multiple recipients.

5. When you have completed entering recipients, select **Done**.

You can now send messages to the new group.

Message settings

Message settings help configure your phone's text and picture message settings.

Alerts

To choose how to be alerted of voicemail, pages, or text messages, select **Menu > Messages > Msg Settings > Alerts > Message Alert, Page Alert, or Voicemail Alert** and one of the following:

- **Disabled** turns off the sound alert.
- **Vibrate, Beep, Freeway, Game, Bloop, Winner, or Zilofon** sets the phone to alert you once when receiving a new message.
- **Vibrate & Remind, Beep & Remind, Fwy & Remind, Game & Remind, Bloop & Remind, Winner & Remind, or Zilofon & Remind** notifies you once when receiving a new message and again every five minutes. To stop a reminder alert, select **Ignore**.

Signature

The signature you create is included at the end of all outgoing messages and is counted as characters in your messages; however, it does not appear in the message creation screen.

1. Select **Menu > Messages > Msg Settings > Signature**.
2. Enter your signature in the text field.
3. Select **OK** to save the signature.

Note: The characters in the signature are included in the total character count of the message.

Edit QuickText

Your phone comes with prewritten (QuickText) messages, such as “Please call me,” which you can insert into the body of a text message. You can edit these messages or create new ones. Your phone stores up to 40 QuickText messages, with up to 100 characters per message.

1. Select **Menu > Messages > Msg Settings > Edit QuickText** and one of the following:
 - Highlight a QuickText message and select **Edit**.
 - Select **New Msg** to create a new QuickText message.
2. Enter or edit the text.
3. Select **Done**.

Note: You can also save a message you have written or received as QuickText.

Auto Retrieve

To set your phone to automatically retrieve multimedia messages, select **Select Menu > Messages > Msg Settings > Auto Retrieve** and one of the following:

- **Enabled** turns on auto retrieve.
- **Disabled** turns off auto retrieve. You are prompted before any multimedia messages are downloaded.

Show/Hide CC/BCC

To show or hide the CC and BCC fields when you are composing a picture message, select **Menu > Messages > Msg Settings > Show CC/BCC** or **Hide CC/BCC**.

Callback Number

Set a callback number to let recipients know at what number they can call you back.

1. Select **Menu > Messages > Msg Settings > Callback Number**.
2. Enter a number in the text field.
3. Select **OK** to save the number.

Text and Picture Message Receipt

To request a notification when a recipient has received a text or multimedia message, select **Menu > Messages > Msg Settings > Text Msg Receipt** or **Pict Msg Receipt > Request**.

Save to Sent

You can save your outgoing messages. Select **Menu > Messages > Msg Settings > Save to Sent** and one of the following:

- **Disabled** does not save outgoing messages.
- **Prompt** allows you to choose whether or not to save your message when you send it.
- **Enabled** saves all outgoing messages to the Sent folder.

Auto-Erase

You can set your phone to erase messages automatically when memory is needed for incoming messages.

Select **Menu > Messages > Msg Settings > Auto-Erase** and one of the following:

- **Disabled** erases no messages.
- **Inbox Msgs** erases old messages in your Inbox when memory is needed.
- **Sent Msgs** erases old messages in your Sent folder when memory is needed.
- **Both** erases old messages in both your Inbox and Sent folder when memory is needed.

Default Text

You can change the default text entry mode when creating a text message. This setting applies only to the message body screen, not the “To” screen.

Select **Menu > Messages > Msg Settings > Default Text** and one of the following:

- **Normal Alpha** to enter text in letter by letter.
- **Rapid Mode** to enter text with word recognition.

Voicemail Number

Set the number your phone calls to retrieve voicemail. Often your voicemail number is automatically programmed by your service provider.

1. Select **Menu > Messages > Msg Settings > Voicemail Number**.
2. Select **Edit**.
3. Enter the voicemail number. Use **Option > Time Pause** or **Hard Pause** to enter pauses.
4. Select **Save**.

10 CAMERA

The following are some tips for you to operate your phone's camera:

- You cannot activate the camera while on an active call or while browsing files in the media gallery.
- Once the camera is active, the home screen acts as the viewfinder.
- If you get a “Low memory” error, check your resolution and quality compression settings.
- If there is no activity within 45 seconds after you turn your camera on, the camera quits and returns to the previous launch point.
- Menu settings and options can only be accessed when the camera is active.

Taking a picture

To take a picture:

1. Activate the camera in one of the following ways:
 - Press the **Camera** key until the camera screen appears.
 - Select **Menu > Camera**.
2. Focus on the image using the phone's display as a viewfinder.
3. Take a picture in one of the following ways:
 - Press the **OK** key.
 - Press the **Camera** key.

- Select **Capture**.

The picture is saved to your Camera Pictures folder.

4. Select **Send** to create a multimedia message or **Erase** to delete the picture from your phone.
5. Press the **End** key to exit camera mode.

Camera mode options

You can set up how your camera takes pictures. While in camera mode, select **Options** and one of the following:

- **Settings** displays the following camera settings you may set up prior to taking a picture:
 - **Flash** sets the camera flash as **Automatic**, **On**, or **Off**.
 - **Resolution** sets the horizontal and vertical number of pixels for the picture.
 - **Low Light Mode** brightens the picture for low light environments.
 - **Self Timer** sets up a countdown timer to automatically take a picture when the timer expires. When set, the camera beeps from 3 seconds down to the time the shutter automatically snaps the picture (unavailable for Multishot mode).

- **Multishot** takes up to six multiple pictures with the **Camera** key pressed and held. A tone plays each time a picture is taken. A second tone plays when the final picture is taken.
- **Shutter Sound** sets the sound used when the camera takes a picture.
- **White Balance** adjusts the camera for different lighting.
- **Color Tone** sets the color tone of the picture.
- **Quality** sets the picture compression. The higher the compression, the better the detail of the picture (higher pixel rate). When set to **High**, the picture file size is larger, using more memory.
- **LED** flashes the indicator light when taking a picture.
- **Viewfinder Display** sets the camera viewfinder as **Fullscreen** or **Actual**.
- **Brightness** adjusts the brightness of the image in the home screen LCD.
- **Camera Pictures** displays all pictures taken and stored.
- **Last Picture** displays the most recently taken picture.
- **Frames** adds a frame or a stamp to your picture. A frame or stamp cannot be removed once it has been used in a picture. The picture resolution changes to 120 x 160 (with the number keypad) or 160x120 (with the QWERTY keypad) while taking pictures with **Frames** enabled. The resolution returns to the original setting with **Frames** disabled.

Note: The following settings revert to the default setting each time you enter and exit the camera application: **Low Light Mode**, **SelfTimer**, **MultiShot**, and **Viewfinder Display**.

Camera indicators and icons

The camera may display the following on screen indicators and icons.

Note: Numbers in the top right corner indicate the number of snapshot remaining. Numbers in the bottom left corner indicate the resolution setting for pictures.



Flash is on.



Camera is in camera mode.



Multishot feature is on.



Self-timer feature is on



Camera zoom mode is ready.

11 MEDIA GALLERY

The Media Gallery stores camera pictures, images, and sounds in the phone and displays those files on the phone's screen.

Accessing folders

To access the folders where your phone stores files, select **Menu > Media Gallery** and one of the following:

- **Camera Pictures** displays thumbnails of the photos you have taken.
- **Images** contains image files that are preloaded, downloaded, saved or created.
- **Sounds** contains sound files that are preloaded, downloaded, saved or created.

Browsing camera pictures

To browse the Camera Pictures folder:

1. Select **Menu > Media Gallery > Camera Pictures**.
2. At your picture list, highlight a picture and select **View**.
3. Select **Send** to create a message with the picture attached or select **Options** and one of the following:
 - **Erase** erases the picture.
 - **Assign** assigns the picture as a Caller ID or wallpaper.

- **Modify > Options > Rotate** rotates the picture by 90° right, 180°, 90° left, flip horizontal or flip vertical.
- **Modify > Options > Resize** resizes the picture to 90%, 75%, 50%, or 35%.
- **Modify > Options > Brightness** adjusts the brightness.
- **Modify > Options > Sharpness** adjusts the sharpness.
- **Modify > Options > Saturation** adjusts the saturation.
- **Modify > Options > Hue** adjusts the hue.
- **Modify > Options > Auto Adjust** automatically adjusts all levels.
- **Modify > Options > Color Tone** changes the picture to grayscale, negative, sepia, or emboss.
- **Zoom** zooms in or out on the picture.
- **Take picture** activates camera mode.
- **Lock/Unlock** disables or enables accidental erasing of the picture.
- **Rename** renames the picture.
- **Details** shows the file details.

Browsing images

To browse the Images folder:

1. Select **Menu > Media Gallery > Images** and one of the following:
 - **Saved images** displays images available.
 - **Wallpapers** displays wallpapers available.
 - **Screensavers** displays screen savers available.
 - **Caller IDs** displays the IDs you have assigned to pictures and images.
2. Highlight a file and select **View**.
3. Depending on your selection, you can do the following:
 - With **Saved images** selected, select **Send** to create a message or **Options > Assign** to assign the selected image.
 - With **Wallpapers** or **Screensavers** selected, select **Set default** to assign the image or **Details** to check the file details.
 - With **Caller IDs** selected, select **Send** to create a message or **Options > Erase, Assign, Lock, Rename, or Details** to perform your desired task on the selected image.

Browsing sounds

To browse the Sounds folder:

1. Select **Menu > Media Gallery > Sounds** and one of the following:
 - **Saved Sounds** displays sounds available.
 - **Ringers** displays ringers available.
 - **Voice Memos** contains voice memos you have made.
2. At the folder list, highlight a file.
3. Depending on your selection, you can do the following:
 - With **Saved Sounds** selected, select **Send** to create a message or **Options > Assign** to assign the selected sound.
 - With **Ringers** selected, select **Assign** to assign the sound or **Options > Details** to check the file details.
 - With **Voice Memos** selected, select **Send** to create a message or **Options > Play, Record new, Erase, Lock, Rename, Details, or Erase All** to perform your desired task on the selected sound.

Playback tools

Use the **Navigation** key to select the playback tools displayed on the screen. See “Playback tools” on page 49.

12 TOOLS & GAMES

Your phone comes with tools and games. Some of the games or tools described here may not be available on your phone.

If you receive an incoming call while you are playing a game, the game is paused and exited. You can return to play once the call alert ends. Games do not remain paused if the phone is turned off or loses power.

Brick Attack

The goal of this game is to eliminate bricks arranged in levels. You send a moving ball upward using a paddle at the bottom of the screen.

1. Select **Menu > Tools & Games > Brick Attack**.
2. At the notification, select **Yes** to conserve battery.
3. Select **New** to start the game. You have the following options:
 - Scroll left and right to move the paddle.
 - Press the **Back** key to pause the game.
 - Select **Resume** to restart the game.
 - Select **Options > Exit** to exit the game.

Race 21

This game is a timed variation of Black Jack. Each game comprises three 90-second rounds. To score points, add cards in each of the four columns, trying to reach but not exceed 21 in each column during the course of the game.

1. Select **Menu > Tools & Games > Race 21**.
2. At the notification, select **Yes** to conserve battery.
3. Select **New Game** to start the game. You have the following options:
 - Scroll left and right to place the cards.
 - Press the **Back** key to pause the game.
 - Select **Continue Game** to restart the game.
 - Select **Exit Immediately** to exit the game.

Voice Memo

The voice memo tool enables you to record and play back audio memos.

Record voice memos

To record new voice memos:

1. Select **Menu > Tools & Games > Voice Memo > Record New**.

Or press and hold the right **Navigation** key at the home screen.

2. Record your voice memo. Select **Stop** when you are done.
3. Select **Save** to save your memo.

If you receive an incoming call while recording a memo, the memo is saved and the incoming call screen appears.

Review voice memos

To play and use voice memos:

1. Select **Menu > Tools & Games > Voice Memo > Recorded Memos**.
2. At the file list, highlight a file.
3. Select **Send** to create a message with the memo attached or select **Options** and one of the following:
 - **Play** to hear the memo.
 - **Record new** to record a new voice memo.
 - **Erase** to erase the memo.
 - **Lock/Unlock** disables or enables accidental erasing of the picture.
 - **Rename** to rename the sound.
 - **Details** to look at details of the file.
 - **Erase All** to erase all memos stored.

Playback tools

When you playback a sound file, use the **Navigation** key to select the playback tools displayed on the screen.



Start or continue the file.



Stop the playback.



Pause the playback.



Mute the playback.



Unmute the playback.

Scheduler

Use the scheduler to schedule events and set reminder alerts.

Create an event

1. Select **Menu > Tools & Games > Scheduler > Add New Event**.
2. At the **Event Name** field, enter a name. Scroll down to move to the next field when done.
3. At the **Type** field, press **OK** and scroll through the list to select a type.
4. At the **Date** field, press **OK** to change the date.
 - Scroll left or right to move between month, day, and year fields.
 - Scroll up or down to change month, day, and year.

Press **OK** to save date and move to the next field.

- At the Time field, press **OK** to change the time.
 - Scroll left or right to move between hour, minute and AM/PM fields.
 - Scroll up or down to change hour, minute and AM/PM.

Press **OK** to save time and move to the next field.

- At the Duration field, press **OK** to change the duration.
 - Scroll left or right to move between hour and minute fields.
 - Scroll up or down to change hour and minute.

Press **OK** to save duration and move to the next field.

- At the Priority field, press **OK** and select a priority from the list.
- At the Reminder field, press **OK** and select a reminder from the list.
- At the Reminder Sound field, press **OK** and select a reminder sound from the list.
- At the Silent Mode field, press **OK** and select a Silent Mode setting.
- At the Recurring Event field, press **OK** and select an option from the list.
- Select Save.

View events

You can view the events saved to the scheduler.

View by date

- Select Menu > Tools & Games > Scheduler and one of the following:
 - View Month** to see the current month. Days with events are highlighted. Scroll through the calendar and press **OK** to select a date.
 - View Day** to see the current date. Scroll right or left to move to another date.
 - Go to Date** to select a specific date. Scroll left or right to move between month, day, and year fields. Scroll up or down to change month, day, and year. Press **OK** to select the date.
- At the day view, do one of the following:
 - Highlight an existing event and press the **OK** key to view the event detail.
 - Highlight a time and select Add New to create a new event.
 - Select **Options** > Go to Today to return to the current date.
 - Select **Options** > Go to Date to select a specific date.
 - Select **Options** > Erase all Events to erase all event for that date.

View by list

1. Select **Menu > Tools & Games > Scheduler > View All Events.**
2. At the event list, highlight a event.
3. Select **View** to see the event detail or one the of the following:
 - Select **Options > Sort by Time** to sort events by time.
 - Select **Options > Sort by Type** to sort events by type.
 - Select **Options > Sort by Priority** to sort events by priority.

Modify an event

You can modify existing events. From the event detail screen, you can select **OK** to return to the previous screen or **Options** and one the following:

- **Edit** to change the event.
- **Erase** to erase the event.
- **Send** to create a text message containing the event.
- **Copy** to copy the event.

Scheduler settings

You can change the default settings of your scheduler. Select **Menu > Tools & Games > Scheduler > Settings** and one the following:

- **Scheduler Hours** to change the work day.
- **Auto Delete** to select when events are automatically deleted.

- **Priority** to select the priority given to new events.
- **Reminder** to select the reminder given to new events.
- **Reminder Sound** to select the sound alert given to new event reminders.
- **Silent Mode** to select whether phone is in silent mode during the duration of new events.

Alarm Clock

You can set up to four alerts with your phone's three alarm clocks and one quick alarm.

Note: The alert occurs only if the phone is on.

Use alarm clocks

1. Select **Menu > Tools & Games > Alarm Clock.**
2. Highlight one of the alarms and select **Set.**
3. At the **Time** field, press **OK** to change the time.
 - Scroll left or right to move between hour, minute and **AM/PM** fields.
 - Scroll up or down to change hour, minute and **AM/PM.**Press **OK** to save time and move to the next field.
4. At the **Alarm Sound** field, press **OK** and select a sound from the list.
5. At the **Recurring Alarm** field, press **OK** and select an option from the list.
6. At the **Note** field, enter a note and press **OK.**
7. Select **Save.**

When the alarm rings, select **Off** to turn off the alarm or **Snooze** to silence the alarm for 10 minutes.

Tip: Opening the flip turns off the alarm.

Use quick alarm

1. Select **Menu > Tools & Games > Alarm Clock**.
2. Highlight the quick alarm and select **Set**.
3. At the **Time** field, select a time option. A notification shows the quick alarm is on.

When the quick alarm rings, select **Off** to turn off the alarm or **Reset** to set the quick alarm again.

Tip Calculator

The tip calculator helps you calculate how much tip to include with a bill.

1. Select **Menu > Tools & Games > Tip Calculator**.
2. Enter the amount of your bill and select **N ext**.
3. Select the percentage amount to tip. The new bill amount is shown.
4. Select **Done** to return to menu or **Split** to split the bill. To split the bill, enter the number of guests and select **N ext**. The phone shows the amount each guest pays. Select **Done** to return to menu.

Calculator

Use the calculator for basic mathematical equations.

1. Select **Menu > Tools & Games > Calculator**.
2. Enter the first number.
3. Use the **Navigation** key to select mathematical operation.
 - Press left to multiply.
 - Press right to divide.
 - Press up to add.
 - Press down to subtract.
4. Enter the second number and press **OK** to get the result.
5. Select **Exit** to return to menu or **Options** and one of the following:
 - **M+** adds the displayed result to the value stored in memory.
 - **MR** displays the currently stored value on the screen.
 - **MC** clears the currently stored value in memory.

Timer

The timer counts down for the specified time and beeps when that amount of time has elapsed.

1. Select **Menu > Tools & Games > Timer > Set**.
2. At the **Set Timer**, enter the time length.
 - Scroll left or right to move between hours, minutes and seconds fields.

- Scroll up or down to change hours, minutes and seconds.
3. If need, select **Sound** and one of the sounds to change the sound.
 4. To work the timer, select the following options:
 - **Start** to begin the countdown.
 - **Stop** to pause the countdown.
 - **Reset** to clear the timer.

When the countdown is complete select **Off** to silence the alarm.

Stopwatch

The stopwatch counts time for you.

1. Select **Menu > Tools & Games > Stopwatch**.
2. To work the stopwatch, select the following options:
 - **Start** to begin counting.
 - **Stop** to pause counting.
 - **Reset** to clear the stopwatch.

Press the **Back** key to return to the menu.

Flashlight

Your phone comes with a flashlight. Select **Menu > Tools & Games > Flashlight > Turn On** or **Turn Off** to activate or deactivate the light, which stays on until you turn it off.

Note: You can also press and hold the **Back** key to turn on the flashlight. Once you release the **Back** key, the flashlight turns off.

13 SETTINGS

Menu options

The contents of the Settings menu are as follows:

Sounds

Silent Mode
Volume
Ringers
Flip Sounds
Pwr On/Off Sound
Keypad

Alerts

Minute Alert
Message Alert
Page Alert
Voicemail Alert
Missed Call Alert

Display

My Banner
Main Menu View
Color Themes
Wallpaper
Screensaver
Backlighting
Auto-Hyphen
Language
Time/Date Format
Brightness

My Phone

Keyguard
Convenience
Voice Features

Accessories

Headset Ringing
Auto-Answer
Pwr Backlighting
Com Port Speed
TTY Device
T-coil Hearing Aid

Network

Data/Fax Calls
Privacy Alert
Roam/Svc Alert
Roam Option
Set Phone Line
Location
Web Alert
Roam Call Alert

Security

Lock Phone
Limit Calls
New Lock Code
Erase Contacts
Emergency Numbers

Note: Some features may not be available. Check with your service provider.

Sounds

Your phone has several settings for sound control. You can select from a variety of ringers and control the volume.

Silent Mode

Your phone is set to make sounds when you receive calls, press keys, navigate through menus, and receive alerts (such as new messages). You can silence all sounds and set the phone to vibrate or light up when you receive calls and alerts.

Select **Menu > Settings > Sounds > Silent Mode** and one of the following:

- **Vibrate Only:** The phone vibrates for the duration of the incoming call or other alerts.
- **Vibe then Ring:** The phone vibrates for the first 10 seconds and then rings for the remainder of the incoming call alert.
- **Lights Only:** The phone lights up for the duration of the incoming call or other alerts.
- **Normal Sounds:** The phone rings for the incoming call or alert (in effect, returns phone to a non-silent mode).

Note: The phone rings when attached to an external power source (such as a charger), even if all sounds have been silenced.

Volume

Ringer, Speakerphone, Earpiece, and Key

To adjust the volume of the ringer, speakerphone, earpiece, or key:

1. Select **Menu > Settings > Sounds > Volume > Ringer Volume, Spkrphone Volume, Earpiece Volume, or Key Volume**.
2. Scroll right to increase the volume, or left to decrease the volume.
3. Select **Save**.

Smart Sound

To automatically adjust the volume during a call based on surrounding noise levels, select **Menu > Settings > Sounds > Volume > Smart Sound > Enabled**.

Ringers

Type, Business, or Personal

You can choose the ringer type for incoming calls and assign a ringer to contacts in your personal or business group. Select **Menu > Settings > Sounds > Ringers > Ringer Type, Business Ringer, or Personal Ringer** and a ringer. You can hear the ringers as you scroll down the list.

Roam Ringer

Your phone alerts you to roaming calls with a specific ringer. Select **Menu > Settings > Sounds > Ringers > Roam Ringer > Enabled**.

Flip Open or Closed Sound

To set your phone's sound tones when its flip opens or closes, select **Menu > Settings > Sounds > Flip Sounds > Flip Open or Flip Closed** and a sound. You can hear the sounds as you scroll down the list.

Power on/off sound

You can set your phone to play a sound when powering on or off. Select **Menu > Settings > Sounds > Power On/Off Sound > Enabled**.

Keypad

Key Sound

To choose the sound the phone makes when you press its keys, select **Menu > Settings > Sounds > Keypad > Key Sound > Tone, Click, or Off**.

Key Length

To control the length of the keypad tones, select **Menu > Settings > Sounds > Keypad > Key Length > Normal or Long**.

Alerts

Minute Alert

Your phone can alert you with a short beep ten seconds before each minute passes during a call. Select **Menu > Settings > Alerts > Minute Alert > Enabled**.

Other alerts

To choose how to be alerted of voicemail, pages, text messages or missed calls, select **Menu > Settings > Alerts > Message Alert, Page Alert, Voicemail Alert, or Missed Call Alert** and one of the following:

- **Disabled** turns off the sound alert.
- **Vibrate, Beep, Freeway, Game, Bloop, Winner, or Zilofon** sets the phone to alert you once when a new message is received.
- **Vibrate & Remind, Beep & Remind, Freeway & Remind, Game & Remind, Bloop & Remind, Winner & Remind, or Zilofon & Remind** sets the phone to notify you once when a new message is received and then notify you again every five minutes. To stop a reminder alert, select **Ignore**.

Display

My Banner

The banner is the personal label for your phone. It appears on the home screen above the time and date. The banner can be up to 14 characters long. To change your banner:

1. Select **Menu > Settings > Display > My Banner**.
2. Select **Edit** and press the **Back** key to clear the current banner.
3. Enter your new text and select **Save**.

Main Menu View

To select a menu style, select **Menu > Settings > Display > Main Menu View** and one of the following:

- **Graphic** displays icons of each menu item, with its name at the bottom of the screen.
- **List** displays a list of each menu item.

The next time you select **Menu** from the home screen, your selected menu style appears.

Color Themes

You can select a color theme for the display background of your phone. Select **Menu > Settings > Display > Color Themes** and a color theme. You can preview the themes as you scroll down the list.

Wallpaper

You can select a wallpaper for your phone's home screen. Select **Menu > Settings > Display > Wallpaper** and one of the following options:

- Scroll to highlight a wallpaper, press the **OK** key, and select **Assign** to select a wallpaper.
- Select **Options > Take Picture** to take a new picture.
- Select **Options > Camera Pictures** to select an existing picture.
- Select **Options > Images** to select an image from your images folder.

Follow the prompts to save your selection.

Screen saver

Screen savers appear on the home screen when the flip is open or closed. A screen saver activates 10 seconds after the last keypress. Incoming calls and alerts override the screen savers. Select **Menu > Settings > Display > Screensaver** and one of the following options:

- Scroll to highlight a screen saver, press the **OK** key, and select **Assign** to select a screen saver.
- Select **Options > Camera Pictures** to select an existing picture.
- Select **Options > Images** to select an image from your images folder.
- Select **Options > Take Picture** to take a new picture.

Follow the prompts to save your selection.

Backlighting

Your screen lights up while you are in a call or when you press a key on the keypad. The backlight automatically turns off when the phone is inactive.

Backlight duration

You can set the length of time that bright backlighting remains on. Select **Menu > Settings > Display > Backlighting > Duration** and one of the following:

- **Disabled** turns backlighting off.

- 7 seconds, 15 seconds, or 30 seconds turns backlighting on for the set time after your last keypress.
- 7 sec. & in call, 15 sec. & in call, or 30 sec. & in call turns backlighting on for the duration of a call, and for the set time after your last keypress.

Note: The “in call” settings drain the battery more quickly.

Power save mode

You can conserve battery life by activating power save mode to dim the backlight. The power save mode sets the backlight to the lowest level. Select **Menu > Settings > Display > Backlighting > Pwr Save Mode > On**.

Auto-Hyphen

Auto-hyphenation, when enabled, automatically inserts hyphens into your phone numbers to be consistent with the U.S. dialing plan, such as 1-222-333-4444. Select **Menu > Settings > Display > Auto-Hyphen > Enabled**.

Language

Your phone can display alternative languages. Select **Menu > Settings > Display > Language** and a language.

Time and date format

Your phone can display different time/date formats. Select **Menu > Settings > Display > Time/Date Format** and a format.

Brightness

To change the brightness of the display:

1. Select **Menu > Settings > Display > Brightness**.
2. Scroll to change the brightness.
3. Select **Save**.

My Phone

Keyguard

Lock the keyguard

The keyguard locks the external number keypad on your phone to prevent accidental keypresses when the phone is turned on and a call is not in progress. You can still answer or silence an incoming call.

- To lock the keypad, press and hold the * **Shift** key.
- To unlock the keypad, select **Keyguard** and press the **OK** key.

Set the keyguard

You can set the phone to lock the keypad automatically when the flip is closed. Select **Menu > Settings > My Phone > Keyguard > Guard on Close**.

Convenience

Your phone provides you with settings that may make your phone more convenient to use.

Airplane Mode

While in an airplane, it is normally required that you turn off your mobile phone because it emits RF signals that interfere with air traffic control.

In Airplane Mode, however, your phone does not emit RF signals. You cannot make or receive calls, send text messages, use the Web, or Bluetooth Wireless Connectivity but you can play games, use the Scheduler, set the clock, and make emergency calls to designated emergency numbers.

Please check with uniformed personnel before operating your phone in Airplane Mode.

To set your phone to Airplane Mode, select **Menu > Settings > My Phone > Convenience > Airplane Mode > OK > Enabled**. Follow the prompts to complete enabling the Airplane Mode.

Open to answer

You can open the flip of your phone to answer a call. Select **Menu > Settings > My Phone > Convenience > Open to answer > Enabled**.

Fast Find

To use fast find, select **Menu > Settings > My Phone > Convenience > Fast Find > Enabled**.

With Fast Find enabled, you can press one or two keys to view close matches of the number you are looking for.

1. With the number keypad, from the home screen, press the keys corresponding to the letters of the name you want to find. A matching contact or speed dial entry appears.
2. Highlight the contact you want and press the **Call** key to call the number.

Frequent List

To enable frequent list, select **Menu > Settings > My Phone > Convenience > Frequent List > Enabled**.

From the home screen, select **Contacts**. With the Frequent List enabled, the last 15 contacts of your most frequently called contacts appear. Scroll past the double line to view the entire contacts list.

Hold Call

With the hold call feature, you can place incoming calls on hold until you are ready to answer them.

Note: The hold call feature does not work with the Open to Answer feature enabled. See “Open to answer” on page 59.

Enable hold call feature

1. Select **Menu > Settings > My Phone > Convenience > Hold Call > Enabled** or **Re-Record Msg** (to record a new hold call message). With no hold message recorded, the phone prompts you to record one, such as “Please hold. I’ll answer in a minute.”
2. Record the message twice, as prompted.
3. Select **Save** to save the message or **Options** and one of the following.
 - **Play** to replay your message.
 - **Re-Record** to record your message again.
 - **Exit** to exit.

The next time a call comes in, you can place it on hold.

Place a call on hold

You can place a call on hold once you have enabled the Hold Call feature.

Note: If you are already on a call and you receive another call, you cannot place the incoming call on hold. With no call waiting enabled, the call goes to voicemail instead.

When a call comes in:

1. Select **Hold Call**. The caller is placed on hold and then hear your recorded hold message.
2. Select **Answer** to speak to the caller on hold or **End Call** to hang up without speaking.

Change the hold message

1. Select **Menu > Settings > My Phone > Convenience > Hold Call > Re-Record Msg**.
2. Record the message twice, as prompted.
3. Select **Save** to save the message or **Options** and one of the following.
 - **Play** to replay your message.
 - **Re-Record** to record your message again.
 - **Exit** to exit.

1-Touch Dialing

The 1-Touch Dialing feature is the fastest way to speed dial a contact that has a speed dial location. To use 1-Touch Dialing, you must enable 1-Touch Dialing on your phone and have a speed dial location assigned to a contact.

To enable 1-touch dialing, select **Menu > Settings > My Phone > Convenience > 1-Touch Dialing > Enabled**.

To call a contact that has a speed dial location, press and hold the speed dialing number.

Note: If it is a two-digit number, press the first digit briefly, then press and hold the second digit. For example, if the speed dialing location is 15, press 1 briefly, then press and hold 5.

Voice Features

The following features enable you to customize the voice commands.

Add Voice Dial

You can add a new voice dial to your phone.

1. Select **Menu > Settings > My Phone > Voice Features > Add Voice Dial**.
2. At the voice prompt, say a name.
3. At the voice prompt, repeat the name.
4. Select one of the following:
 - **Add New** creates a new contact.
 - **Add to existing** adds the voice tag to an existing contact.

Erase Voice Dial

You can erase all existing voice dial tags from your phone. Select **Menu > Settings >**

My Phone > Voice Features >

Erase Voice Dial > Yes.

Voice Training

If your phone is having trouble recognizing your voice, you can train with the **Yes**, **No**, and **Wake up** commands. Select **Menu > Settings >**

My Phone > Voice Features > Voice Training > OK > Train All or the item you want to train.

Follow the prompts for each word until training is complete.

Voice Wake-Up

You can set your phone to make a call using a hands-free accessory.

Note: Voice Wake-up does not work with keyboard active.

Enable voice wake-up

Select **Menu > Settings > My Phone >**

Voice Features > Voice Wake-Up >

With Accessory to enable calls with an accessory.

Use voice wake-up

To wake up the phone:

1. Say “Wake Up” and listen for a tone.
2. Say “Wake Up” again until you hear two tones.

If the phone does not recognize your Wake Up command, see “Voice Training” on page 61.

Voice Answer

You can set your phone to answer a call automatically when using a hands-free accessory.

Enable voice answer

Select **Menu > Settings > My Phone > Voice Features > Voice Answer > Enabled** to enable answering calls with an accessory.

To use the voice answer feature, you must have the **Auto-Answer** feature (see “Auto-Answer” on page 62) disabled and the phone set to **Normal Sounds** (see “Silent Mode” on page 55).

Use voice answer

When you receive an incoming call, the phone prompts “Incoming call, answer?” or “Incoming roam call, answer?” If the caller is recognized as a contact entry in your phone, the phone prompts “Incoming call from (Name), answer?” Say “Yes” or press any key except the **End key** to answer.

Say “No” and press the **End** key to silence the alert. Remain silent. The voice alert repeats twice and the phone rings once, then returns to the home screen.

Expert Mode

With the expert mode enabled, instead of speaking a command following the initial voice prompts, you can speak the command after you hear a tone. Select **Menu > Settings > My Phone > Voice Features > Expert Mode** and one of the following:

- **Normal** sets phone to default voice prompts.
- **Expert** sets phone to sound tones instead of voice prompts.

Phone information

You can access information regarding your phone. Select **Menu > Phone Info** and one of the following:

- **Build Info** shows specific software and hardware information for your phone.
- **Icon Keys** shows the icons used by your phone.

Accessories

This section describes settings that affect accessories you use with your phone.

Headset Ringing

With a headset attached to your phone, the ringer can be played through the headset or phone speaker. Select **Menu > Settings > Accessories > Headset Ringing** and one of the following:

- **Out of phone** rings from the phone speaker.
- **Out of headset** rings from the headset.

Auto-Answer

With a headset or hands-free car kit attached, your phone can be set to answer automatically. Select **Menu > Settings > Accessories > Auto-Answer > After 5 seconds** to set the phone to automatically answer after 5 seconds.

Power backlighting

You can set backlighting to remain on when an external power source, such as the AC adapter, is used with the phone.

Note: Power backlighting may not be available with the optional desktop charger or other accessories. The battery charges more slowly with power backlighting on.

Select **Menu > Settings > Accessories > Pwr Backlighting > Normal** or **Always On**.

Tip: Use the power backlighting as a night light when traveling.

Com Port Speed

The Com Port Speed sets the data rate at which your phone connects to a laptop or PC, or at which it sends and receives over-the-air text messages. Select **Menu > Settings > Accessories > Com Port Speed** and your desired speed.

There may be a higher charge for making calls using high-speed data in areas where IX service is available. Check with your service provider for details.

TTY Device

You can connect the phone to a TTY device for the hearing impaired.

Note: Enable TTY only when using the phone with a TTY device.

1. Connect the TTY device to the phone.
2. Select **Menu > Settings > Accessories > TTY Device** (or enter **##889** from the home screen and select **TTY**) **> OK > TTY On**.

T-coil Hearing Aid

You can use your phone with a T-coil Hearing Aid device. Select **Settings > Accessories > T-coil Hearing Aid > OK > Enabled**.

Note: Enable T-coil Hearing Aid only when using the phone with a T-coil Hearing Aid device.

Network

Data and fax calls

Your phone may be able to receive certain data or faxes, depending on the system sending the information. You cannot receive voice calls while the phone is in data/fax mode.

To receive data or faxes, you must connect the phone to a laptop or PC and switch the phone from voice mode to data/fax mode.

Note: To purchase a cable, visit www.kyocera-wireless.com/store.

To enable data/fax mode, select **Menu > Settings > Network > Data/Fax Calls** and one of the following:

- **Voice Only** turns data/fax mode off.
- **Fax, next call** or **Data, next call** sets the phone to data/fax mode for the next incoming call or the next ten minutes.
- **Fax, until off** or **Data, until off** sets the phone to data/fax mode until the phone is turned off.

Privacy Alert

You can set your phone to alert you when enhanced digital CDMA privacy is lost or regained. Select **Menu > Settings > Network > Privacy Alert > Enabled**.

Roaming alert

Use this setting if you want the phone to alert you when roaming outside of your home service area. Select **Menu > Settings > Network > Roam/Svc Alert** and one of the following:

- **Disabled** turns the roaming alert off.
- **When no svc** alerts you with three tones decreasing in pitch when service is lost and three tones increasing in pitch when service is acquired again.
- **On roam change** alerts you with two decreasing tones when roaming service is acquired and three increasing tones when home area service is acquired again.
- **On any change** alerts you with three increasing tones if there is a change in roaming service or three decreasing tones if the phone loses service.

Roam Option

You can restrict your phone from making a call when roaming. Select **Menu > Settings > Network > Roam Option > Automatic** (to allow roaming calls) or **No roaming** (to disallow roaming calls).

Set Phone Line

Your phone can have two service accounts, or phone lines, associated with it. Each phone line has its own phone number. Select **Menu > Settings > Network > Set Phone Line** and one of the two lines.

When you are using one line, you cannot receive calls from the other. It would be as if the phone were “off” for that number. Your voicemail, however, still takes messages. All contacts and settings are shared for both lines.

Note: You must first establish a second phone line with your service provider. Once established, a second phone number becomes available in the menu for selection.

Location

Use this setting to share your location information with network services other than emergency services (for example, 911, 111, 999 and 000) in markets where service has been implemented. Select **Menu > Settings > Network > Location** and one of the following:

- **911 Only** (default) shares your position information only with emergency services when you call your 3-digit emergency code.
- **Location On** shares your position information, in addition to emergency services.

Note: This feature works only when your phone is in digital mode. You cannot turn off the locator to emergency services.

Web Alert

You can set a prompt to confirm the start or exit of the Web Browser.

Select **Menu > Settings > Network > Web Alert** and one of the following:

- At Start prompts when you start a session.
- At End prompts when you end a session.
- Both prompts when you start or end a session.
- No Prompts sets no prompts.

Roam Call Alert

You can set the phone to warn you before you answer or place a call while roaming. Select **Menu > Settings > Network > Roam Call Alert > Call Prompt** to turn on the call guard. The phone emits a distinctive ring to indicate when you are roaming during a call.

To accept or place a call while roaming, you must press 1.

Note: Roam call alert is disabled when the phone is in Emergency Mode.

Security

This section describes all the features involved in securing your phone and preventing access to personal information. All security features are shielded by a four-digit lock code.

Lock Phone

When your phone is locked, you can call only emergency numbers or your service provider's customer service number. You can still receive incoming calls.

1. Select **Menu > Settings > Security**.
2. Enter your four-digit lock code.
3. Select **Lock Phone** and one of the following:
 - Never leaves the phone always unlocked.
 - On power up locks the phone every time you turn it on.
 - Now locks the phone immediately.

To unlock the phone:

1. From the home screen, select **Unlock**.
2. Enter your four-digit lock code.

Limit Calls

You can limit the calls that can be made from your phone to emergency numbers, your contacts, and your service provider's numbers.

1. Select **Menu > Settings > Security**.
2. Enter your four-digit lock code.
3. Select **Limit Calls** and one of the following:
 - No Limit: limits no calls.
 - Limit Outgoing limits outgoing calls. Incoming calls can be answered.
 - Limit All limits both incoming and outgoing calls.

New Lock Code

Change your lock code from the default provided by the service provider. The lock code is typically 0000 or the last 4 digits of your phone number.

1. Select **Menu > Settings > Security**.
2. Enter your four-digit lock code.
3. Select **New Lock Code > Yes**.
4. Enter a new four-digit code.
5. Re-enter your new lock code.

The lock is now changed.

Erase Contacts

You can erase all entries from your contacts list.

1. Select **Menu > Settings > Security**.
2. Enter your four-digit lock code.
3. Select **Erase Contacts > Yes > Yes**.

Emergency Numbers

The emergency numbers feature allows you to specify three personal phone numbers that can be called when the phone is locked.

1. Select **Menu > Settings > Security**.
2. Enter your four-digit lock code.
3. Select **Emergency Numbers**.
4. Select an **Unassigned** slot.
5. Enter the phone number, including the area code. Do not enter 1 before the area code.
6. Select **Done**.

You can view these numbers only when entering them for the first time. To make a call to an emergency number from a locked phone, you must dial the number (including area code) exactly as it is stored in Emergency Numbers.

14 BLUETOOTH® WIRELESS TECHNOLOGY

The Bluetooth® wireless technology on your phone enables wireless connectivity with accessories such as portable or installed hands-free car kits, headsets, handsets, computers, PC cards and adapters, PDAs, and speakers. Not available on all phones. For details check with your service provider.

You must use a Bluetooth wireless technology device (compatible with Class 2 Bluetooth wireless technology, version 1.2) in order to use this phone wirelessly. Bluetooth wireless technology accessories have the  symbol. For additional information on carrier-supported profiles and third-party accessory compatibility for Bluetooth wireless technology, visit www.kyocera-wireless.com/support.

Turning Bluetooth on

You must turn on your phone's Bluetooth feature to use it with Bluetooth wireless technology devices. Select **Menu > Bluetooth > On/Off** and one of the following:

- **On Visible** allows other devices to find your phone.
- **On Invisible** hides your phone for all devices except those listed in your **My Devices**.

- **Off** prohibits your phone from being used with any Bluetooth wireless technology device. To prolong battery life, it is recommended to set Bluetooth to **Off** when you are not using it.

When you turn Bluetooth **On** the first time, you are prompted to do a device search. Then you can pair with a device.

Pairing

You must first “pair” your phone with the Bluetooth wireless technology enabled device to allow your phone to communicate with it. Refer to the following instructions for setting up Bluetooth wireless technology in conjunction with the user guide provided with your Bluetooth wireless technology device.

1. Select **Menu > Bluetooth > On/Off > On Visible** or **On Invisible**.
2. Prepare the Bluetooth wireless technology device (Bluetooth accessory) for pairing as described in the other device's user guide.
3. Select **Menu > Bluetooth > My Devices > Find New**. Your phone then searches and detects visible Bluetooth wireless technology enabled devices in the vicinity.
4. With devices found, select **Add** to see the list.
5. Highlight your desired device and select **Add**.

Note: When pairing is initiated from another Bluetooth wireless technology device, you are prompted to accept or reject the pairing.

6. If necessary, enter the password provided in the Bluetooth wireless technology device's user guide and select **OK**.

Your phone waits for the device's response.

With the password accepted, the device shows in **My Devices**.

Using Bluetooth

Before you can use the Bluetooth wireless technology functions of your phone, you must get your phone ready to communicate with a device. This is called “connecting.”

Connecting to a device

To connect your phone to an audio Bluetooth wireless technology device:

1. Select **Menu > Bluetooth > My Devices**.
2. At the device list, highlight a device and select **Connect**.

A notification appears confirming the connection. You can now use the device with your phone.

Disconnecting from a device

To disconnect your phone from an audio Bluetooth wireless technology device:

1. Select **Menu > Bluetooth > My Devices**.
2. At the device list, highlight a device and select **Disconnect**.

Device list options

You can change or review the information about each device you paired with your phone.

1. Select **Menu > Bluetooth > My Devices**.
2. Highlight your desired device.
3. Select **Options** and one of the following:
 - **Rename** to rename the device.
 - **Delete** to remove the device from your phone if you are no longer going to use it.
 - **Services** to view a description of the device (such as **Headset**, **Handsfree**, **Object Push**, and **Serial Port**).

Bluetooth settings

You can set how your phone interacts with Bluetooth wireless technology devices. Select **Menu > Bluetooth > Settings** and one of the following:

- **My Name** changes the name of your phone for other devices it is paired with to identify.
- **Visible Duration** sets the time your phone remains visible to other devices.
- **Services** shows the list of the Bluetooth wireless technology service protocol supported by your phone.

15 VOICE RECOGNITION

With voice features, you can call a contact, dial a phone number, access menus, or find contact information from your voice dial list using voice recognition.

Note: You cannot use voice recognition to end a call; you must press the **End** key when the flip is open.

Voice dial list

To call or find a contact using voice dial you must add the contact to your voice dial list. The contact name must not have more than three words or components for voice dialing recognition.

Add a voice tag

You can add a voice dial tag to your phone. See “Add Voice Dial” on page 61.

Edit a voice tag

To edit existing voice dial tags:

1. Select **Menu > Contacts > Voice Dial List**.
2. Select your desired contact.
3. Highlight the number with a voice tag and select **Options > Add Voice Dial, Edit Voice Dial or Erase Voice Dial**.
4. Follow the prompts.

Voice commands

With voice commands, you speak your commands into the phone’s microphone.

Start voice commands

1. Press the **Call** key to initiate voice commands. The phone prompts, “Say a name or say dial”.
2. Say one of the following commands and follow the voice prompts.
 - “**Say a name**” to call a contact on your voice dial list.
 - “**Dial**” to speak the digits of the phone number.
3. Press the **Call** key again to exit and go to the Recent calls list.

Call a contact

Before calling a person, you need to add the contact name to the Voice Dial List. See “Add Voice Dial” on page 61.

1. From the home screen, press the **Call** key. The phone prompts, “Say a name”.
2. Say the name of the person you want to call. If the name you said matches a contact in the Voice Dial List, the phone responds: “Calling (Name).” Remain silent to make the call, or say “No” to cancel.

If the phone finds multiple voice tags that sound like the name you said, the phone lists the names and asks you to verify which name you want to call. Say “Yes” when you hear the correct name. Say “No” when you hear an incorrect name.

3. Press the **End** key to end the call.

Call Using Digit Dial

When using digit dialing, you speak digits to dial a phone number.

Note: You cannot speak a string of digits. You must speak one digit at a time and wait for the prompt.

1. From the home screen, press the **Call** key. The phone prompts, “Say a name or say dial”.
2. Say “Dial”. The phone responds “Speak a digit”.
3. Speak the first digit of the phone number you want to call. Once the phone repeats the digit, you can speak the next digit.

If you pause, the phone prompts you with one of the following options. After the prompt, speak an option:

- Say “Clear” to erase the last digit entered. The phone responds: “Digit cleared.” To clear the entire phone number, say “Clear” again. When the phone prompts you with “Clear entire phone number?”, say “Yes” to clear or “No” to cancel.
- Say “Call” to dial the number.

- Say “Verify” to cause phone to repeat the set of digits you input.
- Say “Cancel” to exit voice recognizer and return to the home screen.
- Speak a digit to enter the next digit. Once the phone repeats the digit, you can speak the next digit or pause to hear the prompt.

4. Press the **End** key to end the call.

Voice Command Settings

To customize the voice commands, see “Voice Features” on page 60.

Customer Support

Your service provider's customer support department may be accessible directly from your phone when you dial a number, such as *611 (check with your service provider). They can answer questions about your phone, phone bill, call coverage area, and specific features available to you, such as call forwarding or voicemail.

For questions about the phone features, refer to the materials provided with your phone, or visit www.kyocera-wireless.com.

For additional questions, you may contact the Kyocera Wireless Corp. Customer Care Center in any of the following ways:

- Web site: www.kyocera-wireless.com.
- Email: phone-help@kyocera-wireless.com.
- Phone: 1-800-349-4478 (U.S. and Canada) or 1-858-882-1401.
- Customer support phone numbers are also available in the following countries:

Argentina: 0-800-666-0052

Australia: 1-800-507-000

Brazil: 0-800-55-2362

Chile: 800-43-1212

Colombia: 01-800-700-1546

India: Toll free#: 1-600-121214

Toll#: 0124-284-5000

Mexico: 001-866-650-5103

New Zealand: 0-800-990-100

Panama: 001-800-51-934

Puerto Rico: 1-866-664-6443

Venezuela 0-800-100-2640

Before requesting support, please try to reproduce and isolate the problem. When you contact the Customer Care Center, be ready to provide the following information:

- The name of your service provider.
- The actual error message or problem you are experiencing.
- The steps you took to reproduce the problem.
- The phone's electronic serial number (ESN).

Note: To locate the ESN, select **Menu > Phone Info > Build Info** and scroll down to the number.

Qualified service

If the problem with your phone persists, return the phone with all accessories and packaging to the dealer for qualified service.

Phone accessories

To shop for phone accessories, visit www.kyocera-wireless.com/store. You may also call us at 800-349-4188 (U.S.A. only) or 858-882-1410.

Product evaluation

To participate in the testing and evaluation of Kyocera Wireless Corp. products, including cellular or PCS phones, visit beta.kyocera-wireless.com.

17 CONSUMER LIMITED WARRANTY

Kyocera Wireless Corp. (“KYOCERA”) offers you a limited warranty that the enclosed product or products (the “Product”) will be free from defects in material and workmanship for a period that expires one year from the date of sale of the Product to you, provided that you are the original end-user purchaser of the Product and provided that your purchase was made from an authorized supplier. Transfer or resale of a Product will automatically terminate warranty coverage with respect to that Product. This limited warranty is not transferable to any third party, including but not limited to any subsequent purchaser or owner of the Product.

KYOCERA shall, at its sole and absolute discretion, either repair or replace a Product (which unit may use refurbished parts of similar quality and functionality) if found by KYOCERA to be defective in material or workmanship, or if KYOCERA determines that it is unable to repair or replace such Product, KYOCERA shall refund the purchase price for such Product, provided that the subject Product (i) is returned, with transportation prepaid, to a KYOCERA authorized service center within the one year warranty period, and (ii) is accompanied by a proof of purchase in the form of a bill of sale or receipted invoice which evidences that the subject Product is within the one year warranty period (“Proof of Purchase”).

After the one year warranty period, you must pay all shipping, parts and labor charges.

This limited warranty does not cover and is void with respect to the following: (i) any Product which has been improperly installed, repaired, maintained or modified; (ii) any Product which has been subjected to misuse (including any Product used in conjunction with hardware electrically or mechanically incompatible or used with accessories not approved by KYOCERA), abuse, accident, physical damage, abnormal operation, improper handling, neglect, exposure to fire, water or excessive moisture or dampness or extreme changes in climate or temperature; (iii) any Product operated outside published maximum ratings; (iv) cosmetic damage; (v) any Product on which warranty stickers or Product serial numbers have been removed, altered, or rendered illegible; (vi) cost of installation, removal or reinstallation; (vii) signal reception problems (unless caused by defects in material and workmanship); (viii) damage the result of fire, flood, acts of God or other acts which are not the fault of KYOCERA and which the Product is not specified to tolerate, including damage caused by mishandling, shipping and blown fuses; (ix) consumables (such as fuses); or (x) any Product which has been opened, repaired, modified or altered by anyone other than KYOCERA or a KYOCERA authorized service center.

USE ONLY KYOCERA APPROVED ACCESSORIES WITH KYOCERA PHONES. USE OF ANY UNAUTHORIZED ACCESSORIES MAY BE DANGEROUS AND WILL INVALIDATE THE PHONE WARRANTY IF SAID ACCESSORIES CAUSE DAMAGE OR A DEFECT TO THE PHONE.

KYOCERA SPECIFICALLY DISCLAIMS LIABILITY FOR ANY AND ALL DIRECT, INDIRECT, SPECIAL, GENERAL, PUNITIVE, EXEMPLARY, AGGRAVATED, INCIDENTAL OR CONSEQUENTIAL DAMAGES, EVEN IF ADVISED OF THE POSSIBILITY THEREOF, WHETHER FORESEEABLE OR UNFORESEEABLE OF ANY KIND WHATSOEVER, INCLUDING BUT NOT LIMITED TO LOSS OF PROFITS, UNANTICIPATED BENEFITS OR REVENUE, ANTICIPATED PROFITS ARISING OUT OF USE OF OR INABILITY TO USE ANY PRODUCT (FOR EXAMPLE, WASTED AIRTIME CHARGES DUE TO THE MALFUNCTION OF A PRODUCT) OR CONTRIBUTION OR INDEMNITY IN RESPECT OF ANY CLAIM RELATED TO A PRODUCT.

REPAIR OR REPLACEMENT OF A DEFECTIVE PRODUCT OR REFUND OF THE PURCHASE PRICE RELATING TO A DEFECTIVE PRODUCT, AS PROVIDED UNDER THIS WARRANTY, ARE YOUR SOLE AND EXCLUSIVE REMEDIES FOR BREACH OF THE LIMITED WARRANTY, AND SUBJECT TO THIS WARRANTY, THE PRODUCTS ARE APPROVED AND ACCEPTED BY YOU "AS IS". KYOCERA MAKES NO OTHER WARRANTIES, REPRESENTATIONS OR CONDITIONS OF ANY KIND, ORAL OR VERBAL, EXPRESS OR IMPLIED,

STATUTORY OR OTHERWISE, WITH RESPECT TO THE PRODUCTS, INCLUDING BUT NOT LIMITED TO ANY IMPLIED WARRANTY OR CONDITION OF MERCHANTABILITY OR FITNESS FOR A PARTICULAR PURPOSE OR AGAINST INFRINGEMENT OR ANY IMPLIED WARRANTY OR CONDITION ARISING OUT OF TRADE USAGE OR OUT OF A COURSE OF DEALING OR COURSE OF PERFORMANCE. NO DEALER, DISTRIBUTOR, AGENT OR EMPLOYEE IS AUTHORIZED TO MAKE ANY MODIFICATION OR ADDITION TO THIS WARRANTY.

Some jurisdictions do not allow the exclusion or limitation of incidental or consequential damages, or allow limitations on how long an implied warranty lasts, so the above limitations or exclusions may not apply to you. This limited warranty gives you specific legal rights, and you may also have other rights which vary from jurisdiction to jurisdiction.

For warranty service information, please call the following telephone number from anywhere in the continental United States and Canada: 1-800-349-4478 or 858-882-1401; or contact KYOCERA at the following address: 10300 Campus Point Drive, San Diego, California, 92121-1582, USA, Attention: Technical Support.

DO NOT RETURN YOUR PRODUCTS TO THE ABOVE ADDRESS. Please call or write for the location of the Kyocera Wireless Corp. authorized service center nearest you and for procedures for obtaining warranty service.

INDEX

Numerics

1-touch dialing, 14, 60

A

accessory, 62, 72

add voice dial, 61

airplane mode, 59

alarm clock, 51

alert

 minute, 28, 56

 missed call, 27

 privacy, 63

 roam, 15

 roam call, 65

 roaming, 64

 voicemail, 15

 web, 26, 65

answering calls, 12

appended message, 39

auto receive mode

 multimedia message, 37

auto retrieve, 41

auto-answer, 62

auto-hyphen, 58

Access Apps, 23

B

back cover, 6

 lock, 1, 6

backlight, 57

 power, 62

backlight duration, 57

banner, 56

battery

 caring, 2

 charging, 1

 installing, 1

 recharging, 1

Bluetooth, 67

 connecting devices, 68

 pairing, 67

 settings, 68

 turning on, 67

BREW apps, 23

brick attack, 48

brightness, 45, 58

business ringer, 55

C

calculator, 52

call

 data and fax, 15, 63

 emergency, 16

 guard, 15

 limit, 65

 roaming, 15, 64

call history, 27

call list, 27

call log, 27

call timers, 28

callback number, 42

 text message, 35

calls

 answering, 12

 ending, 13

camera, 44

 color tone, 45

 flash, 6, 44

 indicators and icons, 45

 LED, 45

 lens, 6

 multiple pictures, 45

 options, 44

 resolution, 44

 self timer, 44

 settings, 44

 shutter sound, 45

 taking picture, 44

 white balance, 45

camera pictures

 browsing, 46

capitalization, 18, 21

CC and BCC

 showing or hiding, 42

color themes, 57

color tone, 45

com port speed, 63

contacts, 29

 adding, 29

 adding extension, 30

 adding to group, 31

 adding voice tag, 31

 changing voice tag, 31

 editing, 29, 30

 email address, 31

 erasing, 66

 erasing voice tag, 31

 note, 32

 phone number type, 33

 picture, 30, 32

 primary number, 31

 ringer, 30, 32

 searching, 33

- secret address, 31, 32
- secret note, 32
- secret numbers, 31
- sending all, 29
- sending as a vCard, 29
- sending as vCard, 30, 33
- sending picture message, 31
- sending text message, 31
- speed dial list, 31, 33
- street address, 32
- viewing all, 29
- voice dial list, 33
- Web address, 31

convenience, 59

convention

- using this guide, 11

custom menu, 13

customer support, 71

D

- data and fax call, 63
- default text, 42
- download, 23
- downloading
 - application, 23

E

- earpiece, 13
- email address
 - contacts, 31
- emergency calls, 16
- emergency numbers
 - security, 66
- emergency service
 - location information, 64
- enhancement, 62
- erase contacts, 66
- erase voice dial, 61

- evaluation
 - product, 72
- event
 - adding, 49
 - changing, 51
 - checking, 50
- expert mode, 62
- eyelet, 6

F

- fast find, 59
- flash, 44
- flashlight, 53
- flight mode. See airplane mode, 59
- flip close
 - sounds, 56
- flip open
 - sounds, 56
- folders, 46
- format
 - time and date, 58
- forward
 - text message, 35
- frame, 45
- frequent list, 59

G

- games, 48
 - downloading, 23
- group list
 - creating, 40

H

- hard pause, 30
- hardware information, 62
- headset
 - ringer, 62
- hearing aid, 63
- help, getting, 71

- hold call, 14, 59

I

- icon
 - phone, 62
 - text message, 35
- icons, 8
- images
 - browsing, 47
- incoming call
 - log, 27
- indicators and icons
 - camera, 45

K

- key
 - frequently used, 7
 - navigation, 11
- key length
 - sounds, 56
- keyguard, 58
- keypad
 - number, 3
 - QWERTY, 5
 - sounds, 56

L

- languages, 58
- LED, 45
- left softkey, 11
- limit calls, 65
- location information, 64
- lock
 - back cover, 1, 6
- lock code
 - changing, 66
- lock message, 35
 - multimedia message, 38
- lock phone, 65

- M**
- main menu, 10
 - style, 57
- making calls, 12
- media gallery, 46
- memory, 24
- menu, 10
 - custom, 13
 - settings, 54
 - style, 57
 - Web, 25
- message settings, 40
- messages
 - multimedia message, 36
 - text message, 34
- minute alert, 28, 56
- missed call
 - alert, 27
 - log, 27
- MobileShop, 23
- mode
 - changing, 18, 21
 - entering text, 17
 - normal alpha, 18
 - numbers only, 20
 - rapid entry, 18, 20
- multimedia message
 - appended messages, 39
 - auto receive mode, 37
 - completing, 39
 - creating, 36
 - erasing, 38
 - forwarding, 38
 - locking, 38
 - options, 37
 - prompt mode, 37
 - receipt, 42
 - retrieving, 37
 - saving picture, 38
 - sent, 40
 - tips, 39
 - viewing, 38
 - viewing options, 38
- multiple, 45
- multishot, 45
- my banner, 56
- N**
- navigation key, 11
- new event
 - adding, 49
- normal alpha mode, 18
- note
 - contacts, 32
- number
 - entering, 17, 20
- number keypad, 3
 - entering text, 20
- number type
 - contacts, 33
- numbers only mode, 20
- O**
- open to answer, 59
- outbox, 40
- outgoing call
 - log, 27
- P**
- pairing, 67
- personal banner, 56
- personal ringer, 55
- phone
 - accessories, 72
 - icons, 62
 - information, 62
 - keypads, 3
 - locking, 65
 - making calls, 12
 - number extension, 30
 - overview, 3
 - turning on and off, 12
- phone line
 - setting, 64
- picture
 - contacts, 32
 - multiple, 45
 - saving, 38
- picture message. See multimedia message, 42
- port speed, 63
- power backlighting, 62
- power save mode, 58
- prepend, 31
- primary number, 31
- privacy alert, 63
- prompt mode
 - multimedia message, 37
- Q**
- QuickText
 - editing, 41
 - text message, 36
- QWERTY keypad, 3, 5
 - entering text, 17
- R**
- race 21, 48
- rapid entry mode, 18, 20
- receipt
 - picture messages, 42
 - text messages, 42
- receipt request
 - text message, 35

- recent calls, 27
- redialing, 12
- reply
 - text message, 35
- resolution, 44
- right softkey, 11
- ringer
 - business, 55
 - contacts, 32
 - headset, 62
 - personal, 55
 - roam, 15, 55
 - type, 55
 - volume, 55
- roam
 - alert, 15
 - call alert, 65
 - options, 15, 64
 - ringer, 15, 55
- roaming alert, 64
- roaming calls, 64
- S**
- scheduler, 49
 - settings, 51
- screen icons, 9
- screen saver, 57
- security
 - emergency numbers, 66
 - settings, 65
- settings
 - Bluetooth, 68
 - menu, 54
 - messages, 40
 - scheduler, 51
 - sounds, 55
 - volume, 55
- shutter sound, 45
- signature, 41
- silent mode, 51, 55
- smart sound, 55
- smiley
 - entering, 18
- software information, 62
- sounds
 - browsing, 47
 - flip close, 56
 - flip open, 56
 - keypad, 56
 - keypad length, 56
 - power on or off, 56
 - reminder, 51
 - settings, 55
 - silence all, 55
- speakerphone, 13
- speed dial, 14
- stopwatch, 53
- style
 - main menu, 57
- support, customer, 71
- symbol
 - entering, 17, 18, 21
- T**
- T-coil hearing aid, 63
- text
 - changing mode, 18, 21
 - entering, 19
 - mode, 17
 - number keypad, 20
 - QWERTY keypad, 17
- text message
 - callback number, 35
 - creating, 34
 - forwarding, 35
 - icon, 35
 - locking, 35
 - notification, 35
 - options, 34
 - priority, 35
 - receipt, 35, 42
 - replying, 35
 - retrieving, 35
 - saving, 36
 - saving as QuickText, 36
 - sender, 36
 - viewing, 35
- time pause, 30
- timer, 52
- tip calculator, 52
- tools, 48
- TTY
 - turning on and off, 12
 - using, 63
- V**
- vCard
 - sending, 33
- voice answer, 61
- voice commands, 60, 69, 70
- voice dial
 - adding, 61, 69
 - changing, 69
 - erasing, 61
 - voice dial list, 69
 - voice memo
 - recording, 48
 - reviewing, 49
 - voice recognition, 69
 - voice training, 61
 - voice wake-up, 61
 - voicemail, 15

- alert, 15
- number, 43

volume

- adjusting, 14
- auto adjust, 55
- settings, 55

W

- wallpaper, 57
- web
 - alert, 26, 65
 - browser, 25
 - menu, 25
- web address
 - contacts, 31
- web apps, downloading, 23
- white balance, 45
- word
 - entering, 18, 20

Kyocera Wireless Corp.
10300 Campus Point Drive
San Diego, CA 92121 USA
www.kyocera-wireless.com
82-G1934-1EN, Rev. 001