



KYOCERA Hydro PLUS

User Guide

Table of Contents

Device Basics.....	1
Battery	1
Install the Battery.....	1
Charge the Battery.....	2
Turn the Device On and Off	2
Turn the Device On	2
Turn the Device Off.....	2
Turn the Screen On and Off	3
Turn the Screen On and Unlock It	3
Turn the Screen Off When Not in Use.....	3
Device Overview	3
Key Functions.....	4
Touchscreen Navigation	5
Home Screen	6
Home Screen Overview.....	6
Extended Screens	6
Customize the Home Screens	7
Status Bar	8
Text Entry	11
Touchscreen Keyboard.....	11
Android Keyboard.....	11
Swype.....	14
Copying and Pasting Text.....	18
Phone.....	20
Make Phone Calls	20
Call Using the Phone Dialpad.....	20
Call From Call Log	20
Call From People	21
Call a Number in a Text Message	21
Call an Emergency Number	21
Call a Number with Pauses	22

Call Using the Plus (+) Code Dialing	22
Call Using the Internet Calling	23
Receive Phone Calls	24
Answer an Incoming Call	24
Mute the Ringtone Without Rejecting a Call	24
Reject an Incoming Call	24
Reject a Call and Send a Text Message	24
Voicemail	24
Set Up Voicemail	24
Voicemail Notification.....	25
Retrieve Your Voicemail Messages.....	25
Voicemail Settings	26
Phone Call Options	26
Caller ID	26
Call Waiting	26
3-Way Calling	27
Call Forwarding.....	27
Other Call Settings.....	28
In-Call Options.....	31
Call Log.....	32
View Recent Calls	32
Call Log Options	32
Clear Call Logs.....	33
People.....	34
Display People.....	34
The People List Options	34
Add a New Entry to People.....	35
Save a Phone Number From the Phone Dialpad	37
Edit an Entry in People	37
Add or Edit Information on an Entry	37
Assign a Picture to an Entry	37
Assign a Ringtone to an Entry	38
Assign a Vibration to an Entry.....	38

Add an Entry to Favorites	38
Send an Entry's Call to Voicemail	39
Delete an Entry.....	39
Synchronize the Entries in People.....	39
Share an Entry in People.....	40
Accounts and Messaging	41
Gmail	41
Create a Google Account	41
Sign In to Your Google Account	42
Access Gmail.....	42
Send a Gmail Message	43
Read and Reply to Gmail Messages	44
Email	44
Add an Email Account (POP3 or IMAP)	44
Add a Corporate Account	45
Create Another Email Account	46
Compose and Send Email	46
View and Reply to Email	47
Manage Your Email Inbox	47
Email General Settings	48
Email Account Settings	48
Delete an Email Account.....	49
Text Messaging and MMS.....	50
Compose Text Messages.....	50
Send a Multimedia Message (MMS).....	51
Save and Resume a Draft Message	52
New Messages Notification	53
Managing Message Conversations	53
Text and MMS Options.....	55
Social Networking Accounts	56
YouTube	56
Google Talk	57
Signing In and Chatting.....	57

Managing Your Friends	58
Mobile Indicators	59
Signing Out	60
Google Talk Settings	60
Applications and Entertainment.....	62
Google Play	62
Find and Install an App.....	62
Create a Google Wallet Account.....	63
Request a Refund for a Paid App	63
Open an Installed App.....	64
Uninstall an App.....	64
Get Help with Google Play.....	64
Cricket Shop	65
Navigation	65
Google Maps	65
Cricket Navigator	67
Muve Music™	67
Google Play Music.....	67
Opening the Music Library	67
The Listen Now Screen	68
More Screens.....	68
Backing Up Your Downloaded Music Files.....	68
Mobile Web	68
Cricket411	69
My Account	69
Evolve Money.....	69
Web and Data	70
Wi-Fi.....	70
Turn Wi-Fi On and Connect to a Wireless Network.....	70
Check the Wireless Network Status	71
Connect to a Different Wi-Fi Network	71
Data Services	71
Launch a Web Connection	71

Data Connection Status and Indicators	72
Browser.....	72
Learn to Navigate the Browser	72
Browser Menu.....	73
Select Text on a Web Page	74
Adjust Browser Settings	75
Adjust Browser Privacy and Security Settings.....	75
Adjust Browser Accessibility Settings	76
Adjust Browser Advanced Settings	77
Adjust Browser Bandwidth Management Settings	78
Adjust Browser Labs Settings.....	78
Set Search Engine	78
Create Website Settings.....	78
Reset the Browser to Default.....	79
Set the Browser Home Page	79
Read Web Page Offline	79
Manage Bookmarks.....	79
Portable Wi-Fi Hotspot.....	80
Camera and Video.....	83
Take Pictures.....	83
Open the Camera	83
Camera Viewfinder Screen	83
Review Screen	84
Take a Picture	85
Close the Camera	85
Record Videos	85
Video Viewfinder Screen.....	85
Record a Video	86
Camera/Video Settings	87
View Pictures and Videos Using Gallery	87
Open Gallery.....	87
View Photos and Videos	88
Zoom In or Out on a Photo.....	89

Watch a Video	89
Close Gallery.....	90
Working with Photos	90
Photo Options Menu	90
Edit a Photo.....	90
Rotate and Save a Photo.....	91
Crop a Photo	91
Share Photos and Videos.....	92
Send Photos or Videos by Email/Gmail	92
Send Photos or Videos by Multimedia Message	93
Send Photos or Videos Using Bluetooth	93
Share Photos or Videos on Google+.....	93
Share Photos on Picasa	94
Share Videos on YouTube	94
Tools and Calendar.....	95
Calendar	95
Add an Event to the Calendar	95
Invite Guests to Your Calendar Event.....	96
Event Alerts.....	96
View Calendar Events	97
Erase Calendar Events.....	99
Show or Hide Calendars	100
Synchronize Calendars with Your Device	100
Clock & Alarm	100
Opening Clock	100
Setting an Alarm	101
Changing Alarm Settings	102
Calculator.....	103
Voice Service	103
Automatic Speech Recognition (ASR)	103
Text-to-Speech Settings.....	104
Voice Search	104
Eco Mode.....	105

Bluetooth	106
Turn Bluetooth On or Off	106
The Bluetooth Menu	106
Pair With a Device	107
Disconnect or Unpair From a Bluetooth Device	108
Send and Receive Information Using Bluetooth.....	108
microSD Card	110
Remove the microSD Card	110
Install a microSD Card.....	111
View the microSD Card Memory.....	112
Format the microSD Card	112
Unmount and Mount the microSD Card	113
Use the Device’s microSD Card as a USB Drive	113
Use the Device’s microSD Card as a Media Device	113
Settings	115
Wireless & Networks Settings	115
Wi-Fi	115
Bluetooth.....	115
Data Usage	115
Airplane Mode	117
Tethering & Portable Hotspot.....	117
Mobile Networks.....	117
Roaming	117
Device Settings.....	119
Sound	119
Display	122
Storage	123
Battery.....	123
PC Connection	123
Apps.....	124
Personal Settings.....	124
Accounts & Sync.....	124
Add Account	124

General Sync Settings	125
Location Services.....	125
Security.....	126
Language & Input	130
Backup & Reset.....	130
System Settings	131
Date & Time	131
Accessibility.....	132
Developer Options	133
About Phone	133
System Update	133
Notes	135
Copyrights	136
Index	137

Device Basics

Battery

Install the Battery

1. Slide the battery cover release latch to the unlocked position (1).

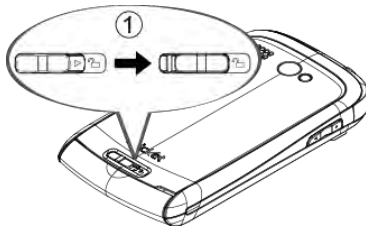

2. Insert your thumb- or fingernail into the slit (2) and lift the battery cover (3).

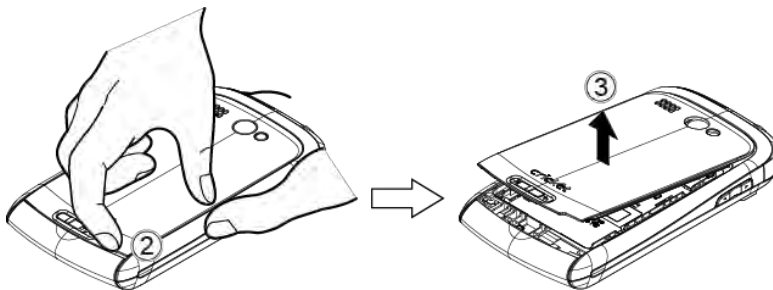

3. Insert the battery, contacts end first, and gently press into place (4).

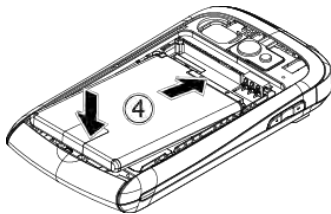

4. Replace the cover, applying equal pressure from the top down on both sides and making sure all the locking tabs of the cover are seated with no gaps (5).

Caution: Ensure that the battery cover release latch is in the unlocked position when replacing the cover.

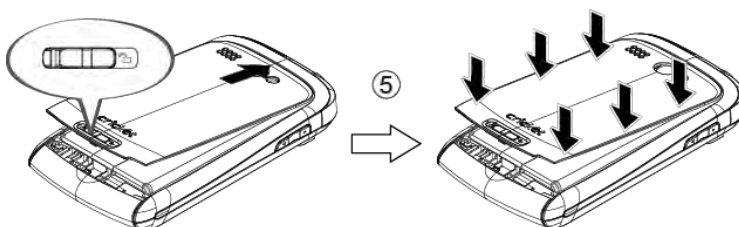

- Slide the battery cover release latch to the locked position (6).

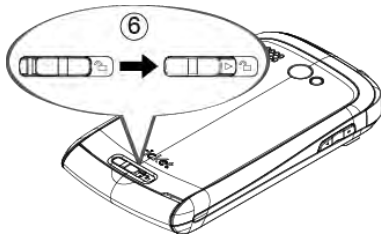

Charge the Battery

- Open the cover of the charger/accessory jack.
- Plug the smaller end of the micro-USB cable into the device's charger/accessory jack.

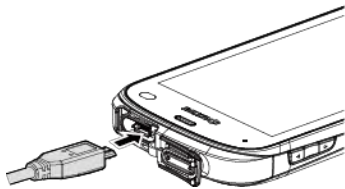

- Plug the other end of the USB cable into the charger, and then plug the charger into an electrical outlet.

Note: Your device's battery should have enough charge for the device to turn on and find a signal, set up voicemail, and make a call. You should fully charge the battery as soon as possible.

Turn the Device On and Off

Turn the Device On

- ▶ Press and hold the **Power** button.

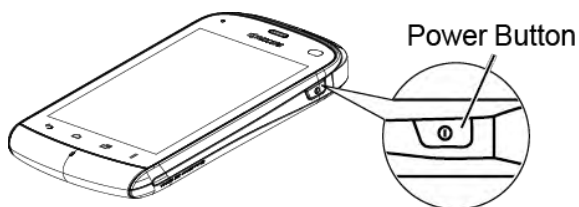

Turn the Device Off

- ▶ Press and hold the **Power** button to open the phone options menu. Touch **Power off** > **OK**.

Your screen remains blank while your device is off.

Turn the Screen On and Off

Turn the Screen On and Unlock It

To save battery power, the device automatically turns off the screen after a certain period of time when you leave it idle. You will still be able to receive messages and calls while the device's screen is off. For information on how to adjust the time before the screen turns off, see [Sleep](#).

1. Press the Power button.
2. Flick  to any direction to unlock the screen.

To disable the slide lock or enable a more secure lock, see [Screen Lock](#).

Turn the Screen Off When Not in Use





- ▶ Press the Power button.

Device Overview



Key Functions

CAUTION! Inserting an accessory into the incorrect jack may damage the device.

- **Earpiece** lets you hear the caller and automated prompts.
- **LED Indicator** shows your device's battery status. It also flashes for incoming calls or pending notifications.
- **Back Key** () returns you to the previous screen or closes the dialog box.
- **Home Key** () returns you to the Home screen.
- **Microphone** allows other callers to hear you clearly when you are speaking to them.
- **Recent Apps Key** () allows you to show the Recent Apps screen.
- **Menu Key** () lets you open the menus of the current screen or application.
- **Display Screen** displays all the information needed to operate your device. Use finger gestures to navigate and interact with items on the screen.
- **Proximity Sensor/Light Sensor** automatically deactivates the touchscreen when you hold the device near your face. This prevents you from unintentionally activating device functions during a call. It also automatically turns off the backlight and brightens the display when you are in sunlight or a bright room, and dims the display in darker places.
- **Charger/Accessory Jack** allows you to connect the micro-USB cable (included) to charge the battery or to transfer files to and from a computer.
- **Speaker** lets you hear the different ringtones and sounds. It also lets you hear the caller's voice in speakerphone mode.
- **Power Button** lets you turn the device on or off, or turn the screen backlight on or off. This button can be configured to end a call.
- **microSD Card Slot** (internal) allows you to insert a microSD card to support external memory. Your device comes with the microSD card preinstalled under the device's battery.
- **Internal Antennas** facilitate reception and transmission. To maximize performance, do not obstruct while using the device.
- **Battery Cover Release Latch** locks the battery cover.
- **Camera Lens**, as part of the built-in camera, lets you take pictures and videos.

- **Volume Button** allows you to adjust the ringtone and media volumes when you are not on a call, or the voice volume during a call.
- **Camera Flash** allows you to take pictures and videos in low light conditions.
- **Headphone Jack** allows you to plug in an optional headset for convenient, hands-free conversations.

Touchscreen Navigation

Warning: Do not touch with a pen or stylus. It may damage the touch screen.

Touch

Touch the screen with your finger to select or launch a menu, option, or application. A light touch works best.

Touch and Hold

To open the available options for an item (for example, options for a contact), simply touch and hold the item.

Drag

Touch and hold your finger before you start to move it. Do not release your finger until you have reached the target position.

Slide or Flick



To slide, quickly move your finger vertically or horizontally across the screen. To flick, move your finger in lighter, quicker strokes than sliding.

Pinch and Spread

Pinch the screen using your thumb and forefinger to zoom out or spread the screen to zoom in when viewing a picture or a Web page. (Move fingers inward to zoom out and outward to zoom in.)

Rotate

For most screens, you can automatically change the screen orientation from portrait to landscape by turning the device sideways. When entering text, you can turn the device sideways to bring up a bigger keyboard.

Note: The **Auto-rotate screen** check box in **Home**  > **Menu**  > **System settings** > **Display** needs to be selected for the screen orientation to automatically change.

Home Screen

The Home screen is the starting point for all applications, functions, and menus. From any application screen, press  to return to the Home screen.

Home Screen Overview

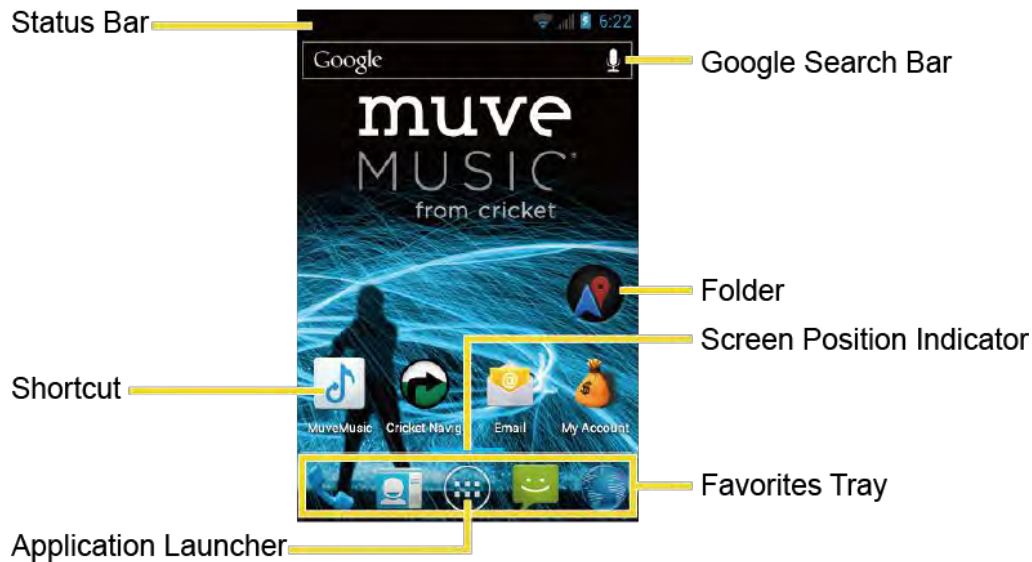

- **Status Bar:** Displays the time, notification, and device status icons. Slide down to display the Notifications panel.
- **Shortcut:** Allows users to quickly launch applications.
- **Application Launcher:** Touch to display available applications and widgets on the device.
- **Favorites Tray:** Keeps icons of your favorite application. The icons in the tray remain visible on every Home screen. You can change icons except the Application launcher icon (center).
- **Screen Position Indicator:** Indicates where you are among the five Home screens.
- **Folder:** Allows users to store multiple application icons as a group.
- **Google Search Bar:** Allows users to enter text or spoken keywords for a quick search on the device or on the Internet. Touch to enter text or touch  to speak your keyword.

Extended Screens

In addition to the main Home screen, your phone has four extended Home screens to provide more space for adding icons, widgets, and more.



- ▶ Press Home  and then drag across the screen to move from the main screen to an extended screen.

Note: You cannot add more screens.

Customize the Home Screens

Add Application Icons or Widgets to the Home Screens

1. Touch  on the Favorites Tray.
2. Slide the APPS and WIDGETS screens to find the item you want to add to the Home screen.
3. Touch and hold an application icon or widget. The Home screen appears.
4. Pressing the item, move your finger to find the place to add it to. The blue frame indicates where it might be placed.
5. Release your finger.

Move or Remove Items on the Home Screens

- ▶ Touch and hold the item you want to move or remove on the screen.
 - To move the item, drag it to a new area and release it.
 - To remove the item, drag it over “X Remove” at the top of the screen and release it when it turns red.

Change the Wallpaper

1. Touch and hold the empty area on the Home screen.
2. Select one of the following options:

- **Gallery/Graphics:** Select to use saved or captured pictures on your device. Touch to select a picture, and crop it before setting it as wallpaper.
- **Live Wallpapers:** Select to use Live wallpapers. Select the wallpaper and touch **Set wallpaper**.
- **Wallpapers:** Select to use preset wallpapers. Select the wallpaper and touch **Set wallpaper**.

Favorites Tray

Favorites Tray takes up to five icons and those icons in the tray remain visible on every Home screen. You can change icons except the Application launcher icon located in the center of the tray.

To add a new icon to the Favorites Tray:

1. Remove the current icon on the tray. See [Move or Remove Items on the Home Screens](#).
2. Touch and hold an application icon and drag it to the Favorites Tray.
3. Release your finger.

Use Folders

You can combine several application icons in a folder.

1. Touch and hold an application icon and drag it over another icon.
2. Release your finger. You can see two icons piled within a folder (a black circle).
3. Touch the folder to see the application icons within the folder.
4. Touch **Unnamed Folder**. The keyboard opens and you can name the folder. To rename it, touch the name.















Status Bar

The status bar at the top of the screen provides device and service status information on the right side and notification alerts on the left. To view notification alerts, slide the status bar down.

Status Icons











Icon	Description
------	-------------

	Bluetooth® enabled
	Wi-Fi® active (full signal)
	Vibrate
	Silent
	Network (full signal)
	Network (roaming, full signal)
	Network (no signal)
	3G (data service)
	1x (data service)
	Airplane mode
	Alarm set
	Battery (charging)
	Battery (full charge)
	Battery (discharged)

Notification Icons



Icon	Description
	Missed call
	New email
	New Gmail
	New SMS message
	New MMS message
	Event
	Music application is running background



	USB connection
	Alarm
	When animating, GPS is active
	Downloading

Text Entry

Touchscreen Keyboard

Two types of keyboards are available on your device: **Android keyboard** and **Swype**. Simply touch a text field where you want to enter text to call up a keyboard. You can turn the device sideways to bring up a bigger keyboard. See [Auto-Rotate Screen](#).

To switch the keyboard from Settings:

1. Press Home  > Menu  and touch **System settings** > **Language & input**.
2. Touch **Default**.
3. Touch **Android keyboard** or **Swype**.

To switch the keyboard when a keyboard is displayed:

1. Drag the Notifications panel down and touch **Select input method**.
2. Touch **Android keyboard** or **Swype**.





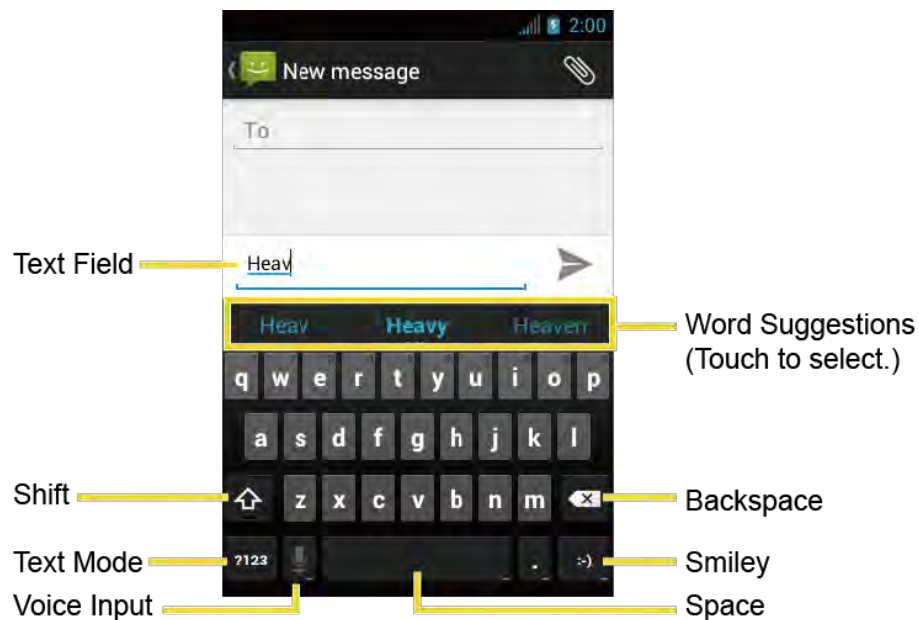







Android Keyboard

Android Keyboard Overview











Note: Key appearance may vary depending on the selected application or text field.

Keyboard Functions

Key	Description
 	Shift: Touch to toggle between lower case and upper case.
	Capslock: Double-touch the lower case or upper case shift key.
 	Text mode: Touch to toggle between the Alphabet keyboard and Number & Symbol keyboard.
	Voice input mode: Touch to enter text using your voice.
	Backspace: Touch to delete a character. Touch and hold to delete multiple characters.
	Smiley: Touch to insert a smiley. Touch and hold to view and select other smileys.
	Next: Touch to go to the next text entry field.
 	Alternate: Touch to toggle between the default Number & Symbol keyboard and additional Number & Symbol keyboard.
	Go: Touch to go to a Web address.
	Space: Touch to insert a space. Touch and hold to select the input method.

Text Mode

ABC mode is primarily used for entering letters while Number & Symbol mode for numbers and symbols.



- ▶ Touch  to select ABC mode. Touch  to select Number & Symbol mode.
 - In ABC mode, touch  to alter the capitalization:
 -  (Unshifted) to enter all letters in a word lowercase.
 -  (One-character-shifted) to capitalize only the first letter of a word.
 - You can select the caps lock by double-touching or touching and holding  or  to make all letters in a word uppercase.
 -  (Caps Lock) to enter all letters in a word uppercase.

- In Number & Symbol mode, touch  to display more symbols.
- Some keys have alternate characters. In either mode, if a key displays an extra character at the upper right corner, touch and hold the key to enter the character. Or, touch and long hold a key to call up a list of all the characters available on that key. Touch the character you want to enter from the list.

Entering Text by Speaking

Voice input is an experimental feature that uses Google's speech-recognition service, so you must have a data or Wi-Fi connection to use it. The touchscreen keyboard displays  when voice input is turned on.





To turn on voice input:

1. Press Home  > Menu  and touch **System settings > Language & input**.
2. Select the **Google voice typing** check box.
3. Touch  next to **Android keyboard**.
4. Touch **Voice input key** and select **On main keyboard** or **On symbols keyboard**.

To enter text by speaking:

1. Touch  on the keyboard.
2. Say the text you wish to enter into the microphone and touch **Done**.

Adding a Word to the User Dictionary

1. Press Home  > Menu  and touch **System settings > Language & input > Personal dictionaries**.
2. Select a language.
3. Touch .
4. Type the word you want to add and touch **OK**. (A list of words you have added to the dictionary is displayed.)
 - Touch a word to edit it.
 - Touch  to delete it.

Android Keyboard Settings

1. On the Android keyboard, touch and hold the space key and touch **Configure input methods**.

- or -

Press Home  > Menu  and touch **System settings > Language & input**.

2. Touch  next to **Android keyboard**.

Tip: You can also touch  > **Android keyboard settings** on the Android keyboard. See [Show settings key](#) to display this key on the keyboard.

3. Choose from the following options.
 - **Input languages:** Touch to select the input language. The dictionary for the selected language will be enabled.
 - **Auto-capitalization:** Select to automatically set the first letter of a sentence to upper case where available.
 - **Vibrate on keypress:** Select to activate vibration when a key is touched.
 - **Sound on keypress:** Select to activate a clicking sound when a key is touched.
 - **Popup on keypress:** Select to display a larger image of the key above it when you touch it.
 - **Show settings key:** Select to display the keyboard settings key on the keyboard.
 - **Voice input key:** Touch to select where the Voice Input key is displayed from **On main keyboard**, **On symbols keyboard**, or **Off**.
 - **Add-on dictionaries:** Touch to select the dictionary you want to use.
 - **Auto correction:** Touch to allow the space bar and punctuation to automatically correct mistyped words.
 - **Show correction suggestions:** Touch to select when correction suggestions are displayed.
 - **Advanced settings:** Touch to open the settings for expert users.

Swype

Swype® allows you to enter text by sliding your finger from letter to letter rather than touching each key individually.

Swype Keyboard Overview

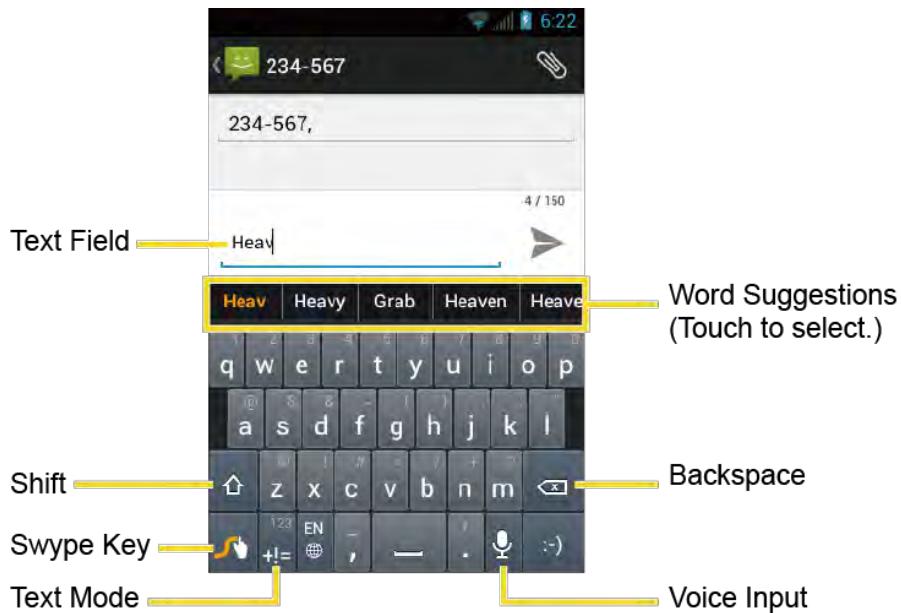

Note: Key appearance may vary depending on the selected application or text field.

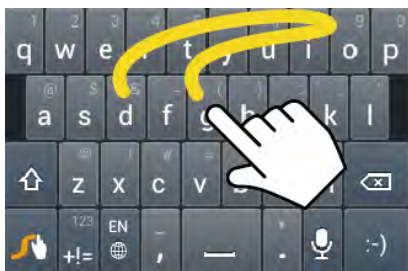

Example: dog
Place your finger on the key with the first letter of the word and glide to the following letters. Lift your finger after the last letter.

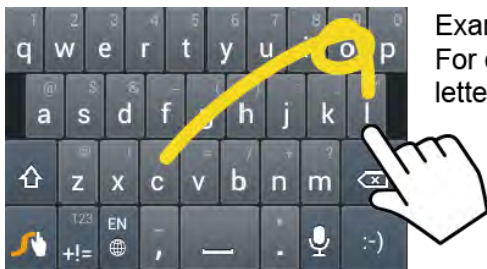









Example: cool
For double letters, circle the letter.



Example: You
To capitalize the letter, slide up over the keyboard.







Tip: For tips on using Swype, touch and hold the Swype key  and then touch **How to Swype**.

Keyboard Functions

Key	Description
	Text mode: Touch to toggle between the Alphabet keyboard and Number & Symbol keyboard.
	Swype: Touch and hold to access the tips or the settings of Swype.
	Voice input mode: Touch to enter text using your voice.
	Backspace: Touch to delete a character. Touch and hold to delete multiple characters.
	Smiley: Touch to insert a smiley. Touch and hold to view and select other smileys.
	Space: Touch to insert a space.
	Enter: Touch to confirm your entry.
	Shift: Touch to toggle between the lowercase, uppercase and caps lock text input.

Text Mode

ABC mode is primarily used for entering letters while Number & Symbol mode for numbers and symbols.

- ▶ Touch  to select ABC mode. Touch  to select Number & Symbol mode.
 - In ABC mode, touch  to alter the capitalization:
 -  (Unshifted) to enter all letters in a word lowercase.
 -  (One-character-shifted) to capitalize only the first letter of a word.
 -  (Caps Lock) to enter all letters in a word uppercase.
 - The Number & Symbol keyboards are in two layers. Touch  to display the second keyboard.

- Some keys have alternate characters. In either mode, if a key displays an extra character on the upper right corner, touch and hold the key to enter the character. Or, touch and long hold a key to call up a list of all the characters available on that key. Touch the character you want to enter from the list.











Entering Text by Speaking

You can use voice input to enter text by speaking anywhere that you can enter text with the touchscreen keyboard.





1. Touch  on the keyboard.
2. Say the text you wish to enter into the microphone.

Adding a Word to the User Dictionary

You can add new words into the dictionary.

1. On the Swype keyboard, touch and hold the Swype key .
- or -
Press Home  > Menu  and touch **System settings** > **Language & input**. Touch  next to **Swype**.
2. Touch **Personal dictionary**.
3. Touch , type the word you want to add, and touch . (A list of words you have added to the dictionary is displayed.)
 - Touch a word to edit it.
 - To delete a word, touch , select a word and then touch  > **OK**.
 - Touch  to select all the words in the dictionary.
 - Touch  to cancel deleting and go back to the previous screen.

Swype Settings

1. On the Swype keyboard, touch and hold the Swype key .
- or -
Press Home  > Menu  and touch **System settings** > **Language & input**. Touch  next to **Swype**.

2. Choose from the following options:
 - **Select Input Method:** Touch to select the Swype or Android keyboard.
 - **How to Swype:** Touch to learn Swype in quick steps.
 - **Personal dictionary:** Touch to make your personal dictionary for Swype.
 - **Preferences:** Touch to show the following settings menu for Swype:
 - **Audio feedback:** Select to turn on sounds from Swype.
 - **Vibrate on keypress:** Select to activate vibration when a key is touched.
 - **Show tips:** Select to turn on a flashing indicator for quick help.
 - **Auto-spacing:** Select to automatically insert spaces between words.
 - **Auto-capitalization:** Select to automatically capitalize the first letter of sentence-initial words within the specific text entry fields.
 - **Show complete trace:** Select to display the complete Swype path.
 - **Word suggestion:** Touch to activate word prediction when typing in Swype.
 - **Speed vs. accuracy:** Touch to set how quickly Swype responds to input.
 - **Reset Swype's dictionary:** Touch to delete all the words you have added to Swype's dictionary.
 - **Version:** Displays the current Swype version.
 - **Language Options:** Touch to select the language to use on Swype.



Copying and Pasting Text

To copy and paste the text:

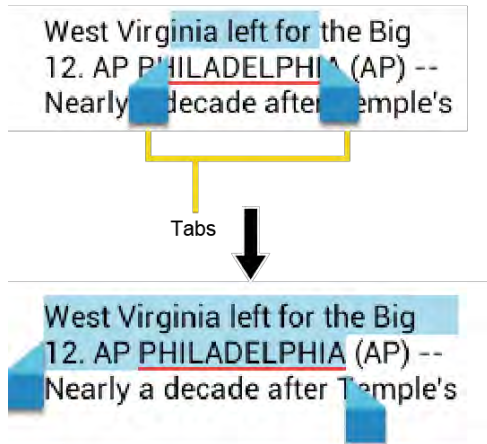
1. Open the application or received message that you want to copy text from.
2. Touch and hold the text body. Selection tabs appear, and the currently selected words or characters are highlighted. Drag the tabs to expand or reduce the range of the selected text.



Tip: Touch , , or **SELECT ALL** to select all the text on the Web page.

3. Touch  or  (Copy).
4. Open the application that you want to paste the text to.
5. Touch and hold the text box where you want to paste the text to, and touch **PASTE**.
 - If you want to add the selected text to the current text, drag a selection tab to the position where you want to insert the selected words or characters.

To copy text from a Web page:

1. Scroll to the area of the Web page containing the text you want to select.
2. Touch and hold the text you want to copy. Drag tabs to expand or reduce the range of selected text. Any selected text will appear highlighted.

Tip: Touch **SELECT ALL** to select all the text on the Web page.

3. Touch  > **Copy**.
4. Open the application that you want to paste into.
5. Touch and hold the text box where you want to paste the text to, and touch **PASTE**.



To copy a URL:

1. To copy a URL, touch and hold the URL to display the options menu.
2. Touch **Copy link URL** or .
3. Open the application that you want to paste into.
4. Touch and hold the text box where you want to paste the URL to, and touch **PASTE**.



Phone

Make Phone Calls



Call Using the Phone Dialpad

1. Press Home  and touch  to display the phone screen.
 - If the dialpad is not displayed when the Phone application opens, touch the Phone tab .
2. Touch the number keys on the dialpad to enter the phone number.







3. Touch the Talk key  to call the number.
4. To end the call, touch .

Call From Call Log



1. Press Home  and touch  to display the phone screen.
2. Touch the Call Log tab  to display the Call log list.

3. Touch the phone icon  next to the name or number you want to place a call.
4. For additional options, touch the name or number.

Call From People

1. Press Home  and touch  to display the phone screen.
2. Touch the People tab  to display the People list.
 - The entries with phone numbers in People are listed.
 - The frequent entries in People are displayed at the top of the list.
3. Touch the entry you want to call.
 - Touch  to search an entry in People.
 - Press Menu  and touch **Contacts to display** to customize the People list. See [Display Options](#).







Call a Number in a Text Message

1. Press Home  and touch  > **Messaging**.
2. Touch the message with the phone number. The Phone screen opens with the phone number automatically filled in and ready to be dialed.
3. Touch  to place a call.

Call an Emergency Number

You can place calls to 911 even if the device's screen is locked or your account is restricted.

To call the 911 emergency number:

1. Flick  to unlock the screen, if the slide screen lock is on.
2. Touch  on the Home screen.
3. Touch    .

To call the 911 emergency number when the device's screen is locked with a pattern, PIN, or password:

1. Touch **Emergency call** on the screen.

2. Touch    .

Once an emergency call is placed, your device will be in Emergency mode for the following five minutes after the call where non-emergency calls cannot be made.

To exit Emergency mode immediately:

- ▶ Press **Menu**  and touch **Exit Emergency mode > Yes**.

Enhanced 911 (E911) Information

This device features an embedded Global Positioning System (GPS) chip necessary for utilizing E911 emergency location services where available.

When you place an emergency 911 call, the GPS feature of your device seeks information to calculate your approximate location. Depending on several variables, including availability and access to satellite signals, it may take up to 30 seconds or more to determine and report your approximate location.





Important: Always report your location to the 911 operator when placing an emergency call. Some designated emergency call takers, known as Public Safety Answering Points (PSAPs), may not be equipped to receive GPS location information from your device.

Call a Number with Pauses

You can dial phone numbers with pauses for use with automated systems, such as voicemail or credit card billing numbers.





There are two types of pauses available on your device:

- **Add 2-sec pause:** Automatically sends the next set of numbers after two seconds.
- **Add wait:** Sends the next set of numbers when you touch **Yes** in the pop-up window.

1. Press **Home**  and touch  and enter all or part of a number.
2. Press **Menu**  and touch **Add 2-sec pause** or **Add wait**.
3. Enter additional numbers.
4. Touch  to dial the number.

Call Using the Plus (+) Code Dialing

When placing international calls, Plus Code Dialing automatically enters the international access code for your location (for example, 011 for international calls made from the U.S.).



1. Press Home  and touch  to display the phone screen.
2. Touch and hold  until you see a “+” on the display screen.
3. Enter the country code and phone number, and then touch . The device automatically prepends the access code for international dialing, followed by the country code and phone number.

Call Using the Internet Calling

When Wi-Fi network is available, you can make and receive calls through an Internet calling account.



Important: Calling a phone number using Internet calling may incur additional charges.

Adding an Internet Calling Account



1. Press Home  and touch  to display the phone screen.
2. Press Menu  and touch **Settings > Accounts > ADD ACCOUNT**.
3. Enter your account details and touch **SAVE**.
4. To set your phone to receive Internet calls on your added account, select the **Receive incoming calls** check box.

Note: This requires the phone to maintain a connection with a Wi-Fi data network, which reduces the life of your phone’s battery.

Making an Internet Call

1. Press Home  and touch  > **People**.
2. Touch an entry and then touch **Internet call**.

Internet Calling Setting

1. Press Home  and touch  to display the phone screen.
2. Press Menu  and touch **Settings > Use Internet calling**.
3. Select an option:
 - **For all calls when data network is available** to use Internet calling for all calls when Wi-Fi network is available.
 - **Only for Internet calls** to use Internet calling only for calls to Internet calling addresses.

- Ask for each call to ask each time you make a call.

Receive Phone Calls

When you receive a phone call from an entry stored in People, the Incoming call screen appears and displays the caller ID icon, name, and phone number of the calling party. When you receive a phone call from someone who is not stored in People, only the default caller ID icon and phone number appear on the Incoming call screen.

Note: If your device is turned off, all calls automatically go to voicemail.

Answer an Incoming Call

- ▶ On the Incoming call screen, flick the Answer icon .

Mute the Ringtone Without Rejecting a Call

- ▶ Press the volume button up or down.



Reject an Incoming Call

- ▶ Flick the Ignore icon  to send the call to your voicemail inbox.

Reject a Call and Send a Text Message

- ▶ Flick the Ignore & Text icon  to ignore the call and send a message to the caller.



To edit a text message beforehand:

1. Press Home  and touch .
2. Press Menu  and touch Settings > Quick responses.
3. Touch a message, edit it and touch OK.

Voicemail

Your device automatically transfers all unanswered calls to your voicemail, even if your device is in use or turned off. Set up your Voicemail to access the service.

Set Up Voicemail

1. Press Home  and touch .
2. Touch and hold  to dial your voicemail number.

3. Follow the system prompts to:
 - Create your password.
 - Record your name announcement.
 - Record your greeting.

Important: **Voicemail Password** - It is strongly recommended that you create a password when setting up your voicemail to protect against unauthorized access. Without a password, anyone who has access to your device is able to access your voicemail messages.

Voicemail Notification



There are several ways your device alerts you to a new voicemail message.

- By sounding the assigned notification sound.
- By vibrating the device.
- By displaying  in the notifications area of the status bar when new unheard voicemail message(s) is received. The figure is the number of new messages. This icon means you have 10 unheard new messages.

Note: Your device accepts messages even when it is turned off. However, your device notifies you of new messages only when it is turned on and you are in the service area.

Retrieve Your Voicemail Messages

Use Your Device to Access Messages



1. Press Home  and touch .
2. Touch and hold . If prompted, enter your voicemail password.
3. Follow the voice prompts to listen to and manage your voicemail messages.

Note: Depending on your plan, you may be charged when you are accessing your voicemail from your wireless device.

Use Another Phone to Access Messages

1. Dial your wireless phone number.
2. When your voicemail answers, press the asterisk key (*) on the phone.
3. Enter your password.

Voicemail Settings







1. Press **Home**  and touch .
2. Press **Menu**  and touch **Settings**.
3. Configure the following settings:
 - Touch **Voicemail service** to select the voicemail service provider.
 - Touch **Voicemail settings** to configure the voicemail number if necessary.
 - Touch **Vibrate** and select when the device responds with vibration to a new voicemail message.

Phone Call Options

Caller ID

Caller ID identifies a caller before you answer the phone by displaying the number of the incoming call.

To make a call without your number displayed:

1. Press **Home**  and touch .
2. Touch   .
3. Enter a phone number.
4. Touch .

Call Waiting

When you're on a call, Call Waiting alerts you to incoming calls by sounding beeps. Your device's screen informs you that another call is coming in and displays the caller's phone number (if it is available).

To respond to an incoming call while you're on a call:



- ▶ Flick .

To switch back to the first caller:

- ▶ Touch **Switch calls**.

Call Waiting Settings

To activate or deactivate the Call Waiting setting:

1. Press **Home**  and touch .
2. Press **Menu**  and touch **Settings > Call waiting**.
3. Touch **Activate** or **Deactivate**. Your device will place a call to activate or deactivate the setting.

3-Way Calling

With 3-Way Calling, you can talk to two people at the same time. When using this feature, the normal airtime rates will be charged for each of the two calls.

1. On the Phone screen, enter a number and touch .
2. Once you have established the connection, touch **Add call**, and dial the second number. (This puts the first caller on hold and dials the second number.)
3. When you're connected to the second party, touch **Merge calls**.

If one of the people you called hangs up during your call, you and the remaining caller stay connected. If you initiated the call and are the first to hang up, all callers are disconnected.



- ▶ To end the 3-way call, touch .

Call Forwarding

Call Forwarding lets you forward all your incoming calls to another phone number - even when your device is turned off. You can continue to make calls from your device when you have activated Call Forwarding.

Note: You are charged a higher rate for calls you have forwarded.

To activate a Call Forwarding setting:



1. Press **Home**  and touch .
2. Press **Menu**  and touch **Settings > Call forwarding**.
3. Select when you want to forward a call.
4. Touch **Activate**.
5. Enter a phone number you want to forward your calls to by:
Typing the number using a keyboard.

- or -



Touching  and selecting the number from your People list.

6. Touch **OK**. Your device will place a call to activate the setting.

To deactivate a Call Forwarding setting:



1. Press **Home**  and touch .
2. Press **Menu**  and touch **Settings** > **Call forwarding**.
3. Select the setting you want to deactivate.
4. Touch **Deactivate**. Your device will place a call to deactivate the setting.

To cancel all Call Forwarding settings:



1. Press **Home**  and touch .
2. Press **Menu**  and touch **Settings** > **Call forwarding** > **Cancel all**. Your device will place a call to cancel all the settings.

Other Call Settings

North American Dialing

1. Press **Home**  and touch .
2. Press **Menu**  and touch **Settings**.
3. Select the **North American dialing** check box when placing international calls while in the United States or Canada. See [Call Using the Plus \(+\) Code Dialing](#).



International Dialing

1. Press **Home**  and touch .
2. Press **Menu**  and touch **Settings**.
3. Clear the **North American dialing** check box and touch **International dialing** to set the international dialing code when placing international calls from outside the United States or Canada.

Auto Retry

With Auto Retry enabled, your device will automatically redial the number it failed to connect to.

To enable Auto Retry:



1. Press **Home**  and touch .
2. Press **Menu**  and touch **Settings**.
3. Select the **Auto Retry** check box.

TTY Mode

A TTY (teletypewriter, also known as a TDD or Text Telephone) is a telecommunications device that allows people who are deaf, hard of hearing, or who have speech or language disabilities to communicate by telephone.

Your device is compatible with select TTY devices. Please check with the manufacturer of your TTY device to ensure that it supports digital wireless transmission. Your device and TTY device will connect using a special cable that plugs into your device's headset jack. If this cable was not provided with your TTY device, contact your TTY device manufacturer to purchase the connector cable.

To turn TTY mode on or off:

1. Press **Home**  and touch .
2. Press **Menu**  and touch **Settings > TTY mode**.
3. Touch **TTY Full**, **TTY HCO**, or **TTY VCO** to turn TTY mode on.

- or -

Touch **TTY Off** to turn TTY mode off.

Note: When enabled, TTY mode may impair the audio quality of non-TTY devices connected to the headset jack.



Warning: 911 Emergency Calling

It is recommended that TTY users make emergency calls by other means, including Telecommunications Relay Services (TRS), analog cellular, and landline communications. Wireless TTY calls to 911 may be corrupted when received by public safety answering points (PSAPs), rendering some communications unintelligible. The problem encountered appears related to TTY equipment or software used by PSAPs. This matter has been brought to the attention of the FCC, and the wireless industry and the PSAP community are currently working to resolve this.

Voice Privacy

You can enable the enhanced privacy mode.



To enable Voice Privacy:

1. Press **Home**  and touch .
2. Press **Menu**  and touch **Settings**.
3. Select the **Voice Privacy** check box.



Call Timer

Your device displays the duration of your last call, outgoing calls, incoming calls, roaming calls, etc.

To view a Call Timer:

1. Press **Home**  and touch .
2. Press **Menu**  and touch **Settings > View call timer**.

To reset a Call Timer:

1. Press **Home**  and touch .
2. Press **Menu**  and touch **Settings > View call timer**.
3. Touch and hold the item you want to reset and touch **Reset > OK** to reset individual timer.

- or -



Touch **Reset all timer > OK** to reset all timers.

Note: You cannot reset **Lifetime calls**, which is the total duration of all the calls you have made and received since the activation of the device.

Call Restrictions

You can restrict the phone calls your device can make and receive. Emergency calls will not be affected by this restriction setting.



To restrict your calls:

1. Press **Home**  and touch .
2. Press **Menu**  and touch **Settings > Call restrictions**.
3. Touch **Outgoing calls** or **Incoming calls**.
4. Touch **Allow all**, **Allow contacts**, or **Allow none**.

Note: If a pattern, PIN, or password is set for the screen lock, you need to enter the pattern, PIN, or password to change the restriction settings.

DTMF Tones

Follow the steps below if you need to change the DTMF tones.

1. Press Home  and touch .
2. Press Menu  and touch Settings > DTMF Tones.
3. Select either Normal or Long.

In-Call Options

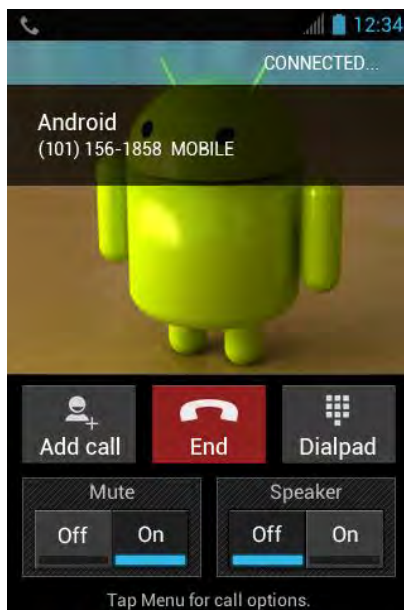

- **Add call:** Touch to initiate a 3-way call.
- **End:** End the current call.
- **Dialpad/Hide:** Toggle the appearance of the onscreen dialpad to enter additional numbers, for example, an extension or access code.
 - For example: When you call your bank's 800 number, use your dialpad to enter your account number and PIN.
- **Mute:** Mute (On) or unmute (Off) the microphone during an active call.
- **Speaker:** Route the device's audio through the speaker (On) or through the earpiece (Off).

Warning: Because of higher volume levels, do not place the device near your ear during speakerphone use.







Press **Menu**  during a call to display a list of additional in-call features. Touch an option to select it.

- **Contacts:** Displays your People list.
- **Bluetooth:** Routes the device's audio through a connected Bluetooth headset when selected.

Call Log

The Call log tab of the Phone application lists max. 500 recent incoming, outgoing, and missed calls.







View Recent Calls



1. Press **Home**  and touch  to display the phone screen.
2. Touch  to display the Call log list.
 - You can determine if an entry was an incoming, outgoing, or a missed call from the icons shown below.
 -  = Incoming Call
 -  = Outgoing Call
 -  = Missed Call

Call Log Options





To make a call from Call log, see [Call From Call Log](#).

For additional options:

1. Press **Home**  and touch  to display the phone screen.
2. Touch  to display the Call log list.
3. Touch the name to display the options list.
 - Touch  to send a text message.
 - Touch  to view an entry in People.
 - Touch  to add the number to People.

- Press Menu  and touch **Remove from call log** to remove the log.
- Press Menu  and touch **Edit number before call** to edit the number before calling.



Clear Call Logs

1. Press Home  and touch  to display the phone screen.
2. Touch  to display the Call log list.
3. Press Menu  and touch **Clear call log > OK**.





People

The People application lets you store and manage contacts from a variety of sources, including contacts you enter and save directly in your device as well as contacts synchronized with your Google Account or compatible email programs.

Display People

► Press Home  and touch  > People.

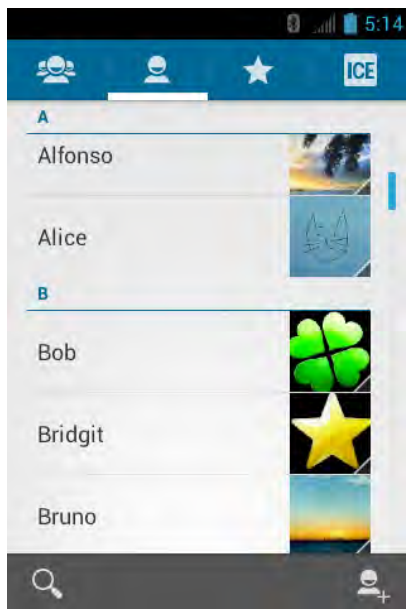

There are four tabs on People:

-  **Groups** to display the Group of entries.
-  **All** to display all entries.
-  **Favorite** to display your favorite entries.
-  **ICE** to display your ICE (in case of emergency) entry.



Scroll through the list to view all your entries. To see a specific entry, scroll to it and touch it.





The People List Options

- Touch  to add an entry. See [Add a New Entry to People](#).
- Touch  to search an entry.





- Press Menu :
 - **Contacts to display:** Selects the People list to be displayed. See [Display Options](#).
 - **Import/export:** Imports/exports entries from/to the microSD card.
 - **Accounts:** Opens the Accounts & sync settings screen. See [Accounts & Sync](#).
 - **Settings:** Opens the Display options page. You can select how your entries are displayed. See [Display Options](#).

Display Options



To select an account to display its People list when you have multiple accounts:

1. Press Home  and touch  > People > .
2. Press Menu  and touch **Contacts to display**.
3. Select an account from the displayed list.
 - If you select **All contacts**, all the entries you save will be displayed.

To select the categories to display in the People list:

1. Press Home  and touch  > People > .
2. Press Menu  and touch **Contacts to display**.
3. Touch **Customize** and select an account.
4. Select the categories and touch **OK**.

To select how your People list is displayed:

1. Press Home  and touch  > People.
2. Press Menu  and touch **Settings**.
3. Set the following options:
 - **Sort list by** to choose how your entries are sorted.
 - **View contact names as** to choose how your entries name is displayed.

Add a New Entry to People

1. Press Home  and touch  > People.

2. If this is the first time to open the People application, select where to save a new entry:
 - **Existing** to save to your existing Google Account.
 - **New** to save to your new Google Account.
 - **Not now** to save to your device only.
3. Touch .
 - You may be prompted to select an account to synchronize the new contact with.
 - Select an account from the displayed list.
 - Touch **Add new account** to add a new account. Select **Google** or **Corporate**.
 - They will be synced automatically with your Google Account online.
4. Use the keyboard to enter as much information as you want.

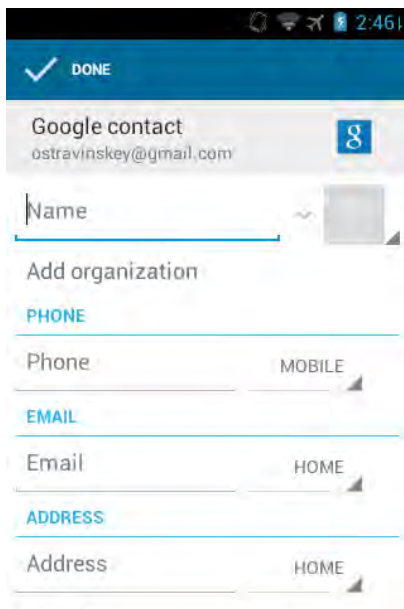

-  (People icon): Touch to assign a photo to the entry. See [Assign a Picture to an Entry](#) .
- **Name**
- **Add organization**
- **PHONE**
- **EMAIL**





- **ADDRESS**
- **Add another field:** Touch to include additional information such as IM (address), Notes, Nickname, Website, Internet call, etc.

Note: To select a type (label) for a phone number, email address, or postal address (such as Mobile, Home, Work, etc.), touch the type to the right of the field.

Note: To add more phone numbers, email addresses, etc., touch **Add new** under the current numbers or addresses.

5. When you have finished adding information, touch **DONE**.

Save a Phone Number From the Phone Dialpad



1. Press Home  and touch  > .
2. Enter a phone number, press Menu  and touch **Add to contacts**.
3. To add the number to an existing entry, touch the contact, select a number type for the new number, and then touch **OK**.

- or -

To add the number to a new entry, touch **CREATE NEW CONTACT**, enter the name and any additional information, and then touch **DONE**. See [Add a New Entry to People](#).

Edit an Entry in People

Add or Edit Information on an Entry

1. Press Home  and touch  > **People**.
2. Touch an entry, press Menu  and touch **Edit**.
3. Touch any field you want to change or add. See [Add a New Entry to People](#).
4. Add or edit the information, and then touch **DONE**.

Note: To select a type (label) for a phone number, email address, or postal address (such as Mobile, Home, Work, etc.), touch the type at the right of the field.



Assign a Picture to an Entry

The assigned picture will be displayed when the entry calls.

1. Press Home  and touch  > **People**.

2. Touch an entry, press **Menu**  and touch **Edit**.
3. Touch the entry icon to the right of the name.
4. To assign a stored picture, touch **Choose photo from Gallery**, select a location and then select a picture.



- or -

To assign a new picture, touch **Take photo** and take a picture by touching . Touch  to continue if you are satisfied with the picture, or touch  and take another picture.



5. You may be prompted to size the picture for use with entries. Touch and drag the square to frame the portion of the picture to use. Touch and drag the side of the square to resize the square and touch **CROP**.
6. Touch **DONE** to save the entry.

Assign a Ringtone to an Entry

Identify the caller with an assigned ringtone to the entry.

1. Press **Home**  and touch  > **People**.
2. Touch an entry, press **Menu**  and touch **Set ringtone**.
3. Touch an available ringtone.
 - When you touch a ringtone, you will hear a sample.
4. Touch **OK** to assign the ringtone.

Assign a Vibration to an Entry

1. Press **Home**  and touch  > **People**.
2. Touch an entry, press **Menu**  and touch **Set vibrate**.
3. Touch an available vibration.
 - When you touch a vibration, you will feel a vibration.
4. Touch **OK** to assign the vibration.



Add an Entry to Favorites

1. Press **Home**  and touch  > **People**.



2. Touch an entry.
3. Touch the star at the upper right corner. The star turns to white.

Send an Entry's Call to Voicemail

You can transfer your entry's voice call to voicemail anytime you receive it.

1. Press Home  and touch  > People.
2. Touch an entry and press Menu .
3. Select the All calls to voicemail check box.

Delete an Entry



1. Press Home  and touch  > People.
2. Touch an entry, press Menu  and touch Delete.
3. Touch OK.

Synchronize the Entries in People

Syncing data from your managed accounts allows you to add and manage a new or existing entry from your online or remote accounts to your device. Prior to syncing, you must first have an active Google or Corporate account with the current entries in People, and be signed into your account via the device.

With syncing, any entries (with phone numbers, email addresses, pictures, etc.) are updated and synced with your device.

For more information about syncing existing managed accounts, see [General Sync Settings](#).

1. Press Home  > Menu  and touch System settings > Accounts & sync.
2. Touch the account you want to sync your People with.
3. Select the Sync Contacts check box.





Note: The process of updating your People can take several minutes. If after 10-20 minutes, your list has not been updated, repeat steps 2 and 3.

Your People then reflects any updated entry information.

- This update process works both ways. For example, any changes on the device are updated to your Gmail contacts list after sync.

Share an Entry in People

You can quickly share the entries in People using Bluetooth, Email, or Gmail.

1. Press **Home**  and touch  > **People**.
2. Touch an entry, press **Menu**  and touch **Share**.
3. In the **Share contact via** menu, select a method:
 - **Bluetooth** to send the information via Bluetooth. See [Bluetooth](#) for information on pairing and sending via Bluetooth.
 - **Email** to send the information as an email attachment. If prompted, select an email account. Address the message, add a subject and a message, and then touch . See [Compose and Send Email](#) for details on sending email.
 - **Gmail** to send the information as a Gmail attachment. Address the message, add a subject and a message, and then touch . See [Send a Gmail Message](#) for details.

Accounts and Messaging

With the data service and your device's messaging capabilities, you have the opportunity to share information through many different channels and accounts.

Gmail

You will need a Google Account to access several device features such as Gmail, Google Talk, and the Google Play Store applications. Before you can access Google applications, you must enter your account information. These applications sync between your device and your online Google Account.

Create a Google Account



If you do not already have a Google Account, you can create one online or by using your device.

Note: Although you need a Gmail account to use certain features of your device, such as Google Play Store, you do not need to use Gmail as the default account for your device.

Create a Google Account Online

1. From a computer, launch a Web browser and navigate to google.com.
2. On the main page, click **Sign in > Create an account for free**.
3. Follow the onscreen prompts to create your free account.

Create a Google Account Using Your Device



1. Press Home  > Menu  and touch **System settings > Accounts & sync**.
2. Touch **ADD ACCOUNT > Google > New**.
3. Enter your First name, Last name, and touch **Next**.
4. Enter your desired username, which will be the first part of your Gmail address, and touch **Next**. The system will check the availability of the entered username.
 - If it is not available, enter another desired username and touch **Try again**. You can also select an available username from the list of **Suggested usernames**. Touch **Touch for suggestions**, touch a name and then touch **Try again**.
5. When prompted, enter and reenter a password and touch **Next**.
6. Create a security question and answer, enter a secondary email address to help you recover your password if you ever lose it, and then touch **Next**.

Note: When setting up a new Google Account, either on your device or online, you will be prompted to add a secondary email address. Enter a second Gmail address or any other email address from which you currently send and receive email. This address is used to authenticate your account should you ever encounter problems or forget your password. It is strongly encouraged for Android users so you can regain access to Google Mobile™ services and purchases on your device.

7. Select if you join Google+ now.
8. Select account settings, read and accept Google Terms of Service, and then touch **I accept**.
9. Type the displayed texts for authentication and touch **Next**.
10. Select if you save your credit card information now to enable purchases at the Google Play Store.
11. If you do not want to use your Google Account to back up your apps, settings and other data, clear the check box.
12. Touch **Next**. Your account is displayed on the list.



Sign In to Your Google Account

If you already have a Google Account, sign in with the account.

1. Press **Home**  > **Menu**  and touch **System settings > Accounts & sync**.
2. Touch **ADD ACCOUNT > Google > Existing**.
3. Enter your Gmail username and password, and then touch **Sign in**.
4. Select if you join Google+ now.
5. Select if you save your credit card information now to enable purchases at the Google Play Store.
6. Select the items you want to sync with Google servers and touch **Next**.

Access Gmail

Your device allows you to access, read, and reply to all your Gmail messages.

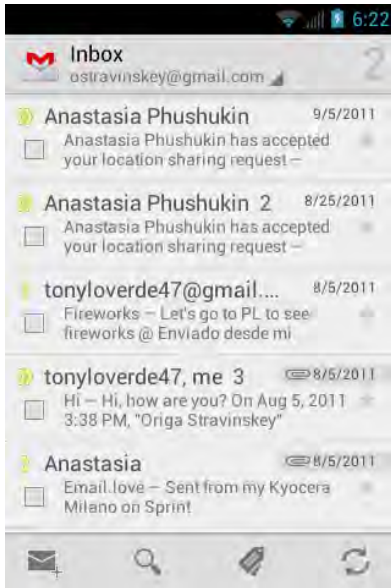

1. Press **Home**  and touch  > **Gmail**.



2. Do any of the following:

- View more email messages: If the Inbox is full, swipe your finger up the screen to view more messages and conversations.
- Read a new email message: Touch the unread message or the conversation with an unread message (just-arrived items display in bold).
- Select messages and conversations: Touch the box before the email or conversation.
- View the Inbox of your other Gmail account. Touch **Inbox** at the top of the screen and select the account you want to view its inbox.
- Refresh the Inbox: Touch .

Send a Gmail Message

1. Press Home  and touch  > Gmail.
2. Touch .
3. Enter the message recipient's email address in the **To** field. If you are sending the email message to several recipients, separate the email addresses with a comma. As you enter email addresses, any matching addresses from your People list are displayed. Touch a match to enter that address directly.

Tip: You can enter a name saved in People to call up the email address. Touch a match from an available list.

Tip: If you want to send a CC or a BCC of the email to other recipients, press **Menu**  and touch **Add Cc/Bcc**.

4. Enter the subject, and then compose your message.



Note: If you want to attach a picture, press **Menu**  and touch **Attach picture**. Locate and then touch the picture you want to attach.

5. After composing your message, touch .





Note: While composing the message, press **Menu**  and touch **Save draft** if you want to send it later. To open a draft email, in the email account Inbox, touch **Inbox** (top of the Gmail screen), and then touch **Drafts**.

Note: To view your sent messages in the Inbox, touch **Inbox**, and then touch **Sent**.

Read and Reply to Gmail Messages

1. Press **Home**  and touch  > **Gmail**.
2. Touch a message to display it.

Tip: You can also access new messages through the status bar. When a new Gmail message arrives, you'll see the  icon in the status bar. Slide the bar down to display notifications. Touch a message to display it.



3. To reply to or forward a message:
 - Touch  to reply to the message.
 - Touch  > **Reply all** to reply to all recipients.
 - Touch  > **Forward** to forward the message.
4. After composing your message, touch .

Email

Use the Email application to send and receive email from your webmail or other accounts, using POP3 or IMAP. You can also access your corporate email and other features on your device.

Add an Email Account (POP3 or IMAP)

You can add several types of personal email accounts, such as POP3 and IMAP accounts, on your device.

1. Press Home  and touch  > **Email**.
2. Enter the Email address and Password for the email account and then touch **Next**.



Important: If the account type you want to set up is not in the device database, you will be asked to enter more details. You should get all pertinent information for the email account, such as incoming and outgoing server settings, before you proceed.

3. Confirm the Account settings and touch **Next**.
4. Enter the name to be displayed on your outgoing messages and touch **Next**. The inbox of the account is displayed.

Add a Corporate Account

If you synchronize your device with your corporate account, you can read, manage, and send email in the same easy way as with a POP3/IMAP account. However, you can also access some powerful Exchange features.

Note: Before setting up a Microsoft® Exchange ActiveSync® account, contact your company's Exchange Server administrator for required sign-in information.

1. Press Home  > Menu  and touch **System settings > Accounts & sync**.
2. Touch **ADD ACCOUNT > Corporate**.
3. Enter your Email address and Password information, and then touch **Next**. Consult your network administrator for further details.
 - **Email address:** your corporate email address.
 - **Password:** typically your network access password (case-sensitive).
4. Enter **Domain\Username**, **Password**, and **Server information** and touch **Next**.
 - **Domain\Username:** enter your network domain\login username.
 - **Password:** typically your network access password (case-sensitive).
 - **Server:** your exchange server remote email address. Typically it is in the form mail.XXX.com. Obtain this information from your company's network administrator.
5. If your network requires SSL encryption, select the **Use secure connection (SSL)** check box and activate this additional level of security. If your exchange server requires this feature, leaving this field unselected can prevent connection.
6. If the onscreen activation disclaimer is displayed, touch **Next**.

7. Configure your Inbox checking frequency, Days to sync (days to synchronize between your device and server), and activate any other email settings, then touch **Next**.



Note: Signal interruptions or incorrect username or password information can cause completion issues.

8. Identify your new account with a unique name and provide the outgoing name, then touch **Done**.

Note: You can have multiple corporate email (Microsoft Exchange ActiveSync) accounts active on your device.



Create Another Email Account

While you are viewing one email account, you can access the tool to create another email account.

1. Press **Home**  and touch  > **Email**.
2. Press **Menu**  and touch **Settings** > **ADD ACCOUNT**.
3. Enter the Email address and Password for the email account and then touch **Next**.
4. Confirm the Account settings and touch **Next**.
5. Enter the name to be displayed on your outgoing messages and touch **Next**. The inbox of the account is displayed.

Compose and Send Email

Compose and send email using any account you have set up on your device. Increase your productivity by attaching files such as pictures or videos to your email messages.



1. Press **Home**  and touch  > **Email**.
2. On the email account Inbox, touch .

Tip: Touch displayed email address to select a different email account.

3. Enter email addresses directly in the **To** field. If you're sending the email to several recipients, separate the email addresses with a comma. As you enter email addresses, any matching addresses from your People list are displayed. Touch a match to enter the address directly.

Tip: You can enter a name saved in People to call up the email address. Touch a match from an available list.





Tip: If you want to send a CC or a BCC of the email to other recipients, press **Menu**  and touch **Add Cc/Bcc**.

4. Enter the subject, and then compose your message.
5. To add an attachment, press **Menu**  and touch **Attach file**, and choose from the following options:
 - **Pictures:** Select photos from Gallery.
 - **Videos:** Select videos from Gallery.
 - **Audio:** Select sound files.
6. Touch  to send the message immediately, or press **Menu**  and touch **Save draft** as draft if you want to send it later.

Note: To open a draft email, in the email account **Inbox**, touch **Inbox** (top of the Email screen), and then touch **Drafts**.







View and Reply to Email

Reading and replying to email on your device is as simple as it is on your computer.

1. Press **Home**  and touch  > **Email**.
2. On the email account **Inbox**, touch the message you want to view.
3. Touch  or  > **Reply all** to reply to the message.

Manage Your Email Inbox

View Your Email Inbox

1. Press **Home**  and touch  > **Email**.
2. Touch the account whose mails you want to view.
 - Touch  to search an email.
 - Touch  to display folders.
 - Touch  to refresh your email box.
 - Press **Menu**  and touch **Settings** to display the Email settings. See [Email General Settings](#) and [Email Account Settings](#).

Refresh an Email Account

Whatever your automatic synchronization settings are, you can also synchronize your sent and received email messages manually at any time.

- While in the account you want to synchronize, touch .

Delete an Email Message



1. On the email account Inbox, touch the message you want to delete (the message is selected).
2. Touch .

Delete Multiple Email Messages

1. On the email account Inbox, touch the check box of the messages you want to delete.
2. Touch .



Email General Settings

You can edit the general settings of your email.

1. Press **Home**  and touch  > **Email**.
2. Press **Menu**  and touch **Settings** > **General**.
 - **Auto-advance:** Choose which screen to show after you delete a message.
 - **Message text size:** Select the message text size.
 - **Reply all:** Select if you want to display “Reply all” option as default.
 - **Ask to show pictures:** Touch if you want to be asked before pictures in messages to be displayed.

Email Account Settings



You can edit the settings of your individual email accounts, such as email address and password, name display and signature, frequency of retrieval, and more.

1. Press **Home**  and touch  > **Email**.
2. Press **Menu**  and touch **Settings**.
3. Select the account you want to edit the settings of.
4. Set the following options:
 - **Account name:** Edit your account name.
 - **Your name:** Edit your name displayed on your emails.

- **Signature:** Allows you to create an email signature for your outgoing emails.
- **Quick responses:** Allows you to edit text you frequently insert when composing emails.
- **Default account:** Assign this account as the default email used for outgoing messages.
- **Inbox check frequency:** Touch to select the time interval used by your device to check your new emails from **Automatic (Push)** (corporate only) **Never**, **Every 5 minutes**, **Every 10 minutes**, **Every 15 minutes**, **Every 30 minutes**, and **Every hour**.
- **Days to sync:** Sets a period of time to synchronize your account (corporate only).
- **Sync email:** Select to synchronize your email (corporate account only).
- **Sync contacts:** Select to synchronize your contacts (corporate account only).
- **Sync calendar:** Select to synchronize your calendar (corporate account only).
- **Download attachments:** Select if you want to automatically download attachments via Wi-Fi.
- **Email notifications:** Activates the email notification icon to appear within the notifications area of the status bar when a new email is received.
 - **Choose ringtone:** Plays a selected ringtone once a new email message is received.
 - **Vibrate:** Activates a vibration once a new email message is received.
- **Incoming settings:** Adjusts the incoming email parameters, such as username, password, and other incoming connection parameters (ex: IMAP server).
- **Outgoing settings:** Adjusts the outgoing parameters, such as username, password, and other outgoing connection parameters (ex: SMTP server, not for a corporate account).
- **Out of office settings:** Sets your current status and your message to reply automatically when you leave your office (corporate account only).
- **Remove account:** Touch to remove the account.

Delete an Email Account

If you no longer want an email account on your device, you can delete it through the mail settings menu.

1. Press Home  and touch  > **Email**.
2. Press Menu  and touch **Settings**.
3. Select the account you want to delete.
4. Touch **Remove account** > **OK**.

Text Messaging and MMS



With Text Messaging (SMS), you can send and receive instant text messages between your wireless device and another messaging-ready phone.

Multimedia messages, or MMS, can contain text and pictures, recorded voice, audio or video files, or picture slideshows.

See your service plan for applicable charges for messaging.

Compose Text Messages

Quickly compose and send text messages on your device.

1. Press Home  and touch  > **Messaging**.
2. On the Messaging screen, touch . The compose screen opens.
3. Fill in one or more recipients.
 - Enter phone numbers or email addresses in the **To** field. If you're sending the message to several recipients, separate the phone numbers or email addresses with commas. As you enter information, any matching phone numbers or addresses from your People list are displayed. Touch a match to enter that number or address.

Tip: You can call up a phone number or email address by entering a name saved in People. Touch a match from an available list.

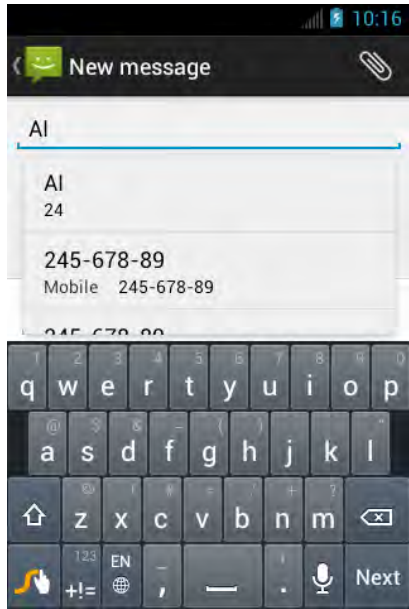



4. Touch **Type message** and then start composing your message.

Tip: You can add a subject line by pressing **Menu**  and then touching **Add subject**.

5. When done, touch  to send the text message.

Send a Multimedia Message (MMS)



When you need to add a little more to a text message, you can send a multimedia message (MMS) with pictures, recorded voices, or audio or video files, or slideshows.

1. Press **Home**  and touch  > **Messaging**.
2. On the Messaging screen, touch . The compose screen opens.
3. Fill in one or more recipients.
 - Enter phone numbers or email addresses in the **To** field. If you're sending the message to several recipients, separate the phone numbers or email addresses with commas. As you enter information, any matching phone numbers or addresses from your **People** list are displayed. Touch a match to enter that number or address.

Tip: You can call up a phone number or email address by entering a name saved in **People**. Touch a match from an available list.



4. Touch **Type message** and then start composing your message.

Tip: You can add a subject line by pressing **Menu**  and then touching **Add subject**.

5. Touch  and select from the following file attachments.
 - **Pictures:** Open Gallery to attach a photo from your storage card.
 - **Capture picture:** Run the camera application to take a photo and attach it.
 - **Videos:** Open Gallery to attach a video from your storage card.
 - **Capture video:** Run the camcorder application to take a video and attach it.
 - **Audio:** Select a ringtone and attach it.
 - **Record audio:** Run the voice recorder application to create a recording and attach it.
 - **Slideshow:** See [Create a Slideshow](#) for details.
6. To make changes to your attachment, touch **Replace** or **Remove**.
7. Touch  to send the MMS message.

Create a Slideshow



In a multimedia message, you can add slides, each containing a photo, video, or audio.

1. In the multimedia message you're composing, Touch  > **Slideshow**.
2. To compose your slideshow, do any of the following.
 - Touch **Add slide** to create a new slide. (This is a placeholder for new images to be added, similar to a playlist.)
 - Touch the created slide (example, Slide 1), touch **Add picture**, and then select the picture you want to add to the slide.
 - Touch the text field below the image to enter a caption for the picture.
 - Touch **Preview** (to preview the slide), **Replace picture** (to delete the currently selected picture), **Remove slide**, or press **Menu**  and touch **Add music**, **Add slide**, **Duration**, or **Layout**.
 - When finished, touch **Done** to attach the slideshow to your message.
3. When you have finished composing the multimedia message, touch **Send**.

Save and Resume a Draft Message



While composing a text or multimedia message, press **Back**  and touch **Yes** to save your message as a draft.

To resume composing the message:

1. On the Messaging screen, touch the message to resume editing it. “Draft” in red appears at the right of the message in the list.
2. When you finish editing the message, touch  or if you add attachments to your message, touch .

New Messages Notification

Depending on your notification settings, the device will play a ringtone, vibrate, or display the message briefly in the status bar when you receive a new text or multimedia message. To change the notification for new text and multimedia messages, see [Text and MMS Options](#) for details.

A new message icon  or  also appears in the notifications area of the status bar to notify you of a new text or multimedia message.

To open the message, slide the status bar down to open the Notifications panel. Touch the new message to open and read it. For information on reading and replying to messages see [Managing Message Conversations](#).

Managing Message Conversations

Text and multimedia messages that are sent to and received from a contact (or a number) are grouped into conversations or message threads in the Messaging screen. Threaded text or multimedia messages let you see exchanged messages (similar to a chat program) with a contact on the screen.

To read a text message:

- ▶ Do one of the following:
 - On the Messaging screen, touch the text message or message thread to open and read it.
 - If you have a new message notification, slide the status bar down to open the Notifications panel. Touch the new message to open and read it.



To return to the Messaging screen from a text message thread, press **Back** .

Note: To view the details of a particular message, in the message thread, touch and hold the message to open the options menu, and then touch **View details**.

Note: If a message contains a link to a Web page, touch the message and then touch the link to open it in the Web browser.

Note: If a message contains a phone number, touch the message to dial the number or touch and hold the message to add it to your People list.



To view a multimedia message (MMS):

1. Press Home  and touch  > **Messaging**.
2. On the Messaging screen, touch a multimedia message or message thread to open it.
3. Touch the attachment to open it.



Tip: To save the attachment, touch and hold the message, and then touch **Save attachment** on the options menu.

Note: When **Auto-retrieve** in MMS settings is disabled, only the message header is downloaded. To download the entire message, touch the **Download** button. For details, see [Text and MMS Options](#).

To reply with a multimedia message (MMS):

1. Press Home  and touch  > **Messaging**.
2. On the Messaging screen, touch a text or multimedia message thread to open it.
3. Touch the text box at the bottom of the screen, enter your reply message, attach files and then touch .

To delete a message thread:

1. Press Home  and touch  > **Messaging**.
2. On the Messaging screen, touch and hold the message thread that you want to delete.
3. Touch .
4. When prompted to confirm, touch **Delete**.



To delete a single message:

1. While viewing a message thread, touch and hold the message that you want to delete.
2. From the options menu, touch **Delete**.
3. When prompted to confirm, touch **Delete**.

When you have received a message from someone stored in your People, you can touch the entry's photo or icon in the message thread to open a menu of options. Depending on the stored entry information, you can view the entry details, phone or send an email message to the entry, and more.

Text and MMS Options

The messages settings menu lets you control options for your text and MMS messages including message limits, and notifications.

1. Press Home  and touch  > **Messaging**.
2. Press Menu  and touch **Settings**. You can set the following options.

Storage Settings

- **Delete old messages:** Automatically delete older messages, when the set limits are reached.
- **Text message limit:** Choose the maximum number of text messages to store in each conversation thread.
- **Multimedia message limit:** Choose the maximum number of MMS messages to store in each conversation thread.

Text (SMS) Messages Settings

- **Delivery reports:** Select this option to request a delivery report for each message you send.
- **Emergency Alerts:** Sets the federally supervised cell phone alert services to send out SMS messages for public warning.
 - **Presidential:** Receives an emergency presidential alert. (Presidential is always grayed out [not selectable] and cannot be excluded.)
 - **Imminent Threat - Extreme:** Select this option if you want to receive emergency alerts of extreme emergency situations (extraordinary threats to life or property).
 - **Imminent Threat - Severe:** Select this option if you want to receive emergency alerts of severe emergency situations (significant threats to life or property).
 - **Amber:** Select this option if you want to receive alerts related to missing or endangered children.
 - **Emergency Alerts Test:** Select this option if you want to receive a test message to make sure that the alert messages can be successfully received.
 - **Help:** Displays the help information for Emergency Alerts.

Multimedia (MMS) Messages Settings

- **Delivery reports:** Select this option to request a delivery report for each message you send.

- **Read reports:** Select this option to request a read report for each message you send.
- **Auto-retrieve:** Select this option to automatically retrieve all your multimedia messages completely. When selected, the multimedia message header plus the message body and attachments will automatically download to your device. If you clear this check box, only the multimedia message header will be retrieved and shown in your Messaging screen.
 - **Roaming auto-retrieve:** Select this option to automatically retrieve all your messages completely when roaming. This may incur significant phone charges.

Notifications Settings

- **Notifications:** Select this option if you want to receive a notification in the status bar when a new text or multimedia message arrives.
 - **Choose ringtone:** Select a ringtone that is specific to new text and multimedia messages. Note that the ringtone briefly plays when selected.
 - **Vibrate:** Select when your device to vibrate when a new text or multimedia message arrives.



Social Networking Accounts

Stay in touch on the go with all your social networking accounts.

YouTube

YouTube™ is a video sharing website on which users can upload and share videos. The site is used to display a wide variety of user-generated video content, including movie clips, TV clips, and music videos, as well as video content such as video blogging, informational shorts and other original videos.

Opening YouTube



- ▶ Press Home  and touch  > YouTube.

Note: If **Terms of Service** appears, touch **Accept** if you agree to the **Terms of Service**.

Watching YouTube Videos

1. On the YouTube screen, touch a video.
2. Touch the screen to show the progress bar at the bottom. Touch the screen while the bar is displayed to pause/play the video. Move the slider on the bar to the left or right to rewind or fast-forward the video.

Searching for Videos

1. On the YouTube screen, touch  at the upper right of the screen to open the search box.
2. Enter the keyword to search. Search results appear below the status bar.
3. Touch one of the results, or touch  or .
4. Scroll through the results and touch a video to watch it.

Google Talk

Google Talk is the instant messaging program provided by Google. Google Talk lets you chat with other people that also have a Google Account. Your Google Talk account is based on the Google Account set on your device.

Signing In and Chatting

You need to sign in to Google Talk before chatting.

- Press Home  and touch  > Talk to open Google Talk.

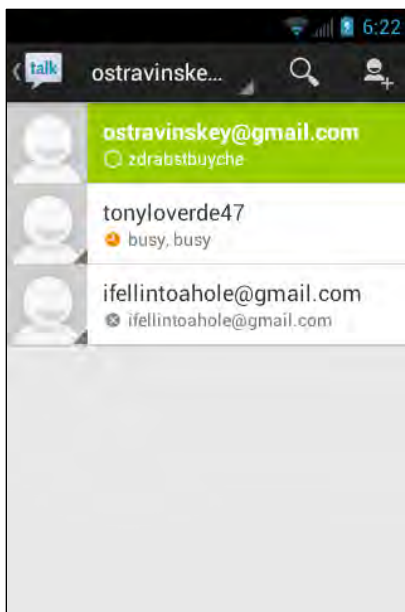

Adding New Friends

You can only add people who have a Google Account.

1. On the friends list screen, touch .
2. Enter the Google Talk ID or the Gmail address of the person you want to add.

3. Touch **DONE**.

Accepting or Declining Invitations

On the friends list screen, touch **Chat invitation**. When an invitation pop-up window appears, touch **Accept**, **Decline** or **Block**.

Changing Your Online Status Message

1. On the friends list screen, touch your email address at the top of the list.
2. Touch the status and select the status you want from the menu.
3. Touch the text box below the online status, and then type your status message.
4. Press **Back** .

Starting a Chat

1. Touch a friend on the friends list.
2. Touch the text box, and then type your message.
3. Touch .

Switching Between Active Chats

You can conduct multiple chats at the same time and switch between active chats.

- ▶ On the friends list, touch the friend you want to chat with.

Closing a Chat

To close the chat, do one of the followings.

- ▶ On a chat screen, press **Menu**  and touch **End chat**.

- or -

On the friends list screen, press **Menu**  and touch **End all chats**. All the chats will be closed.

Managing Your Friends

Friends on the friends list screen are sorted according to their online status and are listed alphabetically.

Viewing the Friends List

You can sort your friends as you like.

- ▶ On the friends list screen, press **Menu**  and touch **Display option**.
 - **Availability** to show friends that are available at the top of the list in order of how frequently you chat with them.
 - **Name** to list your friends alphabetically.
 - **Recency** to show the friends that you have most recently chatted with first.

Blocking Friends

You can block friends from sending you messages.

1. On the friends list screen, touch the name of the friend you want to block.
2. Press **Menu**  and touch **Friend info > Block**. That friend is removed from your friends list and is added to the blocked friends list.

Unblocking Friends

1. On the friends list screen, press **Menu**  and touch **Settings** and touch your account.
2. Touch **Blocked friends**.
3. On the blocked friends list, touch the name of the friend you want to unblock.
4. Touch **OK** to confirm.

Mobile Indicators

Mobile indicators allow you to check your friend's device.

Checking Friends' Devices

You can see which devices your friends are using to chat in Google Talk.

- If “On mobile device” appears below your friend's name, it indicates that your friend is using an Android phone.
- If an email address is displayed, it indicates that your friend is using a computer.

Displaying a Mobile Indicator

You can choose to show a mobile indicator along with your name to let your friends know the type of wireless device you are using.

1. On the friends list screen, press **Menu**  and touch **Settings**.
2. Touch your account name and select the **Mobile indicator** check box.

Signing Out

Follow the steps to sign out from the Google Talk.

- ▶ On the friends list screen, press **Menu**  and touch **Sign out** to sign out from Google Talk.

Google Talk Settings

You can manage the Google Talk settings as you like.

1. On the friends list screen, press **Menu**  and touch **Settings**.
2. Touch your account name and touch any of the following to change the settings.
 - **Mobile indicator:** Select to allow your friends to see the type of wireless device you are using. See [Mobile Indicators](#).
 - **Away when screen off:** Select to show your status as away when the screen is turned off.
 - **Invitation notifications:** Select to show a notification in the status bar when someone invites you to become a friend.
 - **IM notifications:** Select to show a new instant message icon on the status bar when a new instant message is received.
 - **Notification ringtone:** Select if you want the device to ring when a new instant message is received. On the ringtone menu, touch a ringtone to play the tone briefly, and then touch **OK** to confirm selection. Select **Silent** if you do not want the device to ring when a new instant message is received.
 - **Vibrate:** Select if you want the device to vibrate when a new instant message is received.
 - **Video chat notifications:** Select if you want the device open a dialog or only to show notification when a voice or video chat invitation arrives.
 - **Video chat ringtone:** Select if you want the device to ring when a new video chat notification arrives. On the ringtone menu, touch a ringtone to play the tone briefly, and then touch **OK** to confirm selection. Select **Silent** if you do not want the device to ring when a new video chat notification arrives.
 - **Vibrate:** Select if you want the device to vibrate when a new video chat notification arrives.
 - **Blocked friends:** Select to show your blocked friends list.
 - **Clear search history:** Select to delete the Google Talk search history.

- **Manage account:** Select to open the Accounts & sync settings menu.
- **Terms & privacy:** Select to show the Google legal information.

Applications and Entertainment

All of your device's features are accessible through the Applications list. Touch the applications launcher icon  on the Home screen.

Google Play



Google Play™ is your digital content destination to discover Android apps, books, movies, music and much more on your device and on the web.

To access the Google Play Store app, you must first connect to the Internet using your device's Wi-Fi or data connection and sign in to your Google Account. See [Web and Data](#) and [Sign In to Your Google Account](#) for details.

Important: Cricket's policies often do not apply to third-party applications. Third-party applications may access your personal information or require Cricket to disclose your customer information to the third-party application provider. To find out how a third-party application will collect, access, use, or disclose your personal information, check the application provider's policies, which can usually be found on their website. If you aren't comfortable with the third-party application's policies, don't use the application.

Find and Install an App

When you install apps from the Google Play Store app and use them on your device, they may require access to your personal information (such as your location, contact data, and more) or access to certain functions or settings of your device. Download and install only apps that you trust.

1. Press Home  and touch  > Play Store.
2. When you open the Google Play Store app for the first time, the **Terms of Service** window will appear. Touch **Accept** to continue if you agree to the Terms of Service.
3. Find an app you want and touch it to open its details screen.

Note: The Google Play Store screen shots and options may vary depending on the version installed on your device. Your Google Play Store app will update automatically when available.

4. Touch an app to read a description about the app and user reviews.
5. Touch **INSTALL** (for free applications) or the price icon (for paid applications).

Note: You need a Google Wallet account to purchase items on Google Play. See [Create a Google Wallet Account](#) to set up a Google Wallet account if you do not have one.

6. The subsequent screen notifies you whether the app will require access to your personal information or access to certain functions or settings of your device. If you agree to the conditions, touch **ACCEPT** to begin downloading and installing the app.

If you selected a paid app, after touching **ACCEPT**, you're redirected to the Google Wallet screen to pay for the app before it's downloaded to your device.

Warning: **Read the notification carefully! Be especially cautious with apps that have access to many functions or a significant amount of your data. Once you touch **OK** on this screen, you are responsible for the results of using this item on your device.**

Create a Google Wallet Account

You must have a Google Wallet account associated with your Google Account to purchase items from Google Play.

Do one of the following:

- ▶ On your computer, go to wallet.google.com to create a Google Wallet account.

- or -



The first time you use your device to buy an item from Google Play, you're prompted to enter your billing information to set up a Google Wallet account.

Warning: **When you've used Google Wallet once to purchase an app from the Google Play Store app, the device remembers your password, so you don't need to enter it the next time. For this reason, you should secure your device to prevent others from using it without your permission. (For more information, see [Security](#).)**

Request a Refund for a Paid App



If you are not satisfied with an app, you must ask for a refund within 15 minutes of purchase, unless otherwise stated by the app developer. Your credit card is not charged and the app is uninstalled from your device.

If you change your mind, you can install the app again, but you can't request a refund a second time.



1. Press **Home**  and touch  > **Play Store**.
2. Touch  on the top left of the screen, or touch and hold the left end of the screen and slide it to the right, and touch **My apps**.
3. Touch the application to uninstall for a refund. The details screen for the app opens.
4. Touch **Refund**. Your app is uninstalled and the charge is cancelled.

Open an Installed App

There are several options for opening an installed app.



- ▶ On the status bar, check if you see the  icon. If you see the  icon, open the Notifications panel, and then touch the app to open it.

- or -



1. Press Home  and touch .
2. On the All apps screen, locate the app, and then touch the icon.

Uninstall an App

You can uninstall any app that you have downloaded and installed from the Google Play Store app.

1. Press Home  and touch  > **Play Store**.
2. Touch  on the top left of the screen, or touch and hold the left end of the screen and slide it to the right, and touch **My apps**.
3. On the INSTALLED screen, touch the app you want to uninstall, and then touch **UNINSTALL**.
4. When prompted, touch **OK** to remove the app on your device.

- or -



1. Press Home  > Menu  and touch **System settings** > **Apps**.
2. Touch the **DOWNLOADED** tab and touch the app you want to uninstall, and then touch **Uninstall**.
3. When prompted, touch **OK** to remove the app on your device.
4. Touch **OK**.

Get Help with Google Play

If you ever need help or have questions about Google Play, press Menu  and touch **Help**. The Web browser will take you to the Google Play Help Web page.

Cricket Shop

Cricket Shop is where you may purchase games and applications. You must have Flex Bucket funds available in order to make purchases from Cricket Shop. See mycricket.com/support/topic/flex-bucket for details.

- ▶ Press Home  and touch  > Cricket Shop.

Navigation

Your device offers a number of location-based navigation programs to help you figure out where you are and get you where you're going.

Note: You may be asked or redirected to enable your phone's location features for using location-based apps, if you have not enabled them yet. See [Location Services](#).

Google Maps

Use this application to find directions, location information, business addresses, etc., all right from your device. Determine your current location with or without GPS, get driving and transit directions, get phone numbers and addresses for local businesses.

Note: When you open the Google Maps apps for the first time, the Welcome to Google Maps screen will appear. Touch **Accept & continue** if you agree to the Terms of Service and Privacy Policy.

Opening Google Maps

- ▶ Press Home  and touch  > Maps.

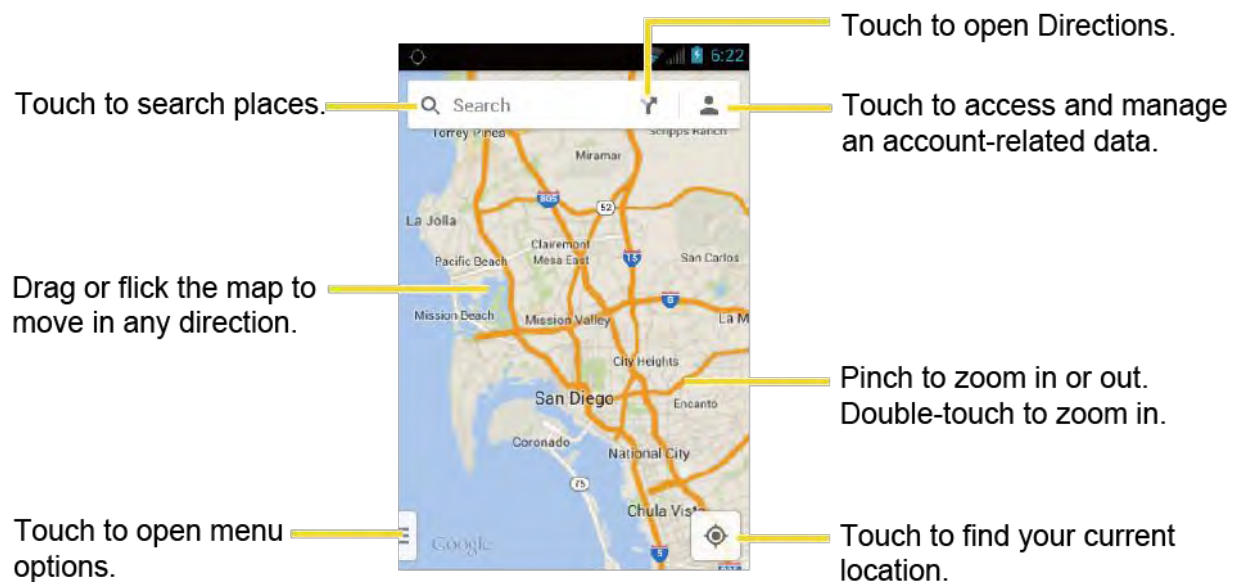

Finding Your Current Location



Note: Don't forget to set your location sources.

On the Google Maps screen, touch . A blue mark indicates your current location on the map. This feature is available when **Google's location service** or **GPS satellites** is enabled. See [Location Services](#).

Searching Maps

1. On the Google Maps screen, touch .
2. Type the place that you want to search. You can enter an address, a city, or type of establishment.

Tip: Touch  to search by speaking the location you are searching.

3. Touch a matching result on the drop-down list, or touch  or  on the keyboard. A red marker appears on the map to indicate the location together with a label at the bottom of the screen.
4. Touch the marker or the label to open the menu for the location.



Adding Map Layers



Layers allow you to view locations and additional information overlaid on the map. Some of the layers are available in selected areas only.

- ▶ On the Google Maps screen, press **Menu** :
 - **Traffic:** Provides real-time traffic information. The colors on the roads indicate the traffic conditions.
 - **Public Transit:** Provides available transit information.
 - **Bicycling:** Provides possible cycling routes.
 - **Satellite:** Provides the hybrid view of road labels overlaid on a satellite image.
 - **Google Earth:** Launches the Google Earth app and displays your location in Google Earth.

Note: Touch [Settings](#), [Help](#), [Send feedback](#) or [Tips and Tricks](#) for additional options.

Getting Directions

1. On the Google Maps screen, touch .
 - Touch  to enter your home or work address.

2. Specify the starting point and the destination:
 - The starting point is set to your current location as default. To change it, touch **My Location** and type a new point in the **Choose starting point...** field or select a point from the list.
 - Touch **Choose destination...** and type your destination or select a destination from the list.
 - Touch  to switch the starting point and the destination.
3. Select the way to get to the destination (by car, by train, or by foot).
 - You may touch  or **Options** to configure available settings options.
4. Touch the result to see the details.



Cricket Navigator

Cricket Navigator gives you turn-by-turn directions onscreen and over speakerphone as well as local search and maps.

- ▶ Press Home  and touch  > Cricket Navigator.

Muve Music™

Muve Music™ offers unlimited music (full track downloads, ringtones and ringback tones) as part of a new wireless rate plan. See Muve Reference Guide and visit mycricket.com/muve-music for details.

- ▶ Press Home  and touch  > MuveMusic.

Google Play Music



The **Play Music** app plays digital audio files saved on the storage card. You need to copy music files to your storage card first to use the Music application. See [Use the Device's microSD Card as a USB Drive](#) for more details on copying files.



Note: If you have signed up for **Google Music™**, the first time you open the **Play Music** application you will be prompted to select the account whose online music library you want to access from the **Google Play Music** application. Follow the onscreen instructions to continue.

Opening the Music Library

- ▶ Press Home  and touch  > **Play Music**. The Listen Now screen appears.

The Listen Now Screen

- ▶ Touch **I'm feeling lucky** to play the music on your device in shuffle mode.
- ▶ Touch an album image and then touch a song in the album to play it.
- ▶ Press **Menu**  on the device or touch  on the screen for available options.
- ▶ Touch  to search for music.

The label of the currently played song appears at the bottom of the screen when you play music. Simply touch  or  on the label or touch the label to display a screen with more control menus to manage.

More Screens

You can play and manage music from other screens, too, in a similar way.

- ▶ Touch  on the top left of the screen, or touch and hold the left end of the screen and slide it to the right, to display the screen options.
 - **My Library:** Your music is sorted by **GENRES**, **ARTISTS**, **ALBUMS** and **SONGS**.
 - **Playlists:** Your playlists are displayed.



Backing Up Your Downloaded Music Files

It is recommended that you back up your downloaded music files to your computer. Although the downloaded files can only be played on your device and on your account, backing them up to your computer lets you access the files in case your microSD card is lost or damaged, or if you install a new microSD card. See [microSD Card](#).

1. Connect your device to your computer using a USB cable.
2. Use your computer to navigate to the microSD card's Music folder.
3. Select and copy the music files to a folder on your computer's hard drive.

Mobile Web

Mobile Web allows you to access the many useful links on our Cricket Mobile Web deck, as well as surf the mobile Internet. On-deck you will find quick and handy links to social networking sites such as MySpace and Facebook, instant weather, horoscope and lottery links, as well as many other sites including sports, news and shopping. See mycricket.com/features-and-downloads/mobile-web for Cricket's Mobile Web partners.

- ▶ Press **Home**  and touch  > **Mobile Web**.



Note: The Mobile Web service will not work in roaming coverage areas.

Note: Depending on your plan, you may be charged for using the Mobile Web service. Check your plan at [My Account](#).

Cricket411

Cricket411 is a Directory Assistance service where you can get useful information, including residential, business, and government listings; movie listings or showtimes, and more.



Note: Depending on your plan, you may be charged for using the Cricket411 service. Check your plan at [My Account](#).

- ▶ Press Home  and touch  > Cricket411.

My Account

My Account provides you with billing and account information from your device or online.

To access My Account from the application on your Cricket phone:



- ▶ Press Home  and touch  > My Account.

To access My Account Online:

- ▶ Launch a Web browser and navigate to account.mycricket.com.

Evolve Money

Evolve Money is the fast, easy, free way to pay all of your bills. You can access Evolve Money directly from your phone.

- ▶ Press Home  and touch  > Evolve Money.

Web and Data

Your device's data capabilities let you wirelessly access the Internet or your corporate network through a variety of connections, including:

- Wi-Fi
- Data Services



This section addresses your device's data connections and the built-in Web browser. Additional data-related features can be found in [Accounts and Messaging](#), [Applications and Entertainment](#), and [Tools and Calendar](#).

Wi-Fi

Wi-Fi provides wireless Internet access over distances of up to 300 feet. To use your device's Wi-Fi, you need access to a wireless access point or "hotspot."



The availability and range of the Wi-Fi signal depends on a number of factors, including infrastructure and other objects through which the signal passes.

Turn Wi-Fi On and Connect to a Wireless Network

1. Press Home  > Menu  and touch **System settings**.
2. If **OFF** is displayed at the right of **Wi-Fi**, Touch it to turn Wi-Fi on. **ON** is displayed and the device will scan for available wireless networks.
3. Touch **Wi-Fi**. The network names and security settings (open network or secured with WEP/WPA/WPA2 PSK) of detected Wi-Fi networks are displayed.
4. Touch a Wi-Fi network to connect. If you selected an open network, you will be automatically connected to the network. If you selected a network that is secured, enter the key, and then touch **Connect**.

Depending on the network type and its security settings, you may also need to enter more information or choose a security certificate.



When your device is connected to a wireless network, the Wi-Fi icon () appears in the status bar and tells you the approximate signal strength. (The above icon indicates maximum signal strength.)

If **Network notification** is enabled, this icon () appears in the status bar whenever the device detects an available open wireless network within range. Press Menu , touch **Advanced**, and select the **Network notification** check box.

Note: The next time your device connects to a previously accessed secured wireless network, you will not be prompted to enter the security key again, unless you reset your device to its factory default settings.



Note: Wi-Fi networks are self-discoverable, which means no additional steps are required for your device to connect to a Wi-Fi network. It may be necessary to provide a username and password for certain closed wireless networks.

Check the Wireless Network Status

1. Press Home  > Menu  and touch **System settings** > **Wi-Fi**.
2. Touch the wireless network that the device is currently connected to. You will see a message box showing the Wi-Fi network name, status, speed, signal strength, and other details.

Note: If you want to remove the wireless network settings, touch **Forget** on this window. You need to enter the settings again if you want to connect to this wireless network.

Connect to a Different Wi-Fi Network

1. Press Home  > Menu  and touch **System settings** > **Wi-Fi**. Detected Wi-Fi networks are displayed in the Wi-Fi networks section. To manually scan for available Wi-Fi networks touch **SCAN**.
2. Touch another Wi-Fi network to connect to it.

Note: If the wireless network you want to connect to is not in the list of detected networks, scroll down the screen, and touch **ADD NETWORK**. Enter the wireless network settings and touch **Save**.

Data Services

With your service, you are ready to start enjoying the advantages of data services. This section will help you learn the basics of using your data services, including managing your username, launching a data connection, and navigating the Web with your device.

Important: Certain data services requests may require additional time to process. While your device is loading the requested service, the touchscreen keyboard may appear unresponsive when in fact they are functioning properly. Allow the device some time to process your data usage request.

Launch a Web Connection

Launching a Web connection is as simple as opening the browser on your device.

- ▶ Press Home  and touch  > **Browser**. (Your data connection starts and you see the home page.)





Note: Internet connections can be made either through the data service or via Wi-Fi (configured within the **Settings > Wi-Fi**).

Tip: To change the device's default launch page to your current page, press **Menu**  and touch **Settings > General > Set homepage > Current page**.

Note: The Browser automatically launches when a Web link is touched from within either an email or text message.

Data Connection Status and Indicators

Your device displays the current status of your data connection through indicators at the top of the screen. The following symbols are used:

Icon	Description
	Your device is connected to the 3G network and is transferring data (for example, when you are opening a Web page).
	Your device is connected to the 3G network but is not currently transferring data (for example, when you are viewing a Web page that is completely open).
	Your device is connected to the 1x network and is transferring data (for example, when you are opening a Web page).
	Your device is connected to the 1x network but is not currently transferring data (for example, when you are viewing a Web page that is completely open).

In any state, you can receive incoming calls.

If you do not see an indicator, your device does not have a current data connection. To launch a connection, see [Launch a Web Connection](#).

Browser

Your device's Web browser gives you full access to both mobile and traditional websites on the go, using data service, or Wi-Fi data connections.

Learn to Navigate the Browser

Navigating through menus and websites during a data session is easy once you have learned a few basics.

Note: Before you access the home page, you may be asked to enter your 10-digit wireless phone number and touch **OK**. Entering your phone number is not required for access to other Web pages.

Scrolling

As with other parts of your device's menu, you'll have to drag up and down to see everything on some websites.

To scroll through a website's page:

- ▶ In a single motion, touch and drag across or up and down a page.

Selecting

To select onscreen items or links:

- ▶ Drag across a page, and then touch an item or onscreen link.

Links, which are displayed as underlined text, allow you to jump to Web pages, select special functions, or even place phone calls.

Go Back

To go back one page:

- ▶ Press **Back**  on your device. Repeat this process to keep going back through your Web page history of recently visited pages.

Go to a Web Page

1. Touch the Address field (top of the browser window) and enter a new Web address.
 - As you enter the address, possible matches are displayed within an onscreen list. Touch an entry to launch the desired website.
2. Touch **Go** to launch the new page.



Note: Not all websites are viewable on your device.

Browser Menu

The browser menu offers additional options to expand your use of the Web on your device.

Open the Browser Menu

The browser menu may be opened anytime you have an active data session, from any page you are viewing.

1. Press **Home**  and touch  > **Browser**.
2. Press **Menu** . You will see the browser menu.

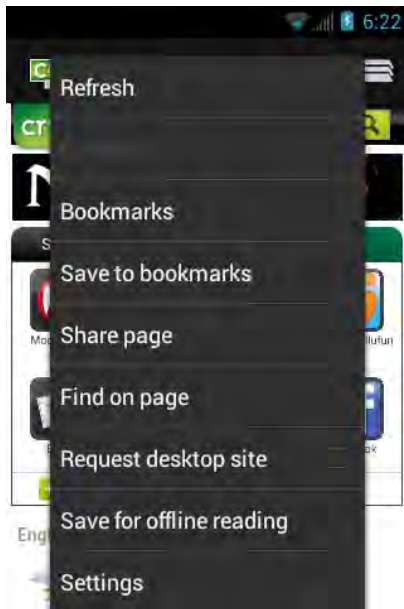

Options available within the browser menu include:

- **Stop:** Stops loading the current Web page.
- **Refresh:** Reloads the current Web page.
- **Forward:** Returns you to a previously viewed page.
- **Bookmarks:** Allows you to access and manage your bookmarks.
- **Save to bookmarks:** Adds the currently viewed page as a bookmark.
- **Share page:** Allows you to send a URL via Gmail, SMS, Email, or Bluetooth.
- **Find on page:** Searches the current Web page for a word.
- **Request desktop site:** Displays the PC site of the current Web page.
- **Save for offline reading:** Saves the current Web page in cache to read it offline.
- **Settings:** Lets you configure and manage your browser settings.

Select Text on a Web Page

You can highlight text on a Web page and copy it, search for it, or share it.

1. Scroll to the area of the Web page containing the text you want to select.
2. Touch and hold the text you want to copy. Drag tabs to expand or reduce the range of selected text. Any selected text will appear highlighted.

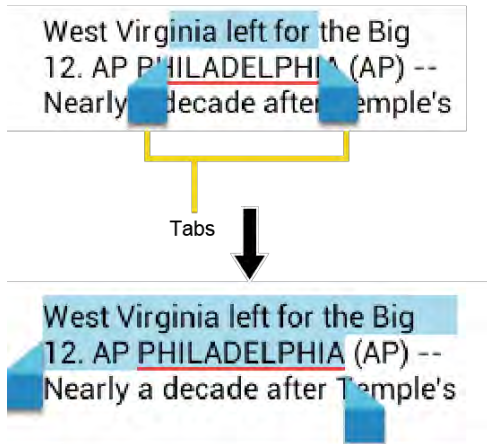



Tip: Touch **SELECT ALL** to select all the text on the Web page.

3. Touch  and select the following options:
 - **Copy** to copy the selected text.
 - **Share** to share the selected text via Bluetooth, Gmail, messaging, etc.
 - **Find** to find the selected text on the Web page.
 - **Web Search** to search the selected text on Internet.

Adjust Browser Settings

You can change the settings for your browser, including setting your home page, and more.

1. Press **Home**  and touch  > **Browser**.
2. Press **Menu**  and touch **Settings** > **General**.
3. Select from one of the following browser general settings:
 - **Set homepage:** Sets the current home page for the Web browser.
 - **Form auto-fill:** Fills out web forms with a single touch.
 - **Auto-fill text:** Sets up text to auto-fill in web forms.

Adjust Browser Privacy and Security Settings



You can adjust your browser's privacy and security settings such as whether or not to save passwords, history, or cache.

1. Press **Home**  and touch  > **Browser**.

2. Press Menu  and touch **Settings > Privacy & security**.
3. Select from one of the following browser privacy and security settings:
 - **Clear cache:** Deletes all currently cached data. Touch **OK** to complete the process.
 - **Clear history:** Clears the browser navigation history. Touch **OK** to complete the process.
 - **Show security warnings:** Notifies you if there is a security issue with the current website. Clear the check mark to disable this function.
 - **Accept cookies:** Allows sites that require cookies to save and read cookies from your device.
 - **Clear all cookie data:** Clears all current browser cookie files. Touch **OK** to complete the process.
 - **Remember form data:** Allows the device to store data from any previously filled-out forms. Clear the check mark to disable this function.
 - **Clear form data:** Deletes any stored data from previously filled out forms. Touch **OK** to complete the process.
 - **Enable location:** Allows sites to request access to your current location (using the built-in GPS function).
 - **Clear location access:** Clears location access for all websites. Touch **OK** to complete the process.
 - **Remember passwords:** Stores usernames and passwords for visited sites. Clear the check mark to disable this function.
 - **Clear passwords:** Deletes any previously stored usernames or passwords. Touch **OK** to complete the process.

Adjust Browser Accessibility Settings



You can adjust your browser's accessibility settings such as font size or screen inversion.

1. Press Home  and touch  > **Browser**.
2. Press Menu  and touch **Settings > Accessibility**.
3. Select from one of the following browser accessibility settings:
 - **Force enable zoom:** Overrides a website's request to control zoom behavior.
 - **Text scaling:** Changes text size as you see on its preview screen.

- **Zoom on double-tap:** Enables zoom function by double-tapping the screen.
- **Minimum font size:** Sets the minimum font size on the Web as you see on its preview screen.
- **Inverted rendering:** Inverts the screen image. Black becomes white and vice versa.
 - **Contrast:** When **Inverted rendering** is enabled, you can set the contrast using the slider.



Adjust Browser Advanced Settings

You can adjust your browser's advanced settings such as setting search engine or default zoom.

1. Press Home  and touch  > **Browser**.
2. Press Menu  and touch **Settings > Advanced**.
3. Select from one of the following browser advanced settings:
 - **Set search engine:** Sets the search engine. See [Set Search Engine](#).
 - **Open in background:** New pages are launched in a separate page and displayed behind the current one. Clear the check mark to disable this function.
 - **Enable JavaScript:** Enables javascript for the current Web page. Without this feature, some pages may not display properly. Clear the check mark to disable this function.
 - **Enable plug-ins:** Allows you to determine the way your device handles program enhancements. Select **Always on**, **On demand**, or **Off**.
 - **Website settings:** Allows you to configure advanced settings for individual websites.
 - **Default zoom:** Sets the default browser viewing size. Choose from: **Far**, **Medium**, or **Close**.
 - **Open pages in overview:** Provides an overview of recently opened pages.
 - **Auto-fit pages:** Allows Web pages to be resized to fit as much of the screen as possible.
 - **Block pop-ups:** Prevents pop-up advertisements or windows from appearing onscreen. Clear the check mark to disable this function.
 - **Text encoding:** Adjusts the current text encoding.
 - **Reset to default:** Resets the browser settings to default.



Adjust Browser Bandwidth Management Settings

You can adjust your browser's bandwidth management settings.

1. Press Home  and touch  > **Browser**.
2. Press Menu  and touch **Settings > Bandwidth management**.
3. Select from one of the following browser bandwidth management settings:
 - **Search result preloading:** Allows browser to preload high confidence search results in the background.
 - **Load images:** Displays images on Web pages.



Adjust Browser Labs Settings

You can adjust your browser's labs settings.

1. Press Home  and touch  > **Browser**.
2. Press Menu  and touch **Settings > Labs**.
3. Select from one of the following browser labs settings:
 - **Quick controls:** Opens the Quick controls and hides application and URL bars.
 - **Fullscreen:** Enables the full screen mode and hides the status bar.



Set Search Engine

You can select the default search engine.

1. Press Home  and touch  > **Browser**.
2. Press Menu  and touch **Settings > Advanced**.
3. Touch **Set search engine** and select a search engine you want to use.

Create Website Settings



You can create settings for individual websites.

1. Press Home  and touch  > **Browser**.
2. Press Menu  and touch **Settings > Advanced > Website settings**.
3. Touch the website you want to create the settings of. These advanced settings can be configured for individual sites.

4. Touch the settings (for example, **Clear location access**) to complete the process.



Reset the Browser to Default

You always have the option to restore your browser to its default settings.

1. Press Home  and touch  > **Browser**.
2. Press Menu  and touch **Settings > Advanced > Reset to default**.
3. Touch **OK** to complete the process.



Set the Browser Home Page

Customize your Web experience by setting your browser's home page.





1. Press Home  and touch  > **Browser**.
2. Press Menu  and touch **Settings > General > Set homepage**.
3. Select the page you want to set as a home page. Touch **Current page** to select the current page as the home page.

Read Web Page Offline

You can save Web pages for offline reading.

1. Press Home  and touch  > **Browser**.
2. Press Menu  and touch **Save for offline reading**. The Web page will be saved in **SAVED PAGES** of the bookmark.

To view the saved pages:

1. Press Home  and touch  > **Browser**.
2. Press Menu  and touch **Bookmarks**.
3. Touch the **SAVED PAGES** tab and select the page you want to view. If you want to view the page online, press Menu  and touch **Go live**.

Manage Bookmarks



Make browsing easier by setting up and using custom bookmarks.

Show Bookmarks



1. Press Home  and touch  > **Browser**.

2. Press **Menu**  and touch **Bookmarks**. Three tabs are revealed:
 - **BOOKMARKS**: Displays a list of your current Web bookmarks.
 - **HISTORY**: Displays a record of your browsing history. These records are organized into folders such as: **Today**, **Yesterday**, **Last 7 days**, and **Most visited**.
 - **SAVED PAGES**: Displays a list of websites you saved for offline reading. Touch an entry to launch the selected page.

Create Bookmarks

1. Press **Home**  and touch  > **Browser**.
2. Open the Web page you want to bookmark.
3. Press **Menu**  and touch **Save to bookmarks**.
4. Enter a descriptive name for the new bookmark.
5. Select an account you want to add the bookmark to.
6. Select where to save the bookmark and touch **OK**.



Create Bookmarks From History Tab

1. Press **Home**  and touch  > **Browser**.
2. Press **Menu**  and touch **Bookmarks**.
3. Touch the **HISTORY** tab.
4. Locate the Web page you want to bookmark and touch the star icon next to it.
5. Edit the necessary info and touch **OK**.

Portable Wi-Fi Hotspot

Portable Wi-Fi Hotspot allows you to turn your device into a Wi-Fi hotspot.



Set Up Portable Wi-Fi Hotspot

1. Press **Home**  and touch  > **Portable Wi-Fi hotspot** > **OK**.
2. Touch **Portable Wi-Fi hotspot** and place a check mark in the adjacent field to activate the service.
 - Using both data service and hotspot drains your device's battery at a much faster rate than when using any other feature combination.



Note: The best way to keep using the device as a hotspot is to have it connected to a power supply.

Important: Write down the passkey (password) for this WEP/WPA/WPA2 PSK communication (shown onscreen).

Connect to Portable Wi-Fi Hotspot

1. Enable Wi-Fi (wireless) functionality on your target device (laptop, media device, etc.).
2. Scan for Wi-Fi networks from the device and select your device hotspot from the network list.
 - Your device name can be changed by pressing Home  and then touching  > **Portable Wi-Fi hotspot** > **Network SSID**.
3. Select this device and follow your onscreen instructions to enter the passkey (provided on the Portable Wi-Fi hotspot page).
4. Launch your Web browser to confirm you have an Internet connection.



Configure Mobile Hotspot

1. Press Home  and touch  > **Portable Wi-Fi hotspot**.
2. Set the following options:
 - **Network SSID:** Sets your network name.
 - **Security:** Sets the security level.
 - **Password:** Sets a password if necessary.
 - **Maximum Wi-Fi clients:** Sets the maximum Wi-Fi clients that can connect to your device.
 - **Auto off:** Sets the length of time to elapse when your hotspot feature is disabled if there is no device connected.
 - **Channel:** Selects the channel you want to use.
 - Press Menu  and touch **Advanced:** Sets the advanced settings, such as local router IP settings or DHCP server settings.

When the portable Wi-Fi hotspot is active and is ready to share its connection, the hotspot icon  appears on the status bar.

Phone As Modem

You can tether your device to your computer with a USB cable to share your device's Internet connection with your computer.

1. Press Home  > Menu  and touch **System settings > More... > Tethering & portable hotspot.**
2. Select the **Phone as modem** check box to turn on the tethered mode.

When the tethered mode is active, the tethered mode icon  appears on the Notifications panel.

If you want to use your device in tethered mode whenever it is connected to a PC, select Phone as modem in Default connection type of PC connection. See [PC Connection](#).

Camera and Video

You can use the camera or camcorder to take and share pictures and videos. Your device comes with a 3.2 megapixel camera that lets you capture sharp pictures and videos.

Take Pictures

Important: Make sure the microSD card is installed before you use the camera or camcorder. All pictures or videos that you capture using your device are stored on the microSD card. For more information on how to install a microSD card on your device, see [Install a microSD Card](#).

Open the Camera

Follow the instructions below to open the camera in photo mode and take photos.

- ▶ Press Home  and touch  > Camera.

Tip: You can open the camera from the slide lock screen. Flick .

Camera Viewfinder Screen

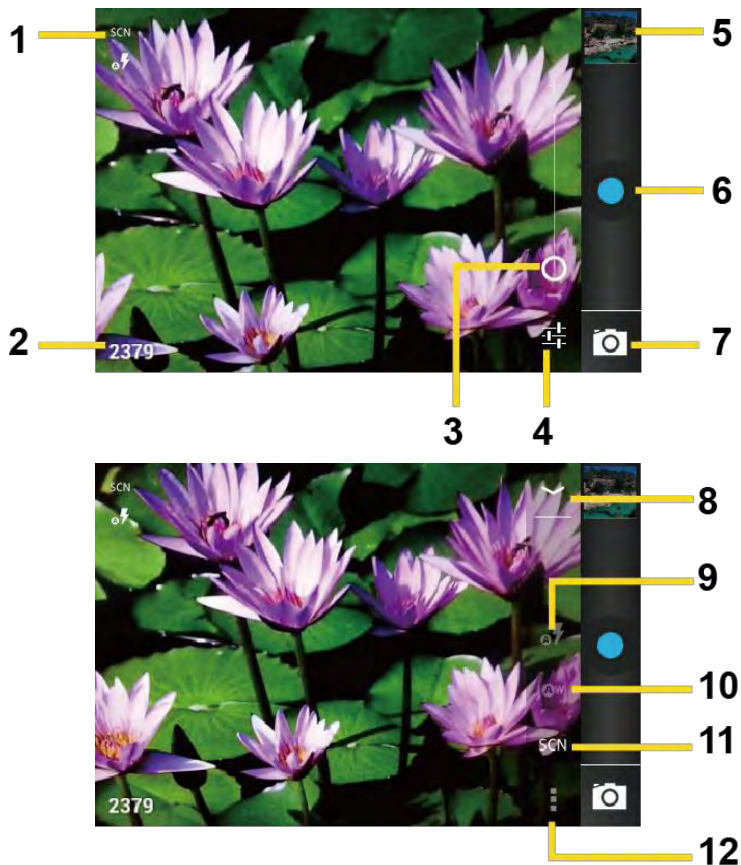

1. **Camera mode icons:** Displays the current camera modes.
2. **Available shot:** Displays the number of shots left available (depending on the capacity of the microSD card).
3. **Zoom slider:** Drag this slider to change the zoom settings. You can also change the zoom settings by pressing the volume button up or down.
4. **Settings button:** Reveals the additional camera mode buttons (8-12).
5. **Thumbnail:** Thumbnail of the latest image you took. Touch to view and manage.
6. **Shutter button:** Touch to take a picture.
7. **Switch button:** Touch to select camera or camcorder.
8. **Close button:** Touch to close the camera mode buttons (9-12) and return to the zoom slider.
9. **Flash mode button:** Touch to select the flash mode.
10. **White balance button:** Touch this button to change the white balance to enable the camera to capture colors more accurately by adjusting to your current lighting.
11. **Scene mode button:** Touch to select a scene mode.

Note: If you select items other than **Auto**, you cannot select **Auto Exposure**, **Flash mode**, and **White balance**.

12. **Camera settings button:** Opens the camera settings menu and lets you change the camera settings. For more information, see [Camera/Video Settings](#).

Review Screen

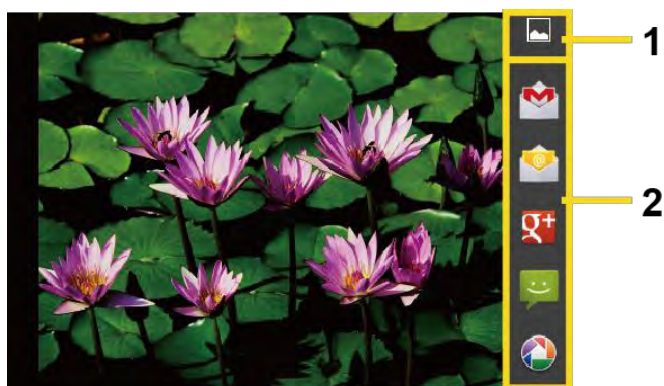

After capturing a photo or video, touch the thumbnail and the review screen is displayed. You can instantly share your photos or videos. See [Share Photos and Videos](#). Touch the Gallery icon to edit your photos or videos. See [View Pictures and Videos Using Gallery](#).



1. **Gallery:** Opens the Gallery application to edit your photos or videos.
2. **Share:** Displays the available applications to share your photos or videos.

Take a Picture

You can take high-resolution pictures using your device's camera.

1. Press Home  and touch  > **Camera**.
2. Change the settings if necessary.
3. Frame your subject on the screen.

Tip: Hold the device vertically when taking portrait shots or hold the device horizontally when taking landscape shots. Then you will not need to rotate the photo after capturing it.

4. Touch  to take the photo.
5. Choose what you want to do with the photo you've just taken. See [Review Screen](#) for details.

Close the Camera

- ▶ On the camera screen, press Home  or Back .

Record Videos

Record high-quality videos (up to WVGA resolution) using your device's video camera.

Video Viewfinder Screen



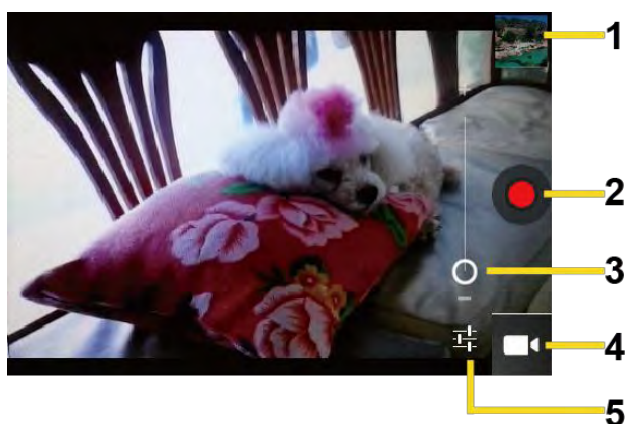

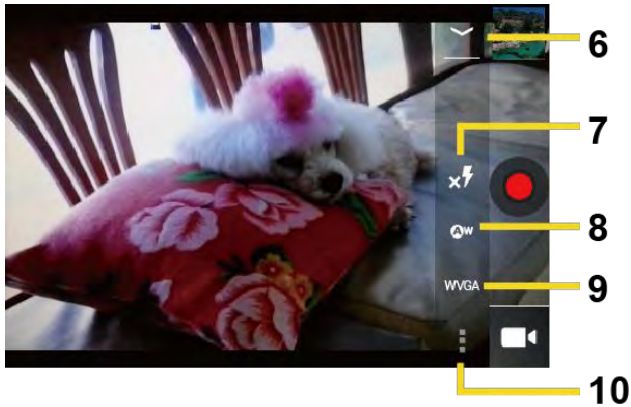
You'll find the following controls on the video viewfinder screen.







1. **Thumbnail:** Thumbnail of the latest image you took. Touch to view and manage.
2. **Recorder button:** Touch to take a video. Touch again to stop.
3. **Zoom slider:** Drag this slider to change the zoom settings. You can also change the zoom settings by pressing the volume button up or down.
4. **Switch button:** Touch to select camera or camcorder.
5. **Settings button:** Reveals the additional video mode buttons (6-10).
6. **Close button:** Touch to close the video mode buttons (7-10) and return to the zoom slider.
7. **Flash mode button:** Touch to select the flash mode.
8. **White balance button:** Touch this button to change the white balance to enable the video to record colors more accurately by adjusting to your current lighting.
9. **Video quality button:** Touch to select a video quality.
10. **Video settings button:** Touch this button to change the video settings. For more information, see [Camera/Video Settings](#).





Record a Video

1. Press Home  and touch  > Camera.
2. Touch  and then touch  to activate camcorder mode.
3. Select **MMS** or **Long video**.
 - **MMS:** Select this option to attach the captured video to your mail. The quality will be automatically set to QCIF (176x144) and the maximum length of a video is 30 seconds.
 - **Long video:** Select this option to capture a long video. The quality can be selected.

4. Frame your subject on the screen.
5. Touch  to start capturing video.
6. Touch  to stop capturing.
7. Choose what you want to do with the video you've just captured. See [Review Screen](#) for details.

Camera/Video Settings

Follow the steps below to change the camera/video settings.

1. Press Home  and touch  > **Camera**.
2. Touch  and then touch  to show the camera/video settings menu.
 - **Store location:** Stores the location information of the picture/video.
 - **Picture size:** Selects from: **3.2M(2048x1536)**, **2.0M(1600x1200)**, **0.8M(1024x768)**, **VGA(640x480)**, or **HVGA(480x320)** (camera only).
 - **Picture quality:** Selects the quality of the pictures from: **Super fine**, **Fine**, or **Normal** (camera only).
 - **Color effect:** Adds a color effect to the picture. Choose from: **None**, **Mono**, **Sepia**, **Negative**, or **Aqua**.
 - **Auto exposure:** Selects the exposure metering range from: **Frame average**, **Center weighted**, or **Spot metering**.
 - **Restore defaults:** Restores all of the camera/video settings to their default values.

View Pictures and Videos Using Gallery

Using the Gallery application, you can view photos and watch videos that you've taken with your device's camera, downloaded, or copied onto your microSD card.

For photos that are on your microSD card, you can do editing. You can also easily make a photo as your contact picture or wallpaper and share photos with your friends.

Open Gallery

The Gallery application opens in the Albums view where your photos and videos organized by albums for easy viewing.

- ▶ Press Home  and touch  > **Gallery**.

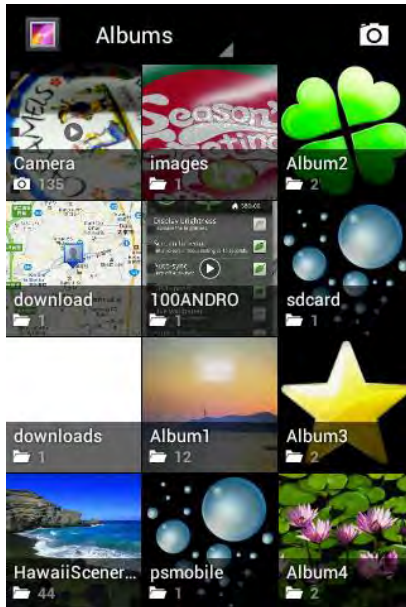

Photos or videos you took with the internal camera are stored in **Camera** album.

Folders in your storage card that contain photos and videos will also be treated as albums and will be listed below **Camera**. The actual folder names will be used as the album names. If you have downloaded any photos and videos, these will be placed in the **download** album.

When viewing pictures in Gallery, scroll left or right the screen to view more albums. Simply touch an album to view the photos or videos in that album.

Note: Depending on the number of pictures stored on the microSD card, it may take some time for Gallery to load all your photos on the screen.

View Photos and Videos

After selecting an album, you can browse through the photos and videos of that album in grid view. Touch a photo or video to view.

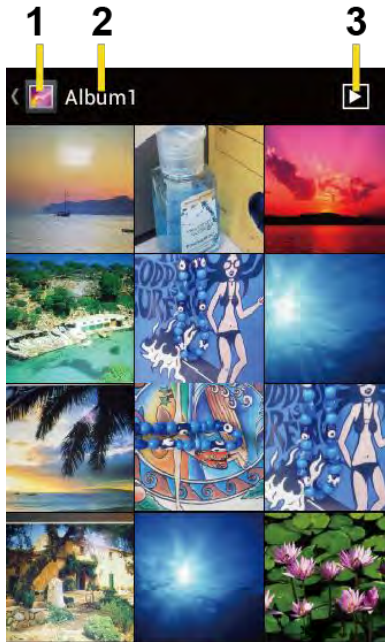

1. Touch to go back to the Gallery screen.
 2. Name of the album.
 3. Touch to show the slideshow of pictures in this album.
- ▶ Press **Menu**  to select pictures or sort pictures.

Zoom In or Out on a Photo

There are two ways you can zoom in or out of a photo.



- ▶ Touch the screen twice quickly to zoom in, then touch the screen twice quickly again to zoom out.

- or -

Pinch the screen using your thumb and forefinger to zoom out or spread the screen to zoom in.

Watch a Video

Use the onscreen controls to play, pause, or stop the video.

- ▶ Touch  to play the video.
- ▶ Touch  to pause the video.

Close Gallery

- ▶ While in the Gallery screen, press Home .

Working with Photos

You can manage your photos or videos.



Photo Options Menu

With the picture displayed, press Menu  to show the following menu.





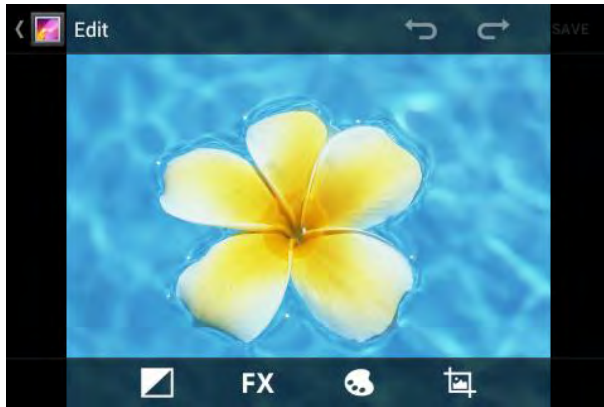

- **Delete:** Deletes the selected picture/video.
- **Slideshow:** Starts the slideshow of the pictures stored.
- **Edit:** Edits the picture. See [Edit a Photo](#).
- **Rotate left/Rotate right:** Rotates the picture.
- **Crop:** Crops the picture. See [Crop a Photo](#).
- **Details:** Shows the details of the picture.
- **Set picture as:** Sets the picture as the contact photo or wallpaper.
- **Show on map:** Shows the location where you took the picture in Google Maps if **Store location** is set to ON. See [Camera/Video Settings](#).

Edit a Photo



Your device has a built in editing tool and you can alter the picture you took easily.

1. Press Home  and touch  > Gallery.
2. Touch an album and then touch a picture.
3. Press Menu  and touch **Edit**.





4. Touch the following icon to edit the picture and scroll left and right to select your favorite effect.
 -  to add exposure effect.
 -  to add artistic effect.
 -  to add color effect.
 -  to add additional effect.
 -  to undo the action.
 -  to redo the action.
5. When finished, touch **SAVE**.

Rotate and Save a Photo

1. Press Home  and touch  > Gallery.
2. Touch an album and then touch a picture.
3. Press Menu  and touch **Rotate left** or **Rotate right**.

Crop a Photo

1. Press Home  and touch  > Gallery.
2. Touch an album, and then touch a picture.
3. Press Menu  and touch **Crop**. A crop box then appears on the photo.

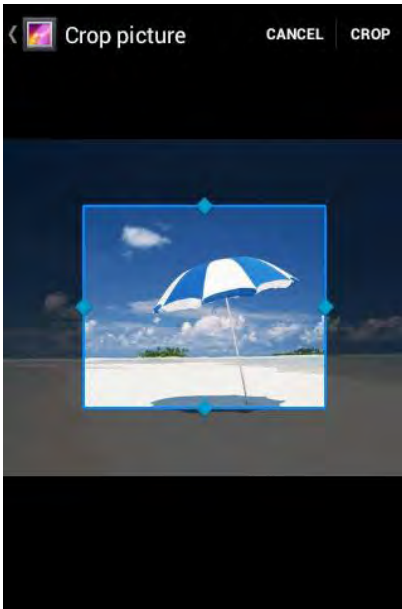

4. To adjust the crop box size, press and hold the edge of the box. When directional arrows appear, drag your finger inward to or outward to resize the crop box.
5. To move the crop box to the part of the photo that you want to crop, drag the crop box to the desired position.
6. Touch **CROP** to apply the changes to the picture.



The cropped picture is saved on the storage card as a copy. The original picture remains unedited.

Share Photos and Videos

The Gallery application lets you send photos and videos using email or multimedia messages. You can share photos on your social networks such as Picasa and share videos on YouTube. You can also send them to another phone or your computer using Bluetooth.

Send Photos or Videos by Email/Gmail

You can send several photos, videos, or both in an email/Gmail message. They are added as file attachments in your email.





1. Press Home  and touch  > **Gallery**.
2. Touch the album that contains the photos or videos you want to share.
3. Press the photo or video until you see a blue frame around it. Touch multiple photos and videos to select them.
4. Touch  > **Gmail** or **Email**. If you cannot find it, touch **See all...**

5. Compose your message and then touch .

Note: If you selected **Email** and you have multiple email accounts, the default email account will be used.



Send Photos or Videos by Multimedia Message

Although you can send several photos or videos in a multimedia message, it may be better to just send one at a time, especially if the files are large in size.

1. Press **Home**  and touch  > **Gallery**.
2. Touch the album that contains the photos or videos you want to share.
3. Press the photo or video until you see a blue frame around it. Touch multiple photos and videos to select them.
4. Touch  > **Messaging**. If you cannot find it, touch **See all...**
5. Compose your message and then touch  ^{MMS}.



Send Photos or Videos Using Bluetooth

You can select several photos, videos, or both and send them to another phone or your computer using Bluetooth.

1. Press **Home**  and touch  > **Gallery**.
2. Touch the album that contains the photos or videos you want to share.
3. Press the photo or video until you see a blue frame around it. Touch multiple photos and videos to select them.
4. Touch  > **Bluetooth**.
5. In the next few steps, you'll be asked to turn on Bluetooth on your device and connect to the receiving Bluetooth device so the files can be sent. For more information, see [Bluetooth](#).

Share Photos or Videos on Google+





You need to be signed in to a Google Account to share photos, videos, or both on Google+.

1. Press **Home**  and touch  > **Gallery**.
2. Touch the album that contains the photos or videos you want to share.

3. Press the photo or video until you see a blue frame around it. Touch multiple photos and videos to select them.
4. Touch  > **Google+**.
5. Follow the instructions on the screen.





Share Photos on Picasa

You need to be signed in to a Google Account to upload pictures to the Picasa™ photo organizing service.

1. Press **Home**  and touch  > **Gallery**.
2. Touch the album that contains the photos you want to share.
3. Press the photo until you see a blue frame around it. Touch multiple photos to select them.
4. Touch  > **Picasa**.
5. Select the online album where you want to upload the pictures, or touch  to create a new album.
6. Touch **Upload**. You can view the photos online at picasaweb.google.com.

Share Videos on YouTube

You can share your videos by uploading them to YouTube™. Before you do this, you must create a YouTube account and sign in to that account on your device.

1. Press **Home**  and touch  > **Gallery**.
2. Touch the album that contains the videos you want to share.
3. Press the video until you see a blue frame around it. Touch multiple videos to select them.
4. Touch  > **YouTube**.
5. Enter the prompted information, such as description and tags, and select a privacy option.
6. Touch .



Tools and Calendar

Calendar

Use Calendar to create and manage events, meetings, and appointments. Your Calendar helps organize your time and reminds you of important events. Depending on your synchronization settings, your device's Calendar stays in sync with your Calendar on the Web, or the corporate calendar.

Add an Event to the Calendar

Add events to your calendar directly from the Calendar application.

1. Press Home  and touch  > **Calendar**.
2. On any Calendar view, press **Menu**  and touch **New event**.
3. If you have more than one calendar, select a calendar in which to add the event.

Note: You can create multiple Google Calendars only in Google Calendar on the Web. After creating them in Google Calendar on the Web, you'll be able to see them in the Calendar application on your device. For more information about creating and managing multiple Google Calendars, visit the Google website: calendar.google.com.

Note: If you have synchronized your device with a corporate account, you can also select these calendars.

4. Enter a name for the event.
5. Enter the event location.
6. To specify the date and time of the event, do one of the following:
 - If there is a time frame for the event, touch the **FROM** and **TO** dates and times to set them.
 - If the event is a special occasion such as a birthday or an all-day event, set the **FROM** and **TO** dates, and then select the **ALL DAY** check box.
7. Select the time zone for the event.
8. Enter email addresses to invite guests to your event and add the event descriptions. See [Invite Guests to Your Calendar Event](#).
9. If the event occurs on a regular basis, touch the **REPETITION** box and then choose how often the event occurs.
10. Set the event reminder time and select how you are notified.

Note: You can add another reminder time in a Google Calendar event. Touch **Add reminder** to add another reminder.

11. Select your status to be displayed on your calendar.
12. Set the privacy status of this event.
13. Touch **DONE**.

Invite Guests to Your Calendar Event

If you want to invite guests to your event, you need to create and add the event in your Calendar using your Google Account or Exchange account.

An email invitation will be sent to your guests from the account used to create the event.

1. Open Calendar and create a new event. Select your Google Account or Exchange account. See [Add an Event to the Calendar](#).
2. Add details about the event, such as date and time, location, and more.
3. In the **GUESTS** field, enter the email addresses of everyone you want to invite to the event. Separate multiple addresses with commas.
4. Add the description of the event to be displayed on the email to your guests.
5. Touch **DONE** to add the event to your Calendar.

If the people to whom you send invitations use Calendar, they'll receive an invitation in Calendar and by email.

Event Alerts

When your device is turned on and you have an event alarm scheduled, your device alerts you and displays the event summary.

There are several ways your device alerts you to scheduled events:

- By playing the assigned ringtone or vibration.
- By showing the  icon on the status bar.
- By showing the Alert pop-up screen.

Event Reminders

If you have set at least one reminder for an event, the upcoming event icon  will appear in the notifications area of the status bar to remind you of the upcoming event.

To view, dismiss, or postpone the reminder:

1. Slide the status bar down to open the Notifications panel.
2. Touch the upcoming event name to display the event.

Note: If you have other pending event reminders, these events will also appear on the screen.

3. Do one of the following:
 - Touch **Snooze all** to postpone all event reminders for five minutes.
 - Touch **Dismiss all** to dismiss all event reminders.
 - Press **Back**  to keep the reminders pending in the notifications area of the status bar.

To set reminder settings:

- ▶ On any Calendar view, press **Menu**  and touch **Settings > General settings**, and set the items under **REMINDER SETTINGS**.

View Calendar Events

You can display the Calendar in daily, weekly, monthly, or agenda view. To change the Calendar view, touch the month and year displayed at the upper left corner, and touch **Day**, **Week**, **Month**, or **Agenda**.

The color of the events indicates the type of calendar that includes the event. To find out what each color represents, press **Menu**  and touch **Calendars to display**.

Day View and Agenda View

Day view displays a list of the events of one day. Agenda view shows a list of all your events in chronological order.

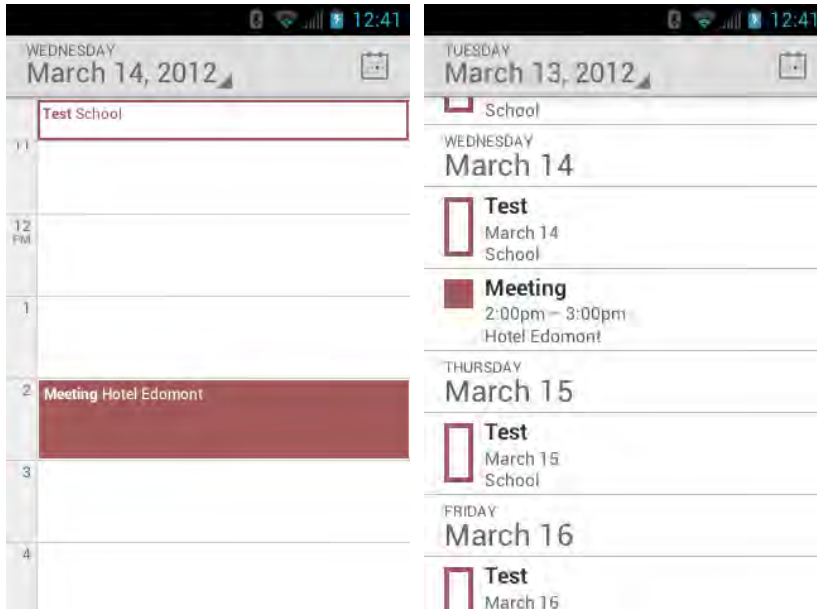

When in Day view, slide left or right across the screen to view earlier or later days.

Week View

Week view displays a chart of the events of one week.



When in Week view:

- You can touch and hold on a time slot to create an event.
- Touch an event to view its details.
- Slide left or right across the screen to view earlier or later weeks.

Month View



In Month view, you'll see markers on days that have events.



When in Month view:

- Touch a day to view the events of that day.
- Slide up or down the screen to view earlier or later months.

Erase Calendar Events

1. Press Home  and touch  > **Calendar**.
2. Open the calendar event details.
 - In **Agenda**, **Day**, and **Week** views, touch the calendar event you want to delete.
 - In **Month** view, touch the date where the calendar event occurs, and touch the calendar event.
3. Touch  > **OK**.

- or -

If the calendar event is recurring, select **Only this event**, **This and future events**, or **All events**, and touch **OK**.



Show or Hide Calendars

- ▶ In any Calendar view, press **Menu**  and touch **Calendars to display**, and then select the check box next to the calendar to display or clear the check box to hide it.

Synchronize Calendars with Your Device

You can choose which Google Calendars to keep synchronized on your device or which ones to stop synchronizing.

Synchronizing a Google Calendar

1. Press **Home**  > **Menu**  and touch **System settings** > **Accounts & sync**.
2. Touch the account you want to sync with.
3. Touch **Sync Calendar**.
4. In any Calendar view, press **Menu**  and touch **Calendars to display** > **Calendars to sync**.
5. Select the calendar to sync and touch **OK**.

Synchronize a Corporate Calendar



If you have set up a corporate account on your device, you can also synchronize corporate calendar events on your device. Calendar events on your corporate account will also show in Calendar if you chose to synchronize with the Exchange ActiveSync Server.

Clock & Alarm

The Clock application functions as a desk clock that shows the date and time. You can also use it to turn your device into an alarm clock.

Opening Clock

The instructions below show how to open the Clock application.

- ▶ Press **Home**  and touch  > **Clock**.





Touch empty space to dim the screen.

The time when the next alarm is set.

Touch icon to set an alarm.

Setting an Alarm

1. Press Home  and touch  > Clock.
2. Touch  on the screen.

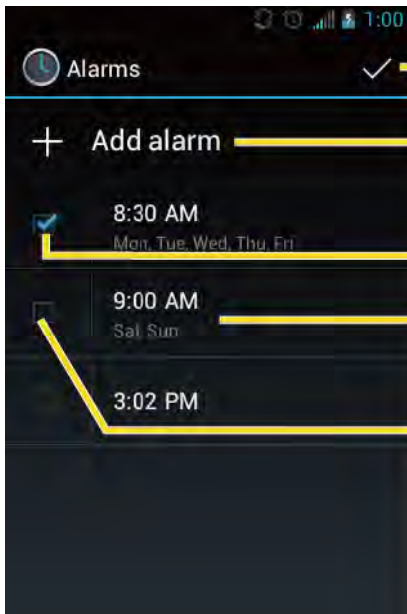

Touch to return to the main Clock screen.

Touch to add an alarm.



Alarm is ON.

Touch to open a screen where you can customize an alarm.



Touch to turn an alarm on or off.

Note: When you first open the alarms, two alarms are set up by default and ready for you to customize. These alarms are turned off by default.





3. Touch an existing alarm to change the settings or touch **Add alarm** to add a new one and set the alarm time.

4. Touch **Time** to adjust the hour and minute, and select AM or PM by touching  or , or sliding each item vertically.
5. Touch **Repeat** to select a repeat status for the alarm.
6. Touch **Ringtone** to select a ringtone that will play as an alarm.
7. Touch **Vibrate** to add a vibration feature to the alarm.
8. Touch **Label** to enter a name for the alarm.
9. Touch **Turn alarm on** to set the alarm on.
10. When you're finished, touch **OK**. (Alarms that are set are selected.)
 - Touch the check mark next to an alarm to turn it on or off.

To delete an Alarm:

1. Press **Home**  and touch  > **Clock**.
2. Touch  on the screen.
3. From the Alarms screen, touch a desired alarm, and then touch **Delete**.
4. Touch **OK** to confirm the deletion.





Changing Alarm Settings

1. Press **Home**  and touch  > **Clock**.
2. Touch  on the screen.
3. From the Alarms screen, press **Menu**  and touch **Settings**.
4. Configure the following options:
 - **Alarm in silent mode:** Select to sound the alarm even while the device is in silent mode.
 - **Alarm volume:** Select to set the alarm volume.
 - **Snooze duration:** Select to set the snooze duration from 5 to 30 minutes in 5-minute intervals.
 - **Auto-silence:** Set how long the alarm sounds.
 - **Volume button behavior:** Selects the behavior of the volume button when pressed while the alarm sounds. Choose from: **None**, **Silence**, **Snooze**, or **Dismiss**.

- **Set default ringtone:** Select to set the ringtone for the alarm.

Calculator

Your device comes with a built-in calculator.



1. Press Home  and touch  > **Calculator**.
2. Enter numbers by touching the onscreen keys.
3. Touch **DELETE** to clear a number. Touch and hold to clear an entire number.
4. To access more advanced features, flick the screen left or press **Menu**  and touch **Advanced panel**.
5. Press **Back**  to close the calculator.

Voice Service

Automatic Speech Recognition (ASR)

You can use your device's built-in automatic speech recognition (ASR) software (Voice Dialer) to dial a phone number in your People or to launch device functions. All you have to do is talk into the device, and ASR will recognize your voice and complete tasks by itself.

Activating the Voice Dialer



- ▶ Press Home  and touch  > **Voice Dialer**.

The device prompts you to say a command from the list displayed on the screen. To complete your task, simply follow the onscreen prompts or touch an onscreen option.



If the application does not recognize the number, name, or application name, it will find the most likely matches and display a list. Touch a selection or touch **Cancel** to exit the Voice Dialer.

Tip: Use ASR in a quiet environment so it can accurately recognize your commands.



Making a Voice Call with the Voice Dialer

1. Press Home  and touch  > **Voice Dialer**.
2. When prompted to speak, say “Call [contact]” or “Dial [number].”
3. For example, say “Call John Smith on mobile,” to call John Smith’s mobile phone. Your device dials the number stored for the contact “John Smith” with the label “Mobile.”

Opening an Application with the Voice Dialer



1. Press Home  and touch  > **Voice Dialer**.
2. When prompted to speak, say “Open [application name].”
 - For example, say “Open Calendar,” to open the Calendar. The application screen is displayed.

Opening a Settings Menu with the Voice Dialer

1. Press Home  and touch  > **Voice Dialer**.
2. When prompted to speak, say “Open [settings menu name].”
3. For example, say “Open sound settings.” The Sound settings menu screen is displayed.

Text-to-Speech Settings

Your device can convert text into speech in some downloaded applications. You may select the language you hear or adjust its speed.

1. Press Home  > Menu  and touch **System settings > Language & input**.
2. Touch **Text-to-speech output**.
3. Select your engine. Touch  to configure the settings of the selected engine.
4. Touch **Speech rate** and select a speed.
5. Touch **Listen to an example** to play a short demonstration of the set speech synthesis.

Voice Search

Voice Search allows you to find information on the web as well as items and information on your device by speaking your search terms.

1. Touch  on the Google Search Bar.



- or -

Press Home  and touch  > **Search > **.

2. Speak clearly into the device’s microphone. If an error occurs, touch **Speak again** or **Try again**.
3. Touch a matching item from the onscreen list.



Voice Search Settings

You can configure the settings of the voice search feature.

1. Press Home  > Menu  and touch **System settings** > **Language & input**.
2. Touch **Voice Search**.
 - **Language** to set the language used when entering text by speaking.
 - **SafeSearch** to filter explicit text and images from the search results. Select from **Off**, **Moderate**, or **Strict**.
 - **Block offensive words** to replace recognized offensive words in transcriptions with [#] when entering text by speaking.

Eco Mode

The Eco Mode allows you to save battery life while using your device.

1. Press Home  and touch  > **Eco Mode**.
2. Drag the onscreen slider to select when you use the Eco Mode.
 - **Never**: Disables the Eco Mode.
 - **10-90%**: Selects the remaining battery power when the Eco Mode activates. For example, 40% means the Eco Mode activates when the remaining battery power reaches 40%.
 - **Always**: Sets your device to always use the Eco Mode.
3. Touch **Eco settings** to select the Eco level.
4. Touch the leaf of the following items to select:
 - **Sleep** to set the screen timeout to 15 seconds.
 - **Display brightness** to decrease the display brightness.
 - **Wallpaper** to select the Eco wallpaper.
 - **Auto-sync** to disable automatic synchronization with applications.
 - **Haptic feedback** to turn off Haptic feedback feature.
 - **Auto-rotate screen** to disable the Auto-rotate screen feature.
5. Touch **Close**.

When Eco Mode is on, the Eco Mode icon  appears on the status bar.





Configured settings in the Eco Mode are automatically reflected in the respective **Settings** menu, and vice versa.

Bluetooth

Bluetooth is a short-range communications technology that allows you to connect wirelessly to a number of Bluetooth devices, such as headsets and hands-free car kits, and Bluetooth-enabled handhelds, computers, printers, and wireless phones. The Bluetooth communication range is usually approximately 30 feet.





Turn Bluetooth On or Off

Turn Bluetooth On

1. Press Home  > Menu  and touch **System settings**.
2. Touch  next to **Bluetooth**.  is displayed and the device will scan for available Bluetooth devices.



Turn Bluetooth Off

Turn off Bluetooth when not in use to conserve battery power, or in places where using a wireless device is prohibited, such as aboard an aircraft and in hospitals.



1. Press Home  > Menu  and touch **System settings**.
2. Touch  next to **Bluetooth** and confirm that  is displayed.

The Bluetooth Menu

Set the Device Visible

1. Press Home  > Menu  and touch **System settings** > **Bluetooth**.
2. Touch your device name at the top of the list to set your device visible to other devices.
 - Touch again to set your device not visible to other device. The duration your device is visible can be changed.

The Bluetooth Settings

1. Press Home  > Menu  and touch **System settings** > **Bluetooth**.
2. Press Menu  and set the following options:
 - **Rename phone** to rename your device. Enter a new name and touch **Rename**.



- **Visibility timeout** to select the time duration your device is visible to other devices.
- **Show received files** to show the files received using the Bluetooth feature.

Pair With a Device

Connect a Bluetooth Headset or Car Kit

You can listen to music over a Bluetooth stereo headset, or have hands-free conversations using a compatible Bluetooth headset or car kit. It's the same procedure to set up stereo audio and hands-free devices.

To listen to music with your headset or car kit, the headset or car kit must support the A2DP Bluetooth profile.



1. Press Home  > Menu  and touch **System settings** > **Bluetooth**.
2. If the **Bluetooth** is not turned on, touch  to turn Bluetooth on.
3. Make sure that the headset is discoverable, so that your device can find the headset. Refer to the instructions that came with the headset to find out how to set it to discoverable mode.
4. Touch **SEARCH FOR DEVICES**. Your device will start to scan for Bluetooth devices within range.
5. When you see the name of your headset displayed in the Bluetooth devices section, touch the name. Your device then automatically tries to pair with the headset.
6. If automatic pairing fails, enter the passcode supplied with your headset.

The pairing and connection status is displayed below the hands-free headset or car kit name in the Bluetooth devices section. When the Bluetooth headset or car kit is connected to your device, the Bluetooth connected icon  is displayed in the status bar. Depending on the type of headset or car kit you have connected, you can then start using the headset or car kit to listen to music or make and receive phone calls.

Note: Due to different specifications and features of other Bluetooth compatible devices, display and operations may be different, and functions such as transfer or exchange may not be possible with all Bluetooth compatible devices.



Reconnect a Headset or Car Kit

When you have paired a headset with your device, you should be able to reconnect it automatically by turning on Bluetooth on your device and then turning on the headset. However, sometimes you will need to reconnect manually, for example if you have been using your headset with another Bluetooth device.



1. Press Home  > Menu  and touch **System settings** > **Bluetooth**.
2. If the **Bluetooth** is not turned on, touch  to turn Bluetooth on.
3. Make sure that the headset is discoverable.
4. Touch the headset's name in the Bluetooth devices section.
5. If prompted to enter a passcode, try 0000 or 1234, or consult the headset or car kit documentation to find the passcode.
6. If you still cannot reconnect to the headset or car kit, follow the instructions in [Disconnect or Unpair From a Bluetooth Device](#), and then follow the instructions in [Pair With a Device](#).
7. Connect a Bluetooth headset or a car kit.

Disconnect or Unpair From a Bluetooth Device

Disconnect a Bluetooth Device

1. Press Home  > Menu  and touch **System settings** > **Bluetooth**.
2. Touch the device to disconnect.
3. Touch **OK**.

Unpair From a Bluetooth Device

1. Press Home  > Menu  and touch **System settings** > **Bluetooth**.
2. Touch  next to the device to unpair.
3. Touch **Unpair**.





Send and Receive Information Using Bluetooth

You can use Bluetooth to transfer information between your device and another Bluetooth-enabled device such as a phone or notebook computer. The first time you transfer information between your device and another device, you need to enter or confirm a security passcode. After that, your device and the other device are paired, and you will not need to exchange passcodes to transfer information in the future.

Send Information From Your Device to Another Device

You can send the following types of information, depending on the device you are sending to.

- Images and videos
- Contacts information

1. Set the receiving device to discoverable mode. You may also need to set it to “Receive Beams” or “Receive Files.” Refer to the device’s documentation for instructions on receiving information over Bluetooth.
2. On the device, open the application that contains the information or file you want to send. For example, if you want to send a photo, press **Home**  and touch  > **Gallery**.
3. Follow the steps for the type of item you want to send:
 - Photo or video (in Camera): After capturing a photo, on the preview screen, touch .
 - Photos and videos (in Gallery): On the Albums tab, touch an album, and select the items you want to share. Touch , and then touch **Bluetooth**.
 - Contacts information: Touch the entry, and then press **Menu**  and touch **Share** > **Bluetooth**.
4. If you are prompted to turn on Bluetooth, touch **Turn on**.
5. Touch the name of the receiving device.
6. If prompted, accept the connection on the receiving device, and enter the same passcode on both your device and the other device, or confirm the auto-generated passcode.
7. On the receiving device, accept the file.



The location where the information is saved depends on the type of information and the receiving device:

- If you send a contact, it is normally added directly to the contact application on the receiving device.
- If you send another file type to a Windows computer, it is normally saved in the Bluetooth Exchange folder within your personal document folders.
 - On Windows XP, the path may be: C:\Documents and Settings\[your username]\My Documents\Bluetooth Exchange.
 - On Windows Vista, the path may be: C:\Users\[your username]\Documents.
- If you send a file to another device, the saved location may depend on the file type. For example, if you send an image file to another wireless phone, it may be saved in a folder named “Images.”

Receive Information From Another Device

Your device is capable of receiving a wide variety of file types with Bluetooth, including photos, videos, or contacts.

To receive files from another device, you need to have a microSD card installed in your device.

1. Press Home  > Menu  and touch **System settings** > **Bluetooth**.
2. If the Bluetooth is not turned on, touch **OFF** to turn Bluetooth on.
3. Touch your device name to set it visible from other devices.
4. Press Menu  and touch **Visibility timeout**.
5. Select the time duration your device is visible to others.
6. On the sending device, send one or more files to your device. Refer to the device's documentation for instructions on sending information over Bluetooth.
7. If prompted, enter the same passcode on both your device and the other device, or confirm the auto-generated passcode. A Bluetooth authorization request is displayed on your device.
8. Touch **OK**.
9. When your device receives a file transfer request notification, slide down the Notifications panel, and then touch **Accept**.
10. When a file is transferred, a notification is displayed. To open the file immediately, slide down the Notifications panel, and then touch the relevant notification.

When you open a received file, what happens next depends on the file type:

- For a vCard contact file, if there are multiple vCard files on your storage card, you can choose to import one, several, or all of those contacts to your People list.

microSD Card

Your device is equipped with a microSD™ (Secure Digital) memory card that allows you to store images, videos, music, documents, and voice data on your device.

Important: Your device comes with the microSD card preinstalled.

Warning: Do not handle a damaged or leaking Li-Ion battery as you can be burned.

Remove the microSD Card

1. Unmount the SDcard. See [Unmount and Mount the microSD Card](#).

2. Remove the battery cover following steps 1-2 in *Install the Battery*.
3. Grasp the white pull-tab extending from the battery pack and pull the battery out of its compartment.
4. Slide the SD card holder in the direction of the arrow to unlock it (①).
5. Raise the card and the card holder with your fingers (②).
6. Gently pull out the card from the holder (③).

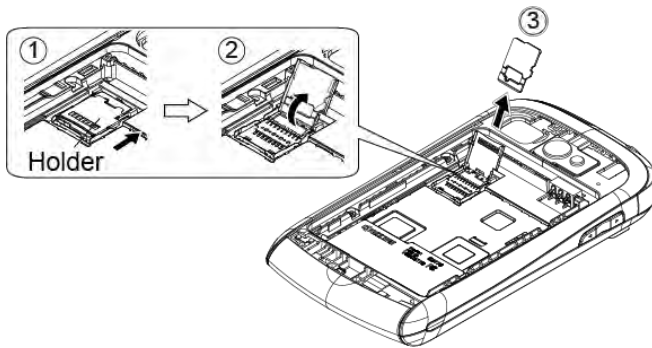

7. Replace the card holder and gently press them, and then slide the holder in the direction of the arrow to lock it (④ to ⑥).

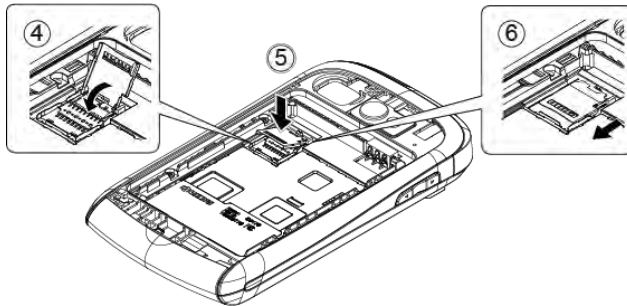

8. Place the battery back into its compartment and replace the battery cover. See steps 3-5 in *Install the Battery*.

Note: You can easily damage the microSD card by improper operation. Please be careful when inserting, removing, or handling the microSD card.

Note: Make sure your battery is fully charged before using the microSD card. Your data may become damaged or unusable if the battery runs out while using the microSD card.

Install a microSD Card

1. Remove the battery cover following steps 1-2 in *Install the Battery*.
2. Slide the SD card holder in the direction of the arrow to unlock it (①).

3. Raise the card holder with your fingers (2).
4. Insert a microSD card into the holder. Make sure to check the position of the gold terminals (3).

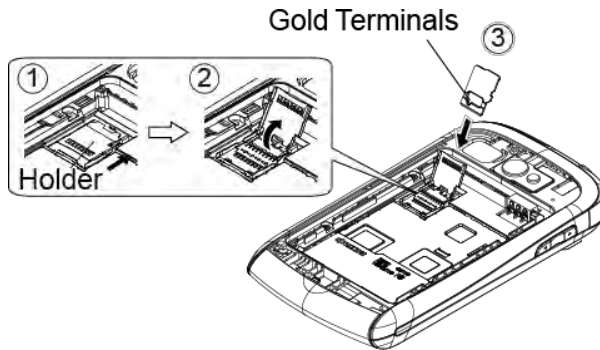

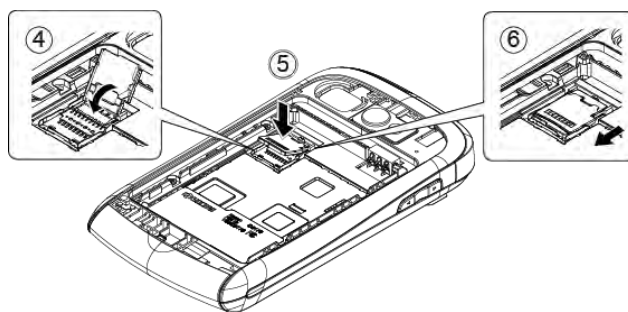

5. Replace the card and the card holder and gently press them, and then slide the holder in the direction of the arrow to lock it (4 to 6).





6. Place the battery back into its compartment and replace the battery cover. See steps 3-5 in [Install the Battery](#).

View the microSD Card Memory

1. With the microSD card inserted, press Home  > Menu  and touch System settings > Apps.
2. Touch the ON SD CARD tab. The total and available memory space will be displayed at the bottom of the screen.

Format the microSD Card



1. Press Home  > Menu  and touch System settings > Storage.
2. Scroll down the screen, touch Erase SD card > Erase SD card > Erase everything.

Note: The formatting procedure erases all the data on the microSD card, after which the files CANNOT be retrieved. To prevent the loss of important data, please check the contents before you format the card.



Unmount and Mount the microSD Card

You need to unmount the microSD card first before removing it to prevent corrupting the data stored on it or damaging the microSD card. Also, you need to mount the microSD card for using it.

To unmount the microSD card:

1. Press Home  > Menu  and touch **System settings** > **Storage**.
2. Touch **Unmount SD card** > **OK**.

To mount the microSD card:

- ▶ Press Home  > Menu  and touch **System settings** > **Storage** > **Mount SD card**.

Use the Device's microSD Card as a USB Drive

To transfer music, pictures, and other files from your computer to your device's microSD card, you need to set the device's microSD card as a USB drive.

1. Connect the device to your computer using the supplied USB cable.
2. If you see  on the status bar, slide it down to open the Notifications panel and touch the USB connection notification.
3. Touch **Mass Storage** > **Done** > **OK**. See [PC Connection](#).
4. On your computer, the connected device is recognized as a removable disk. Navigate to this removable disk and open it.
5. Do one of the following:
 - Copy files from the computer to the root folder on the device's storage card.
 - Copy files from the device's storage card to a folder on your computer or computer desktop.
6. After copying the files, unmount the removable disk (that is, the connected device) as required by your computer's operating system to safely remove your device, and disconnect the device from the computer.

Note: The device will not recognize the microSD card when it is connected to a computer as a disk drive. You will not be able to use some of the device's applications such as the Camera or Play Music.

Use the Device's microSD Card as a Media Device

You can connect your device as a media device to your computer.

1. Connect the device to your computer using the supplied USB cable.
2. If you see  on the status bar, slide it down to open the Notifications panel and touch the USB connection notification.
3. Touch **Media Transfer** > **Done**. See [PC Connection](#).

Settings

Wireless & Networks Settings

Wi-Fi

You can enjoy the advantage of Wi-Fi hotspots for high-speed data access using available computer networks. For details on your device's Wi-Fi features and settings, see [Wi-Fi](#).

Bluetooth



The Bluetooth wireless technology enables wireless connectivity with accessories such as portable or installed hands-free car kits, phones, handsets, computers, and so on. For details on your device's Bluetooth settings, see [Bluetooth](#).

Data Usage

You can see the amount of data uploaded and downloaded by your device during a specific period of time.



Enable Data Statistics

Enabling the Data statistics feature allows your device to collect the necessary data.

1. Press Home  > Menu  and touch **System settings** > **Data usage**.
2. Touch **Data statistics** if **OFF** is displayed next to it.
3. Read the message and touch **OK**. **ON** will be displayed.

View Data Usage by Application



You can view the amount of the data usage for specific period of time.

1. Press Home  > Menu  and touch **System settings** > **Data usage**.
2. Confirm **Mobile data** is set to **ON**.
3. Touch  next to **Data usage cycle** to change the period of time for which the chart will display the data usage.
4. Touch either of the white lines on the chart to display the tabs. Drag the white tabs horizontally to see the data usage of a specific period within the displayed cycle.
 - The usage amount will be displayed just below the chart.



Set Data Usage Limit

You can also set the limit for mobile data in case you don't have unlimited data plan which cuts off data at a specified threshold.

Warning: The usage displayed is measured by your device. Your carrier's data usage accounting may differ and the usage in excess of your data limit plan can result in charges. Data usage limit set in this menu is not guaranteed to prevent additional charges.

1. Press Home  > Menu  and touch **System settings** > **Data usage**.
2. Select the **Set mobile data limit** check box. Read the message and touch **OK**.
3. Drag the red tab vertically to set the limit you want.



- or -

Touch the red line, select the limit by touching  or , or sliding each item vertically and then touch **Set**.

- When your data usage reaches the limit, mobile data will be turned off automatically.

4. Drag the orange tab vertically to set the level you receive warning.



- or -

Touch the orange line, select the limit by touching  or , or sliding each item vertically and then touch **Set**.

- When your data usage reaches the level set with the orange line, you will see the message.

Restrict Data Usage by Application

You can restrict the background data usage.

1. Press Home  > Menu  and touch **System settings** > **Data usage**.
2. Press Menu  and select the **Restrict background data** check box.
3. Read the message and touch **OK**.

Tip: You can see the Wi-Fi usage. Press Menu  and select the **Show Wi-Fi usage** check box.

Airplane Mode

Airplane mode allows you to use many of your device's features, such as Gallery, Camera, and Music, when you are on an airplane or in any other area where making or receiving calls or data is prohibited. When you set your device to Airplane mode, it cannot send or receive any calls or access online information. While in Airplane mode, the status bar will display .

To quickly turn Airplane mode on or off:

- ▶ Press and hold the **Power** button and touch **Airplane mode**.

To turn Airplane mode on or off in Settings:

1. Press Home  > Menu  and touch **System settings > More...**
2. Select the **Airplane mode** check box.



Tethering & Portable Hotspot

The portable Wi-Fi hotspot turns your device into a wireless router and shares your device's data connection with one or more computers or mobile devices using Wi-Fi. For details on your device's tethering and portable hotspot settings, see [Portable Wi-Fi Hotspot](#).

Mobile Networks

Mobile networks menu lets you enjoy the data connection.

Enable Data

1. Press Home  > Menu  and touch **System settings > More... > Mobile networks**.
2. Select the **Data enabled** check box.

Roaming

Roaming is the ability to make or receive calls and access data services when you're off the Cricket network.

Roaming Icon

Your display screen always lets you know when you're off the Cricket network. Anytime you are roaming, the device displays the roaming icon ()

Roaming on Other Networks

When you're roaming on other networks, your call quality and security will be similar to the quality you receive when making calls on the Cricket network. However, you may not be able to access certain features, such as data services, depending on the available network.

Note: If you're on a call when you leave the Cricket network, your call is dropped. If your call is dropped in an area where you think Cricket service is available, turn your device off and on again to reconnect to the network.

Check for Voicemail Messages While Roaming

When you are roaming off the Cricket network, you may not receive on-phone notification of new voicemail messages. Callers can still leave messages, but you will need to periodically check your voicemail for new messages if you are in a roaming service area for an extended period of time.

1. Dial your area code + your phone number.
2. When you hear your voicemail greeting, touch .
3. Enter your password at the prompt and follow the voice prompts.

When you return to the Cricket network, voicemail notification will resume as normal.

Data Roaming



To use the data service while roaming:

1. Press Home  > Menu  and touch **System settings**.
2. Touch **More...** > **Mobile networks** > **Data roaming** > **OK**.

Roaming Settings



You can determine which signals your device accepts. Choose from different settings on your device to control your roaming experience.

To set the roaming mode:

1. Press Home  > Menu  and touch **System settings**.
2. Touch **More...** > **Mobile networks** > **System select**.
3. Select an option:
 - **Home only** to access only the Cricket network and prevent roaming on other networks for both voice and data communications.
 - **Automatic** to seek service on the Cricket network. When Cricket service is unavailable, the device searches for an alternate service. If you select this option, select the type(s) of communication for which roaming should be allowed.



Roaming Guards

Your device alerts you when you are roaming off the Cricket network by requiring an extra step before you can place or answer a call, or try to access data while roaming.

1. Press Home  > Menu  and touch **System settings**.
2. Touch **More...** > **Mobile networks** > **Roaming guards**.
3. Check the service you want to enable Roaming guards for:
 - **Voice** to display a prompt that will require you to respond anytime you attempt to access voice service while roaming.
 - **Data** to display a prompt that will require you to respond anytime you attempt to access data service while roaming. The prompt will not appear again while you are in the data session you allowed.

Tip: If you prefer not to use the Roaming guards feature, touch the **Never ask** check box and then touch **Roam** while the alert dialog is displayed. You will not be notified of your roaming status until you enable Roaming guards again.

To place roaming calls with Roaming guards on:

1. Press Home  and touch .
2. Enter the area code + the seven-digit number and touch .
3. Read the message and touch **OK**.

To answer roaming calls with Roaming guards on:

- ▶ Read the message and touch **OK**.

To access data services while roaming with Roaming guards on:

- ▶ Read the message and touch **Roam**.



To send a text message while roaming with Roaming guards on:

- ▶ Read the message and touch **Send now**.
 - Touch **Save as draft** to save the message as draft and send it later.

Device Settings

Sound



Volumes

1. Press Home  > Menu  and touch **System settings** > **Sound** > **Volumes**.
2. Drag the onscreen slider to adjust the volume level of **Music, video, games, & other media, Ringtone & notifications, or Alarms**.
3. Touch **OK**.

Tip: You can adjust the ringtone volume in standby mode (or the earpiece volume during a call) by using the volume button on the left side of your device.

Silent Mode



The Silent mode option allows you to mute all sounds or vibrate (except for media and alarm sounds).

1. Press Home  > Menu  and touch **System settings** > **Sound** > **Silent mode**.
2. Select an option:
 - **Off** to disable the silent mode.
 - **Vibrate** to mute all sounds but vibrate. You can select the vibrate pattern. See [Vibrate Pattern](#).
 - **Mute** to mute all sounds.

Tip: Press the volume button down in standby mode until you see  or  on the screen.

Phone Ringtone



You can select and assign ringtones for your incoming calls.

1. Press Home  > Menu  and touch **System settings** > **Sound** > **Phone ringtone**.
2. Touch a ringtone from the available list. The ringtone briefly plays when selected.
3. Touch **OK** to assign a ringtone.

Tip: You can assign individual ringtones to the entries in People. See [Assign a Ringtone to an Entry](#).

Vibrate Pattern



You can select the vibrate pattern.

1. Press Home  > Menu  and touch **System settings** > **Sound** > **Vibrate pattern**.
2. Touch a vibrate pattern from the available list. Your device briefly vibrates when selected.

3. Touch **OK** to assign a vibrate pattern.

Default Notification

Use the settings menus to assign specific ringtones for notifications.



1. Press **Home**  > **Menu**  and touch **System settings** > **Sound** > **Default notification**.
2. Touch a notification sound from the available list. The sound briefly plays when selected.
3. Touch **OK** to assign a notification sound.

Vibrate and Ring

- ▶ Select the **Vibrate and ring** check box to let your device ring and vibrate simultaneously.

Persistent Alerts

This menu lets you set alerts, such as beep, vibration, or LED blinking for notification.

1. Press **Home**  > **Menu**  and touch **System settings** > **Sound** > **Persistent alerts**.
2. Select the following:
 - **Audible tone** to beep when notification is on the notification bar.
 - **Vibrate** to vibrate when notification is on the notification bar.
 - **Blink LED** to blink the LED indicator when notification is on the notification bar.
3. If you see a message, touch **OK**.
4. Touch **OK**.

System



The System settings menu lets you select whether you hear tones when touching numbers on the dialpad, selecting onscreen options, and more.

- **Dial pad touch tones:** Select to play tones when using the dialpad.
- **Touch sounds:** Select to play sounds when making an onscreen selection.
- **Screen lock sound:** Select to play sounds when locking or unlocking the screen.
- **Vibrate on touch:** Select to vibrate when touching softkeys and during certain other instances.

- **Hearing aid:** Select to use your hearing aid device effectively.

Display

Brightness



1. Press Home  > Menu  and touch **System settings > Display > Brightness**.
2. Drag the Brightness slider left or right to adjust the screen brightness.

- or -

Select the **Automatic brightness** check box to set the brightness automatically.

3. Touch **OK**.



Wallpaper

1. Press Home  > Menu  and touch **System settings > Display > Wallpaper**.
2. Select the wallpaper you want to display on the screen.

Auto-Rotate Screen



Your device is capable of automatically changing the orientation of some onscreen content. With this feature, you can view the screen in either portrait or landscape orientation by turning the device sideways. By default, the screen orientation automatically changes when the device is rotated.

To deactivate the Auto-rotate feature:



1. Press Home  > Menu  and touch **System settings > Display**.
2. Clear the **Auto-rotate screen** check box.

Sleep

Select the delay time before the screen automatically turns off.



1. Press Home  > Menu  and touch **System settings > Display > Sleep**.
2. Select a delay time.

Font Size

1. Press Home  > Menu  and touch **System settings > Display > Font size**.
2. Select a font size.

Key Backlight



Select the delay time before the key backlight automatically turns off.

1. Press Home  > Menu  and touch **System settings** > **Display** > **Key backlight**.
2. Select a delay time.

Screen Proximity Safety



Set the distance between your device and your face that triggers your device's proximity sensor to work.

Note: If you disable the proximity sensor, it may cause accidental key presses during a call.

1. Press Home  > Menu  and touch **System settings** > **Display** > **Screen proximity safety**.
2. Drag the slider left or right to adjust the distance from your face and touch **OK**.



Storage

The Storage settings menu lets you see the available space of the internal storage and the SD card on your device and provides options for your microSD card. For SD card options, see [microSD Card](#).

- ▶ Press Home  > Menu  and touch **System settings** > **Storage**.



Battery

The battery menu lets you see the current battery status and which applications have been using the battery.

1. Press Home  > Menu  and touch **System settings** > **Battery**.
2. Touch "... on battery" to see the history details of the battery usage.

PC Connection

Set your device's default connection mode when connected to the USB port of a computer.



1. Press Home  > Menu  and touch **System settings** > **PC connection**.
2. Touch **Default connection type** and select an option:
 - **Charge Only:** Let your PC charge your device only.
 - **Mass Storage:** Let your device function as a removable disk when connected to the USB port of a computer.

- **Media Transfer:** Let your device function as a media device when connected to the USB port of a computer.
 - **Phone as Modem:** Let your device function as a modem when connected to the USB port of a computer.
3. Select the **Ask me** check box if you want to display the selection screen whenever you connect your device to a computer.

If **Ask me** is selected, the selection screen is displayed whenever you connect your device to a computer. If you want this selection set as default, select the **Remember this choice** check box and touch **Done** on the selection screen.

Apps

This menu lets you view applications on your device.

1. Press Home  > Menu  and touch **System settings** > **Apps**.
2. Touch one of the following tabs to select the applications to be displayed:
 - **DOWNLOADED:** Select to display downloaded application. You can also see the storage status on your device at the bottom of the screen.
 - **ON SD CARD:** Select to display applications stored on the microSD card. You can also see the storage status on your SD card at the bottom of the screen.
 - **RUNNING:** Select to display currently running applications. You can also see the RAM status on your device at the bottom of the screen. Touch **SHOW CACHED PROCESSES** to see the cached process of the application.
 - **ALL:** Select to display all applications stored on your device and SD card.



Personal Settings

Accounts & Sync

The Accounts & sync settings menu lets you add and manage your accounts and synchronize the calendar or People on your device.

Add Account

You can add additional account to your device.



1. Press Home  > Menu  and touch **System settings** > **Accounts & sync** > **ADD ACCOUNT**.
2. Touch an account type.

- Corporate, Google, etc.
3. Follow the instructions on the screen to add your additional account.
 - Depending on the account type, you may need to enter an email address or user address, password, domain name, or other information. For Corporate accounts, contact your server administrator to determine what information you will need.

General Sync Settings

Let applications synchronize data in the background, whether or not you are actively working in them.

As default your Google Accounts are automatically synced.

1. Press Home  > Menu  and touch **System settings** > **Accounts & sync**.
2. If you see  at the upper right corner, your accounts will automatically sync. Touch the account with the data you want to sync.
3. Touch the types of data you wish to synchronize automatically. (A check mark indicates the feature is enabled.)

Note: If you do not want to sync your Google Account automatically, touch  at the upper right corner and confirm  is displayed.



Note: If you want to remove the account, press **Menu**  and touch **Remove account**.

Location Services

Your device is equipped with a Location feature for use in connection with location-based services. The Location services menu allows the network to detect your position. Turning Location services off will hide your location from everyone except **911**.

Google's Location Service

This service uses Wi-Fi and/or mobile networks to detect your location.

1. Press Home  > Menu  and touch **System settings** > **Location services**.
2. Select the **Google's location service** check box.
3. Read the disclaimer and touch **Agree**.

GPS Satellites



This service uses available GPS to pinpoint your location within certain applications such as Google Maps.

1. Press Home  > Menu  and touch **System settings** > **Location services**.

2. Select the **GPS satellites** check box.

Location & Google Search

This service lets Google use your location to improve search results and other services.

1. Press Home  > Menu  and touch **System settings** > **Location services**.
2. Select the **Location & Google search** check box.
3. Read the disclaimer and touch **Agree**.

Security

The Security settings menus let you set device security, lock codes, passwords, administrator settings, and more.



Screen Lock

You can choose the way how your device acts when the device's display screen is turned on. As default, you must flick the lock button on the screen. See [Turn the Screen On and Unlock It](#).

The security of your device can be increased by drawing the correct pattern on the screen, entering the correct PIN, or entering the correct password to unlock the device's control keys, buttons, and touchscreen.

If you fail to enter the correct pattern, PIN or password after five attempts, you will have to wait for 30 seconds before you can try again.

To use a pattern:

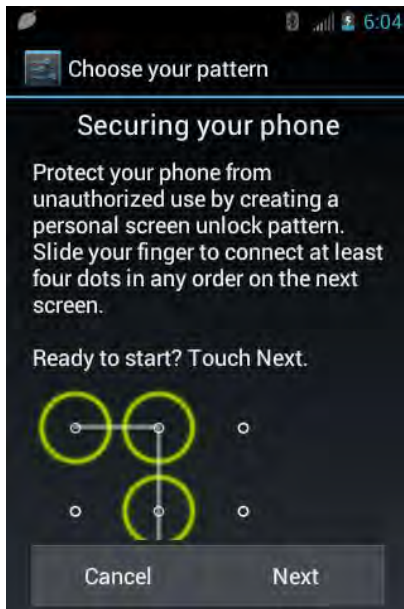

1. Press Home  > Menu  and touch **System settings** > **Security** > **Screen lock**.
2. Touch **Pattern**.





3. Read the information and study the example pattern on the screen and touch **Next**.
4. Draw the screen unlock pattern by connecting at least four dots in a vertical, horizontal, or diagonal direction. Lift your finger from the screen when finished. The device records the pattern.
5. Touch **Continue**.
6. When prompted, draw the screen unlock pattern again, and then touch **Confirm**.

Note: Clear the **Make pattern visible** check box if you do not want the pattern to be displayed on the screen when you draw it.

To use a PIN:

1. Press Home  > Menu  and touch **System settings** > **Security** > **Screen lock**.
2. Touch **PIN**.
3. Enter a PIN and touch **Continue**.
4. Enter your PIN again and touch **OK** to confirm it.

To use a password:

1. Press Home  > Menu  and touch **System settings** > **Security** > **Screen lock**.
2. Touch **Password**.
3. Enter a password and touch **Continue**.
4. Enter your password again and touch **OK** to confirm it.



Note: Select the **Vibrate on touch** check box if you want the device to vibrate when you draw the pattern or enter the PIN.

Note: Touch **Automatically lock** to select the time duration before the screen lock feature activates.

Note: Select **Power button instantly locks** to activate the screen lock feature by pressing the **Power** button.

Note: Touch **Owner info** to enter your information to be displayed on the lock screen.

To change or disable the screen lock:

1. Press Home  > Menu  and touch **System settings** > **Security** > **Screen lock**.
2. Draw your unlock screen pattern, or enter your PIN or password and touch **Next**.
3. Touch **None** to disable the screen lock or change the unlock mode.

- or -



Touch **Slide** to return to the default slide lock.

Encrypt Data

You can encrypt your device and the SD card installed in your device. For both encryption and decryption, you need a PIN or password for the screen lock. (See [Screen Lock](#) to set a PIN or password.) You cannot use other features including making or receiving phone calls during encryption.

Warning: To unencrypt your device, you need to reset your device to the original factory settings, which erases all data from the device's application storage.

Warning: To unencrypt your SD card, you need to format the card, which permanently removes all files stored on the card.

1. Charge the battery enough and connect the device to an electrical outlet.
2. Press Home  > Menu  and touch **System settings** > **Security** > **Encrypt data**.
3. Select an option:
 - **Phone & SD card** to encrypt your device and the SD card installed in your device.
 - **Phone** to encrypt your device only.
 - **SD card** to encrypt the installed SD card only.
4. Read the message and touch **Next**.
5. Enter the PIN or password for the screen lock and touch **Next**.

6. Read the message and touch **Encrypt**.

Warning: Do not remove the battery or the SD card during encryption. If you interrupt the encryption process, you will lose some or all of your data.



Passwords

You can hide your password or PIN number as you type it.

1. Press Home  > Menu  and touch **System settings** > **Security**.
2. Clear the **Make passwords visible** check box.



Device Administration

You can disable the authority to be a device administrator of certain applications. If disabled, you will typically lose some functionality in those applications, such as the ability to sync new email or calendar events to your device.

1. Press Home  > Menu  and touch **System settings** > **Security** > **Device administrators**.
2. Touch an application you want to disable the authority to be a device administrator.



Unknown Sources

Follow the steps below to install non-Google Play store applications.



1. Press Home  > Menu  and touch **System settings** > **Security**.
2. Select the **Unknown sources** check box and touch **OK**.

Credential Storage



You can see the trusted credentials on your device's system.

1. Press Home  > Menu  and touch **System settings** > **Security** > **Trusted credentials**.
2. Touch an item to read the information.

You can install encrypted certificates from the SD card.

1. Press Home  > Menu  and touch **System settings** > **Security** > **Install from SD card**.
2. Touch an available certificate.
3. Follow the onscreen instructions.

You can remove all the credentials on your device.

1. Press Home  > Menu  and touch **System settings** > **Security** > **Clear credentials**.
2. Touch **OK**.



Language & Input

Your device's Language & input settings let you select a language for the device's screens and menus, as well as manage a personal user dictionary. The Keyboard settings let you select a preferred input method, control keyboard settings, and more. For details, see [Text Entry](#).

This menu also provides the settings when using voice function. See [Text-to-Speech Settings](#) and [Voice Search](#).

Language



You can choose to display your phone's onscreen menus in English or in Spanish.

1. Press Home  > Menu  and touch **System settings** > **Language & input** > **Language**.
2. Touch **English** or **Español**.

Backup & Reset



Back up My Data

You can back up your settings to a Google server.

1. Press Home  > Menu  and touch **System settings** > **Backup & reset**.
2. Select the **Back up my data** check box to enable the feature.

Backup Account

Specify an account to back up your settings to.



1. Press Home  > Menu  and touch **System settings** > **Backup & reset**.
2. Touch **Backup account**.
3. Select an account from the displayed list.

- or -

Touch **Add account** and follow the onscreen instructions.

Automatic Restore

Enable this option to restore your settings and other data when you install an application.



1. Press Home  > Menu  and touch **System settings** > **Backup & reset**.
2. Select the **Automatic restore** check box.

Factory Data Reset

Your device's Backup & reset menu includes the **Factory data reset** option. This option lets you reset your device to the original factory settings, which erases all data from the device's application storage, including the following options.

- Your Google Account
- All other email and social networking accounts
- System and application data and settings
- Downloaded applications





To reset your device



1. Press Home  > Menu  and touch **System settings** > **Backup & reset**.
2. Touch **Factory data reset** and read the Factory data reset information.
3. Touch **Reset phone**.
4. Touch **Erase everything**. Your device will power down and reset itself, which may take up to 10 minutes.

System Settings

Date & Time

Your device obtains its time and date information by using the network-provided date, time, and time zone. These values can be changed manually.

1. Press Home  > Menu  and touch **System settings** > **Date & time**.
2. Clear the **Automatic date & time** check box if necessary.
3. Clear the **Automatic time zone** check box if necessary.
4. Touch **Set date** and adjust the date, month, and year by touching  or , or sliding each item vertically. Touch **Set** when finished.

5. Touch **Set time** and adjust the hour and minute, and select **AM** or **PM** by touching  or , or sliding each item vertically. Touch **Set** when finished.
6. Touch **Select time zone**, and then select a time zone from the onscreen list. Scroll down the list to view additional time zones.
7. Touch **Use 24-hour format** to toggle between 12-hour or 24-hour format.
8. Touch **Select date format** to select how the date information is displayed on your device.



Accessibility

You can download and manage accessibility-related applications or configure the accessibility setting of your device.

Note: You can also enable your TTY (teletypewriter, also known as a TDD or Text Telephone) settings. See [TTY Mode](#).





Services

This menu provides you with the list of accessibility-related applications. Touch the application and configure its settings.

1. Press Home  > Menu  and touch **System settings** > **Accessibility**.
2. Touch the application to configure its settings.



TalkBack

TalkBack provides spoken feedback to help visually impaired users.

1. Press Home  > Menu  and touch **System settings** > **Accessibility** > **TalkBack**.
2. To turn it on, touch , read the message and then touch **OK**.  is displayed.
3. Touch **SETTINGS** to configure its settings.

System

This menu configures the accessibility settings of the system in your device.

1. Press Home  > Menu  and touch **System settings** > **Accessibility**.
2. Configure the following system accessibility settings:
 - **Large text** to use large fonts on the screen.
 - **Power button ends call** to use the **Power** button to end a call.

- **Auto-rotate screen** to automatically change the orientation of some onscreen content when the device is rotated.
- **Speak passwords** to let your device speak the password you enter.
- **Explore by touch** to let your device speak or write the descriptions of what's under your finger (when **TalkBack** is turned on).
- **Touch & hold delay** to set the delay time when the screen recognizes the touch and hold operation.
- **Install web scripts** to install web scripts that make the web content more accessible.

Developer Options

These menus are specific for application development. Unless you have a specific reason for changing these settings, you should leave them at the default settings.

About Phone

The About phone menu lets you access important phone information including your phone number, and view legal information.

System Update

From time to time, updates may become available for your device. You can download and apply updates through the System update menu.



Update Kyocera Software

This option provides you the latest Android Operating System (OS) and the device firmware on your device via an over-the-air connection.

Before Updating Your Firmware:



Updating your device firmware may erase all user data from your device. You must back up all critical information before updating your device firmware.

To back up your account information:



1. Press **Home**  > **Menu**  and touch **System settings** > **Accounts & sync**.
2. Touch the account containing data you want to back up now.
3. Press **Menu**  and touch **Sync now**.

As an added precaution, to preserve any data on your microSD card, please remove it from your device prior to starting the update process.

To update Kyocera Firmware:



1. Press Home  > Menu  and touch **System settings > System updates > Update Kyocera software.**
2. Follow the onscreen instructions.

Confirm Your Current Device Firmware:

1. Press Home  > Menu  and touch **System settings > About phone.**
2. Scroll to the version number.

Reinstall Your Google Application:

Your Google™ application purchases are reloaded remotely and can be re-installed after the update is applied.

1. Log into your Google Account via the device.
2. Press Home  and touch  > **Play Store.**
3. Touch  on the top left of the screen, or touch and hold the left end of the screen and slide it to the right, and touch **My apps.**
4. Scroll through the list of previously downloaded Google applications and choose the one you wish to reinstall.
5. Follow the onscreen instructions.

Notes

- Instructions to perform tasks in this guide may change depending on the software version on your device.
- All screens in this guide are simulated. Actual displays may vary.

Copyrights

© 2014 Kyocera Corporation. All Rights Reserved. All other trademarks are the property of their respective owners. KYOCERA is a registered trademark of Kyocera Corporation.

Android, Google Play, Google Maps, Gmail, Google Talk, and YouTube are trademarks of Google Inc.

The Bluetooth® word mark and logos are registered trademarks owned by Bluetooth SIG, Inc. and any use of such marks by Kyocera Corporation is under license. Other trademarks and trade names are those of their respective owners.



microSD and microSDHC Logos are trademarks of SD-3C, LLC.

Swype and the Swype logos are registered trademarks or trademarks of Nuance Communications, Inc. © 2014 Nuance Communications, Inc. All rights reserved.

Index

- 3-Way Calling, 27
- Accessibility, 132
- Accounts & Sync, 124
 - Add Account, 124
 - General Sync Settings, 125
- Airplane Mode, 117
- Alarm, 101
 - Change, 102
- Android Keyboard, 11
 - Overview, 11
 - Settings, 14
 - User Dictionary, 13
 - Voice Input, 13
- Answer a Call, 24
- Applications, 62
- Auto Retry, 28
- Auto-Rotate Screen, 122
- Backup, 130
- Battery, 1
 - Charge, 2
 - Install, 1
 - Remove, 111
- Bluetooth, 106
 - Disconnect, 108
 - Menu, 106
 - Pair, 107
 - Receive, 108
 - Send, 108
 - Turn On/Off, 106
 - Unpair, 108
- Brightness, 122
- Browser, 72
 - Accessibility Settings, 76
 - Advanced Settings, 77
 - Bandwidth Management Settings, 78
 - Bookmarks, 79
 - Browser Labs Settings, 78
 - General Settings, 75
 - Homepage, 79
 - Menu, 73
 - Navigation, 72

- Offline Reading, 79
- Open, 71
- Privacy Settings, 75
- Reset, 79
- Search Engine, 78
- Security Settings, 75
- Text Selection, 74
- Website Settings, 78

Calculator, 103

Calendar, 95

- Add an Event, 95
- Erase Events, 99
- Event Alerts, 96
- Invite Guests, 96
- Show or Hide, 100
- Synchronize, 100
- View Events, 97

Call Forwarding, 27

Call Log, 32

- Clear, 33
- Options, 32
- View, 32

Call Restrictions, 30

Call Timer, 30

Call Waiting, 26

Caller ID, 26

Camera

- Close, 85
- Open, 83
- Review Screen, 84
- Settings, 87
- Take a Picture, 85
- Viewfinder, 83
- Zoom, 86

Clock, 100

Copy, 18

Copyrights, 136

Credential Storage, 129

Cricket Services

- Cricket Navigator, 67
- Cricket Shop, 65
- Cricket411, 69
- Mobile Web, 68
- Muve Music, 67

- My Account, 69
- Cricket Shop, 65
- Data Connection
 - Stauts Indicator, 72
- Data Service, 71
- Data Usage, 115
- Date & Time, 131
- Default Notification, 121
- Developer Options, 133
- Device
 - Overview, 3
 - Turn Off, 2
 - Turn On, 2
- Device Administration, 129
- Eco Mode, 105
- Email, 44
 - Account Settings, 48
 - Add an Account, 44
 - Compose and Send, 46
 - Corporate Account, 45
 - Delete an Account, 49
 - General Settings, 48
 - Manage Inbox, 47
 - View and Reply, 47
- Emergency Call, 21
- Enhanced 911 (E911), 22
- Enter Text, 11
- Entertainment, 62
- Evolve Money, 69
- Factory Data Reset, 131
- Font Size, 122
- Gallery, 87
 - Close, 90
 - Open, 87
 - View, 88
 - Zoom, 89
- Gmail, 41
 - Access, 42
 - Google Account, 41
 - Read and Reply to a Message, 44
 - Send a Message, 43
- Google Account
 - Create, 41
 - Sign In, 42

- Google Maps, 65
- Google Talk, 57
 - Manage Friends, 58
 - Mobile Indicators, 59
 - Settings, 60
 - Sign In and Chat, 57
 - Sign Out, 60
- Google Play, 62
 - Play Store, 62
- Home Screen, 6
 - Customize, 7
 - Extended Screens, 6
 - Overview, 6
- In-Call Options, 31
- Incoming Calls
 - Answer, 24
 - Mute the Ringtone, 24
 - Reject, 24
 - Reject and Send a Text, 24
- Internet Call, 23
- Keyboard
 - Android, 11
 - Swype, 14
- Language, 130
- Location Settings, 125
- microSD Card, 110
 - Format, 112
 - Install, 111
 - Media Device, 113
 - Memory Information, 112
 - Remove, 110
 - Unmount, 113
 - USB Drive, 113
- Mobile Web, 68
- Music, 67
 - Back up, 68
 - Library, 67
- Muve Music, 67
- My Account, 69
- My Location, 125
- Navigation, 65
- Notifications, 8
- Paste, 18
- People, 34

- Add a New Entry, 35
- Display, 34
- Edit an Entry, 37
- Save a Phone Number, 37
- Share an Entry, 40
- Synchronize the Entries, 39
- Phone, 20
- Phone Call
 - Emergency Call, 21
 - From People, 21
 - From Recent Calls, 20
 - From Text Message, 21
 - Make Calls, 20
 - Plus Code Dialing, 22
 - Receive, 24
 - Using Internet Call, 23
 - Using Phone Dialpad, 20
 - With Pauses, 22
- Pictures, 83
 - Crop, 91
 - Edit, 90
 - Options Menu, 90
 - Rotate, 91
 - Share, 92
- Play Music, 67
- Portable Wi-Fi Hotspot, 80
- Proximity Sensor, 123
- Ringtone, 120
- Roaming, 117
- Screen Lock, 126
 - Change, 128
 - Password, 127
 - Pattern, 126
 - PIN, 127
 - Slide, 128
- Screen Timeout, 122
- Security Settings, 126
 - Encrypt Data, 128
 - Passwords, 129
 - Screen Lock, 126
- Settings, 115
- Share Photos and Videos, 92
 - Bluetooth, 93
 - Email, 92

- Gmail, 92
- Google+, 93
- Multimedia Message, 93
- Picasa, 94
- YouTube, 94
- Silent Mode, 120
- Status Bar, 8
- Storage Settings, 123
- Swype, 14
 - Keyboard Overview, 15
 - Settings, 17
 - User Dictionary, 17
 - Voice Input, 17
- System Update, 133
- Tethering & Portable Hotspot, 117
- Text Entry, 11
- Text Message
 - Make a Call From, 21
- Text Messaging and MMS, 50
 - Compose a Multimedia Message, 51
 - Compose a Text Message, 50
 - Draft Messages, 52
 - Manage Messages, 53
 - New Messages, 53
 - Settings, 55
- Text-to-Speech, 104
- Tools, 95
- Touchscreen
 - Keyboard, 11
 - Navigation, 5
 - Turn Off, 3
 - Turn On, 3
- Trademarks, 136
- TTY Mode, 29
- Vibrate
 - And Ring, 121
 - Pattern, 120
- Videos, 85
 - Record, 86
 - Settings, 87
 - Share, 92
 - Viewfinder, 85
 - Watch, 89
- Voice Dial, 103

- Voice Input
 - Android Keyboard, 13
 - Swype, 17
- Voice Privacy, 29
- Voice Search, 104
- Voicemail, 24
 - Notification, 25
 - Retrieve Messages, 25
 - Set up, 24
 - Settings, 26
- Volume, 119
- Wallpaper, 7, 122
- Web, 70
- Wi-Fi, 70
 - Connect, 70
 - Connect to a Different Network, 71
 - Settings, 115
 - Status, 71
- YouTube, 56