



America

---

## **Certification Exhibit**

**FCC ID: YKD-25STW4100-029**

**FCC Rule Part: 15.247**

**TÜV SÜD Project Number: 72126853**

**Manufacturer: L3 Communications, CyTerra Division**  
**Model: HF-A11-SMT-0**

## **Manual**

# RANGE-R2D

## OPERATION & TRAINING MANUAL

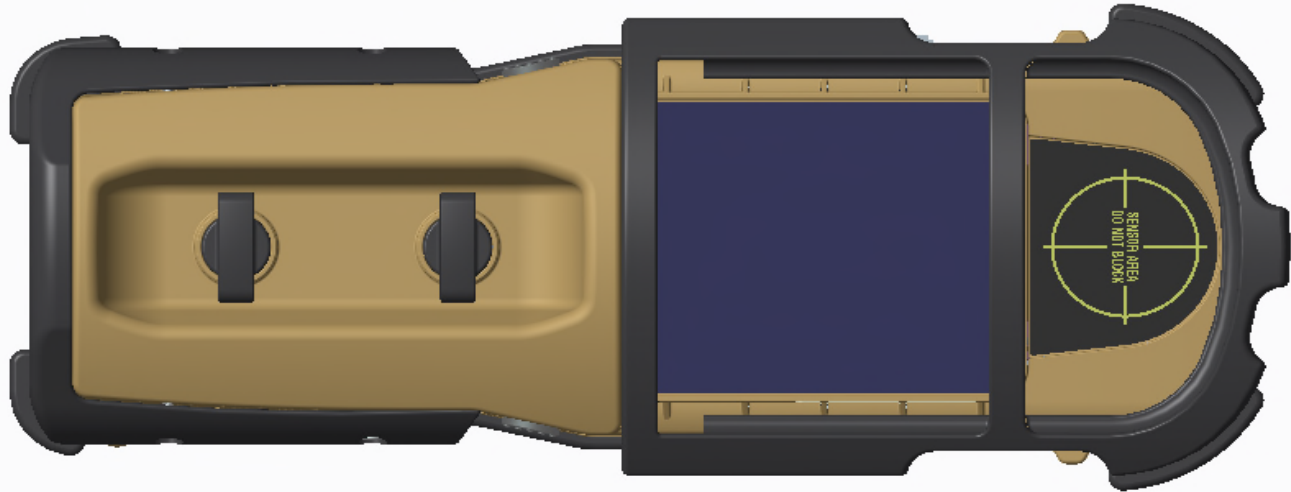

# FCC Required Information

- **Warning:** Changes or modifications to this device not expressly approved by **L-3 CyTerra** could void the user's authority to operate the equipment
- **NOTE:** This equipment has been tested and found to comply with the limits for a Class B digital device, pursuant to Part 15 of the FCC Rules. These limits are designed to provide reasonable protection against harmful interference in a residential installation. This equipment generates, uses, and can radiate radio frequency energy and, if not installed and used in accordance with the instructions, may cause harmful interference to radio communications. However, there is no guarantee that interference will not occur in a particular installation. If this equipment does cause harmful interference to radio or television reception, which can be determined by turning the equipment off and on, the user is encouraged to try to correct the interference by one or more of the following measures:
  - Reorient or relocate the receiving antenna.
  - Increase the separation between the equipment and receiver.
  - Connect the equipment into an outlet on a circuit different from that to which the receiver is connected.
  - Consult the dealer or an experienced radio/TV technician for help.
- This equipment complies with radiation exposure limits set forth for an uncontrolled environment. This equipment is in direct contact with the body of the user under normal operating conditions. This transmitter must not be co-located or operating in conjunction with any other antenna or transmitter.



# LESSON 1

## Description and Capabilities

# INSTRUCTION POINTS

- The RANGE-R2D system is a portable, handheld, battery-operated system designed to detect moving and near-stationary targets through walls constructed of common building materials.
- The system is comprised of a stepped-frequency, continuous-wave radar transceiver, digital signal processor, display and power supply electronics enclosed in a rugged, water-resistant, lightweight plastic housing.
- The operator controls consist solely of the two momentary push-button switches located on the sides of the system.
- The graphics display on the front of the system presents target detection information and system status.
- The display is easy to use, alerts are simple to interpret, and detection is nearly immediate.

# GENERAL



The RANGE-R2D is lightweight and compact. It is designed to detect moving and near stationary objects through walls constructed of common building materials.

# MECHANICAL DATA

Item	Weight
RANGE-R2D Unit	3 lbs (1.36 kg)
Storage Container	6.1 lbs (2.77 kg)

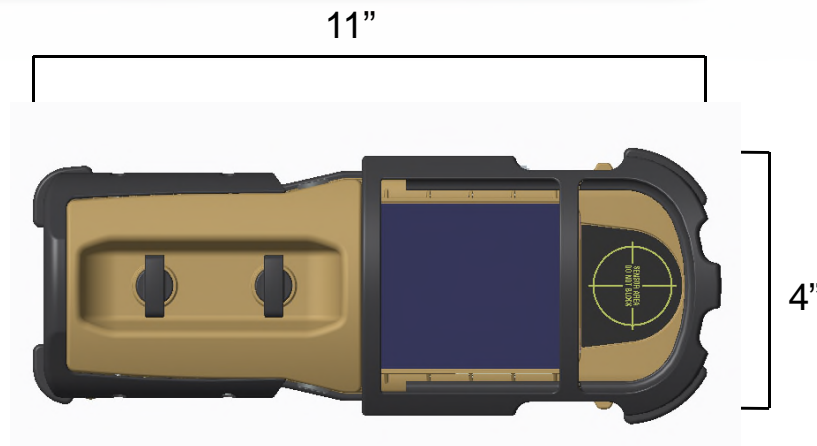

Item	Dimensions
RANGE-R2D Unit	10"x3.6"x3.9" (25.4cm x 9.14cm x 9.91cm)
Storage Container	16.3"x12.8"x6.8" (41.4cm x 32.51cm x 17.27cm)



# INSTRUCTION POINTS

- The major components are as follows:
- **Rotational View LCD**– displays target information. The display will rotate to match the long axis of system orientation. **THIS WILL NOT WORK WITH THE SYSTEM WITH THE LONG AXIS ORIENTED VERTICALLY.**
- **Scan Buttons (X2)** – to perform all system operations. Scan Buttons will also rotate to match the LCD screen.
- **Battery Lid** – secures the battery compartment, keeps moisture away from the batteries.
- **Rearward Antenna** – helps reduce false alarm rate, **The Operator should NEVER cover this antenna.**
- **Receive Antenna** – receives radar waves sent from the transmit antenna
- **Transmit Antenna** – transmits radar waves to locate targets.



# MAJOR COMPONENTS

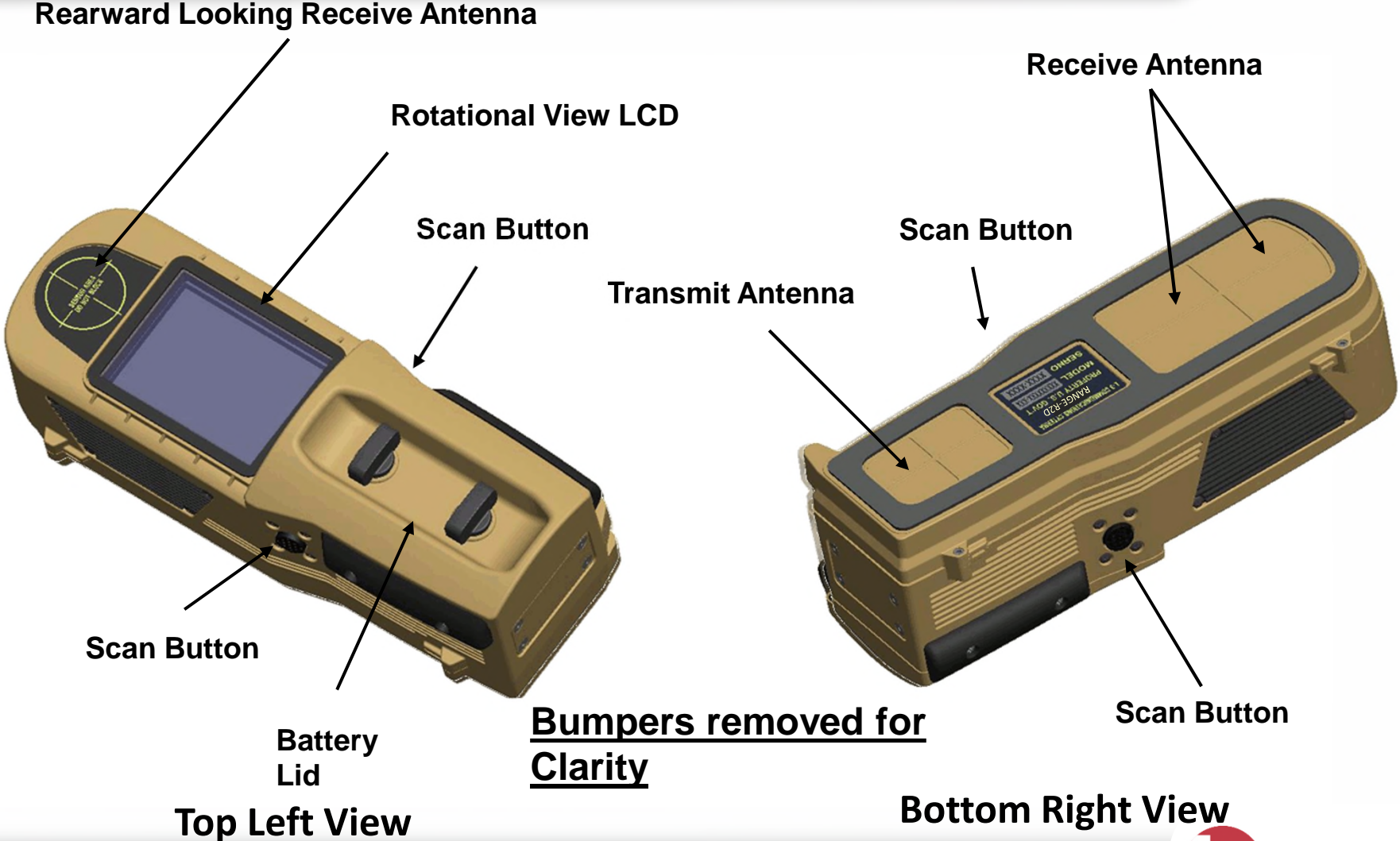

# INSTRUCTION POINTS

- The rearward looking antenna faces the operator and helps reduce the influence of the operator and other “friendly” movers that could otherwise appear as targets on the readout display.
- The rearward antenna should never be blocked during operation.
- Avoid blocking the rearward antenna when stabilizing the system.
- For both left- and right-handed use, the operator’s hand will cover the battery compartment.
- If possible the operator should hold the sensor in the prone position without blocking the line of site for the rear antenna. Stabilize the sensor at eye level for best results.
- Keep operator movement to a minimum.

# REARWARD LOOKING ANTENNA

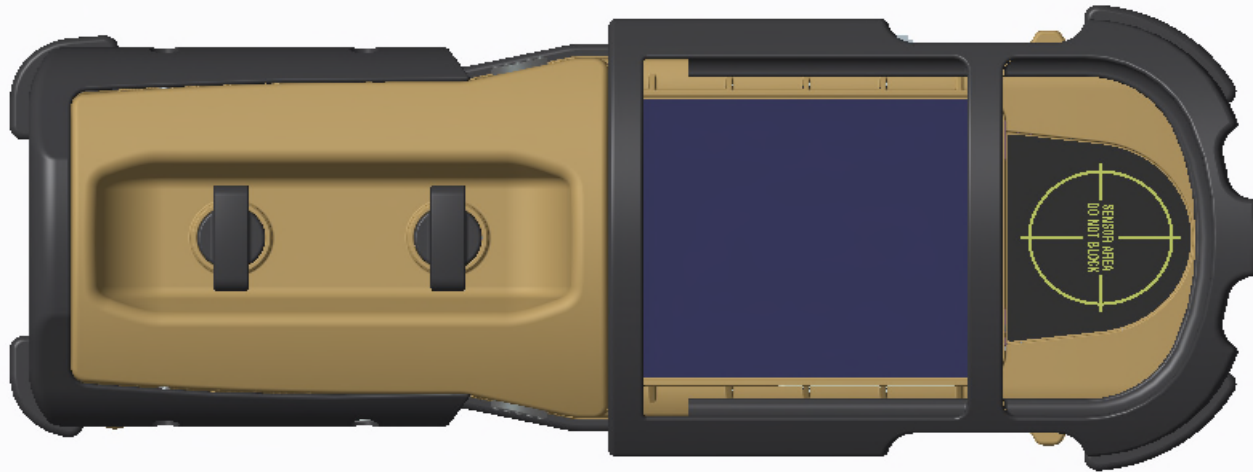

Operating hand will cover the battery compartment.

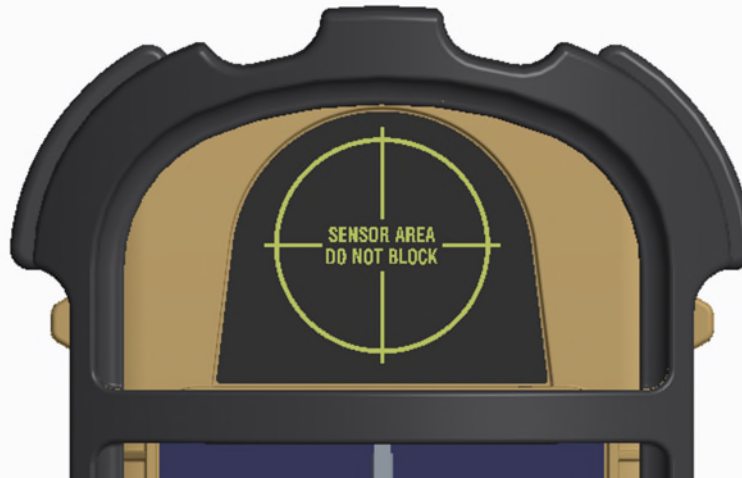

Used to help reduce false alarms caused by the operator and or people around the operator.

**DO NOT BLOCK** the rearward looking antenna with your non-operating hand when trying to stabilize the system. Hold the system at eye level when operating.



# INSTRUCTION POINTS

- **Battery Indicator:** Represents battery life of the system
- **Target Indicator:** The red square indicates one target. The red square will also indicate more than one target in an area if they are close to each other.
- **Track Indicator:** Represents a detected target's last position
- **Over-temp Indicator:** System has reached an internal temperature of 80 degrees Celsius and will shut off at 85 degrees Celsius.
- **Operator Movement Indicator:** Informs the operator that excessive movement of the system could be affecting the systems performance.
- **Excessive Backside Movement Indicator:** Lets the operator know there is too much movement behind the system for it to work properly.
- **Target Display Grid:** Displays all target information (in meters)
- **Horizontal Red Lines on the Display:** The first two walls detected by the system. Only 2 can be shown at a time.
- **Number of Targets Indicator:** Displays the total number of targets detected as a numeric value.
- **Field of view lines:** Displays the area of detection the system is currently scanning in. NOTE: FOV off if wall coupled, FOV on if standoff.

# LCD SCREEN LAYOUT – Indoor/Against Wall Use

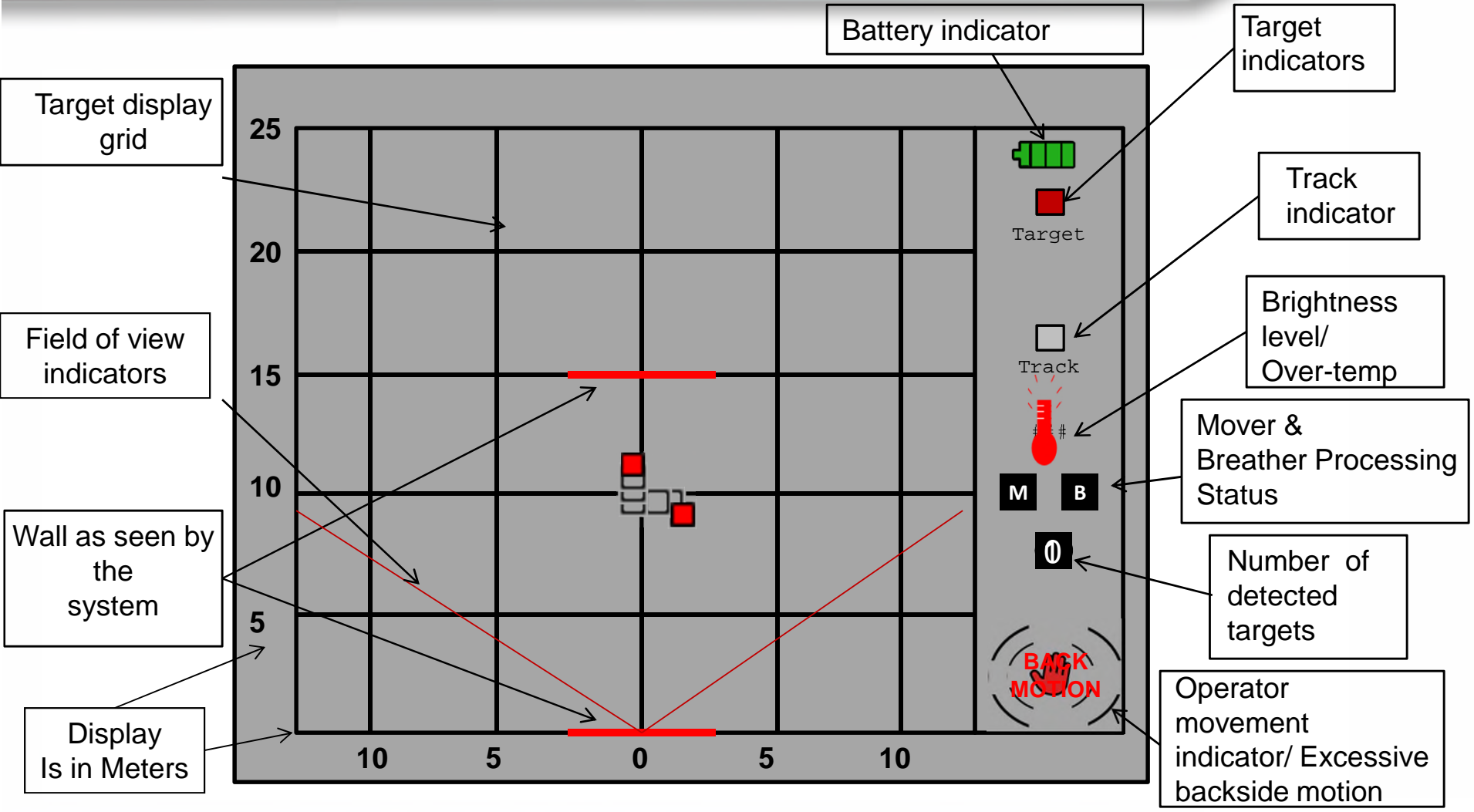

# INSTRUCTION POINTS

- The system transmits radar waves into the target area.
- All solid objects in that area reflect the waves.
- The system receives these reflected waves, processes the return, and analyzes the data using principles of Doppler radar to detect moving objects and identify possible targets.

# THEORY OF OPERATION

Radar waves are transmitted into the target area. The radar waves are then reflected by solid objects. The system detects these reflected waves, analyzes them, and interprets them on the LCD. The sensor can be placed against the wall or from standoff.

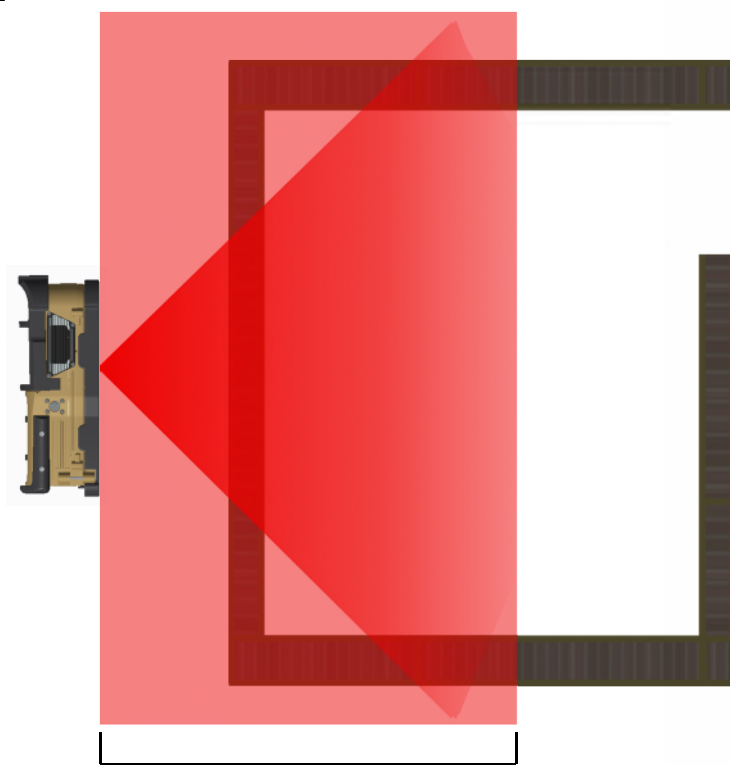
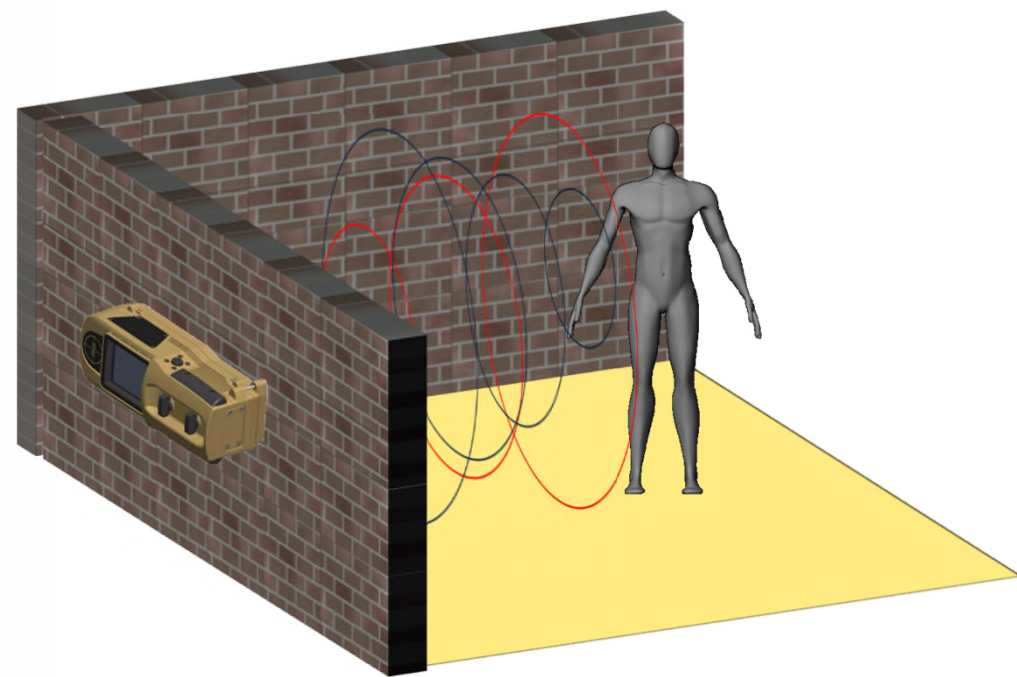

25 meters



# INSTRUCTION POINTS

- Relative motion is the changing distance between two objects. In other words, it is the relative speed between these objects.
- A radar signal reflected off a stationary object (no relative motion) would return at the same frequency as it was transmitted.
- When the target is approaching or moving towards the transmitter, the radar signal reflected off the object will be compressed and the returned frequency will be higher than the frequency that was transmitted.
- Conversely, a radar signal reflected off an object moving away from the transmitter/receiver will be stretched.
- The reflected (returned) signal will be of a lower frequency than the transmitted signal.



# DOPPLER EFFECT

Radar waves reflected from a stationary target will remain constant. Radar waves reflected from a moving object will be compressed if the object is approaching or stretched if the object is receding.

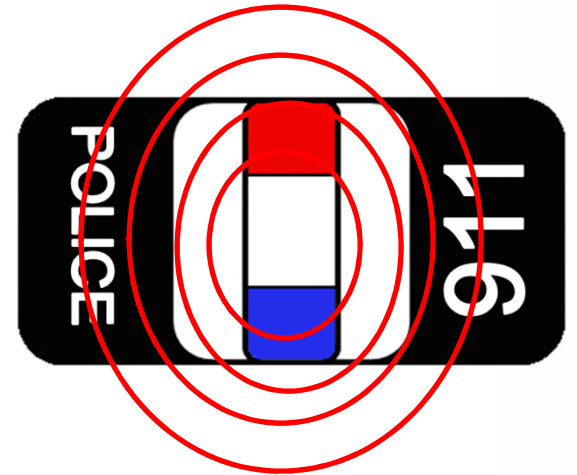
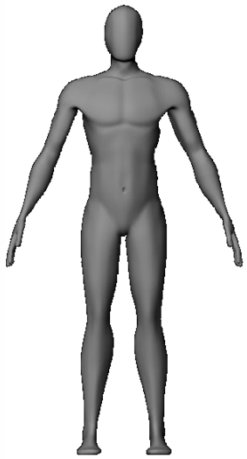

# DOPPLER EFFECT

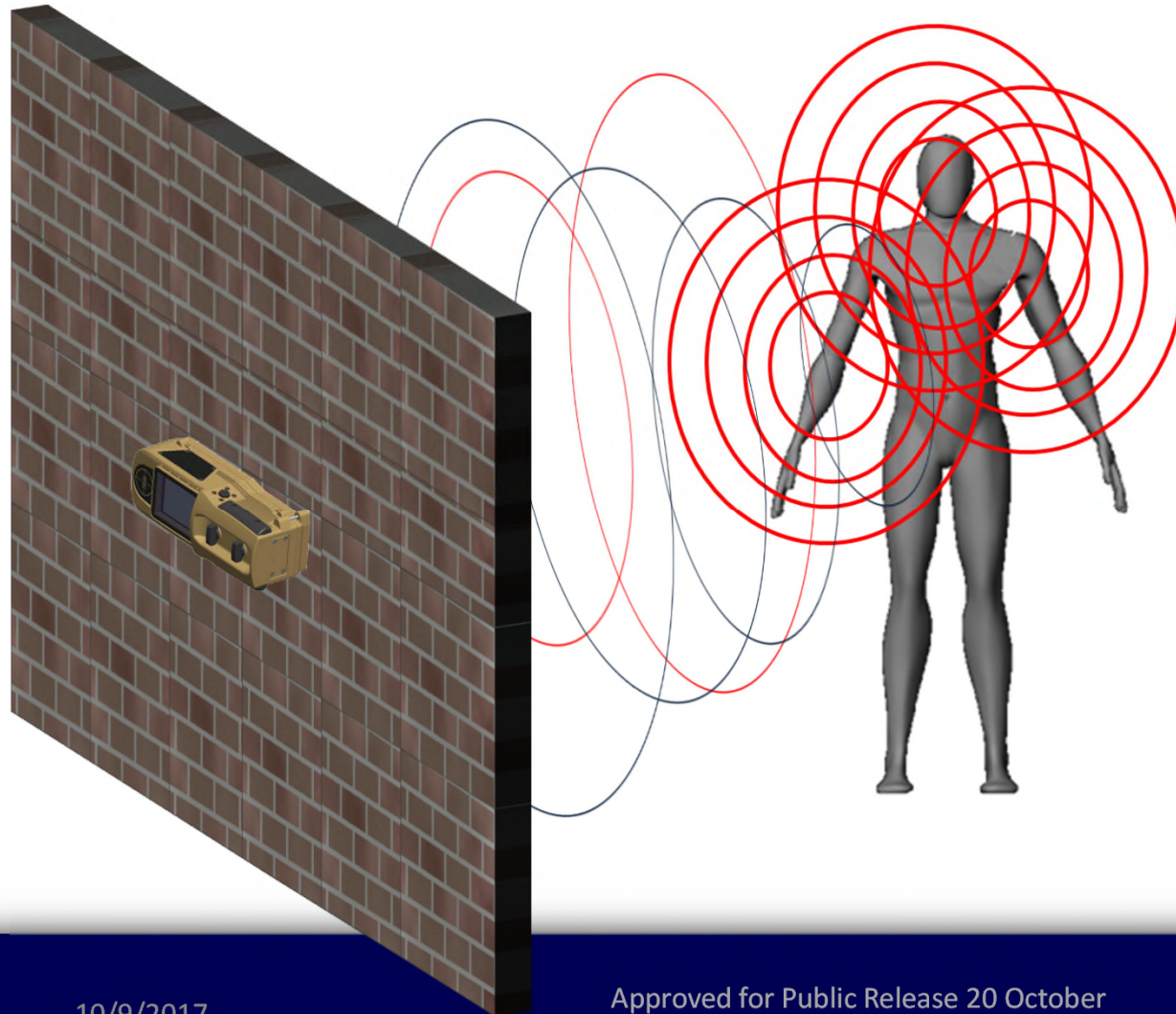

Each movement from the target will have an effect on the Doppler. These movements will be detected by the system and displayed on the LCD.

- Breathing
- Limb Movement
- Unintentional Micro-Movements

# INSTRUCTION POINTS

- The RANGE-R2D detects targets up to a range of 25 m from the sensor.
- The RANGE-R2D senses motion through non-metallic walls and barriers of different materials such as drywall, adobe, cinderblock, and rebar reinforced concrete. It has been tested through walls up to 12” thick, but may not be limited to this material depth dependent upon composition and density.
- The system is water resistant up to 4 feet for 30 minutes. The system would have to be held underwater to stay submerged, otherwise it would float.

# CAPABILITIES

Function	Performance
Max effective range	25 meters (from sensor)
Minimum mobile target acquisition time	5 seconds
Minimum stationary target* acquisition time	30 seconds
Accuracy	2 meters in range or cross range
Field of View	+/-80° from center (open air)
Water resistant	4 feet for 30 minutes

\* A target that exhibits activity but does not change position



# CAPABILITIES

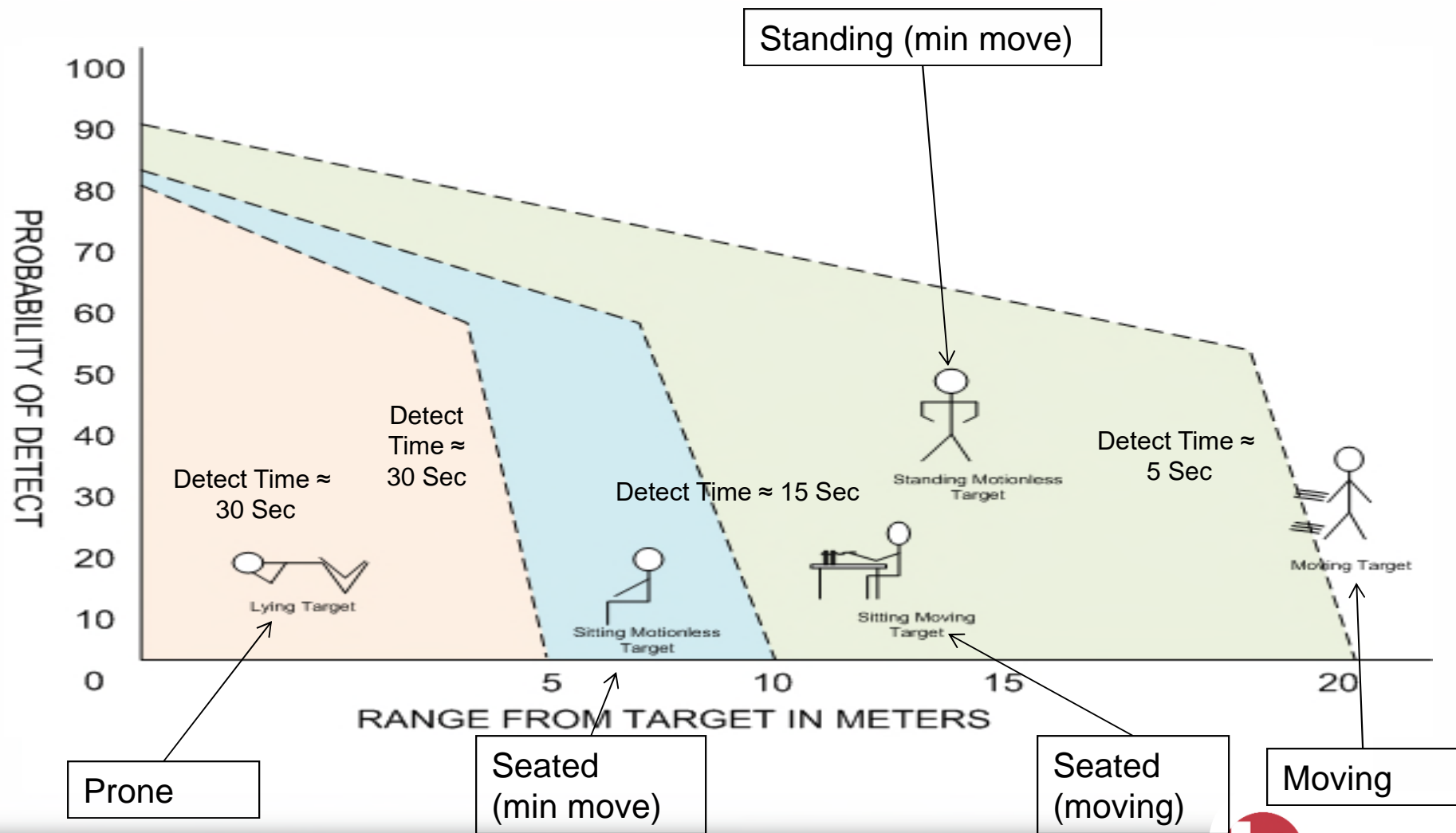

# LESSON 2

## Operation

# INSTRUCTION POINTS

- Prior to operation, batteries need to be installed into the RANGE-R2D system.
- The RANGE-R2D is designed to operate on eight standard “AA” sized 1.5v lithium batteries.
- Alkaline AA, and 1.5v Nickel Metal Hydride AA batteries can be used in the system, but will not give you maximum performance from the system.
- Failure to install the batteries properly will cause the system to malfunction.
- To install the batteries, remove the battery door by unscrewing the thumbscrew located at the top of the unit. Insert all batteries as the diagram inside the case states.
- Replace the battery cover and secure it by hand tightening the thumbscrews.
- Do not mix the types of batteries that are in the system at one time.

# BATTERY INSTALLATION



Note: Bumpers removed for clarity

## Functional Batteries (in order of performance)

1.5v Lithium (L-91)

1.5v Nickel Metal  
Hydride

Alkaline

### **WARNING**

Installing the batteries  
incorrectly will cause the  
system to malfunction.  
**DO NOT MIX BATTERY  
TYPES!!**



# BATTERY COMPATIBILTY/PERFORMANCE

Battery Type ("AA" Size x 8)	Operational Condition (On/Off Cycle)	Battery Life vs. Temp		
		-20°C (-4°F)	25°C (77°F)	50°C (122°F)
Lithium	30 sec/3 min	9.1 hrs	11.7 hrs	12.75 hrs
NiMH	30 sec/3 min	6.5 hrs	6.6 hrs	8.3 hrs
Alkaline	30 sec/3 min	0.25 hrs	3.1 hrs	5.8 hrs
Lithium	1 min/6 min	9 hrs	11.6 hrs	13 hrs
NiMH	1 min/6 min	8.25 hrs	8.5 hrs	8.75 hrs
Alkaline	1 min/6 min	0.33 hrs	2.8 hrs	5.5 hrs
Lithium	Continuous	1.2 hrs	1.5 hrs	1.4 hrs
NiMH	Continuous	0.9 hrs	1.25 hrs	1.25 hrs
Alkaline	Continuous	1 min	24 min	37 min



# INSTRUCTION POINTS

- Operator controls consist solely of the two momentary push button switches referred to as scan buttons located on the sides of the system.
- These two buttons perform the several functions: they power on the system, power off the system, adjust the brightness, and navigate the user interface.
- The sensor contains an inertial measurement unit that automatically detects the orientation of the sensor for single button specific functions.

# CONTROL SEQUENCE

Function	Sequence
Power-On	Press and release both Scan Buttons. Sensor will boot to Menu Mode.
Power-Off	Press and hold both Scan Buttons for 3 seconds.
Brightness Control	In the Main Menu select brightness and press either up or down to brighten or dim the display.
Zoom Selection	In Scan Mode, press the bottom Scan button to zoom in.
Main Menu	Press and release both Scan Buttons while in Scan Mode.
Cycle Menu Options	Press the bottom Scan Button while in Menu Mode.
Select Menu Option	Press the top Scan Button while the selection is highlighted.
Scan Mode	Press and release both Scan Buttons from any other mode or menu.

# INSTRUCTION POINTS

- With batteries installed, aim the system in the desired direction (either against a wall or in stand off) and press and release the two scan buttons.
- Tracking of moving targets will start in a minimum of three seconds.

# HOLDING THE SYSTEM

## Wall Coupled Use:

- Select Wall Mode
- Thumb and index finger operating scan buttons
- Palm covering battery compartment
- Hold at eye level
- **DO NOT COVER OR BLOCK REARWARD LOOKING ANTENNA!**
- **DO NOT COVER OR BLOCK FORWARD LOOKING ANTENNAS!**

## Stand Off Use:

- Mount sensor on tripod or monopod
- Select Standoff Mode
- **DO NOT COVER OR BLOCK REARWARD LOOKING ANTENNA!**
- **DO NOT COVER OR BLOCK FORWARD LOOKING ANTENNAS!**

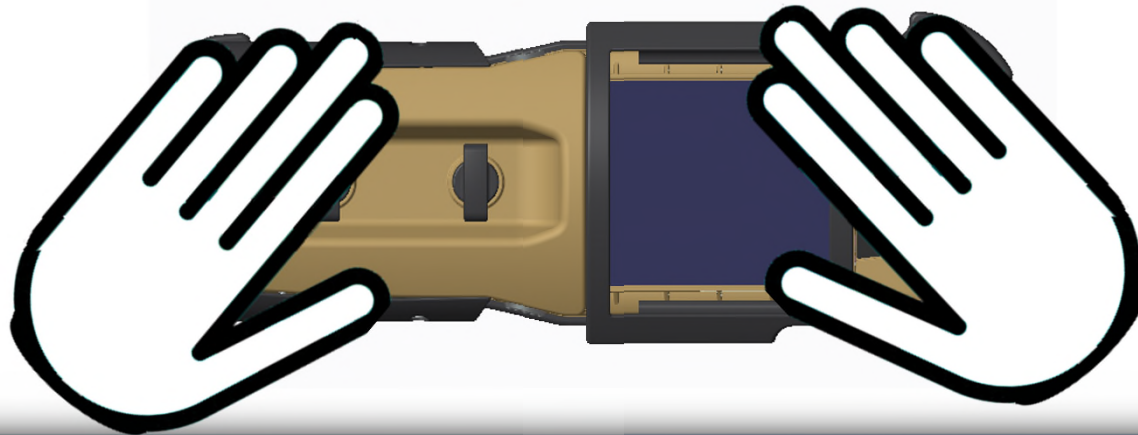

# SYSTEM INITIALIZATION

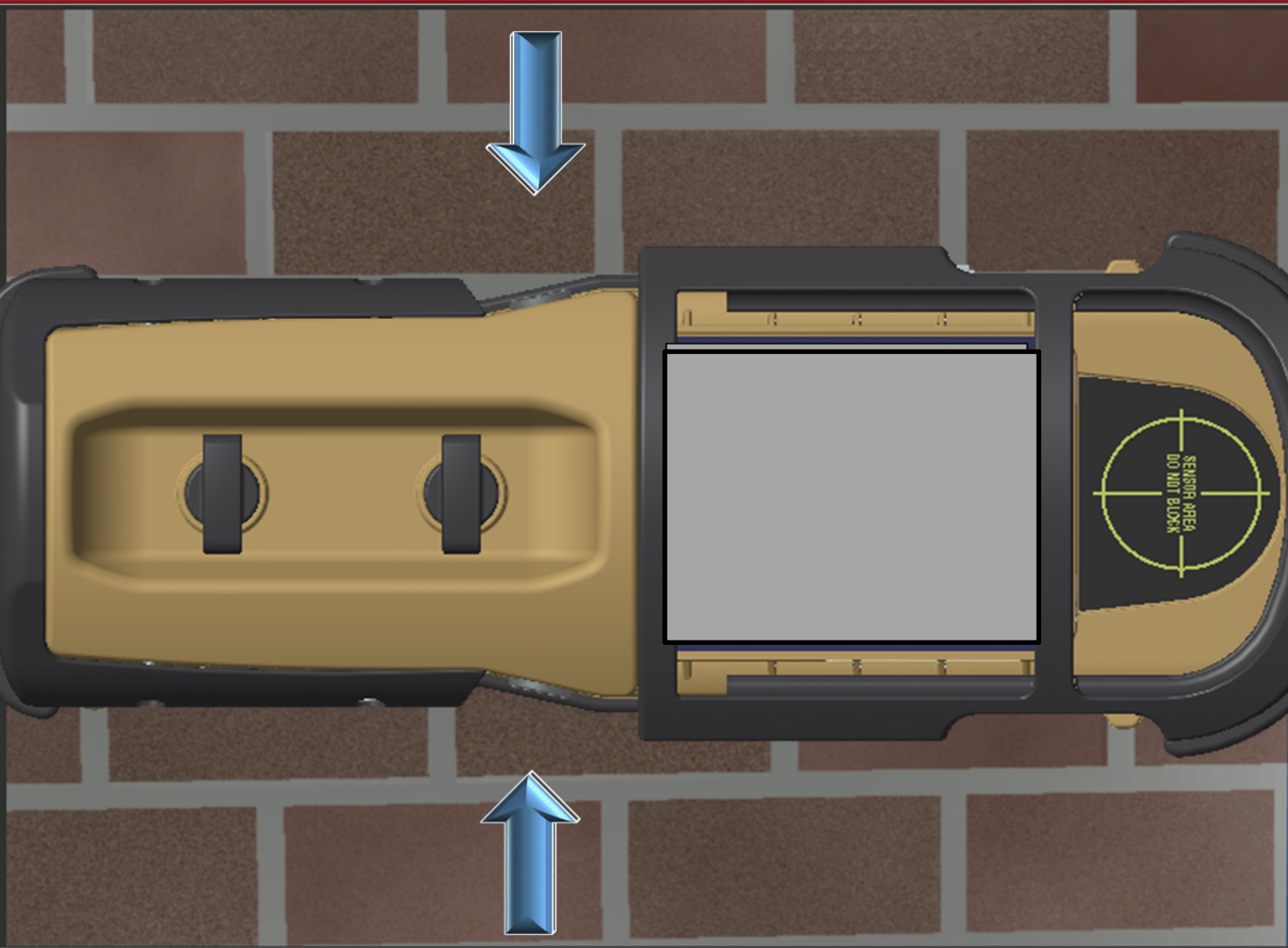

**WARNING**  
Do not block rearward antenna while scanning.

Once the system is in the desired position (flush to the wall or aimed at the target structure), depress and release the Scan Buttons

Note: Bumpers removed for clarity

THIS TECHNICAL DATA IS CONTROLLED UNDER THE U.S. INTERNATIONAL TRAFFIC IN ARMS REGULATIONS (ITAR) AND MAY NOT BE EXPORTED TO A FOREIGN PERSON, EITHER IN THE U.S. OR ABROAD, WITHOUT THE PROPER AUTHORIZATION BY THE U.S. DEPARTMENT OF STATE.



**communications**  
CyTerra

# WALL COUPLING

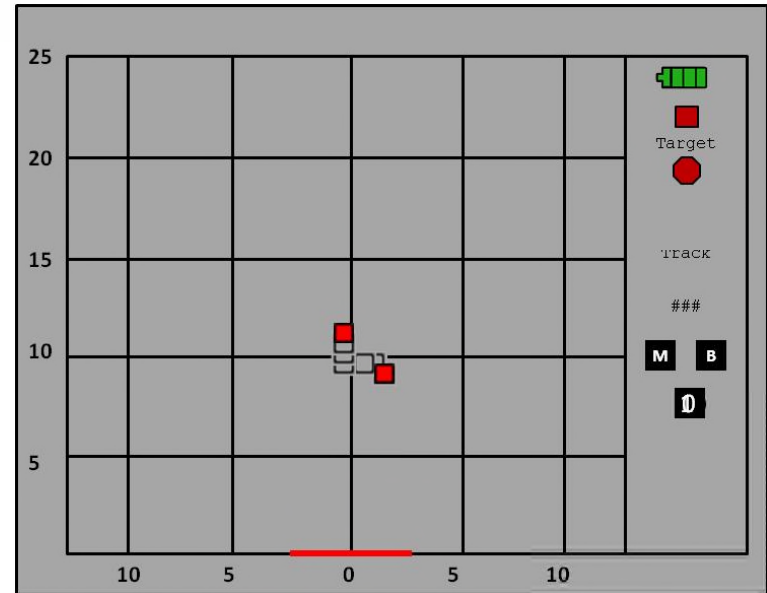
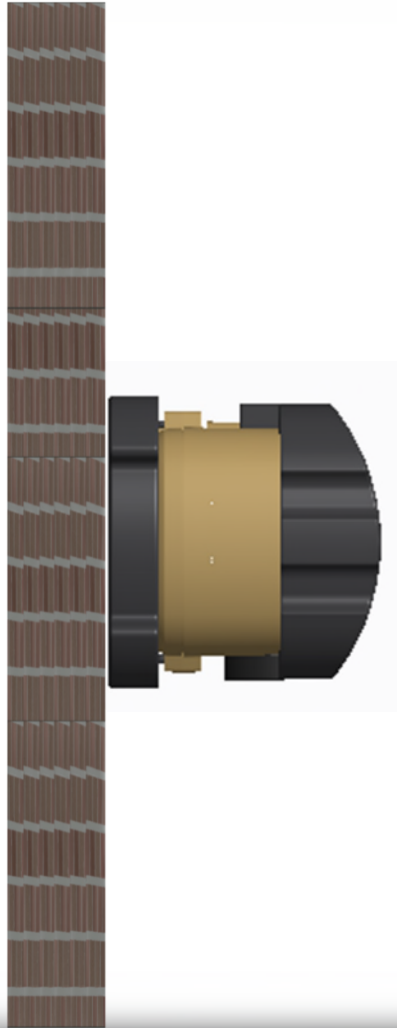

Wall Mode is selected in the menu screen and utilizes a 180 degree FOV. The first wall always appears at the “0 line” when the system is set to Wall mode, whether the system is against a wall or not.

## Factors to Consider When Gauging Scan Time

- The minimum amount of time to detect a stationary target (standing person) is six seconds.
- There is a 2.5 second delay between the real movement and the displayed results. The object is displayed where it was 2.5 seconds ago.
- Objects must be separated by at least 2 meters to be displayed as separate targets.

A 30 second scan time is recommended before moving to a new scanning position.



# CAPABILITIES

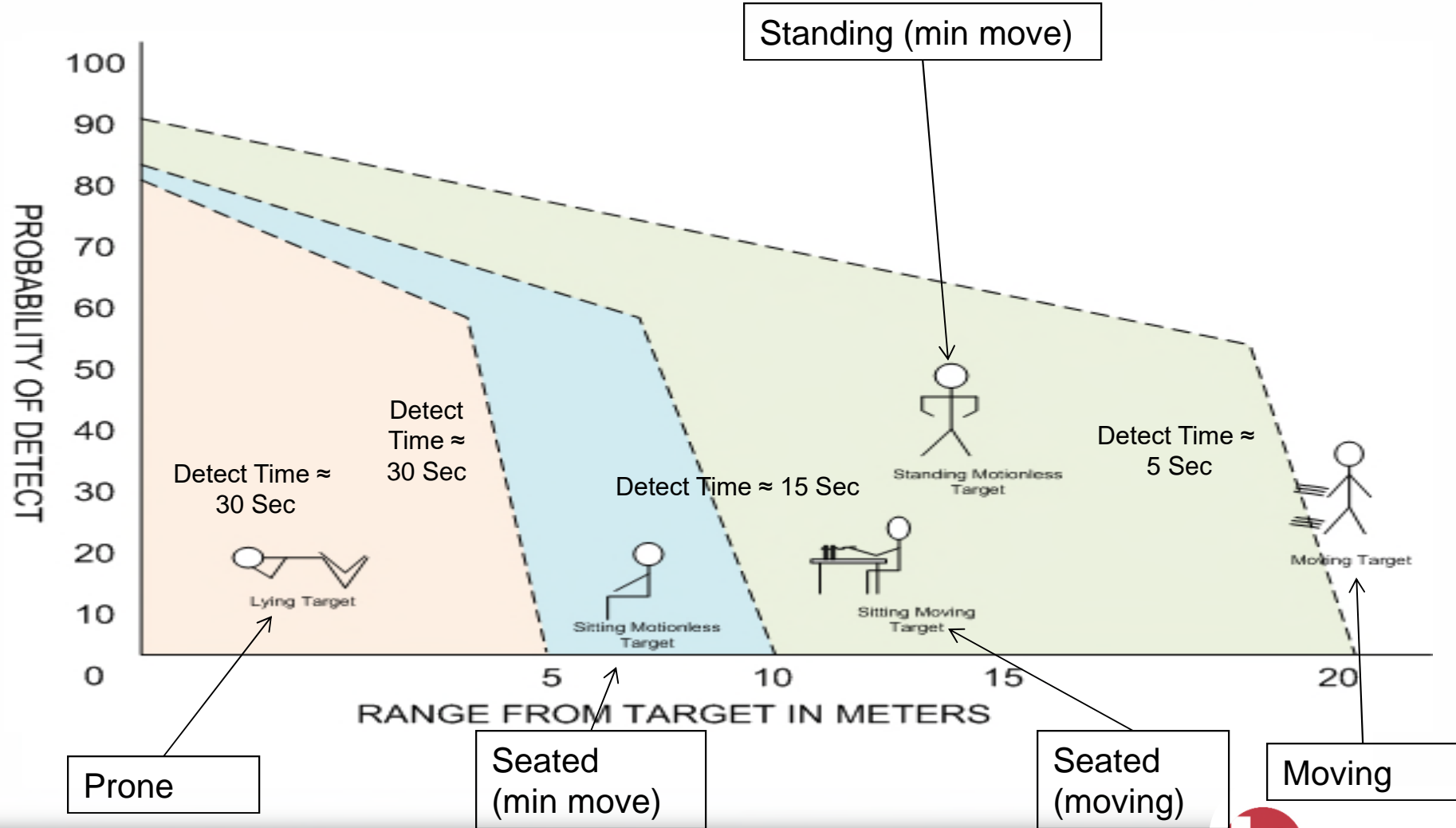

# INSTRUCTION POINTS

## Brightness Adjustment

- The brightness level of the display is adjustable via a menu selection.
- To increase the brightness, select up and press the top scan button.
- To decrease the brightness, select down and press the top scan button.
- Orientation of the system does not affect the button use.

## Zoom Feature and Adjustment

- The Zoom feature can only be accessed while in the Scan Mode. The top and bottom scan buttons also control this function.
- The scan buttons allow the operator to zoom in or zoom out.
- **Warning: The unit must settle for approximately 3-5 seconds after scanning has started for the Zoom feature to work.**

# ADJUSTING SCREEN BRIGHTNESS

The brightness level is adjusted on the menu screen. The operator selects “up” or “down” to adjust the brightness of the screen.



# INSTRUCTION POINTS

- By using the correct button sequence, the operator can navigate through the four different menus . This allows the operator to customize the use of the system. Once again, the Scan Buttons are used to navigate the menus and make selections. The menus include the **Main Menu, Standoff, Wifi, Shutdown Timeout, Target Limit Select, Brightness** and **Status**.
- **Main Menu**- allows operator to choose the other menu screens
  - Note: Selection of Wall Mode or Standoff Mode is made on the Main Menu page. Field of View (FOV) automatically changes to 180 (Wall Mode) or 90 (Standoff) with this mode selection. Wifi on or off if the unit is a Range-R2D Link
- **Target Limit Select**- allows operator to limit the number of targets to be displayed. Choices are 1, 2, 3, no limit.
- **Shutdown Timeout**- allows operator to select the time the system will stay on without further button actuation
- **Brightness** – allows the operator to brighten or dim the display
- **Status**- shows system information

# MENU NAVIGATION

- Press and release Scan Buttons to enter menu mode.
- Press and release the lower button to scroll through menu choices.
- Press and release the top button to make the selection.
  - Currently selected options are noted by the \*
- The example below shows selection of Shutdown Timeout

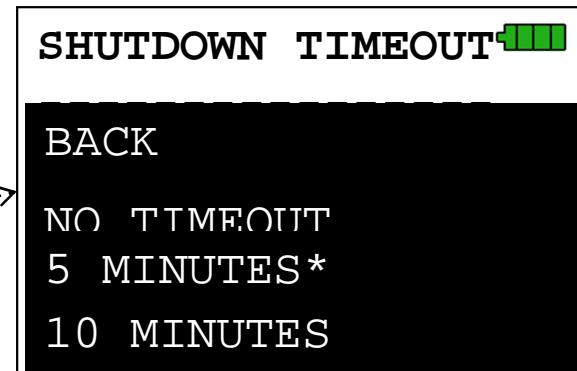
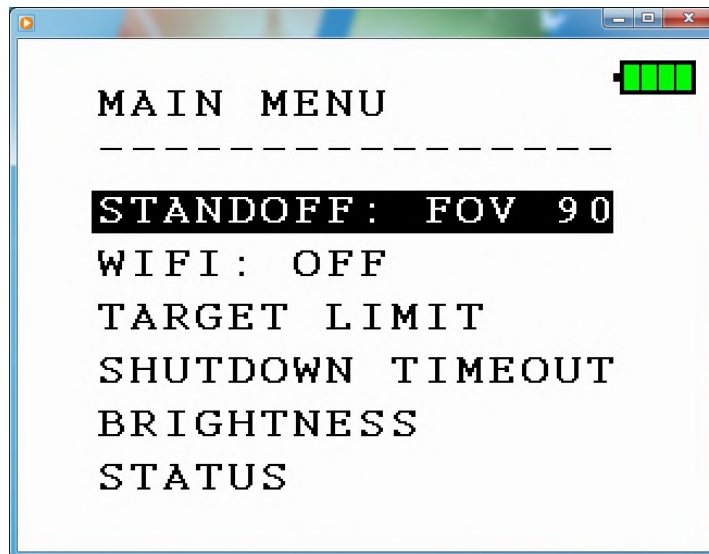

This selection controls how long the system will scan before returning to standby mode.

# DISPLAY ZOOM

- The system allows changing the display to focus on an area smaller than the default 25m range and azimuth. Momentarily depressing the bottom button while in scan mode changes to the 10m x 10m display, pressing it again gives a 5m x 5m display.
- Depressing the upper button changes back to 10m x 10m, and again changes back to the default display.
- Switching from scan back to standby restores the default display.
- When in zoom mode, the display background changes to yellow to alert the operator, and red arrows along the border of the display indicate targets that are within the range of the sensor, but beyond the selected display range.



# 10m x 10m DISPLAY ZOOM

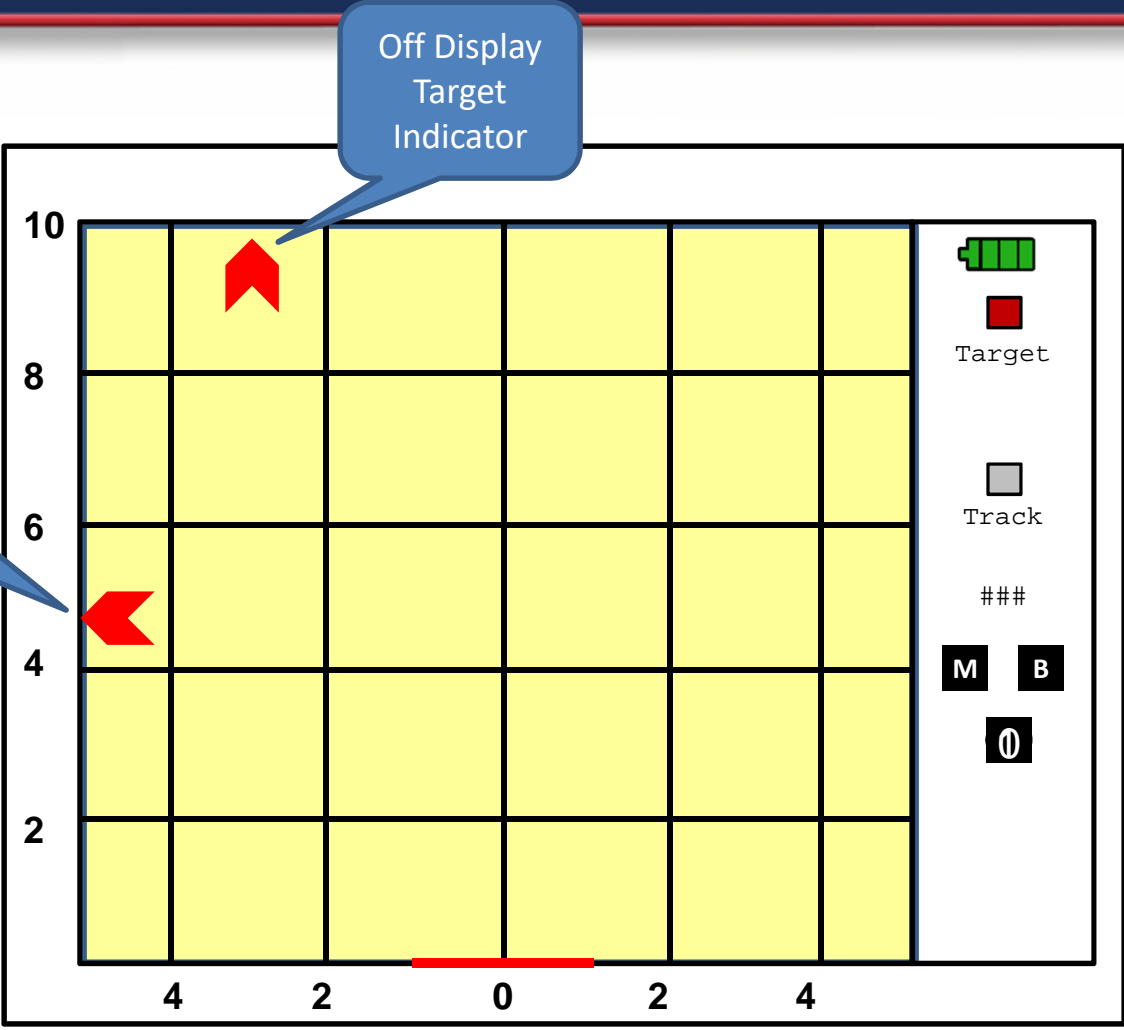

# 5m x 5m DISPLAY ZOOM

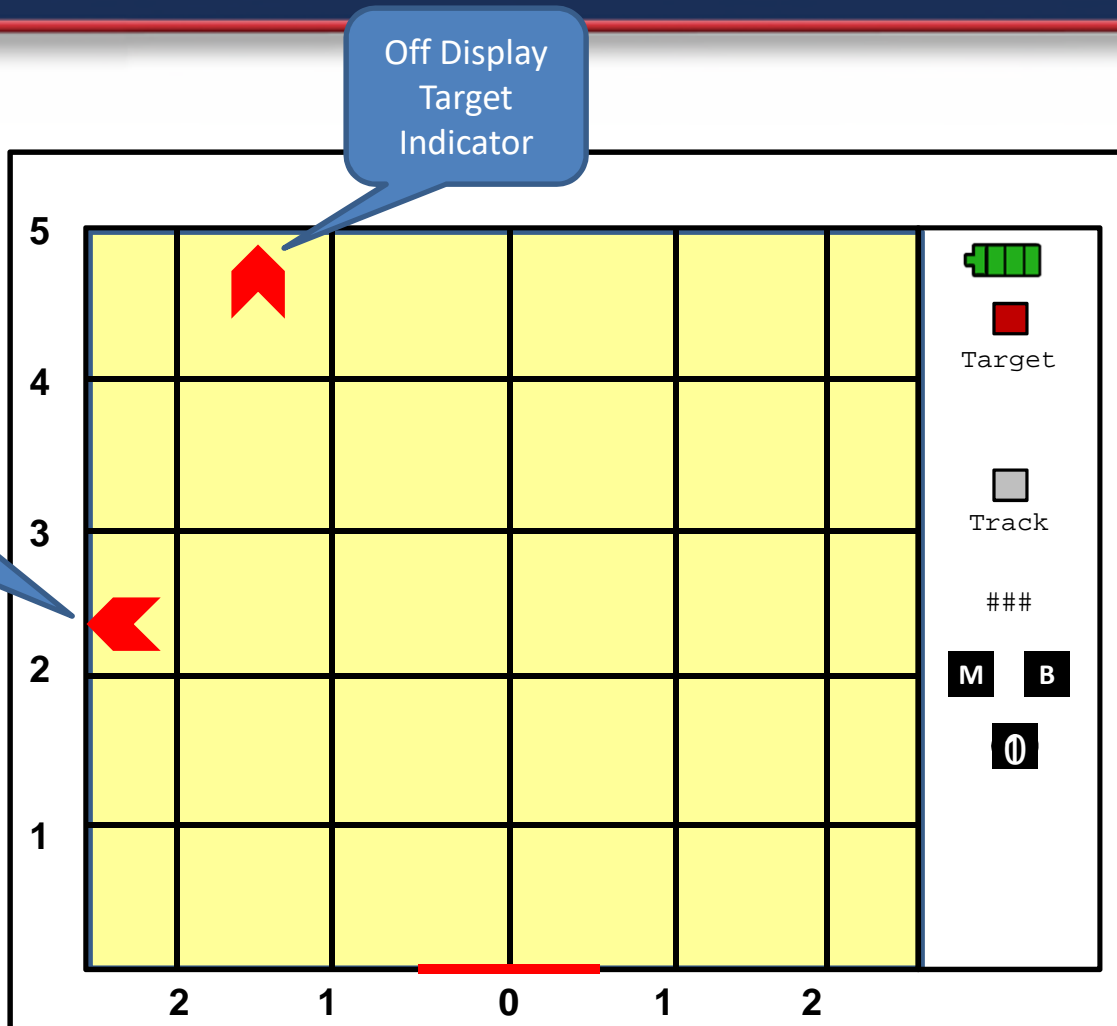



# INSTRUCTION POINTS

- Whenever the system is not functioning properly, yet is still able to boot up, the message “RETURN TO DEPOT” will appear.
- If this happens, shutdown the system, wait 10 seconds, and restart the system.
- Ensure the batteries are fully charged and installed properly.
- If the “RETURN TO DEPOT” message occurs again, the operator should have the system serviced as soon as possible.

# SYSTEM FAULT



- Shut down the sensor
- Power on the sensor
- If problem continues send for maintenance

# INSTRUCTION POINTS

- Wall blockage occurs when a large reflective object obscures the view of the target area. The reflective object may be within the wall itself or in close proximity to the wall. The RANGE-R2D sensor alerts the operator if such a condition exists.
- Since it is possible that the transmit signal is being blocked and not reaching potential targets, target detection is not possible when blockage is detected.
- While operating in Scan Mode and with blockage detected, the word “Blocked” will be displayed. If this occurs, the operator should move to a different spot on the wall and try again.
- In some situations, a blockage alert indication may not occur even though the signal is blocked. One such blockage could manifest if the system is held up directly against a metal door or wall.
- In this situation, the transmit signal is completely blocked and little to no energy reaches the receive antenna. Because the power threshold for a blockage signal will not be exceeded, no alert is generated. Another scenario occurs when the wall material is highly absorptive. Here, signal returns from the obscuring object are greatly reduced by losses in the wall. The power threshold for a blockage signal is not exceeded and no alert is generated.



# FRONT BLOCKED

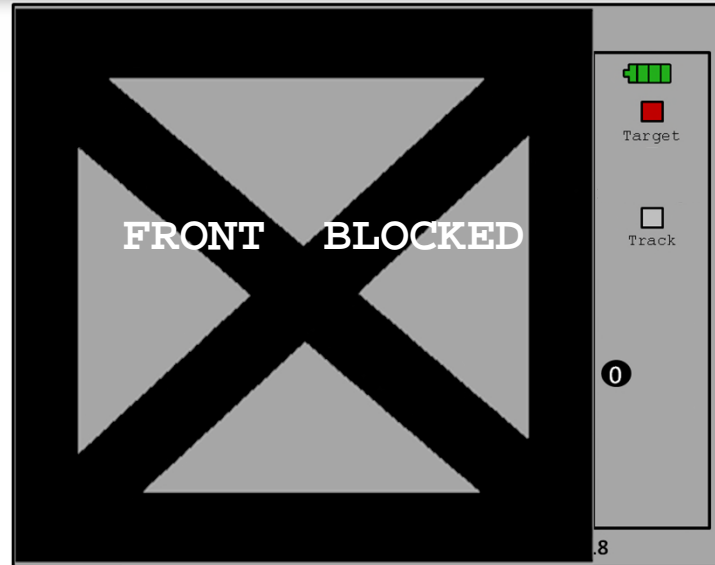

- Attempt to scan in a different area
- Consider construction materials
  - Saturated, porous materials
  - Metal

# INSTRUCTION POINTS

- There may also be cases where the system is receiving outside interference causing it not to function as intended. In this case, the message “JAMMED” will appear on the screen letting the operator know there is a problem.
- While operating in Scan Mode and with strong interference detected, the display will show the message “JAMMED”. Move to a different spot on the wall where the interference may be lower. If the “JAMMED” indication persists, the system cannot be used until the interference source ceases operation.
- Multiple systems working in close proximity may cause the system to display the “JAMMED” message.

# JAMMED

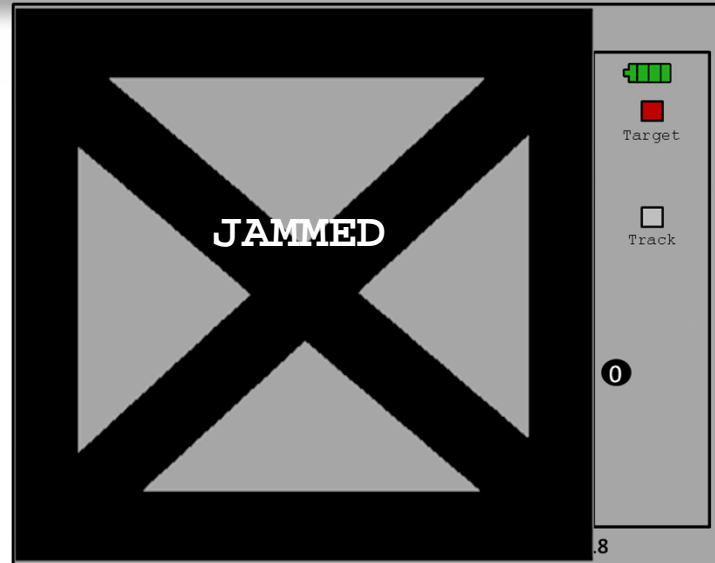

- Outside interference is preventing scanning
- Consider other equipment being used by your unit
- Consider equipment being used by adjacent units
- Consider enemy/local capabilities
- Multiple systems working near each other

# INSTRUCTION POINTS

- Describe the different Battery Status Indicators
- **FULL BATTERY** – The battery voltage is sufficient to provide full operational performance.
- **LOW BATTERY CAUTION** – The battery voltage is beginning to get low, but will continue to function normally. The operator should consider replacing the batteries when only 2 bars are illuminated.
- **LOW BATTERY WARNING (Flashing)** – The battery voltage is too low to continue operation. The operator must replace the batteries. The sensor will shut down 30 seconds after the flashing starts.

# BATTERY STATUS INDICATORS



**FULL BATTERY** – The battery voltage is sufficient to provide full operational performance.



**LOW BATTERY CAUTION** – The battery voltage is beginning to get low, but will continue to function normally. The operator should consider replacing the batteries when only 2 bars are illuminated.



**LOW BATTERY WARNING)** – The battery voltage is too low to continue operation. The operator must replace the batteries. Icon goes red with 30 minutes of battery life, flashed at 30 seconds of life. The system will shut down after 30 seconds.

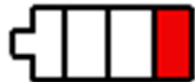



# LESSON 3

## Factors Affecting Detection

# USING A MOTION DETECTOR

**The purpose of this section is to make the user aware of phenomena that can affect the performance of radar based sensors in general, and phenomena that can affect the RANGE-R2D specifically.**

**These phenomena do not affect every usage of the sensor or every venue where it may be used, but they are factors the operator needs to be aware of to maximize the effectiveness of the system.**

# USING A MOTION DETECTOR

## Factors that can cause unwanted detections (False Alerts)

This is a motion detector. It will pick up the movement of any object. This includes but is not limited to:

- Animals
- Friendly personnel (in front or behind the operator)

The system target acquisition algorithm is designed to negate the following, but these items may still appear as targets:

- The movement of trees and foliage caused by the wind
- Oscillating fans (inconsistent circular patterns)
- Vibrating equipment (duct work, compressors, etc)

Any of these moving objects, and others, may appear as targets on the display. There is no way for the operator to determine this “clutter” from an actual target.

# USING A MOTION DETECTOR

## Factors that can cause missed detections

**Environmental factors can create a “noisy” Doppler environment and can make it more difficult for the sensor to detect the targets of interest:**

- Ceiling fans can create a Doppler signal in their immediate vicinity of greater strength than that of a stationary target, potentially causing the target of interest in the same immediate vicinity to not be detected.
  - RANGE-R2D looks for the unique ceiling fan signature and alerts the operator that it's present, indicates its location, and shows the estimated area where detection may be affected as a shadowed area on the display.
- Fluorescent lighting also creates a strong Doppler signature that can have an effect more so on moving targets, if their movement speed aligns with a Doppler frequency given off by the lights.
  - RANGE-R2D looks for the signature emitted, and alerts the operator to ensure they are aware reduced detection performance may occur.

# INSTRUCTION POINTS

- Radar will not penetrate metallic surfaces. Should you try to scan over a metallic surface the “Blocked” screen appears. In this instance you should attempt to rescan in an attempt to find a less metallic area.
- Metal plate is the most likely to give you problems.
- The sensor will be able to “see” through rebar reinforced concrete.

# BUILDING MATERIALS

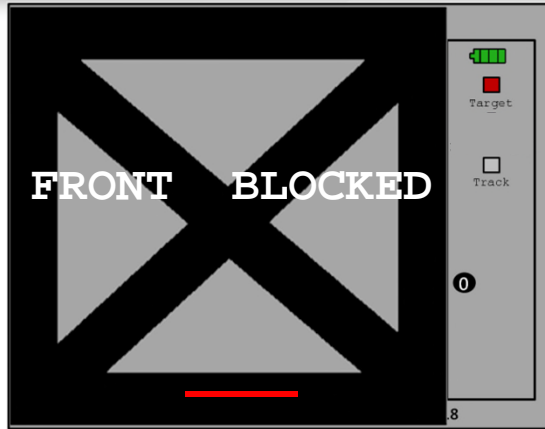

## Metallic Surfaces and Objects

- Sensor can not penetrate metal surfaces
- Move sensor and attempt to rescan
- Metallic surfaces behind non-metallic surfaces could also block the system (refrigerator, file cabinet).

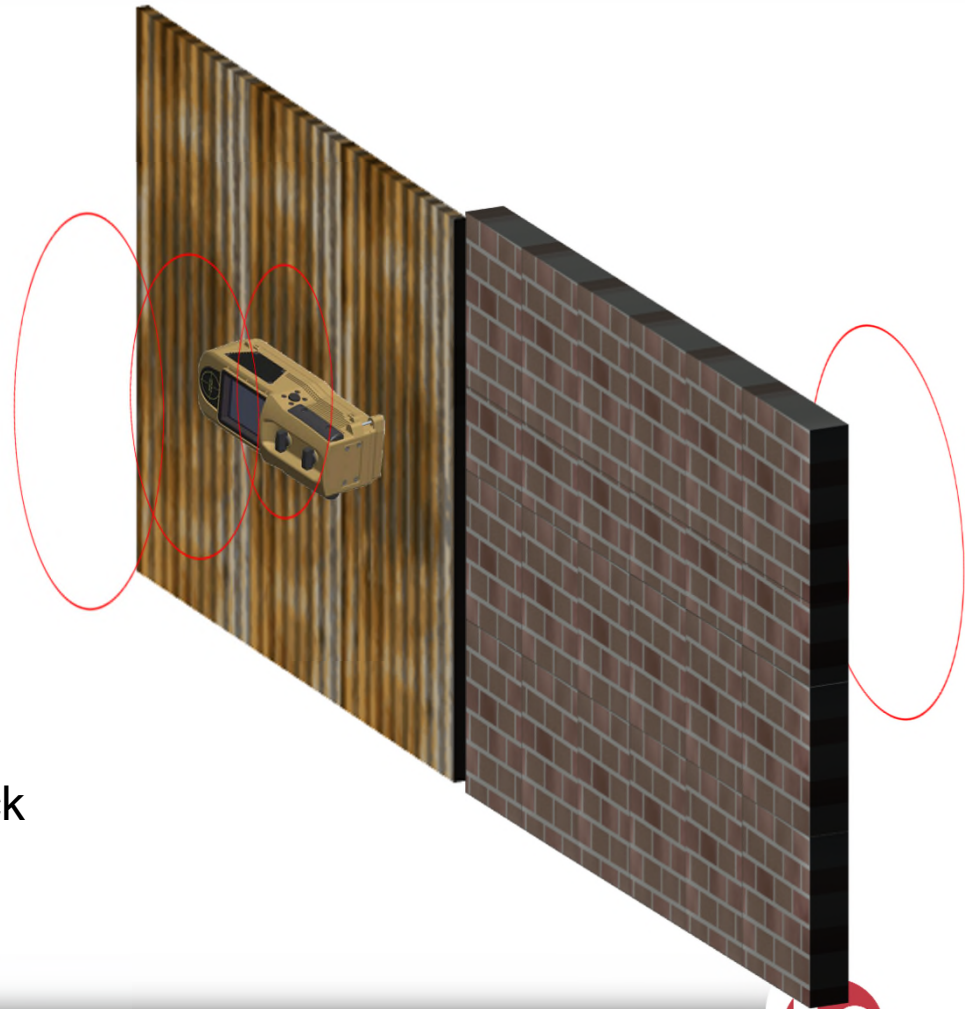

# UNDETECTED FRONT BLOCK

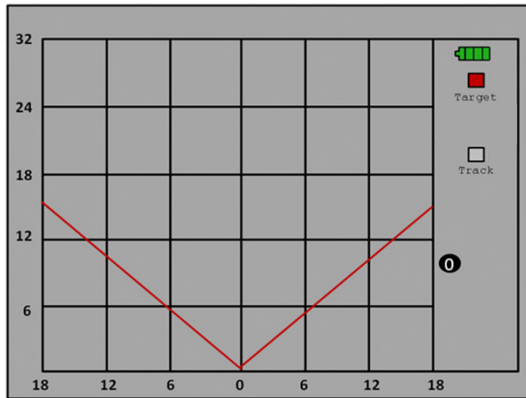

## Unseen obstructions

- Metal objects behind the wall can block the signal from the radar.
- Because there is space between the system and the metal, the blocked warning may not be detected.

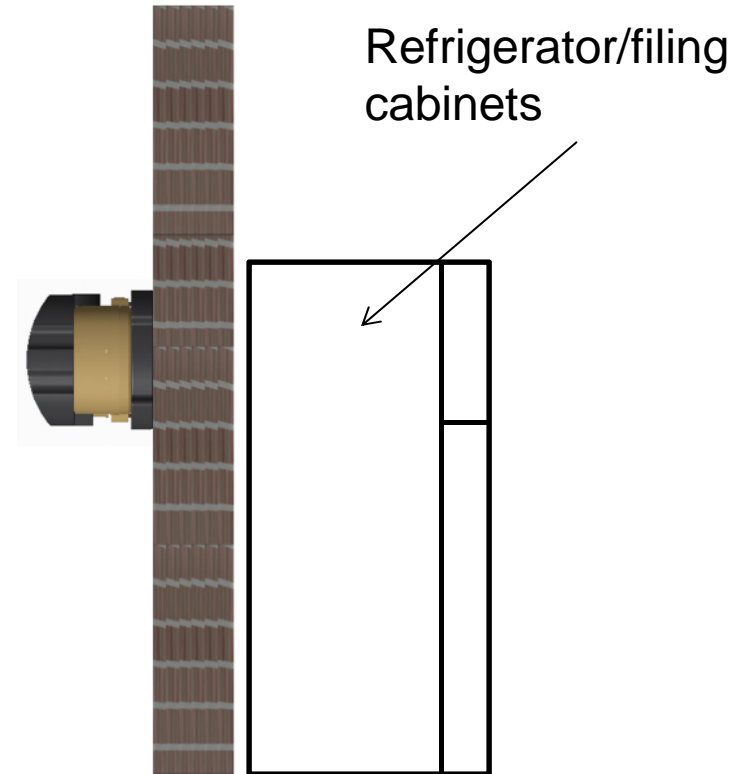

# BUILDING MATERIALS

## Concrete Block

The spaces in concrete block walls can cause some reduction in detection ability



Scanning with the system between two blocks may reduce the effectiveness of the system.

Attempt to scan with the system over one block only.



# BUILDING MATERIALS

Moisture content of the structure being scanned will affect the systems ability to “see” through the walls. If the surface is saturated, the system may not be able to detect targets at all.

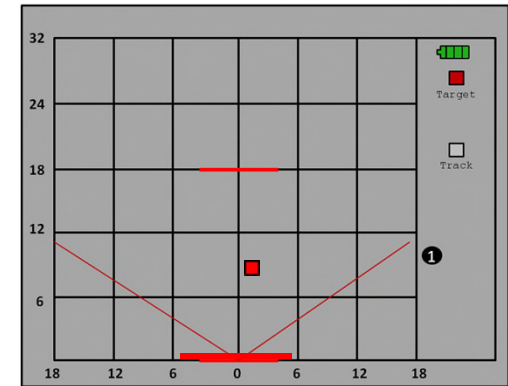
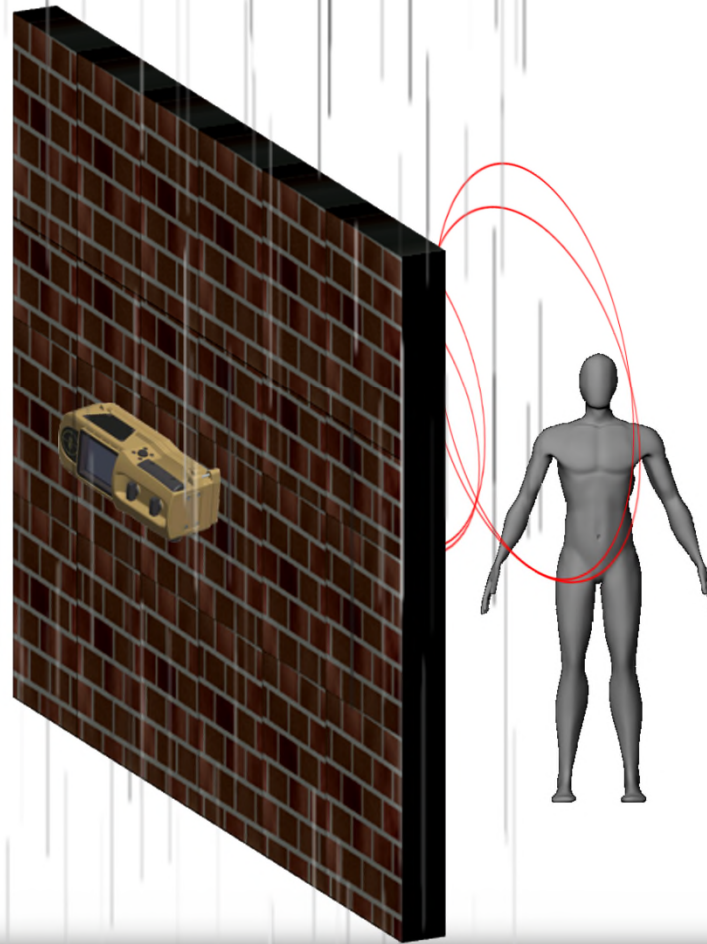

The amount of moisture will affect the systems detection capability. The more moisture present, the less detection capability is available.



# OPERATOR INDUCED ERRORS

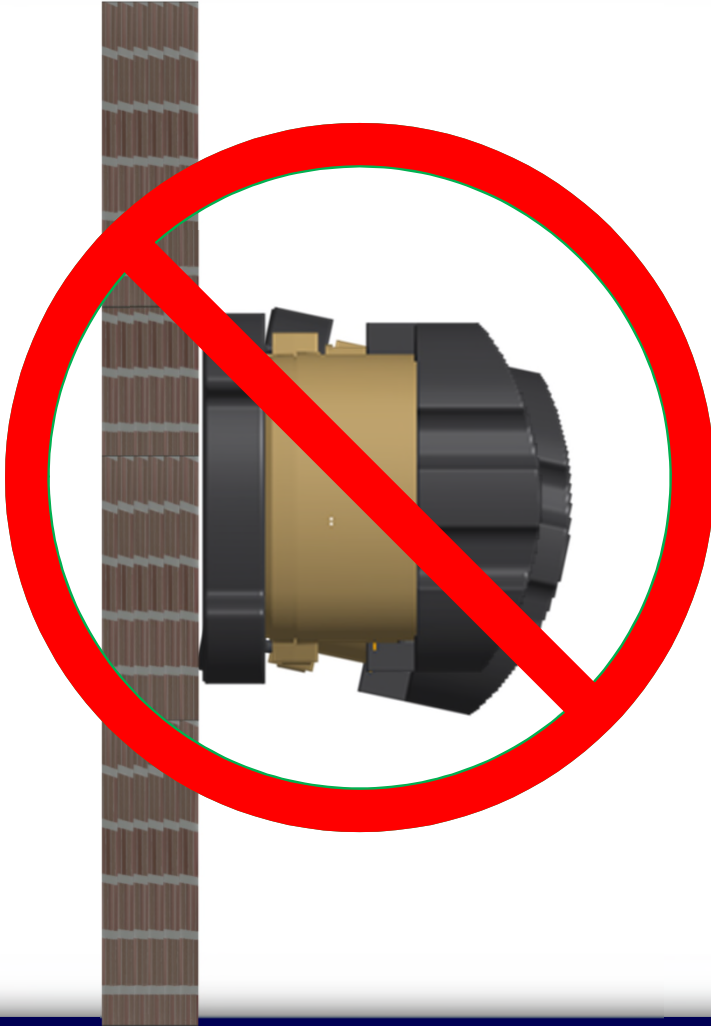

When scanning against the wall, ensure that system is flush to the surface being scanned and being held to eye level.

Begin scanning only after you have set the system in place.

# OPERATOR INDUCED ERRORS

As the operator you can diminish the systems ability to detect objects. The system should be held so the operator's hands do not interfere with any of the system's antennas.

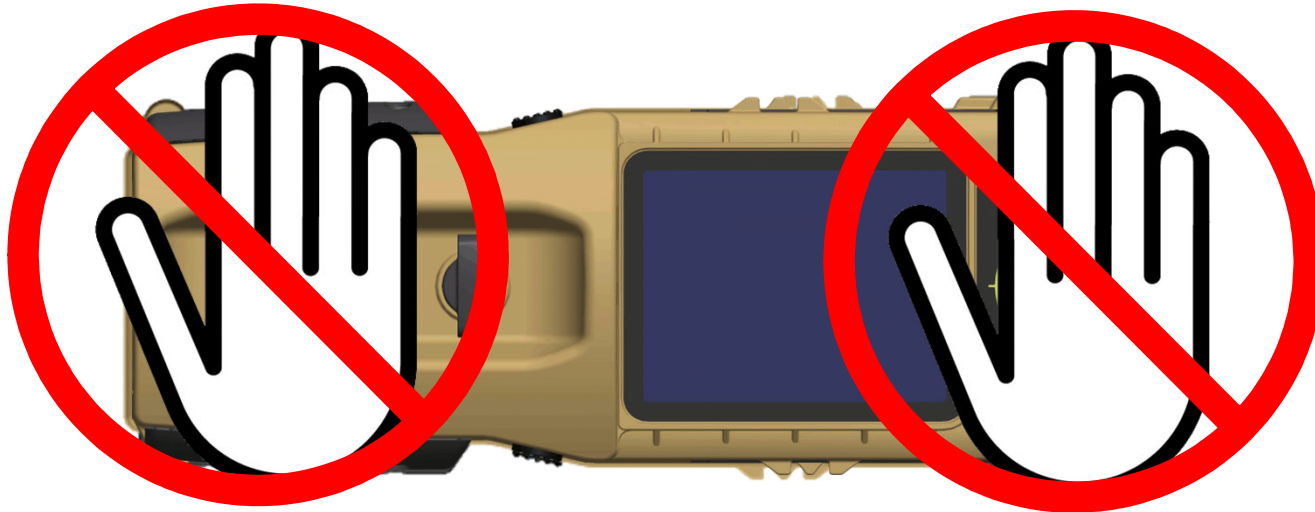

**Bumpers removed for clarity**

Do not block the rearward looking antenna.

Do not block the front looking antennas.

# INSTRUCTION POINTS

- Movement from the operator, teammates, and the operator moving the sensor itself can all affect what is/isn't detected by the system. The movement indicator on the bottom right corner of the LCD lets the operator know if he/she is moving the sensor enough to affect detection.
- The sensor should be kept as still as possible when scanning.
- As mentioned earlier **DO NOT BLOCK THE REARWARD FACING ANTENNA** when trying to stabilize the system.

# INSTRUCTION POINTS

- The sensor will also indicate areas of possible reduced detection by showing those areas as shaded on the display.

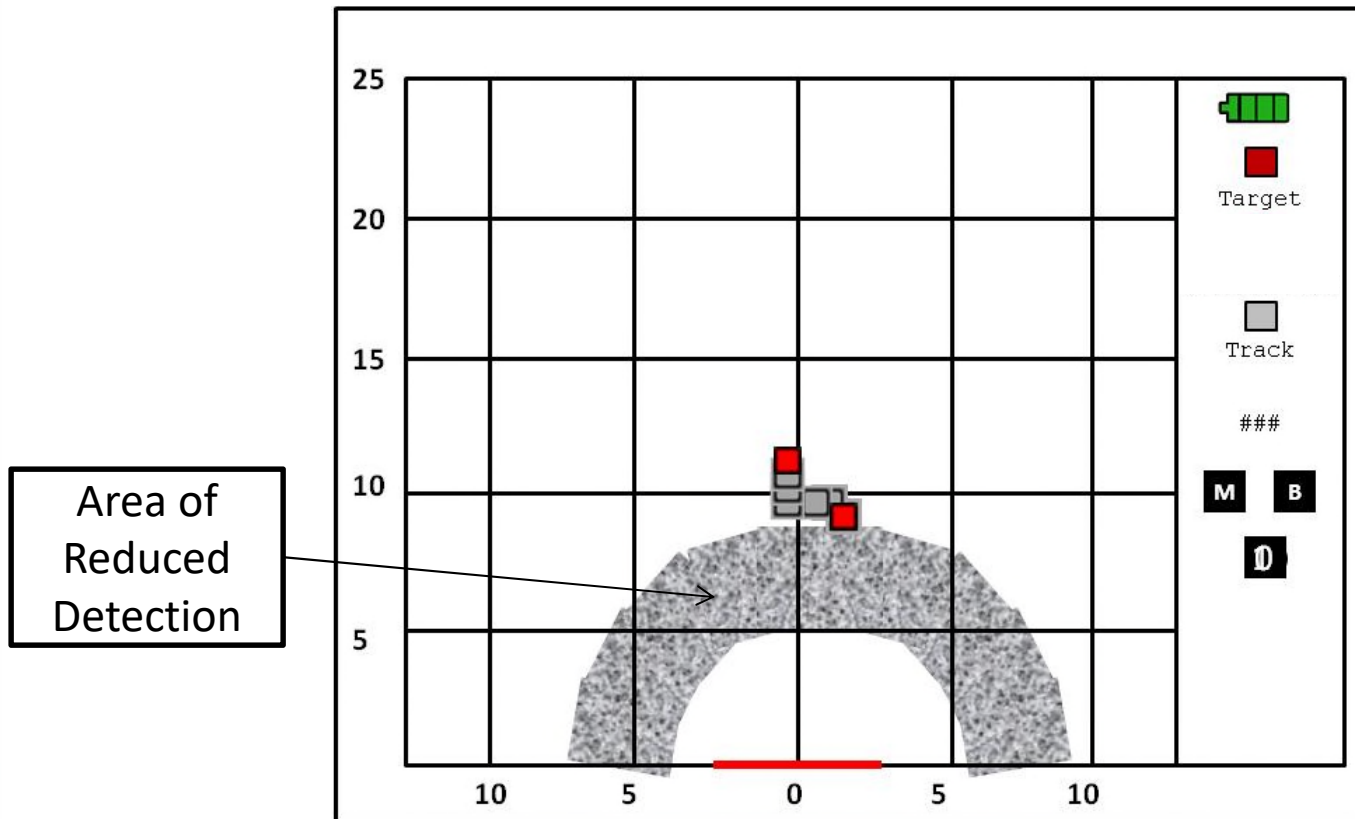

# INSTRUCTION POINTS

- The movement from ceiling fans can cause the noise level the radar sees to be too high for stationary target detection in the area under and adjacent to the fan. The RANGE-R2D can detect the unique signature of a ceiling fan and will show the operator where it's located so they can be aware of the area of reduced detection.

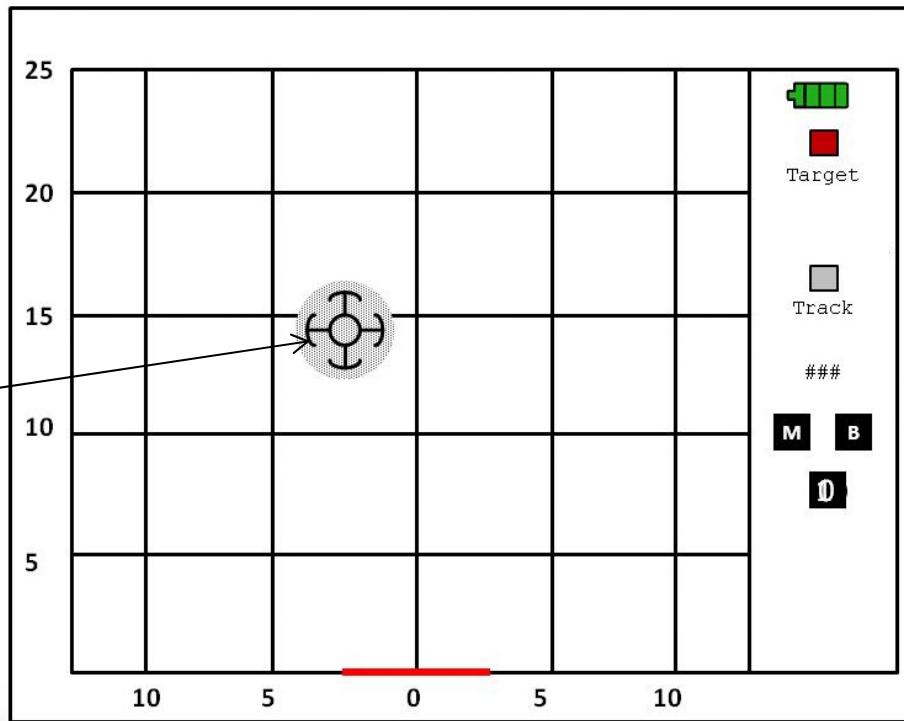

Area of Reduced Detection

# INSTRUCTION POINTS

- The movement from ceiling fans can cause the noise level the radar sees to be too high for stationary target detection in the area under and adjacent to the fan. The RANGE-R2D can detect the unique signature of a ceiling fan and will show the operator where it's located so they can be aware of the area of reduced detection.

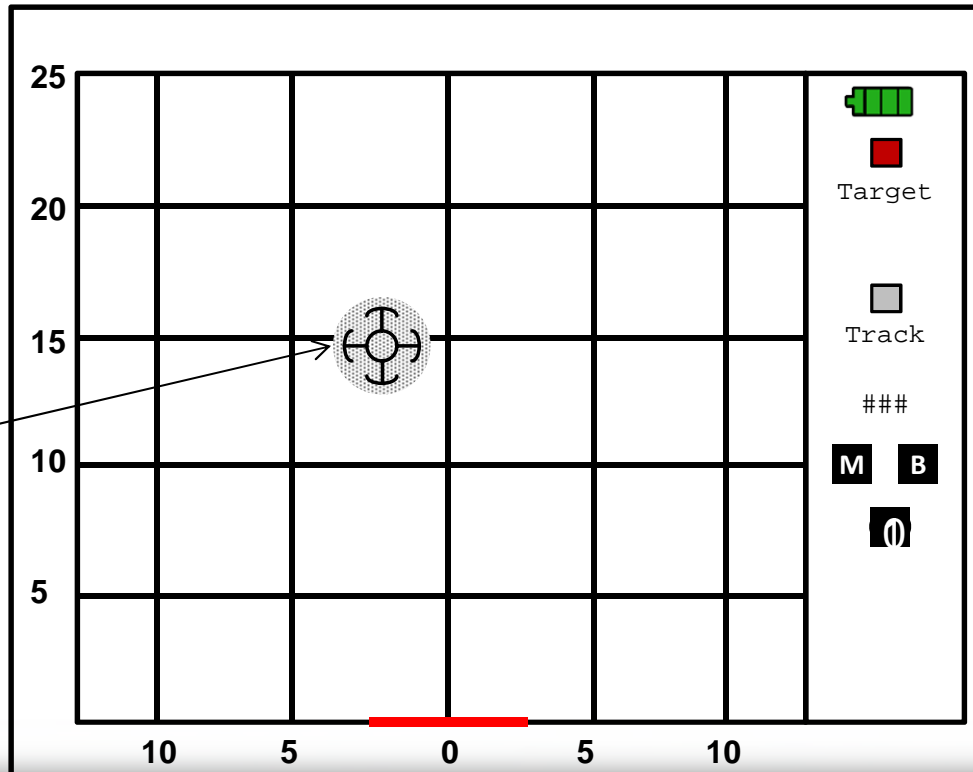

# INSTRUCTION POINTS

- The electronic signature emitted by fluorescent lighting can cause areas of reduced detection. The RANGE-R2D can detect the unique signature of fluorescent lights and it alerts the operator that it's present and detection may be reduced.

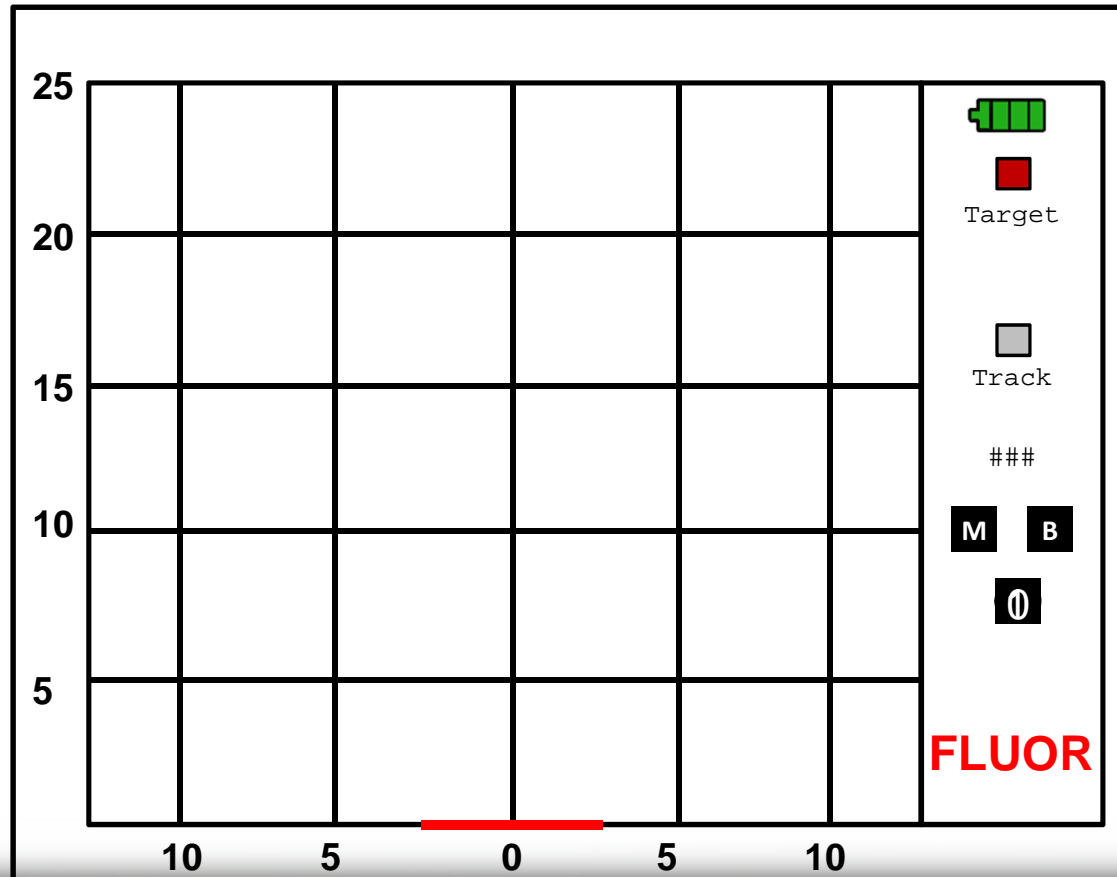



# OPERATOR INDUCED ERRORS

## Operators Effect on the System:

The operator should remain as still as possible. This is especially important when the sensor is being used in standoff from a wall. The system will display no new information while the Operator Movement Indicator is displayed.

If the Operator Movement Indicator appears, first attempt to stabilize the system.

If the indicator persists, attempt to rescan.

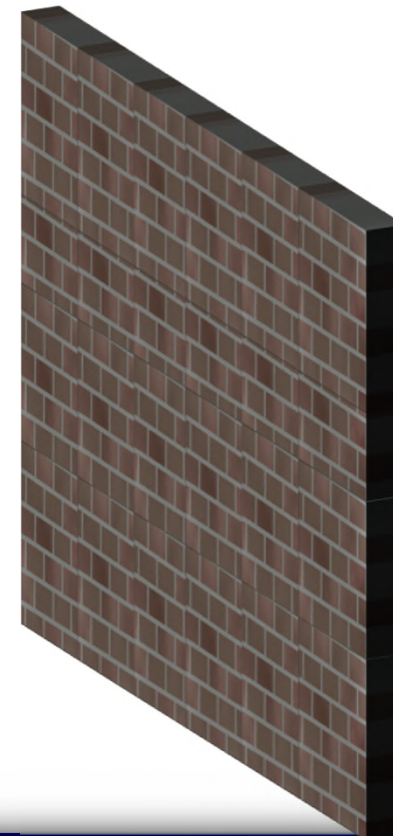
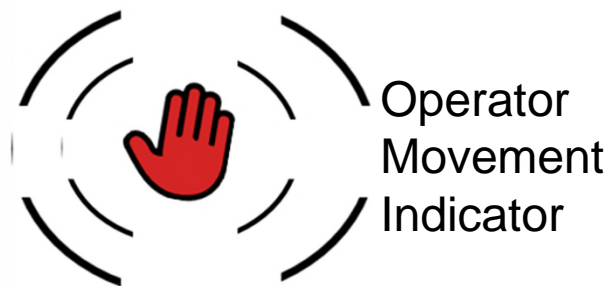

# INSTRUCTION POINTS

- Part of the radar energy emitted by the sensor penetrates the building and part reflects off the building back in the direction of the sensor.
- The energy reflected off the building can reflect off moving objects behind the sensor and back to the sensor in a path that makes movement behind the sensor look like it is actually in front of it.
- If the movement behind the sensor is at the same range as the target inside the building is from the first wall of the building, this energy competes with the energy of the target.
- The more closely grouped personnel are to the sensor, the smaller the area affected by their movement.
- The sensor has a rear looking antenna and software algorithms that detect movement behind the sensor and remove the unwanted energy, but if the backside energy is much greater than the target energy, the target may be cancelled also.
- The operator and any personnel behind the sensor should remain still during scanning.



# BACKSIDE TARGETS

## WARNING

The energy from personnel moving behind the sensor may prevent detection of targets

To help prevent this, the system will warn you that there is too much motion being detected on the operator's side of the system by displaying the Excessive Backside Motion Icon.

In some cases the Backside Motion Indicator will not appear and backside targets could appear as targets in your target area.

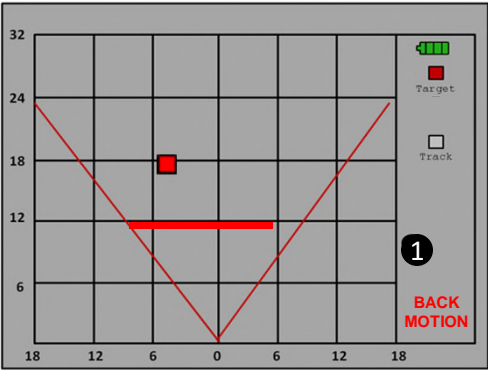
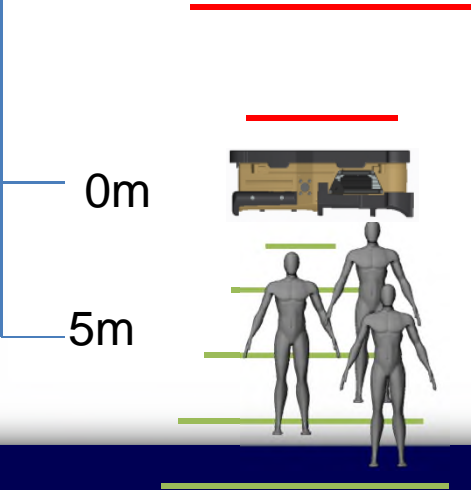
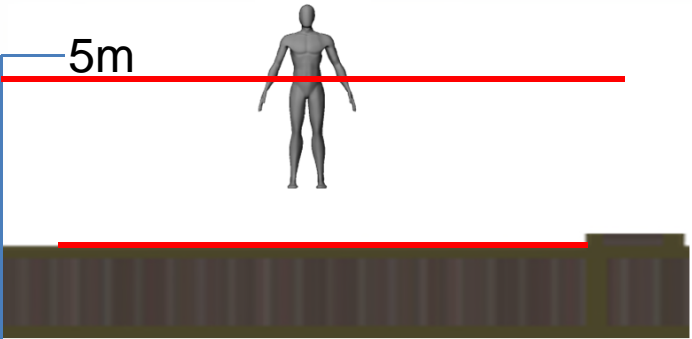

# REDUCED BACKSIDE DETECTION

The operator may reduce the effectiveness of the rearward looking antenna's ability to reduce backside motion if the antenna is blocked by the operators body

This reduced area will move based on how the system is held by the operator



No reduction

No reduction

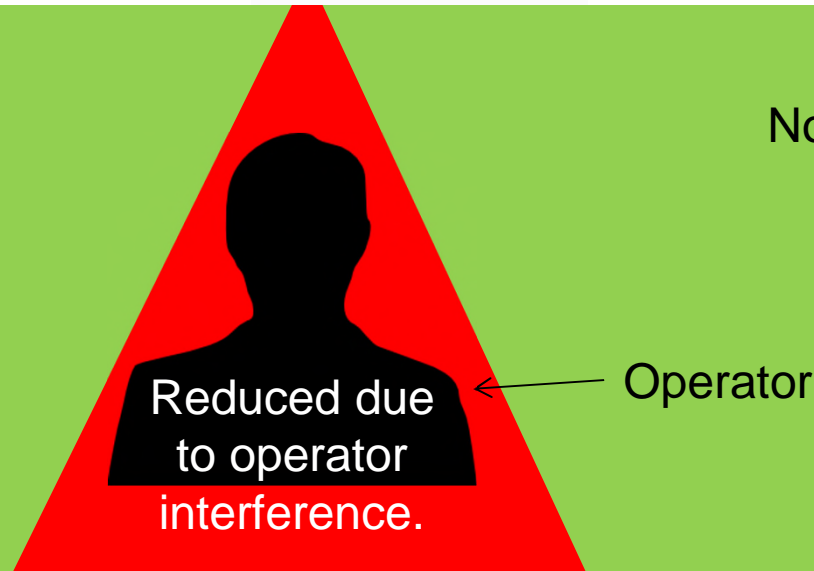

# INSTRUCTION POINTS

- Part of the radar energy emitted by the sensor penetrates the building and part reflects off the building back in the direction of the sensor.
- The energy reflected off the building can reflect off moving objects behind the sensor and back to the sensor in a path that makes movement behind the sensor look like it is actually in front of it.
- If the movement behind the sensor is at the same range as the target inside the building is from the first wall of the building, this energy competes with the energy of the target.
- The more closely grouped personnel are to the sensor, the smaller the area affected by their movement.
- The sensor has a rear looking antenna and software algorithms that detect movement behind the sensor and remove the unwanted energy, but if the backside energy is much greater than the target energy, the target may be cancelled also.
- The operator and any personnel behind the sensor should remain still during scanning.



# ENVIRONMENTAL TARGET MASKING

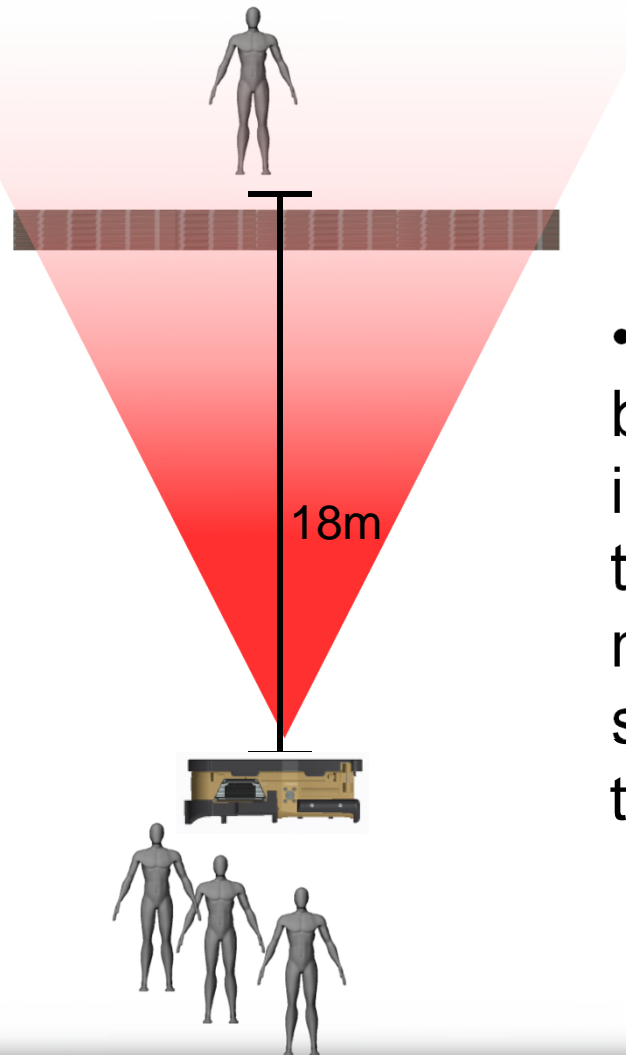
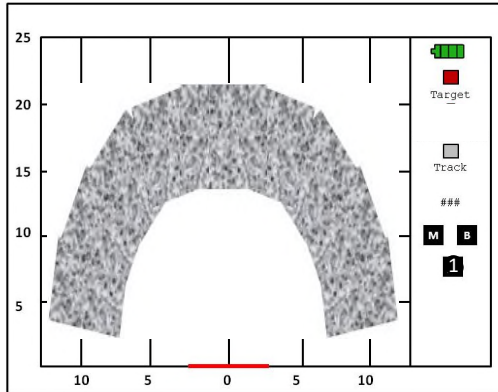

- The sensor detects backside motion and indicates the area in the field of view that may be impacted by shading that area on the display.

# MULTIPLE TARGETS



Targets may be too close to be represented by individual target icons. The multi target icon (red square) is used in these situations.

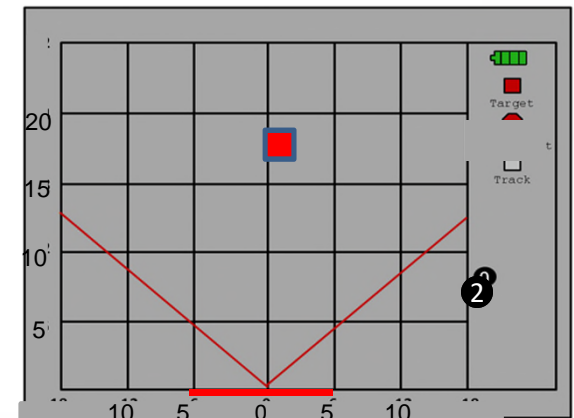
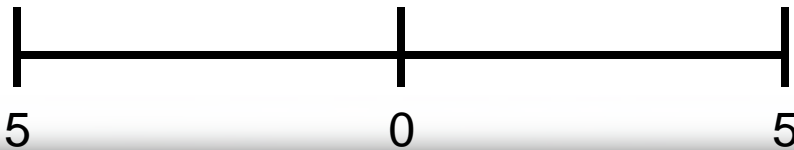

# LARGE TARGETS

Larger targets may appear to travel in an arc when they pass in front of the system. This is because of their large radar cross section.

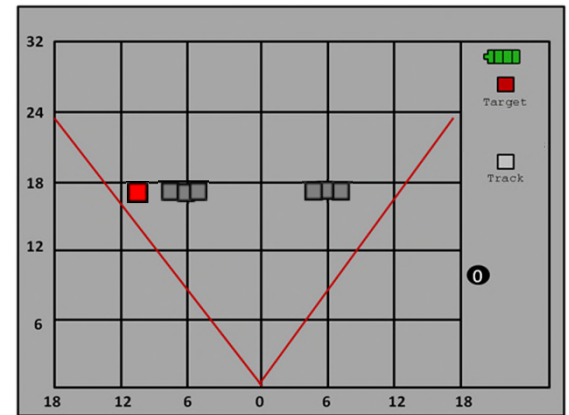
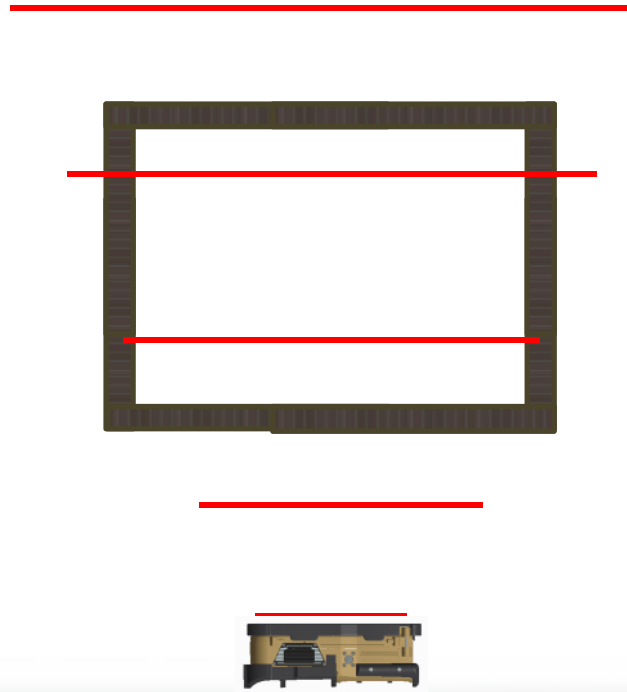



# INSTRUCTION POINTS

- The best detection performance occurs directly in front of the unit, and extends out  $\pm 60$  degrees in a conical pattern.
- The detection performance rapidly falls off to a minimum at  $\pm 90$  degrees, creating blind spots. Detection is possible within these blind spots, but will be greatly reduced.
- The optimal detection distance is a maximum of 25 meters but this may vary based on the type of wall construction.
- Detection through multiple walls or even an entire building is possible depending on the construction materials of the wall within the structure, however detection performance is diminished when traveling through additional walls such as interior cinder block or concrete walls.
- Stationary targets detection will diminish more rapidly than moving target detection.
- The sensor always assumes it is against the wall of the structure and shows the first wall at zero range. The 2<sup>nd</sup> wall is shown at the distance estimated by the sensor.



# FACTORS EFFECTING DETECTION

## Areas of Reduced Accuracy in the Field of View.

The best detection performance occurs directly in front of the unit, and extends out  $\pm 60$  degrees in a conical pattern. Detection performance rapidly falls off to a minimum at  $\pm 90$  degrees, creating blind spots. Detection performance may be diminished because of construction material and the number of walls in the detection range.

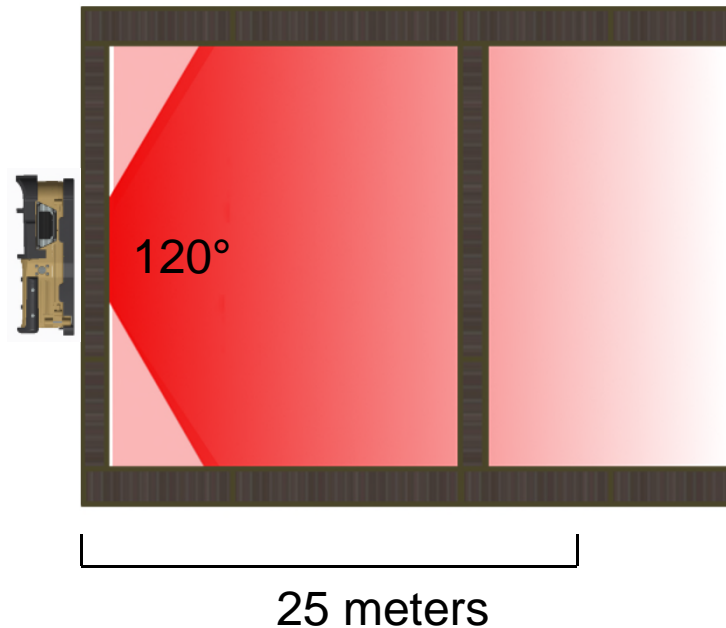

Probability of Detection

# INSTRUCTION POINTS

- Multiple scans performed at set intervals along the wall or adjacent walls of the same room will increase area coverage and increase your probability of detecting targets.
- By performing these extra scans, the amount of area with diminished detection performance is drastically reduced.
- The number and amount of times scanned will be determined by the operator.

# WALL DETECTION

- Walls less than one meter apart will not be counted as two walls.
- If the second wall is greater than 10 meters away it will not be displayed on the readout

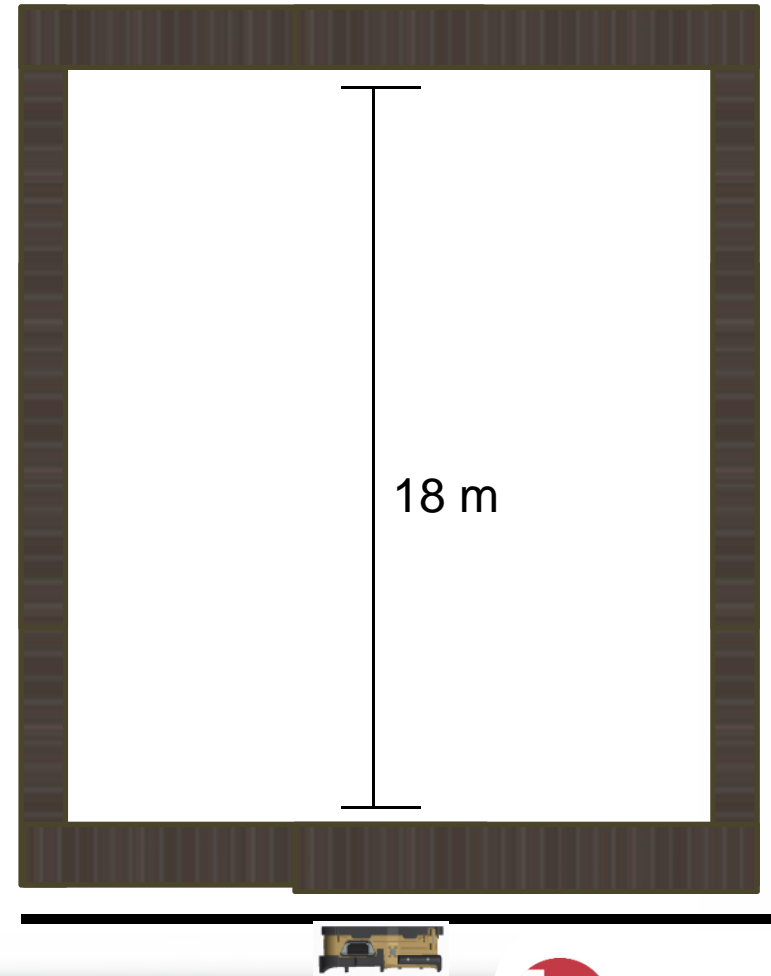
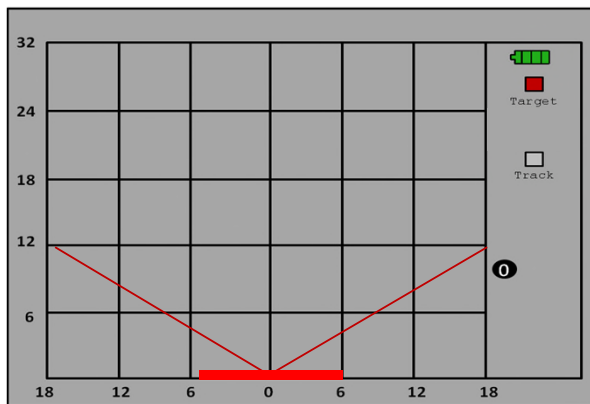

# FACTORS AFFECTING DETECTION

## Area Coverage.

Multiple scans performed at set intervals along the wall or adjacent walls of the same room will increase area coverage and increase your probability of detecting targets.

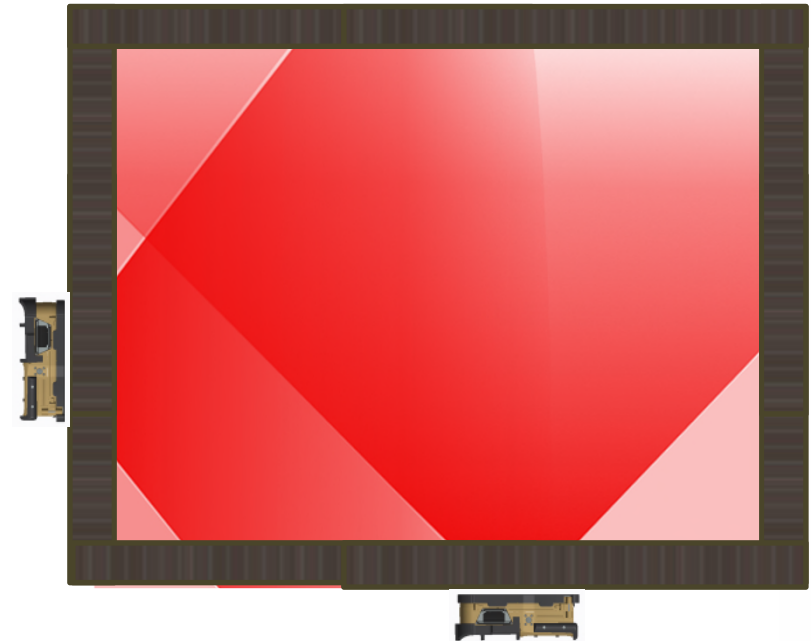

Probability of Detection

# INSTRUCTION POINTS

- The RANGE-R2D is also capable of detecting targets on different floors within a building if the targets falls within the field of view of the system.
- Operators will not be able to determine precisely which floor is producing the alert.
- Detection performance may diminish when travelling through the ceiling or the floor of the structure based upon types of material encountered.

# FACTORS EFFECTING DETECTION

## Multi-level Structures.

When scanning a multiple level structure, personnel on different levels may be detected if the target is within the field of view of the system.

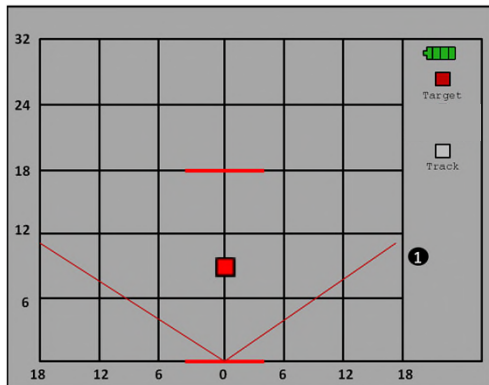

Probability of Detection

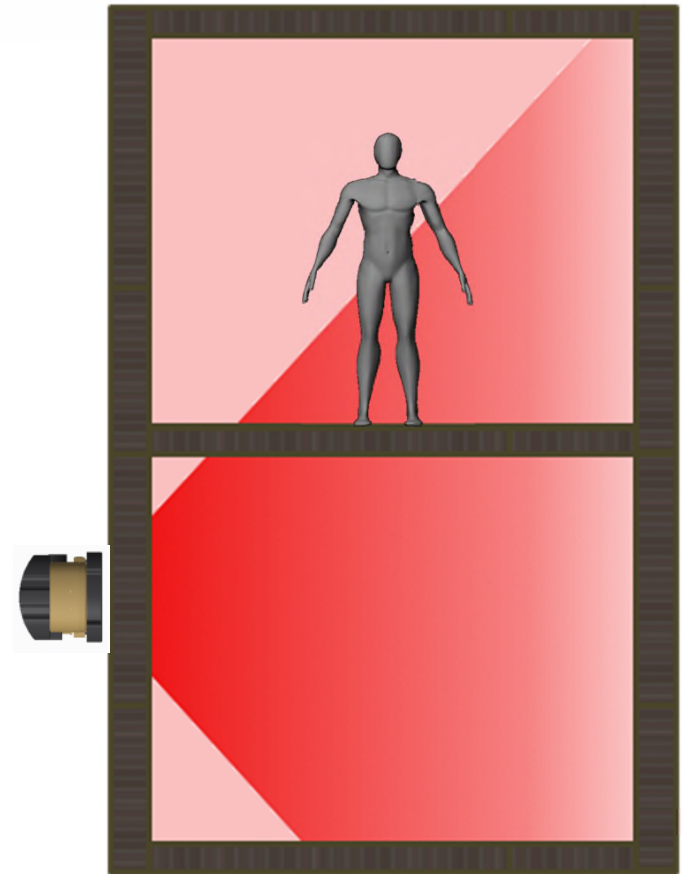

Two Story Building

# ENVIRONMENTAL TARGET MASKING

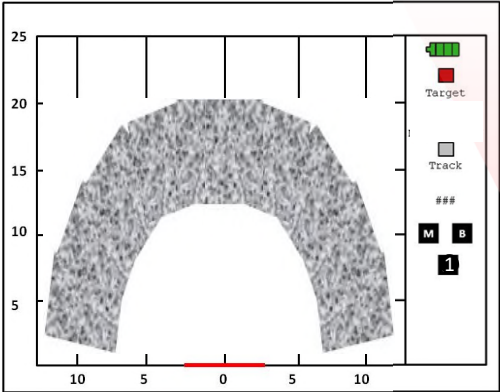

- Breathers could be masked by environmental factors.
- The sensor detects this and indicates the area in the field of view that may be impacted by shading that area on the display.

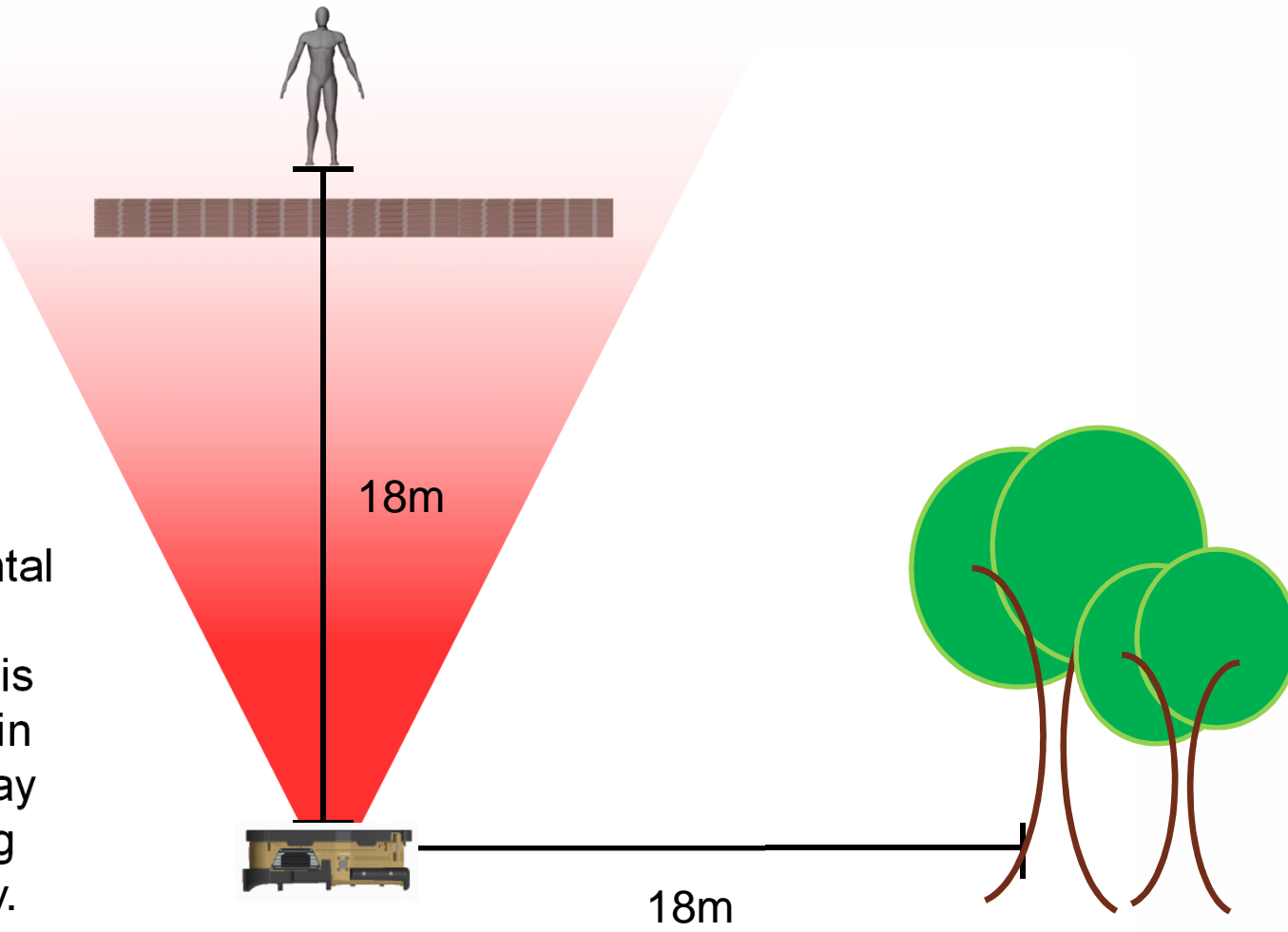



# INSTRUCTION POINTS

- If necessary or desired, the system can be used in standoff away from a wall. The system will still display the first two walls within detection range. Keep in mind that the systems range is still 25 meters. If the system is held 10 meters from a wall you will only be able to detect 15 meters past that wall.
- Using the system from a standoff position will be more difficult than operating the system against the wall. The operator must do his best to keep the system steady. The system must be mounted to a tripod for best results. A monopod may be used, but stationary target detection sensitivity may be reduced. If the system is moving too much, the “shaky hand” movement indicator will be displayed on the bottom right hand of the display.
- The sights on the outside of the system above the display (in either left or right handed use) can be used to aim at specific points. The sights are off set from the display opening to ensure that they line up with the center of the actual radar display.



# SCANNING WITH STANDOFF

It is possible for the system to be used away from walls or surfaces to detect targets.

Ensure the distance from the first wall is greater than ½ meter.

Detection of the first wall is critical to operation of the sensor. If the first wall is not shown at correct approximate location, move the sensor enough to bring up the motion indicator. This will reinitiate wall detection.

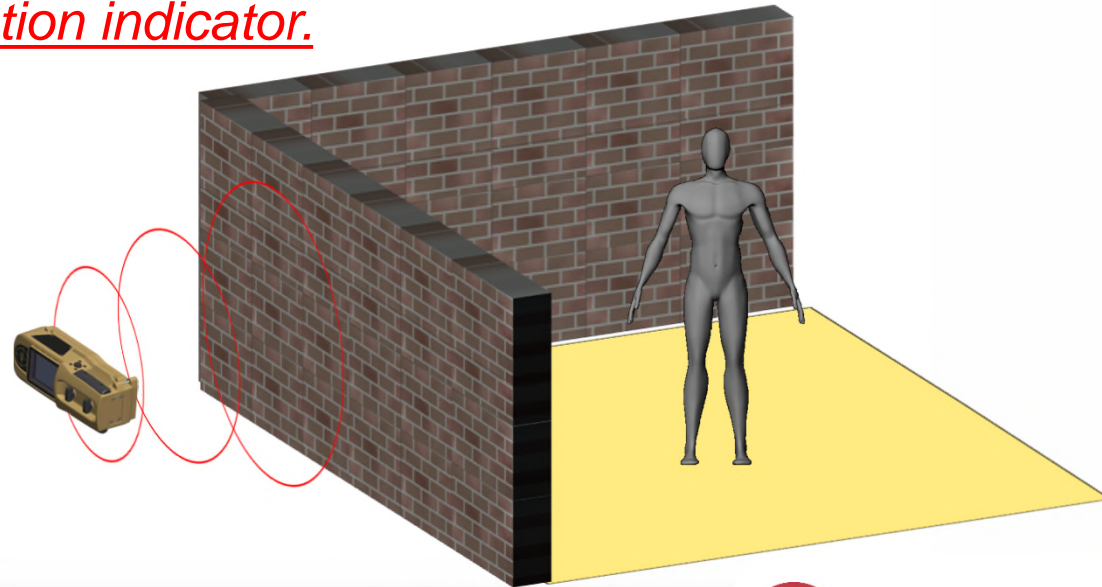
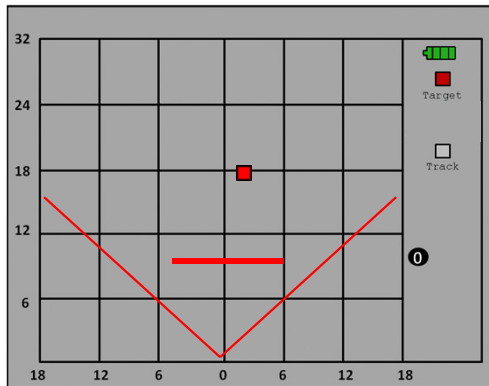

# NARROWED FIELD OF VIEW

To help reduce the risk of false positives when set to Standoff mode, the system will adjust its field of view to 90 degrees. (Field of view is 180 degrees when set to Wall mode.)

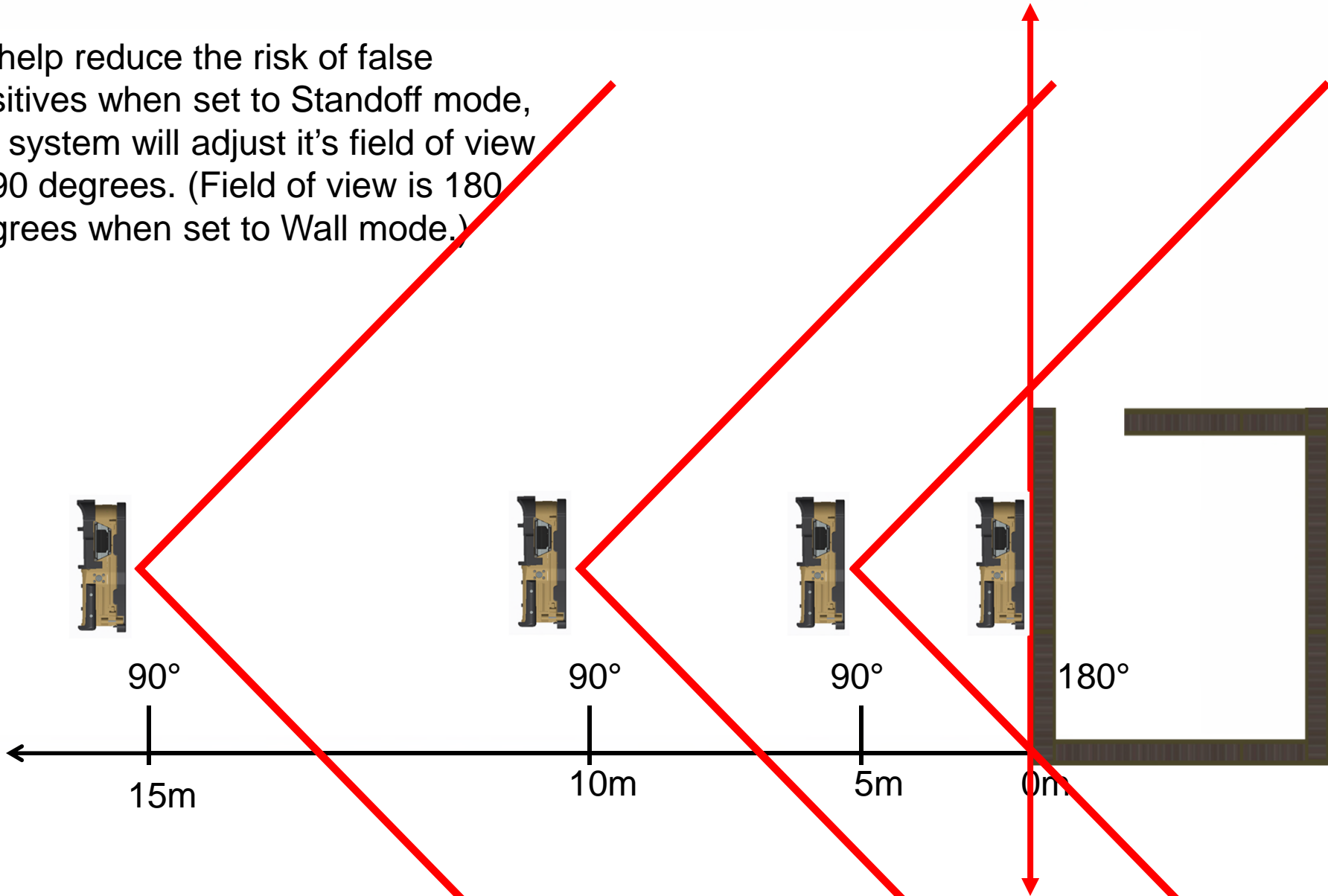

# SCANNING WITH STANDOFF

Aim the system at the structure you intend to scan. Just keeping the system “level” can result in the ground being interpreted as a wall by the system.

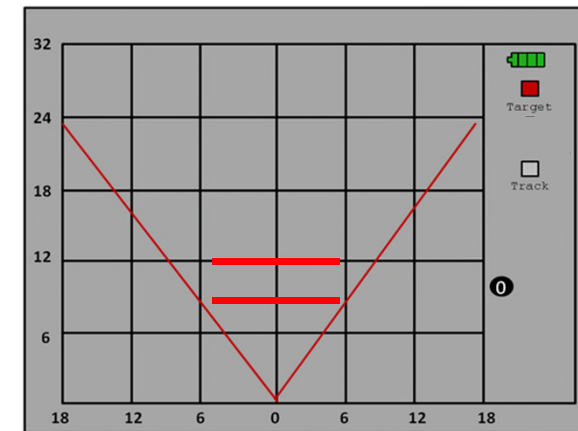
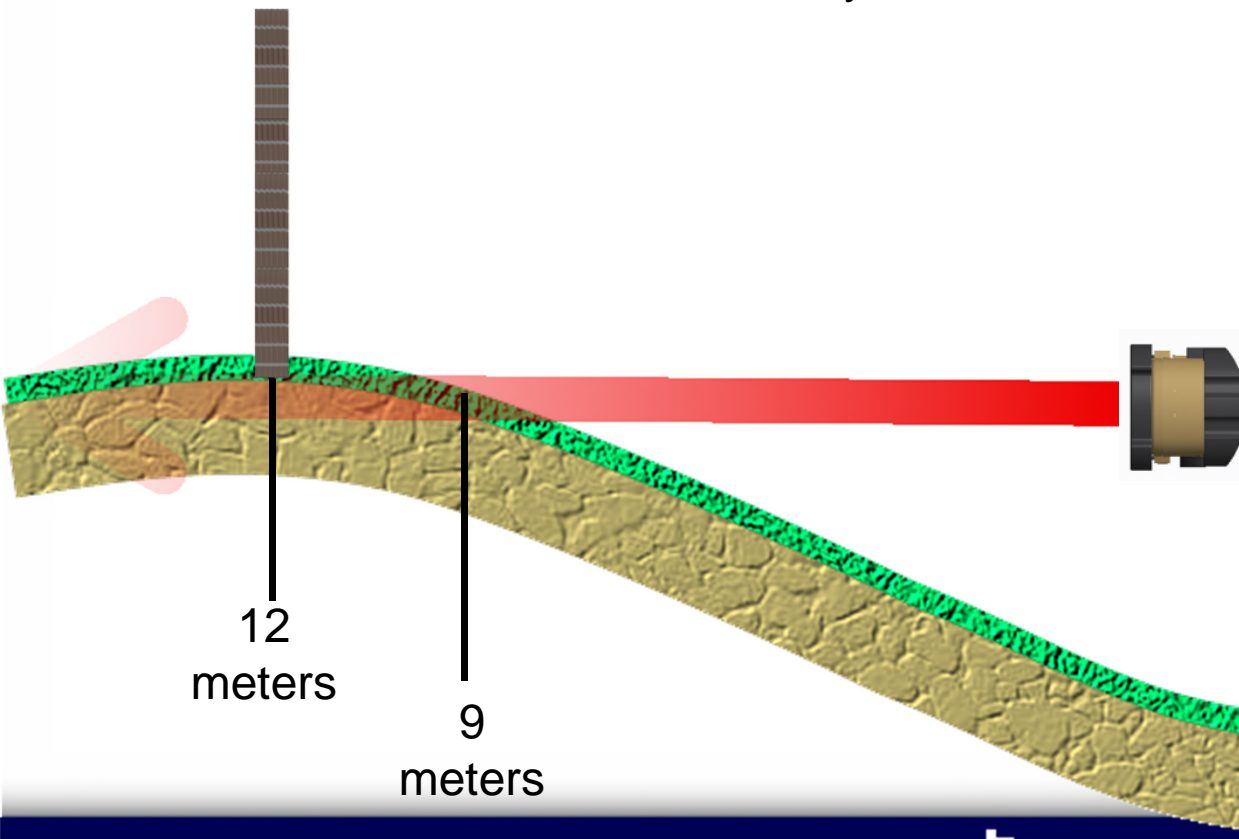

# SCANNING WITH STANDOFF

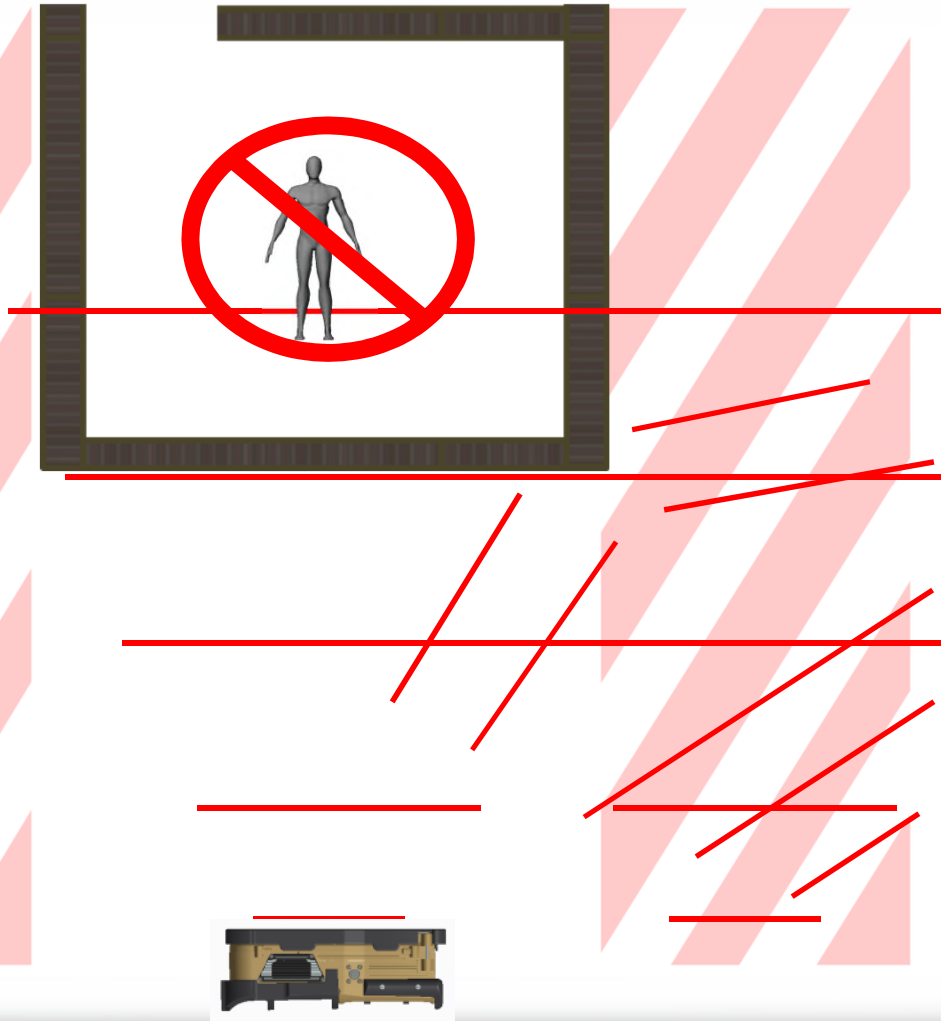

When scanning in standoff mode it is important to be center the system to the structure you are scanning. If you are not centered on the structure when scanning, the first wall may not be detected giving you inaccurate readings while scanning. Scanning from the corners or off angles can reduce the effectiveness of the system.

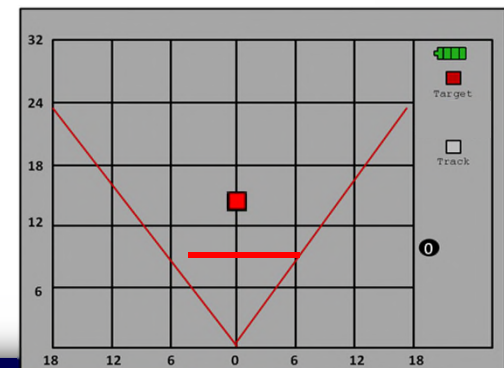

# INSTRUCTION POINTS

- While not the ideal method of operation, the system can be used +/- 10° from parallel of the wall being scanned.
- Using the sensor at a greater angle than 10° from the wall may cause degradation of detection of walls and negatively affect detection of targets.

# SCANNING WITH STANDOFF

## Off-Angle Use

Not the ideal method of operation. Operating the system this way will reduce the effectiveness of the scan.



$\pm 10^\circ$

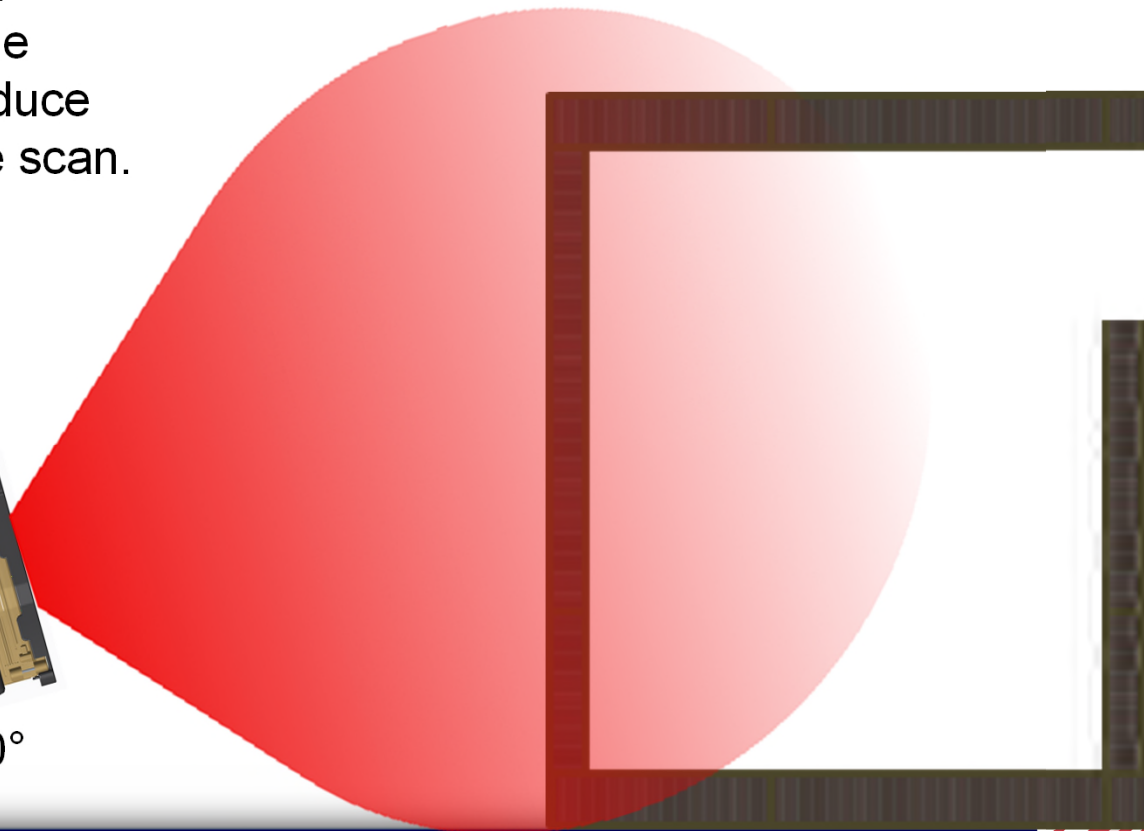

CyTerra

# RANGE-R2D LINK

## ADDENDUM TO RANGE-R2D OPERATION & TRAINING MANUAL





# FCC Required Information

- **Warning:** Changes or modifications to this device not expressly approved by **L-3 CyTerra** could void the user's authority to operate the equipment
- **NOTE:** This equipment has been tested and found to comply with the limits for a Class B digital device, pursuant to Part 15 of the FCC Rules. These limits are designed to provide reasonable protection against harmful interference in a residential installation. This equipment generates, uses, and can radiate radio frequency energy and, if not installed and used in accordance with the instructions, may cause harmful interference to radio communications. However, there is no guarantee that interference will not occur in a particular installation. If this equipment does cause harmful interference to radio or television reception, which can be determined by turning the equipment off and on, the user is encouraged to try to correct the interference by one or more of the following measures:
  - Reorient or relocate the receiving antenna.
  - Increase the separation between the equipment and receiver.
  - Connect the equipment into an outlet on a circuit different from that to which the receiver is connected.
  - Consult the dealer or an experienced radio/TV technician for help.
- This equipment complies with radiation exposure limits set forth for an uncontrolled environment. This equipment is in direct contact with the body of the user under normal operating conditions. This transmitter must not be co-located or operating in conjunction with any other antenna or transmitter.



# LESSON 1

## Description and Capabilities



# INSTRUCTION POINTS

- The RANGE-R2D LINK system is RANGE-R2D with secure WiFi capability added that allows remote monitoring and control of the system from a distance of 100 meters or greater (Line of Sight).
- The 2D LINK system can also operate from AC power with the provided power supply.
- Components of the RANGE-R2D LINK System
  - RANGE-R2D LINK sensor with built in WiFi module and tripod mount.
  - HP Stream 7 (or equivalent) Windows Tablet ( Do Not cover upper left corner, this is where the antennae is located)
  - AC power supply and cord (used for either the sensor or the battery charger).
  - Qty. 16 nickel metal hydride rechargeable batteries
  - 8 cell battery charger.



# MAJOR COMPONENTS

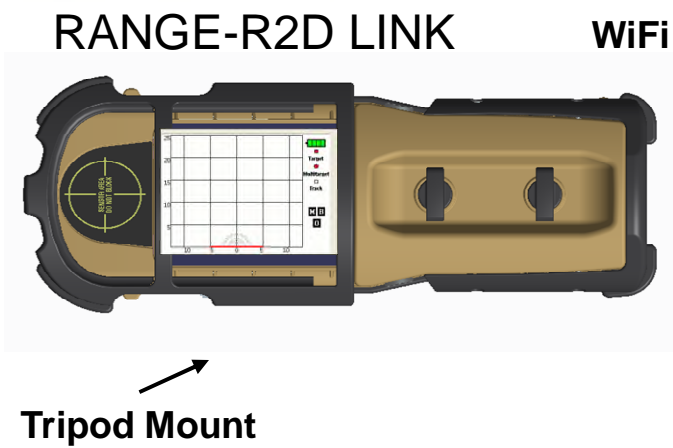

**WIFI ANTENNAS!**  
Keep hands away from this edge for best results.

REMOTE DEVICE

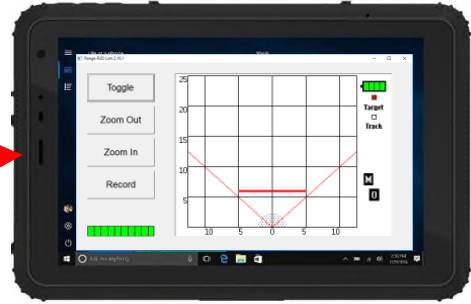

*Note: Do not cover Remote Device Antennae*

BATTERY CHARGER



POWER SUPPLY



# MECHANICAL DATA

Item	Weight
RANGE-R2D Link Unit	3.5 lbs (1.36 kg)
Storage Container	6.1 lbs (2.77 kg)
Soft Case	0.5 lbs (0.23 kg)

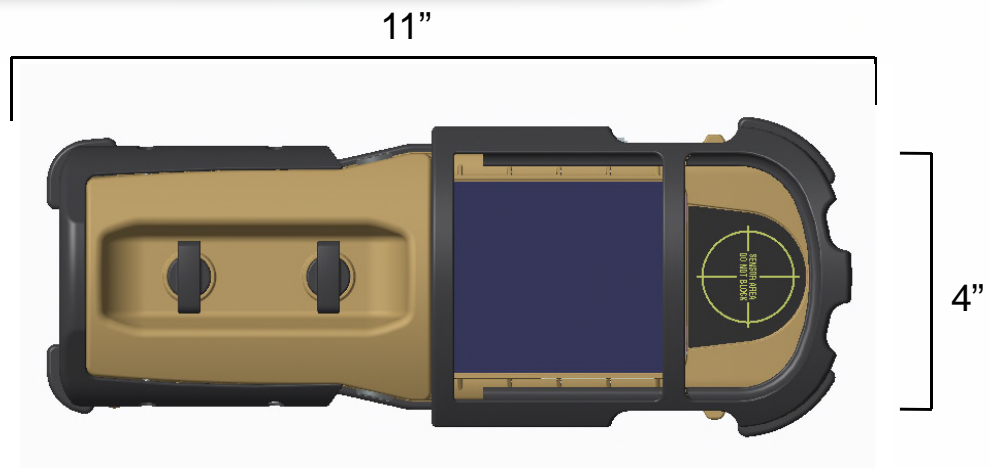

Item	Dimensions
RANGE-R2D Link Unit	12"x3.6"x3.9" (25.4cm x 9.14cm x 9.91cm)
Storage Container	16.3"x12.8"x6.8" (41.4cm x 32.51cm x 17.27cm)

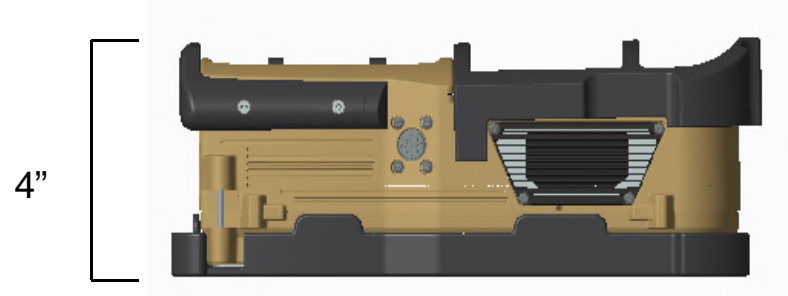

# LESSON 2

## Operation



# POWERING THE SYSTEM

- The RANGE-R2D LINK can operate from either Lithium Energizer L91 primary batteries, rechargeable nickel metal hydride batteries, or external AC power supply.
  - Install the desired batteries or connect the external power supply to the external power connector.
  - **CAUTION! DO NOT INSTALL BATTERIES AND CONNECT THE EXTERNAL POWER SUPPLY SIMULTANEOUSLY AS THE POWER SUPPLY WILL BE SUPPLYING UNREGULATED CURRENT TO THE BATTERIES AND DAMAGE TO THE BATTERIES, POWER SUPPLY AND/OR RANGE-R2D LINK SENSOR MAY OCCUR!**

External Power Connector

RANGE-R2D LINK

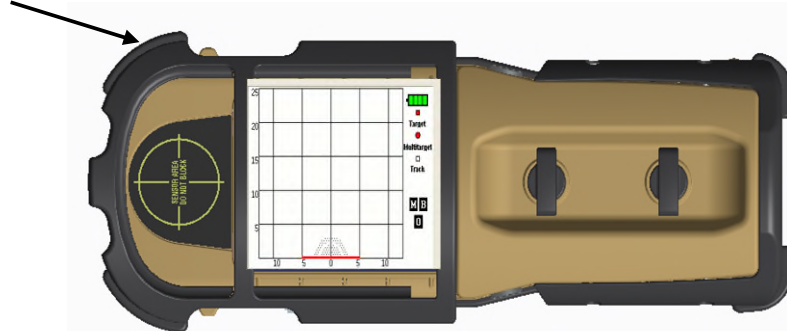

WiFi Module

# POWERING THE SYSTEM

- The WiFi module is in the OFF setting when the sensor is initially powered on.
- To enable WiFi, select WiFi from the main menu and it will toggle to the on state.
  - Note: Once enabled, WiFi remains on until power on the sensor is cycled off and then on again. This implementation prevents accidental turning off WiFi from the remote device and losing communication with the sensor.
- Remove the batteries when use of the system is completed to prevent draining of the batteries.

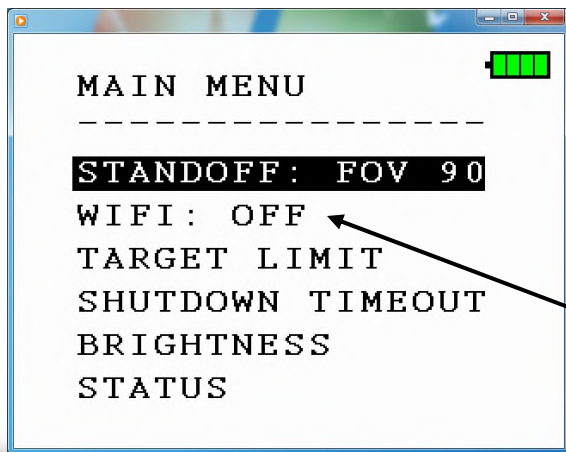

WiFi Enable

RANGE-R2D LINK

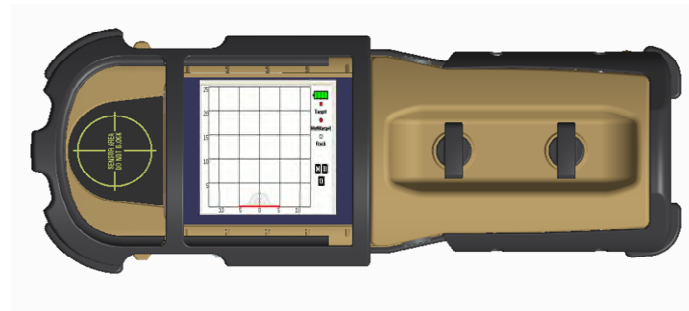

WiFi Module





# POWERING THE SYSTEM

- Power on the remote device, allow Microsoft Windows 10 to start, and navigate to the RANGE-R2D Link App on the Windows Desktop



**WIFI ANTENNAS!**  
Keep hands away from this edge for best results.

### Navigating the Windows Start screen

The Windows® Start screen provides a central location where you can access your information and email, browse the Web, stream videos, view photos, and access social media websites.



**NOTE:** The appearance of the Start screen may vary.

- 1 Open an app:**  
Tap a Start screen app. To quickly return to the Start screen, tap the Start button in the lower-left corner of the screen.
- 2 Display the charms (Search, Share, Start, Devices, and Settings):**  
Swipe from the right edge of the touch screen.
- 3 Find a list of all apps on your tablet:**  
Swipe to the left until the arrow appears, and then tap the arrow in the lower-left corner of the Start screen.
- 4 Display the Start menu**  
Tap the Desktop app, and then press and release the Start button in the lower-left corner.
- 5 Switch between open apps:**  
Swipe in and out from the left edge of the touch screen to reveal a list of open apps, and then tap an open app.

# Using The Windows Application

- Double tap on the RANGE-R2D Link icon to start the application.

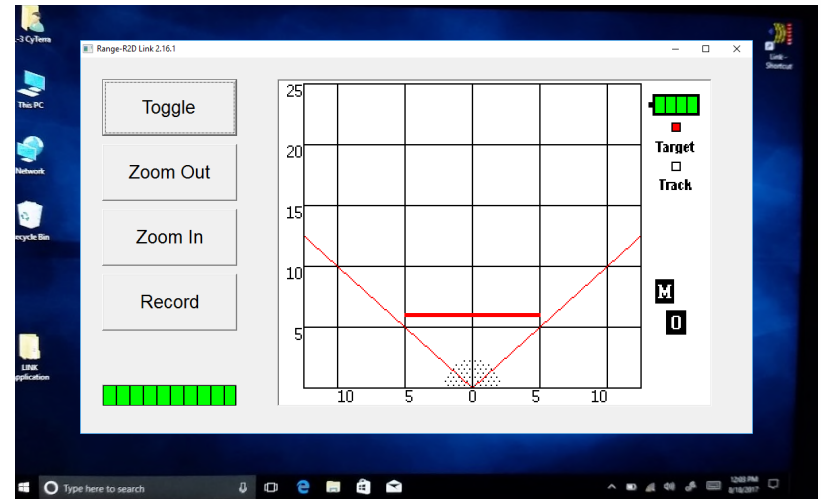
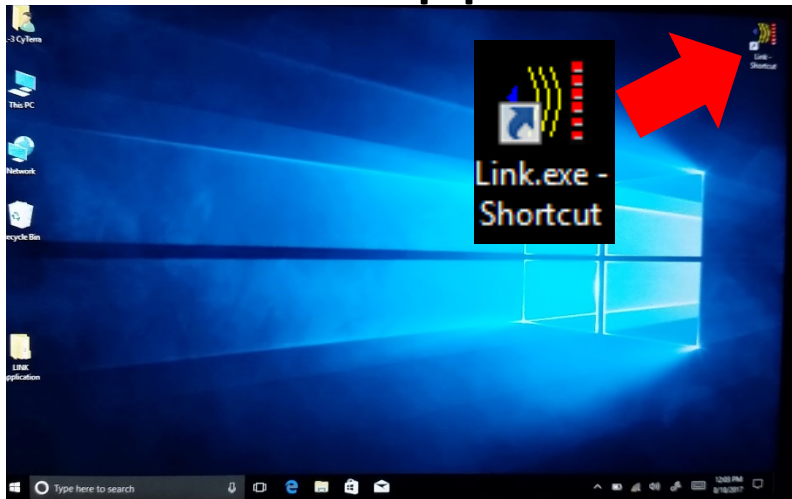

- Application will connect to sensor
- Sensor will go into SCAN mode

# POWERING THE SYSTEM

- The app will open and the remote device will indicate it's connecting to the sensor.

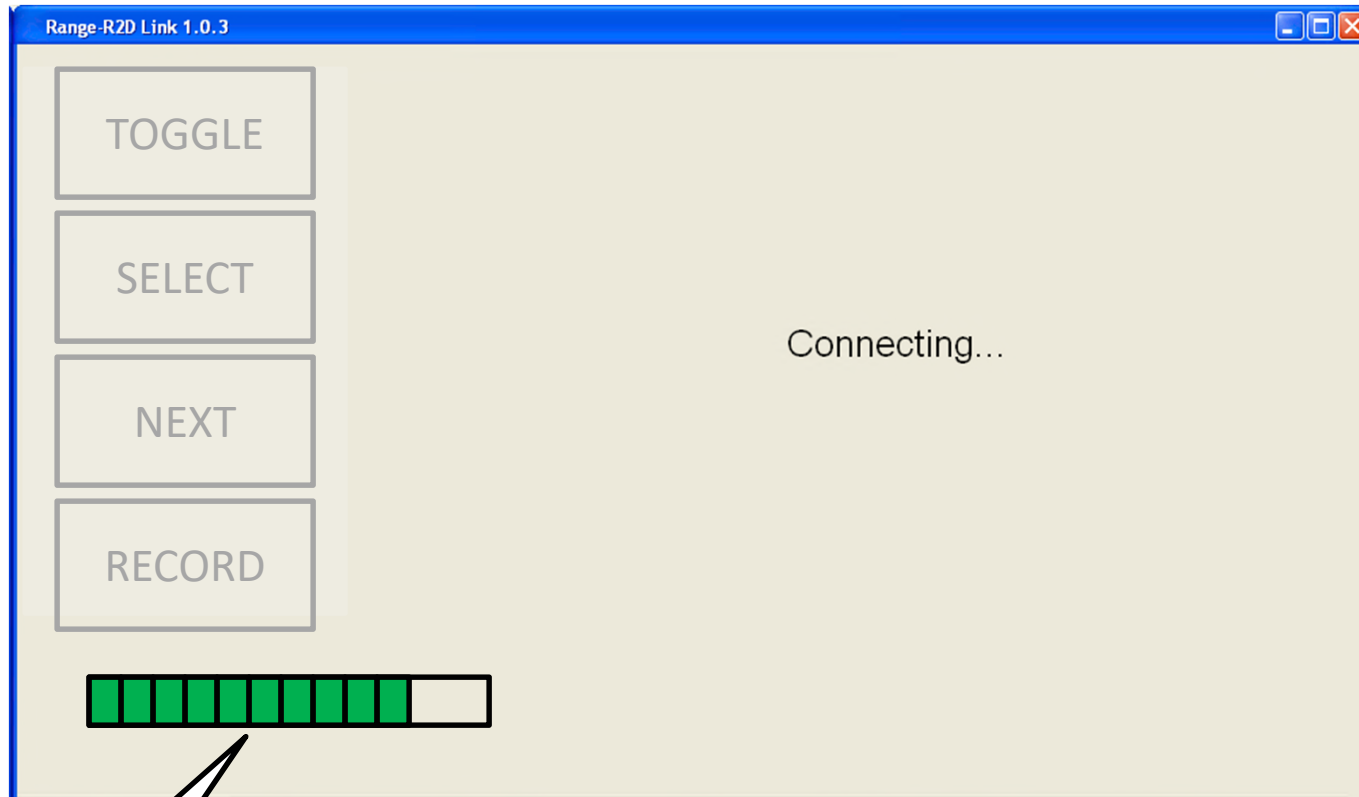

Signal  
Quality

**Note: Do not cover the remote display antennae**



# POWERING THE SYSTEM

- When the remote device has completed connection to the sensor the Main Menu display shown on the sensor display will show on the remote device.

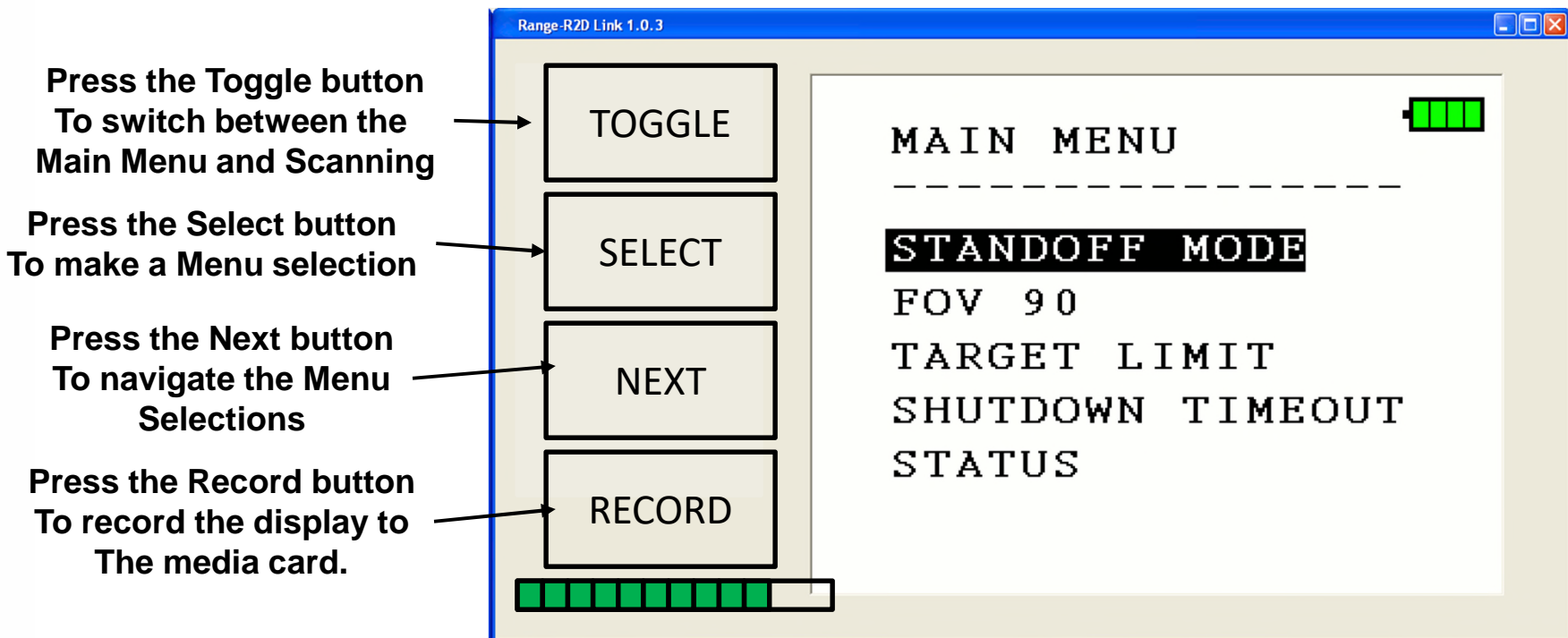

# POWERING THE SYSTEM

- When in scan mode, the display on the sensor is duplicated on the remote device and the RANGE-R2D LINK operates as if the user were holding it. Follow RANGE-R2D Operating Instructions for use.

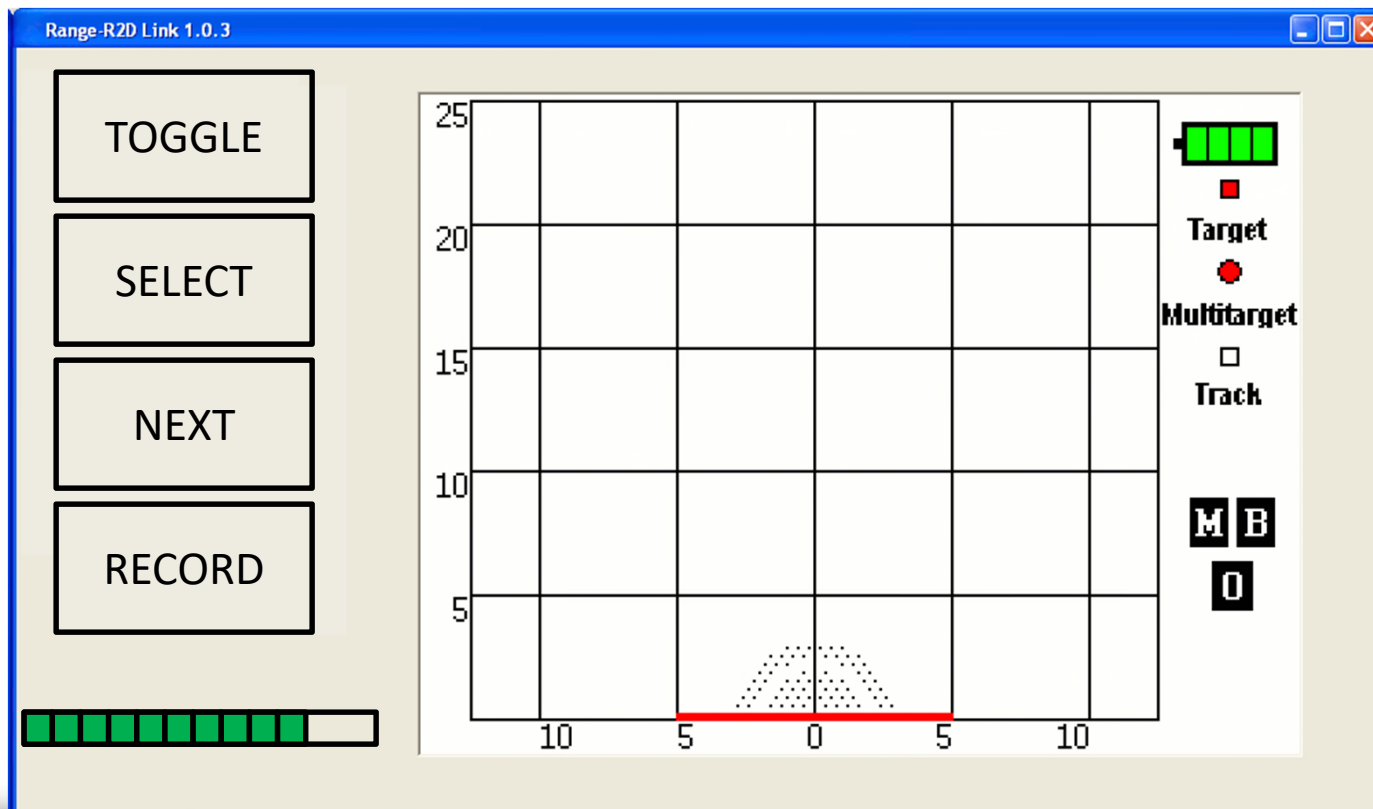

# TURNING THE SYSTEM OFF

- Close the RANGE-R2D LINK application by tapping on the “X” in the red box in the upper right hand corner of the display.
- Power the remote device off using the standard Windows 8.1 method.
- Squeeze and hold the two control buttons on the sensor until the RANGE-R2D Link power off.
- Remove the batteries or disconnect external power from the RANGE-R2D LINK.

