

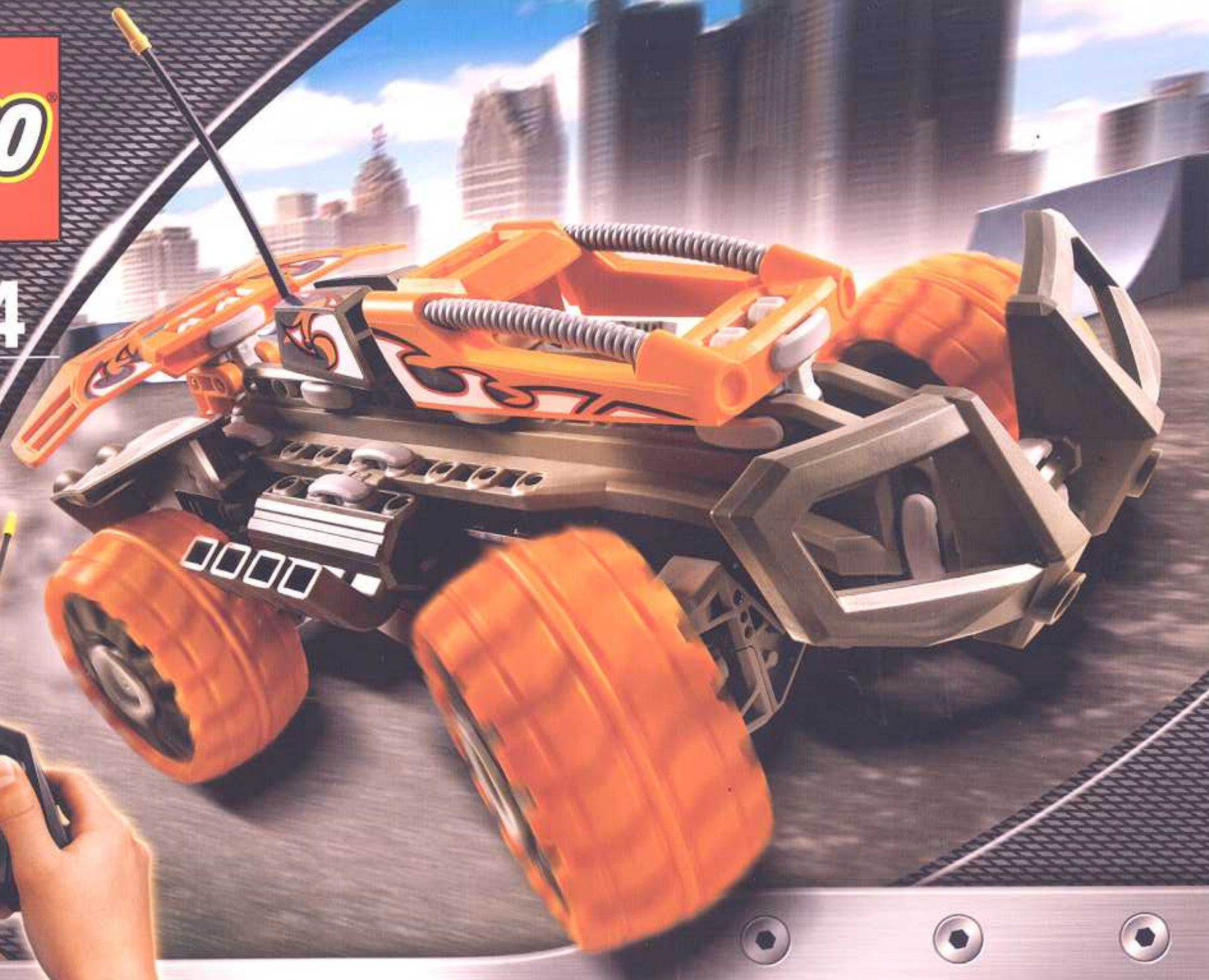

8-14

8676



4492724

8676 9599

08/12/05 9:39:06

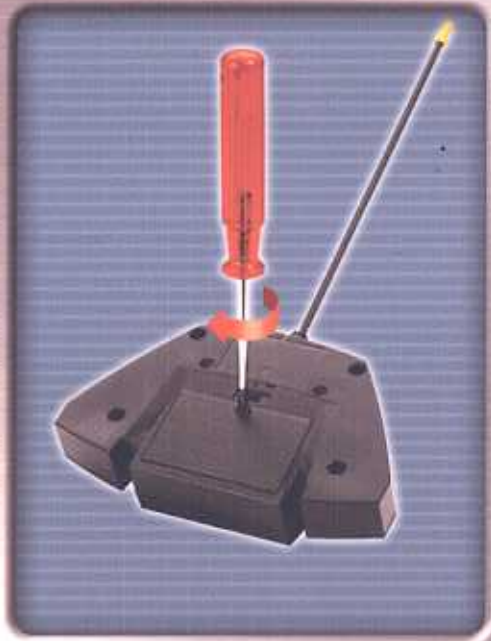

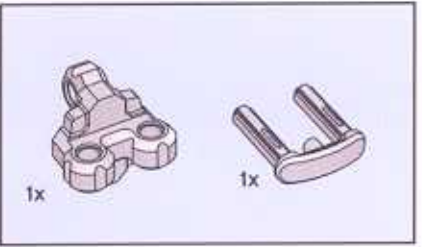

1

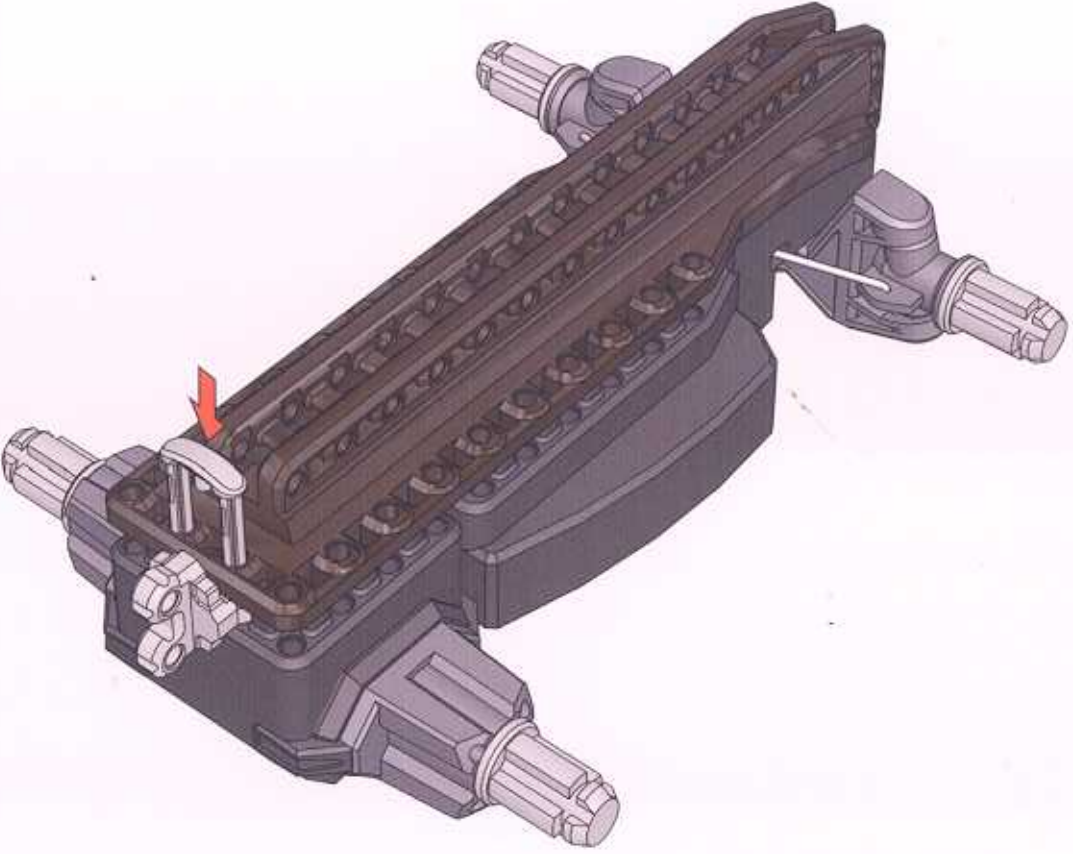

6

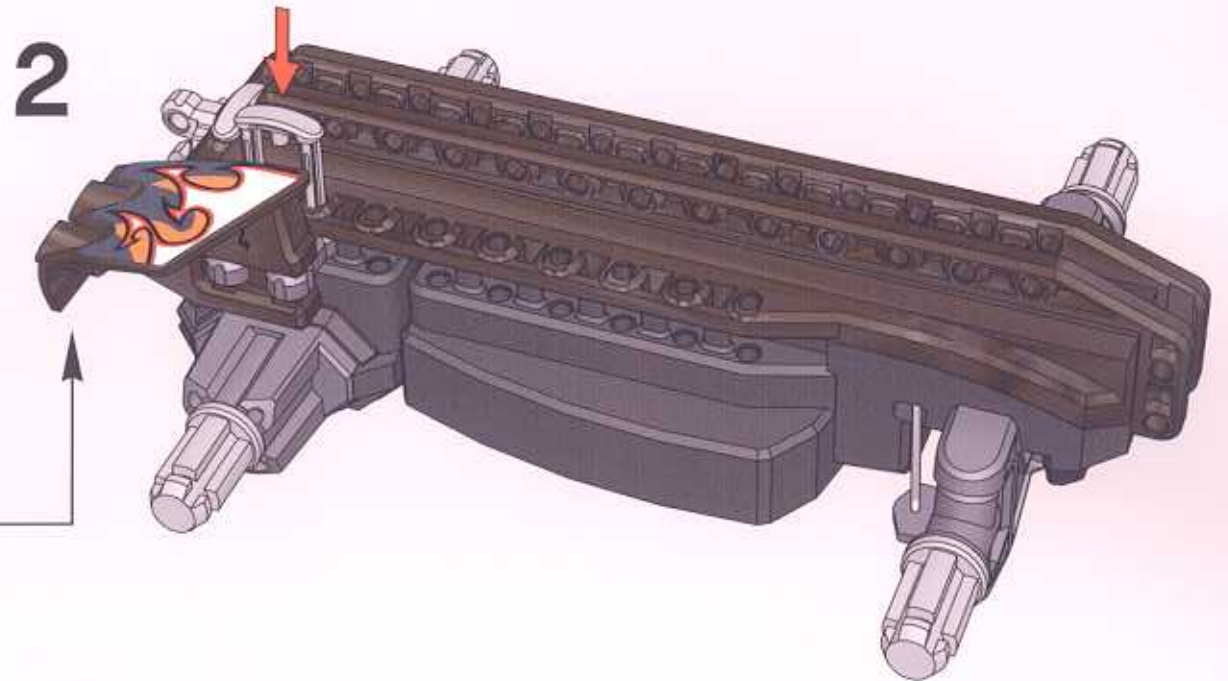
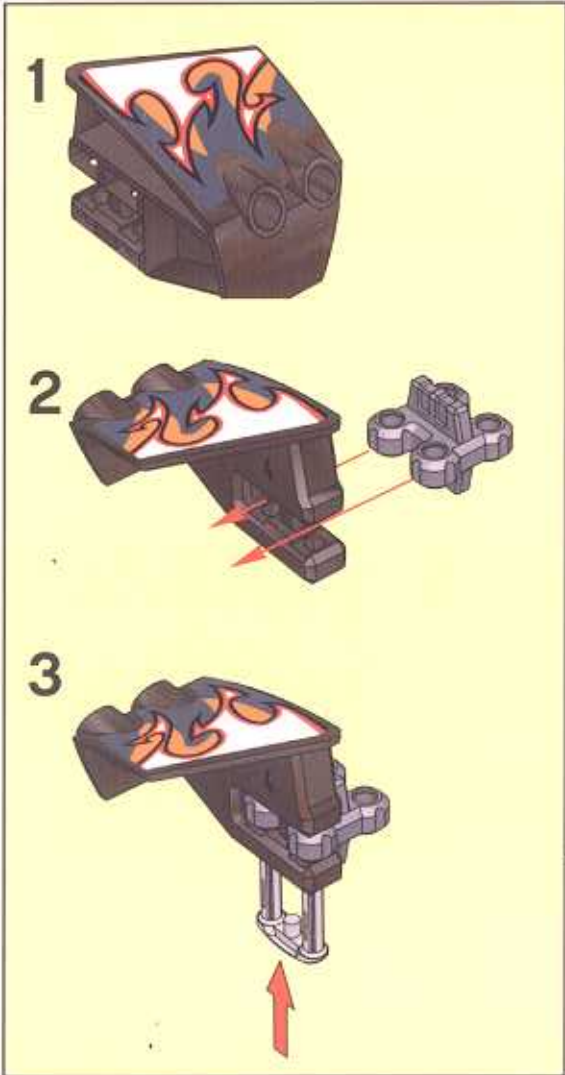
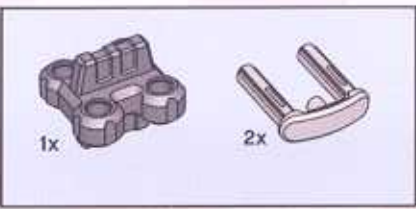

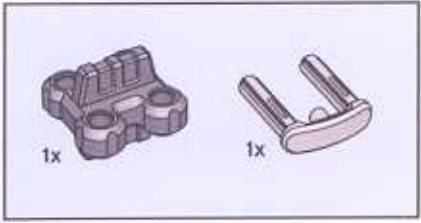

**3**

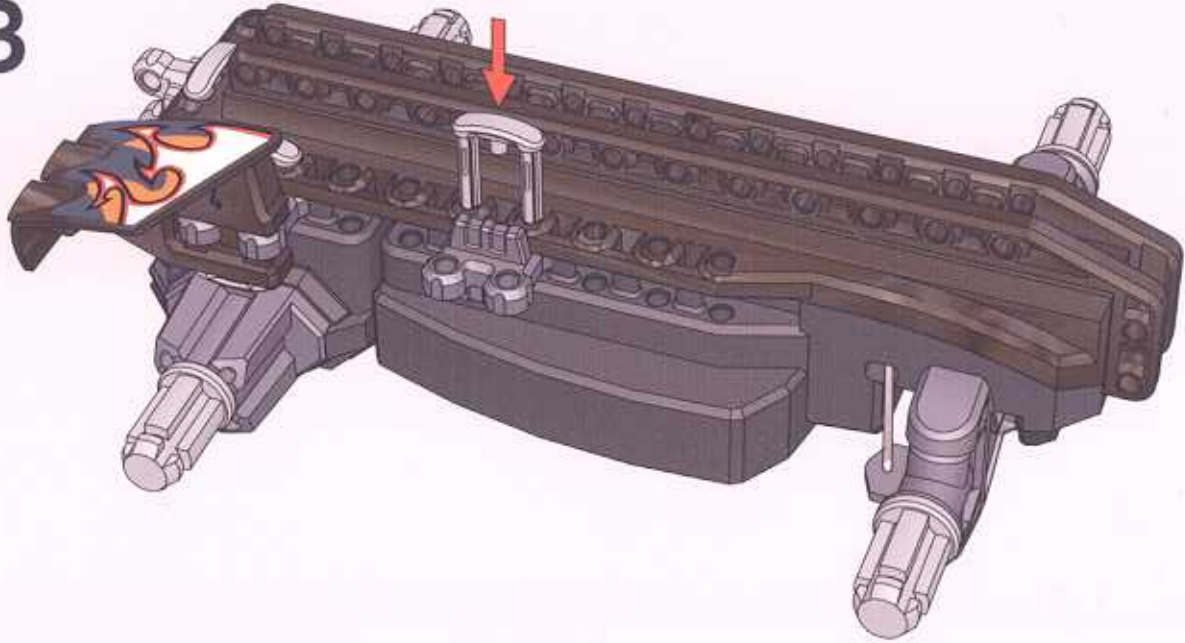

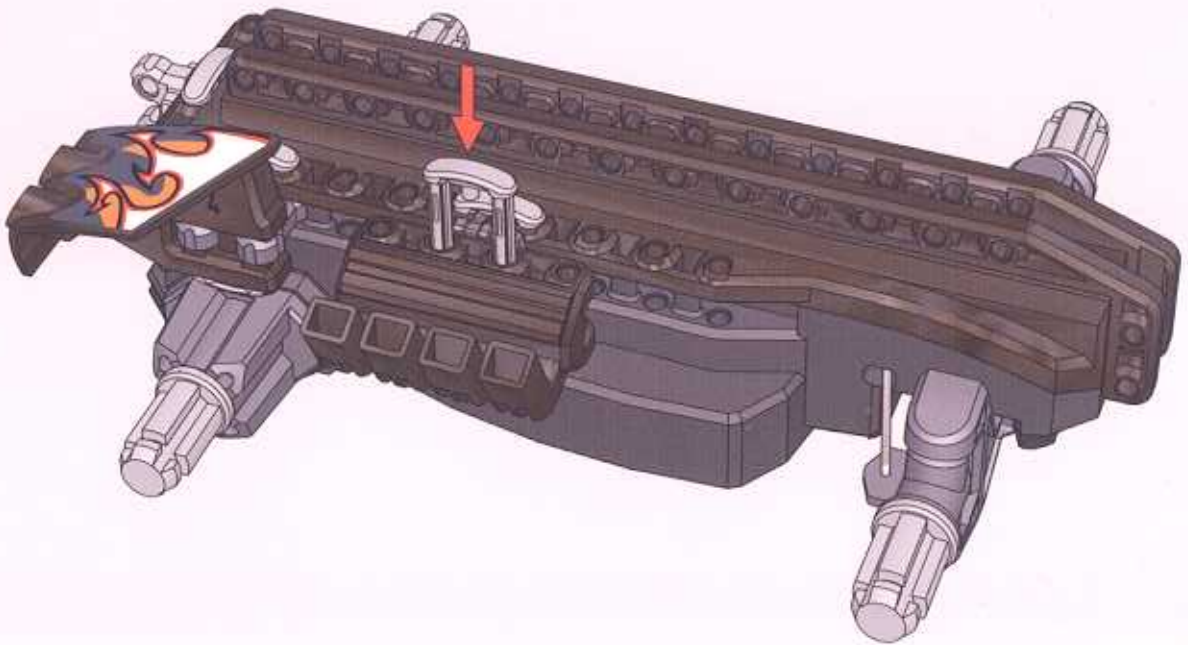

4

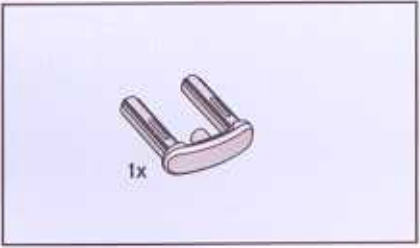

8

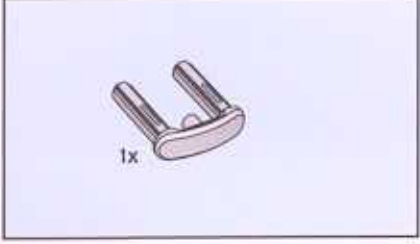

5

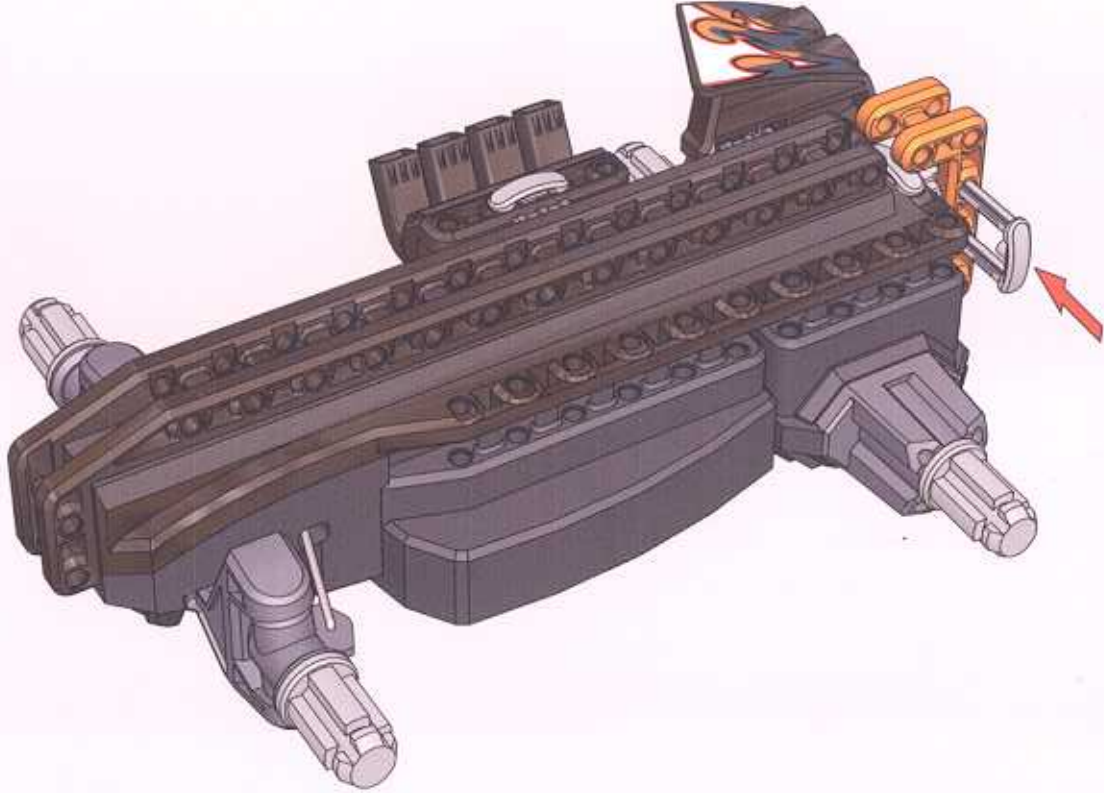

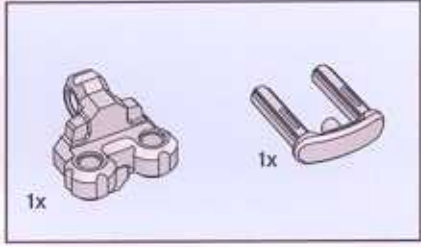

6

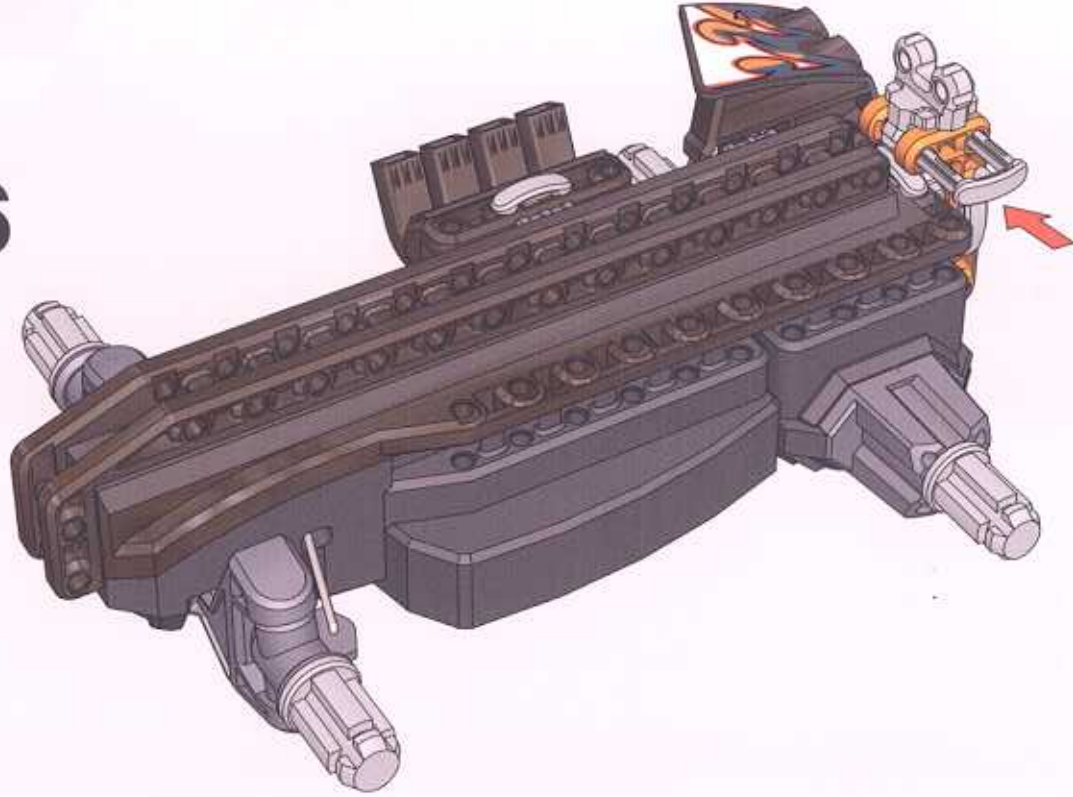



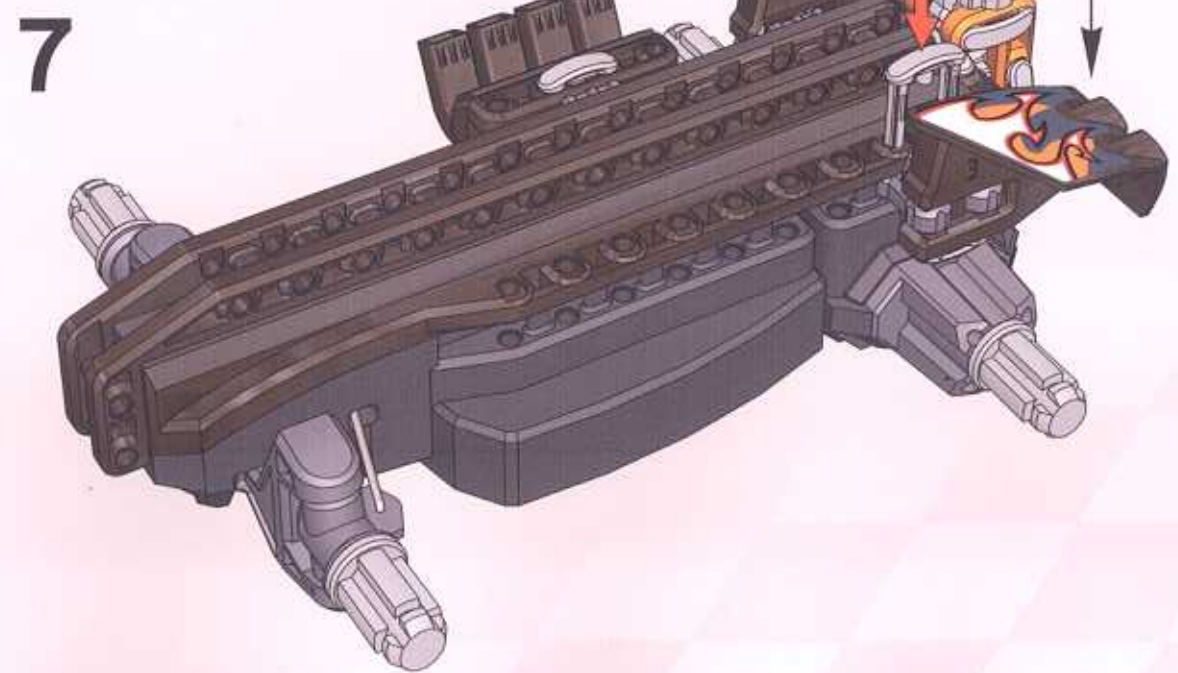
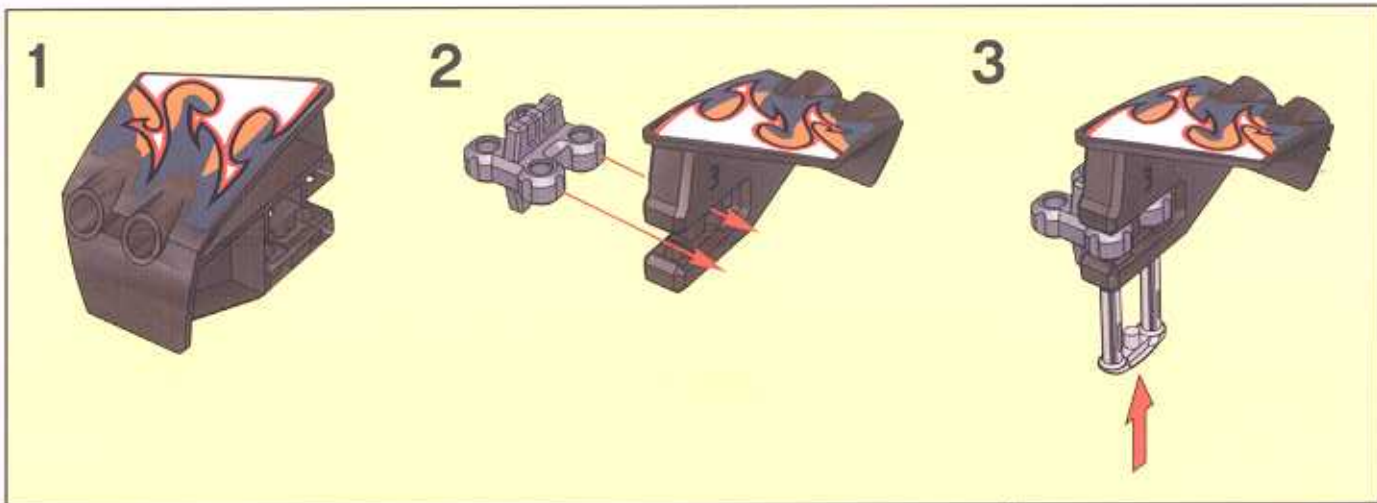
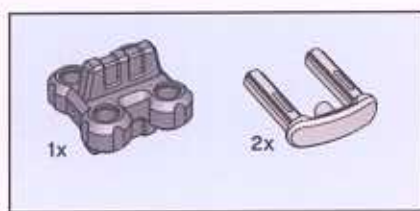

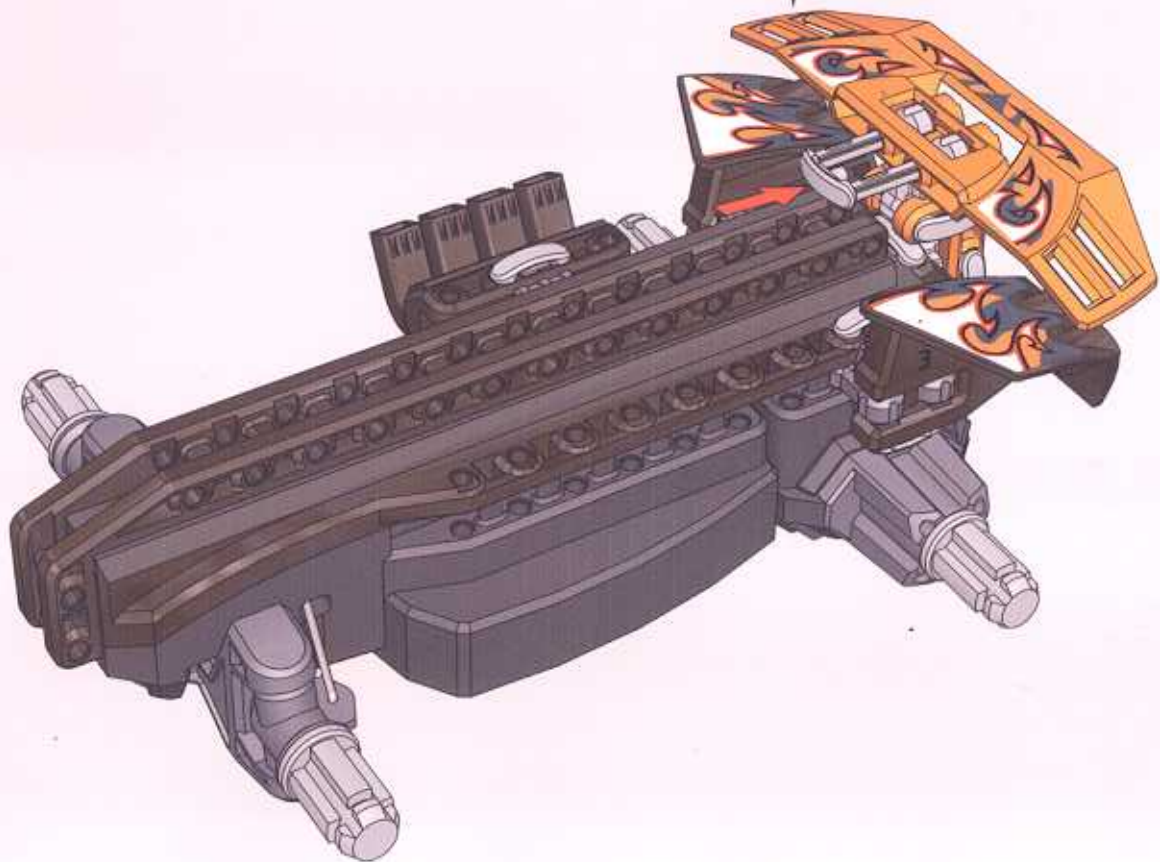
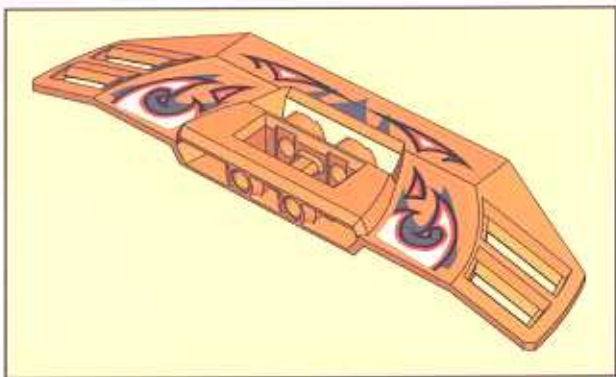

8

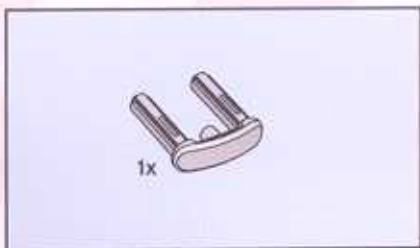

12

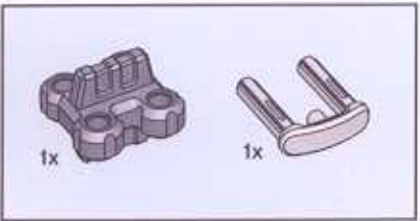

9

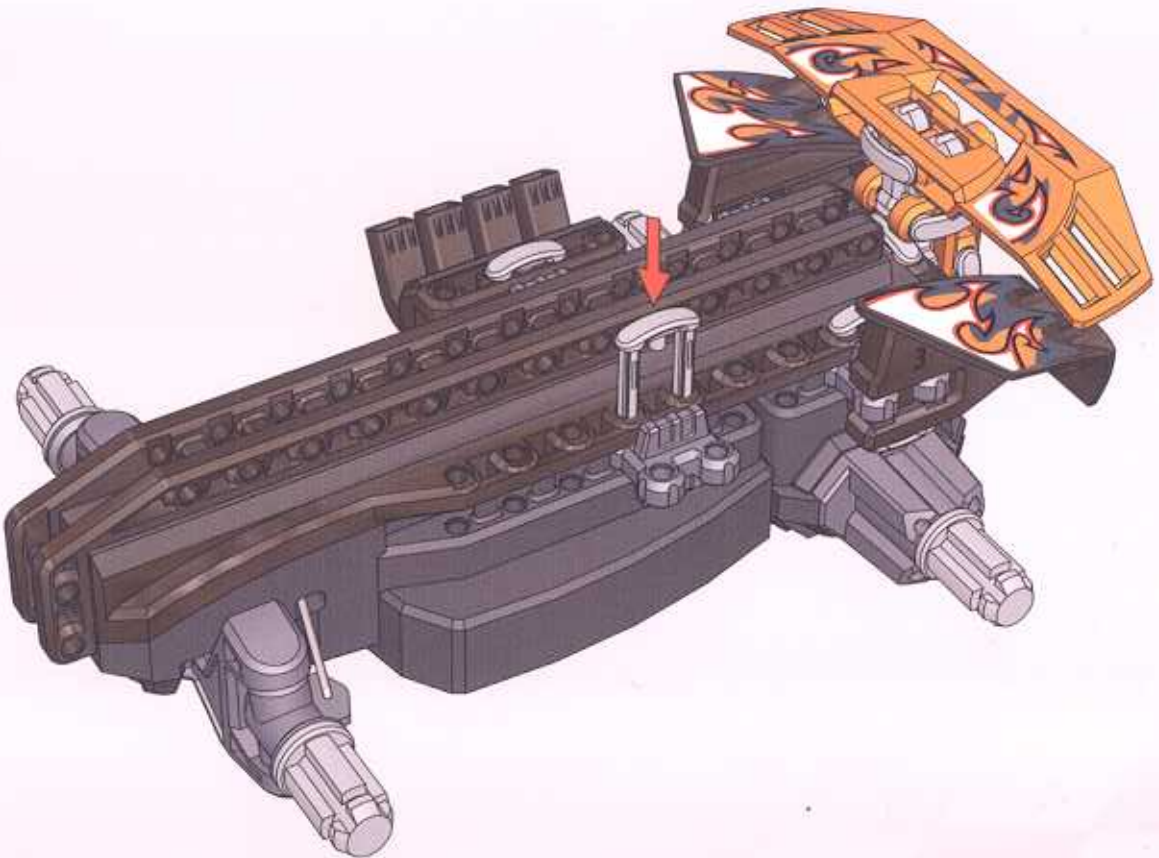

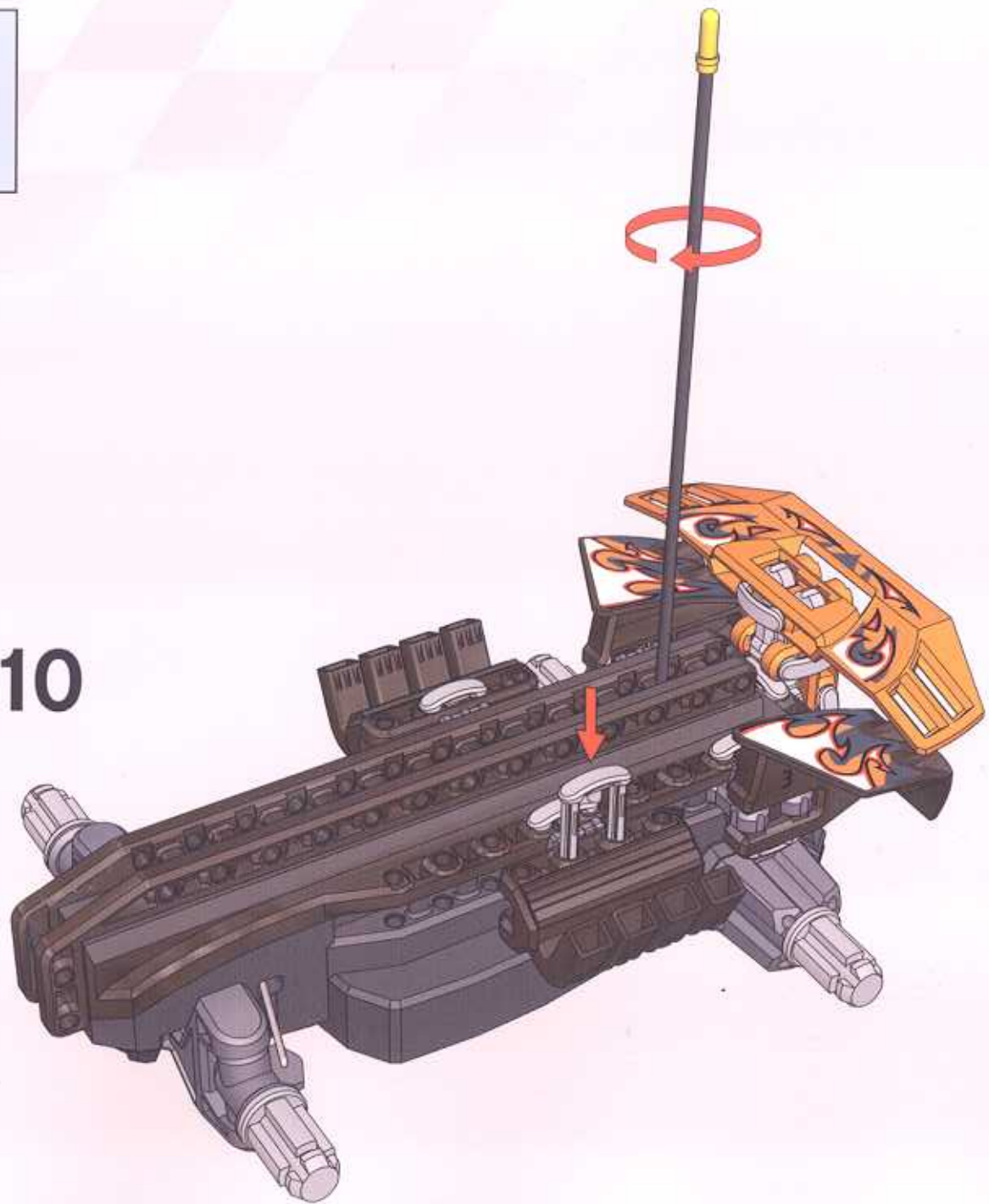

10

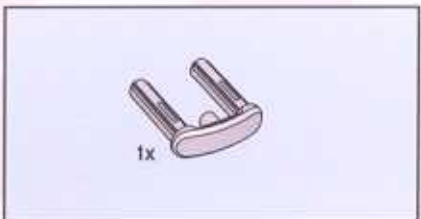

14

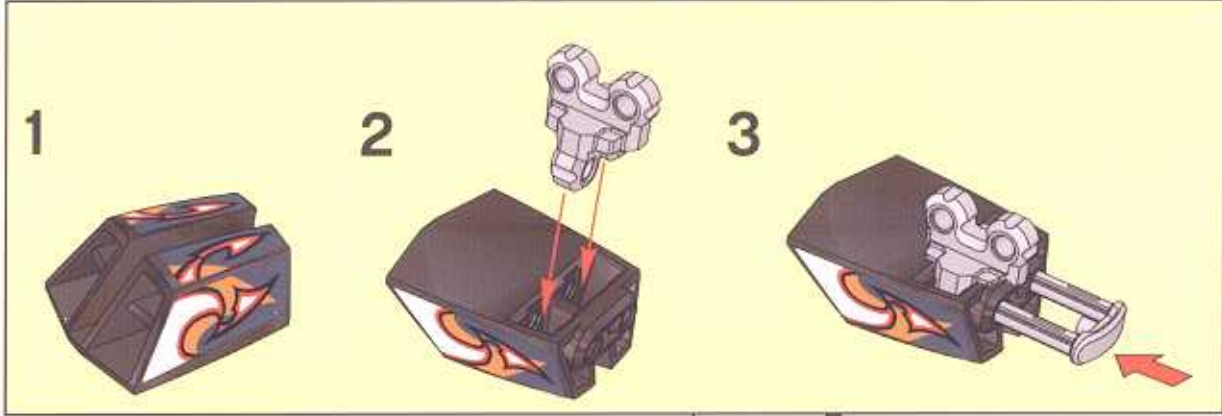
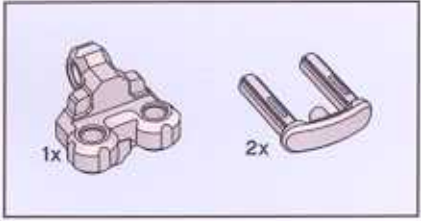

11

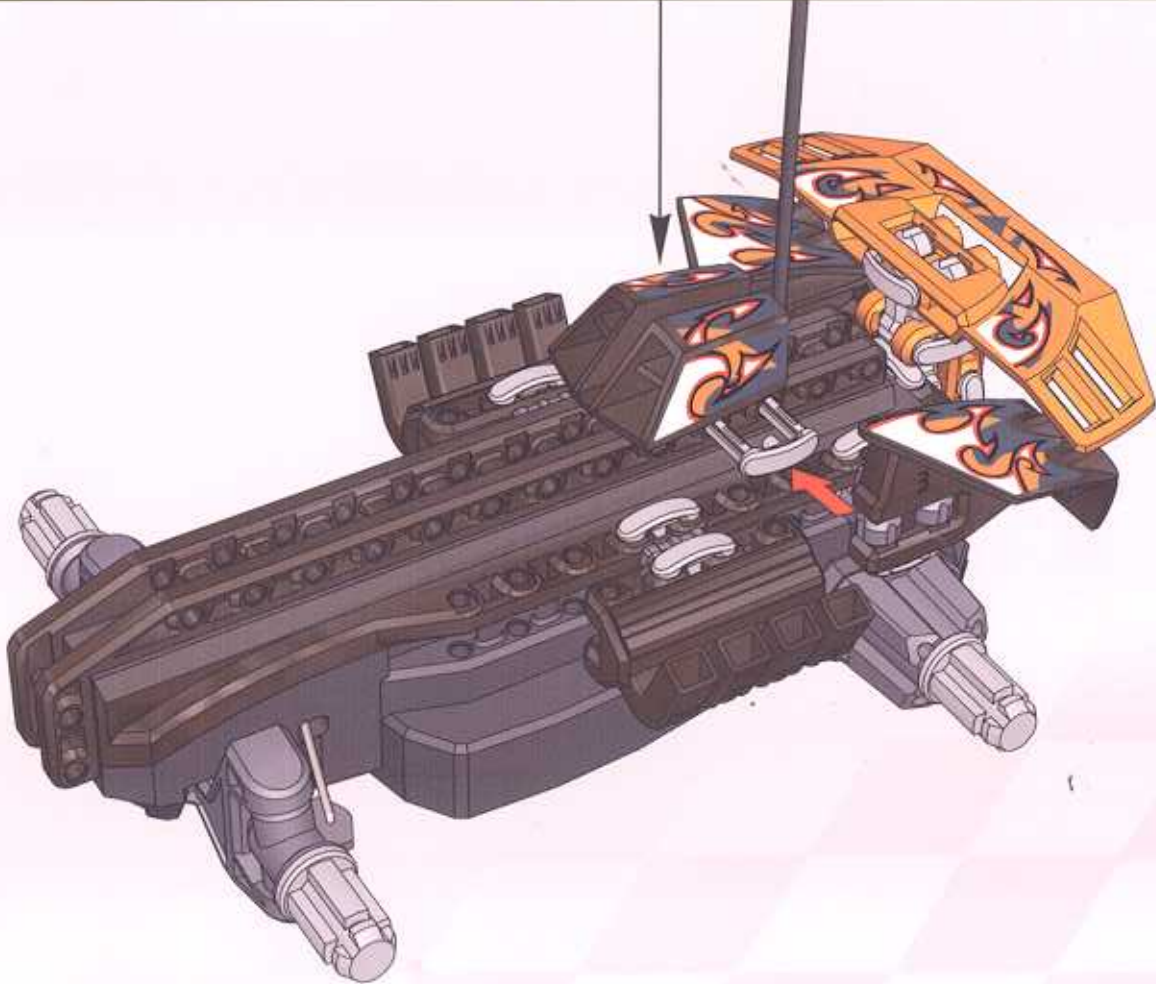

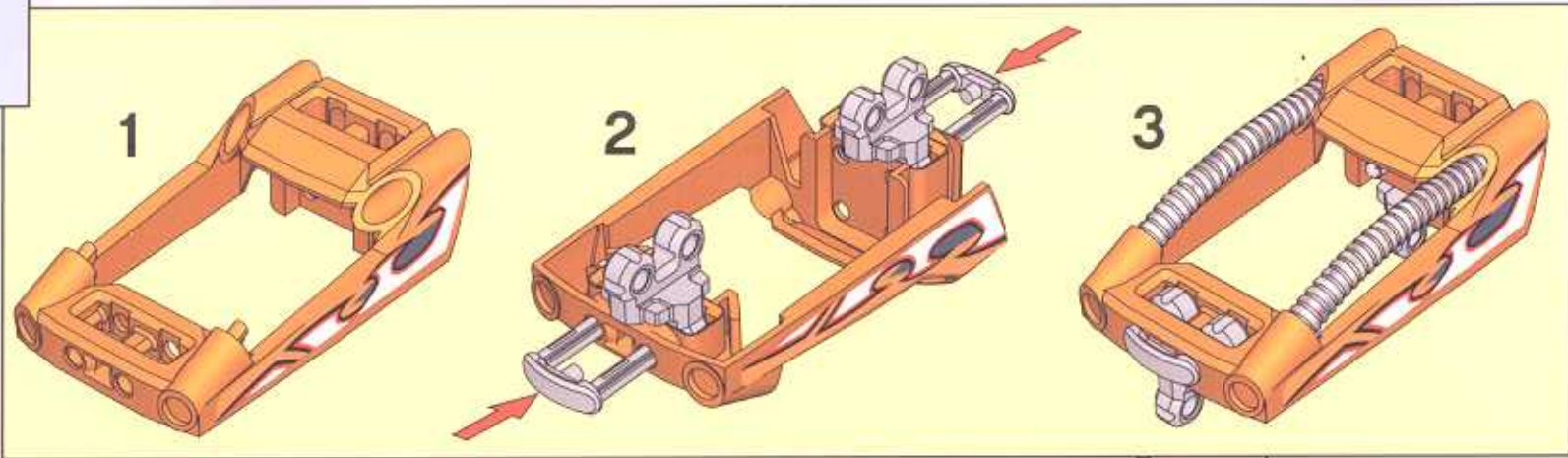
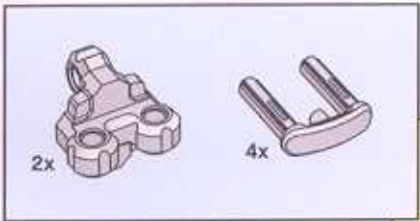

12

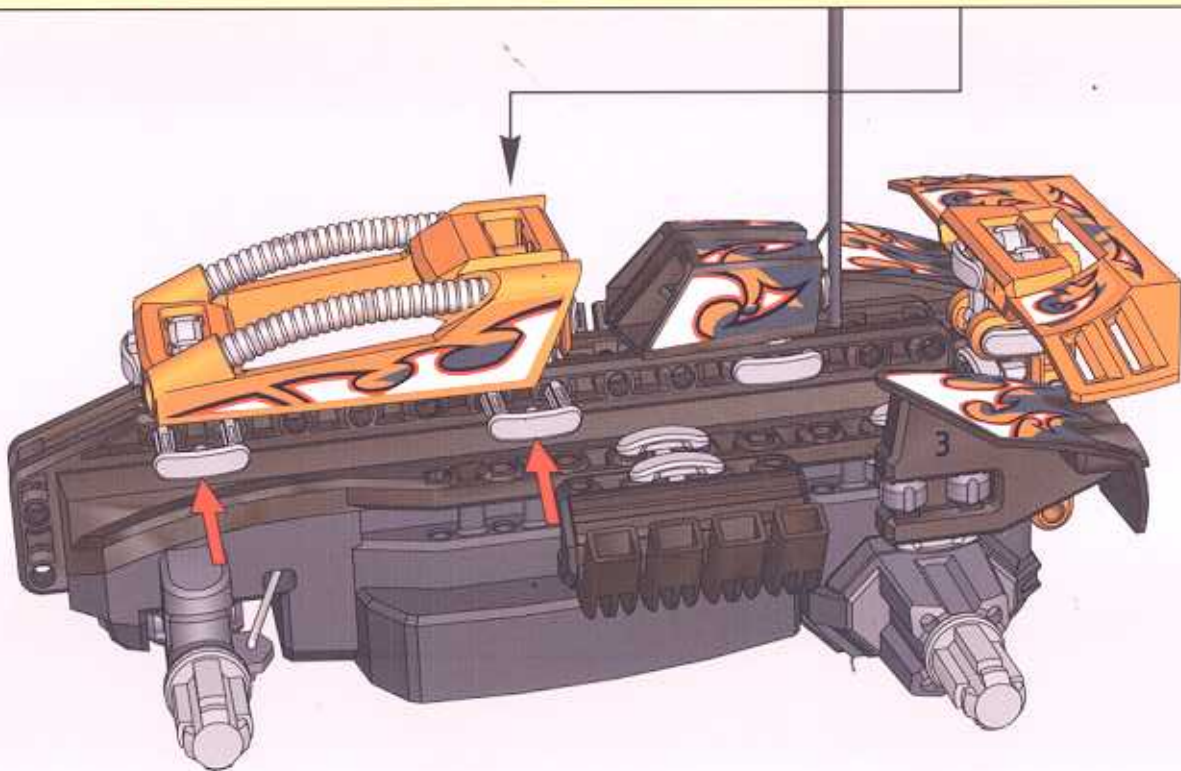

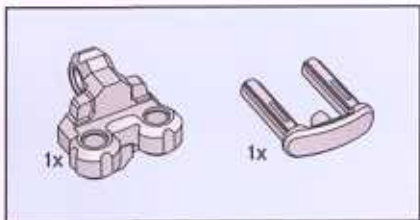

13

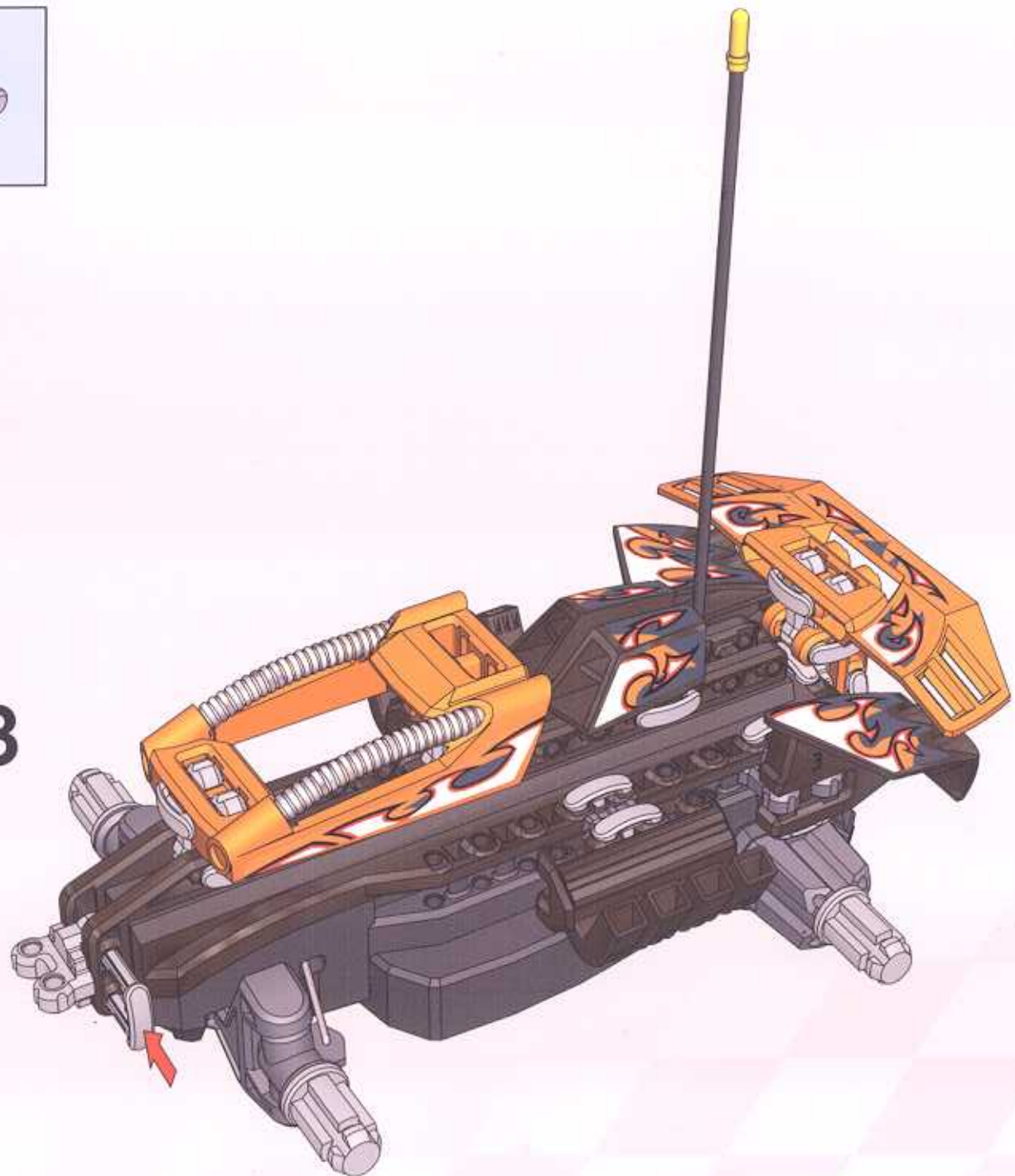

14

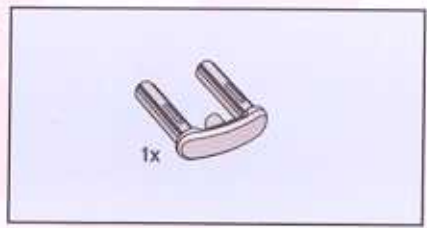
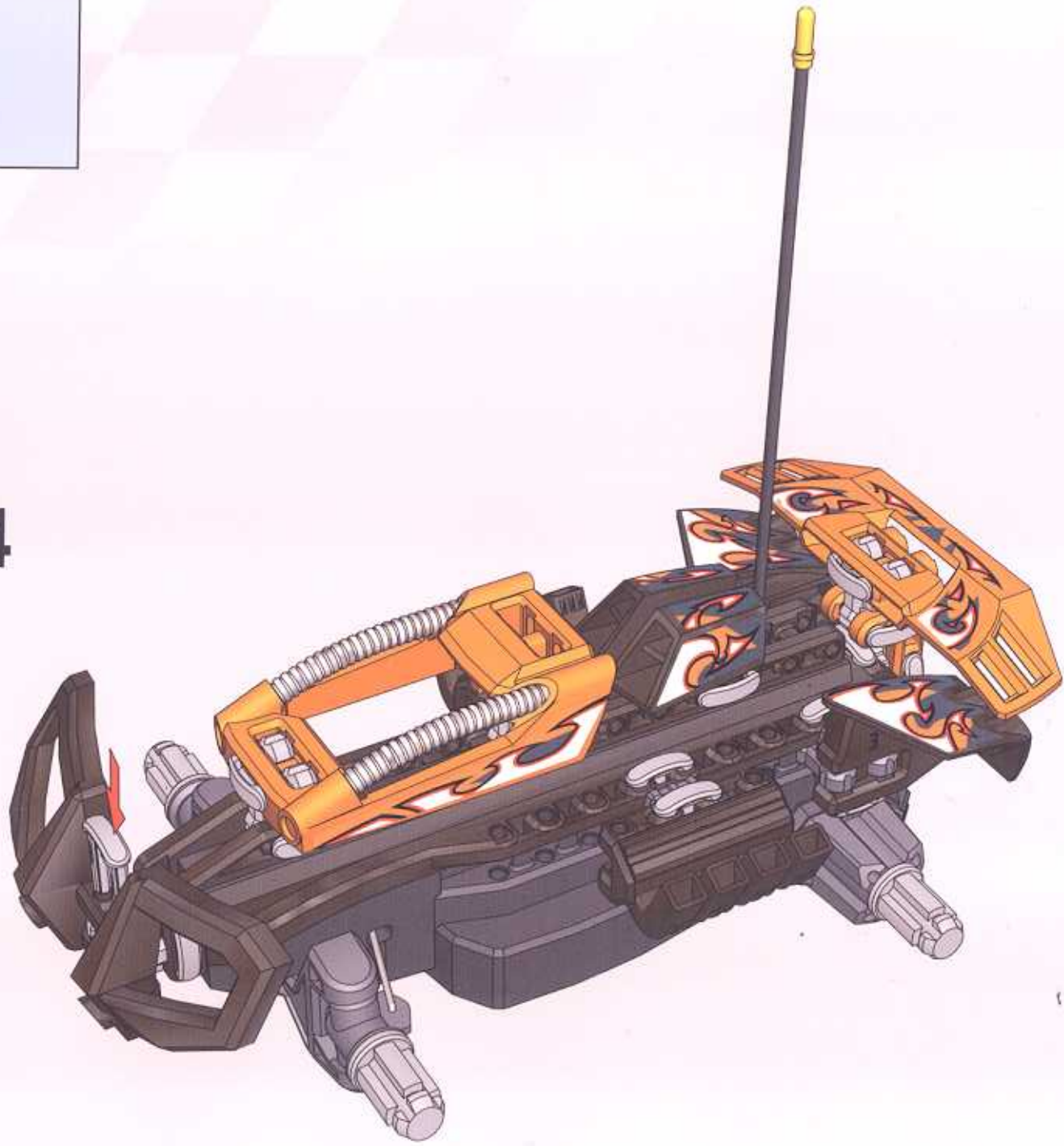

18



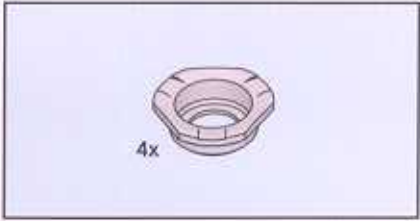

15

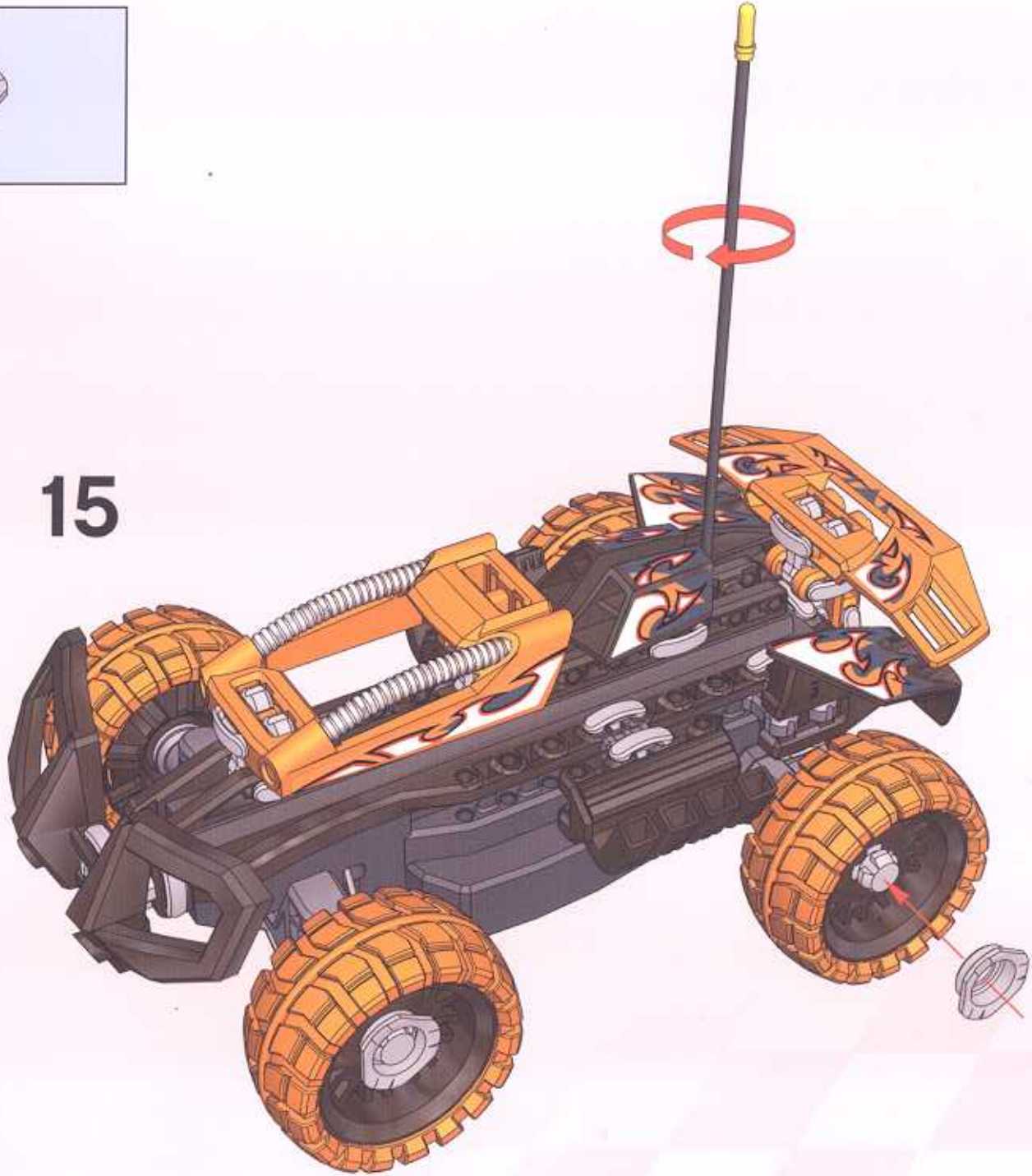



SERVICE  
WWW.LEGO.COM

LEGO

RACERS

9-16  
8675

OUTDOOR  
CHALLENGER

OUTDOOR  
CHALLENGER

©2006 The LEGO Group.

20/11/05 12:15:44

8675\_1.indd 24

2/24/2005 4:40 PM 8675\_p21-24\_04.tif HingLin\_No\_10\_DoubleCoated\_E106\_720\_AGS175\_V04a1\_02.mx4 (F83EA804) PC:C\_E106\_72

## User information in accordance with Article 6.3 of Directive 1999/5/EC

**Danish:** LEGO Company erklærer herved, at følgende udstyr Sunset Cruiser (8676) overholder de væsentlige krav og øvrige relevante krav i direktiv 1999/5/EF.

**Dutch:** Hierbij verklaart LEGO Company dat het toestel Sunset Cruiser (8676) in overeenstemming is met de essentiële eisen en de andere relevante bepalingen van richtlijn 1999/5/EG. Bij deze verklaart LEGO Company dat deze Sunset Cruiser (8676) voldoet aan de essentiële eisen en aan de overige relevante bepalingen van Richtlijn 1999/5/EC.

**English:** Hereby, LEGO Company, declares that this Sunset Cruiser (8676) is in compliance with the essential requirements and other relevant provisions of Directive 1999/5/EC.

**Finnish:** LEGO Company vakuuttaa täten että Sunset Cruiser (8676) tyypinen laite on direktiivin 1999/5/EY oleellisten vaatimusten ja sitä koskevien direktiivin muiden ehtojen mukainen.

**French:** Par la présente LEGO Company déclare que l'appareil Sunset Cruiser (8676) est conforme aux exigences essentielles et aux autres dispositions pertinentes de la directive 1999/5/CE. Par la présente, LEGO Company déclare que ce Sunset Cruiser (8676) est conforme aux exigences essentielles et aux autres dispositions de la directive 1999/5/CE qui lui sont applicables.

**German:** Hiermit erklärt LEGO Company, dass sich dieser Sunset Cruiser (8676) in Übereinstimmung mit den grundlegenden Anforderungen und den anderen relevanten Vorschriften der Richtlinie 1999/5/EG befindet". (BMW)  
Hiermit erklärt LEGO Company die Übereinstimmung des Gerätes Sunset Cruiser (8676) mit den grundlegenden Anforderungen und den anderen relevanten Festlegungen der Richtlinie 1999/5/EG. (Wien)

**Greek:** ΜΕ ΤΗΝ ΠΑΡΟΥΣΑ LEGO Company ΔΗΛΩΝΕΙ ΟΤΙ Sunset Cruiser (8676) ΣΥΜΜΟΡΦΩΝΕΤΑΙ ΠΡΟΣ ΤΙΣ ΟΥΣΙΩΔΕΙΣ ΑΠΑΙΤΗΣΕΙΣ ΚΑΙ ΤΙΣ ΣΧΕΤΙΚΕΣ ΔΙΑΤΑΞΕΙΣ ΤΗΣ ΟΔΗΓΙΑΣ 1999/5/ΕΚ ΛΟΙΠΕΣ

**Italian:** Con la presente LEGO Company dichiara che questo Sunset Cruiser (8676) è conforme ai requisiti essenziali ed alle altre disposizioni pertinenti stabilite dalla direttiva 1999/5/CE.

**Portuguese:** LEGO Company declara que este Sunset Cruiser (8676) está conforme com os requisitos essenciais e outras provisões da Directiva 1999/5/CE.

**Spanish:** Por medio de la presente LEGO Company declara que el Sunset Cruiser (8676) cumple con los requisitos esenciales y cualesquiera otras disposiciones aplicables o exigibles de la Directiva 1999/5/CE.

**Swedish:** Härmed intygar LEGO Company att denna Sunset Cruiser (8676) står i överensstämmelse med de väsentliga egenskapskrav och övriga relevanta bestämmelser som framgår av direktiv 1999/5/EG.

## Model: Sunset Cruiser transmitter (57823) FCC ID: NPI57823

This device complies with part 15 of the FCC Rules. Operation is subject to the following two conditions:

1. This device may not cause harmful interference.
2. This device must accept any interference received, including interference that may cause undesired operation.

### Warning:

Changes or modifications to this unit not expressly approved by the party responsible for compliance could void the user's authority to operate the equipment.

### NOTE:

This equipment has been tested and found to comply with the limits for a Class B digital device, pursuant to part 15 of the FCC Rules. These limits are designed to provide reasonable protection against harmful interference in a residential installation.

This equipment generates, uses and can radiate radio frequency energy and, if not installed and used in accordance with the instructions, may cause harmful interference to radio communications. However, there is no guarantee that interference will not occur in a particular installation. If this equipment does cause harmful interference to radio or television reception, which can be determined by turning the equipment off and on, the user is encouraged to try to correct the interference by one or more of the following measures:

- Reorient or relocate the receiving antenna.
- Increase the separation between the equipment and receiver.
- Connect the equipment into an outlet on a circuit different from that to which the receiver is connected.

Consult the dealer or an experienced radio/TV technician for help.

## Model: Sunset Cruiser receiver (57820) FCC ID: NPI57820

Cet appareil est conforme aux exigences de la section 15 des règlements du Conseil supérieur de l'audiovisuel (FCC). Son fonctionnement est soumis aux 2 conditions qui suivent :

1. Cet appareil ne peut causer de brouillage nocif.
2. Cet appareil doit accepter tout brouillage reçu, y compris le brouillage pouvant engendrer un code d'opération non souhaité.

### Avertissement :

Les changements ou modifications apportés à cette unité et n'ayant pas été expressément autorisés par l'équipe responsable de la conformité aux règlements pourraient annuler la permission accordée à l'utilisateur quant à l'opération de l'équipement.

### REMARQUE :

Cet équipement a été testé et déclaré conforme aux limites définies dans la section 15 de la réglementation FCC et applicables aux appareils numériques de classe B. Ces limites sont fixées pour obtenir une protection satisfaisante contre les interférences nuisibles dans les installations résidentielles.

Cet équipement produit, consomme et peut émettre de l'énergie radioélectrique et il risque, s'il n'est pas installé et utilisé conformément aux instructions, de provoquer des interférences nuisibles avec les communications radio. Il est cependant impossible de garantir que des interférences ne surviendront pas dans une installation particulière.

Si cet équipement est la cause d'interférences gênant la réception de programmes radio ou télévisés, ce qui peut être déterminé en mettant l'appareil hors tension et de nouveau sous tension, il est demandé à l'utilisateur de tenter de remédier au problème à l'aide d'une ou plusieurs des mesures suivantes :

- Réorienter ou déplacer l'antenne de réception.
- Augmenter la distance séparant l'équipement et le récepteur.
- Raccorder l'équipement sur une sortie appartenant à un circuit différent de celui auquel le récepteur est connecté.

Consulter le revendeur ou un technicien radio-télévision expérimenté pour obtenir de l'aide.

