

LGI - 3000W Users Manual

LG Information & Communications, Ltd.

1 Product Features

Light Weight, Compact, Solid Design

Low Cost Smartphone

Easy to Use

- Voice Activated Dialing
- Large Graphic LCD Display with Touch Panel
 - 160 X 240(dots)
 - Partial Display in Phone Mode
 - Virtual Keyboard for Easy Entry
 - Backlight for High Visibility
- Intuitive and Easy-to-use Phonebook, Large Screen Call Log
- Scheduler(Datebook) with Alarms.
- Various useful PIMs : Phonebook, Datebook, Todo List, Memo, Sketch, World Clock, Calculator, ...
- Speaker Phone Capability(0.3W Max)

Support Data Communication

- Phone.com Browser
- Text Message, E-Mail
- PC Connectivity-Compatible with the Microsoft Outlook, Scheduler+



FCC RF EXPOSURE INFORMATION

WARNING! Read this information before using your phone

In August 1996 the Federal Communications Commission (FCC) of the United States with its action in Report and Order FCC 96-326 adopted an updated safety standard for human exposure to radio frequency (RF) electromagnetic energy emitted by FCC regulated transmitters. Those guidelines are consistent with the safety standard previously set by both U.S. and international standards bodies. The design of this phone complies with the FCC guidelines and these international standards.



Use only the supplied or an approved antenna. Unauthorized antennas, modifications, or attachments could impair call quality, damage the phone, or result in violation of FCC regulations.

Do not use the phone with a damaged antenna. If a damaged antenna comes into contact with the skin, a minor burn may result. Please contact your local dealer for replacement antenna.

Body-worn Operation

This device was tested for typical body-worn operations with the back of the phone kept 0.79 inches (2 cm) from the body. To comply with FCC RF exposure requirements, a minimum separation distance of 0.79 inches (2 cm) must be maintained between the user's body and the back of the phone, including the antenna, whether extended or retracted. Third-party belt-clips, holsters and similar accessories containing metallic components should not be used. Body-worn accessories that cannot maintain 0.79 inch (2 cm) separation distance between the user's body and the back of the phone, and have not been tested for typical body-worn operations may not comply with FCC RF exposure limits and should be avoided.

Vehicle Mounted External Antenna (optional, if available.)

A minimum separation distance of 7.9 inches (20 cm) must be maintained between the user/bystander and the vehicle mounted external antenna to satisfy FCC RF exposure requirements.

For more information about RF exposure, please visit the FCC website at www.fcc.gov

2 Product Specifications

	Specification
Size	FlipUp type : 135 * 56.5 * 25mm
Button / Connector	Dial Key pad : 12 keys 4 function keys, cursor key, Backlight/Power On-Off Button : Volume up/down Jack : Headset jack ICA/SIO jack Connector : for External device Contact : for Charger
Weight	TBD
LCD Module	Resolution : 160 * 240 Dot Pitch : 0.25mm Graphic LCD with Backlight Size : Full Active size : 40* 60mm , Partial Active size : 40 * 27.5mm Module size : 50.5*70.65mm(min) Touch Panel Size : 50.3 * 70.3
Battery	3.6V Li-ion 1 cell / 1300 mAH Cell Size : 9 * 34 * 48mm 3 Hours Talk (@+10dBm, 45 % rate, standard batt.) 100 hours Stand-by Time (@2.56s slot mode 2, standard)

3 Design Rendering



4 Description

Phone Mode(Flip Closed)



Phone Mode LCD Display

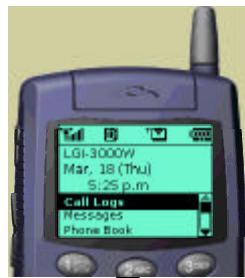

Basic Display Format

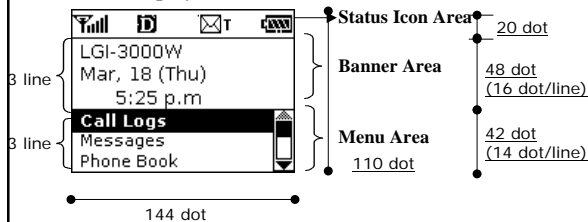

Display Icons

ICON	DESCRIPTION
	Signal Strength Indicator
	No Service
	Roaming
	New page/text messages
	New voicemail
	Vibrator Indicator
	Battery Charge Status

PIM Mode(Flip Opened)

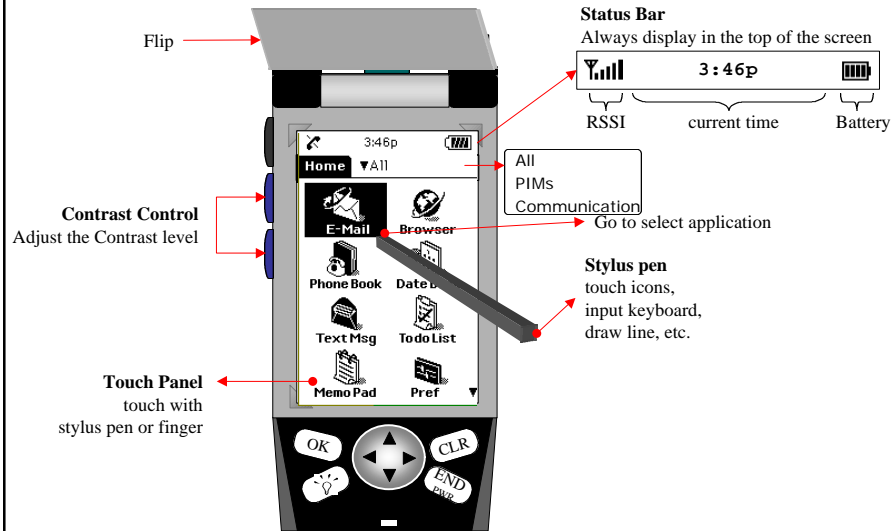

5 UI Specification

Phone Mode (Flip Closed)

Initial Screen

1. Turning the Power On

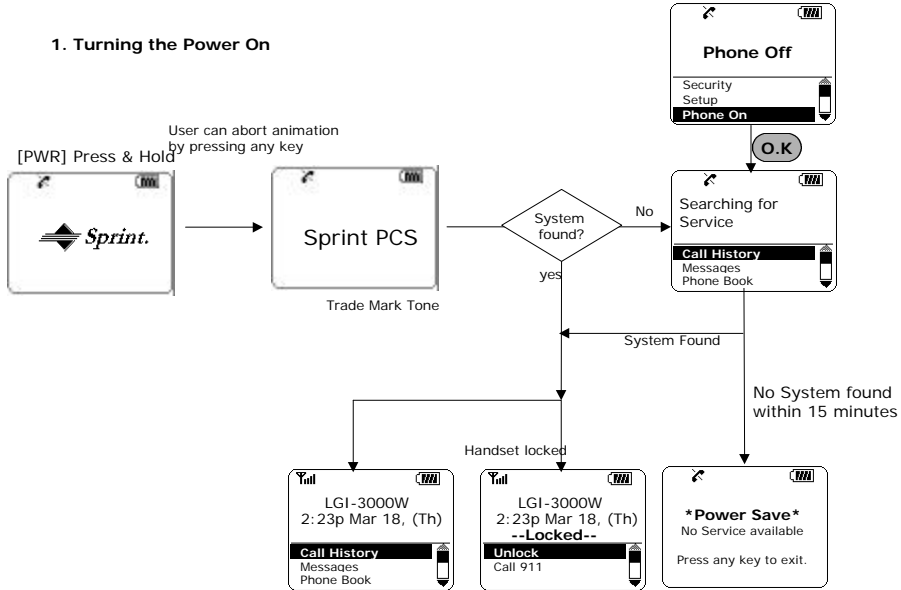

Phone Mode (Flip Closed)

Initial Screen (continued)

2. Power Off

2.1 System Power Off

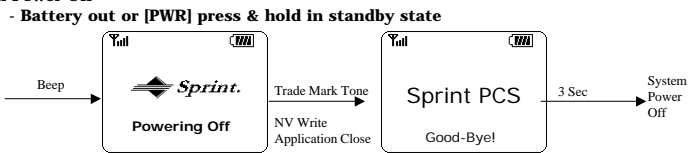

2.2 Phone Power Off

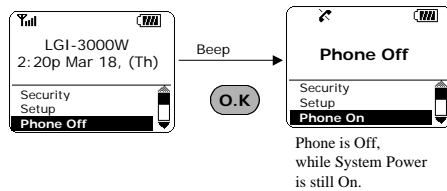

Phone Mode (Flip Closed)

Initial Screen (continued)

3. Standby State

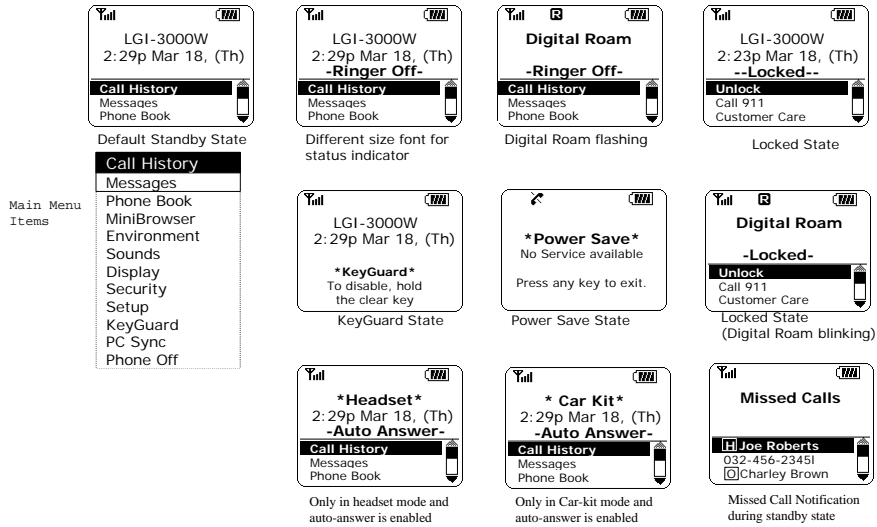

Phone Mode (Flip Closed)

Call Origination

1. 1-Digit Input

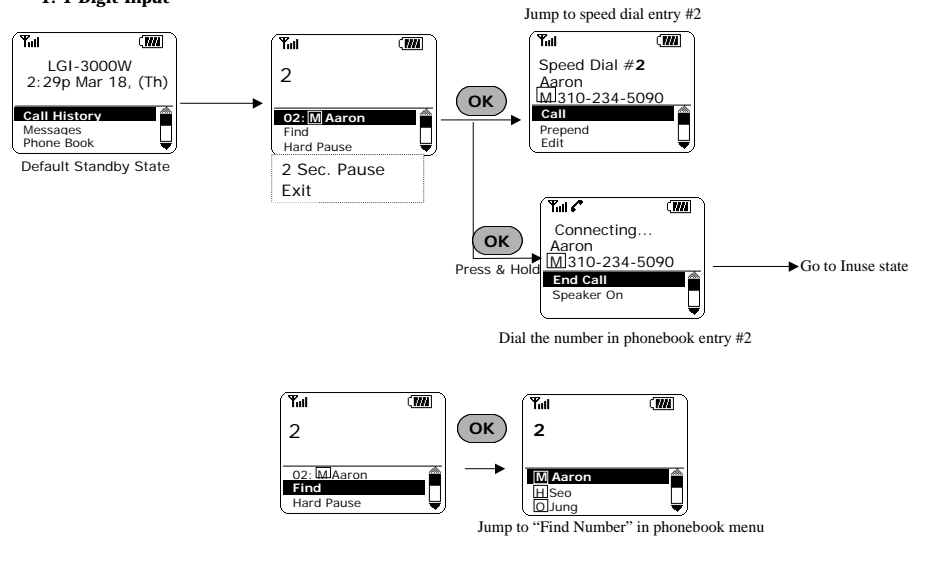

Phone Mode (Flip Closed)

Call Origination (continued)

2. 4-Digit Input

If there are more than two phone numbers of "6595" in phone book.

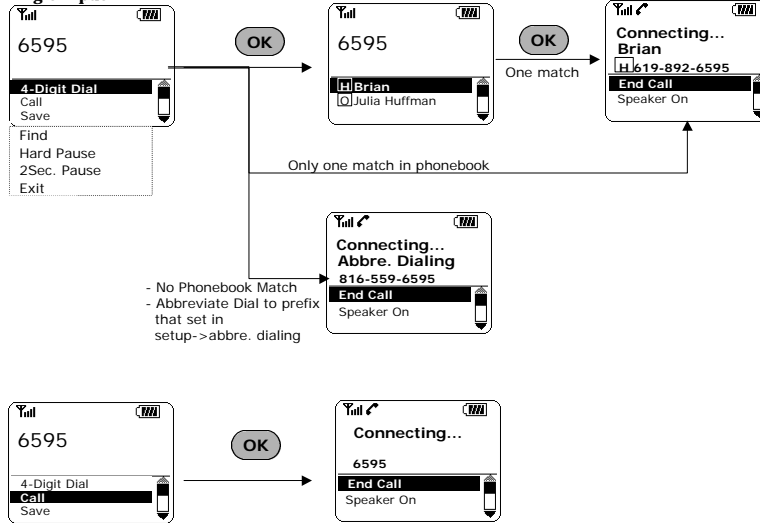

Phone Mode (Flip Closed)

Call Origination (continued)

3. Others

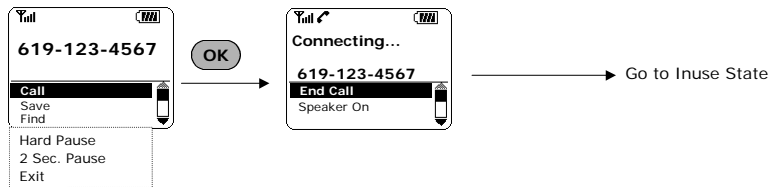

4. Dynamic Numeric Character Sizing

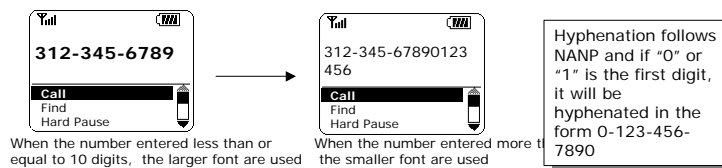

Phone Mode (Flip Closed)

Call Origination (continued)

5. Voice Dialing

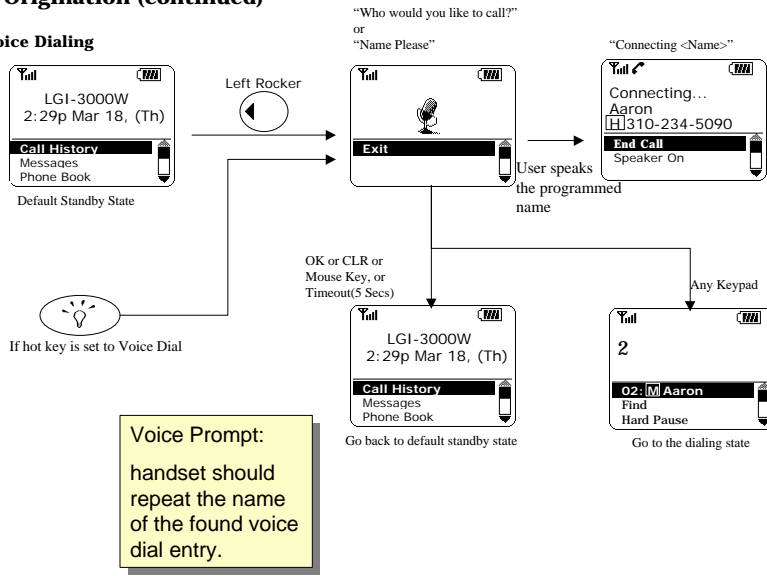

Phone Mode (Flip Closed)

Call Origination (continued)

6. Continue Dialing after Pause

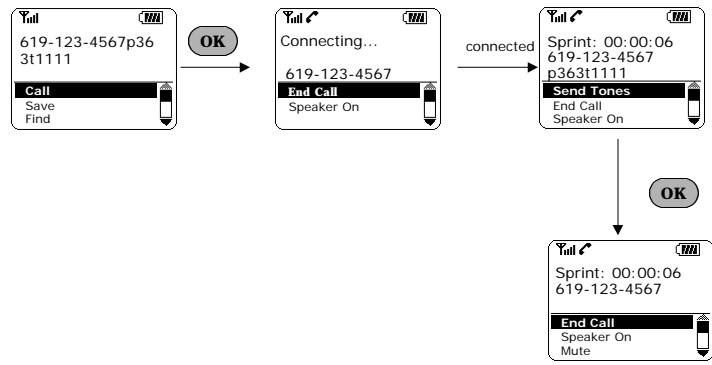

Phone Mode (Flip Closed)

Incoming Call / In use / End Call

1. Incoming Call

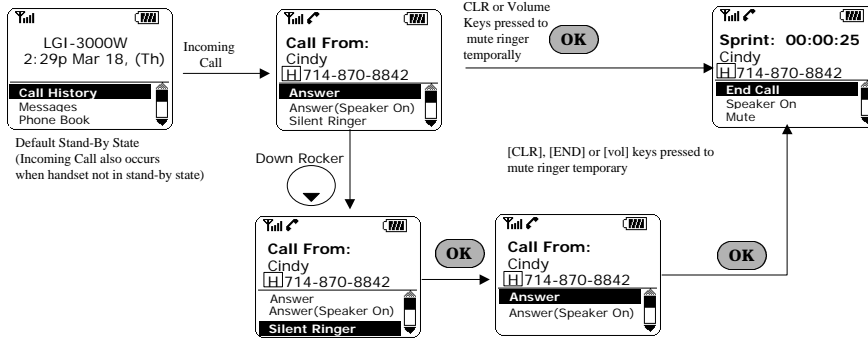

Phone Mode (Flip Closed)

Incoming Call / In use / End Call (continued)

2. In Use State

2.1. Default Inuse State

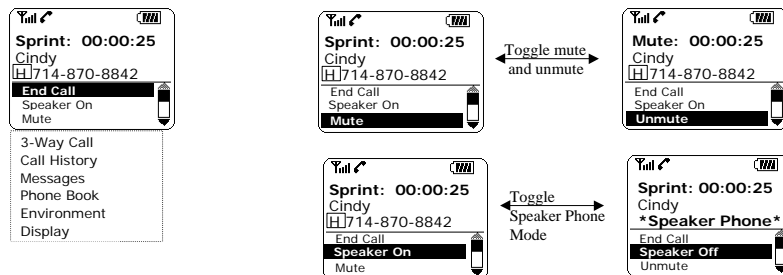

2.2. Call Waiting State



Call Waiting State(Call Waiting Blinks) same menu options in Roaming

2.3. Roam State

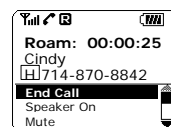

Default In Use State(ROAM Blinks)

3-way call may not be applicable in roaming, especially analog roaming. The menu option "Flash" will be used instead

Phone Mode (Flip Closed)

Incoming Call / In use / End Call (continued)

2. In Use State

2.4. 3-Way Call

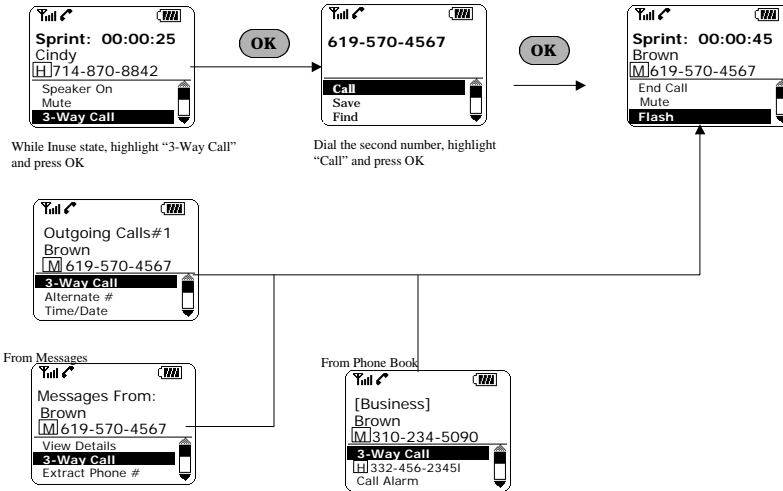

Phone Mode (Flip Closed)

Incoming Call / In use / End Call (continued)

3. End Call & Post-Call Number Storage

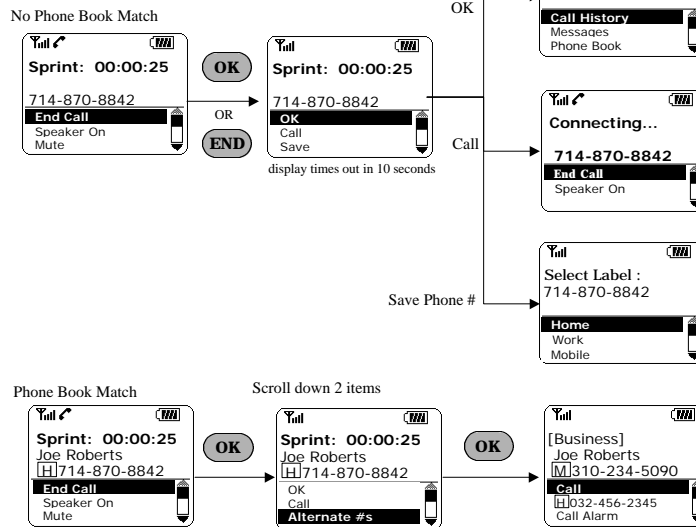

Phone Mode (Flip Closed)

Locked State

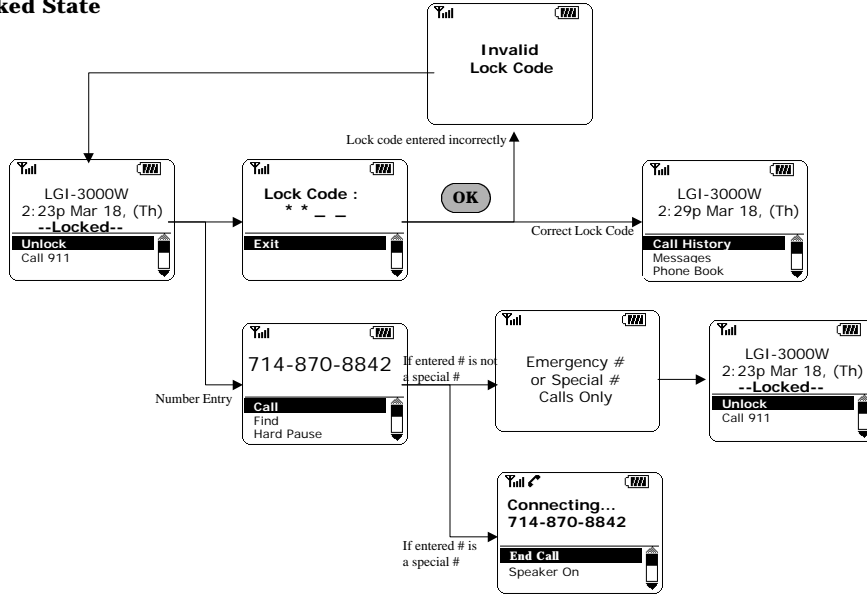

Phone Mode (Flip Closed)

Main Menu

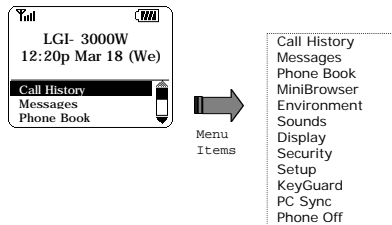

Phone Mode (Flip Closed)

Menu : Call History(Continued)

Add "Return Call" Statue to Missed Call

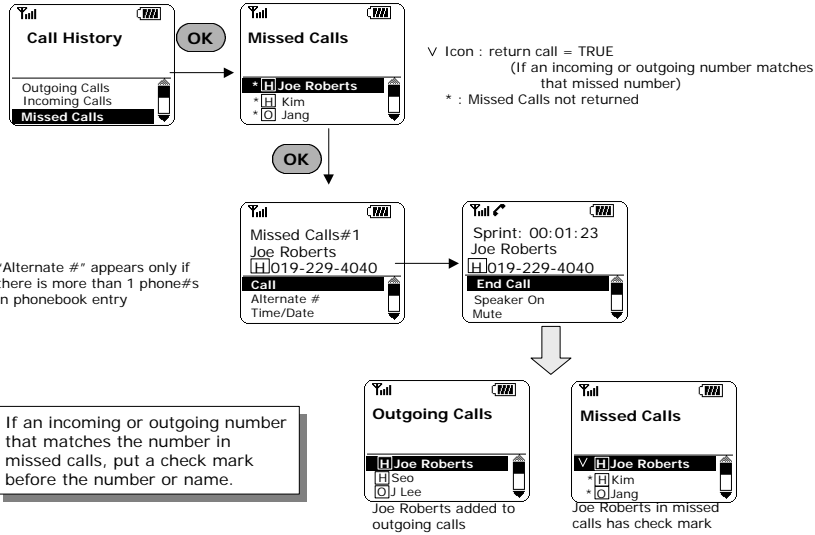

Phone Mode (Flip Closed)

Menu : Call History (continued)

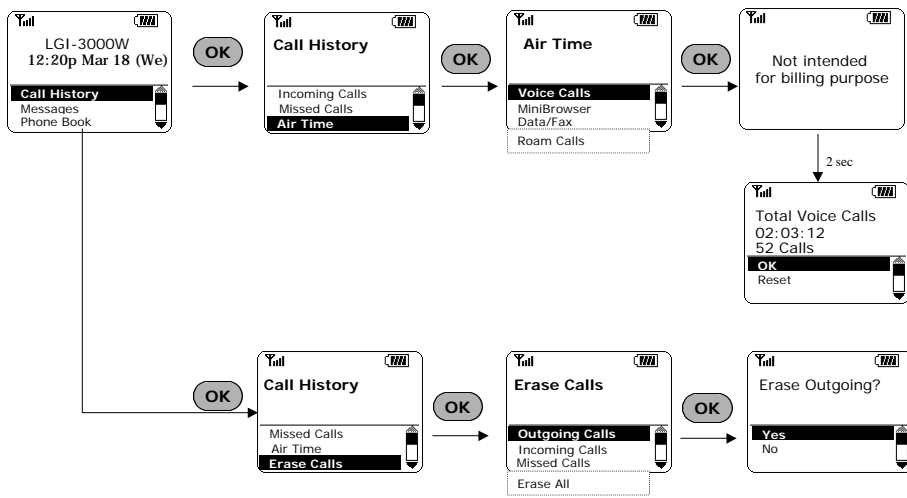

Phone Mode (Flip Closed)

Menu : Messages (continued)

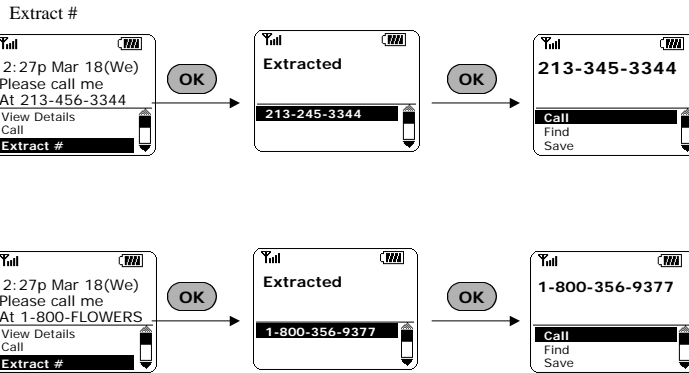

Phone Mode (Flip Closed)

Menu : Messages (continued)

Make New Folder from Received Msg

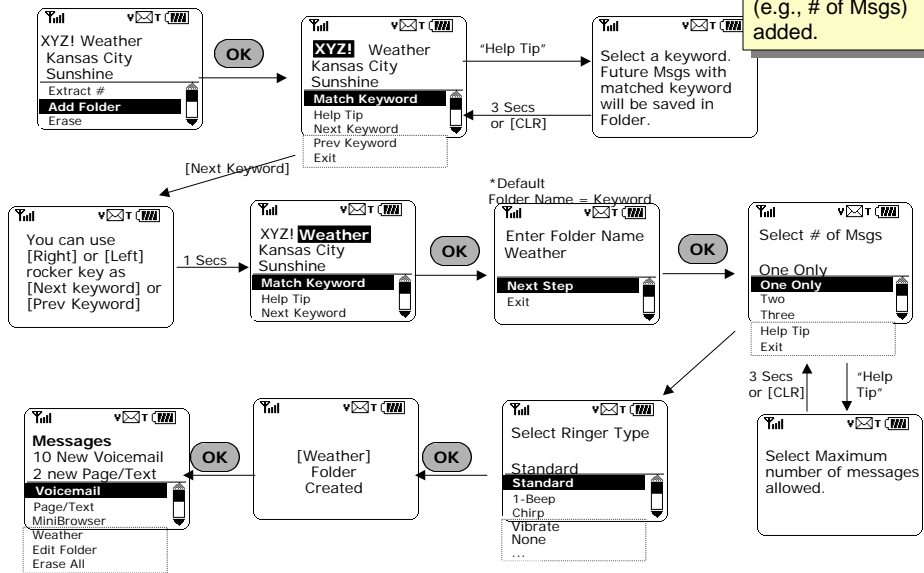

Phone Mode (Flip Closed)

Menu : Messages (continued)

Edit Folder - Modify Folder

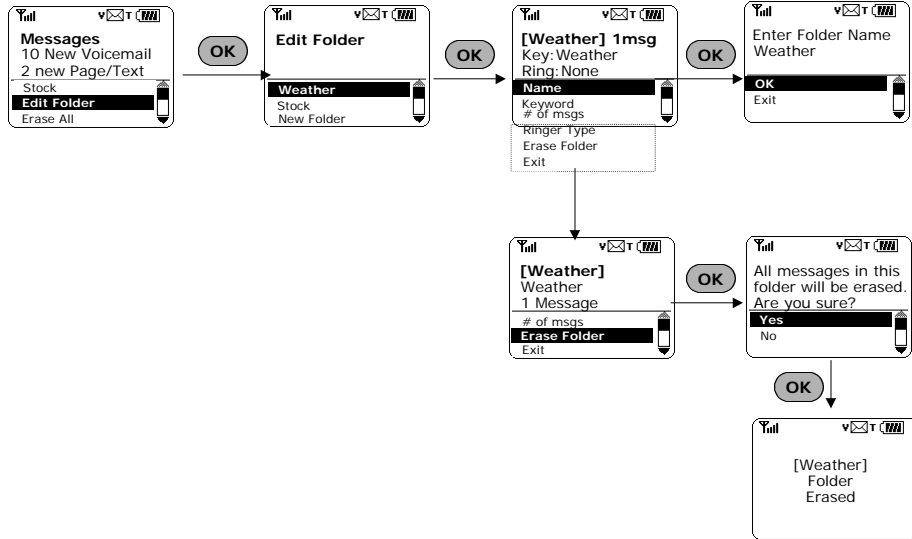

Phone Mode (Flip Closed)

Menu : Messages (continued)

Edit Folder - New Folder

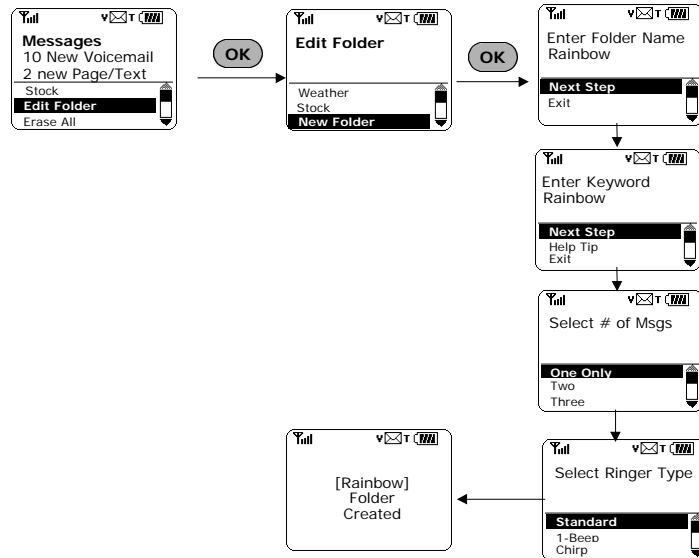

Phone Mode (Flip Closed)

Menu : Messages (continued)

SMS Notification when locked or keyguard state

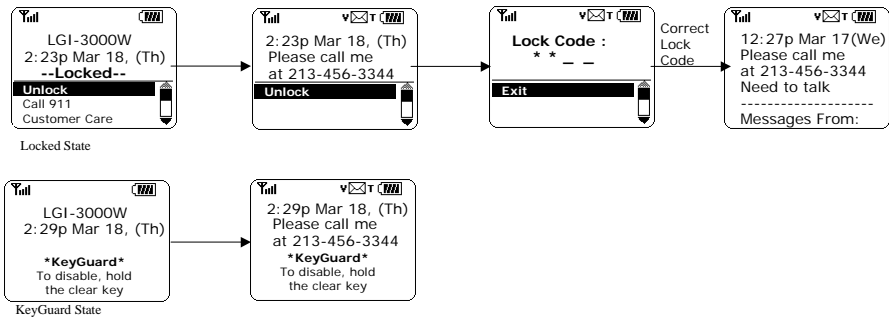

Phone Mode (Flip Closed)

Menu : Phone Book

Look up Name

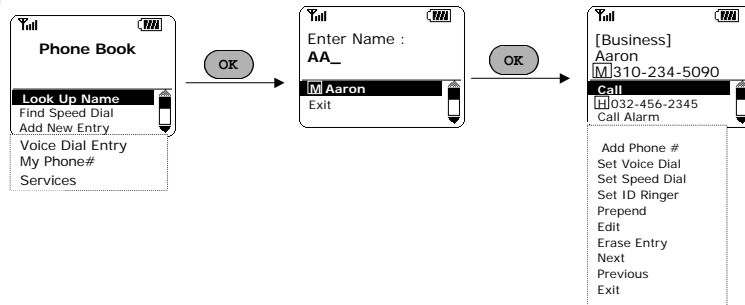

Phone Mode (Flip Closed)

Menu : Phone Book

Find Speed Dial

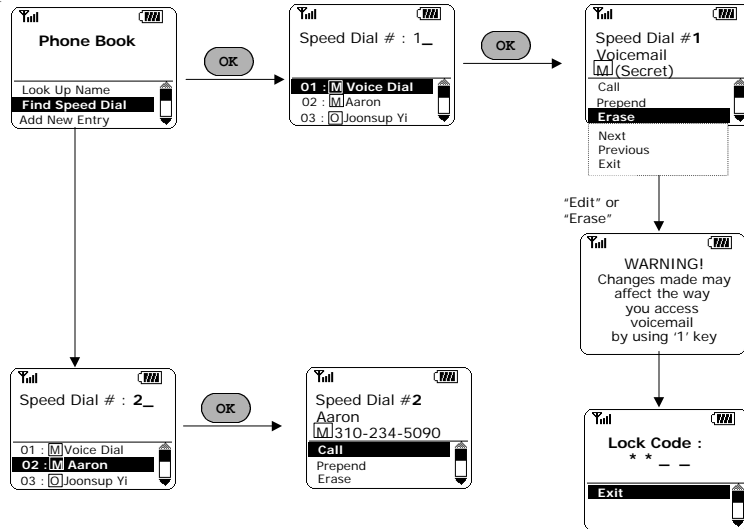

Phone Mode (Flip Closed)

Menu : Phone Book (continued)

Look Up Name -> Call Alarm

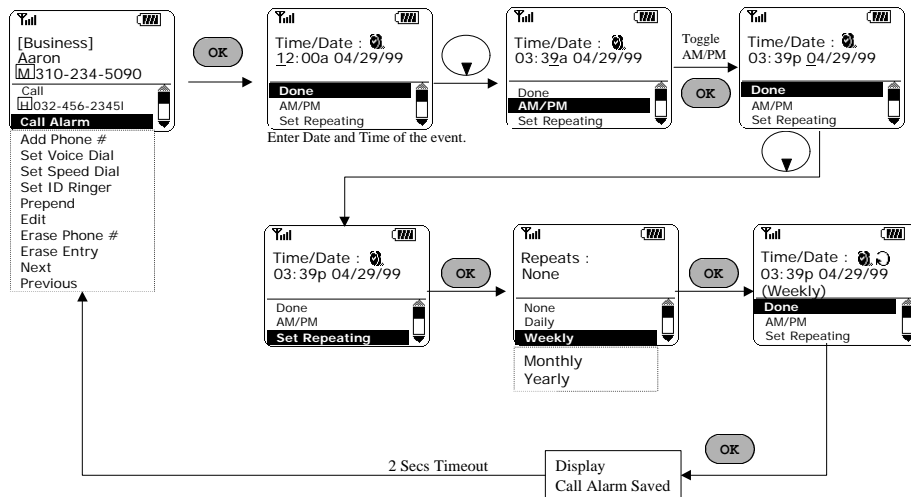

Phone Mode (Flip Closed)

Menu : Phone Book (continued)

Look Up Name -> Add Phone #

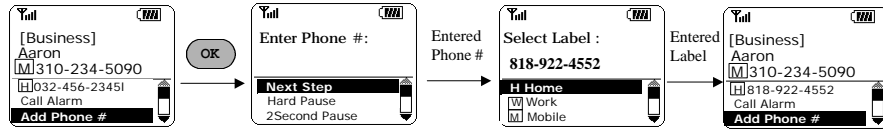

Phone Mode (Flip Closed)

Menu : Phone Book (continued)

Look Up Name -> Set Voice Dial

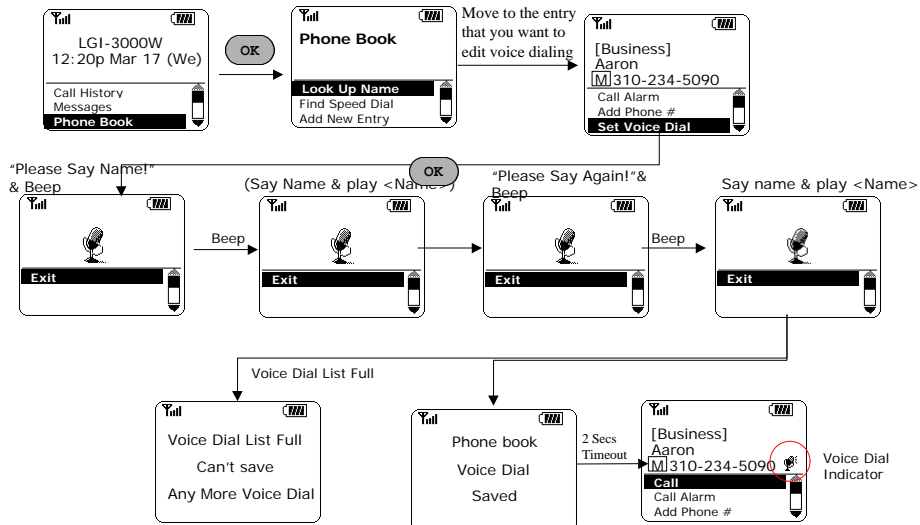

Phone Mode (Flip Closed)

Menu : Phone Book (continued)

Look Up Name -> Set Speed Dial

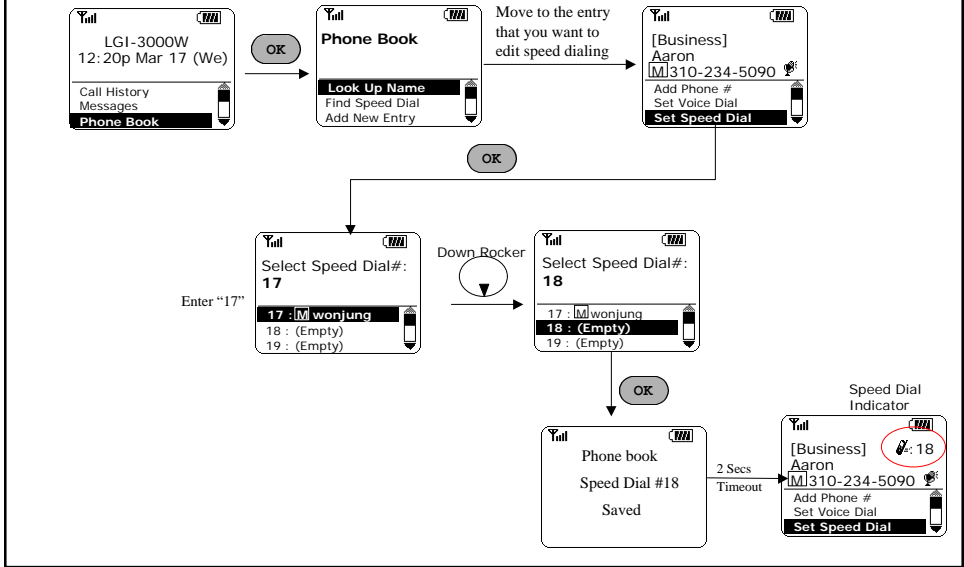

Phone Mode (Flip Closed)

Menu : Phone Book (continued)

Look Up Name -> Edit

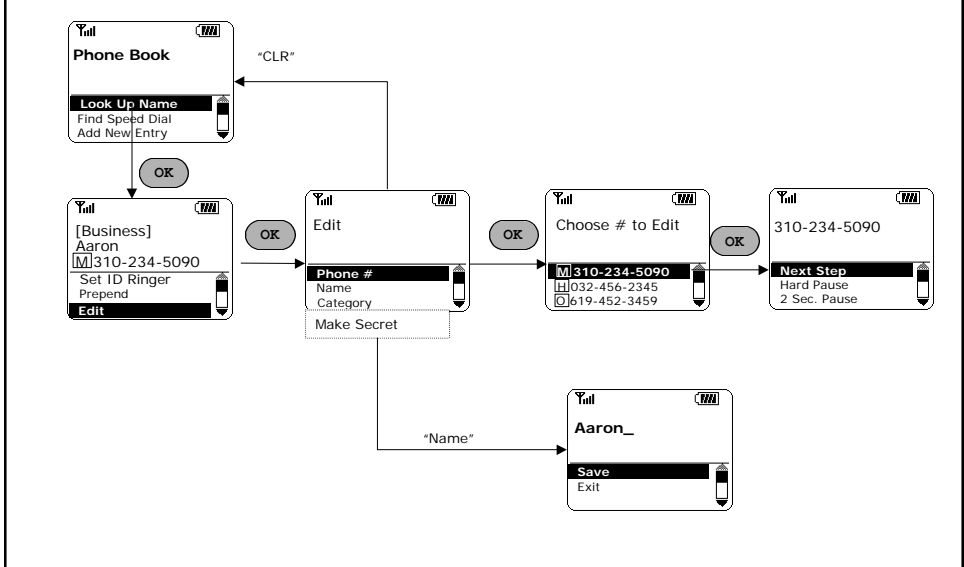

Phone Mode (Flip Closed)

Menu : Phone Book (continued)

Look Up Name -> Edit(continued)

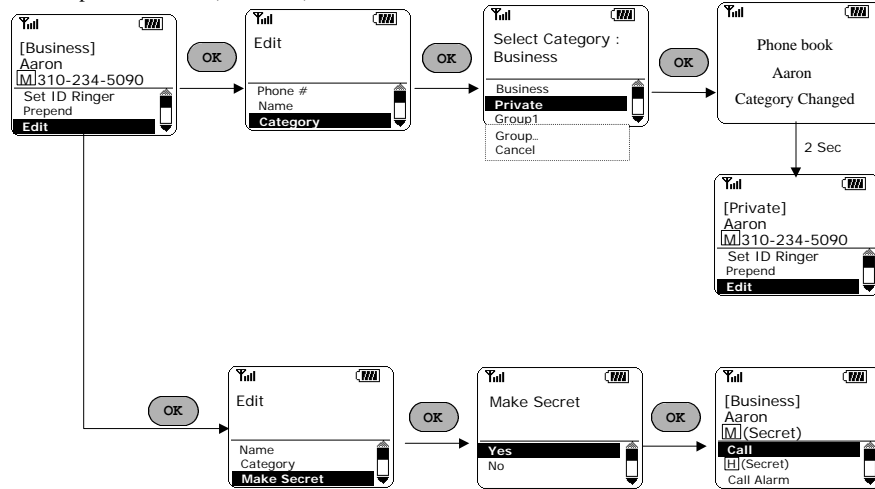

Phone Mode (Flip Closed)

Menu : Phone Book (continued)

Look Up Name -> Secret Item Edit(continued)

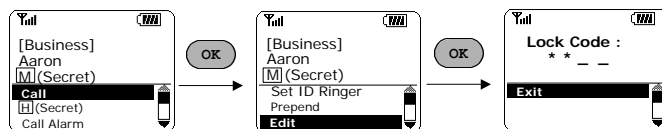

Phone Mode (Flip Closed)

Menu : Phone Book (continued)

Add New Entry

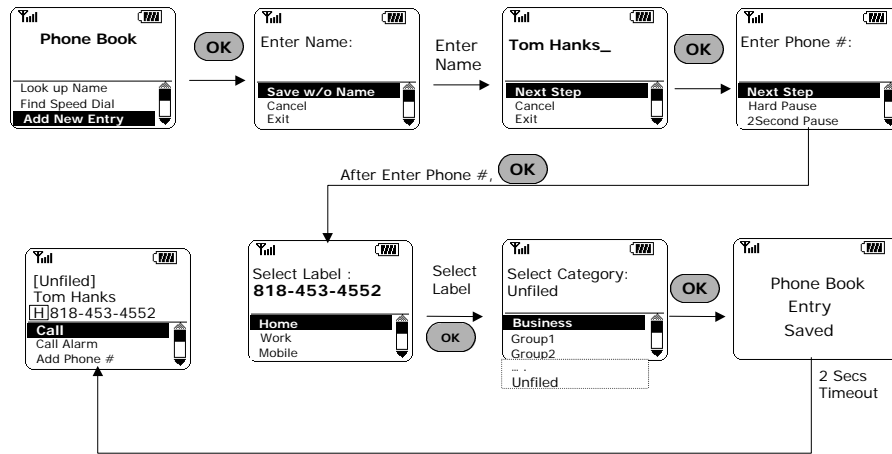

Phone Mode (Flip Closed)

Menu : Phone Book (continued)

Voice Dial Entry

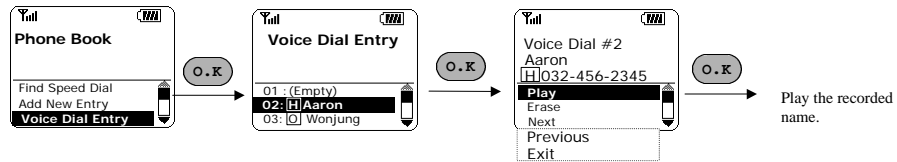

My Phone #

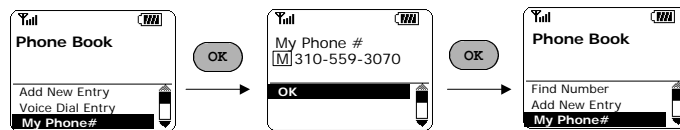

Phone Mode (Flip Closed)

Menu : Phone Book (continued)

Services

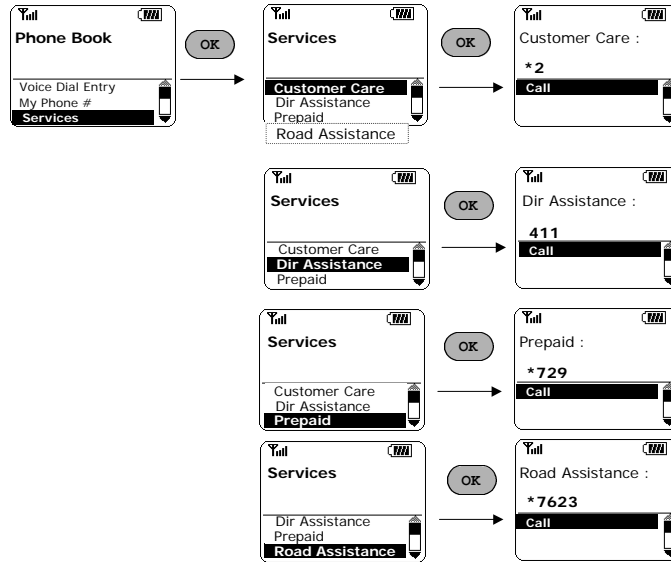

Phone Mode (Flip Closed)

Menu : MiniBrowser

Display Card

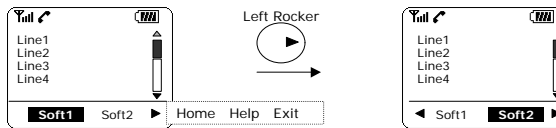

Choice Card

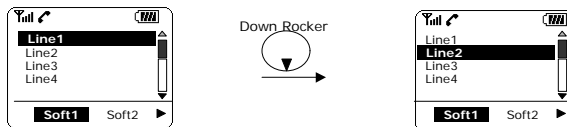

Entry Card

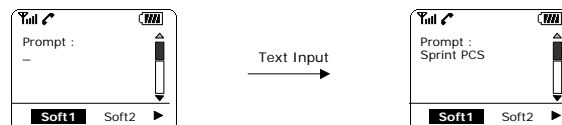

Phone Mode (Flip Closed)

MiniBrowser Prompt To Start

"To Start" or "Both"

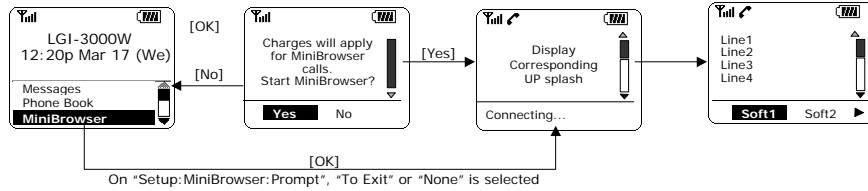

On "Setup:MiniBrowser:Prompt", "To Exit" or "None" is selected

MiniBrowser Prompt To Exit

"To Exit" or "Both"

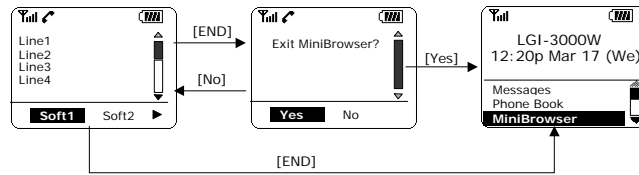

On "Setup:MiniBrowser:Prompt", "To Start" or "None" is selected

Phone Mode (Flip Closed)

Menu : Environment

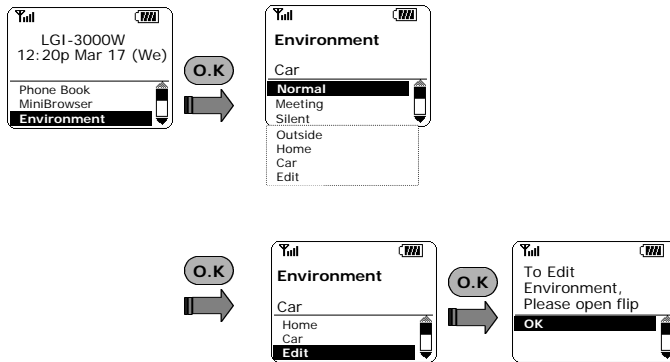

Phone Mode (Flip Closed)

Menu : Sounds

1. Volume

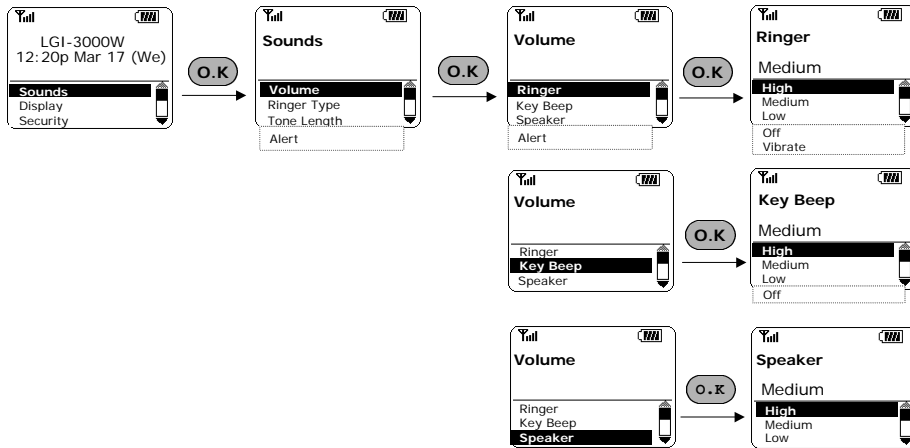

Phone Mode (Flip Closed)

Menu : Sound (continued)

2. Ringer Type

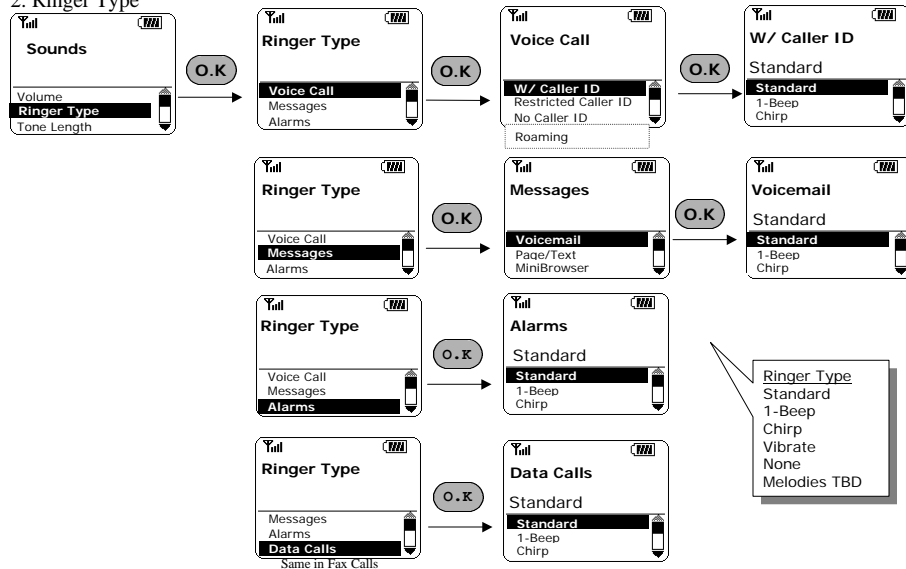

Phone Mode (Flip Closed)

Menu : Sound (continued)

3. Tone Length

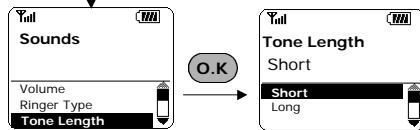

4. Alert

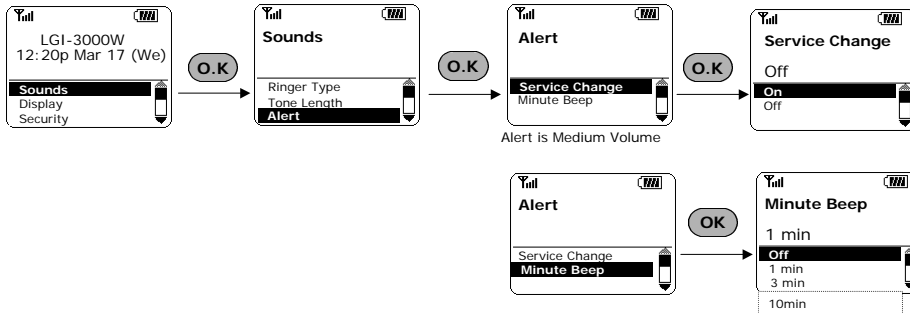

Phone Mode (Flip Closed)

Menu : Display

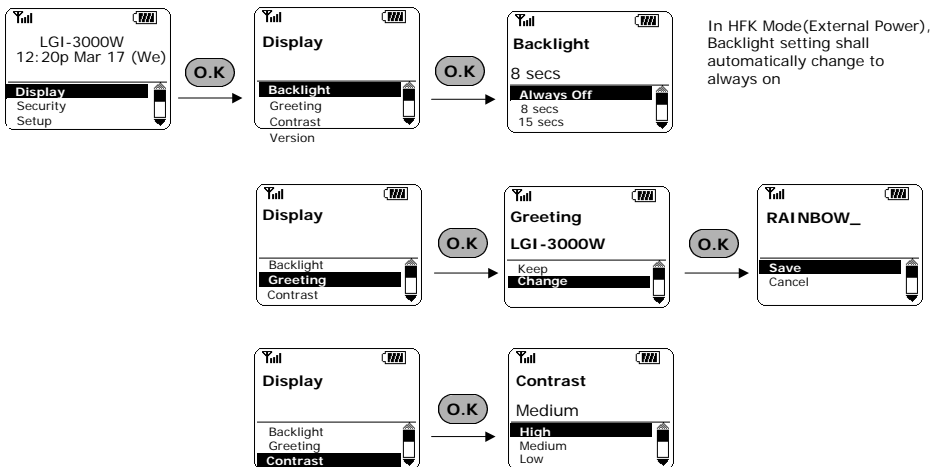

Phone Mode (Flip Closed)

Menu : Display (continued)

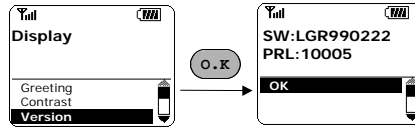

Phone Mode (Flip Closed)

Menu : Security

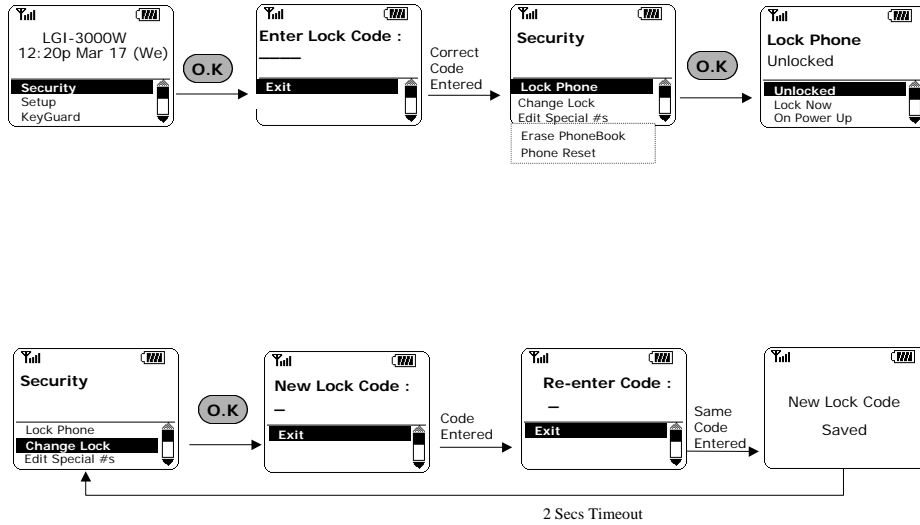

Phone Mode (Flip Closed)

Menu : Setup(Continued)

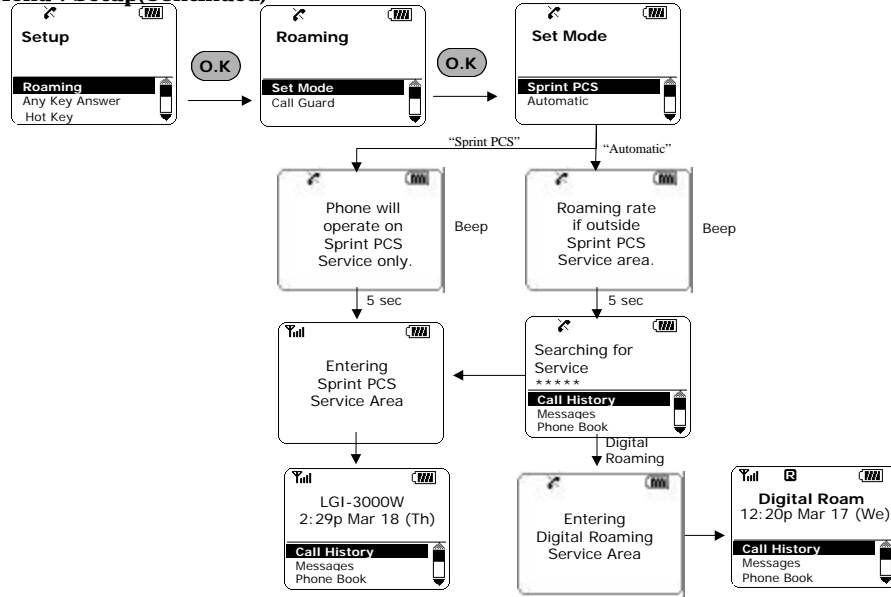

Phone Mode (Flip Closed)

Menu : Setup:Roaming:Call Guard

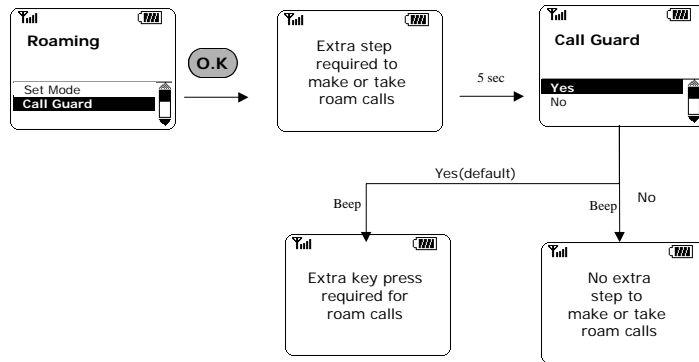

Phone Mode (Flip Closed)

Menu : Setup(Continued)

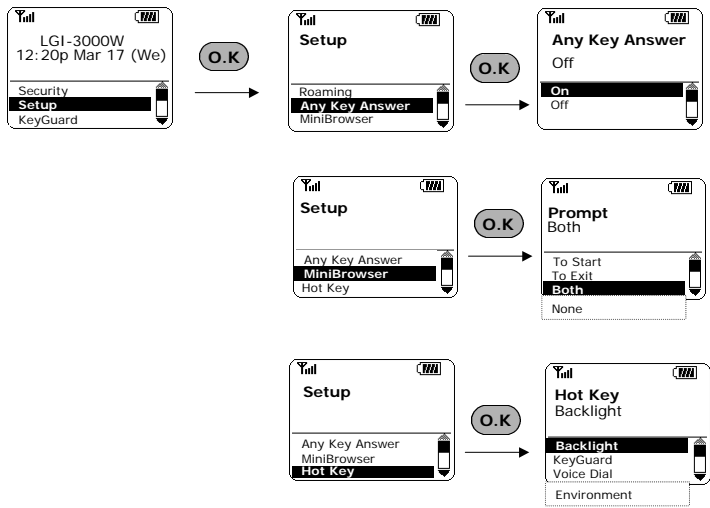

Phone Mode (Flip Closed)

Menu : Setup(Continued)

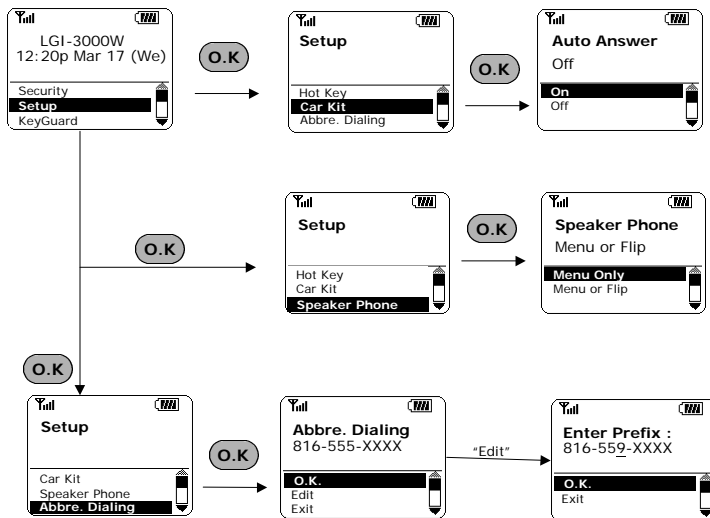

Phone Mode (Flip Closed)

Menu : KeyGuard

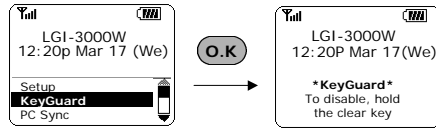

Phone Mode (Flip Closed)

Menu : PC Sync

