

**CDMA Fixed Wireless Telephone
User Manual**

Model: LSP-2000



FCC RF EXPOSURE INFORMATION

WARNING! Read this information before using your phone

In August 1996 the Federal Communications Commission (FCC) of the United States with its action in Report and Order FCC 96-326 adopted an updated safety standard for human exposure to radio frequency (RF) electromagnetic energy emitted by FCC regulated transmitters. Those guidelines are consistent with the safety standard previously set by both U.S. and international standards bodies. The design of this phone complies with the FCC guidelines and these international standards.



To comply with FCC RF exposure requirements, a minimum separation distance of 2 cm (0.8 inches) must be maintained between the user/bystander and the back of the phone, including the antenna.

For more information about RF exposure, please visit the FCC website at www.fcc.gov

REVISED HISTORY

DATE	ISSUE	CONTENTS OF CHANGES	REMARK
1999/07	ISSUE 1	Initial Release	

Blank Page

CONTENTS

Highlights.....	5
1. Important Information.....	6
1.1 Safety Information	6
1.2 Optimal Phone Performance.....	6
1.3 Care and Service.....	7
2. Introduction.....	8
2.1 Front View of the Telephone.....	8
2.2 LCD Display.....	9
2.3 Installation.....	10
2.4 Installation Steps	12
3. Basic Operation.....	13
3.1 Making a Call.....	13
3.2 Redialing Last Outgoing Number	13
3.3 Receiving a Call.....	14
3.4 Signal Strength.....	14
3.5 Missed Call Message	14
4. List of Menu State.....	15
4.1 Select Volume	15
4.1.1 Ring Volume	15
4.1.2 Key Volume	16
4.1.3 Ear Volume.....	16
4.2 Ring Type Selection	16
4.3 Wake-up Time.....	16
4.4 Security	17
4.4.1 Lock Mode Set.....	17
4.4.2 Clear Calls.....	17
4.4.3 Clear Memory.....	18
4.4.4 Emergency Call.....	18
4.4.5 Changing Lock Code	18
4.5 Convenient Features	18
4.5.1 Hot Line	18
4.5.2 Hot Line Time.....	19
4.5.3 Speed Dial(enable/disable).....	19

4.6	Additional Feature	19
4.6.1	Key-tone Length.....	19
4.6.2	Auto Time-out.....	20
4.6.3	3 Minute Alert	20
5.	Function while in a Call	20
5.1	Ear Volume.....	20
5.2	MIC Volume	20
5.3	Mute	21
5.4	Memo	21
5.5	Transmitting your own number	21
6.	Searching, Editing & Dialing	22
6.1	Retrieving Last Call History.....	22
6.2	Retrieving Phone Number by Address.....	23
6.3	Retrieving Phone Number by Name	24
7.	SMS(Short Message Service).....	25
7.1	Check & Deleting Received Message	25
7.1.1	Text Message.....	25
7.1.2	Voice Message	26
7.2	Erasing all Message	26
7.3	Setting alert tone count	26
8.	Beside Functions	27
8.1	Redial.....	27
8.2	Viewing your own number.....	27
9.	Storing Phone Number	27
9.1	Storing / Editing Phone Numbers	27
9.1.1	Storing Phone Numbers	27
9.1.2	Erasing Stored Phone Numbers.....	28
9.2	Finding Stored Phone Numbers	29
10.	General Information	31

Highlights

Congratulations on your purchase of the LSP-200 Fixed Wireless Telephone. This telephone has been designed to operate on the latest digital mobile communications technology. This technology has greatly enhanced voice clarity and can provide various advanced features.

The telephone provides:

- 3-line LCD Display with status indicator
- A choice of 10 ring sounds
- A menu driven interface with prompts for easy operation
- Last Number Redial
- Speed Dialing with a 99-number memory
- Dial tone
- ROH (Receiver Off-Hook) tone
- Step Ring Volume Level Switch
- Internal Back-up Battery Pack
- AC Power Supply
- Dipole Antenna
- DB9 Data Port for service and repair

1. Important Information

1.1 Safety Information

Warning

To reduce the risk of fire or electric shock, do not expose this product to rain or moisture. Do not use this product near swimming pools or other bodies of water.

IMPORTANT

Before installing or operating this product, read this information before using your telephone.

1.2 Optimal Phone Performance

- Do not operate your product when holding the antenna, or when someone is within four inches (ten centimeters) of the antenna. Holding the antenna affects call quality and may cause the telephone to operate at a higher power level than needed.
- For the best call quality, keep the antenna free from obstructions and point the antenna straight up.
- Do not use the unit with a damaged antenna. Have your antenna replaced by a qualified technician immediately. Use only a manufacturer-approved antenna. Non-approved antennas, modifications, or attachments could impair call quality, damage the phone.
- RF energy may affect improperly installed or inadequately shielded personal medical devices such as pace markers, hospital monitor. Consult the manufacturer of any personal medical devices to determine if they are adequately shielded from external RF energy. Turn your terminal OFF in health care facilities when any regulations posted in the areas instruct you to do so. Hospitals or health care facilities may be using equipment that could be sensitive to external RF energy.
- If this equipment does cause harmful interference to radio or television reception, which can be determined by turning the equipment off and on, the user is encouraged to try to correct the interference by one or more of the following measures:
 - Reorient or relocate the receiving antenna
 - Increase the separation between the radio or television and the telephone.
 - Connect the equipment into an outlet on a circuit different from that to which the terminal is connected.
 - Consult you Authorized LGIC Dealer or an experienced radio/TV technician for help.
- Use only the battery, antenna and AC power supply provided by LGIC. Using any other type will invalidate the warranty.
- Only authorized personnel should service the phone and its accessories. Faulty installation or service may be dangerous and may invalidate the warranty.
- Do not use the unit in designated "no cellular phone use" area.
- Avoid exposure to high temperature or humidity.
- Avoid wetting the unit with any liquids. If the unit gets wet, turn the power off immediately and remove the backup battery and AC power supply. If the unit is inoperable, then return to the service agent for service.
- Avoid shock or impact.
- We recommend you to charge the backup battery before initial use. Backup battery may be discharged during delivery.

1.3 Care and Service

- Unplug the telephone from the wall outlet and remove antenna (or disconnect antenna cable) before cleaning. Do not use liquid or aerosol cleaners. Use a damp cloth for cleaning.
- If the unit fails for any reason, do not attempt to disassemble; contact the telephone service provider for assistance.
- If any of the following conditions exist; unplug the unit at the wall plug, remove battery, and call the service provider.
 - The power supply cord is damaged or frayed.
 - Liquid has been spilled into the unit.
 - The unit has been exposed to rain or water.
 - The unit has been dropped or damaged.
 - The unit does not work normally by following the operating instructions.

2. Introduction

2.1 Front View of the Telephone

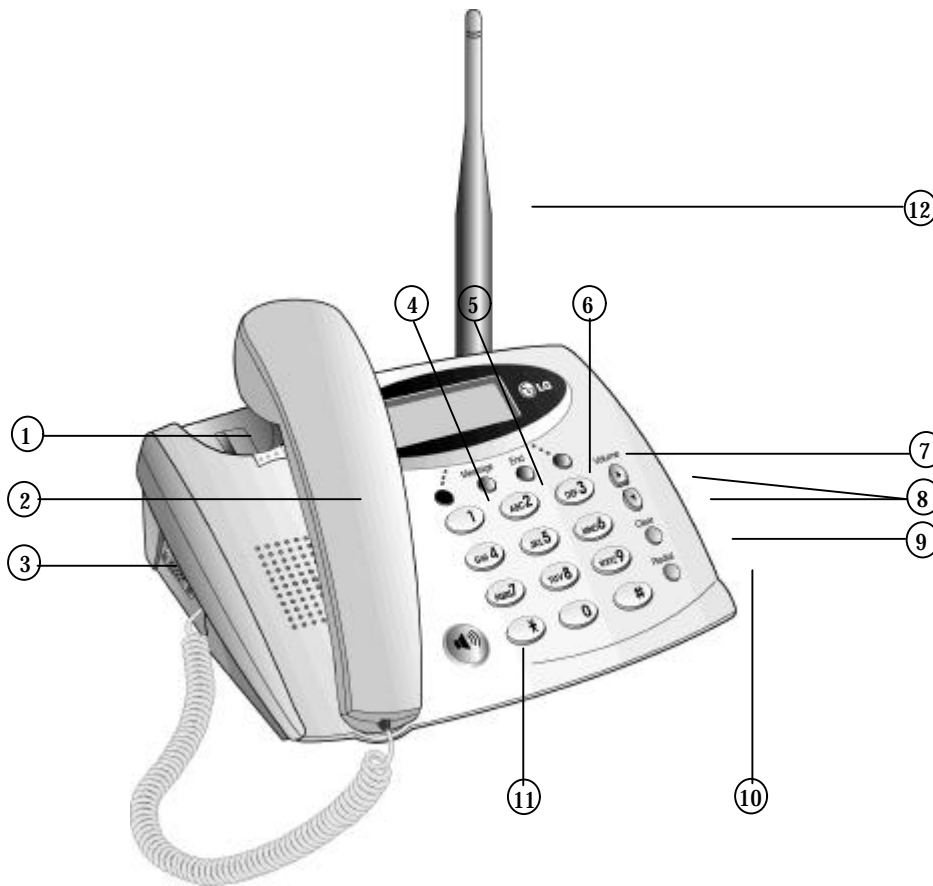

Hook Switch
Base Handset
DB-9 Port

Used for data communication or service.
personnel.

Soft Key 1

Displays main menu features and also
used as soft key while setting menu items
in sub-field.

Message Button

Press to view text or voice message.

End Button

Exit all the way out of a menu back to the
phone's standby display without changing
any setting.

Soft Key 2

Displays recall menu feature and also
used as soft key while setting menu items
in sub-field.

Volume Up/Down Button

Used for volume control and scroll
through menu.

Clear Button

Press to erase displayed letters, numbers
or returns to the previous menu option.

Redial Button

Press to dial the last dialed number or
display its own number.

OHD Button : On Hook Dialing

Dipole Antenna

2.2 LCD Display

The LCD shows icons on the top of the LCD screen.

Different indicator appears based on the phone's operating mode.

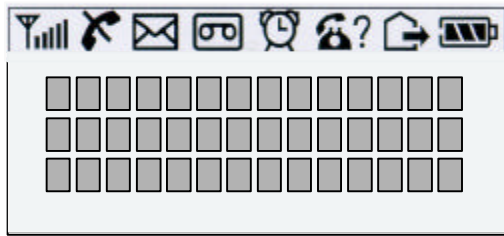

- 1) RSSI indicator : Indicates the signal strength in the service area.



- 2) No service : The phone is not receiving system signal.
- 3) In use : Call is in progress.



: No service



: In use

- 4) Text message : Displayed when a text message is received.



- 5) Voice message : Displayed when a voice message is received.



- 6) Alarm : Displayed when wake up alarm time was setting.



- 7) Caller ID : Displayed when caller ID is received.



- 8) OUT : Not used



- 9) Battery charge level : Indicates battery charge level.



2.3 Installation

You should follow each step carefully as shown below in order to guarantee proper operation of CDMA Fixed Wireless Telephone.

STEP I. Check Components

- Fixed Wireless Terminal is supplied with the following standard unit and accessories;
 1. LSP-200 Main Unit with Handset -1EA-
 2. Dipole Antenna -1EA-
 3. Backup Battery -1EA-
 4. User Guide -1EA-
 5. AC/DC Power Adapter -1EA-
 6. Power Cord(Only SMPS Adapter) -1EA-
- Please make sure that these components are present before you begin the unit installation. And then compare the following figures and components. If components are missing or damage is found, contact the store where you purchased the unit immediately.

STEP II. Place the Terminal

- Place the terminal on the stable flat secure surface area (desk, table, etc.). Serious damage may result if the unit falls. Do not place the unit on, or within 1 meter of heaters or radiators. This unit is designed for desktop usage. Avoid direct exposure to the sun lights and damp area.
- Read the SAFETY INFORMATION located at the first part of this document before you place the terminal

STEP III. Connect Components (See the figures in "Installation Steps".)

- Connect the antenna to the TNC antenna connector located at the top side of the terminal. If you placed the terminal on the flat surface, bend the antenna up right.
- Connect curl cord of handset assembly to the RJ-11C port located at the left side of the terminal.
- Open the battery case, securely connect the battery cord, place the backup battery pack and close the case.
- Connect the AC/DC Adapter cable to the DC input port located at the topside of the terminal.
- Please follow the below to get better voice quality;
 1. Keep away from electrical appliances such as TV, computer, radio and so on.
 2. Keep terminal in a high and central location with no obstructions, such as metal walls.
 3. Raise the integral antenna of terminal to get maximum strength of receive signal as shown figure at the next page.



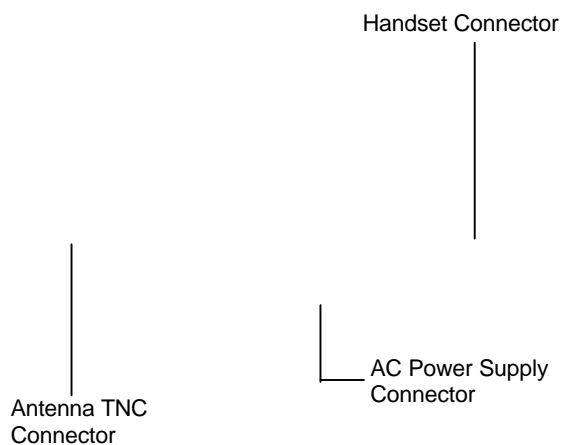

STEP IV. Check the LCD Display

- After you follow the installation instruction **step I** to **step III**, please check the LCD for normal operation.
- If you may not see status of service, please repeat the 5th instruction of **step III**. And conform Fixed Wireless Telephone to get the proper signal strength from service operator system.

P2.4 Installation Steps

lease follow the below procedure to install the unit properly.



1 Connect Base-handset to the handset connector.

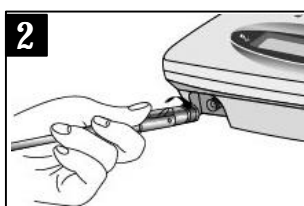

2 Connect the antenna to the TNC connector (Turn right).



3 Bend the antenna up right.



4 Open the battery cover at the bottom of the unit.

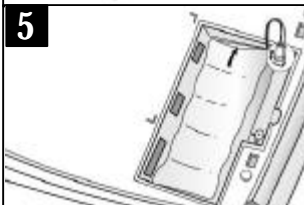

5 Insert back-up battery in the bottom of the unit.



6 Connect the AC power supply.

3 Basic Operation

3.1 Making a Call

1. Pick up the handset or press  button.
2. Listen for dial tone
3. Enter the phone number with area code if needed.

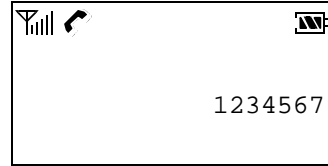

4. Wait for the Auto Time-out.

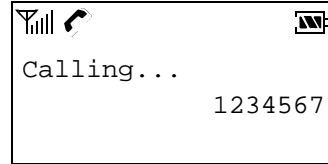

5. The call is connected and you can start conversation.
6. To disconnect the call, replace the handset or press  button.

3.2 Redialing Last Outgoing Number

Pick up the handset or press  button.

Listen for dial tone.

Press **Redial** button. The last number that you called will be re-dialed.

- **Correcting dialing mistakes**
 1. Press **Clear** button shortly to erase the most recent digit.
 2. Press and hold **Clear** button for at least one second.
- If the phone is locked ,enter the Lock Code
- If the call did not go through, press the hook switch and dial again.
- **Flashing / Hook Switch**
 1. While in the middle of a call, pressing the hook switch for less than 1 second will be treated as a flash. After 1 second, the call will be terminated.
 2. Very briefly pressing the hook switch will be ignored.
- Battery icon is displayed only when the terminal is battery operating without AC power.

3.3 Receiving a Call

1. When bell rings, pick up the handset.
2. Start conversation.

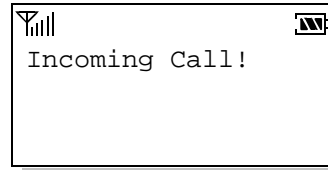

3. To disconnect the call, replace the handset.

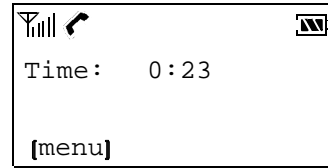

3.4 Signal Strength

The quality of calls depends on the signal strength in your area. The stronger the signal, the better the call quality. The signal strength icon indicates the current strength as a number of bars. You can see the antenna and bars according to the strength of received signal in the upper-left part.

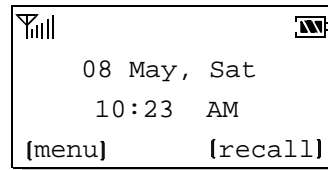

3.5 Missed Call Message

If a call is received and not answered for user's absence, You are informed that you have missed a call. The latest missed call time and number of missed call is displayed. Press **[ok]** to erase "Missed call" message.

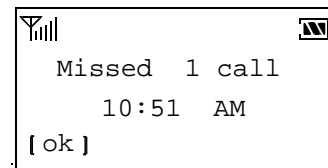

4. List of Menu State

Main Menu	Sub-Menu	Setting Value	Default
1. Select Volume	1. Ring Volume	3 steps	
	2. Key Volume	3 steps +silent	
	3. Ear Volume	3 steps	
2. Ring Select	-	10 types	
3. Wake-up Time	-	12 hour (AM/PM)	
4. Security	1. Lock Mode Set		
	2. Clear Calls	10 ea.	
	3. Clear Memory	99ea	
	4. Emergency Call	Local (3 ea.)	
	5. Lock Code	4 digit	
5. Convenient	1. Hot Line	Enable/Disable	
	2. Hot Line Time	2-9 Sec.	
	3. Speed Dial	Enable/Disable	
6. Additional	1. Key Tone Length		
	2. Auto Time-out	2-9 Sec.	
	3. 3 Min. Alert	Enable/Disable	

4.1 Select Volume

This menu allows you to adjust the various different volumes.

4.1.1 Ring Volume

The received tone when you receive a call can be adjusted.

- From the MENU

1. Press **[menu]** + **1**(Select Volume)+ **1**(Ring Volume) in on-hook state.
2. Press **Volume** button or **[next]** to adjust ring volume.
3. Press **[ok]**

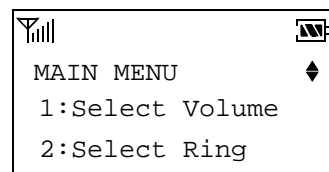

- By the **Volume** button

1. Press **Volume** button to adjust ring volume in on-hook state

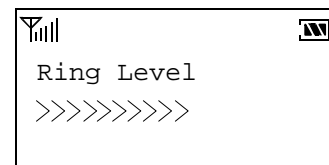
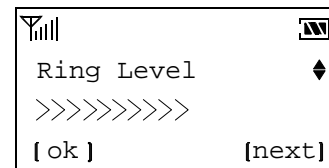

4.1.2 Key Volume

The tone when you press a key can be adjusted.

1. Press **[menu]** + **1**(Select Volume) + **2**(Key Volume) in on-hook state.
2. Press **Volume** button or **[next]** to adjust key volume.
3. Press **[ok]**

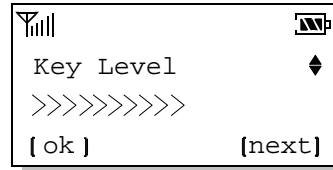

4.1.3 Ear Volume

The voice of the other party can be adjusted in on-hook state.

1. Press **[menu]** + **1**(Select Volume) + **3**(Ear Volume) in on-hook state.
2. Press **Volume** button or **[next]** to adjust ear piece volume
3. Press **[ok]**
 - ✓ Press **Volume** button to adjust volume during conversation

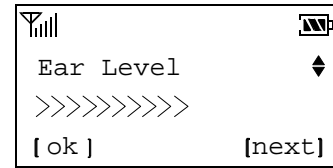

4.2 Ring Type Selection

You can select the various ring types

1. Press **[menu]** + **2**(Select Ring) in on-hook state.
2. Select a desired ring type with **Volume** button or **[next]**.
 - ✓ There are 10 different ring types.
 - ✓ Those are General, Chime, Cord, Escalate, Jewel, Pathetique, Bolero, Edelweiss, Csikos Post, Sweet Home.
3. Press **[ok]** to save and exit.

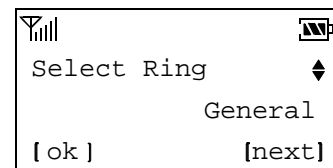

4.3 Wake-up Time

This function allows you to adjust Wake-up Time.

1. Press **[menu]** + **3**(Wake-up Time)

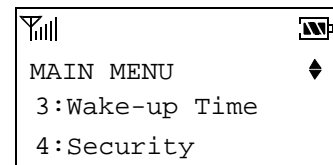

Select Always, once or off by [next] and press [ok].

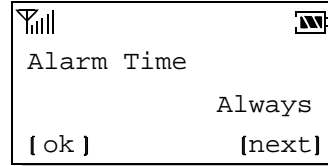

2. Press [edit] and set the time.

3. Select A.M. or P.M. by [AM/PM].

4. If you want to modify the wrong time, press **Clear** button and set again.

5. Press [ok] to save and exit

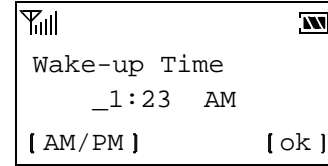

4.4 Security

4.4.1 Lock Mode Set

This function prevents your phone from being used without permission. Typical default value is 0000. Possible settings are **off**, **power on** and **always**. The **off** means that the phone is not locked. **Power on** locks the phone when the phone is turned on. **Always** sets the phone locked immediately.

Press [menu] + 4 (Security)

Enter your own 4 digit lock code

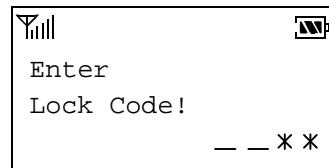

Press 1(Lock Mode Set)

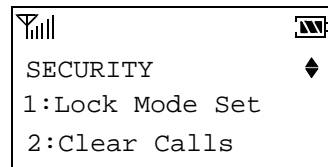

Select **off**, **power on** or **always** by [next] or **Volume** button.

Press [ok] to save and exit.

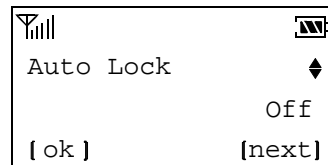

4.4.2 Clear Calls

When a previous outgoing or incoming call history is stored in a memory location, you can erase the all call history.

1. Do the above 1 and 2 steps of 4.4.1.

2. Press 2(Clear Calls)

3. Press [yes] to erase all call history

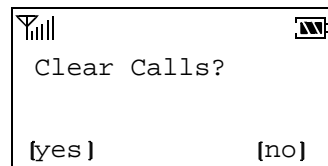

4.4.3 Clear Memory

When you want to delete phonebook memory, you can erase all phonebook memory.

1. Do the above step1 and 2 of 4.4.1.
2. Press **3**(Clear Memory).
3. Press **[yes]** to erase all phone memory.

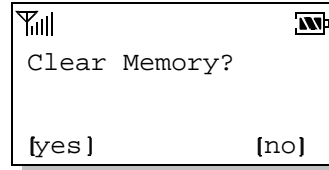

4.4.4 Emergency Call

Even if your phone is locked you can make calls to 3 emergency numbers.

1. Do the above step1 and 2 of 4.4.1.
2. Press **4**(Emergency Call)
3. Press **[next]** or **Volume** button to choose the number from 1 to 3
4. Press **[edit]**.
5. Enter the emergency phone number
6. Press **[ok]** to save the number

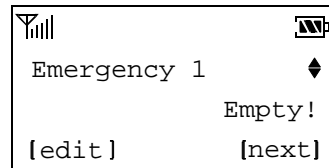

5. Enter the emergency phone number
6. Press **[ok]** to save the number

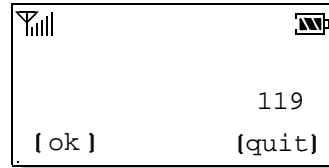

7. Press **[next]** to edit others or Press **End** button to exit emergency call process

4.4.5 Changing Lock Code

You can change a new lock code(4digits).

1. Do the above step1 and 2 of 4.4.1.
2. Press **5**.(Lock Code)
3. Enter new lock code and press **[ok]** to save.
4. Enter new lock code again to confirm and press **[ok]** to save.

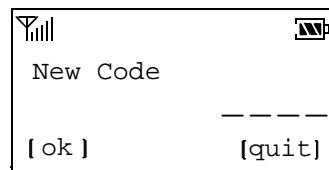

4.5 Convenient Features

While the Hot line function is enabled, the programmed number will be automatically dialed when you pick up the handset and wait for the programmed hot line time (2~9 sec) without any key press.

4.5.1 Hot Line

1. Press **[menu] + 5** (Convenient)
2. Press **1**(Hot Line)

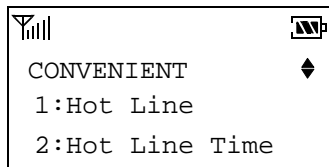

3. Select **on** or **off** by [**next**] or **Volume** button and press [**ok**] to select.

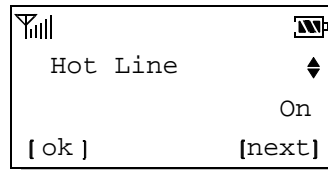

4. Press [**edit**] to input Hot Line phone number.

5. Enter the Hot Line phone number

6. Press [**ok**] to save and exit.

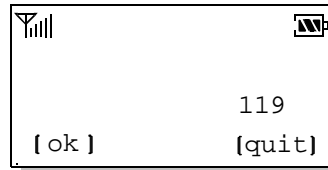

4.5.2 Hot Line Time

1. Press [**menu**] + 5 (Convenient)
2. Press 2(Hot Line Time).
3. Select hot line connection time(2~9 sec.) by [**next**] or **Volume** button.
4. Press [**ok**] to select.

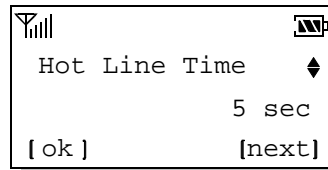

4.5.3 Speed Dial (enable / disable)

1. Press [**menu**] + 5 (Convenient)
2. Press 3(Speed Dial)
3. Select **Yes** or **No** by [**next**] or **Volume** button and press [**ok**] to save and exit.

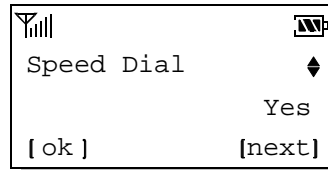

This function can be used when the Speed Dial is set to Yes.

- Speed Dial Function

1. You can store phone numbers in memory locations (1~99) and place a call.
2. Press the memory number (1 through 99) corresponding to the appropriate memory location, and hold for a few seconds.

4.6 Additional feature

4.6.1 Key-tone Length

Setting key beep playback length. Possible settings are **Short** and **Long**.

1. Press [**menu**] + 6(Additional).
2. Press 1(KeyTone Length).

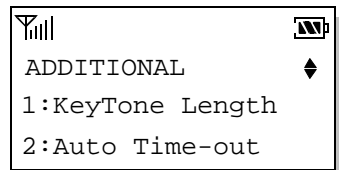

Select **Short** or **Long** by **[next]** or **Volume** button and press **[ok]** to select.

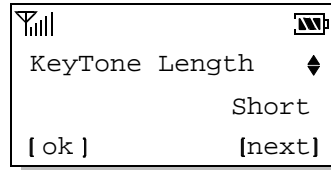

4.6.2 Auto Time-out

Setting the length of time the phone waits before automatically dialing a number. You can select this time between 2 and 9 second.

1. Press **[menu]** + **6**(Additional).
2. Press **2**(Auto Time-out).
3. Select Auto time-out second between 2 and 9 by **[next]** or **Volume** button.
4. Press **[ok]** to select.

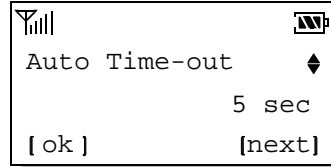

4.6.3 3 Minute Alert

Alerts you every 10 seconds before the end of every 3 minutes during a call.

1. Press **[menu]** + **6**(Additional)
2. Press **3**(3 Min. Alert)
3. Select **On** or **Off** by **[next]** or **Volume** button.
4. Press **[ok]** to save and exit

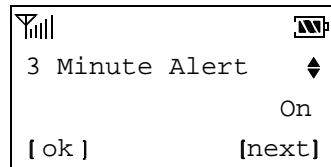

5. Functions while in a call

5.1 Ear Volume

You may adjust ear volume while you are in a call.

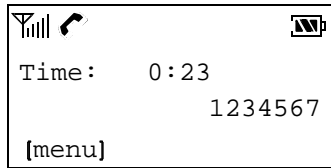

The **Volume** button on the right side of the phone can be used to adjust ear volume.



5.2 MIC Volume

Adjusting MIC volume while in a call.

1. Press **[menu]** and **2**(MIC Level) while in a call.

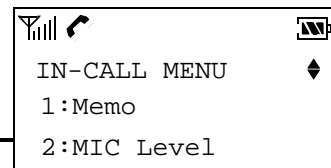

2. Select **Low** or **High** by **[next]** or **Volume** button.

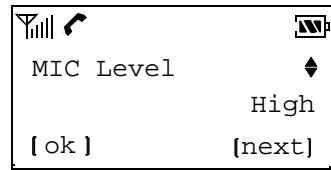

3. Press **[ok]** to save and exit.

5.3 Mute

This function prevents your voice from being transmitted but you can still hear other side.

1. Press **End** button while in a call.
2. You could see "Mute" message blinking on the right side of the LCD.
3. To release Mute, Press **End** button again.

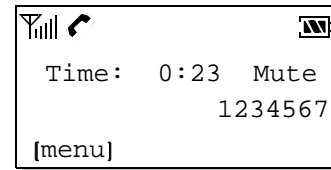

5.4 Memo

You can save numbers while in a call.

1. Press **[menu]** and **1**(Memo) while in a call.

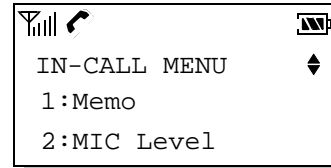

2. Enter a number by key pad.

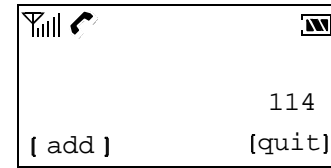

3. Press **[add]** to save and exit. Or press **[quit]** to exit.

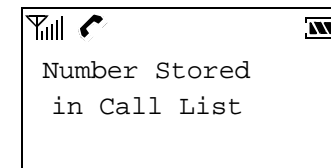

5.5 Transmitting your own number

This function is a convenient feature which enables you to transmit your own phone number while in a call through one key press. (For example, Sending your phone number when you pages.)

- ✓ Press **[menu]** and **3**(Send Owner #)

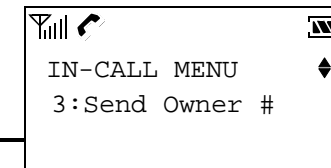

6. Searching, Editing & Dialing

6.1 Retrieving Last Call History

1. Press **[recall]** and **1**(Last Calls)

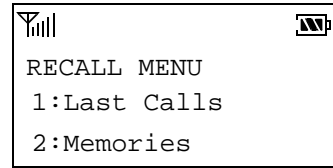

2. Select a number or a name in the last call list by **[next]** and press **[view]**.

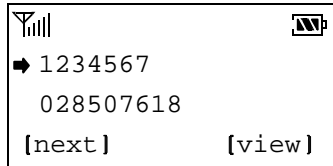

3. To see more information press **[time]** or press **[save]** to save a number in the memory.

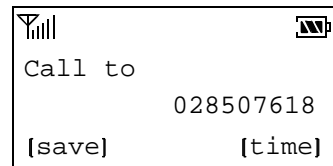

✓ Pick up the handset or Press **[call]** button to make a call with the displayed number.

● By pressing **[time]**

✓ Press **[ok]** to exit

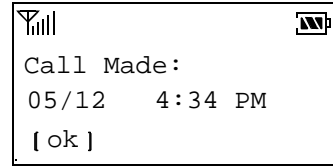

● To save a number

✓ Press **[save]** in step3

✓ Enter the name in text mode and press **[ok]** to save. Press **[A/a]** to change upper or lower case character.

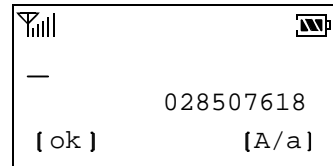

- To store without name, just press **[ok]**.
- Refer to "To enter a character".

✓ Enter a desired memory location (01~99: 2 digits) or press **[next]** to choose a desired memory location and press **[ok]**.

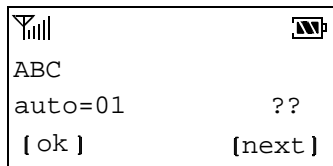

- The phone number is stored in the displayed memory location.

✓ The phone will display a message asking to keep your number as secret or not. Select "No" or "Yes" using **[next]**. Then press **[ok]**.

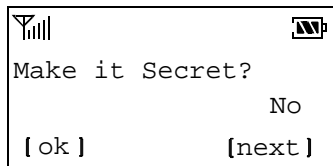

- You can see a confirming message.

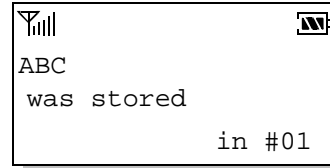

- You can see used memory situation.

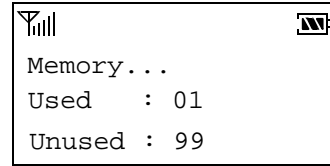

6.2 Retrieving Phone Number by Address

1. Press **[recall]** and **2**(Memories)

2. Enter a memory address to retrieve phone number.
(ex: If you enter a memory address, 01.)

- ✓ If there is no stored phone number in the memory location, "Empty address" is displayed.

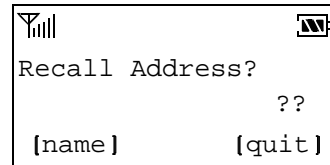

3. Pick up the handset or press **[call]** button to call to displayed number, press **[edit]** to edit stored information or press **[erase]** to delete displayed information.

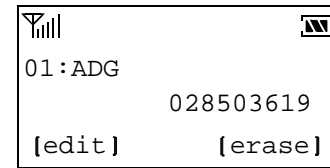

- Edit process

- ✓ Modify the phone number by **Clear** button and keypad. And Press **[ok]** to edit a related name.

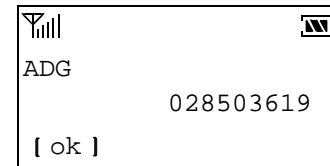

- 1) Delete the phone number by **Clear** button.
- 2) Enter the modified phone number.
- 3) Press **[ok]**.
- 4) To move cursor, use **Volume** button or *, #.
- 5) Enter the name.
- 6) Press **[ok]**.

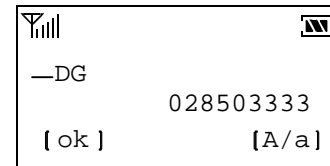

- ✓ Enter a new memory address to store a new information or choose the new memory address by **[next]** and press **[ok]**.

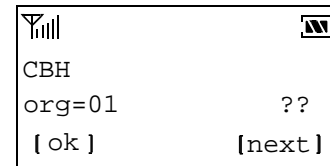

- ✓ Press **[ok]** to make it non secret

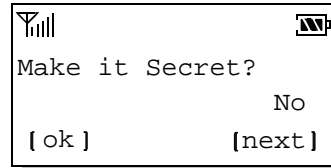

- Erasing process
- ✓ You might press **[erase]** at the above step 3.

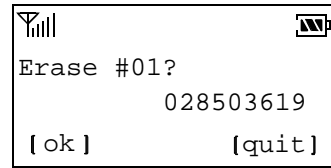

- ✓ Press **[ok]** to complete erasing process.

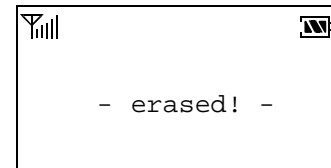

6.3 Retrieving Phone Number by Name

1. Press **[recall]** and 2(Memories)
2. Press **[name]** to retrieve phone number by name.

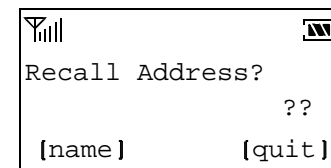

3. Enter the name that you want to look for and press **[find]**.

- ✓ At least two letters are recommended for quick search.

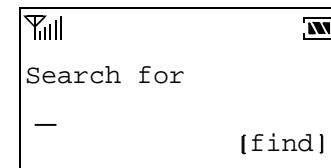

- ✓ Press **[next]** or **Volume** button to scroll through the list of matches.

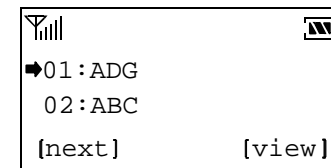

4. Press **[view]** to see information in that location.

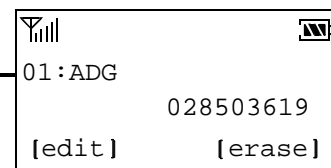

- ✓ Pick up handset to make a call.

7. SMS (Short Message Service)

Messaging, Paging, and Voice mail features are available when your phone is turned on. Using **Message** button allows you to access messages for viewing on the LCD screen. While viewing a message, you can return the call with the number provided in the message by picking up handset.

Check with your WLL service provider regarding the availability of this feature. The information in a message depends on the mode the WLL is operating in and the service's capabilities.

7.1 Checking & Deleting Received Message

7.1.1 Text Message

1. Press **Message** button and **1**(Received MSG)

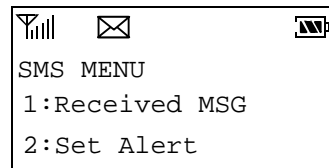

2. Press **1**(Message) to see a received text message list.

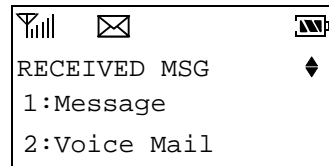

- ✓ Locate **➡** to the desired message in the list.
- ✓ Mark **!** means a new message.
- ✓ Mark **∨** means a already checked message.

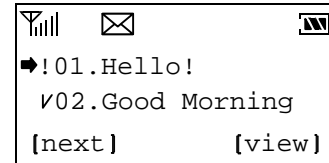

3. Press **[view]** to see the content of desired message.

- ✓ You can see the message with received time and caller's phone number.

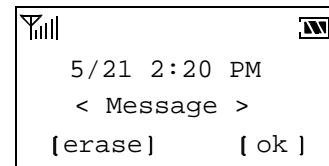

- ✓ Use the **Volume** button to read all message.

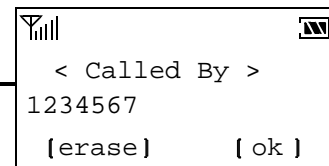
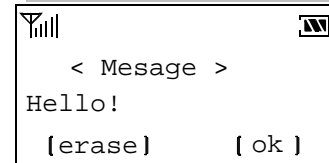

4. Press **[erase]** to erase a message.

- ✓ Press **[yes]** to complete erasing process.

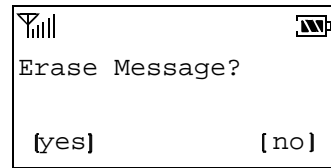

7.1.2 Voice Message

Voice mail notifications indicate the number of new voice mail message in your mail box. Only the most recent voice mail notification will be stored in the WLL phone; previous messages will be overwritten. When a voice mail messages left for you, the WLL phone will alert and display “ -Voice Mail -“. You must call your voice mail service to retrieve these messages.

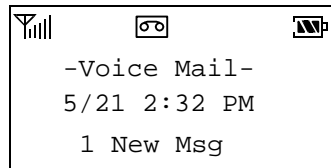

1. Press **Message** button and **1**(Received MSG) in idle state.

2. Press **2**(Voice Mail) to check the voice message.

- ✓ If there is no voice message, “No New Voice Mail” is displayed.

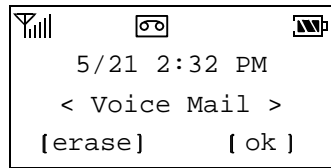

- ✓ Press **[erase]** to delete the voice message.

3. Pick up the phone to make a call to call back your voice mail box if the number of the voice mail box is provided by system.

7.2 Erasing all Message

1. Press **Message** button and **1**(Received MSG).

2. Press **3**(clear All).

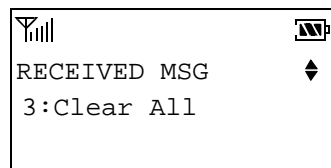

3. Press **[yes]** to delete.

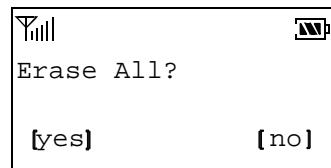

7.3 Setting alert tone count.

1. Press **Message** button and **2**(Set Alert).

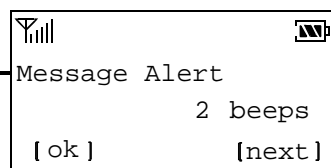

2. Select **no**, **2 beeps** or **4 beeps** by pressing **[next]**.
3. Press **[ok]** to save and exit.

8. Beside Functions

8.1 Redial

Pick up the handset or press  button and **Redial** button to redial last outgoing number.

8.2 Viewing your own number

Press **Redial** button in on-hook state to see your own telephone number

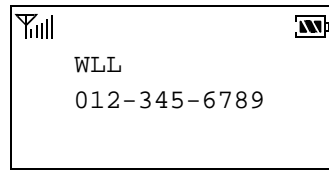

9. Storing Phone Number

9.1 Storing/Editing Phone Numbers

9.1.1 Storing Phone Numbers

Frequently used phone numbers can be stored on the memory locations (01~99: 2 digits) and you can make a call by pressing memory location number in off-hook state.

1. Enter the area code and phone number in on-hook state. (Max. 32 digits)
2. Press **[save]**.

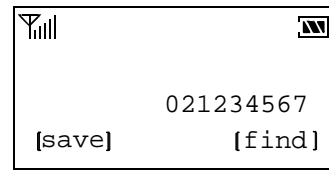

3. Enter the name in text mode and press **[ok]** to save.
Press **[A/a]** to change upper or lower case characters.

- ✓ To store without name, just press **[ok]**.
- ✓ Refer to "To enter a character".

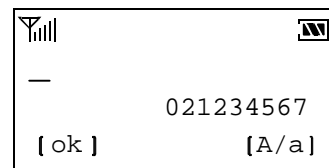

4. Enter the desired memory location.

- ✓ The phone number is stored in the displayed

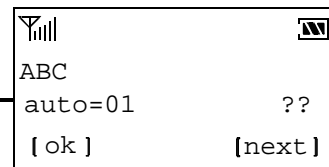

memory location.

5. The phone will display a message asking to keep your number as secret or not. Select "No" or "Yes" using **[next]**. Then Press **[ok]**.

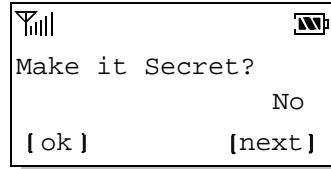

- ✓ You can see a confirming message.

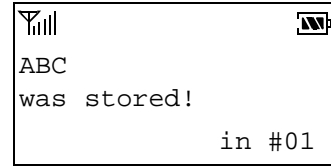

- ✓ You can see used memory situation.

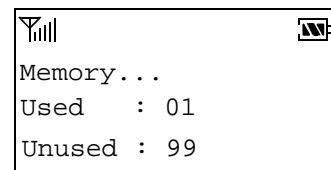

● **To enter a character.**

You can enter English character in editing mode.

You can enter English character as default, and press **Message** to select specific character.

● **To enter English character.**

Press once a keypad to enter the first letter labeled in the keypad, twice to enter the second letter and 3 times to enter the third letter.

EX) To enter "L",

Press dial button **5** labeled "JKL" 3 times to enter "L".

- ✓ After 2 seconds entering a character, the cursor is moved to the next position automatically.
- ✓ Press **Volume** button to move the cursor.
- ✓ Press **Clear** button to erase or correct entered character.

● **To enter specific character,**

Press **Message** to view a desired character while you are entering names.

- ✓ Special characters includes *, #, %, ", :, +, <, >, =, and more
- ✓ Press the number next to the character you want insert.

9.1.2 Erasing Stored Phone Numbers

When a phone number is stored in a memory location, you can erase the stored phone number.

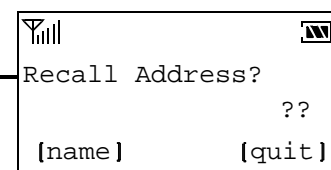

1. Press **[recall]** and **2**(memories) and enter a number of the desired memory location to erase.

- ✓ If there is no stored phone number in the memory location, "Empty Address" is displayed.

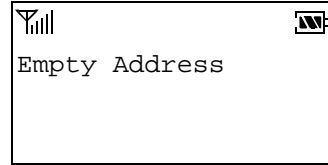

- ✓ If you do not remember the memory location to erase, press **Volume** button or press **[name]** to search phone number by name.

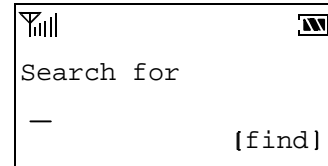

2. Erasing process

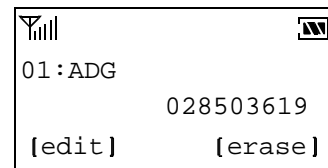

- ✓ Press **[erase]** to delete.

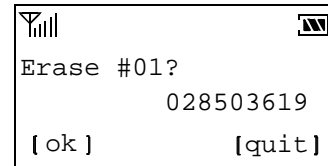

- ✓ Press **[ok]** to complete erasing process.

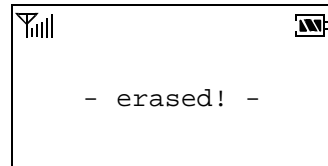

9.2 Finding Stored Phone Numbers

You can see the whole list of stored phone numbers in memory list and if you forgot the memory location, can find it in sequence. And You can place a call with the phone number.

1. Press **[recall]** and **2**(memories) in on-hook state.

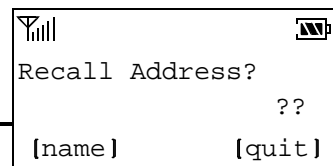

2. Press **Volume** button to find the desired phone number.

- ✓ Locate **➡** in the desired name or address to find.
- ✓ If not any entered name, phone number is displayed.

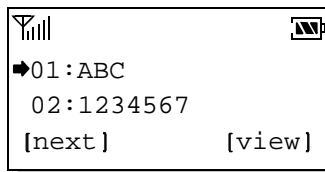

3. Press **[view]** to see the stored number.

4. To make a call with the phone number in the state of step 2 or step 3, pick up the handset or press **[call]** button and wait for Auto Time-out.

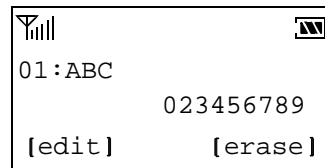

10. General Information

Main Unit

Item	Description
Tx Frequency	Digital : 1851.25 ~ 1908.75 MHz
Rx Frequency	Digital : 1931.25 ~ 1988.75 MHz
Channel Bandwidth	1.25 MHz
Tx Power	Digital : Max. 0.2W
Rx Sensitivity	-104 ~ -25dBm
Size	183 X 229 X 88 (L X W X H)
Weight(g)	Below 1200(with battery, Ni-cd)
	Below 1120(with battery, Ni-MH)
	Below 920 (without battery)
Operating Temperature	0 ~ 50

AC/DC Adapter

Item	SMPS Type Description
Input Voltage	AC 100 ~ 250V / 0.3A, 15W
Input Frequency	50 / 60Hz
Output Voltage	9.6V(DC), 1A

Battery

Item	Description
Capacity	6V Ni-cd 1700mAh / 6V Ni-MH 1700mAh
Talk duration time	3 Hours
Standby duration time	40 Hours
Charging duration time	Trickle, 30 Hours

Licensed by QUALCOMM Incorporated under one or more of the following Patents:

U.S, Patent No. 4,901,307 U.S, Patent No. 5,056,109 U.S, Patent No. 5,099,204

U.S, Patent No. 5,101,501 U.S, Patent No. 5,103,459 U.S, Patent No. 5,107,225

