



FCC ID: SSNMNC4U1186

ATTACHMENT E.

- User Manual -

HCT CO., LTD.

SAN 136-1, AMI-RI, BUBAL-EUP, ICHEON-SI, KYOUNGKI-DO, 467-701, KOREA
TEL:+82 31 639 8517 FAX:+82 31 639 8525 www.hct.co.kr

Report No. : HCT-RF09-0616

1/1

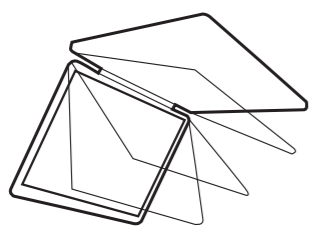

User's Guide

1000DPI
Wireless
Mobile Optical Mouse



1

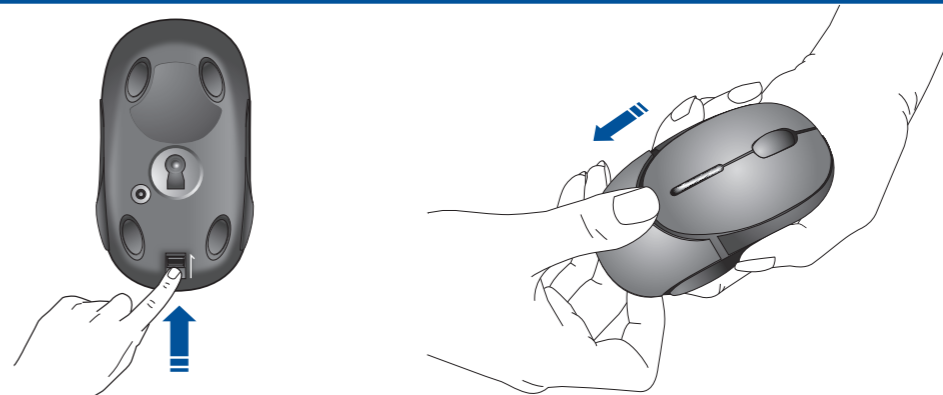

English At the bottom of the mouse, follow the direction of the arrow to push gently, at the same time, to pull out the battery cover in opposite direction, to pull out the battery cover.

简体中文 依鼠标底部箭头指示方向推动按钮；同时反方向拉动鼠标电池盖，以打开电池盖。

繁體中文 依滑鼠底部箭頭指示方向推動按鈕；同時反方向拉動滑鼠電池蓋，以打開電池蓋。

2

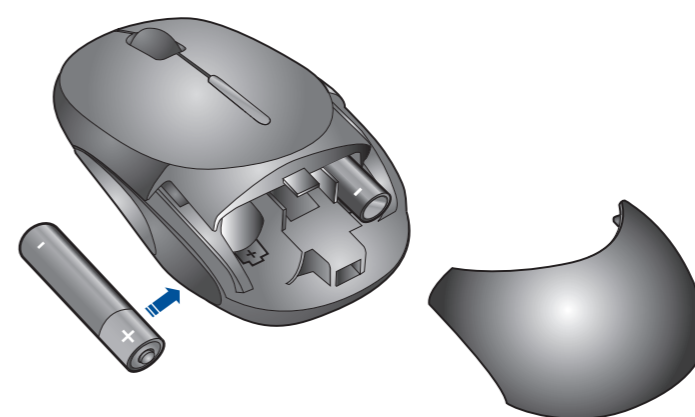

English Follow the arrow where how to put the batteries in the right direction.

简体中文 请依图示将电池依正负极方向置入电池槽。

繁體中文 請依圖示將電池依正負極方向置入電池槽。

7

English **Battery Warning** Remove batteries when not using your cordless device for long period of time. If the cursor on your screen does not move or moves erratically when you move your mouse. Please change batteries, and exercise care when handling batteries.

简体中文 **使用电池时请注意!** 长期不使用无线装置时，请取出电池。当屏幕上的指针无法移动或移动不正常时，请立即更换电池，更换电池时请小心处理。

繁體中文 **使用電池時請注意!** 長期未使用無線裝置時，請取出電池。當螢幕上的游標無法移動或游標移動不正常時，請立即更換電池，更換電池時請小心處理。

3

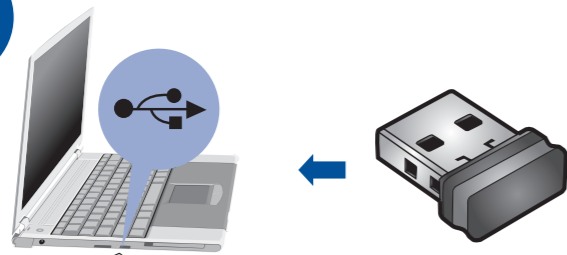

ON

English Insert nano wireless receiver into the computer's USB port, turn on the computer power supply, mouse will working normally.

简体中文 将微型接收器插入电脑的USB连接口，开启电脑电源，鼠标即可正常使用。

繁體中文 將袖珍無線接收器插入電腦的USB連接埠，開啟電腦電源，滑鼠即可正常使用。

5

English When not using the mouse, press the power button on the bottom of mouse for 3~5 seconds to shut down the mouse power for battery power saving. Then press the power button again to re-start the mouse power.

简体中文 不使用鼠标时，按住鼠标底部电源按钮3~5秒，即可关闭鼠标电源以节省电力；再按一下电源按钮即可重开启电源。

繁體中文 不使用滑鼠時，按住滑鼠底部電源按鈕3~5秒，即可關閉滑鼠電源以節省電力；再按一下電源按鈕即可重開啟電源。

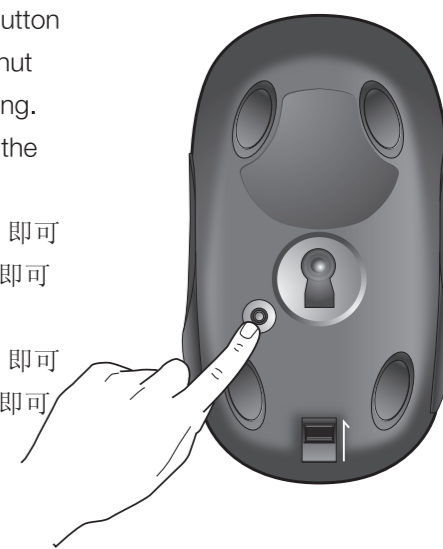

4

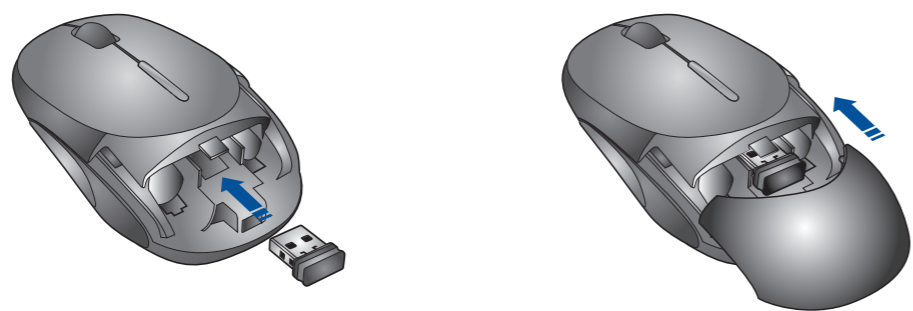

English **To readily carry the mouse:** (a) Open the battery case. (b) Insert nano wireless receiver inside the compartment by the direction of the arrow. (c) Close the battery case back.

简体中文 携带鼠标的准备: a) 打开鼠标电池盖, b) 将接收器按方向插入固定槽内, c) 盖上电池盖。

繁體中文 攜帶滑鼠的準備: a) 打開滑鼠電池蓋, b) 將接收器按方向插入固定槽內, c) 蓋上電池蓋。

6

English **If the mouse LED is blinking blue,** please replace the batteries. **If the mouse is not working:** 1. Make sure the mouse power is on (turn-on / working). 2. Check the battery capacity and installation. 3. Check receiver installation. 4. Try another USB port.

简体中文 如鼠标LED指示灯呈闪烁蓝色，请更换电池。如鼠标无法工作: 1. 确保鼠标处于使用状态(打开)。2. 检查电池电量和电池的安装。3. 检查接收器的安装。4. 尝试使用其他的USB连接端口。

繁體中文 若滑鼠LED指示燈呈閃爍藍燈，請更換電池。如滑鼠沒有動作: 1. 確定滑鼠電源已開啟。2. 檢查電池是否裝妥及測試電池電量。3. 檢查接收器是否安裝妥當。4. 嘗試插在其他USB連接埠。

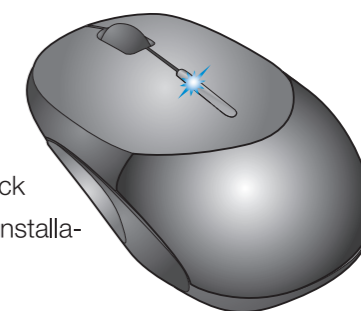

This equipment has been tested and found to comply with the limits for a Class A digital device, pursuant to part 15 of the FCC Rules. These limits are designed to provide reasonable protection against harmful interference in a residential installation. This equipment generates, uses and can radiate radio frequency energy and, if not installed and used in accordance with the instructions, may cause harmful interference to radio communications. However, there is no guarantee that interference will not occur in a particular installation. If this equipment does cause harmful interference to radio or television reception, which can be determined by turning the equipment off and on, the user is encouraged to try to correct the interference by one or more of the following measures:

- Reorient or relocate the receiving antenna.
- Increase the separation between the equipment and receiver.
- Connect the equipment into an outlet on a circuit different from that to which the receiver is connected.
- Consult the dealer or an experienced radio/TV technician for help.

Caution: Any changes or modifications to this device not explicitly approved by manufacturer could void your authority to operate this equipment.

This device complies with part 15 of the FCC Rules. Operation is subject to the following two conditions: (1) This device may not cause harmful interference, and (2) this device must accept any interference received, including interference that may cause undesired operation.

This equipment complies with FCC radiation exposure limits set forth for an uncontrolled environment. This equipment should be installed and operated with minimum 20 cm between the radiator and your body. This transmitter must not be collocated or operating in conjunction with any other antenna or transmitter unless authorized to do so by the FCC.