

Installation and Operating Guide | Warranty

Model Numbers | 19LS4D, 22LS4D | LCD TV



WARNING / CAUTION



WARNING / CAUTION
RISK OF ELECTRIC SHOCK
DO NOT OPEN



**TO REDUCE THE RISK OF ELECTRIC SHOCK
DO NOT REMOVE COVER (OR BACK). NO
USER SERVICEABLE PARTS INSIDE. REFER TO
QUALIFIED SERVICE PERSONNEL.**



The lightning flash with arrowhead symbol, within an equilateral triangle, is intended to alert the user to the presence of uninsulated “dangerous voltage” within the product’s enclosure that may be of sufficient magnitude to constitute a risk of electric shock to persons.



The exclamation point within an equilateral triangle is intended to alert the user to the presence of important operating and maintenance (servicing) instructions in the literature accompanying the appliance.

WARNING/CAUTION

TO REDUCE THE RISK OF FIRE AND ELECTRIC SHOCK, DO NOT EXPOSE THIS PRODUCT TO RAIN OR MOISTURE.

NOTE TO CABLE/TV INSTALLER

This reminder is provided to call the CATV system installer’s attention to Article 820-40 of the National Electric Code (U.S.A.). The code provides guidelines for proper grounding and, in particular, specifies that the cable ground shall be connected to the grounding system of the building, as close to the point of the cable entry as practical.

WARNING / CAUTION

To prevent fire or shock hazards, do not expose this product to rain or moisture.

FCC NOTICE

Class B digital device

This equipment has been tested and found to comply with the limits for a Class B digital device, pursuant to Part 15 of the FCC Rules. These limits are designed to provide reasonable protection against harmful interference in a residential installation. This equipment generates, uses and can radiate radio frequency energy and, if not installed and used in accordance with the instructions, may cause harmful interference to radio communications. However, there is no guarantee that interference will not occur in a particular installation. If this equipment does cause harmful interference to radio or television reception, which can be determined by turning the equipment off and on, the user is encouraged to try to correct the interference by one or more of the following measures:

- Reorient or relocate the receiving antenna.
- Increase the separation between the equipment and receiver.
- Connect the equipment to an outlet on a circuit different from that to which the receiver is connected.
- Consult the dealer or an experienced radio/TV technician for help.

Any changes or modifications not expressly approved by the party responsible for compliance could void the user’s authority to operate the equipment.

CAUTION

Do not attempt to modify this product in any way without written authorization from LG Electronics. Unauthorized modification could void the user’s authority to operate this product

SAFETY INSTRUCTIONS

IMPORTANT SAFETY INSTRUCTIONS

Important safety instructions shall be provided with each apparatus. This information shall be given in a separate booklet or sheet, or be located before any operating instructions in an instruction for installation for use and supplied with the apparatus.

This information shall be given in a language acceptable to the country where the apparatus is intended to be used. The important safety instructions shall be entitled "Important Safety Instructions". The following safety instructions shall be included where applicable, and, when used, shall be verbatim as follows. Additional safety information may be included by adding statements after the end of the following safety instruction list. At the manufacturer's option, a picture or drawing that illustrates the intent of a specific safety instruction may be placed immediately adjacent to that safety instruction:

Read these instructions.

Keep these instructions.

Heed all warnings.

Follow all instructions.



- 1 Do not use this apparatus near water.



- 2 Clean only with dry cloth.



- 3 Do not block any ventilation openings. Install in accordance with the manufacturer's instructions.



- 4 Do not install near any heat sources such as radiators, heat registers, stoves, or other apparatus (including amplifiers) that produce heat.



- 5 Do not defeat the safety purpose of the polarized or grounding-type plug. A polarized plug has two blades with one wider than the other. A grounding type plug has two blades and a third grounding prong. The wide blade or the third prong are provided for your safety. If the provided plug does not fit into your outlet, consult an electrician for replacement of the obsolete outlet.



- 6 Protect the power cord from being walked on or pinched particularly at plugs, convenience receptacles, and the point where they exit from the apparatus.



- 7 Only use attachments/accessories specified by the manufacturer.



- 8 Unplug this apparatus when unused for long periods of time.

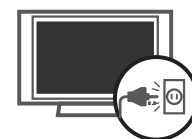

- 9 Use only with the cart, stand, tripod, bracket, or table specified by the manufacturer, or sold with the apparatus. When a cart is used, use caution when moving the cart/apparatus combination to avoid injury from tip-over.



- 10 Never touch this apparatus or antenna during a thunder or lightning storm.

- 11 Do not allow a impact shock or any objects to fall into the product, and do not drop onto the screen with something.

- 12 Refer all servicing to qualified service personnel. Servicing is required when the apparatus has been damaged in any way, such as power-supply cord or plug is damaged, liquid has been spilled or objects have fallen into the apparatus, the apparatus has exposed to rain or moisture, does not operate normally, or has been dropped.



- 13 CAUTION concerning the Power Cord : Most appliances recommend they be placed upon a dedicated circuit; that is, a single outlet circuit which powers only that appliance and has no additional outlets or branch circuits. Check the specification page of this owner's manual to be certain.

Do not overload wall outlets. Overloaded wall outlets, loose or damaged wall outlets, extension cords, frayed power cords, or damaged or cracked wire insulation are dangerous. Any of these conditions could result in electric shock or fire. Periodically examine the cord of your appliance, and if its appearance indicates damage or deterioration, unplug it, discontinue use

of the appliance, and have the cord replaced with an exact replacement part by an authorized servicer. Protect the power cord from physical or mechanical abuse, such as being twisted, kinked, pinched, closed in a door, or walked upon. Pay particular attention to plugs, wall outlets, and the point where the cord exits the appliance.



- 14 Outdoor use marking :
WARNING - To reduce the risk of fire or electric shock, do not expose this appliance to rain or moisture.



- 15 Wet Location Marking : Apparatus shall not be exposed to dripping or splashing and no objects filled with liquids, such as vases, shall be placed on or over apparatus.



- 16 **GROUNDING**
Ensure that you connect the earth ground wire to prevent possible electric shock. If grounding methods are not possible, have a qualified electrician install a separate circuit breaker. Do not try to ground the unit by connecting it to telephone wires, lightening rods, or gas pipes.

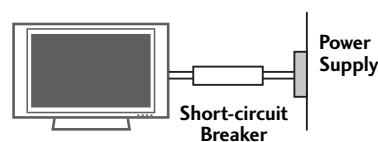

- 17 **DISCONNECTING DEVICE FROM MAINS**
Mains plug is the disconnecting device. The plug must remain readily operable.

CONTENTS

WARNING / CAUTION	1
SAFETY INSTRUCTIONS	2
INTRODUCTION	
Feature of this TV	6

PREPARATION

Accessories	7
Front Panel Information	8
Back Panel Information	9
Stand Installation	10
Detaching Stand	11
Back Cover for Wire Arrangement	12
Positioning your display	13
VESA Wall Mounting	14
Desktop Pedestal Installation	14
Kensington Security System	15
Attaching the TV to a Desk	15
Antenna or Cable Connection	16

EXTERNAL EQUIPMENT SETUP

HD Receiver Setup	17
DVD Setup	20
VCR Setup	22
Headphone Setup	24
PC Setup	25

WATCHING TV / CHANNEL CONTROL

Remote Control Key Functions	28
Turning On TV	29
Channel Selection	29
Volume Adjustment	29
On-Screen Menus Selection	30
Channel Search	
- Auto Scan (Auto Tuning)	32
- Add / Delete Channel (Manual Tuning)	33
- Channel Editing	34
Key Lock	35

PICTURE CONTROL

Picture Size (Aspect Ratio) Control	36
Preset Picture Settings	
- Picture Mode - Preset	38
- Color Tone - Preset	39
Manual Picture Adjustment	
- Picture Mode - User Mode	40
- Color Tone - User Mode	41
DB - Digital Booster	42
Advanced - Black (Darkness) Level	43
Picture Reset	44

SOUND & LANGUAGE CONTROL

Preset Sound Setting (Sound Mode)	45
Sound Setting Adjustment - User Mode	46
Balance	47
Stereo/SAP Broadcasts Setup	48
Audio Language	49
On-Screen Menus Language Selection	50
Caption Mode	51
- Analog Broadcasting System Captions	52
- Digital Broadcasting System Captions	53
- Caption Option	54

TIME SETTING

Clock Setting	
- Auto Clock Setup	55
- Manual Clock Setup	56
Auto On/Off Timer Setting	57
Sleep Timer Setting	58
Auto Shut-off Setting.....	59

PARENTAL CONTROL / RATINGS

Set Password & Lock System	
- Setting up Your Password	60
- Set Password	61
- Lock System	61
Movie & TV Rating	
- Movie Rating (MPAA)	62
- TV Rating Children & General	63

APPENDIX

Troubleshooting	64
Maintenance	66
Product Specifications	67

INTRODUCTION

FEATURE OF THIS TV



High-definition television. High-resolution digital television broadcast and playback system composed of roughly a million or more pixels, 16:9 aspect-ratio screens, and AC3 digital audio. A subset of digital television, HDTV formats include 1080i and 720p resolutions.



Manufactured under license from Dolby Laboratories. "Dolby" and the double-D symbol are trademarks of Dolby Laboratories.



HDMI™, the HDMI logo and High-Definition Multimedia Interface are trademarks or registered trademarks of HDMI Licensing."

If the TV feels cold to the touch, there may be a small "flicker" when it is turned on. This is normal, there is nothing wrong with TV.

Some minute dot defects may be visible on the screen, appearing as tiny red, green, or blue spots. However, they have no adverse effect on the monitor's performance.

Avoid touching the LCD screen or holding your finger(s) against it for long periods of time. Doing so may produce some temporary distortion effects on the screen.

On Disposal

- a. The fluorescent lamp used in this product contains a small amount of mercury.
- b. Do not dispose of this product with general household waste.
- c. Disposal of this product must be carried out in accordance to the regulations of your local authority.

PREPARATION

ACCESSORIES

Ensure that the following accessories are included with your product. If an accessory is missing, please contact the dealer where you purchased the product.

User must use shielded signal interface cables (D-sub 15 pin cable) with ferrite cores to maintain standard compliance for the product.

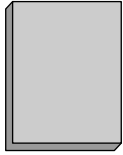

Owner's Manual



CD Manual

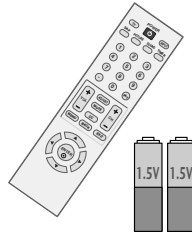

Remote Control,
Batteries

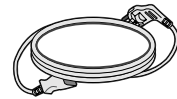

Power Cord



Cable Management

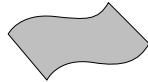

Polishing Cloth

* Slightly wipe stained spot on the exterior only with the polishing cloth for the product exterior if there is stain or fingerprint on surface of the exterior.

* Do not wipe roughly when removing stain. Please be cautious of that excessive pressure may cause scratch or discoloration.

Option Extras

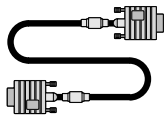

D-sub 15 pin Cable

PREPARATION

FRONT PANEL INFORMATION

- Here shown may be somewhat different from your TV.

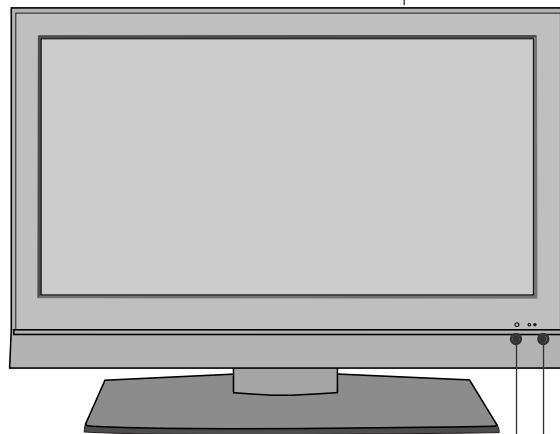
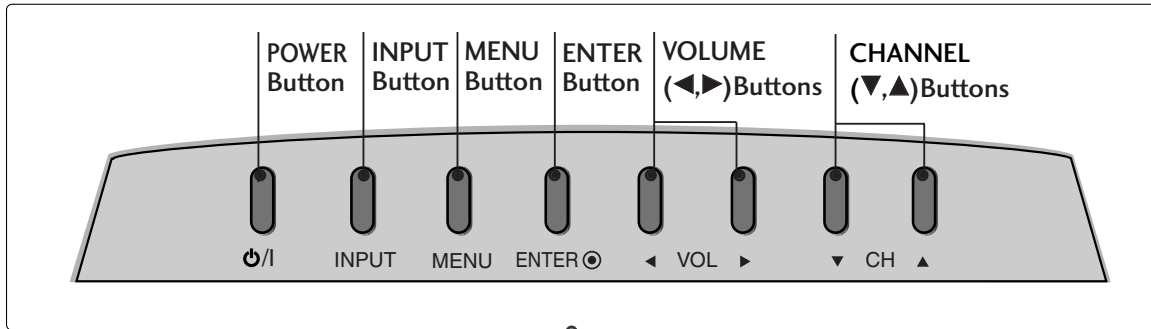

Remote Control Sensor

Power/Standby Indicator

Illuminates red in standby mode. When the TV is turned on, the indicator blinks green and then illuminates green before the picture is displayed.

! NOTE

- ▶ If your product has a protection tape attached, remove the tape. And then wipe the product with a cloth (If a polishing cloth is included with your product, use it).

BACK PANEL INFORMATION

▪ Here shown may be somewhat different from your TV.

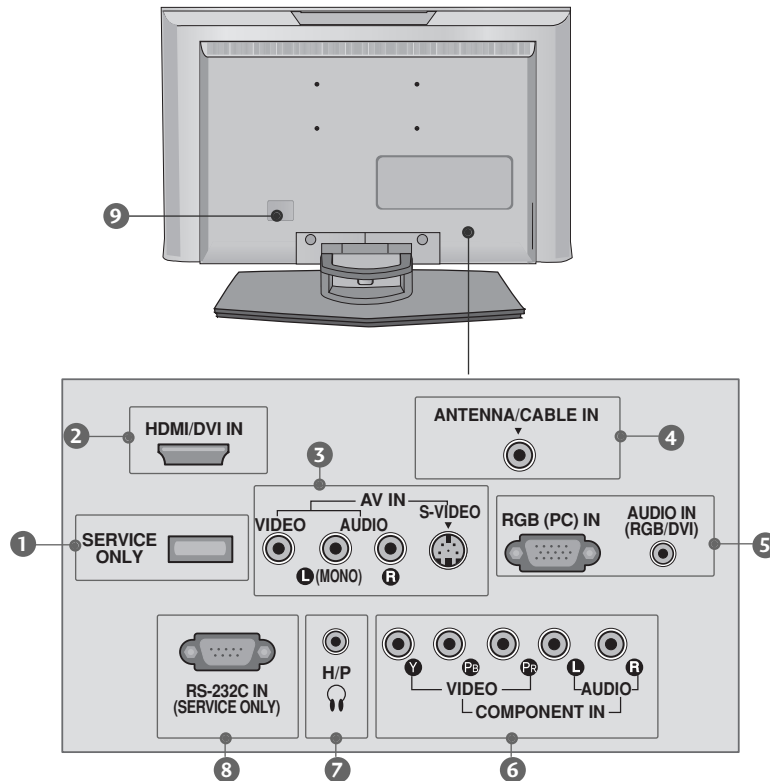

1 SERVICE ONLY

2 HDMI/DVI IN

Connect a HDMI signal to this jack.
Or DVI (Video) signal to this jack with a HDMI to DVI cable.

3 AV IN (Audio/Video)

Connect audio/video output from an external device to these jacks.

S-VIDEO

Connect S-Video out from an S-VIDEO device.

4 ANTENNA/CABLE IN

Connect over-the air signals to this jack.
Connect cable signals to this jack.

5 RGB (PC) IN

Connect the output from a PC.

AUDIO IN (RGB/DVI)

Connect the audio from a PC or DTV.

6 COMPONENT IN

Connect a component video/audio device to these jacks.

7 HEADPHONE INPUT

Plug the headphone into the headphone socket.

8 RS-232C IN (CONTROL & SERVICE) PORT

For external control devices.

9 Power Cord Socket

For operation with AC power.

Caution: Never attempt to operate the TV on DC power.

PREPARATION

STAND INSTALLATION

■ Here shown may be somewhat different from your TV.

- 1 Carefully place the product screen side down on a cushioned surface that will protect product and screen from damage.

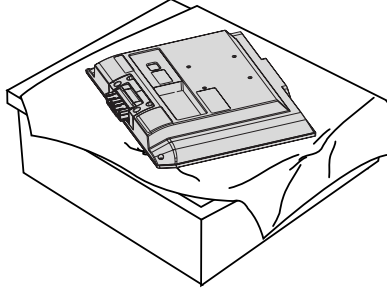

- 2 Hold the **HINGE BODY** and bend it upward.

HINGE BODY

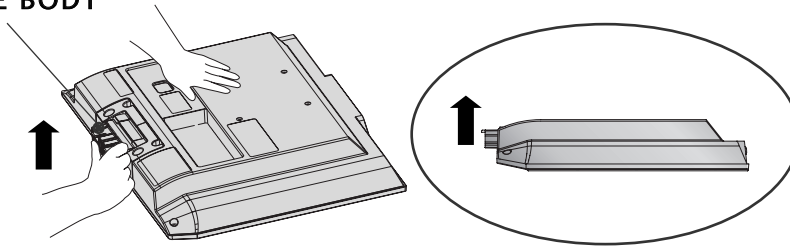

- 3 Insert the **STAND BODY** into the product until clicking sound.

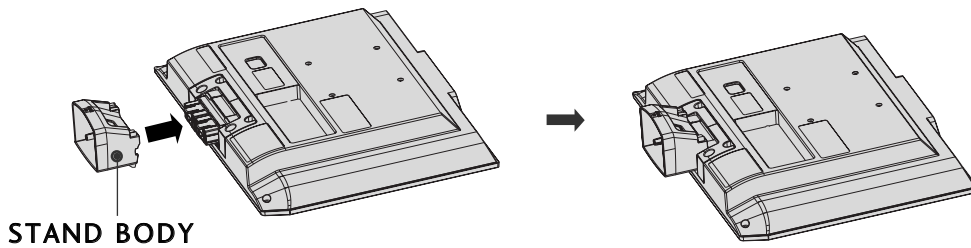

- 4 Assemble the parts of the **STAND BODY** with **COVER BASE** of the product.

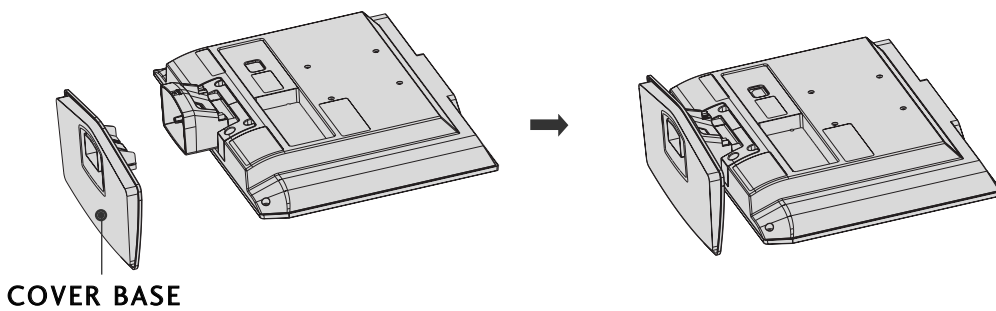

DETACHING STAND

■ Here shown may be somewhat different from your TV.

- 1 Carefully place the product screen side down on a cushioned surface that will protect product and screen from damage.

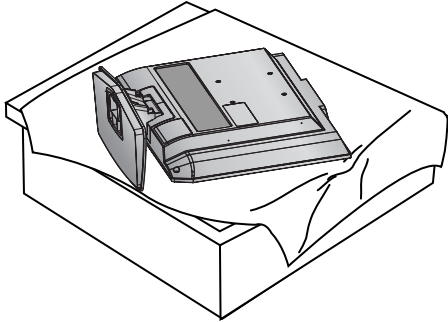

- 2 Pull cover base backward while pressing button on stand body.

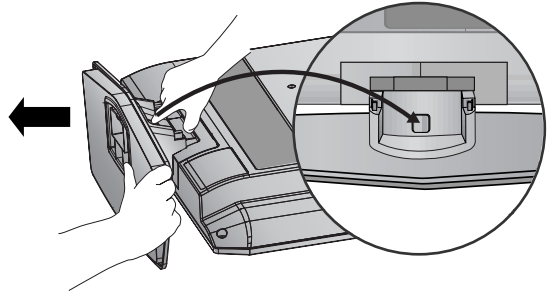

- 3 Shake the base while pulling, it will separate from stand body.

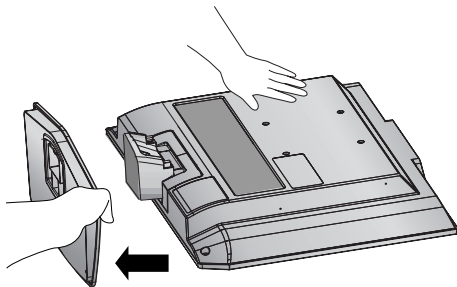

- 4 Hold the **HINGE BODY** and bend it upward.

HINGE BODY

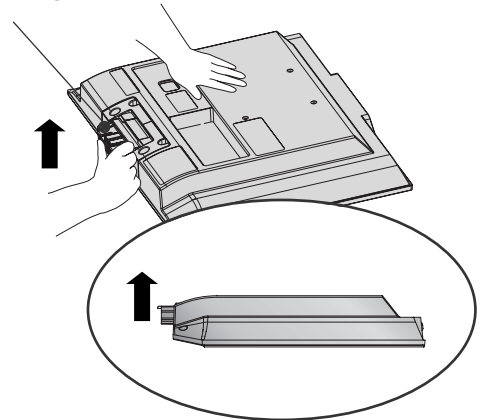

- 5 Pull stand body to separate from set while pressing the 2 latches.

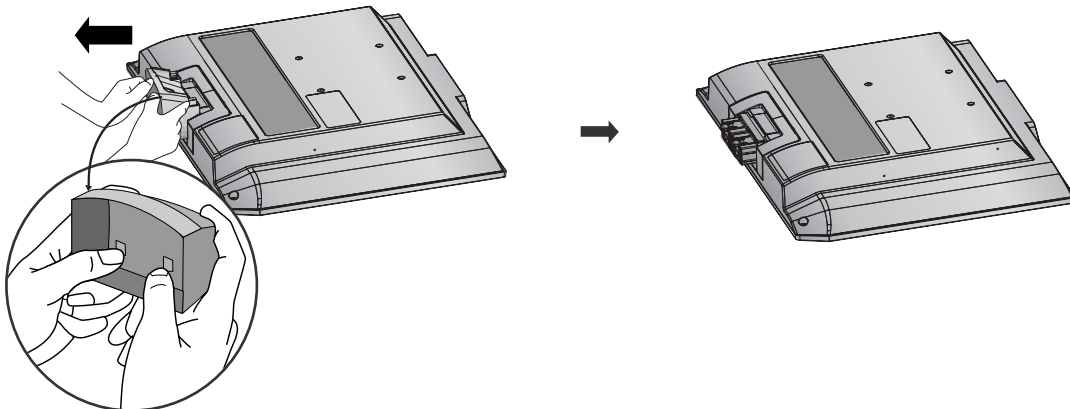

PREPARATION

BACK COVER FOR WIRE ARRANGEMENT

- Here shown may be somewhat different from your TV.

- 1 Connect the cables as necessary.
To connect an additional equipment, see the **EXTERNAL EQUIPMENT SETUP** section.

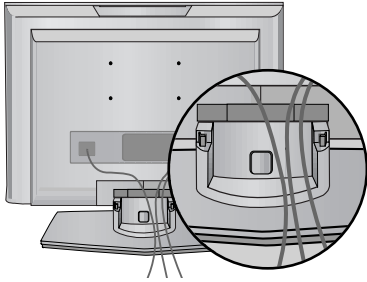

- 2 Install the **CABLE MANAGEMENT** as shown.

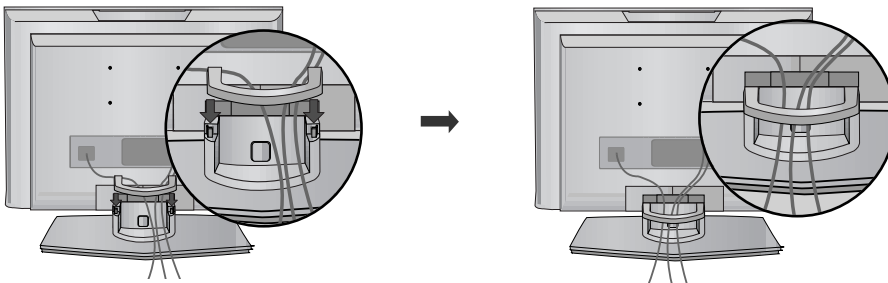

How to remove the **CABLE MANAGEMENT**

First, press the cable management. Hold the **CABLE MANAGEMENT** with both hands and pull it upward.

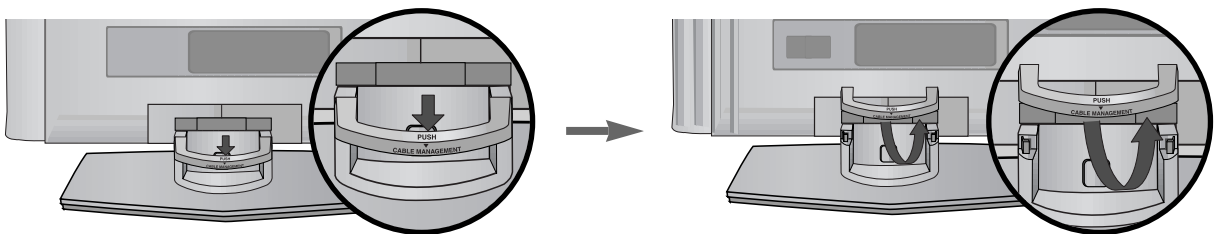

! NOTE

- ▶ Do not hold the **CABLE MANAGEMENT** when moving the product.
- If the product is dropped, you may be injured or the product may be broken.

POSITIONING YOUR DISPLAY

- Here shown may be somewhat different from your TV.
- Adjust the position of the panel in various ways for maximum comfort.
- Tilt range

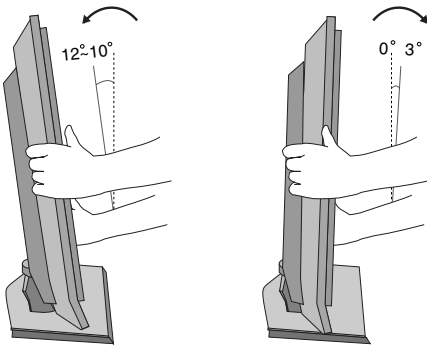

PREPARATION

VESA WALL MOUNTING

This product accepts a VESA-compliant mounting interface pad. (optional)
There 4 threaded holes are available for attaching the bracket.

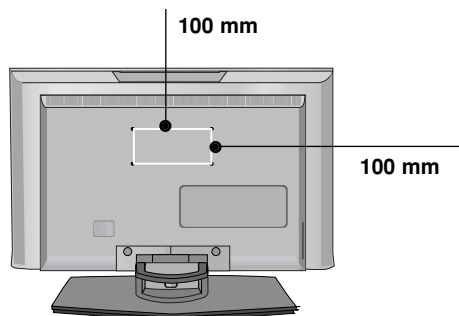

PREPARATION

! NOTE

- ▶ Screw length needed depends on the wall mount used. For further information, refer to the VESA Wall Mounting Instruction Guide.

DESKTOP PEDESTAL INSTALLATION

For proper ventilation, allow a clearance of 4 inches on all four sides from the wall.

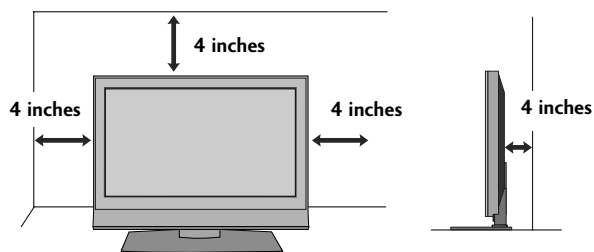

! CAUTION

- ▶ Ensure adequate ventilation by following the clearance recommendations.

KENSINGTON SECURITY SYSTEM

- The TV is equipped with a Kensington Security System connector on the back panel. Connect the Kensington Security System cable as shown below.
- For the detailed installation and use of the Kensington Security System, refer to the user's guide provided with the Kensington Security System.

For further information, contact <http://www.kensington.com>, the internet homepage of the Kensington company. Kensington sells security systems for expensive electronic equipment such as notebook PCs and LCD projectors.

NOTE

- The Kensington Security System is an optional accessory.

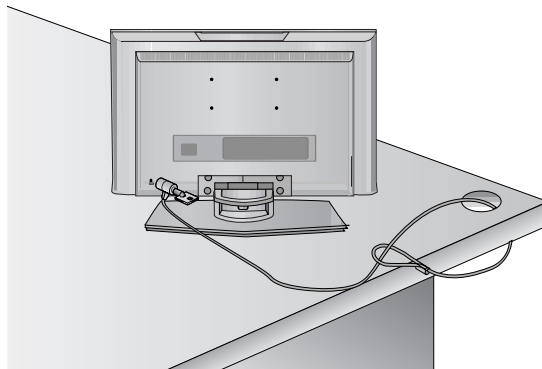

ATTACHING THE TV TO A DESK (Only 23 inches)

The TV must be attached to a desk so it cannot be pulled in a forward/backward direction, potentially causing injury or damaging the product.

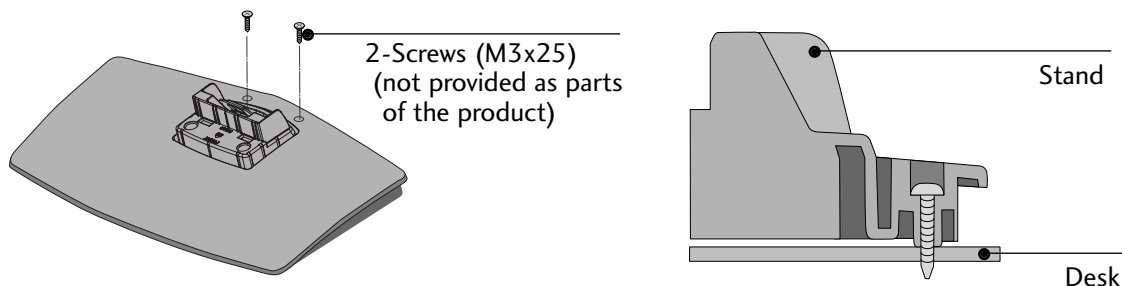

⚠ WARNING

- ▶ This apparatus must be securely attached to the floor/wall per installation instructions. Tipping, shaking, or rocking the machine may cause injury/death.

PREPARATION

ANTENNA OR CABLE CONNECTION

1. Antenna (Analog or Digital)

Wall Antenna Socket or Outdoor Antenna without a Cable Box Connections.

For optimum picture quality, adjust antenna direction if needed.

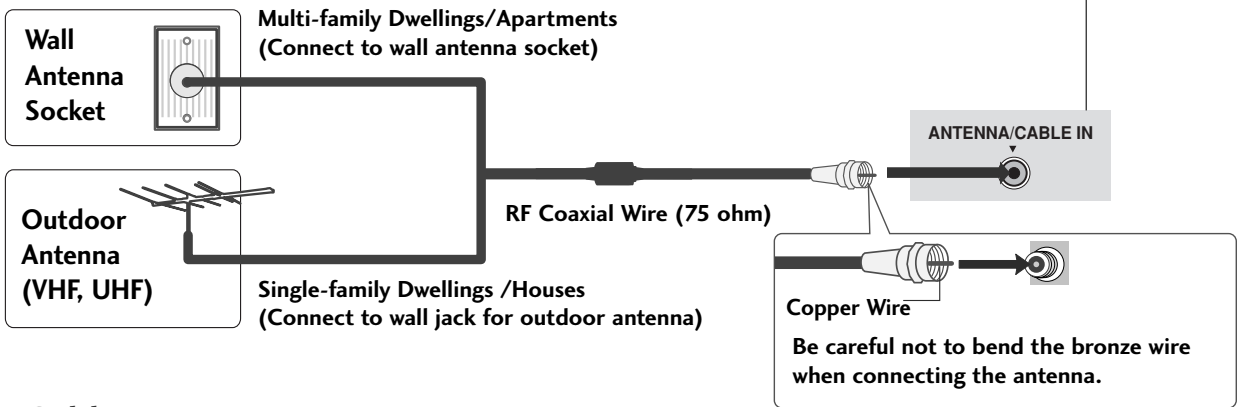

2. Cable



3. Using both cable and antenna

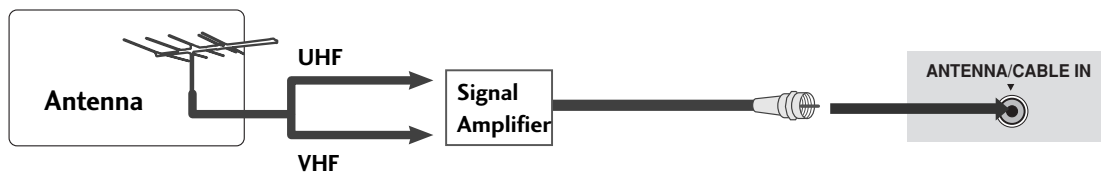
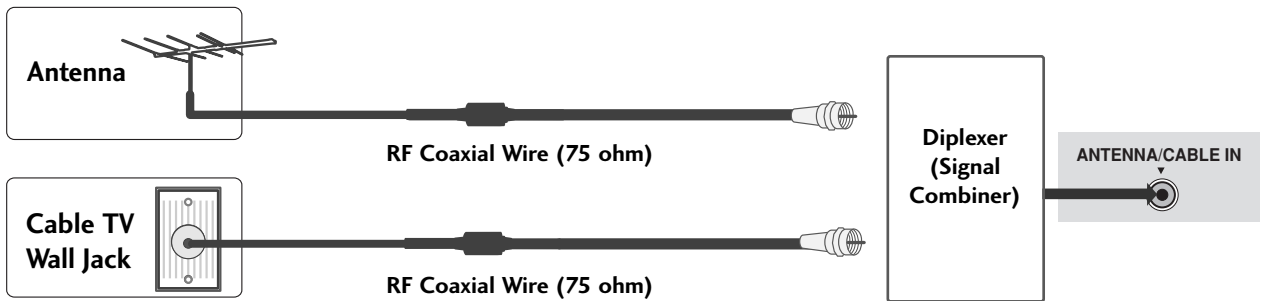

- To improve the picture quality in a poor signal area, please purchase a signal amplifier and install properly.
- If the antenna needs to be split for two TV's, install a 2-Way Signal Splitter.
- If the antenna is not installed properly, contact your dealer for assistance.

NOTE ▶ The TV will let you know when the analog, cable, and digital channel scans are complete.

EXTERNAL EQUIPMENT SETUP

- To prevent the equipment damage, never plug in any power cords until you have finished connecting all equipment.

HD RECEIVER SETUP

This TV can receive Digital Over-the-air/Cable signals without an external digital set-top box. However, if you do receive digital signals from a digital set-top box or other digital external device, refer to the figure as shown below.

When connecting Component cable

1. How to connect

- 1 Connect the video outputs (Y, Pb, Pr) of the digital set top box to the **COMPONENT IN VIDEO** jacks on the set. Match the jack colors (Y = green, Pb = blue, and Pr = red).
- 2 Connect the audio output of the digital set-top box to the **COMPONENT IN AUDIO** jacks on the set.

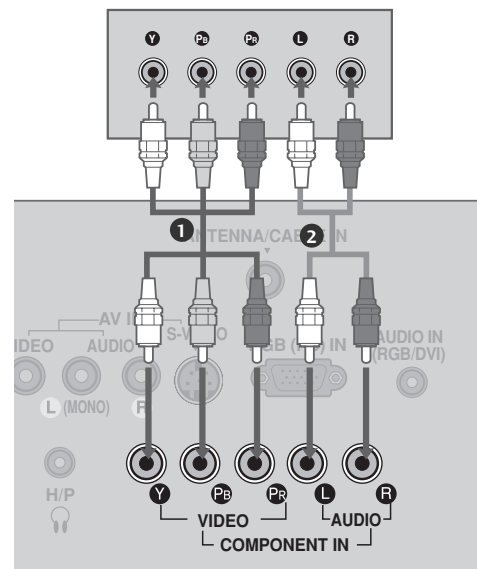

2. How to use

- Turn on the digital set-top box.
(Refer to the owner's manual for the digital set-top box. operation)
- Select **Component** input source by using the **INPUT** button on the remote control.

EXTERNAL EQUIPMENT SETUP

When connecting HDMI cable

1. How to connect

- 1 Connect the digital set-top box to **HDMI/DVI IN** jack on the set.
- 2 No separated audio connection is necessary. HDMI supports both audio and video.

2. How to use

- Turn on the digital set-top box. (Refer to the owner's manual for the digital set-top box.)
- Select **HDMI/DVI** input source by using the **INPUT** button on the remote control.

! NOTE

- ▶ When connected, the TV will tell a connected device what resolution it supports and the resolution it prefers. If the device supports this Auto HDMI function, the player output resolution will be automatically set to 720p.
- ▶ If the device does not support Auto HDMI, you need to set the output resolution appropriately.

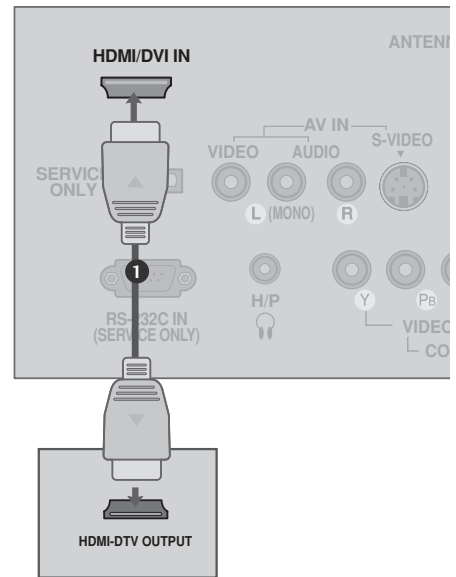

When connecting HDMI to DVI cable

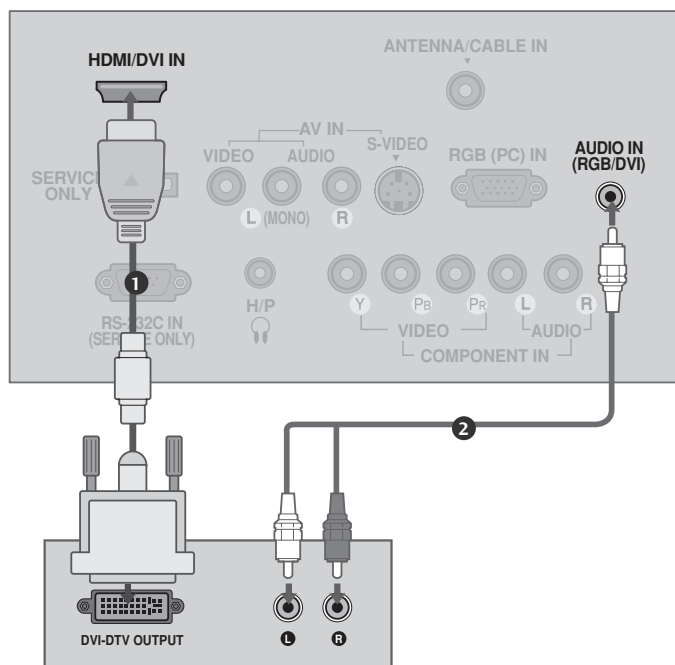

1. How to connect

- 1 Connect the DVI output of the digital set-top box to the **HDMI/DVI IN** jack on the set.
- 2 Connect the audio output of the digital set-top box to the **AUDIO IN (RGB/DVI)** jack on the set.

2. How to use

- Turn on the digital set-top box. (Refer to the owner's manual for the digital set-top box.)
- Select **HDMI/DVI** input source by using the **INPUT** button on the remote control.

EXTERNAL EQUIPMENT SETUP

DVD SETUP

When connecting Component cable

1. How to connect

- 1
 Connect the video outputs (Y, PB, PR) of the DVD to the **COMPONENT IN VIDEO** jacks on the set.
 Match the jack colors
 (Y = green, PB = blue, and PR = red).

- 2
 Connect the audio outputs of the DVD to the **COMPONENT IN AUDIO** jacks on the set.

2. How to use

- Turn on the DVD player, insert a DVD.
- Select **Component** input source by using the **INPUT** button on the remote control.
- Refer to the DVD player's manual for operating instructions.

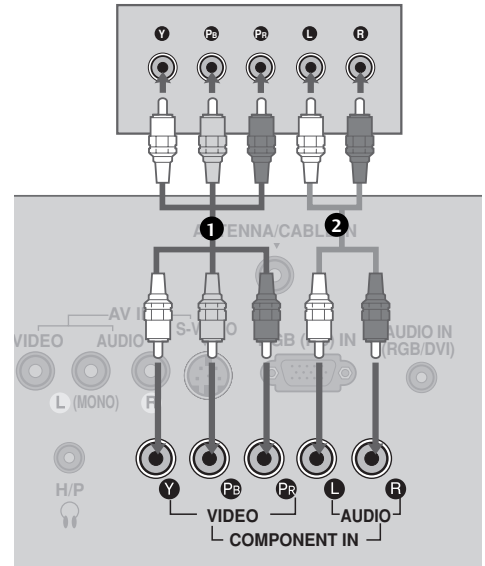

Component Input ports

To get better picture quality, connect a DVD player to the component input ports as shown below.

Component ports on the TV	Y	P _B	P _R
Video output ports on DVD player	Y	P _B	P _R
	Y	B-Y	R-Y
	Y	Cb	Cr
	Y	Pb	Pr

When connecting with an S-Video cable

1. How to connect

- 1 Connect the S-VIDEO output of the DVD to the S-VIDEO input on the set.
- 2 Connect the audio outputs of the DVD to the AUDIO input jacks on the set.

2. How to use

- Turn on the DVD player, insert a DVD.
- Select **AV** input source by using the **INPUT** button on the remote control.
- Refer to the DVD player's manual for operating instructions.

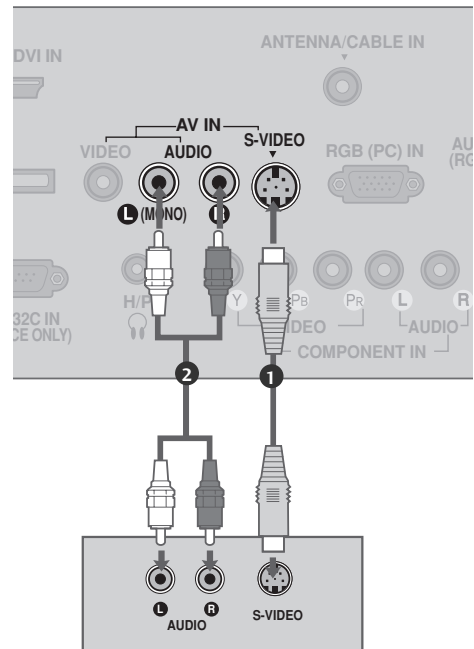

When connecting HDMI cable

1. How to connect

- 1 Connect the HDMI output of the DVD to the HDMI/DVI IN jack on the set.
- 2 No separated audio connection is necessary. HDMI supports both audio and video.

2. How to use

- Select **HDMI/DVI** input source by using the **INPUT** button on the remote control.
- Refer to the DVD player's manual for operating instructions.

! NOTE

- ▶ When connected, the TV will tell a connected device what resolution it supports and the resolution it prefers. If the device supports this Auto HDMI function, the player output resolution will be automatically set to 720p.
- ▶ If the device does not support Auto HDMI, you need to set the output resolution appropriately.
To get the best picture quality, adjust the output resolution of the DVD to 720p.

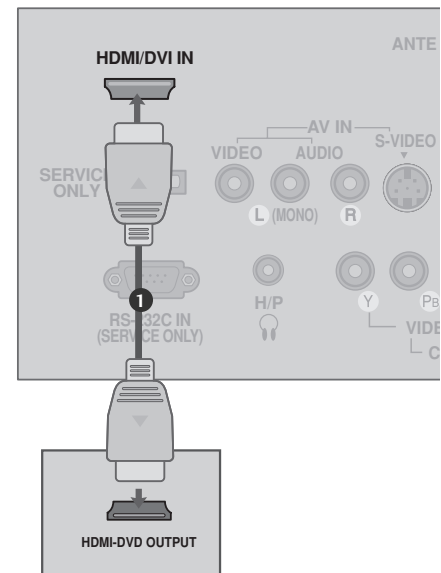

EXTERNAL EQUIPMENT SETUP

VCR SETUP

- To avoid picture noise (interference), leave an adequate distance between the VCR and TV.
- If the 4:3 picture format is used; the fixed images on the sides of the screen may remain visible on the screen. This phenomenon is common to all manufactures and in consequence the manufactures warranty does not cover the product bearing this phenomenon.

When connecting with an antenna

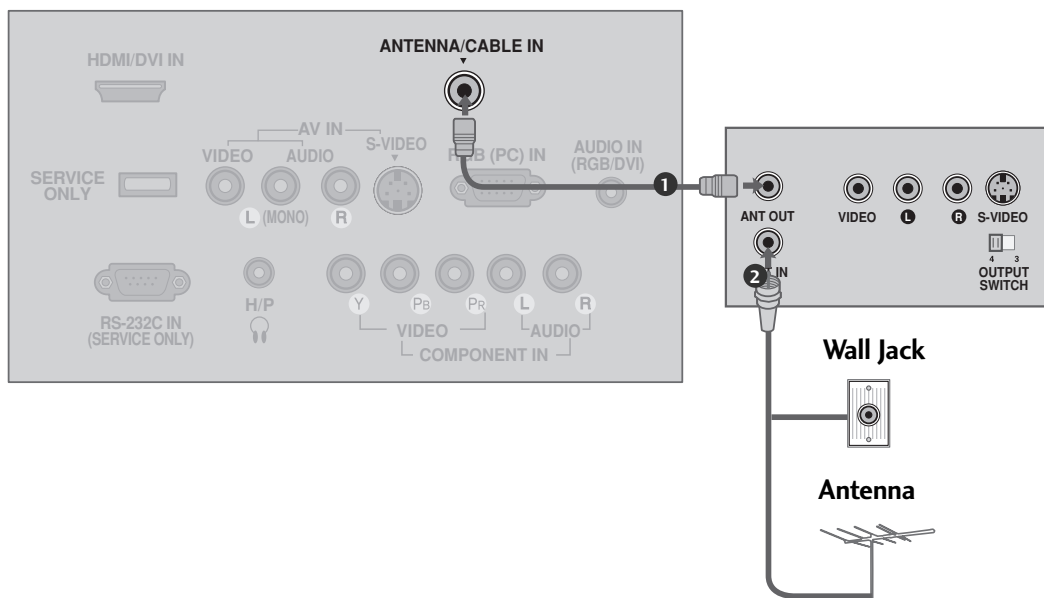

1. How to connect

- 1 Connect the RF antenna out socket of the VCR to the **ANTENNA/CABLE IN** socket on the set.
- 2 Connect the antenna cable to the RF antenna in socket of the VCR.

2. How to use

- Set VCR output switch to 3 or 4 and then tune TV to the same channel number.
- Insert a video tape into the VCR and press PLAY on the VCR. (Refer to the VCR owner's manual.)

When connecting with a RCA cable

1. How to connect

- 1 Connect the **AUDIO/VIDEO** jacks between TV and VCR. Match the jack colors (Video = yellow, Audio Left = white, and Audio Right = red)

2. How to use

- Insert a video tape into the VCR and press **PLAY** on the VCR. (Refer to the VCR owner's manual.)
- Select **AV** input source by using the **INPUT** button on the remote control.

! NOTE

- ▶ If you have a mono VCR, connect the audio cable from the VCR to the **AUDIO L/MONO** jack of the set.

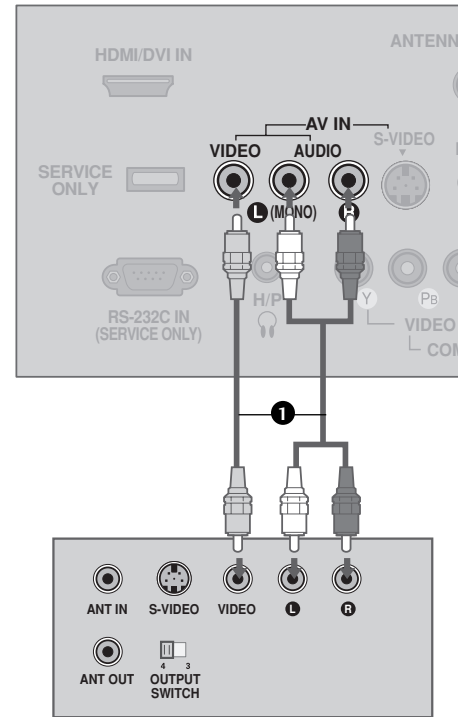

When connecting with an S-Video cable

1. How to connect

- 1 Connect the **S-VIDEO** output of the VCR to the **S-VIDEO** input on the set.
- 2 Connect the audio outputs of the VCR to the **AUDIO** input jacks on the set.

2. How to use

- Insert a video tape into the VCR and press **PLAY** on the VCR. (Refer to the VCR owner's manual.)
- Select **AV** input source by using the **INPUT** button on the remote control.

! NOTE

- ▶ The picture quality is improved: compared to normal composite (RCA cable) input.

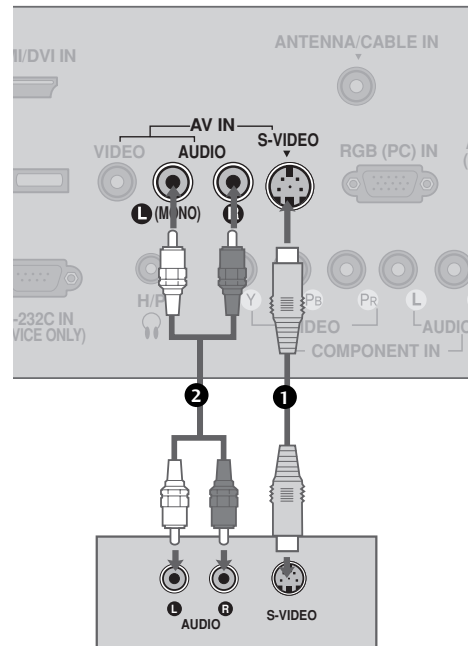

! CAUTION

- ▶ Do not connect to both Video and S-Video at the same time. In the event that you connect both Video and the S-Video cables, only the S-Video will work.

EXTERNAL EQUIPMENT SETUP

HEADPHONE SETUP

You can listen to the sound through the headphone.

1. How to connect

- 1 Plug the headphone into the headphone socket.
- 2 To adjust the headphone volume, press the **VOL +** or **-** button. If you press the **MUTE** button, the sound from the headphone is switched off.

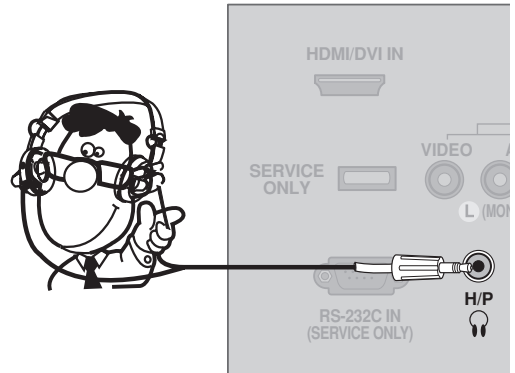

PC SETUP

This TV provides Plug and Play capability, meaning that the PC adjusts automatically to the TV's settings.

When connecting D-sub 15pin cable

1. How to connect

- 1 Connect the RGB output of the PC to the **RGB (PC) IN** jack on the set.
- 2 Connect the PC audio output to the **AUDIO IN (RGB/DVI)** jack on the set.

2. How to use

- Turn on the PC and the TV.
- Select **RGB-PC** input source by using the **INPUT** button on the remote control.

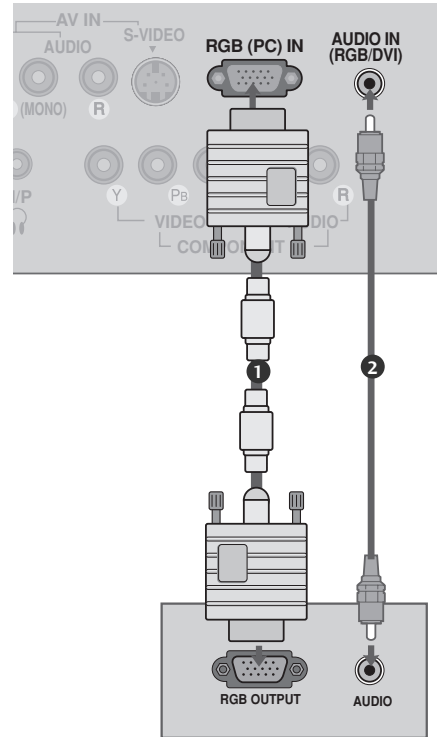

When connecting HDMI to DVI cable

1. How to connect

- 1 Connect the DVI output of the PC to the **HDMI/DVI IN** jack on the set.
- 2 Connect the PC audio output to the **AUDIO IN (RGB/DVI)** jack on the set.

2. How to use

- Turn on the PC and the TV.
- Select **HDMI/DVI** input source by using the **INPUT** button on the remote control.

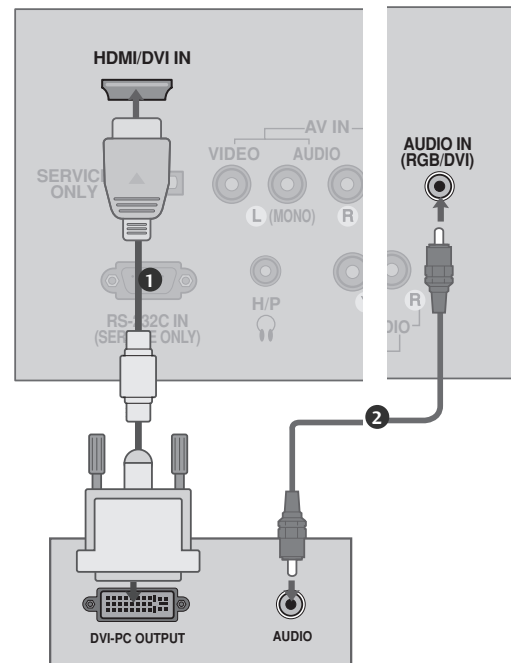

EXTERNAL EQUIPMENT SETUP

! NOTES

- ▶ To get the the best picture quality, adjust the PC graphics card to 1024x768, 60Hz.
- ▶ Depending on the graphics card, DOS mode may not work if a HDMI to DVI Cable is in use.
- ▶ If the video doesn't fit the screen, try pressing the ADJUST button to adjust the screen position of TV.
- ▶ Check the image on your TV. There may be noise associated with the resolution, vertical pattern, contrast or brightness in PC mode. If noise is present, change the PC output to another resolution, change the refresh rate to another rate or adjust the brightness and contrast on the VIDEO menu until the picture is clear. If the refresh rate of the PC graphic card can not be changed, change the PC graphic card or consult the manufacturer of the PC graphic card.
- ▶ Avoid keeping a fixed image on the screen for a long period of time. The fixed image may become permanently imprinted on the screen.
- ▶ The synchronization input form for Horizontal and Vertical frequencies is separate.

Supported Display Specifications

Resolution	Horizontal Frequency(KHz)	Vertical Frequency(Hz)	
640x350	31.469	70.08	● * RGB-PC mode only
720x400	31.469	70.08	
640x480	31.469	59.94	
800x600	37.879	60.31	
1024x768	48.363	60.00	
1280x768	47.776	59.87	
1360x768	47.712	60.01	
1366x768	60.023	60.00	
720x480	31.469	59.94	● * HDMI mode only
	31.500	60.00	
1280x720	44.96	59.94	●
	45.000	60.00	
1920x1080	33.72	59.94	●
	33.75	60.00	

Screen Setup for PC mode

Overview

When the RGB input of the set is connected to a PC output, select the RGB-PC as the main input mode.

When HDMI connect to PC output and select HDMI/DVI input, this function is used.

After connecting RGB-PC or HDMI/DVI to PC output and checking the screen quality.

When you change the resolution, select the proper resolution in present input to see the best picture appearance.

Adjustment for screen Resolution, Position, Size, and Phase

- 1 Press the **ADJUST** button and then use ▲ or ▼ button to select **Resolution**, **Position**, **Size**, or **Phase**.
- 2 Press the **ENTER** button and then use ▲ ▼ ◀ ▶ button to make appropriate adjustments.
 - The **Phase** adjustment range is 0 ~ +64.
In HDMI/DVI-PC mode, **Phase** is not available.
 - The **Size** adjustment range is -30 ~ +30.
In HDMI/DVI-PC mode, **Size** is not available.
- 3 Press the **ENTER** button.

Auto Configuration and Initializing (Reset to original factory values)

- 1 Press the **ADJUST** button and then use ▲ or ▼ button to select **Auto** or **Reset**.
- 2 Press the **ENTER** button and then use ◀ or ▶ button to select **Yes**.
- 3 Press the **ENTER** button.

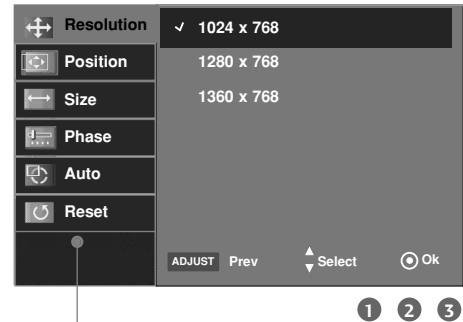

- Resolution** This function allows you select resolution of XGA/WXGA.
- Position** This function is to adjust picture to left/right and up/down as you prefer.
- Size** This function is to minimize any vertical bars or stripes visible on the screen background. And the horizontal screen size will also change.
- Phase** This function allows you to remove any horizontal noise and clear or sharpen the image of characters.
- Auto** This function is to adjust picture position and minimizes image shaking automatically.
- Reset** This function is to initialize the adjusted value.

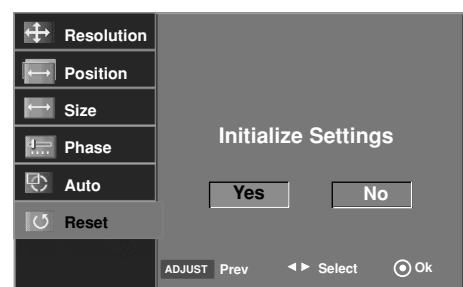

1 2 3

WATCHING TV / CHANNEL CONTROL

REMOTE CONTROL FUNCTIONS

When using the remote control, aim it at the remote control sensor on the TV.

SAP • Analog mode: Selects MTS sound (Mono, Stereo, or a SAP) ► **p.48**
• DTV mode: Changes the audio language.

PICTURE Selects the factory preset picture depend on the viewing environment. ► **p.38**

SOUND Selects the factory preset sound for type of program. ► **p.45**

TIMER Select the amount of time before your TV turns off automatically. ► **p.58**

VOLUME UP /DOWN Increase/decrease the sound level.

ADJUST Adjust the screen resolution, position, size and phase. ► **p.27**

MUTE Switch the sound on or off. ► **p.30**

CC Select a closed caption. ► **p.51**

CHANNEL UP/DOWN Select available channels.

MENU Displays the main menu.

BACK Tune to the last channel viewed.

EXIT Clear all on-screen displays and return to TV viewing from any menu.

THUMBSTICK (Up/Down/Left Right/ENTER) Navigate the on-screen menus and adjust the system settings to your preference.

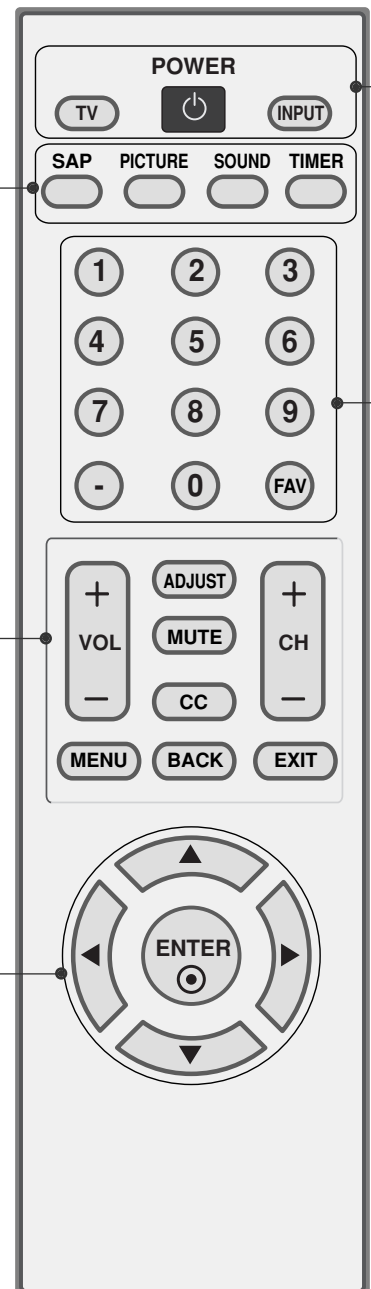

POWER Turns your TV or any other programmed equipment on or off, depending on the mode.

TV In AV, Component, RGB-PC, and HDMI/DVI input sources, screen returns to the last TV channel.

INPUT External input modes rotate in regular sequence: TV, AV, Component, RGB-PC, and HDMI/DVI. (AV, Component, RGB-PC, and HDMI/DVI input sources are linked automatically, only if a device is connected.)

NUMBER button

— (DASH) Used to enter a program number for multiple program channels such as 2-1, 2-2, etc.

FAV Scroll through the programmed Favorite channels. ► **p.34**

Installing Batteries

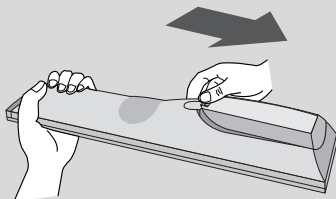

- Open the battery compartment cover on the back side and install the batteries matching correct polarity (+ with +, - with -).
- Install two 1.5V AAA batteries. Don't mix old or used batteries with new ones.
- Close cover.

Remote control effective range

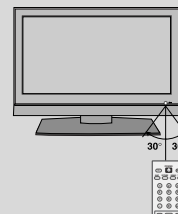

- Use a remote control up to 7 meters distance and 30 degree (left/right) within the receiving unit scope.
- Dispose of used batteries in a recycle bin to preserve environment.

WATCHING TV / CHANNEL CONTROL

TURNING ON TV

- 1 First, connect power cord correctly.
At this moment, the TV switches to standby mode.
 - In standby mode to turn TV on, press the $\phi/|$, **INPUT**, **CH** (\blacktriangle or \blacktriangledown) button on the TV or press the **POWER**, **INPUT**, **TV**, **CH** (+ or -), **Number (0~9)** button on the remote control.
- 2 Select the viewing source by using the **INPUT** button on the remote control.
 - This TV is programmed to remember which power state it was last set to, even if the power cord is out.
- 3 When finished using the TV, press the **POWER** button on the remote control. The TV reverts to standby mode.



! NOTE

- ▶ If you intend to be away on vacation, disconnect the power plug from the wall power outlet.

CHANNEL SELECTION

- 1 Press the **CH** (+ or -) or **NUMBER** buttons to select a channel number.



VOLUME ADJUSTMENT

Adjust the volume to suit your personal preference.

- 1 Press the **VOL** (+ or -) button to adjust the volume.
- 2 If you want to switch the sound off, press the **MUTE** button.
- 3 You can cancel the Mute function by pressing the **MUTE** or **VOL** (+ or -) button.



ON-SCREEN MENUS SELECTION

Your TV's OSD (On Screen Display) may differ slightly from what is shown in this manual.

- 1 Press the **MENU** button and then use **▲** or **▼** button to select the each menu.
- 2 Press the **▶** button and then use **▲ ▼ ◀ ▶** button to display the available menus.

SETUP

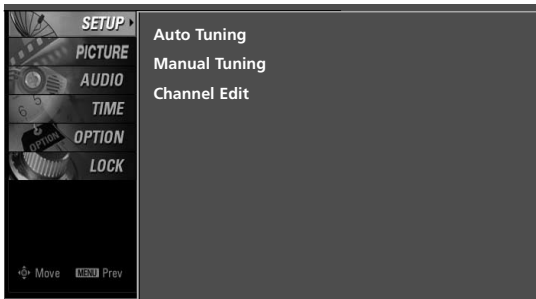

PICTURE

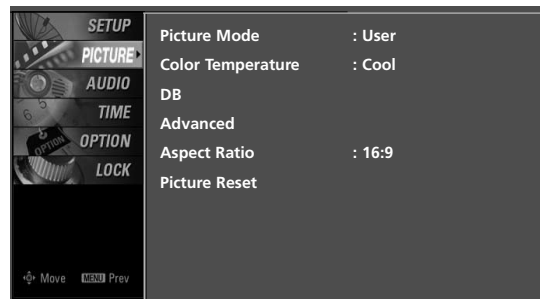

LOCK

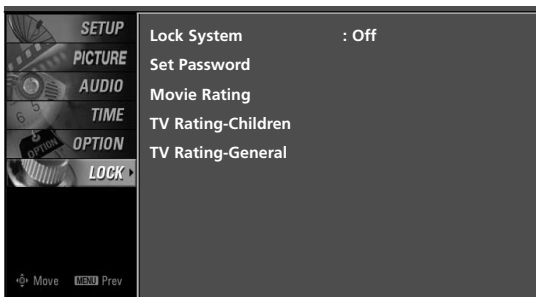

AUDIO

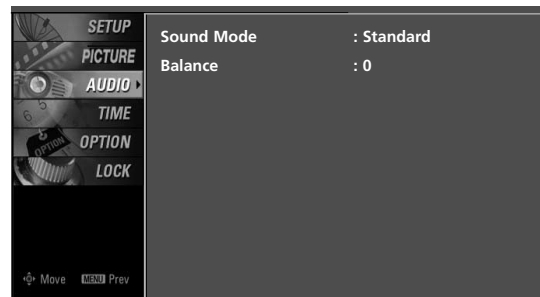

OPTION

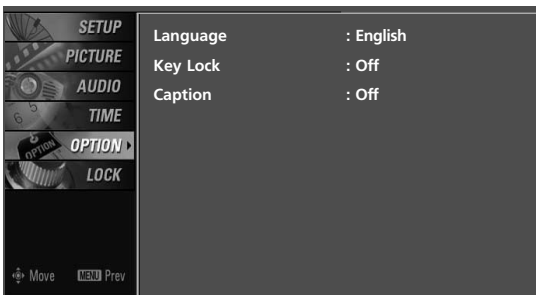

TIME

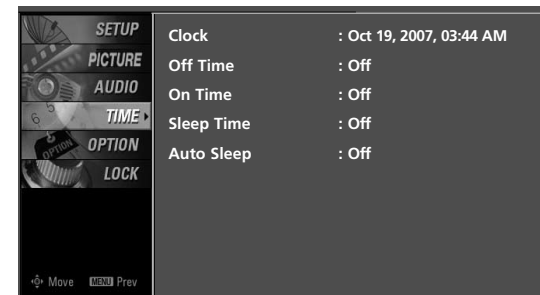

WATCHING TV / CHANNEL CONTROL

CHANNEL SEARCH

Auto Scan (Auto Tuning)

Automatically finds all channels available through antenna or cable inputs, and stores them in memory on the channel list.

Run Auto Tuning again after any Antenna/Cable connection changes.

A password is required to gain access to Auto Tuning menu if the Lock System is turned on.

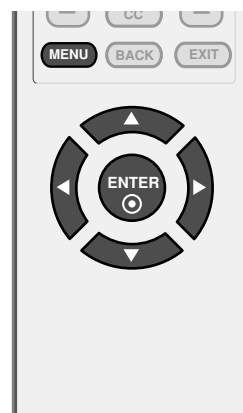

1 Press the **MENU** button and then use ▲ or ▼ button to select the **SETUP** menu.

2 Press the ► button and then use ▲ or ▼ button to select **Auto Tuning**.

3 Press the **ENTER** button to begin the channel search. Allow **Auto Tuning** to complete the channel search cycle for **ANTENNA** and **CABLE**.

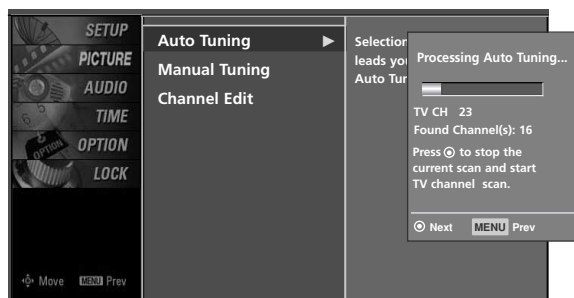
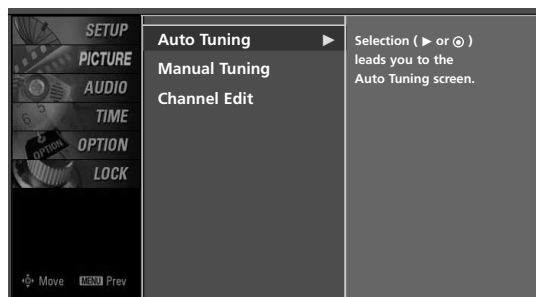
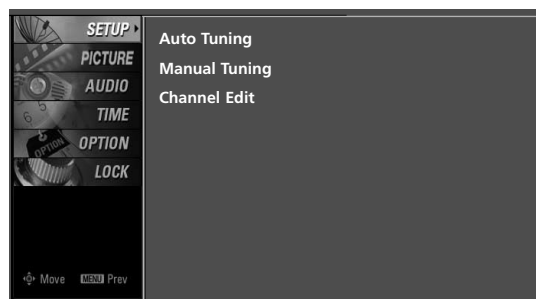

Add/Delete Channel (Manual Tuning)

A password is required to gain access to Manual Tuning menu if the Lock System is turned on.

If selecting DTV or CADTV input signal, you can view the on-screen signal strength monitor to see the quality of the signal being received.

- 1 Press the **MENU** button and then use ▲ or ▼ button to select the **SETUP** menu.
- 2 Press the ► button and then use ▲ or ▼ button to select **Manual Tuning**.
- 3 Press the ► button and then use ▲ or ▼ button to select **TV, DTV, CATV, and CADTV**.
- 4 Press the ► button and then use ▲ or ▼ button to select channel you want to add or delete.
- 5 Press the **ENTER** button to add or delete the channel.
- 6 Press the **EXIT** button to return to TV viewing or press **MENU** button to return to the previous menu.

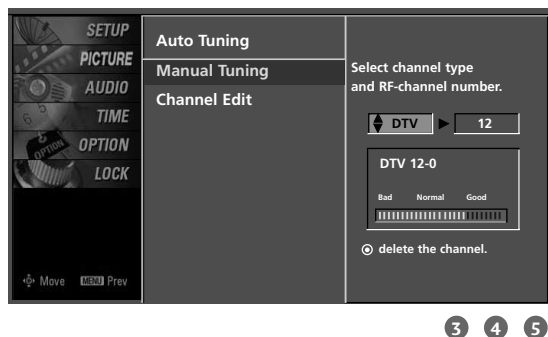
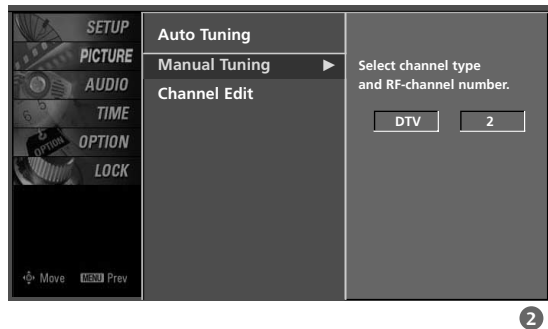
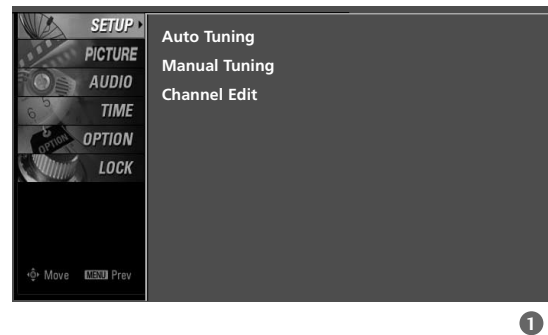
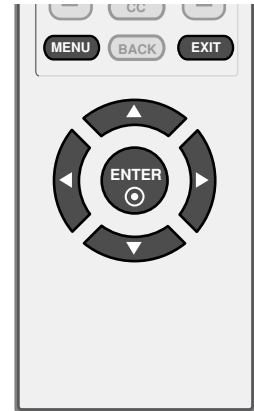

4 5

WATCHING TV / CHANNEL CONTROL

Channel Editing

There are two different ways in order to add or delete scanned channels. One is "Custom List" and the other is "Favorite List" in the channel list. Both of them are available after **Auto Tuning** on the **SETUP** menu.

A Custom List can be created by toggling each channel on or off with **ENTER** button. The channels in the Custom List are displayed in black, and the channels deleted from the Custom List are displayed in gray. Once a channel is highlighted you can add or delete the channel by referring to the small window at the top-left corner of the screen.

You can create your own Favorite List. Use the **FAV** button on the remote control when a channel is highlighted and then add or delete the channel to/from your Favorite List.



1 Press the **MENU** button and then use ▲ or ▼ button to select the **SETUP** menu.

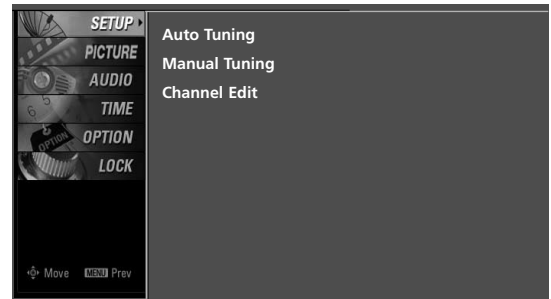

1

2 Press the ► button and then use ▲ or ▼ button to select **Channel Edit**.

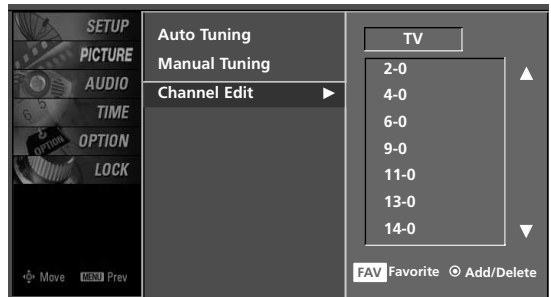

2

3 Press the ► button and then use ▲ or ▼ button to select channel and then use the **ENTER** button to add or delete it.

Press **FAV** button to add the channel to the Favorite List. The surfing icon will appear in back of that channel number.

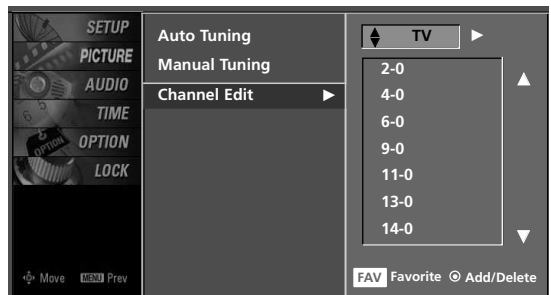

3 4

4 Press **EXIT** button to return to TV viewing or press **MENU** button to return to the previous menu.

KEY LOCK

The TV can be set up so that it can only be used with the remote control.

This feature can be used to prevent unauthorized viewing by locking out the front panel controls.

This TV is programmed to remember which option it was last set to even if you turn the TV off.

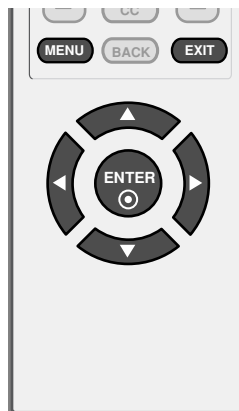

1 Press the **MENU** button and then use ▲ or ▼ button to select the **OPTION** menu.

2 Press the ► button and then use ▲ or ▼ button to select **Key lock**.

3 Press the ► button and then use ▲ or ▼ button to select **On** or **Off**.

4 Press **EXIT** button to return to TV viewing or press **MENU** button to return to the previous menu.



1

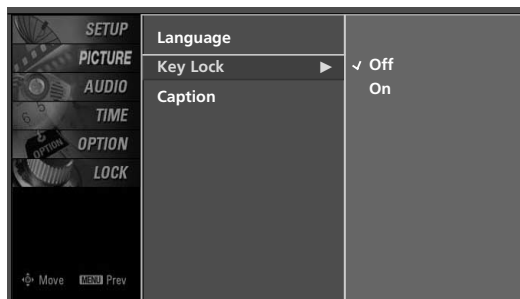

2 3

PICTURE CONTROL

PICTURE SIZE (ASPECT RATIO) CONTROL

This feature allows an analog picture with a 4:3 aspect ratio is displayed on your TV. When you receive an analog picture with a 4:3 aspect ratio on your 16:9 TV, you need to specify how the picture is to be displayed.

- RGB-PC input source use 4:3 or 16:9 aspect ratio.



! NOTE

- ▶ If a fixed image is displayed on the screen for a long time, the image may become imprinted on the screen and remain visible. This phenomenon is common to all manufactures and in consequence the manufactures warranty does not cover the product bearing this phenomenon.

- 1 Press the **MENU** button and then use **▲** or **▼** button to select the **PICTURE** menu.

- 2 Press the **▶** button and then use **▲** or **▼** button to select **Aspect Ratio**.

- 3 Press the **▶** button and then use **▲** or **▼** button to select the desired picture option (**Set By Program**, **4:3**, **16:9**, **Full**, **Horizon**, or **Zoom**).

- 4 Press **EXIT** button to return to TV viewing or press **MENU** button to return to the previous menu.

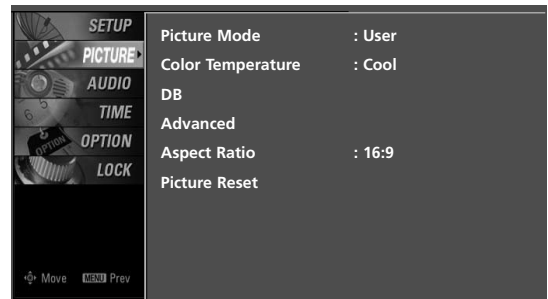

1

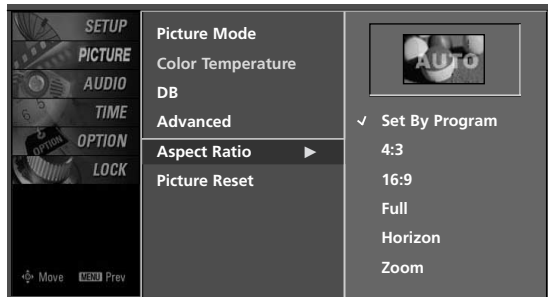

2 3

Set by program

Selects the proper picture proportion to match the source's image.

(4:3 → 4:3)



(16:9 → 16:9)

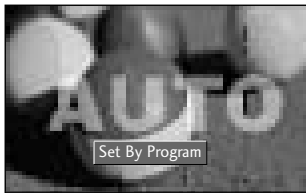

4:3

Choose 4:3 when you want to view a picture with an original 4:3 aspect ratio.

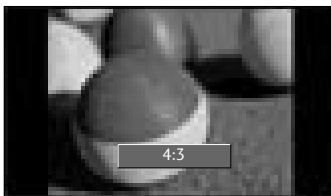

16:9

Adjust the picture horizontally, in a linear proportion to fill the entire screen.

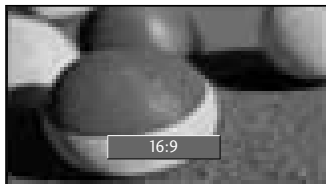

Horizon

The screen size is, more enlarged at both sides, to create a spectacular view.



Zoom

Choose Zoom when you want to view the picture without any alteration. However, the top and bottom portions of the picture will be cropped.

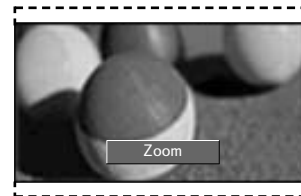

PICTURE CONTROL

PRESET PICTURE SETTINGS

Picture Mode - Preset

Picture Mode adjusts the TV for the best picture appearance. Select the preset value in the Picture Mode menu based on the program category.

Dynamic, Standard, Mild Settings are preset for the optimum picture quality at the factory and are not adjustable.

In the **User** mode only, user can directly adjust the contrast, brightness, color, sharpness, tint.

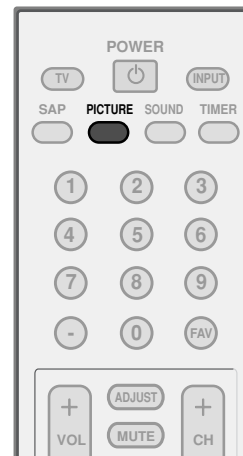

- 1 Press the **PICTURE** button repeatedly to select the picture appearance setup option as below :
Dynamic, Standard, Mild, and User (your own settings).

- 2 Press the **EXIT** button to save and return to TV viewing.

- You can also use the **PICTURE** menu to adjust **Picture Mode**.

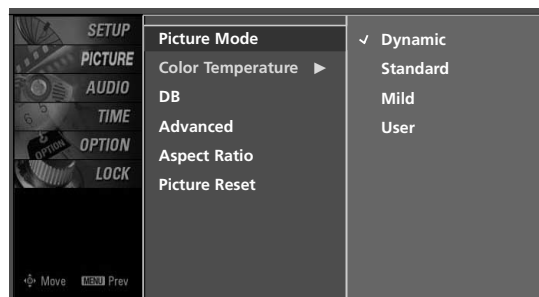
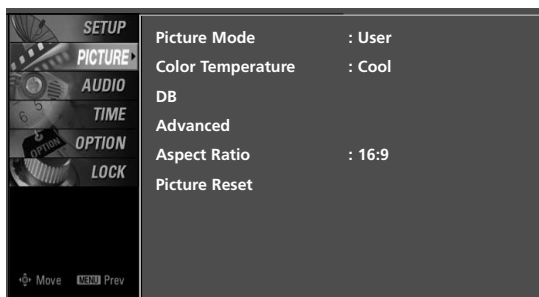

Color Tone - Preset

Choose one of three automatic color adjustments. Set to warm to enhance hotter colors such as red, or set to cool to see less intense colors with more blue.

When selecting Picture Mode options (Dynamic, Standard and Mild), Color Temperature is automatically change.

When selecting Picture Mode options (User), you can choose the Color Temperature.



1 Press the **MENU** button and then use ▲ or ▼ button to select the **PICTURE** menu.

2 Press the ► button and then use ▲ or ▼ button to select **Color Temperature**.

3 Press the ► button and then use ▲ or ▼ button to select either **Cool, Medium, Warm** or **User**.

4 Press **EXIT** button to return to TV viewing or press **MENU** button to return to the previous menu.

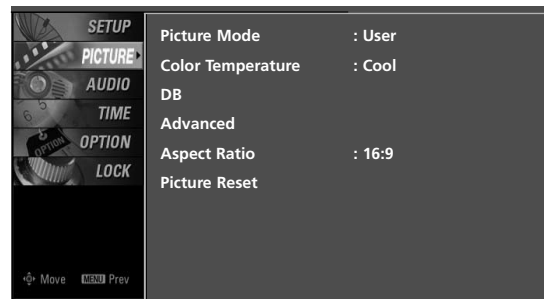

1

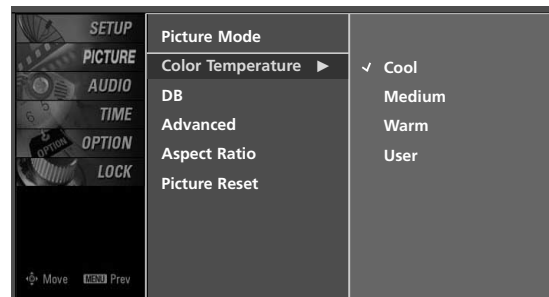

2 3

PICTURE CONTROL

MANUAL PICTURE ADJUSTMENT

Picture Mode - User Mode

Adjust the picture appearance to suit your preference and viewing situations.



1 Press the **MENU** button and then use ▲ or ▼ button to select the **PICTURE** menu.

2 Press the ► button and then use ▲ or ▼ button to select **Picture Mode**.

3 Press the ► button and then use ▲ or ▼ button to select **User**.

4 Press the ► button and then use ▲ or ▼ button to select the desired picture option (**Backlight**, **Contrast**, **Brightness**, **Color**, **Sharpness**, or **Tint**).

■ Backlight

To control the brightness of screen, adjust the brightness of LCD panel.

5 Press the ► button and then use ◀ or ▶ button to make appropriate adjustments.

6 Press **EXIT** button to return to TV viewing or press **MENU** button to return to the previous menu.

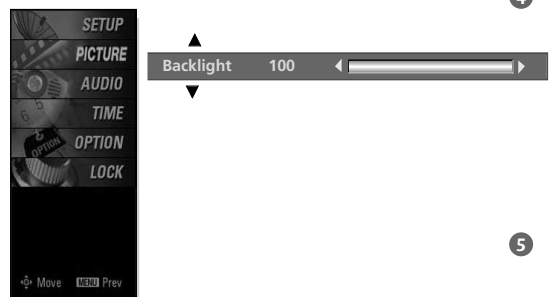
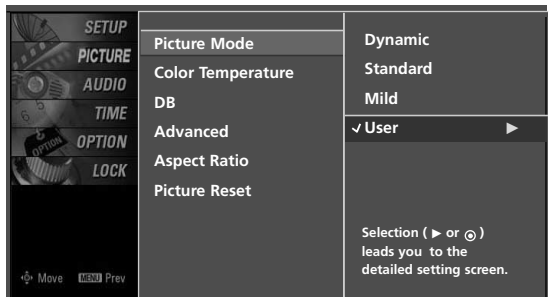
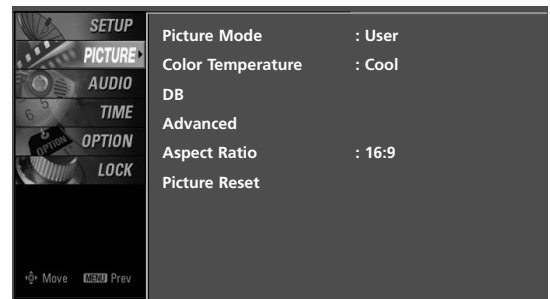

Color Tone - User Mode

You can also adjust the detailed settings (Red, Green, Blue) by selecting the **Color Temperature-User** menu. This feature operate only if the picture mode set **User**.



1 Press the **MENU** button and then use ▲ or ▼ button to select the **PICTURE** menu.

2 Press the ► button and then use ▲ or ▼ button to select **Color Temperature**.

3 Press the ► button and then use ▲ or ▼ button to select **User**.

4 Press the ► button and then use ▲ or ▼ button to select **Red, Green, or Blue**.

5 Press the ► button and then use ◀ or ▶ button to make appropriate adjustments.

- The adjustment range of **Red, Green, or Blue** is -20~ +20.

6 Press **EXIT** button to return to TV viewing or press **MENU** button to return to the previous menu.

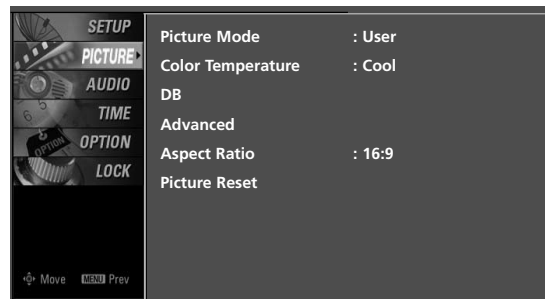

1

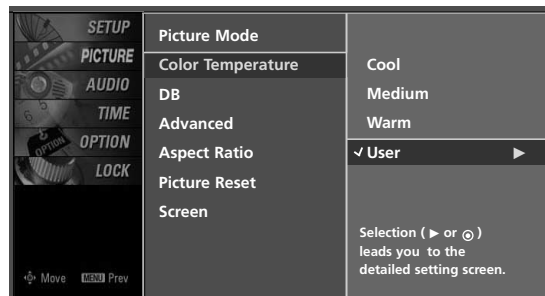

2 3

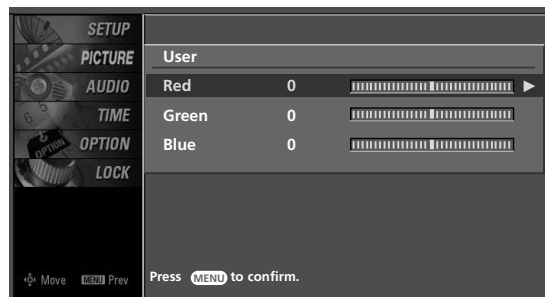

4



5

PICTURE CONTROL

DB - DIGITAL BOOSTER

DB is LG Electronic's unique picture improving technology to display a real HD source through an advanced digital signal processing algorithm.

When selecting Picture Mode options (Dynamic, Standard, and Mild), DB is automatically changed to Auto.

When selecting Picture Mode option (User), you can choose the Auto / Manual.

When selecting the Manual, you can adjust the DB Contrast, DB color and DB Noise.



1 Press the **MENU** button and then use **▲** or **▼** button to select the **PICTURE** menu.

2 Press the **▶** button and then use **▲** or **▼** button to select **DB**.

3 Press the **▶** button and then use **◀** or **▶** button to select **Auto** or **Manual**.

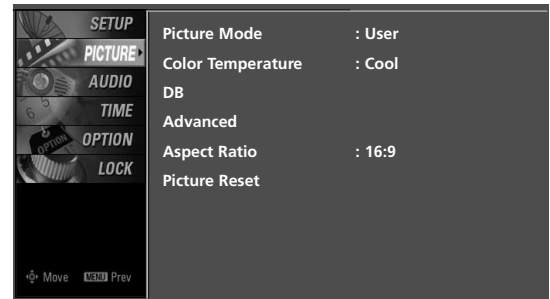

1

Selecting the Manual

1. Press the **▼** button and then use **▲** or **▼** button to select **DB Contrast**, **DB Color** or **DB Noise**.

- **DB Contrast:** Optimizing the contrast automatically according to the brightness of the reflection.
- **DB Color:** Adjusting the colors of the reflection automatically to reproduce as closely as possible to the natural colors.
- **DB Noise :** Removing the noise up to the point where it does not damage the original picture.

2. Use the **▲** or **▼** button to select **On** or **Off**.

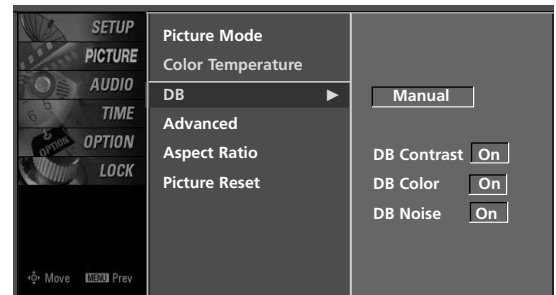

2 3

4 Press **EXIT** button to return to TV viewing or press **MENU** button to return to the previous menu.

ADVANCED - BLACK (DARKNESS) LEVEL

Adjusting the contrast and the brightness of the screen using the black level of the screen.

This feature operates only in AV1, AV2, HDMI1/DVI, or HDMI2 mode.



1 Press the **MENU** button and then use ▲ or ▼ button to select the **PICTURE** menu.

2 Press the ► button and then use ▲ or ▼ button to select **Advanced**.

3 Press the ► button and then use ▲ or ▼ button to select **Black level Low** or **High**.

- **Low**
The screen gets darker.
- **High**
The screen gets brighter.

4 Press **EXIT** button to return to TV viewing or press **MENU** button to return to the previous menu.

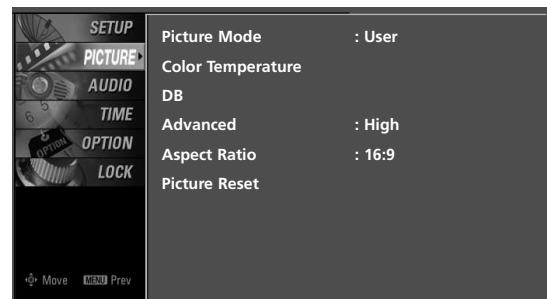

1

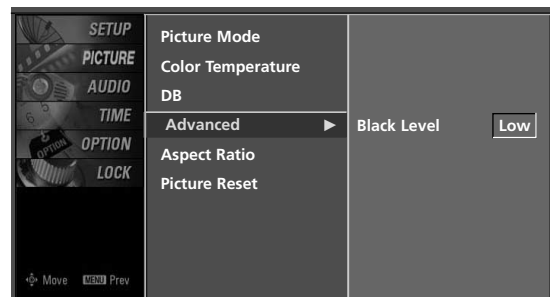

2 3

PICTURE CONTROL

PICTURE RESET

Use to quickly reset all the Picture menu options to their original factory preset values.



1 Press the **MENU** button and then use ▲ or ▼ button to select the **PICTURE** menu.

2 Press the ► button and then use ▲ or ▼ button to select **Picture Reset**.

3 Press the ► button to reset the Picture menu options to original values.

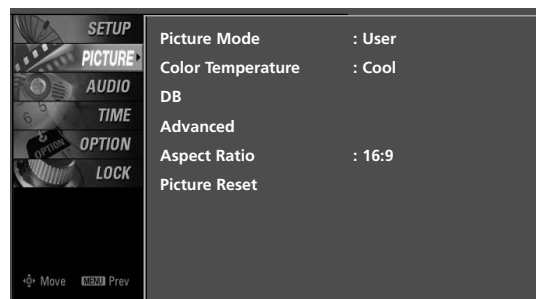

1

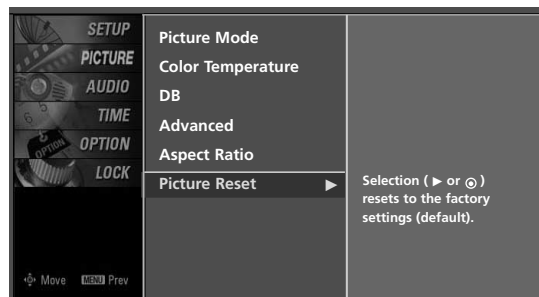

2 3

SOUND & LANGUAGE CONTROL

PRESET SOUND SETTINGS (SOUND MODE)

Sound Mode lets you enjoy the best sound without any special adjustment because the TV sets the appropriate sound options based on the program content.

Standard, Music, News, Movie, and Sports are preset for good sound quality at the factory and are not adjustable.



1 Press the **SOUND** button repeatedly to select the appropriate sound setup as below :
Standard, Music, Movie, Sports, and User (your own settings).

2 Press **EXIT** button to return to TV viewing.

■ You can also adjust **Sound Mode** in the **AUDIO** menu.

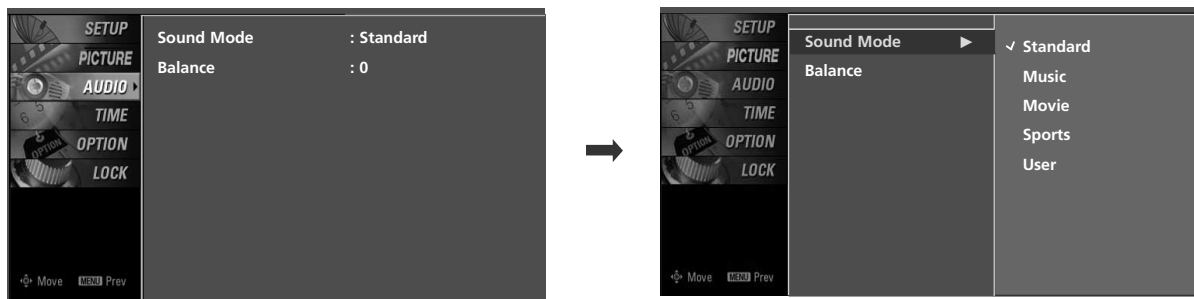

SOUND & LANGUAGE CONTROL

SOUND SETTING ADJUSTMENT - USER MODE

Adjust the sound to suit your taste and room situations.



1 Press the **MENU** button and then use ▲ or ▼ button to select the **AUDIO** menu.

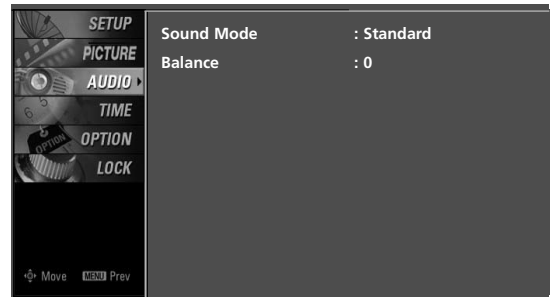

2 Press the ► button and then use ▲ or ▼ button to select **Sound Mode**.

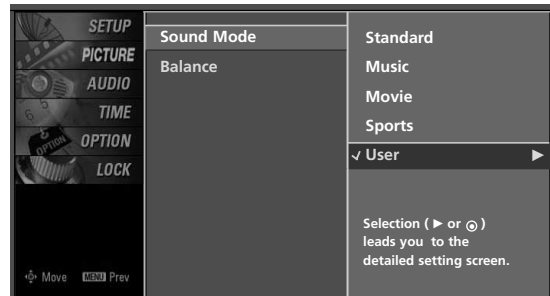

3 Press the ► button and then use ▲ or ▼ button to select **User**.

4 Press the ► button and then use ▲ or ▼ button to select the desired sound option (**Treble** or **Bass**).



5 Press the ► button and then use ◀ or ▶ button to make appropriate adjustments.

6 Press **EXIT** button to return to TV viewing or press **MENU** button to return to the previous menu.

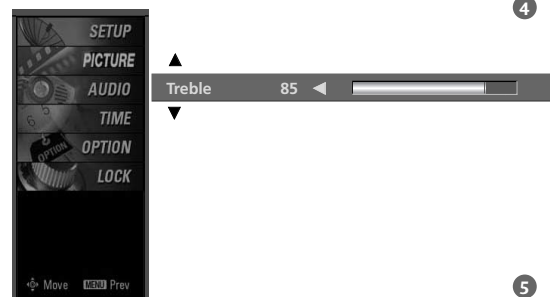

BALANCE

Adjust the left/right sound of speaker to suit your taste and room situations.

- 1 Press the **MENU** button and then use ▲ or ▼ button to select the **AUDIO** menu.
- 2 Press the ► button and then use ▲ or ▼ button to select **Balance**.
- 3 Press the ► button and then use ◀ or ▶ button to make appropriate adjustments.
- 4 Press **EXIT** button to return to TV viewing or press **MENU** button to return to the previous menu.

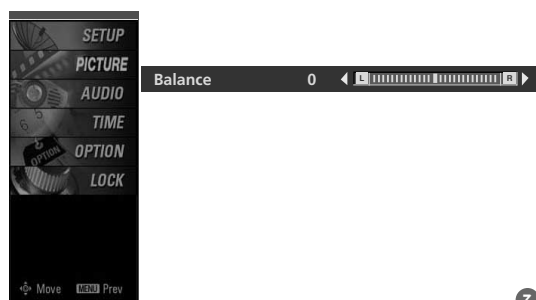
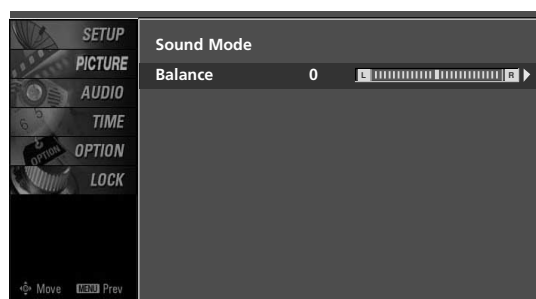
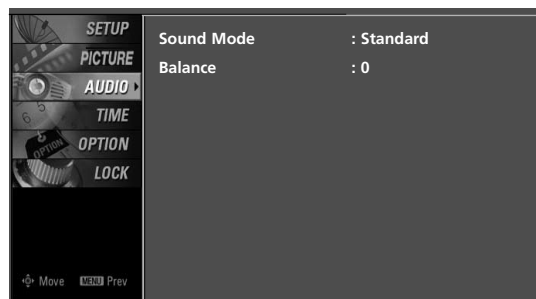

SOUND & LANGUAGE CONTROL

STEREO/SAP BROADCASTS SETUP

This TV can receive MTS stereo programs and any SAP (Secondary Audio Program) that accompanies the stereo program if the station transmits an additional sound signal as well as the original one and when you select Stereo or SAP on the remote control.

Mono sound is automatically received if the broadcast is only in Mono; even though Stereo or SAP has been selected.

Select Mono if you want to listen to the mono sound in remote areas during stereo/SAP broadcasting.

Stereo or SAP can be received in Analog channel.



1 Use the **SAP** button to select your desired MTS mode in analog signal. Each time you press the **SAP** button, **Mono**, **Stereo**, or **SAP** appear in turn.

- If other languages available on the digital signal, select them with the **SAP** button.

2 Press **EXIT** button to save and return to TV viewing.

AUDIO LANGUAGE

Other languages may be available if a digital signal is provided by the broadcasting station.
This feature operates only in DTV/CADTV mode.



1 Press the **MENU** button and then use **▲** or **▼** button to select the **OPTION** menu.

2 Press the **▶** button and then use **▲** or **▼** button to select **Language**.

3 Press the **▶** button and then use **▲** or **▼** button to select **Audio**.

4 Press the **▶** button and then use **◀** or **▶** button to select **English, Spanish, or French**.

5 Press **EXIT** button to return to TV viewing or press **MENU** button to return to the previous menu.



1

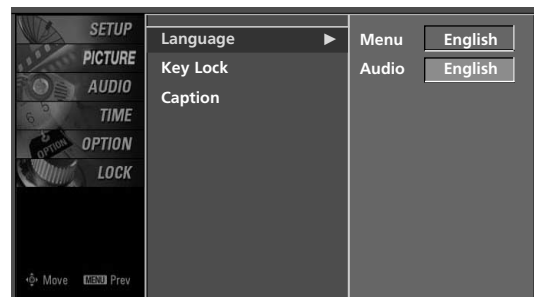

2 3

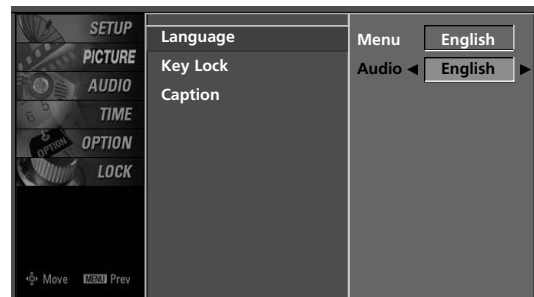

4

SOUND & LANGUAGE CONTROL

ON-SCREEN MENUS LANGUAGE SELECTION

The menus can be shown on the screen in the selected language. First select your language.



1 Press the **MENU** button and then use ▲ or ▼ button to select the **OPTION** menu.

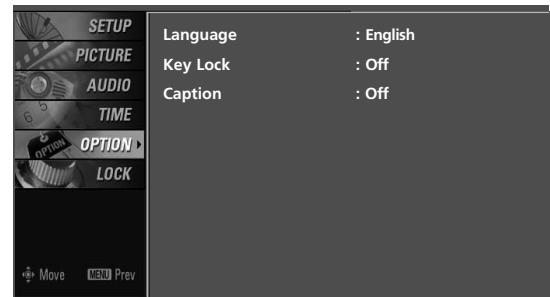

2 Press the ► button and then use ▲ or ▼ button to select **Language**.

3 Press the ► button and then use ▲ or ▼ button to select **Menu**.

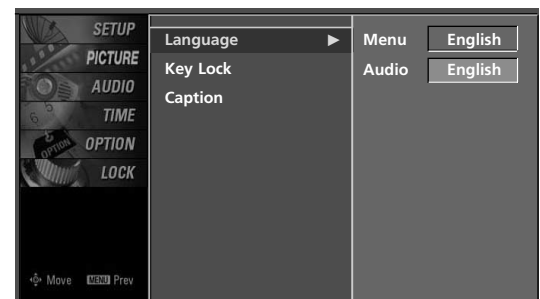

4 Press the ► button and then use ◀ or ▶ button to select your desired language.
From this point on, the on-screen menus will be shown in the selected language.

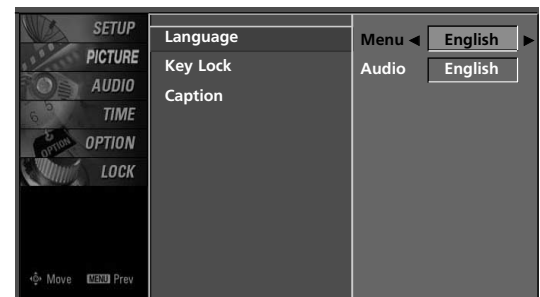

5 Press the **EXIT** button to return to TV viewing or press **MENU** to return to the previous menu.

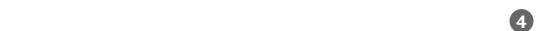

CAPTION MODE

Caption must be provided to help people with hearing loss watch TV.



- 1 Use the **CC** button to select Caption **On** or **Off**.
 - When selecting **Off**, Sub-menus for Analog, DTV, and Digital Option become disabled.

- 2 Press **EXIT** to save and return to TV viewing.

- You can also adjust **Caption** in the **OPTION** menu.

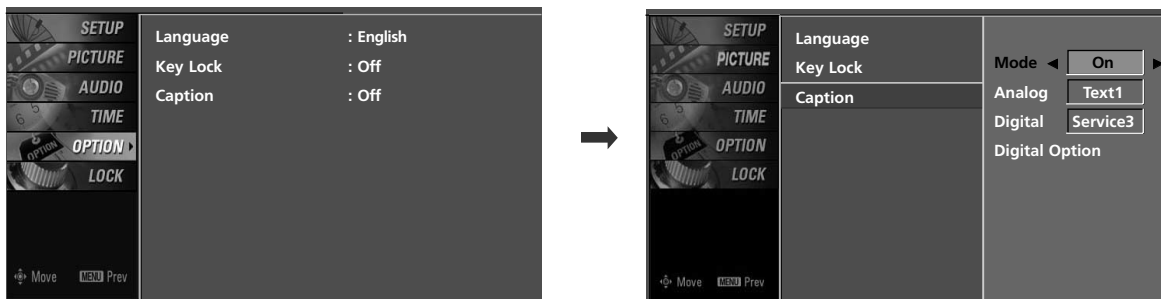

SOUND & LANGUAGE CONTROL

Analog Broadcasting System Captions

Select a caption mode for displaying captioning information if provided on a program. Analog caption displays information at any position on the screen and is usually the program's dialog.

Caption/Text, if provided by the broadcaster, would be available for both digital and analog channels on the Antenna/Cable.

This TV is programmed to memorize the caption/text mode which was last set when you turn the power off.

This function is only available when **Caption Mode** is set **On**.

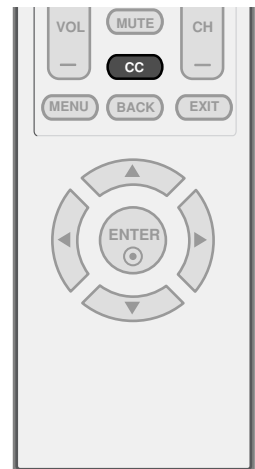

1 Press the **MENU** button and then use **▲** or **▼** button to select the **OPTION** menu.

2 Press the **▶** button and then use **▲** or **▼** button to select **Caption**.

3 Press the **▶** button and then use **▲** or **▼** button to select **Analog**.

4 Press the **▶** button and then use **◀** or **▶** button to select **CC1, CC2, CC3, CC4, Text1, Text2, Text3** or **Text4**

■ CAPTION

The term for the words that scroll across the bottom of the TV screen; usually the audio portion of the program provided for the hearing impaired.

■ TEXT

The term for the words that appear in a large black frame and almost cover the entire screen; usually messages provided by the broadcaster.

5 Press the **EXIT** button to return to TV viewing or press **MENU** to return to the previous menu.

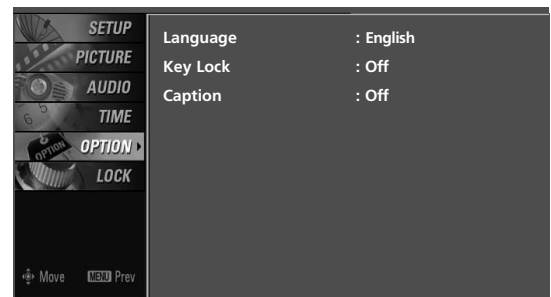

1

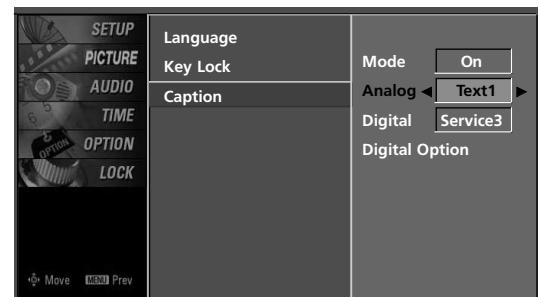

2 3 4

Digital Broadcasting System Captions

Choose the language you want the DTV/CADTV Captions to appear in.

Other Languages can be chosen for digital sources only if they are included on the program.

This function is only available when **Caption Mode** is set **On**.



1 Press the **MENU** button and then use ▲ or ▼ button to select the **OPTION** menu.

2 Press the ► button and then use ▲ or ▼ button to select **Caption**.

3 Press the ► button and then use ▲ or ▼ button to select **Digital**.

4 Press the ► button and then use ◀ or ▶ button to select **Service1 ~ Service6**.

5 Press **EXIT** button to return to TV viewing or press **MENU** button to return to the previous menu.

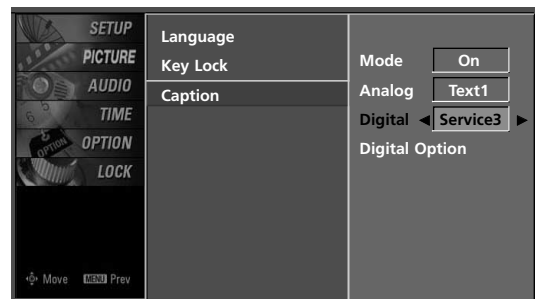

3 **4**

SOUND & LANGUAGE CONTROL

Caption Option

Customize the DTV/CADTV captions that appear on your screen.

This function is only available when **Caption Mode** is set **On**.

1 Press the **MENU** button and then use **▲** or **▼** button to select the **OPTION** menu.

2 Press the **▶** button and then use **▲** or **▼** button to select **Caption**.

3 Press the **▶** button and then use **▲** or **▼** button to select **Digital Option**.

4 Press the **▶** button and then use **◀** or **▶** button to select **Custom**.

5 Use **▲** or **▼** button to customize the **Style, Font,** etc., to your preference.

A preview icon is provided at the bottom of the screen, use it to see the caption language.

- **Size** : Set the word size.
- **Font** : Select a typeface for the text.
- **Text Color** : Choose a color for the text.
- **Text Opacity** : Specify the opacity for the text color.
- **Bg (Background) Color** : Select a background color.
- **Bg (Background) Opacity** : Select the opacity for the background color.
- **Edge Type** : Select an edge type.
- **dge Color** : Select a color for the edges.

6 Press **EXIT** button to return to TV viewing or press **MENU** button to return to the previous menu.

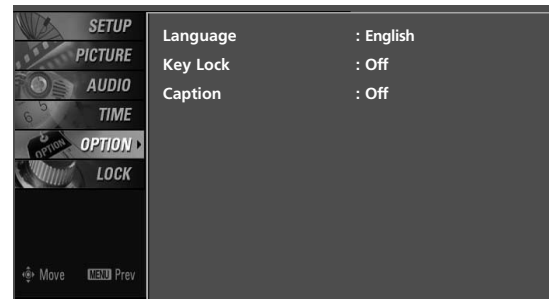

1

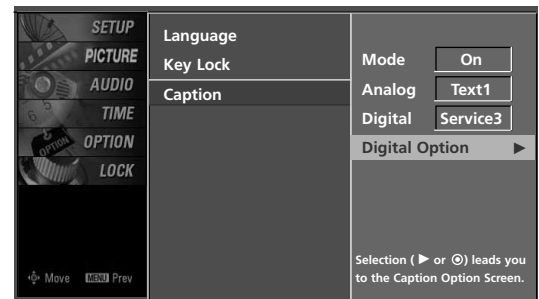

2 3

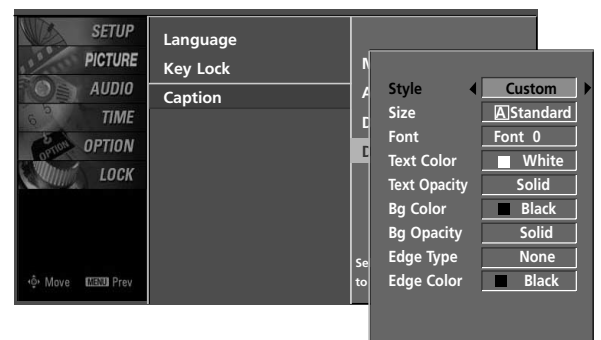

4 5

TIME SETTING

CLOCK SETTING

Auto Clock Setup

The time is set automatically from a digital channel signal. The digital channel signal includes information for the current time provided by the broadcasting station. Set the clock manually if the current time is set incorrectly by the auto clock function.



1 Press the **MENU** button and then use ▲ or ▼ button to select the **TIME** menu.

2 Press the ► button and then use ▲ or ▼ button to select **Clock**.

3 Press the ► button and then use ▲ or ▼ button to select **Auto**.

4 Press the ► button and then use ▲ or ▼ button to select your viewing area time zone: **Eastern, Central, Mountain, Pacific, Alaska** or **Hawaii**.

5 Press the ► button and then use ▲ or ▼ button to select **Auto, Off, On**, depending on whether or not your viewing area observes Daylight Saving time.

6 Press **EXIT** button to return to TV viewing or press **MENU** button to return to the previous menu.

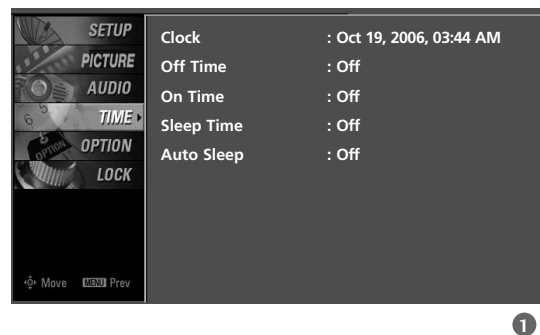

1

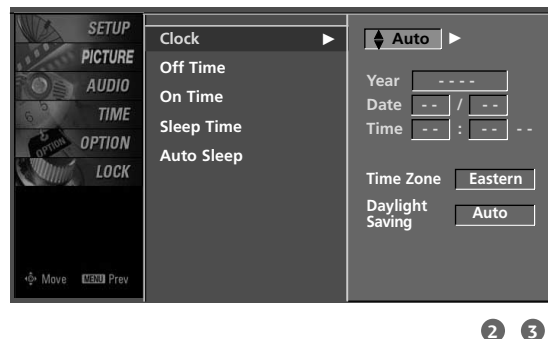

2 3

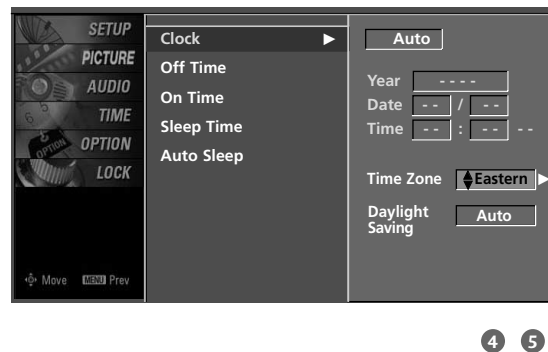

4 5

TIME SETTING

Manual Clock Setup

If the current time setting is wrong, reset the clock manually.



1 Press the **MENU** button and then use ▲ or ▼ button to select the **TIME** menu.

2 Press the ► button and then use ▲ or ▼ button to select **Clock**.

3 Press the ► button and then use ▲ or ▼ button to select **Manual**.

4 Press the ► button and then use ◀ or ▶ button to select either the year, date, or time option. Once selected, use the ▲ or ▼ button to set the year, date, and time options.

5 Press **EXIT** button to return to TV viewing or press **MENU** button to return to the previous menu.



1

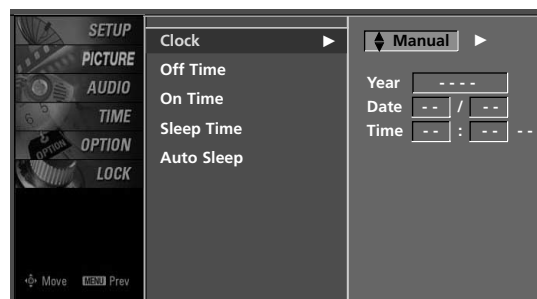

2 3

AUTO ON/OFF TIMER SETTING

The timer function operates only if the current time has been set.

The Off-Timer function overrides the On-Timer function if they are both set to the same time.

The TV must be in standby mode for the On-Timer to work. If you do not press any button within 2 hours after the TV turns on with the On Timer function, the TV will automatically revert to standby mode.



- 1 Press the **MENU** button and then use ▲ or ▼ button to select the **TIME** menu.

- 2 Press the ► button and then use ▲ or ▼ button to select **Off Time** or **On Time**.

- 3 Press the ► button and then use ▲ or ▼ button to select **On**.
 - To cancel the **On/Off time** function, select **Off**.

- 4 Press the ► button and then use ▲ or ▼ button to set the hour.

- 5 Press the ► button and then use ▲ or ▼ button to set the minutes.

- 6 **Only On timer**
Press the ► button and then use ▲ or ▼ button to select the channel at turn-on.

Press the ► button and then use ▲ or ▼ button to set the sound level at turn-on.

- 7 Press **EXIT** button to return to TV viewing or press **MENU** button to return to the previous menu.



1

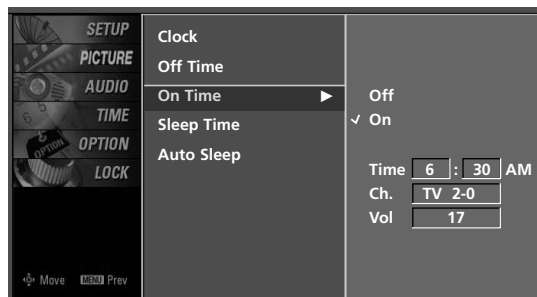

2 3 4 5 6

TIME SETTING

SLEEP TIMER SETTING

The Sleep Timer turns the TV off at the preset time.
Note that this setting is cleared when the TV is turned off.



- 1 Press the **TIMER** button repeatedly to select the number of minutes. First the **Off** option appears on the screen, followed by the following sleep timer options : 10, 20, 30, 60, 90, 120, 180, and 240 minutes.
- 2 When the number of minutes you want is displayed on the screen, press the **ENTER** button. The timer begins to count down from the number of minutes selected.
- 3 To check the remaining minutes before the TV turns off, press the **TIMER** button once.
- 4 To cancel the Sleep Timer, press the **TIMER** button repeatedly to select **Off**.

■ You can also set up the **Sleep Timer** in the **TIME** menu.

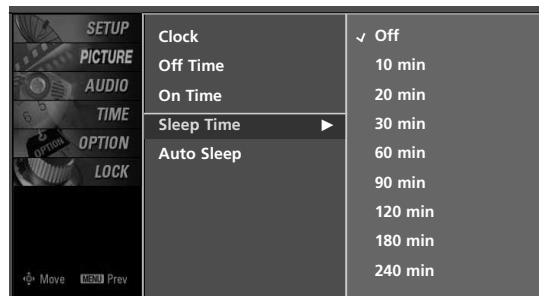

AUTO SHUT-OFF SETTING

If set to on and there is no input signal, the TV turns off automatically after 10 minutes.



1 Press the **MENU** button and then use ▲ or ▼ button to select the **TIME** menu.

2 Press the ► button and then use ▲ or ▼ button to select **Auto Sleep**.

3 Press the ► button and then use ▲ or ▼ button to select **On** or **Off**.

4 Press **EXIT** button to return to TV viewing or press **MENU** button to return to the previous menu.



1

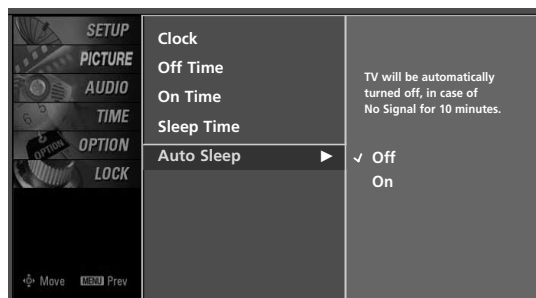

2 3

PARENTAL CONTROL / RATINGS

Parental Control can be used to block specific channels, ratings and other viewing sources.

The Parental Control Function (V-Chip) is used to block program viewing based on the ratings sent by the broadcasting station. The default setting is to allow all programs to be viewed. Viewing can be blocked by choosing the type of the program and the categories. It is also possible to block all program viewing for a time period. To use this function, the following must be done :

1. Set ratings and categories to be blocked.
2. Specify a password
3. Enable the lock

V-Chip rating and categories

Rating guidelines are provided by broadcasting stations. Most television programs and television movies can be blocked by TV Rating and/or Individual Categories. Movies that have been shown at the theaters or direct-to-video movies use the Movie Rating System (MPAA) only.

Ratings for Television programs including made-for-TV movies :

- TV-G (General audience)
- TV-MA (Mature audience only)
- TV-PG (Parental guidance suggested)
- TV-Y (All children)
- TV-14 (Parents strongly cautioned)
- TV-Y7 (Children 7 years older)

SET PASSWORD & LOCK SYSTEM

Setting up Your Password

Set up blocking schemes to block specific channels, ratings, and external viewing sources.

A password is required to gain access to this menu.

- 1 Press the **MENU** button and then use the **▲** or **▼** button to select the **LOCK** menu. Then, press the **▶** button.

- Enter the password as requested.
- The TV is set up with the initial password "0-0-0-0".



Set Password

Change the password by inputting a new password twice.

- 1 After inputting the password, use the ▲ or ▼ button to choose **Set password**.
- 2 Press the ► button and then choose any 4 digits for your new password.
As soon as the 4 digits are entered, re-enter the same 4 digits on the **Confirm**.
Then your changed password has been memorized.
- 3 Press **EXIT** to return to TV viewing or press **MENU** to return to the previous menu.

! NOTE

- ▶ If you ever forget your password, key in '7', '7', '7', '7' on the remote control.

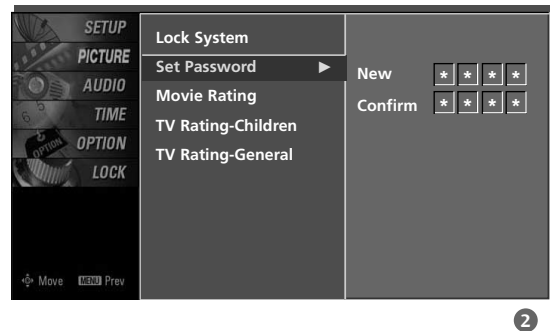
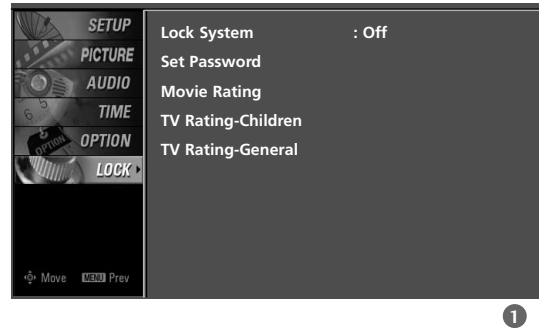

Lock System

Enables or disables the blocking scheme you set up previously.

- 1 After inputting the password, use the ▲ or ▼ button to choose **Lock System**.
- 2 Press the ► button and then use the ▲ or ▼ button to select **On** or **Off**.
 - When you select **On**, the Lock System is enable.
- 3 Press **EXIT** button to return to TV viewing or press **MENU** button to return to the previous menu.

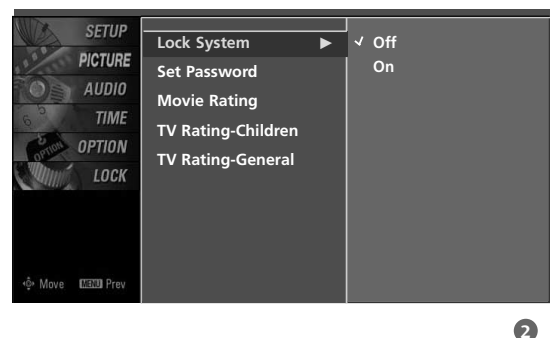
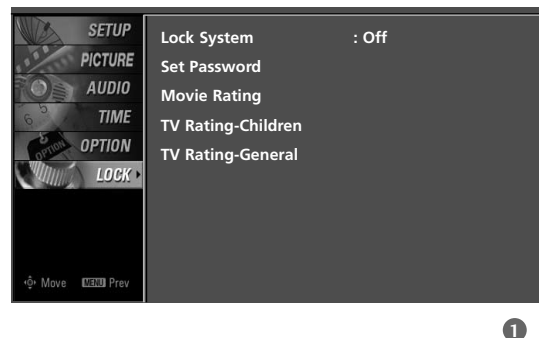

PARENTAL CONTROL / RATINGS

MOVIE & TV RATING

Movie Rating (MPAA)

Blocks movies according to the movie ratings limits specified, so children cannot view certain movies. You can set the ratings limit by blocking out all the movies with the ratings above a specified level. Keep in mind that the movie ratings limit only applies to movies shown on TV, not TV programs, such as soap operas.

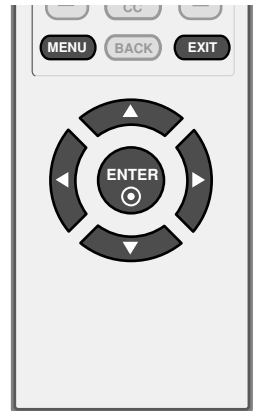

1 After inputting the password, use the ▲ or ▼ button to choose **Movie Rating**.

2 Press the ► button and then use the ▲ or ▼ button to select **G, PG, PG-13, R, NC-17** or **X**.

- G (General audience)
- PG (Parental guidance suggested)
- PG-13 (Parents strongly cautioned)
- R (Restricted)
- NC-17 (No one 17 and under admitted)
- X (Adult only)
- Blocking Off (Permits all programs)

► If you set PG-13 : G and PG movies will be available, PG-13, R, NC-17 and X will be blocked.

3 Press **EXIT** button to return to TV viewing or press **MENU** button to return to the previous menu.

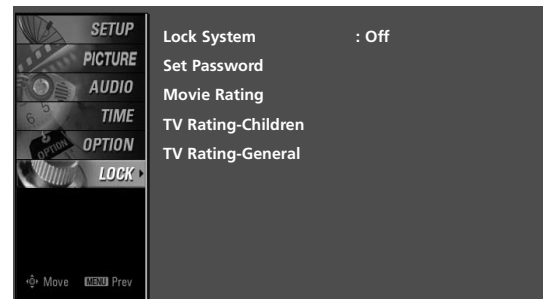

1

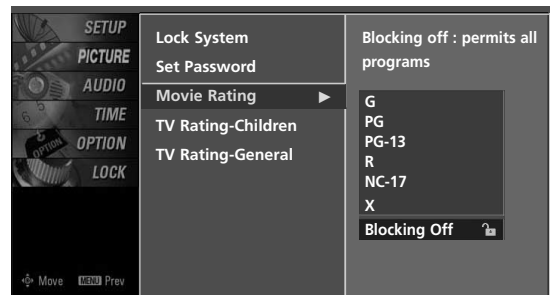

2

TV Rating Children

Prevents children from watching certain children’s TV programs, according to the ratings limit set. The children rating does not apply to other TV programs. Unless you block certain TV programs intended for mature audiences in the TV Rating - sub menu, your children can view those programs.

- 1 After inputting the password, use the ▲ or ▼ button to choose **TV Rating-Children**.
- 2 Press the ► button and then use the ▲ or ▼ button to select **Age**, or **Fantasy Violence**.
Press the ► button and then use the ▲ or ▼ button to select block options.
 - Age(applies to TV-Y, TV-Y7)
 - Fantasy Violence(applies to TV-Y7)

- 3 Press **EXIT** button to return to TV viewing or press **MENU** button to return to the previous menu.

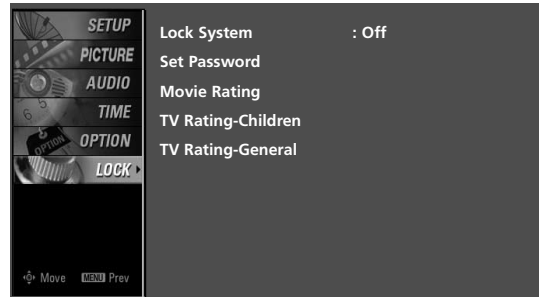

1

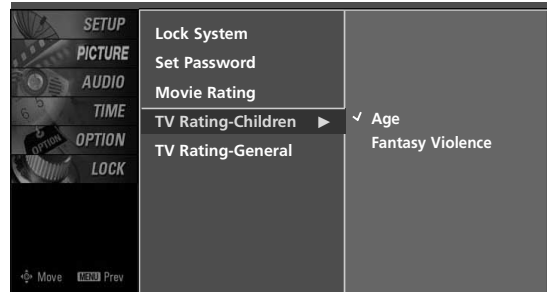

2

TV Rating General

Based on the ratings, blocks certain TV programs that you and your family do not want to view.

- 1 After inputting the password, use the ▲ or ▼ button to choose **TV Rating-General**.
- 2 Press the ► button and then use the ▲ or ▼ button to select **Age**, **Dialogue**, **Language**, **Sex** or **Violence**.
Press the ► button and then use the ▲ or ▼ button to select block options.
 - Age(applies to TV-G,TV-PG,TV-14,TV-MA)
 - Dialogue-sexual dialogue (applies to TV-PG,TV-14)
 - Language-adult language (applies to TV-PG,TV-14,TV-MA)
 - Sex-sexual situations (applies to TV-PG,TV-14,TV-MA)
 - Violence (applies to TV-PG,TV-14,TV-MA)

- 3 Press **EXIT** button to return to TV viewing or press **MENU** button to return to the previous menu.

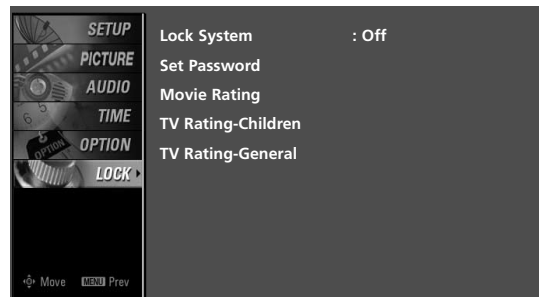

1

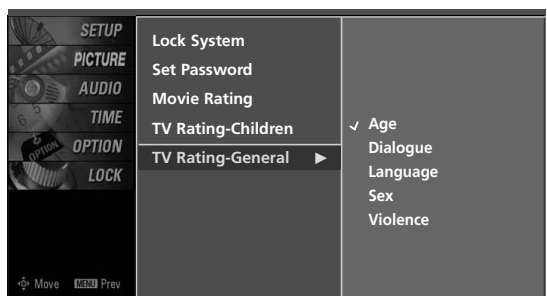

2

APPENDIX

TROUBLESHOOTING

The operation does not work normally.	
The remote control doesn't work	<ul style="list-style-type: none"> Check to see if there is any object between the product and the remote control causing obstruction. Ensure you are pointing the remote control directly at the TV. Ensure that the batteries are installed with correct polarity (+ to +, - to -). Ensure that the correct remote operating mode is set: TV, VCR etc. Install new batteries.
Power is suddenly turned off	<ul style="list-style-type: none"> Is the sleep timer set? Check the power control settings. Power interrupted. No broadcast on station tuned with Auto off activated.

The video function does not work.	
No picture & No sound	<ul style="list-style-type: none"> Check whether the product is turned on. Try another channel. The problem may be with the broadcast. Is the power cord inserted into wall power outlet? Check your antenna direction and/or location. Test the wall power outlet, plug another product's power cord into the outlet where the product's power cord was plugged in.
Picture appears slowly after switching on	<ul style="list-style-type: none"> This is normal, the image is muted during the product startup process. Please contact your service center, if the picture has not appeared after five minutes.
No or poor color or poor picture	<ul style="list-style-type: none"> Adjust Color in menu option. Keep a sufficient distance between the product and the VCR. Try another channel. The problem may be with the broadcast. Are the video cables installed properly? Activate any function to restore the brightness of the picture.
Horizontal/vertical bars or picture shaking	<ul style="list-style-type: none"> Check for local interference such as an electrical appliance or power tool.
Poor reception on some channels	<ul style="list-style-type: none"> Station or cable product experiencing problems, tune to another station. Station signal is weak, reorient antenna to receive weaker station. Check for sources of possible interference.
Lines or streaks in pictures	<ul style="list-style-type: none"> Check antenna (Change the direction of the antenna).

The audio function does not work.

Picture OK & No sound	<ul style="list-style-type: none">■ Press the VOL or VOLUME button.■ Sound muted? Press MUTE button.■ Try another channel. The problem may be with the broadcast.■ Are the audio cables installed properly?
No output from one of the speakers	<ul style="list-style-type: none">■ Adjust Balance in menu option.
Unusual sound from inside the product	<ul style="list-style-type: none">■ A change in ambient humidity or temperature may result in an unusual noise when the product is turned on or off and does not indicate a fault with the product.

There is a problem in PC mode. (Only PC mode applied)

The signal is out of range	<ul style="list-style-type: none">■ Adjust resolution, horizontal frequency, or vertical frequency.■ Check the input source.
Vertical bar or stripe on background & Horizontal Noise & Incorrect position	<ul style="list-style-type: none">■ Work the Auto configure or adjust clock, phase, or H/V position. (Option)
Screen color is unstable or single color	<ul style="list-style-type: none">■ Check the signal cable.■ Reinstall the PC video card.

APPENDIX

MAINTENANCE

Early malfunctions can be prevented. Careful and regular cleaning can extend the amount of time you can enjoy your new TV.

Caution: Be sure to turn the power off and unplug the power cord before you begin any cleaning.

Cleaning the Screen

- 1 Here's a great way to keep the dust off your screen for a while. Wet a soft cloth in a mixture of lukewarm water and a little fabric softener or dish washing detergent. Wring the cloth until it's almost dry, and then use it to wipe the screen.
- 2 Make sure the excess water is off the screen, and then let it air-dry before you turn on your TV.

Cleaning the Cabinet

- To remove dirt or dust, wipe the cabinet with a soft, dry, lint-free cloth.
- Please be sure not to use a wet cloth.

Extended Absence

CAUTION

- ▶ If you expect to leave your TV dormant for a long time (such as a vacation), it's a good idea to unplug the power cord to protect against possible damage from lightning or power surges.

PRODUCT SPECIFICATIONS

■ The specifications shown above may be changed without prior notice for quality improvement.

MODELS		19LS4D (19LS4D-UA)	22LS4D (22LS4D-UA)
Dimensions (Width x Height x Depth)	Including stand	18.0 x 15.6 x 6.8 inches 456.8 x 396.6 x 172.0mm	20.7 x 17.4 x 7.4 inches 525.4 x 441.6 x 187.4 mm
	Excluding stand	18.0 x 14.5 x 2.8 inches 456.8 x 368.5 x 70.5 mm	20.7 x 16.3 x 2.7 inches 525.4 x 413.0 x 68.6 mm
Weight	including stand	11.5 pounds / 5.2 kg	12.8 pounds / 5.8 kg
	excluding stand	10.1 pounds / 4.6 kg	11.5 pounds / 5.2 kg
Power requirement	AC100-240V ~ 50/60Hz		
Television System	NTSC-M, ATSC, 64 & 256 QAM		
Program Coverage	VHF 2-13, UHF 14-69, CATV 1-135, DTV 2-69, CADTV 1-135		
External Antenna Impedance	75 ohm		
Environment condition	Operating Temperature	32 ~ 104°F (0 ~ 40°C)	
	Operating Humidity	Less than 80%	
	Storage Temperature	-4 ~ 140°F (-20 ~ 60°C)	
	Storage Humidity	Less than 85%	

LG Electronics Inc.