

APPENDIX H  
: USER'S MANUAL



# LCD TV OWNER'S MANUAL

## LCD TV MODELS

19LG30  
22LG30

Please read this manual carefully before operating your set.

Retain it for future reference.

Record model number and serial number of the set.

See the label attached on the back cover and quote this information to your dealer when you require service.

ENERGY STAR is a set of power-saving guidelines issued by the U.S. Environmental Protection Agency(EPA).



As an ENERGY STAR Partner LGE U. S. A.,Inc. has determined that this product meets the ENERGY STAR guidelines for energy efficiency.

P/NO : SAC30708022 (0712-REV00)

# WARNING / CAUTION



TO REDUCE THE RISK OF ELECTRIC SHOCK DO NOT REMOVE COVER (OR BACK). NO USER SERVICEABLE PARTS INSIDE. REFER TO QUALIFIED SERVICE PERSONNEL.



The lightning flash with arrowhead symbol, within an equilateral triangle, is intended to alert the user to the presence of uninsulated “dangerous voltage” within the product’s enclosure that may be of sufficient magnitude to constitute a risk of electric shock to persons.



The exclamation point within an equilateral triangle is intended to alert the user to the presence of important operating and maintenance (servicing) instructions in the literature accompanying the appliance.

## WARNING/CAUTION

TO REDUCE THE RISK OF FIRE AND ELECTRIC SHOCK, DO NOT EXPOSE THIS PRODUCT TO RAIN OR MOISTURE.

## NOTE TO CABLE/TV INSTALLER

This reminder is provided to call the CATV system installer’s attention to Article 820-40 of the National Electric Code (U.S.A.). The code provides guidelines for proper grounding and, in particular, specifies that the cable ground shall be connected to the grounding system of the building, as close to the point of the cable entry as practical.

## WARNING / CAUTION

To prevent fire or shock hazards, do not expose this product to rain or moisture.

## FCC NOTICE

### Class B digital device

This equipment has been tested and found to comply with the limits for a Class B digital device, pursuant to Part 15 of the FCC Rules. These limits are designed to provide reasonable protection against harmful interference in a residential installation. This equipment generates, uses and can radiate radio frequency energy and, if not installed and used in accordance with the instructions, may cause harmful interference to radio communications. However, there is no guarantee that interference will not occur in a particular installation. If this equipment does cause harmful interference to radio or television reception, which can be determined by turning the equipment off and on, the user is encouraged to try to correct the interference by one or more of the following measures:

- Reorient or relocate the receiving antenna.
- Increase the separation between the equipment and receiver.
- Connect the equipment to an outlet on a circuit different from that to which the receiver is connected.
- Consult the dealer or an experienced radio/TV technician for help.

**Any changes or modifications not expressly approved by the party responsible for compliance could void the user’s authority to operate the equipment.**

## CAUTION

Do not attempt to modify this product in any way without written authorization from LG Electronics. Unauthorized modification could void the user’s authority to operate this product

# SAFETY INSTRUCTIONS

## IMPORTANT SAFETY INSTRUCTIONS

Important safety instructions shall be provided with each apparatus. This information shall be given in a separate booklet or sheet, or be located before any operating instructions in an instruction for installation for use and supplied with the apparatus.

This information shall be given in a language acceptable to the country where the apparatus is intended to be used. The important safety instructions shall be entitled "Important Safety Instructions". The following safety instructions shall be included where applicable, and, when used, shall be verbatim as follows. Additional safety information may be included by adding statements after the end of the following safety instruction list. At the manufacturer's option, a picture or drawing that illustrates the intent of a specific safety instruction may be placed immediately adjacent to that safety instruction:

**Read these instructions.**

**Keep these instructions.**

**Heed all warnings.**

**Follow all instructions.**



- 1** Do not use this apparatus near water.

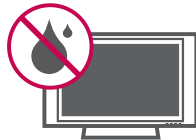

- 2** Clean only with dry cloth.



- 3** Do not block any ventilation openings. Install in accordance with the manufacturer's instructions.



- 4** Do not install near any heat sources such as radiators, heat registers, stoves, or other apparatus (including amplifiers) that produce heat.



- 5** When mounting a TV it on the wall, make sure not to install TV by hanging power and signal cables on the back of the TV.

- 6** Do not defeat the safety purpose of the polarized or grounding-type plug. A polarized plug has two blades with one wider than the other. A grounding type plug has two blades and a third grounding prong. The wide blade or the third prong are provided for your safety. If the provided plug does not fit into your outlet, consult an electrician for replacement of the obsolete outlet.



- 7** Protect the power cord from being walked on or pinched particularly at plugs, convenience receptacles, and the point where they exit from the apparatus.



- 8** Only use attachments/accessories specified by the manufacturer.



- 9** Unplug this apparatus when unused for long periods of time.

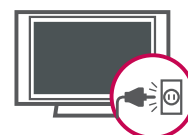

- 10** Use only with the cart, stand, tripod, bracket, or table specified by the manufacturer, or sold with the apparatus. When a cart is used, use caution when moving the cart/apparatus combination to avoid injury from tip-over.



- 11** Never touch this apparatus or antenna during a thunder or lightning storm.

- 12** Do not allow an impact shock or any objects to fall into the product, and do not drop onto the screen with something.

- 13** Refer all servicing to qualified service personnel. Servicing is required when the apparatus has been damaged in any way, such as power-supply cord or plug is damaged, liquid has been spilled or objects have fallen into the apparatus, the apparatus has been exposed to rain or moisture, does not operate normally, or has been dropped.

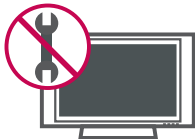

- 14** CAUTION concerning the Power Cord : Most appliances recommend they be placed upon a dedicated circuit; that is, a single outlet circuit which powers only that appliance and has no additional outlets or branch circuits. Check the specification page of this owner's manual to be certain.

Do not overload wall outlets. Overloaded wall outlets, loose or damaged wall outlets, extension cords, frayed power cords, or damaged or cracked wire insulation are dangerous. Any of these conditions could result in electric shock or fire. Periodically examine the cord of your appliance, and if its appearance indicates damage or deterioration, unplug it, discontinue use

of the appliance, and have the cord replaced with an exact replacement part by an authorized servicer. Protect the power cord from physical or mechanical abuse, such as being twisted, kinked, pinched, closed in a door, or walked upon. Pay particular attention to plugs, wall outlets, and the point where the cord exits the appliance.



- 15** Outdoor use marking :  
WARNING - To reduce the risk of fire or electric shock, do not expose this appliance to rain or moisture.



- 16** Wet Location Marking : Apparatus shall not be exposed to dripping or splashing and no objects filled with liquids, such as vases, shall be placed on or over apparatus.



## **17** GROUNDING

Ensure that you connect the earth ground wire to prevent possible electric shock. If grounding methods are not possible, have a qualified electrician install a separate circuit breaker.

Do not try to ground the unit by connecting it to telephone wires, lightning rods, or gas pipes.

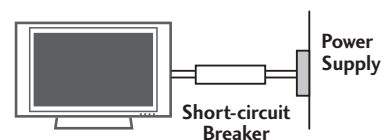

- 18** DISCONNECTING DEVICE FROM MAINS  
Mains plug is the disconnecting device. The plug must remain readily operable.

# CONTENTS

<b>WARNING / CAUTION</b> .....	1
--------------------------------	---

<b>SAFETY INSTRUCTIONS</b> .....	2
----------------------------------	---

## PREPARATION

Accessories .....	7
Front Panel Information .....	8
Back Panel Information .....	9
Stand Installation .....	10
Back Cover for Wire Arrangement .....	11
VESA Wall Mounting .....	12
Desktop Pedestal Installation .....	12
Positioning your Display .....	13
Kensington Security System .....	14
Antenna or Cable Connection .....	15

## EXTERNAL EQUIPMENT SETUP

HD Receiver Setup .....	16
DVD Setup .....	18
VCR Setup .....	21
Headphone Setup .....	23
PC Setup .....	24

## WATCHING TV / CHANNEL CONTROL

Remote Control Functions .....	30
Turning On TV .....	32
Channel Selection .....	32
Volume Adjustment .....	32
Quick Menu .....	33
Initial Setting .....	34
On-Screen Menus Selection .....	36
Channel Setup	
- Auto Scan (Auto Tuning) .....	37
- Add / Delete Channel (Manual Tuning) .....	38
- Channel Editing .....	39
Input List .....	40
Input Label .....	41
AV Mode .....	42

## PICTURE CONTROL

Picture Size (Aspect Ratio) Control .....	43
Preset Picture Settings	
- Picture Mode - Preset .....	44
- Color Tone - Preset .....	45
Manual Picture Adjustment	
- Picture Mode - User Mode .....	46
- Color Tone - User Mode .....	47
Picture Improvement Technology .....	48
Advanced - Black (Darkness) Level .....	49
Advanced - Film Mode .....	50
Picture Reset .....	51

## SOUND & LANGUAGE CONTROL

Clear Voice .....	52
Preset Sound Setting (Sound Mode) .....	53
Sound Setting Adjustment - User Mode .....	54
Balance .....	55
Audio Reset .....	56
Stereo/SAP Broadcasts Setup .....	57
Audio Language .....	58
On-Screen Menus Language Selection .....	59
Caption Mode	
- Analog Broadcasting System Captions .....	60
- Digital Broadcasting System Captions .....	61
- Caption Option .....	62

## TIME SETTING

Clock Setting	
- Auto Clock Setup .....	63
- Manual Clock Setup .....	64
Auto On/Off Timer Setting .....	65
Sleep Timer Setting .....	66
Auto Shut-off Setting .....	67

## PARENTAL CONTROL / RATINGS

Set Password & Lock System .....	68
Channel Blocking .....	71
Movie & TV Rating .....	72
Downloadable Rating .....	77
External Input Blocking .....	78
Key lock .....	79

## APPENDIX

Troubleshooting .....	80
Maintenance .....	82
Product Specifications .....	83
External Control Through RS-232C .....	84

- 
- If the TV feels cold to the touch, there may be a small “flicker” when it is turned on. This is normal, there is nothing wrong with TV.
  - Some minute dot defects may be visible on the screen, appearing as tiny red, green, or blue spots. However, they have no adverse effect on the monitor’s performance.
  - Avoid touching the LCD screen or holding your finger(s) against it for long periods of time. Doing so may produce some temporary distortion effects on the screen.

**On Disposal**

- a. The fluorescent lamp used in this product contains a small amount of mercury.
- b. Do not dispose of this product with general household waste.
- c. Disposal of this product must be carried out in accordance to the regulations of your local authority.



# PREPARATION

## ACCESSORIES

Ensure that the following accessories are included with your product. If an accessory is missing, please contact the dealer where you purchased the product.

User must use shielded signal interface cables (D-sub 15 pin cable) with ferrite cores to maintain standard compliance for the product.

The accessories can be different from the figures shown here.

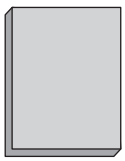

Owner's Manual



CD Manual

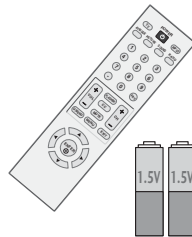

Remote Control,  
Batteries



Power Cord



75ohm Round Cable

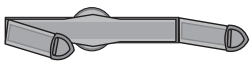

Cable Management Clip

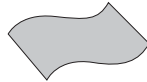

Polishing Cloth

\* Slightly wipe stained spot on the exterior only with the polishing cloth for the product exterior if there is stain or fingerprint on surface of the exterior.

\* Do not wipe roughly when removing stain. Please be cautious of that excessive pressure may cause scratch or discoloration.

### Option Extras

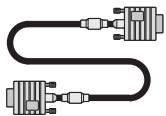

D-sub 15 pin Cable

# PREPARATION

## FRONT PANEL INFORMATION

- Image shown may differ from your TV
- **NOTE:** If your product has a protection tape attached, remove the tape. And then wipe the product with a cloth (If a polishing cloth is included with your product, use it).

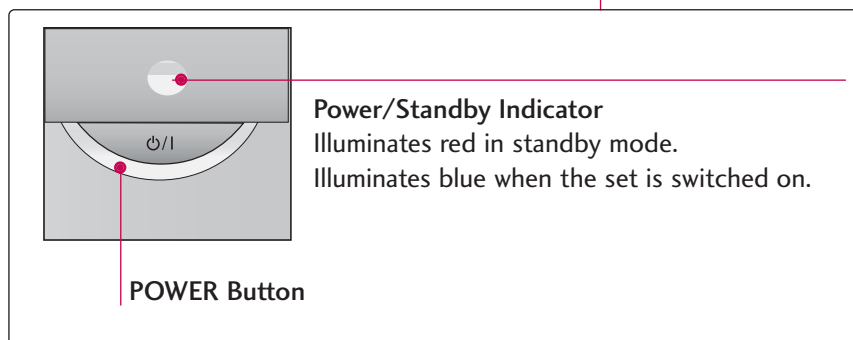
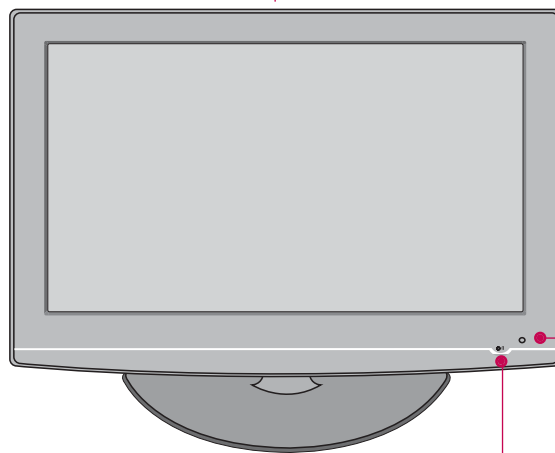
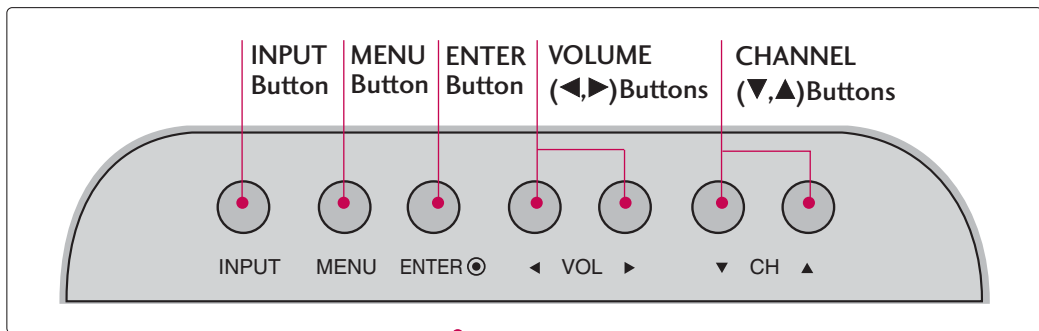

## BACK PANEL INFORMATION

■ Image shown may differ from your TV

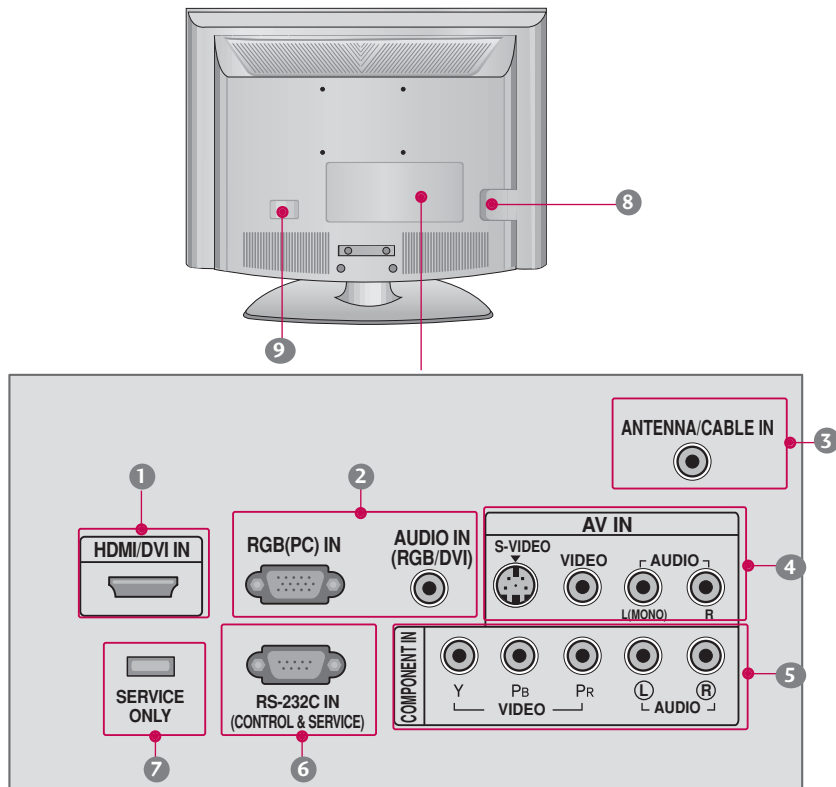

### 1 HDMI/DVI IN

Connect a HDMI signal to this jack.  
Or DVI (Video) signal to this jack with a HDMI to DVI cable.

### 2 RGB (PC) IN

Connect the output from a PC.

### AUDIO (RGB/DVI) IN

Connect the audio from a PC.

### 3 ANTENNA/CABLE IN

Connect over-the air signals to this jack.  
Connect cable signals to this jack.

### 4 AV IN (Audio/Video)

Connect audio/video output from an external device to these jacks.

#### S-VIDEO

Connect S-Video out from an S-VIDEO device.

### 5 COMPONENT IN

Connect a component video/audio device to these jacks.

### 6 RS-232C IN (CONTROL & SERVICE) PORT

Connect to the RS-232C port on a PC.

### 7 SERVICE ONLY

For service.

### 8 HEADPHONE INPUT

Plug the headphone into the headphone socket.

### 9 Power Cord Socket

For operation with AC power.

Caution: Never attempt to operate the TV on DC power.

# PREPARATION

## STAND INSTALLATION

▪ Image shown may differ from your TV

- 1 Carefully place the TV screen side down on a cushioned surface to protect the screen from damage.

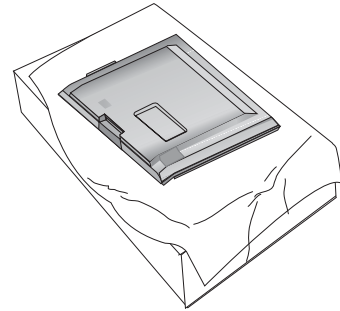

- 2 Assemble the TV as shown.

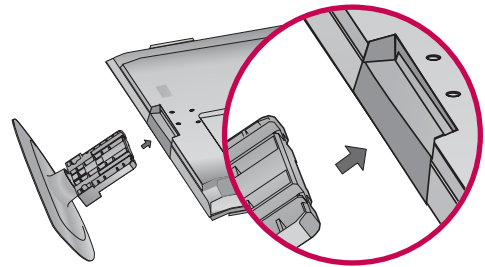

- 3 Fix the 4 bolts securely using the holes in the back of the TV

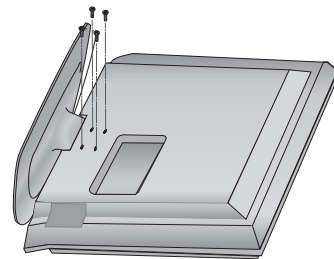

## BACK COVER FOR WIRE ARRANGEMENT

■ Image shown may differ from your TV

- 1 Connect the cables as necessary.  
To connect an additional equipment, see the **EXTERNAL EQUIPMENT SETUP** section.

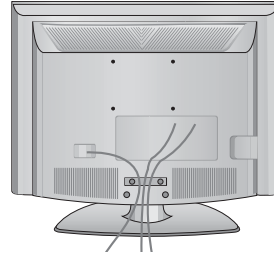

- 2 Install the **CABLE MANAGEMENT CLIP** as shown and manage the cable.

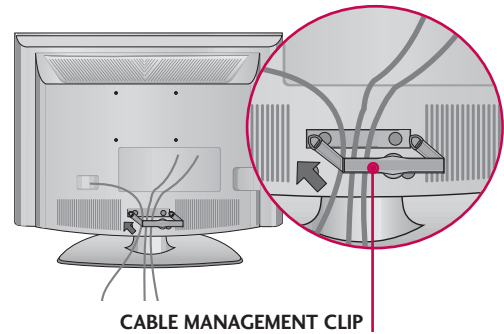

- 3 Fit the **CABLE MANAGEMENT CLIP** as shown.

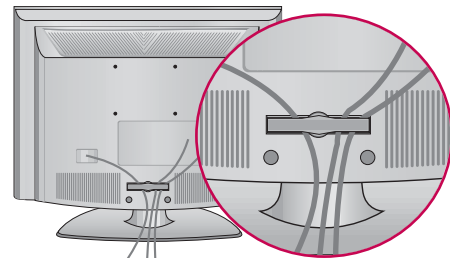

# PREPARATION

## VESA WALL MOUNTING

This product accepts a VESA-compliant mounting interface pad. (optional)  
There 4 threaded holes are available for attaching the bracket.

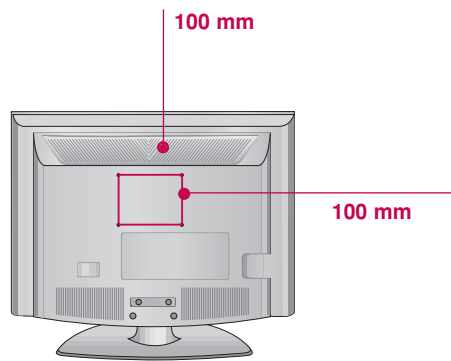

### ! NOTE

- ▶ Screw length needed depends on the wall mount used. For further information, refer to the VESA Wall Mounting Instruction Guide.

## DESKTOP PEDESTAL INSTALLATION

For proper ventilation, allow a clearance of 4 inches on all four sides from the wall.

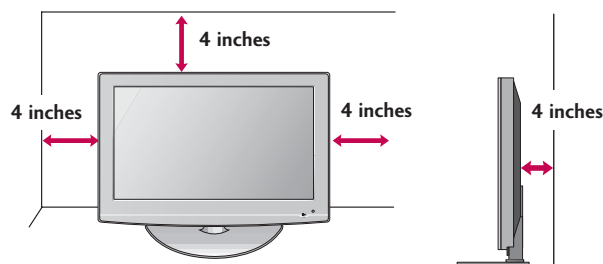

### ! CAUTION

- ▶ Ensure adequate ventilation by following the clearance recommendations.

## POSITIONING YOUR DISPLAY

- Here shown may be somewhat different from your TV.
  - Adjust the position of the panel in various ways for maximum comfort.
- Tilt range

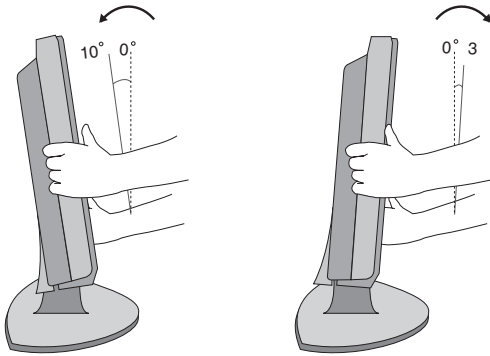

# PREPARATION

## KENSINGTON SECURITY SYSTEM

PREPARATION

- The TV is equipped with a Kensington Security System connector on the back panel. Connect the Kensington Security System cable as shown below.
- For the detailed installation and use of the Kensington Security System, refer to the user's guide provided with the Kensington Security System.

For further information, contact <http://www.kensington.com>, the internet homepage of the Kensington company. Kensington sells security systems for expensive electronic equipment such as notebook PCs and LCD projectors.

### NOTE

- The Kensington Security System is an optional accessory.

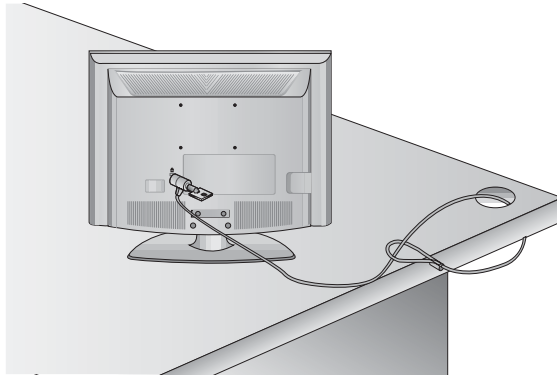



# ANTENNA OR CABLE CONNECTION

■ Image shown may differ from your TV.

## 1. Antenna (Analog or Digital)

Wall Antenna Socket or Outdoor Antenna without a Cable Box Connections.

For optimum picture quality, adjust antenna direction if needed.

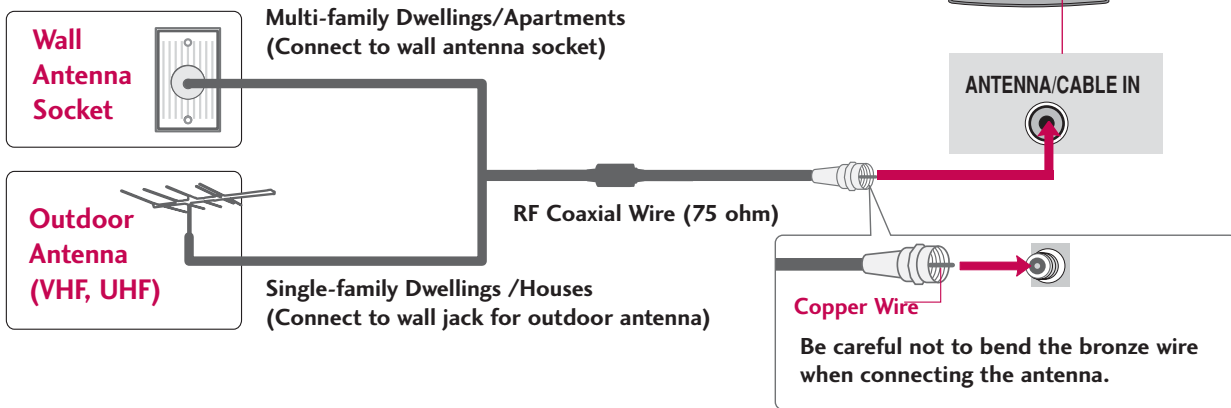
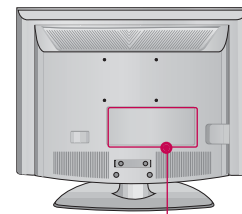

## 2. Cable

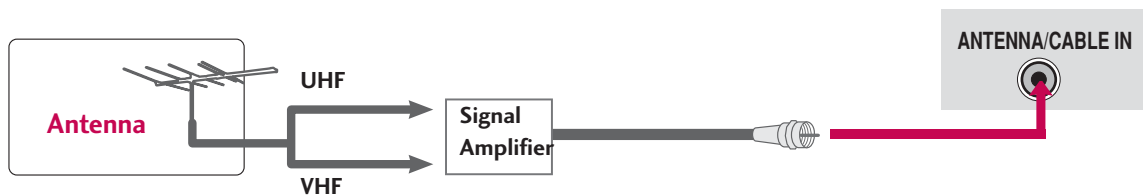
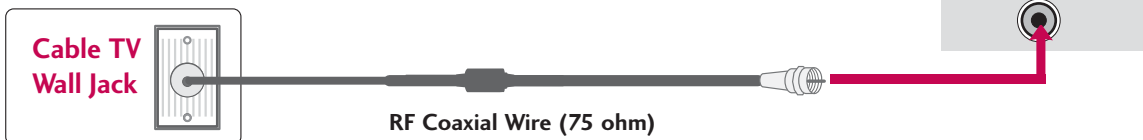

- To improve the picture quality in a poor signal area, please purchase a signal amplifier and install properly.
- If the antenna needs to be split for two TV's, install a 2-Way Signal Splitter.
- If the antenna is not installed properly, contact your dealer for assistance.

**NOTE** ▶ The TV will let you know when the analog, cable, and digital channel scans are complete.

# EXTERNAL EQUIPMENT SETUP

- To prevent the equipment damage, never plug in any power cords until you have finished connecting all equipment.

## HD RECEIVER SETUP

This TV can receive Digital Over-the-air/Cable signals without an external digital set-top box. However, if you do receive digital signals from a digital set-top box or other digital external device, refer to the figure as shown below.

### When connecting Component cable

#### 1. How to connect

- 1 Connect the video outputs (Y, PB, PR) of the digital set top box to the **COMPONENT IN VIDEO** jacks on the set. Match the jack colors (Y = green, PB = blue, and PR = red).
- 2 Connect the audio output of the digital set-top box to the **COMPONENT IN AUDIO** jacks on the set.

#### 2. How to use

- Turn on the digital set-top box.  
(Refer to the owner's manual for the digital set-top box operation)
- Select **Component** input source by using the **INPUT** button on the remote control.

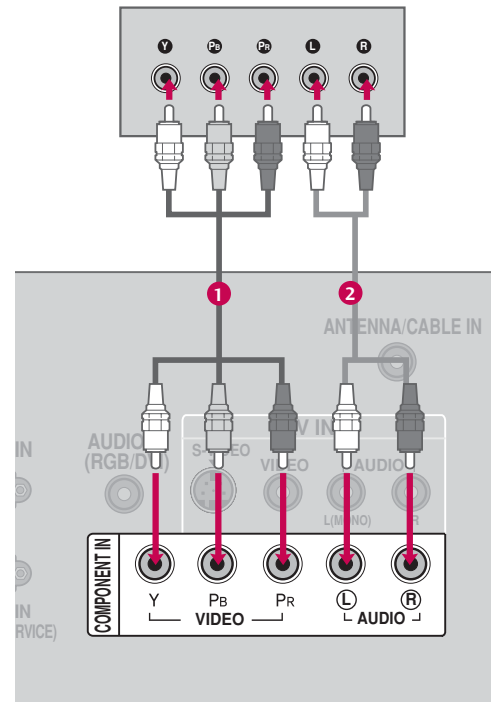

Signal	Component	HDMI
480i	Yes	No
480p	Yes	Yes
720p	Yes	Yes
1080i	Yes	Yes
1080p	Yes	Yes

Y, CB/PB, CR/PR

Resolution	Horizontal Frequency(KHz)	Vertical Frequency(Hz)
720x480i	15.73	59.94
	15.73	60.00
720x480p	31.47	59.94
	31.50	60.00
1280x720p	44.96	59.94
	45.00	60.00
1920x1080i	33.72	59.94
	33.75	60.00
1920x1080p	27.00	24.00
	33.75	30.00
	67.43	59.94
	67.50	60.00

## When connecting HDMI cable

### 1. How to connect

- 1 Connect the digital set-top box to **HDMI/DVI IN** jack on the set.
- 2 No separated audio connection is necessary. HDMI supports both audio and video.

### 2. How to use

- Turn on the digital set-top box.  
(Refer to the owner's manual for the digital set-top box.)
- Select **HDMI** input source with using the **INPUT** button on the remote control.

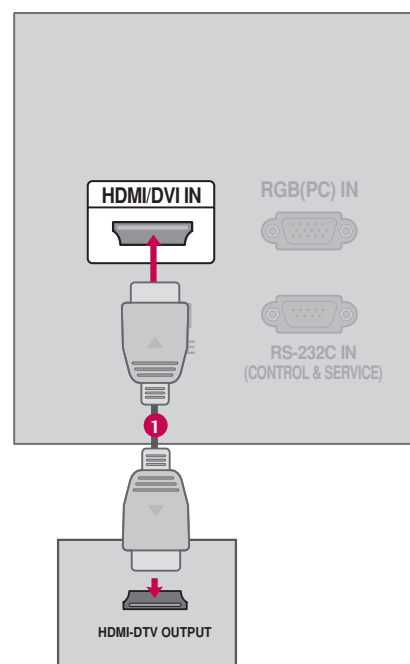

#### HDMI-DTV

Resolution	Horizontal Frequency(KHz)	Vertical Frequency(Hz)
720x480p	31.47	59.94
	31.50	60.00
1280x720p	44.96	59.94
	45.00	60.00
1920x1080i	33.72	59.94
	33.75	60.00
1920x1080p	27.00	24.00
	33.75	30.00
	67.43	59.94
	67.50	60.00

# EXTERNAL EQUIPMENT SETUP

## When connecting HDMI to DVI cable

### 1. How to connect

- 1 Connect the DVI output of the digital set-top box to the **HDMI/DVI IN** jack on the set.
- 2 Connect the audio output of the digital set-top box to the **AUDIO IN (RGB/DVI)** jack on the set.

### 2. How to use

- Turn on the digital set-top box. (Refer to the owner's manual for the digital set-top box.)
- Select **HDMI** input source with using the **INPUT** button on the remote control.

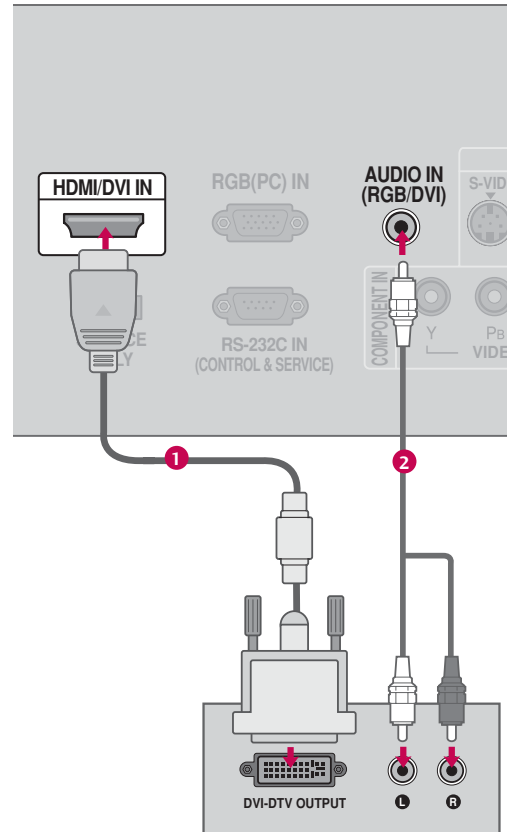

# DVD SETUP

## When connecting Component cable

### 1. How to connect

- 1 Connect the video outputs (Y, PB, PR) of the DVD to the **COMPONENT IN VIDEO** jacks on the set. Match the jack colors (Y = green, PB = blue, and PR = red).
- 2 Connect the audio outputs of the DVD to the **COMPONENT IN AUDIO** jacks on the set.

### 2. How to use

- Turn on the DVD player, insert a DVD.
- Select **Component** input source by using the **INPUT** button on the remote control.
- Refer to the DVD player's manual for operating instructions.

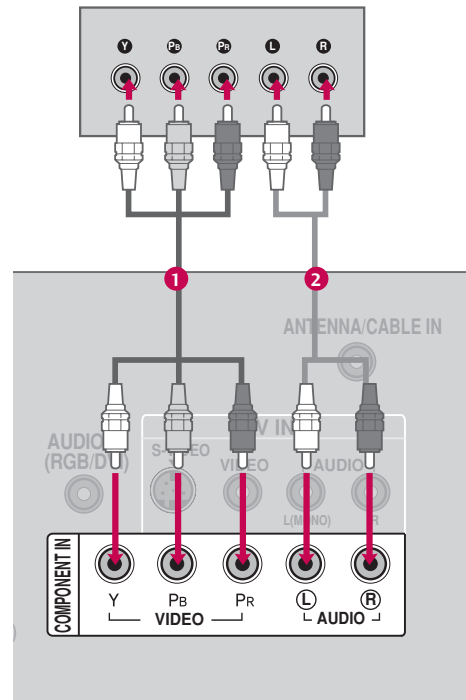

### Component Input ports

To get better picture quality, connect a DVD player to the component input ports as shown below.

Component ports on the TV	Y	P <sub>B</sub>	P <sub>R</sub>
Video output ports on DVD player	Y	P <sub>B</sub>	P <sub>R</sub>
	Y	B-Y	R-Y
	Y	C <sub>b</sub>	C <sub>r</sub>
	Y	P <sub>b</sub>	P <sub>r</sub>

# EXTERNAL EQUIPMENT SETUP

## When connecting with an S-Video cable

### 1. How to connect

- 1 Connect the S-VIDEO output of the DVD to the S-VIDEO input on the set.
- 2 Connect the audio outputs of the DVD to the AUDIO input jacks on the set.

### 2. How to use

- Turn on the DVD player, insert a DVD.
- Select **AV** input source by using the **INPUT** button on the remote control.
- Refer to the DVD player's manual for operating instructions.

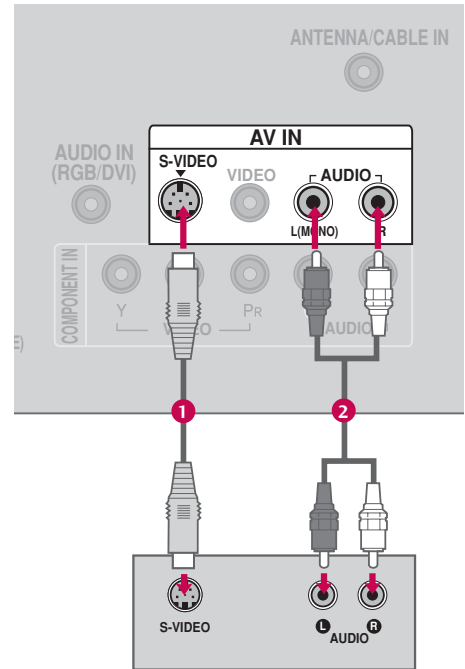

## When connecting HDMI cable

### 1. How to connect

- 1 Connect the HDMI output of the DVD to the HDMI/DVI IN jack on the set.
- 2 No separated audio connection is necessary. HDMI supports both audio and video.

### 2. How to use

- Select **HDMI** input source by using the **INPUT** button on the remote control.
- Refer to the DVD player's manual for operating instructions.

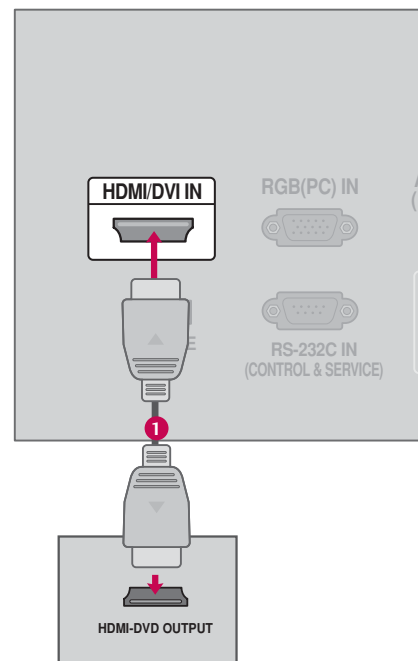

## VCR SETUP

- To avoid picture noise (interference), leave an adequate distance between the VCR and TV.
- Use the ISM feature in the Option menu to avoid having a fixed image remain on the screen for a long period of time (Only Plasma TV model). If the 4:3 picture format is used; the fixed images on the sides of the screen may remain visible on the screen. This phenomenon is common to all manufactures and in consequence the manufactures warranty does not cover the product bearing this phenomenon.

### When connecting with an antenna

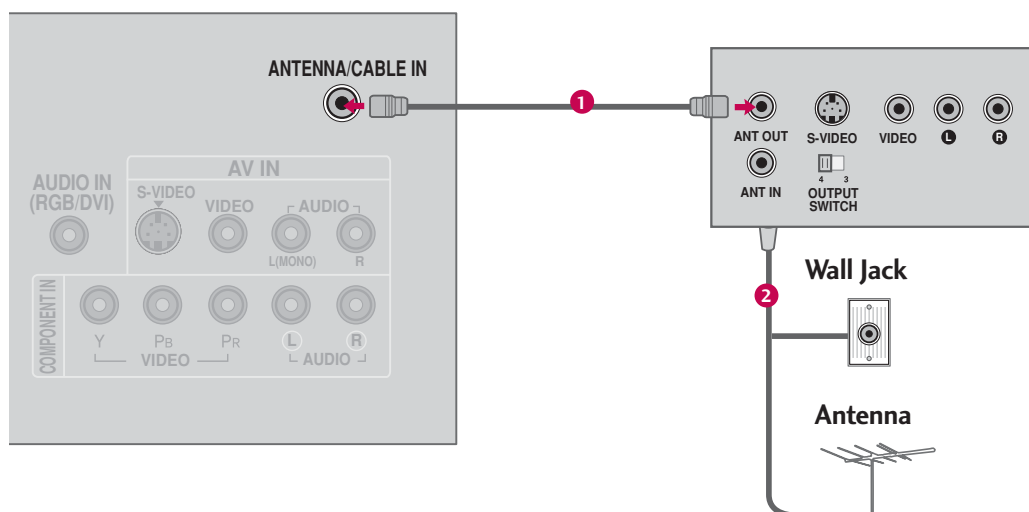

### 1. How to connect

- 1 Connect the RF antenna out socket of the VCR to the **ANTENNA/CABLE IN** socket on the set.
- 2 Connect the antenna cable to the RF antenna in socket of the VCR.

### 2. How to use

- Set VCR output switch to 3 or 4 and then tune TV to the same channel number.
- Insert a video tape into the VCR and press PLAY on the VCR. (Refer to the VCR owner's manual.)

# EXTERNAL EQUIPMENT SETUP

## When connecting with a RCA cable

### 1. How to connect

- 1 Connect the **AUDIO/VIDEO** jacks between TV and VCR. Match the jack colors (Video = yellow, Audio Left = white, and Audio Right = red)

### 2. How to use

- Insert a video tape into the VCR and press PLAY on the VCR. (Refer to the VCR owner's manual.)
- Select **AV** input source by using the **INPUT** button on the remote control.

**NOTE** ▶ If you have a mono VCR, connect the audio cable from the VCR to the **AUDIO L/MONO** jack of the set.

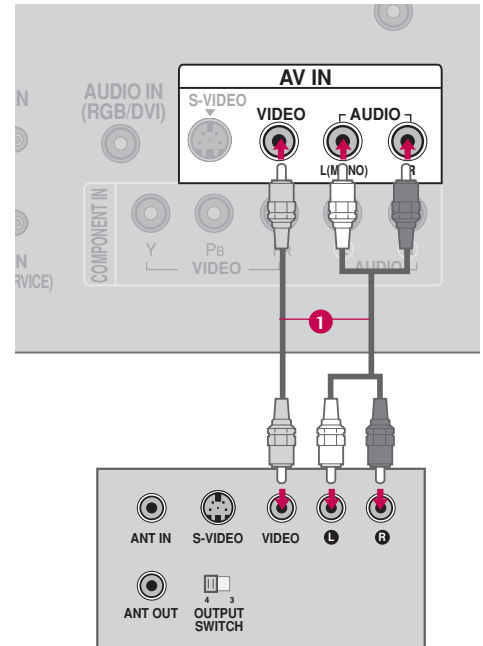

## When connecting with an S-Video cable

### 1. How to connect

- 1 Connect the S-VIDEO output of the VCR to the S-VIDEO input on the set.
- 2 Connect the audio outputs of the VCR to the **AUDIO** input jacks on the set.

### 2. How to use

- Insert a video tape into the VCR and press PLAY on the VCR. (Refer to the VCR owner's manual.)
- Select **AV** input source by using the **INPUT** button on the remote control.

**NOTE**  
▶ The picture quality is improved: compared to normal composite (RCA cable) input.

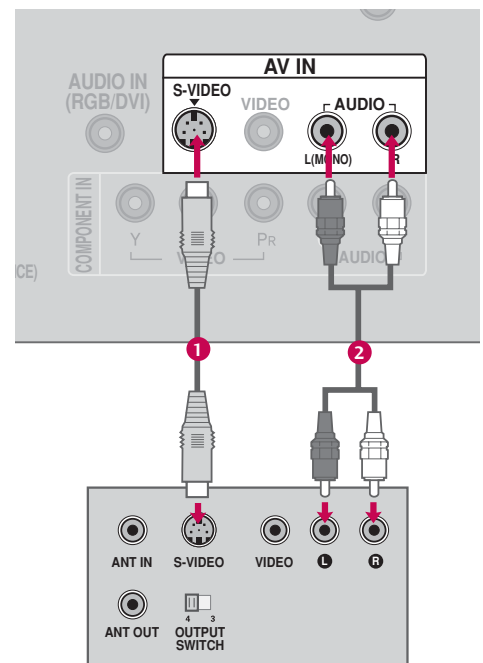

### CAUTION

- ▶ Do not connect to both Video and S-Video at the same time. In the event that you connect both Video and the S-Video cables, only the S-Video will work.



# HEADPHONE SETUP

You can listen to the sound through the headphone.

## 1. How to connect

---

- 1 Plug the headphone into the headphone socket.
  - 2 To adjust the headphone volume, press the **VOL +** or **-** button. If you press the **MUTE** button, the sound from the headphone is switched off.
- 

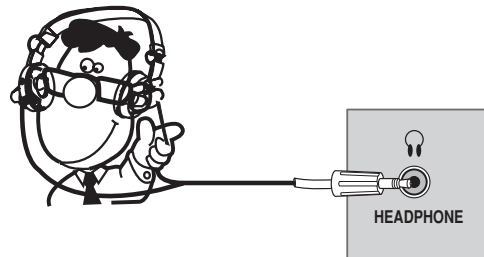

# EXTERNAL EQUIPMENT SETUP

## PC SETUP

This TV provides Plug and Play capability, meaning that the PC adjusts automatically to the TV's settings.

### When connecting D-sub 15 pin cable

#### 1. How to connect

- 1 Connect the RGB output of the PC to the **RGB (PC) IN** jack on the set.
- 2 Connect the PC audio output to the **AUDIO IN (RGB/DVI)** jack on the set.

#### 2. How to use

- Turn on the PC and the TV.
- Select **RGB-PC** input source by using the **INPUT** button on the remote control.

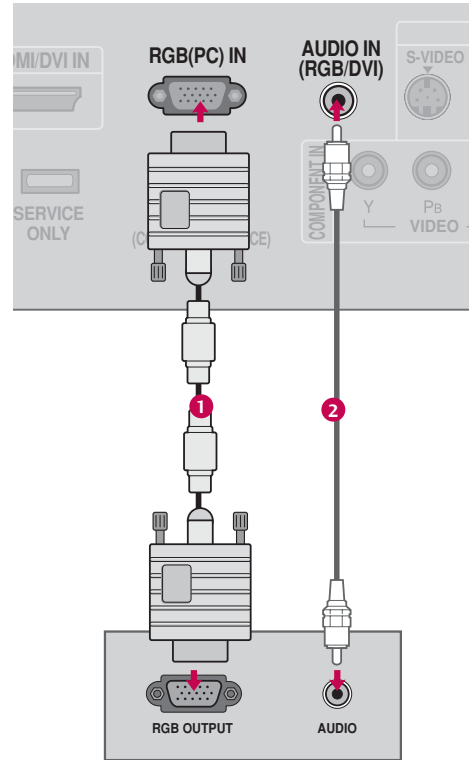

### When connecting HDMI to DVI cable

#### 1. How to connect

- 1 Connect the DVI output of the PC to the **HDMI/DVI IN** jack on the set.
- 2 Connect the PC audio output to the **AUDIO IN (RGB/DVI)** jack on the set.

#### 2. How to use

- Turn on the PC and the TV.
- Select **HDMI** input source by using the **INPUT** button on the remote control.

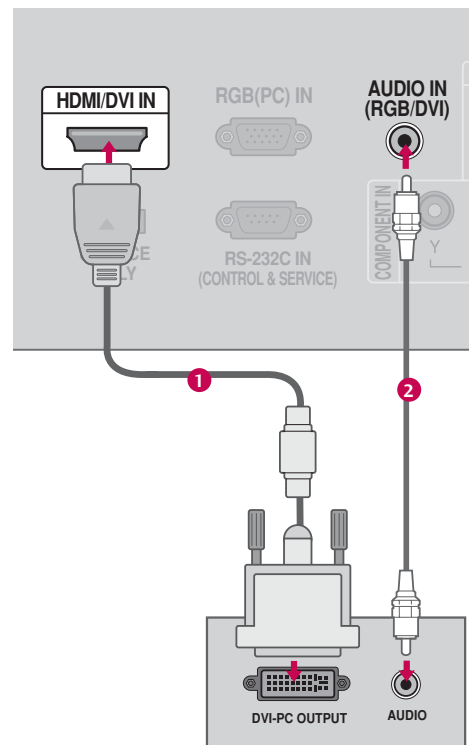

## ! NOTES

- ▶ To get the the best picture quality, adjust the PC graphics card to 1440x900 (19LG30), 1680x1050 (22LG30).
- ▶ Depending on the graphics card, DOS mode may not work if a HDMI to DVI Cable is in use.
- ▶ If the video doesn't fit the screen, try pressing the ADJUST button to adjust the screen position of TV.
- ▶ Check the image on your TV. There may be noise associated with the resolution, vertical pattern, contrast or brightness in PC mode. If noise is present, change the PC output to another resolution, change the refresh rate to another rate or adjust the brightness and contrast on the PICTURE menu until the picture is clear. If the refresh rate of the PC graphic card can not be changed, change the PC graphic card or consult the manufacturer of the PC graphic card.
- ▶ Avoid keeping a fixed image on the screen for a long period of time. The fixed image may become permanently imprinted on the screen.
- ▶ The synchronization input form for Horizontal and Vertical frequencies is separate.

## Supported Display Specifications

### RGB-PC, HDMI/DVI-PC mode

Resolution	Horizontal Frequency(KHz)	Vertical Frequency(Hz)
640x350	31.469	70.08
720x400	31.469	70.08
640x480	31.469	59.94
800x600	37.879	60.31
1024x768	48.363	60.00
1280x768	47.776	59.87
1360x768 RGB-PC	47.712	60.01
1360x768 HDMI-PC	47.720	59.799
1366x768	47.13	59.65
1440x900	55.5	59.90
1400x1050 (22 inches only)	64.744	59.948
1680x1050 (22 inches only)	65.290	59.954

\* RGB-PC mode only

# EXTERNAL EQUIPMENT SETUP







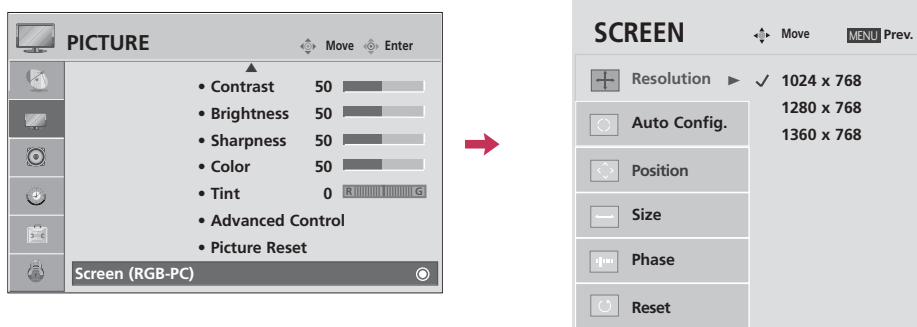

## Screen Setup for PC mode

### Selecting Resolution

When you change the resolution, select the proper resolution in present input to see the best picture appearance. XGA (1024, 1280, 1360) isn't distinguished because of having the same H/V Sync Time. This function is you to select the Default Sync Time.

This feature operates only in RGB-PC mode.



-   Select **PICTURE**.
-   Select **SCREEN (RGB-PC)**.
-   Select **Resolution**.
-   Select the desired resolution.
-  Return to the previous menu.







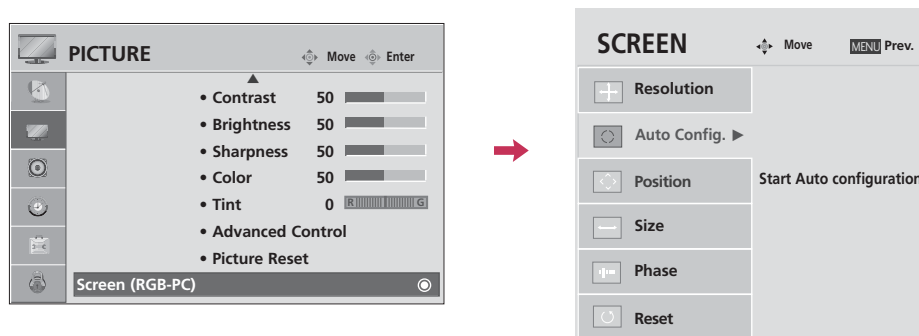

## Auto Configure

Automatically adjusts picture position and minimizes image instability. After adjustment, if the image is still not correct, your TV is functioning properly but needs further adjustment.

### Auto configure

This function is for automatic adjustment of the screen position, clock, and phase. The displayed image will be unstable for a few seconds while the auto configuration is in progress.



- 1   Select **PICTURE**.
- 2   Select **SCREEN (RGB-PC)**.
- 3   Select **Auto Config..**
- 4   Select **Yes**.
- 5  Start Auto Configuration.

- If the position of the image is still not correct, try Auto adjustment again.
- If picture needs to be adjusted again after Auto adjustment in RGB-PC, you can adjust the **Position**, **Size** or **Phase**.

# PREPARATION





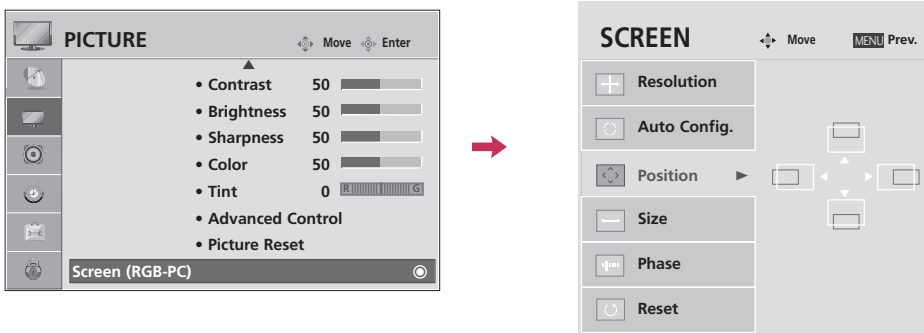

PREPARATION

## Adjustment for screen Position, Size, and Phase

If the picture is not clear after auto adjustment and especially if characters are still trembling, adjust the picture phase manually.

This feature operates only in RGB-PC mode.

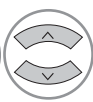

-   Select **PICTURE**.
-   Select **SCREEN (RGB-PC)**.
-   Select **Position, Size, or Phase**.
-   Make appropriate adjustments.

- **Position:** This function is to adjust picture to left/right and up/down as you prefer.
- **Size:** This function is to minimize any vertical bars or stripes visible on the screen background. And the horizontal screen size will also change. The **Size** adjustment range is **-50 ~ +50**.
- **Phase:** This function allows you to remove any horizontal noise and clear or sharpen the image of characters. The **Phase** adjustment range is **-32 ~ +32**.

## Screen Reset (Reset to original factory values)

Returns to the default settings Resolution, Auto Config., Position, Size and Phase at the factory.

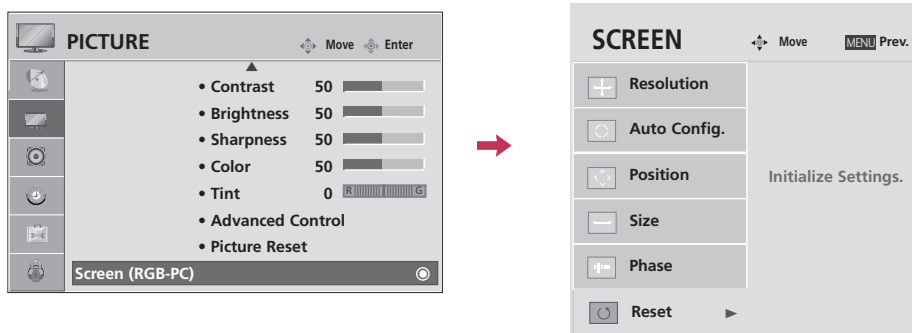

1   Select **PICTURE**.

2   Select **SCREEN**.

3   Select **Reset**.

4   Select **Yes**.

5 

# WATCHING TV / CHANNEL CONTROL

## REMOTE CONTROL FUNCTIONS

When using the remote control, aim it at the remote control sensor on the TV.

**AV MODE** It helps you select and set images and sounds when connecting AV devices. ▶ p.42

**PICTURE** Selects the factory preset picture depend on the viewing environment. ▶ p.44

**SOUND** Selects the factory preset sound for type of program. ▶ p.53

**RATIO** Change the aspect ratio.▶ p.43

**VOLUME UP /DOWN** Increase/decrease the sound level.

**FLASHBK** Tune to the last channel viewed.

**CC** Select a closed caption. ▶ p.60

**MUTE** Switch the sound on or off. ▶ p.32

**CHANNEL UP/DOWN** Select available channels.

**Q.MENU** Select the desired quick menu source. ▶ p.33

**MENU** Displays the main menu.

**EXIT** Clear all on-screen displays and return to TV viewing from any menu.

**THUMBSTICK** (Up/Down/Left Right/ENTER) Navigate the on-screen menus and adjust the system settings to your preference.

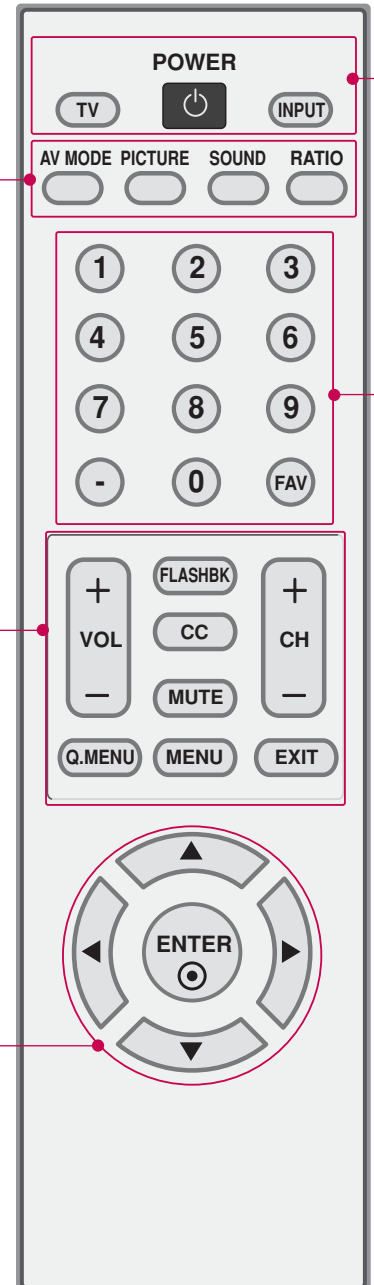



**POWER** Turns your TV on or off.

**TV** In AV, Component, RGB-PC, and HDMI input sources, screen returns to the last TV channel.

**INPUT** External input modes rotate in regular sequence

#### NUMBER button

**— (DASH)** Used to enter a program number for multiple program channels such as 2-1, 2-2, etc.

**FAV** Scroll through the programmed Favorite channels. ► **p.33**

## Installing Batteries

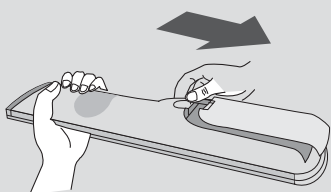

- Open the battery compartment cover on the back side and install the batteries matching correct polarity (+ with +, - with -).
- Install two 1.5V AAA batteries. Don't mix old or used batteries with new ones.
- Close cover.

# WATCHING TV / CHANNEL CONTROL

## TURNING ON TV

- 1** First, connect power cord correctly.  
At this moment, the TV switches to standby mode.
  - In standby mode to turn TV on, press the  $\phi/|$ , **INPUT**, **CH** ( $\blacktriangle$  or  $\blacktriangledown$ ) button on the TV or press the **POWER**, **INPUT**, **TV**, **CH** (+ or -), **Number (0~9)** button on the remote control.
- 2** Select the viewing source by using the **INPUT** button on the remote control.
  - This TV is programmed to remember which power state it was last set to, even if the power cord is out.
- 3** When finished using the TV, press the **POWER** button on the remote control. The TV reverts to standby mode.

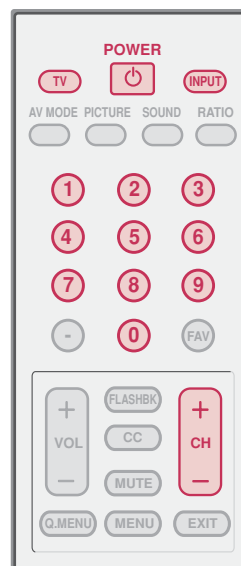

### ! NOTE

- ▶ If you intend to be away on vacation, disconnect the power plug from the wall power outlet.

## CHANNEL SELECTION

- 1** Press the **CH** (+ or -) or **NUMBER** buttons to select a channel number.

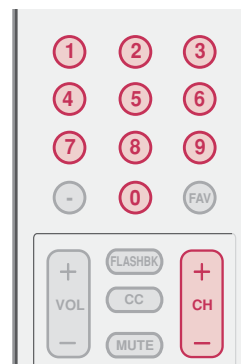

## VOLUME ADJUSTMENT

Adjust the volume to suit your personal preference.

- 1** Press the **VOL** (+ or -) button to adjust the volume.
- 2** If you want to switch the sound off, press the **MUTE** button.
- 3** You can cancel the Mute function by pressing the **MUTE** or **VOL** (+ or -) button.



## QUICK MENU

Your TV's OSD (On Screen Display) may differ slightly from what is shown in this manual. Q.Menu (Quick Menu) is a menu of features which users might use frequently.

- **Aspect Ratio:** Selects your desired picture format.
- **Brightness:** Adjusts screen brightness.
- **Clear Voice:** By differentiating the human sound range from others, it helps users listen to human voices better.
- **Picture Mode:** Selects the factory preset picture depend on the viewing environment.
- **Sound Mode:** Selects the factory preset sound for type of program.
- **Caption:** Select a closed caption.
- **Multi Audio:** Selects MTS sound.
- **Sleep Time:** Select the amount of time before your TV turns off automatically.
- **Del/Add/Fav:** Select channel you want to add or delete or add the channel to the Favorite List.



1   Display each menu.

2  Make appropriate adjustments.

3  Return to TV viewing

# WATCHING TV / CHANNEL CONTROL

## INITIAL SETTING

This OSD (On Screen Display) is displayed automatically on the screen as figure after turning on the TV and you can adjust the Location, Time, Language, Auto tuning.

### Step1. Mode setting

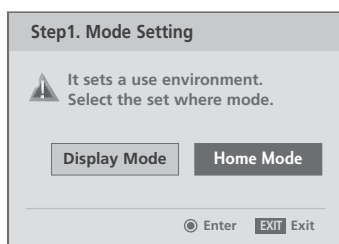

1 Select **Display Mode** or **Home Mode**.



- **Display Mode:** It maintains the 'Picture mode' optimized for the shop environment. It maintains the picture mode as 'Vivid' at a specific interval.  
It's not available to use Low Power.
- **Home Mode:** You can adjust the 'picture mode' to use.

### Step2. Time setting

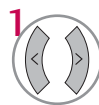
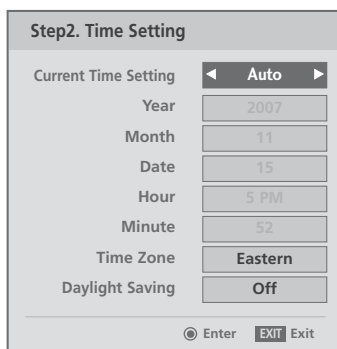

1 Select **Auto** or **Manual**.



2 Select desired time option.



## Step3. Option setting

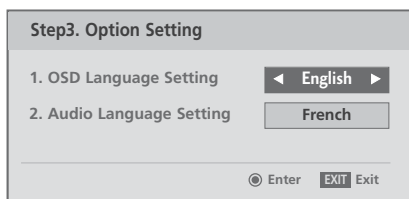

1 Select **OSD Language Setting** or **Audio Language Setting**.

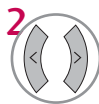

2 Select your desired language.



## Step4. Auto Tuning

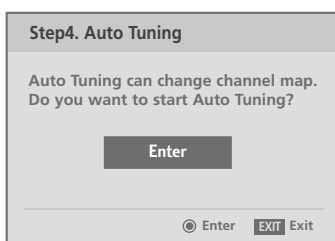

1 Start **Auto Tuning**.

### ! NOTE

- You can also adjust **Initial Setting** in the **OPTION** menu.

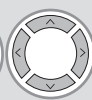

1 Select **OPTION**.

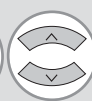

2 Select **Initial Setting**.







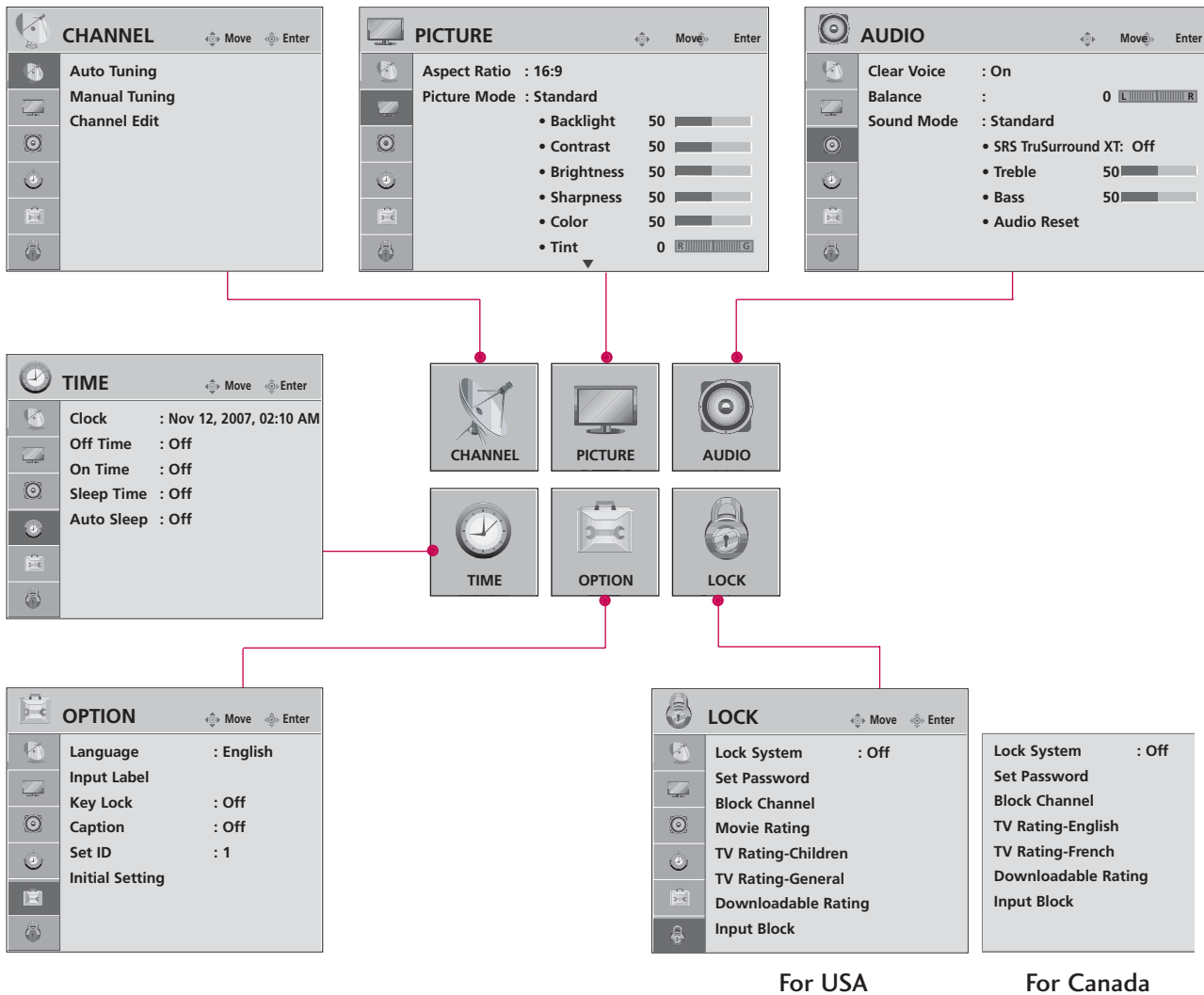

# WATCHING TV /CHANNEL CONTROL

## ON-SCREEN MENUS SELECTION

Your TV's OSD (On Screen Display) may differ slightly from that shown in this manual.

WATCHING TV / CHANNEL CONTROL

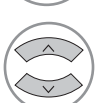

- 1   Display each menu.
- 2   Select a menu item.
- 3  Enter to the pop up menu.
- 4  Return to TV viewing







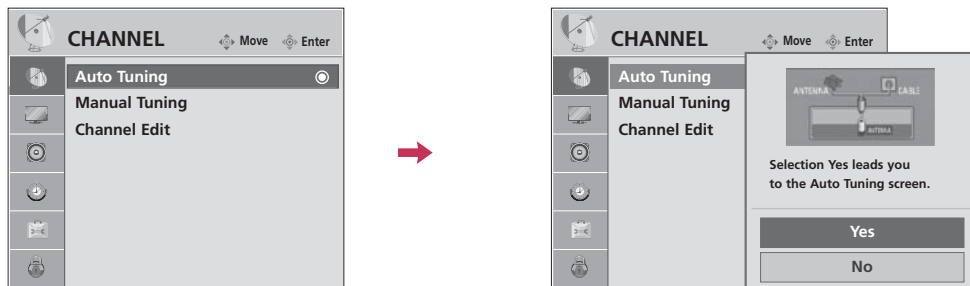

## CHANNEL SETUP

### Auto Scan (Auto Tuning)

Automatically finds all channels available through antenna or cable inputs, and stores them in memory on the channel list.

Run Auto Tuning again after any Antenna/Cable connection changes.



- 1   Select **CHANNEL**.
- 2   Select **Auto Tuning**.
- 3   Select **Yes**.
- 4  Run **Auto tuning**.
- 5  Return to the previous menu.
-  Return to TV viewing

- A password is required to gain access to Auto Tuning menu if the Lock System is turned on.

# PICTURE CONTROL

## PICTURE SIZE (ASPECT RATIO) CONTROL

This feature lets you choose the way an analog picture with a 4:3 aspect ratio is displayed on your TV. When you receive an analog picture with a 4:3 aspect ratio on your 16:9 TV, you need to specify how the picture is to be displayed.

- RGB-PC input source use 4:3 or 16:9 aspect ratio.

### ! NOTE

- ▶ If a fixed image is displayed on the screen for a long time, the image may become imprinted on the screen and remain visible. This phenomenon is common to all manufactures and in consequence the manufactures warranty does not cover the product bearing this phenomenon.



Select the desired picture format.

### Set by program

Selects the proper picture proportion to match the source's image.

(4:3 → 4:3)

(16:9 → 16:9)



### 4:3

Choose 4:3 when you want to view a picture with an original 4:3 aspect ratio.

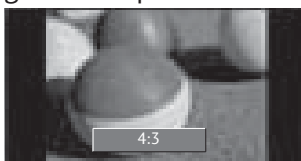

### 16:9

Adjust the picture horizontally, in a linear proportion to fill the entire screen.

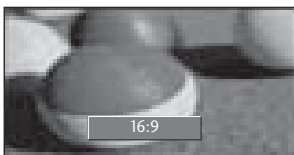

### Zoom 1

Choose Zoom 1 when you want to view the picture without any alteration. However, the top and bottom portions of the picture will be cropped.

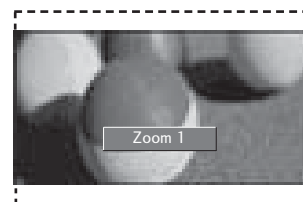

### Zoom 2

Choose Zoom 2 when you want the picture to be altered, both vertically extended and cropped. The picture taking a halfway trade off between alteration and screen coverage.

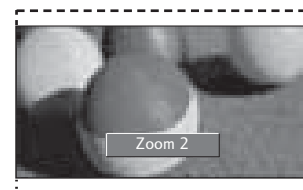

### Just Scan

Following selection will lead to you view the picture of best quality without loss of original picture in high resolution image.

Notes: If there are noise in original picture, you can see the noise at the edge.

**Just Scan** operates only in DTV/CADTV (720p/1080i/1080p), HDMI-DTV, DVI-DTV input source.

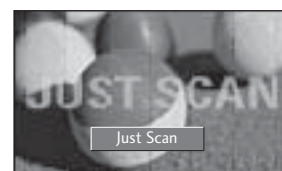



# APPENDIX

## TROUBLESHOOTING

### The operation does not work normally.

The remote control doesn't work	<ul style="list-style-type: none"> <li>■ Check to see if there is any object between the product and the remote control causing obstruction. Ensure you are pointing the remote control directly at the TV.</li> <li>■ Ensure that the batteries are installed with correct polarity (+ to +, - to -).</li> <li>■ Ensure that the correct remote operating mode is set: TV, VCR etc.</li> <li>■ Install new batteries.</li> </ul>
Power is suddenly turned off	<ul style="list-style-type: none"> <li>■ Is the sleep timer set?</li> <li>■ Check the power control settings. Power interrupted.</li> <li>■ No broadcast on station tuned with Auto off activated.</li> </ul>

### The video function does not work.

No picture & No sound	<ul style="list-style-type: none"> <li>■ Check whether the product is turned on.</li> <li>■ Try another channel. The problem may be with the broadcast.</li> <li>■ Is the power cord inserted into wall power outlet?</li> <li>■ Check your antenna direction and/or location.</li> <li>■ Test the wall power outlet, plug another product's power cord into the outlet where the product's power cord was plugged in.</li> </ul>
Picture appears slowly after switching on	<ul style="list-style-type: none"> <li>■ This is normal, the image is muted during the product startup process. Please contact your service center, if the picture has not appeared after five minutes.</li> </ul>
No or poor color or poor picture	<ul style="list-style-type: none"> <li>■ Adjust Color in menu option.</li> <li>■ Keep a sufficient distance between the product and the VCR.</li> <li>■ Try another channel. The problem may be with the broadcast.</li> <li>■ Are the video cables installed properly?</li> <li>■ Activate any function to restore the brightness of the picture.</li> </ul>
Horizontal/vertical bars or picture shaking	<ul style="list-style-type: none"> <li>■ Check for local interference such as an electrical appliance or power tool.</li> </ul>
Poor reception on some channels	<ul style="list-style-type: none"> <li>■ Station or cable product experiencing problems, tune to another station.</li> <li>■ Station signal is weak, reorient antenna to receive weaker station.</li> <li>■ Check for sources of possible interference.</li> </ul>
Lines or streaks in pictures	<ul style="list-style-type: none"> <li>■ Check antenna (Change the direction of the antenna).</li> </ul>

### The audio function does not work.

Picture OK & No sound	<ul style="list-style-type: none"><li>■ Press the VOL or VOLUME button.</li><li>■ Sound muted? Press MUTE button.</li><li>■ Try another channel. The problem may be with the broadcast.</li><li>■ Are the audio cables installed properly?</li></ul>
No output from one of the speakers	<ul style="list-style-type: none"><li>■ Adjust Balance in menu option.</li></ul>
Unusual sound from inside the product	<ul style="list-style-type: none"><li>■ A change in ambient humidity or temperature may result in an unusual noise when the product is turned on or off and does not indicate a fault with the product.</li></ul>

### There is a problem in PC mode. (Only PC mode applied)

The signal is out of range	<ul style="list-style-type: none"><li>■ Adjust resolution, horizontal frequency, or vertical frequency.</li><li>■ Check the input source.</li></ul>
Vertical bar or stripe on background & Horizontal Noise & Incorrect position	<ul style="list-style-type: none"><li>■ Work the Auto configure or adjust clock, phase, or H/V position. (Option)</li></ul>
Screen color is unstable or single color	<ul style="list-style-type: none"><li>■ Check the signal cable.</li><li>■ Reinstall the PC video card.</li></ul>

# MAINTENANCE

Early malfunctions can be prevented. Careful and regular cleaning can extend the amount of time you can enjoy your new TV.

**Caution:** Be sure to turn the power off and unplug the power cord before you begin any cleaning.

## Cleaning the Screen

- 1 Here's a great way to keep the dust off your screen for a while. Wet a soft cloth in a mixture of lukewarm water and a little fabric softener or dish washing detergent. Wring the cloth until it's almost dry, and then use it to wipe the screen.
- 2 Make sure the excess water is off the screen, and then let it air-dry before you turn on your TV.

## Cleaning the Cabinet

- To remove dirt or dust, wipe the cabinet with a soft, dry, lint-free cloth.
- Please be sure not to use a wet cloth.

## Extended Absence

### CAUTION

- ▶ If you expect to leave your TV dormant for a long time (such as a vacation), it's a good idea to unplug the power cord to protect against possible damage from lightning or power surges.

## PRODUCT SPECIFICATIONS

MODELS		19LG30 (19LG30-UA)	22LG30 (22LG30-UA)
Dimensions (Width x Height x Depth)	Including stand	18.1 x 15.4 x 7.4 inches 458.8 x 391.0 x 189.2 mm	20.6 x 17.0 x 7.4 inches 522.2 x 432.4 x 189.2 mm
	Excluding stand	18.1 x 13.6 x 2.7 inches 458.8 x 344.5 x 69.0 mm	20.6 x 15.1 x 2.7 inches 522.2 x 383.3 x 69.0 mm
Weight	including stand	11.5 pounds / 5.2 kg	12.8 pounds / 5.8 kg
	excluding stand	10.1 pounds / 4.6 kg	11.5 pounds / 5.2 kg
Power requirement	AC100-240V ~ 50/60Hz		
Television System	NTSC-M, ATSC, 64 & 256 QAM		
Program Coverage	VHF 2-13, UHF 14-69, CATV 1-135, DTV 2-69, CADTV 1-135		
External Antenna Impedance	75 ohm		
Environment condition	Operating Temperature	32 ~ 104°F (0 ~ 40°C)	
	Operating Humidity	Less than 80%	
	Storage Temperature	-4 ~ 140°F (-20 ~ 60°C)	
	Storage Humidity	Less than 85%	

- The specifications shown above may be changed without prior notice for quality improvement.

## EXTERNAL CONTROL THROUGH RS-232C

The RS-232C port allows you connect the RS-232C input jack to an external control device (such as a computer or an A/V control system) to control the TV's functions externally.

- **Note:** RS-232C on this unit is intended to be used with third party RS-232C control hardware and software. The instructions below are provided to help with programming software or to test functionality using telenet software.

### RS-232C Setup

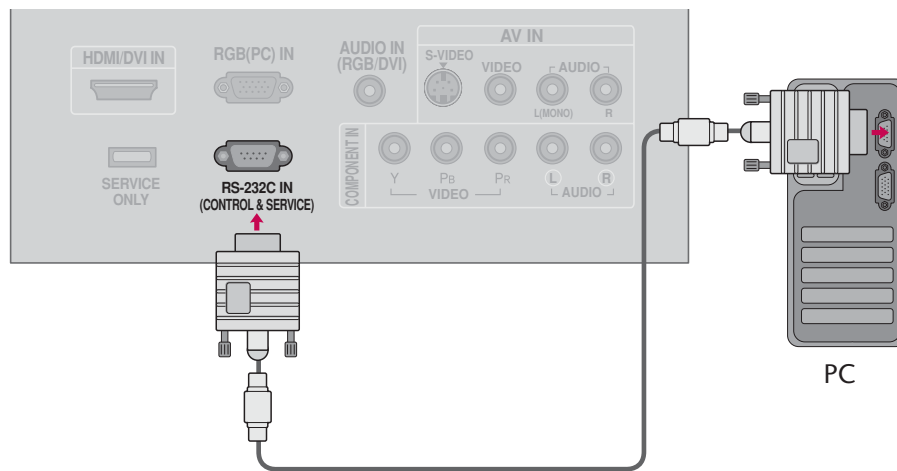

### Type of Connector; D-Sub 9-Pin Male

No.	Pin Name
1	No connection
2	RXD (Receive data)
3	TXD (Transmit data)
4	DTR (DTE side ready)
5	GND
6	DSR (DCE side ready)
7	RTS (Ready to send)
8	CTS (Clear to send)
9	No Connection

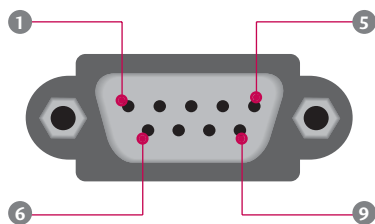

### Communication Parameters

- Baud rate : 9600 bps (UART)
- Data length : 8 bits
- Parity : None
- Stop bit : 1 bit
- Communication code : ASCII code
- Use a crossed (reverse) cable.

#### ! NOTE

- ▶ This product has command echo back in the RS-232C Command.

## RS-232C Configurations



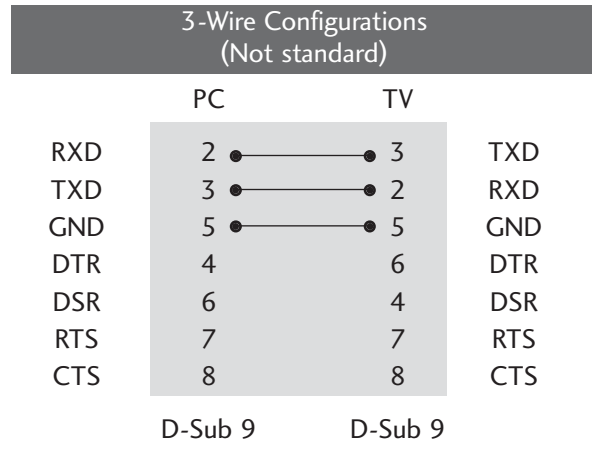
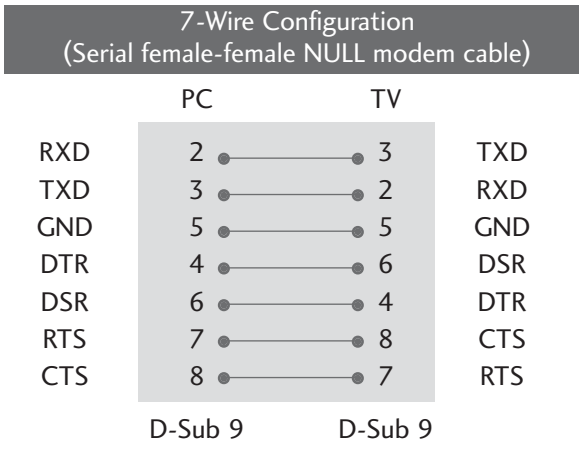



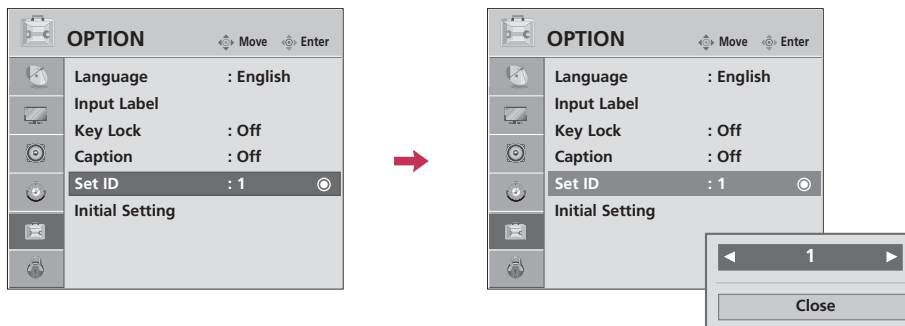

Either cable below can be used.



## Set ID

Use this function to specify a TV ID number.  
Refer to 'Real Data Mapping1'. ▶ p.87.



- 1   Select **OPTION**.
- 2   Select **Set ID**.
- 3   Choose the desired TV ID number.  
The adjustment range of Set ID is 1 ~ 99.
- 4  Return to the previous menu.
-  Return to TV viewing

# APPENDIX

## Command Reference List

	COMMAND1	COMMAND2	DATA (Hexadecimal)		COMMAND1	COMMAND2	DATA (Hexadecimal)
01. Power	k	a	0 ~ 1	10. Tint	k	j	0 ~ 64
02. Input Select	k	b	(▶ p.87)	11. Sharpness	k	k	0 ~ 64
03. Aspect Ratio	k	c	(▶ p.87)	12. OSD Select	k	l	0 ~ 1
04. Screen Mute	k	d	0 ~ 1	13. Remote Control Lock Mode	k	m	0 ~ 1
05. Volume Mute	k	e	0 ~ 1	14. Treble	k	r	0 ~ 64
06. Volume Control	k	f	0 ~ 64	15. Bass	k	s	0 ~ 64
07. Contrast	k	g	0 ~ 64	16. Balance	k	t	0 ~ 64
08. Brightness	k	h	0 ~ 64	17. Color Temperature	k	u	0 ~ 3
09. Color	k	i	0 ~ 64				

	COMMAND1	COMMAND2	DATA0 (Hexadecimal)	DATA1 (Hexadecimal)	DATA2 (Hexadecimal)	DATA3 (Hexadecimal)	DATA4 (Hexadecimal)	DATA5 (Hexadecimal)
18. Channel Tuning	m	a	physical program high	major program low	major low	minor high	minor low	attribute
19. Channel Add/Del	m	b	0 ~ 1					
20. Key	m	c	(▶ p.89)					
21. Input Select	x	b	(▶ p.89)					

## Transmission / Receiving Protocol

### Transmission

**[Command1][Command2][ ][Set ID][ ][Data][Cr]**

[Command 1] : First command to control the set.(j, k, m or x)

[Command 2] : Second command to control the set.

[Set ID] : You can adjust the set ID to choose desired TV ID number in Setup menu. Adjustment range is 1 ~ 99. When selecting Set ID '0', every connected the TV is controlled. Set ID is indicated as decimal (1 ~ 99) on menu and as Hexa decimal (0x0~0x63) on transmission /receiving protocol.

[DATA] : To transmit the command data.

Transmit the 'FF' data to read status of command.

[Cr] : Carriage Return

ASCII code '0x0D'

[ ] : ASCII code 'space (0x20)'

\* In this model, TV will not send the status during the standby mode.

### OK Acknowledgement

**[Command2][ ][Set ID][ ][OK][Data][x]**

The TV transmits ACK (acknowledgement) based on this format when receiving normal data. At this time, if the data is data read mode, it indicates present status data. If the data is data write mode, it returns the data of the PC computer.

\* In this model, TV will not send the status during the standby mode.

\* Data Format

[Command 2] : Use as command.

[Set ID] : Use the small character, if set ID is 10, it will send the '0', 'a'.

[DATA] : Use the small character, if data is 0 x ab, it will send the 'a', 'b'.

[OK] : Use the large character.

### Error Acknowledgement

**[Command2][ ][Set ID][ ][NG][Data][x]**

The TV transmits ACK (acknowledgement) based on this format when receiving abnormal data from non-viable functions or communication errors.

Data1: Illegal Code

Data2: Not supported function

Data3: Wait more time

\* In this model, TV will not send the status during the standby mode.

\* Data Format

[Command 2] : Use as command.

[Set ID] : Use the small character, if set ID is 10, it will send the '0', 'a'.

[DATA] : Use the small character, if data is 0 x ab, it will send the 'a', 'b'.

[NG] : Use the large character

**01. Power (Command: k a)**

To control Power On/Off of the TV.

**Transmission** [k][a][ ][Set ID][ ][Data][Cr]

Data 0 : Power Off      Data 1 : Power On

**Acknowledgement** [a][ ][Set ID][ ][OK/NG][Data][x]

\* In a like manner, if other functions transmit 'FF' data based on this format, Acknowledgement data feedback presents status about each function.

\* In this model, TV will send the Acknowledge after power on processing completion.

\* There might be a time delay between command and acknowledgement.

**02. Input Select (Command: k b) (Main Picture Input)**

To select input source for the TV.

**Transmission** [k][b][ ][Set ID][ ][Data][Cr]

Data 0: DTV                      Data 4: Component

Data 1: Analog                 Data 7: RGB-PC

Data 2: AV                      Data 8: HDMI

**Acknowledgement** [b][ ][Set ID][ ][OK/NG][Data][x]

**03. Aspect Ratio (Command: k c) (Main picture format)**

To adjust the screen format.

**Transmission** [k][c][ ][Set ID][ ][Data][Cr]

Date 1: 4:3                      6: Set by program

2: 16:9

3: Horizon

4: Zoom

**Acknowledgement** [c][ ][Set ID][ ][OK/NG][Data][x]

**04. Screen Mute (Command: k d)**

To select screen mute on/off.

**Transmission** [k][d][ ][Set ID][ ][Data][Cr]

Data 0 : Screen mute off (Picture on)

Data 1 : Screen mute on (Picture off)

**Acknowledgement** [d][ ][Set ID][ ][OK/NG][Data][x]

**05. Volume Mute (Command: k e)**

To control volume mute on/off.

You can also adjust mute using the MUTE button on remote control.

**Transmission** [k][e][ ][Set ID][ ][Data][Cr]

Data 0 : Volume mute on (Volume off)

Data 1 : Volume mute off (Volume on)

**Acknowledgement** [e][ ][Set ID][ ][OK/NG][Data][x]

**06. Volume Control (Command: k f)**

To adjust volume.

You can also adjust volume with the volume buttons on remote control.

**Transmission** [k][f][ ][Set ID][ ][Data][Cr]

Data Min : 0 ~ Max : 64

Refer to 'Real data mapping' as shown below.

**Acknowledgement** [f][ ][Set ID][ ][OK/NG][Data][x]

**07. Contrast (Command: k g)**

To adjust screen contrast.

You can also adjust contrast in the Video menu.

**Transmission** [k][g][ ][Set ID][ ][Data][Cr]

Data Min : 0 ~ Max : 64

Refer to 'Real data mapping' as shown below.

**Acknowledgement** [g][ ][Set ID][ ][OK/NG][Data][x]

**08. Brightness (Command: k h)**

To adjust screen brightness.

You can also adjust brightness in the Video menu.

**Transmission** [k][h][ ][Set ID][ ][Data][Cr]

Data Min : 0 ~ Max : 64 (\*transmit by Hexadecimal code)

Refer to 'Real data mapping' as shown below.

**Acknowledgement** [h][ ][Set ID][ ][OK/NG][Data][x]

**09. Color (Command: k i)**

To adjust the screen color.

You can also adjust color in the Video menu.

**Transmission** [k][i][ ][Set ID][ ][Data][Cr]

Data Min : 0 ~ Max : 64

Refer to 'Real data mapping' as shown below.

**Acknowledgement** [i][ ][Set ID][ ][OK/NG][Data][x]

\*Real data mapping

0 : Step 0

⋮

A : Step 10 (SET ID 10)

⋮

F : Step 15 (SET ID 15)

10 : Step 16 (SET ID 16)

⋮

63 : Step 99 (SET ID 99)

64 : Step 100

\* Tint : R50 ~ G50

\* Balance : L50 ~ R50



## 10. Tint (Command: k j)

To adjust the screen tint.

You can also adjust tint in the Video menu.

*Transmission* [k][j][ ][Set ID][ ][Data][Cr]

Data Red : 0 ~ Green : 64

\*Refer to 'Real data mapping': ► p.87.

*Acknowledgement* [j][ ][Set ID][ ][OK/NG][Data][x]

## 11. Sharpness (Command: k k)

To adjust the screen sharpness.

You can also adjust sharpness in the Video menu.

*Transmission* [k][k][ ][Set ID][ ][Data][Cr]

Data Min: 0 ~ Max: 64

\*Refer to 'Real data mapping': ► p.87.

*Acknowledgement* [k][ ][Set ID][ ][OK/NG][Data][x]

## 12. OSD Select (Command: k l)

To select OSD (On Screen Display) on/off.

*Transmission* [k][l][ ][Set ID][ ][Data][Cr]

Data 0: OSD off                      Data 1: OSD on

*Acknowledgement* [l][ ][Set ID][ ][OK/NG][Data][x]

## 13. Remote Control Lock Mode (Command: k m)

To lock the remote control and the front panel controls on the set.

*Transmission* [k][m][ ][Set ID][ ][Data][Cr]

Data 0: Lock off                      Data 1: Lock on

*Acknowledgement* [m][ ][Set ID][ ][OK/NG][Data][x]

If you're not using the remote control and front panel controls on the TV, use this mode. When main power is on/off, remote control lock is released.

## 14. Treble (Command: k r)

To adjust treble.

You can also adjust treble in the Audio menu.

*Transmission* [k][r][ ][Set ID][ ][Data][Cr]

Data Min: 0 ~ Max: 64(\*transmit by Hexadecimal code)

\*Refer to 'Real data mapping': ► p.87.

*Acknowledgement* [r][ ][Set ID][ ][OK/NG][Data][x]

## 15. Bass (Command: k s)

To adjust bass.

You can also adjust bass in the Audio menu.

*Transmission* [k][s][ ][Set ID][ ][Data][Cr]

Data Min: 0 ~ Max: 64(\*transmit by Hexadecimal code)

\*Refer to 'Real data mapping': ► p.87.

*Acknowledgement* [s][ ][Set ID][ ][OK/NG][Data][x]

## 16. Balance (Command: k t)

To adjust balance.

You can also adjust balance in the Audio menu.

*Transmission* [k][t][ ][Set ID][ ][Data][Cr]

Data Min: 0 ~ Max: 64(\*transmit by Hexadecimal code)

\*Refer to 'Real data mapping': ► p.87.

*Acknowledgement* [t][ ][Set ID][ ][OK/NG][Data][x]

## 17. Color Temperature (Command: k u)

To adjust color temperature.

You can also adjust color temperature in the Video menu.

*Transmission* [k][u][ ][Set ID][ ][Data][Cr]

Data 0: Medium    1: Cool    2: Warm    3: User

*Acknowledgement* [u][ ][Set ID][ ][OK/NG][Data][x]

## 18. Channel Tuning (Command: m a)

To tune channel to following physical/major/minor number.

*Transmission* [m][a][ ][Set ID][ ][Data0][ ][Data1][ ][Data2][ ][Data3][ ][Data4][ ][Data5][Cr]

Digital channels have a Physical, Major, and Minor channel number. The Physical number is the actual digital channel number, the Major is the number that the channel should be mapped to, and the Minor is the sub-channel. Since the ATSC tuner automatically maps the channel to the Major number, the Physical number is not required when sending a command.

Data 0: Physical Channel Number

NTSC air: 02~45, NTSC cable: 01, 0E~7D

ATSC air: 01~45, ATSC cable: 01~87

Data1 & 2: Major Channel Number

Data1: High byte                      Data2: Low byte

Two bytes are available for the Major and Minor, normally only the second byte is used.

Data3 & 4: Minor Channel Number

Not needed for NTSC.

Data5:

7	Main/Sub Picture	6	Two/One Part Channel	5	Using Physical Channel	4	Reserved	3	2	1	0	Step
0	Main	0	Two	0	Use	x		0	0	0	0	NTSC Air
1		1	One	1	No Use	x		0	0	0	1	NTSC Cable
						x		0	0	1	0	ATSC Air
						x		0	0	1	1	ATSC Cable_std
						x		0	1	0	0	ATSC Cable_hrc
						x		0	1	0	1	ATSC Cable_irc
						x		0	1	1	0	ATSC cable_auto
						x		0	1	1	1	Reserved
						x		x	x	x	x	-
						x		1	1	1	1	Reserved

The table above lists the binary code which must be converted to Hexadecimal before sending. For example: The binary code to tune the sub source to an NTSC cable channel is "1000 0001", which translates to "81" in Hex.

- \* 7th bit : For which source do you want to change the channel.
- \* 6th bit: Use a two part or one part channel. Most cases just use 0 since it's ignored when using NTSC.
- \* 5th bit: Use 0 with NTSC since it can only use the physical channel number. Normally use 1 for ATSC since most times it doesn't matter what the physical number is.
- \* 4th bit: Set to 0.
- \* 3-0 bits: Choose signal type.

\* Tune Command Examples:

1. Tune to the analog (NTSC) cable channel 35.

Data 0 = Physical of 35 = 23  
 Data 1 & 2 = No Major = 00 00  
 Data 3 & 4 = No Minor = 00 00  
 Data 5 = 0000 0001 in binary = 01  
 Total = ma 00 23 00 00 00 00 01

2. Tune to the digital (ATSC) local channel 30-3.

Data 0 = Don't know Physical = 00  
 Data 1 & 2 = Major is 30 = 00 1E  
 Data 3 & 4 = Minor is 3 = 00 03  
 Data 5 = 0010 0010 in binary = 22  
 Total = ma 00 00 00 1E 00 03 22

*Acknowledgement*[a][ ][Set ID][ ][OK][Data0][Data1][Data2][Data3][Data4][x][a][ ][Set ID][ ][NG][Data0][x]

## 19. Channel Add/Del (Command: m b)

To add and delete the channels

*Transmission* [m][b][ ][Set ID][ ][Data][Cr]

Data 0: Channel Delete      Data 1: Channel Add

*Acknowledgement* [b][ ][Set ID][ ][OK/NG][Data][x]

## 20. Key (Command: m c)

To send IR remote key code.

*Transmission* [m][c][ ][Set ID][ ][Data][Cr]

*Acknowledgement* [c][ ][Set ID][ ][OK/NG][Data][x]

Code (Hexa)	Remote control	Code (Hexa)	Remote control
0F	TV	39	MUTE
0B	INPUT	40	▲
08	POWER	41	▼
0E	RATIO	07	◀
10-19	Number Key 0-9	06	▶
4C	- (Dash)	44	ENTER
CB	FLASHBK	43	Q.MENU
09	CC	52	SOUND
02	VOL +	4D	PICTURE
03	VOL -	5B	EXIT
00	CH +	0A	AV MODE
01	CH -	1A	MENU
1E	FAV		

## 21. Input select (Command: x b)

To select input source for TV.

*Transmission* [x][b][ ][Set ID][ ][Data][Cr]

Data 00 : DTV (Antenna)      Data 40 : Component

Data 01 : DTV (Cable)      Data 60 : RGB PC

Data 10 : Analog (Antenna)      Data 90 : HDMI

Data 11 : Analog (Cable)

Data 20 : AV

*Acknowledgement* [b][ ][Set ID][ ][OK/NG][Data][x]

**LG Electronics Inc.**



# Regulatory information

## Regulatory information

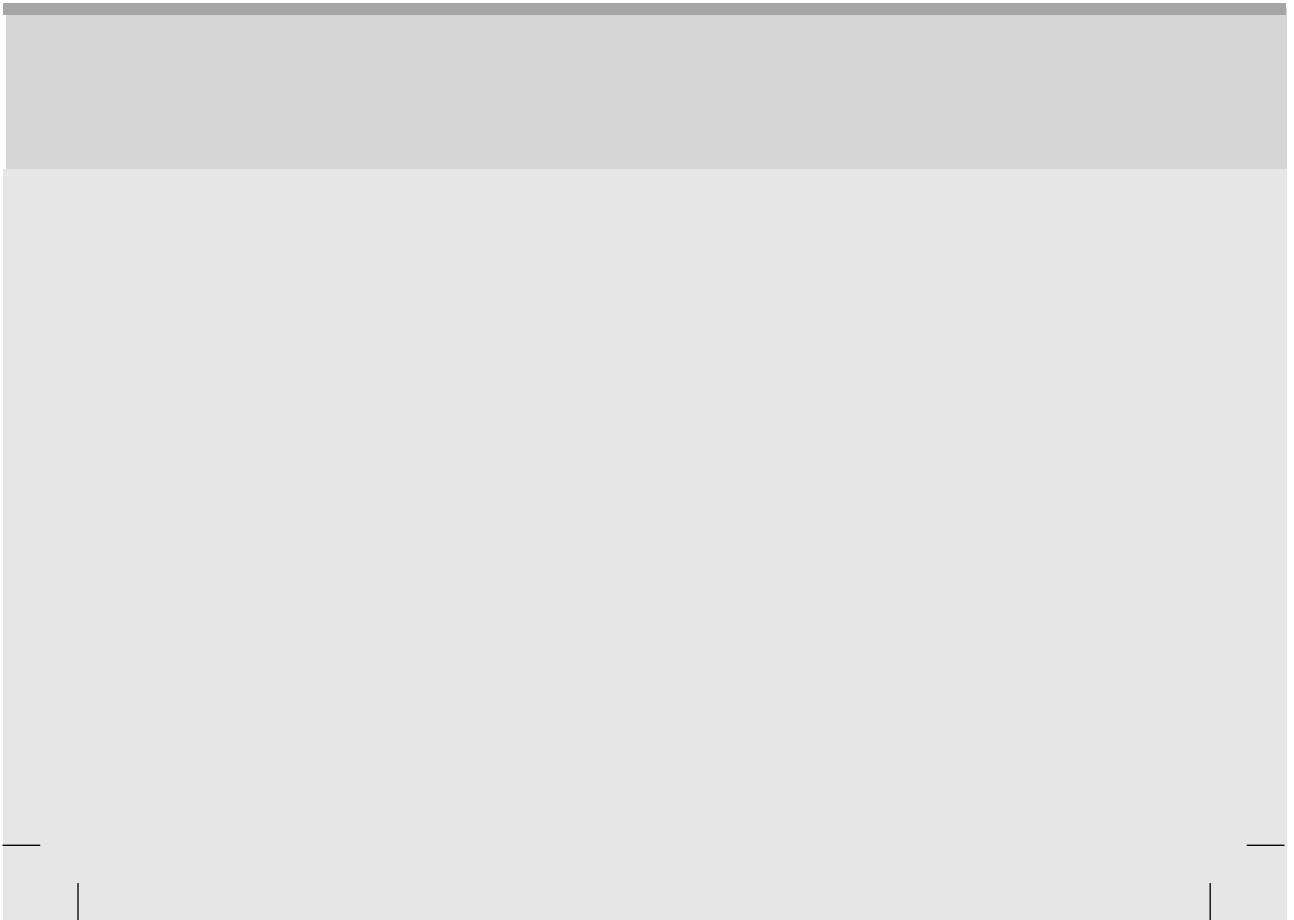

## ■■■ Regulatory Information cont.

### :: FCC Compliance Statement

This equipment has been tested and found to comply within the limits of a Class B digital device pursuant to Part 15 of the FCC Rules. These limits are designed to provide reasonable protection against harmful interference in a residential installation.

This equipment generates, uses, and can radiate radio frequency energy and if not installed and used in accordance with the instructions, may cause harmful interference to radio communications. However, there is no guarantee that interference will not occur in a particular installation.

If this equipment does cause harmful interference to radio or television reception (which can be determined by turning the equipment on and off), the user is encouraged to try to correct the interference by using one or more of the following measures:

- Reorient or relocate the receiving antenna.
- Increase the separation between the equipment and the receiver.
- Connect the equipment into an outlet on a circuit different from that to which the receiver is connected.
- Consult the dealer or an experienced radio/TV technician for help.

Caution: Changes or modifications not expressly approved by the party responsible for compliance could void the user's (or your) authority to operate the equipment. Only peripherals (digital input/output devices, terminals, printers, etc.) certified to comply with the Class B limits may be attached to this monitor. Operation with non-certified peripherals is likely to result in interference to radio and TV reception. Only shielded signal cables may be used with this System.

#### NOTICE

The regulations are applied only to the products with the ID LABEL indicating specific requirements.

### :: Canadian DOC Notice

This Class B digital apparatus meets all requirements of the Canadian Interference-Causing Equipment Regulations. Cet appareil numérique de la classe B

respecte toutes les exigences du Règlement sur le matériel brouilleur du Canada.

#### NOTICE

The regulations are applied only to the products with the ID LABEL indicating specific requirements.

### :: CE Conformity Notice (for Europe)

Products with the "CE" Marking comply with the EMC Directive(89/336/EEC) and LOW VOLTAGE Directive (73/23/EEC) issued by the Commission of the European Community.

Compliance with these directives implies conformity to the following European Norms :

- EN 55022 ; Radio Frequency Interference
- EN 55024 ; Electromagnetic Immunity
- EN 61000-3-2 ; Power Line Harmonics
- EN 61000-3-3 ; Voltage Fluctuations
- EN 60950 ; Product Safety

#### NOTICE

The regulations are applied only to the products with the ID LABEL indicating specific requirements.

### :: Low Radiation Compliance (MPR II)

This monitor meets one of the strictest guidelines available today for low radiation emissions, offering the user extra shielding and an antistatic screen coating. These guidelines, set forth by a government agency in Sweden, limit the amount of emission allowed in the Extremely Low Frequency (ELF) and Very Low Frequency (VLF) electromagnetic range.

### :: TCO95 (TCO95 applied model only)



#### Congratulations!

You have just purchased a TCO'95 approved and labelled product! Your choice has provided you with a product developed for professional use. Your purchase has also contributed to reducing the burden on the environment and to the further development of environmentally-adapted electronic products.

## ■■■ Regulatory Information cont.

### Why do we have environmentally labelled computers?

In many countries, environmental labelling has become an established method for encouraging the adaptation of goods and services to the environment. The main problem as far as computers and other electronic equipment are concerned is that environmentally harmful substances are used both in the products and during their manufacture. Since it has not been possible so far for the majority of electronic equipment to be recycled in a satisfactory way, most of these potentially damaging substances sooner or later enter Nature.

There are also other characteristics of a computer, such as energy consumption levels, that are important from both the working and natural environment viewpoints. Since all types of conventional electricity generation have a negative effect on the environment (acidic- and climatic-influencing emissions, radioactive waste, etc.), it is vital to conserve energy. Electronic equipment in offices consumes an enormous amount of energy, since it is often routinely left running continuously.

### What does the environmental labelling involve?

This product meets the requirements for the TCO'95 scheme, which provides for international environmental labelling of personal computers. The labelling scheme was developed as a joint effort by the TCO (The Swedish Confederation of Professional Employees), Naturkyddsforeningen (The Swedish Society for Nature Conservation), and NUTEK (The National Board for Industrial and Technical Development in Sweden), and SEMKO AB (an international certification agency).

The requirements cover a wide range of issues: environment, ergonomics, usability, emission of electrical and magnetic fields, energy consumption and electrical and fire safety.

The environmental demands concern, among other things, restriction on the presence and use of heavy metals, brominated and chlorinated flame retardants, CFCs (freons), and chlorinated solvents. The product must be prepared for recycling, and the manufacturer is obliged to have an environmental plan, which must be adhered to in each country where the company implements its operational policy.

The energy requirements include a demand that the

computer and/or display, after a certain period of inactivity, shall reduce its power consumption to a lower level, in one or more stages. The length of time to reactivate the computer shall be reasonable for the user.

Labelled products must meet strict environmental demands, for example, in respect of the reduction of electric and magnetic fields, along with physical and visual ergonomics and good usability.

The following is a brief summary of the environmental requirements met by this product. The complete environmental criteria document may be ordered from:

TCO Development Unit  
Linnegatan 14, S-11494 Stockholm, Sweden  
FAX +46-8 782 92 07  
E-mail (Internet): [development@tco.se](mailto:development@tco.se)

Current information regarding TCO'95 approved and labelled products may also be obtained on the Internet using the address: <http://www.tco-info.com/>

TCO'95 is a co-operative project between:



Naturkydds  
foreningen



NUTEK

SEMKO

Närings- och teknikutvecklingsverket

### Environmental requirements

Brominated flame retardants are present in printed circuit boards, cabling, casings, and housings, and are added to delay the spread of fire. Up to 30% of the plastic in a computer casing can consist of flame-retardant substances. These are related to another group of environmental toxins, PCBs, and are suspected of giving rise to similar harm, including reproductive damage in fish-eating birds and mammals. Flame retardants have been found in human blood, and researchers fear that they can disturb fetus development.

Bio-accumulative<sup>1</sup> TCO'95 demands require that plastic components weighing more than 25 grams must not contain flame retardants with organically bound chlorine or bromine.

Lead can be found in picture tubes, display screens, solder, and capacitors. Lead damages the nervous system and in higher doses causes lead poisoning. The

## ■■■ Regulatory Information cont.

relevant bio-accumulative TCO'95 requirement permits the inclusion of lead, as no replacement has yet been developed.

Cadmium is present in rechargeable batteries and in the color-generating layers of certain computer displays. Cadmium damages the nervous system and is toxic in high doses. The relevant bio-accumulative TCO'95 requirement states that batteries may not contain more than 25 ppm (parts per million) of cadmium. The color-generating layers of display screens must not contain any cadmium.

Mercury is sometimes found in batteries, relays and switches. Mercury damages the nervous system and is toxic in high doses. The relevant bio-accumulative TCO'95 requirement states that batteries may not contain more than 25 ppm of mercury and that no mercury is present in any of the electrical or electronic components concerned with the display unit.

CFCs (freons) are sometimes used for washing printed circuit boards and in the manufacture of expanded foam for packaging. CFCs break down ozone and thereby damage the ozone layer in the atmosphere, causing increased reception on Earth of ultra-violet light with consequent increased risks of skin cancer (malignant melanoma). The relevant TCO'95 requirement: Neither CFCs nor HCFCs may be used during the manufacture of the product or its packaging.

<sup>1</sup> Bio-accumulative means that the substance accumulates within living organisms.

### Shipping Package

The packaging material can be recycled, or you can save it to return the monitor to a service center for repair or disposal.

### CFC Compounds in Distribution Packaging

Cushioning material used for shipping finished monitors are not manufactured with nor do they contain any CFC compounds.

### Design for Disassembly/Recycling

These monitors have been designed for easy end-of-life disassembly and recycling. Fasteners are generally of the same type for efficient disassembly. Components made of different materials can be easily separated and plastics have been identified using international symbols to aid in recycling.

### Monitor Disposal

#### WARNING

If you need to dispose of a monitor, ask a qualified service representative for the proper procedure. Improper disposal could result in personal injury from implosion.

:: **TCO'99** (TCO'99 applied model only)



### Congratulations!

You have just purchased a TCO'99 approved and labelled product! Your choice has provided you with a product developed for professional use. Your purchase has also contributed to reducing the burden on the environment and also to the further development of environmentally adapted electronics products.

### Why do we have environmentally labelled computers?

In many countries, environmental labelling has become an established method for encouraging the adaptation of goods and services to the environment. With the growing manufacture and usage of electronic equipment throughout the world, there is a recognized concern for the materials and substances used by electronic products with regards to their eventual recycling and disposal. By proper selection of these materials and substances, the impact on the environment can be minimized.

There are also other characteristics of a computer, such as energy consumption levels, that are important from the viewpoints of both the work (internal) and natural (external) environments. Electronic equipment in offices is often left running continuously, resulting in unnecessary consumption of large amounts of energy and additional power generation. From the standpoint of carbon dioxide emissions alone, it is vital to save energy.

### What does labelling involve?

The product meets the requirements for the TCO'99 scheme which provides for international and environmental labelling of personal computers and/or displays.

The labelling scheme was developed as a joint effort by the TCO (The Swedish Confederation of Professional Employees), Svenska Naturskyddsforeningen (The Swedish Society for Nature Conservation) and Statens Energimyndighet (The Swedish National Energy Administration).

## ■■■ Regulatory Information cont.

Approval requirements cover a wide range of issues: ecology, ergonomics, emission of electrical and magnetical fields, energy consumption and electrical safety.

Ecological criteria impose restrictions on the presence and use of heavy metals, brominated and chlorinated flame retardants, and other substances. The product must be prepared for recycling and the manufacturing site(s) shall be certified according to ISO14001 or EMAS registered.

Energy requirements include a demand that the system unit and/or display, after a certain period of inactivity, shall reduce its power consumption to a lower level in one or more stages. The length of time to reactivate the system unit shall be reasonable for the user.

Labelled products must meet strict environmental demands, for example, in respect of the reduction of electrical and magnetical fields as well as work load and visual ergonomics.

Below you will find a brief summary of the ecological requirements met by this product. The complete ecological criteria document can be found at TCO Development's website <http://www.tcodevelopment.com> or may be ordered from:

**TCO Development**  
SE-114 94 STOCKHOLM, Sweden  
Fax: +46 8 782 92 07  
Email : [development@tco.se](mailto:development@tco.se)  
Information regarding TCO'99 approved and labelled products may also be obtained at <http://www.tcodevelopment.com>

### Ecological requirements

#### Flame retardants

Flame retardants may be present in printed wiring board laminates, cables, and housings. Their purpose is to prevent, or at least to delay the spread of fire. Up to 30% by weight of the plastic in a computer casing can consist of flame retardant substances. Many flame retardants contain bromine or chlorine, and these flame retardants are chemically related to PCBs (polychlorinated biphenyls). Both the flame retardants containing bromine or chlorine and the PCBs are suspected of giving rise to health effects, including reproductive damage in fish-eating birds and mammals, due to the bio-accumulative\* processes when not disposed of in accordance with strict standards for disposal.

TCO'99 requires that plastic components weighing more than 25 grams shall not contain flame retardants with organically bound bromine or chlorine. Flame retardants are allowed in the printed wiring board laminates due to the lack of commercially available alternatives.

#### Cadmium\*\*

Cadmium is present in rechargeable batteries and in the colour-generating layers of certain computer displays. TCO'99 requires that batteries, the colour-generating layers of display screens, and the electrical or electronics components shall not contain any cadmium.

#### Mercury\*\*

Mercury is sometimes found in batteries, relays and switches. TCO'99 requires that batteries shall not contain any mercury. It also demands that mercury is not present in any of the electrical or electronics components associated with the labelled unit. There is however one exception. Mercury is, for the time being, permitted in the back light system of flat panel monitors as there today is no commercially available alternative. TCO aims on removing this exception when a mercury free alternative is available.

#### Lead\*\*

Lead can be found in picture tubes, display screens, solders and capacitors. TCO'99 permits the use of lead due to the lack of commercially available alternatives, but in future requirements TCO Development aims at restricting the use of lead.

\* Bio-accumulative is defined as substances which accumulate in living organisms.

\*\*Lead, Cadmium and Mercury are heavy metals which are bio-accumulative.



## ■■■ Regulatory Information cont.

:: **TCO'03** (TCO'03 applied model only)



### **Congratulations!**

The display you have just purchased carries the TCO'03 Displays label.

This means that your display is designed, manufactured and tested according to some of the strictest quality and environmental requirements in the world. This makes for a high performance product, designed with the user in focus that also minimizes the impact on our natural environment. Some of the features of the TCO'03 Display requirements:

### **Ergonomics**

- Good visual ergonomics and image quality in order to improve the working environment for the user and to reduce sight and strain problems. Important parameters are luminance, contrast, resolution, reflectance, colour rendition and image stability.

### **Energy**

- Energy-saving mode after a certain time – beneficial both for the user and the environment
- Electrical safety

### **Emissions**

- Electromagnetic fields
- Noise emissions

### **Ecology**

- The product must be prepared for recycling and the manufacturer must have a certified environmental management system such as EMAS or ISO 14 001
- Restrictions on
  - chlorinated and brominated flame retardants and polymers
  - heavy metals such as cadmium, mercury and lead.

The requirements included in this label have been developed by TCO Development in co-operation with scientists, experts, users as well as manufacturers all over the world. Since the end of the 1980s TCO has been involved in influencing the development of IT equipment in a more user-friendly direction. Our labelling system started

with displays in 1992 and is now requested by users and IT-manufacturers all over the world.

For more information, please visit  
[www.tcodevelopment.com](http://www.tcodevelopment.com)

## English

### **Information for Environmental Preservation**

LGE. announced the 'LG Declaration for a Cleaner Environment' in 1994, and this ideal has served as a guiding managerial principle ever since. The Declaration is a foundation that has allowed us to undertake environmentally friendly activities in careful consideration of economic, environmental, and social aspects.

We promote activities for environmental preservation, and we specifically develop our products to embrace the concept of environment-friendly.

We minimize the hazardous materials contained in our products. For example, there is no cadmium to be found in our monitors.

### **Information for recycling**

This monitor may contain parts which could be hazardous to the environment. It is important that this monitor be recycled after use.

LGE. handles all waste monitors through an environmentally acceptable recycling method. There are several take-back and recycling systems currently in operation worldwide. Many parts will be reused and recycled, while harmful substances and heavy metals are treated by an environmentally friendly method.

If you want to find out more information about our recycling program, please contact your local LG vendor or a corporate representative of LG.

We set our vision and policies on a cleaner world by selecting the issue of the global environment as a task for corporate improvement. Please visit our website for more information about our 'green' policies.

[http://www.lge.com/experience/social\\_commitment/environment.jsp](http://www.lge.com/experience/social_commitment/environment.jsp)

## ■■■ Regulatory Information cont.

### ■ ■ ■ Deutsch

#### Informationen zur Erhaltung der Umwelt

Im Jahr 1994 verkündete LGE die 'LG Declaration for a Cleaner Environment' (LG Erklärung für eine sauberere Umwelt). Seitdem dient dieses Ideal als führendes Prinzip des Unternehmens. Diese Erklärung war die Basis für die Durchführung von

umweltfreundlichen Aktivitäten, wobei wirtschaftliche, umweltbezogene und soziale Aspekte in die Überlegungen mit einbezogen wurden.

Wir fördern Aktivitäten zum Schutz der Umwelt und die Entwicklung unserer Produkte ist darauf ausgerichtet, unserem Konzept bezüglich Umweltfreundlichkeit gerecht zu werden.

Wir sind darauf bedacht, den Anteil der in unseren Produkten enthaltenen schädlichen Materialien zu minimieren. So ist in unseren Monitoren beispielsweise kein Kadmium zu finden.

#### Informationen zum Thema Recycling

Dieser Monitor enthält Teile, die umweltschädlich sein können. Es ist unbedingt erforderlich, dass der Monitor recycelt wird, nachdem er außer Dienst gestellt wurde.

Bei LGE werden alle ausrangierten Monitore in einem unter umweltbezogenen Aspekten geeigneten Verfahren recycelt. Augenblicklich sind weltweit mehrere Rücknahme- und Recyclingsysteme im Einsatz. Viele Teile werden wieder verwendet und recycelt. Schädliche Substanzen und Schwermetalle werden durch umweltverträgliche Verfahren behandelt.

Falls Sie mehr über unser Recyclingprogramm erfahren möchten, wenden Sie sich bitte an Ihren lokalen LG-Händler oder einen Unternehmensvertreter von LG.

Wir richten unsere Firmenpolitik auf eine sauberere Umwelt hin aus, indem wir umweltspezifische Aspekte als wichtigen Punkt in die Weiterentwicklung unseres Unternehmens einfließen lassen. Zusätzliche Informationen über unsere 'grüne' Firmenpolitik erhalten Sie auf unserer Website.

[http://www.lge.com/experience/social\\_commitment/environment.jsp](http://www.lge.com/experience/social_commitment/environment.jsp)

### ■ ■ ■ Français

#### Information sur la protection de l'environnement

LGE a publié sa 'Déclaration en faveur d'un

environnement plus propre' en 1994 et celle-ci est restée, depuis lors, un principe directeur de notre entreprise. Cette déclaration a servi de base à notre réflexion et nous a permis de prendre en compte à la fois les aspects économiques et sociaux de nos activités, tout en respectant l'environnement.

Nous encourageons les activités en faveur de la préservation de l'environnement et c'est dans cet esprit que nous développons nos produits : nous réduisons au minimum les matières dangereuses qui entrent dans leur composition et l'on ne trouve pas de cadmium, par exemple, dans nos moniteurs.

#### Information sur le recyclage

Ce moniteur peut contenir des composants qui présentent un risque pour l'environnement. Il est donc important que celui-ci soit recyclé après usage.

LGE traite les moniteurs en fin de cycle conformément à une méthode de recyclage respectueuse de l'environnement. Nous reprenons nos produits et les recyclons dans plusieurs sites répartis dans le monde entier. De nombreux composants sont réutilisés et recyclés, et les matières dangereuses, ainsi que les métaux lourds, sont traités selon un procédé écologique.

Si vous souhaitez plus de renseignements sur notre programme de recyclage, veuillez contacter votre revendeur LG ou un l'un de nos représentants.

Nous voulons agir pour un monde plus propre et croyons au rôle de notre entreprise dans l'amélioration de l'environnement. Pour plus de renseignements sur notre politique "verte", rendez visite à notre site :

[http://www.lge.com/experience/social\\_commitment/environment.jsp](http://www.lge.com/experience/social_commitment/environment.jsp)

### ■ ■ ■ Italiano

#### Informazioni per la tutela dell'ambiente

La LGE ha annunciato nel 1994 la cosiddetta 'LG Declaration for a Cleaner Environment' (Dichiarazione di LG a favore di un ambiente più pulito), un ideale che da allora funge da principio ispiratore della gestione aziendale. La dichiarazione rappresenta il fondamento che consente di intraprendere attività a favore dell'ambiente tenendo conto degli aspetti economici, ambientali e sociali.

## ■■■ Regulatory Information cont.

Noi della LG, promuoviamo attività a favore della tutela dell'ambiente sviluppando appositamente i nostri prodotti per cogliere il concetto del rispetto dell'ambiente riducendo i materiali dannosi presenti nei nostri prodotti. Ad esempio nei nostri monitor non è presente il cadmio.

### Informazioni per il riciclaggio

Il monitor può presentare componenti che potrebbero risultare eventualmente dannosi per l'ambiente. È importante che il monitor sia riciclato al termine del suo utilizzo.

La LGE. gestisce tutti i monitor di rifiuto con un metodo di riciclaggio soddisfacente dal punto di vista ambientale. In tutto il mondo sono attualmente in funzione numerosi sistemi di riciclaggio e recupero. I diversi componenti sono riutilizzati e riciclati, mentre le sostanze dannose e i metalli pesanti vengono trattati con un metodo rispettoso dell'ambiente.

Se si desiderano maggiori informazioni in merito al programma di riciclaggio, è consigliabile rivolgersi al proprio rivenditore LG o ad un rappresentante aziendale della LG.

Noi della LG impostiamo la nostra visione e le nostre politiche a favore di un mondo più pulito ponendo la questione dell'ambiente dal punto di vista globale come una mansione rivolta al miglioramento della nostra azienda. Vi invitiamo a visitare il nostro sito internet per ulteriori informazioni sulla nostra politica "verde".

[http://www.lge.com/experience/social\\_commitment/enviro ment.jsp](http://www.lge.com/experience/social_commitment/enviro ment.jsp)

## ■■■ Español

### Información para la conservación medioambiental

LGE. presentó la 'Declaración para un entorno más limpio de LG' en 1994 y este ideal ha servido para guiar nuestros principios empresariales desde entonces. La Declaración es la base que nos ha permitido llevar a cabo tareas que respetan el medio ambiente siempre teniendo en cuenta aspectos sociales, económicos y medioambientales.

Promocionamos actividades orientadas a la conservación del medio ambiente y desarrollamos nuestros productos específicamente para que se ajusten a la filosofía que protege el entorno.

Reducimos al máximo el uso de materiales de riesgo en nuestros productos. Un ejemplo de ello es la ausencia total de cadmio en nuestros monitores.

### Información para el reciclaje

Este monitor puede contener piezas que entrañen riesgos medioambientales. Es importante reciclar este monitor después de su utilización.

LGE. trata todos los monitores usados siguiendo un método de reciclaje que no daña al entorno. Contamos con diversos sistemas de recuperación y reciclaje que funcionan a nivel mundial en la actualidad. Es posible reciclar y reutilizar muchas de las piezas, mientras que las sustancias dañinas y los metales pesados se tratan siguiendo un método que no perjudique al medio ambiente. Si desea obtener más información acerca del programa de reciclaje, póngase en contacto con su proveedor local de LG o con un representante empresarial de nuestra marca.

Basamos nuestra visión y nuestras políticas en un mundo más limpio y para ellos optamos por un entorno global como tarea principal de nuestra evolución como empresa. Visite nuestra página Web para obtener más información sobre nuestras políticas ecológicas.

[http://www.lge.com/experience/social\\_commitment/enviro ment.jsp](http://www.lge.com/experience/social_commitment/enviro ment.jsp)

## ■■■ Português

### Informações relacionadas à preservação ambiental

A LGE. anunciou a 'LG Declaration for a Cleaner Environment' (Declaração da LG para um ambiente mais limpo) em 1994 e esse ideal tem servido desde então como um princípio administrativo de orientação. A Declaração é a base que nos tem permitido realizar atividades favoráveis ao ambiente com consideração atenta aos aspectos econômicos, ambientais e sociais.

Promovemos atividades de preservação ambiental e desenvolvemos nossos produtos para englobar especificamente o conceito de favorável ao ambiente.

Reduzimos os materiais perigosos contidos em nossos produtos. Por exemplo, não há cádmio em nossos monitores.

## ■■■ Regulatory Information cont.

### Informações relacionadas à reciclagem

Este monitor pode conter peças que podem representar riscos ao ambiente. É importante que ele seja reciclado após o uso.

A LGE, cuida de todos os monitores descartados através de um método de reciclagem agradável ao ambiente. Há vários sistemas de devolução e reciclagem atualmente em operação no mundo. Muitas peças serão reutilizadas e recicladas e as substâncias nocivas e os metais pesados passarão por tratamento através de um método favorável ao ambiente.

Para obter mais informações sobre nosso programa de reciclagem, entre em contato com seu fornecedor LG local ou com um representante corporativo da LG.

Definimos nossa visão e nossas políticas relacionadas a um mundo mais limpo selecionando a questão do ambiente global como uma tarefa de aprimoramento corporativo. Visite nosso site para obter mais informações sobre nossas políticas de meio ambiente.

[http://www.lge.com/experience/social\\_commitment/environment.jsp](http://www.lge.com/experience/social_commitment/environment.jsp)

### ■ ■ ■ Nederlands

#### Informatie met betrekking tot het behoud van het milieu

LGE publiceerde in 1994 de 'LG Declaration for a Cleaner Environment' (de LG-verklaring met betrekking tot een schoner milieu). Deze verklaring en het ideaal van een schoner milieu fungeren sindsdien als een bestuurlijke leidraad voor onze onderneming. Op basis van deze verklaring ontplooiën wij milieuvriendelijke activiteiten, waarbij er zowel met sociale en economische aspecten, als met milieuaspecten zorgvuldig rekening wordt gehouden.

Wij ondersteunen activiteiten die zijn gericht op het behoud van het milieu en wij houden bij het ontwikkelen onze producten specifiek rekening met de milieuvriendelijkheid van onze producten.

Wij minimaliseren het gebruik van schadelijke stoffen in onze producten. Er wordt bijvoorbeeld geen cadmium verwerkt in onze monitoren.

#### Informatie met betrekking tot recycling

Deze monitor bevat materialen die schadelijk zouden kunnen zijn voor het milieu. Het is belangrijk dat deze

monitor aan het einde van zijn levensduur wordt gerecycled.

LGE verwerkt alle afvalmonitoren via een milieuvriendelijke recyclingmethode. Hiervoor worden er momenteel wereldwijd verscheidene inname- en recyclingsystemen gehanteerd. Een groot aantal onderdelen wordt opnieuw gebruikt en gerecycled, waarbij schadelijke stoffen en zware metalen volgens een milieuvriendelijke methode worden verwerkt.

Voor meer informatie over ons recyclingprogramma kunt u contact opnemen met uw plaatselijke LG-vertegenwoordiger of een LG-vestiging.

Onze visie en ons beleid met betrekking tot een schonere wereld vloeien voort uit het feit dat wij het milieu hebben aangemerkt als een onderwerp dat speciale aandacht verdient binnen onze onderneming. Bezoek onze website voor meer informatie over ons 'groene' beleid.

[http://www.lge.com/experience/social\\_commitment/environment.jsp](http://www.lge.com/experience/social_commitment/environment.jsp)

### ■ ■ ■ Russian

#### Информация по охране окружающей среды

В 1994 году корпорация LGE опубликовала 'Декларацию LG по охране окружающей среды', которая с тех пор служит основным принципом управления. На основе этой декларации мы смогли предпринять действия, обеспечивающие безопасность окружающей среды, уделяя при этом должное внимание экономическим, экологическим и социальным аспектам.

Мы стимулируем деятельность по охране окружающей среды, уделяя особое внимание разработке нашей продукции в соответствии с концепцией экологической безопасности.

Мы сводим к минимуму содержание опасных веществ в нашей продукции. Например, в наших мониторах вы не найдете кадмия.

#### Информация по утилизации отходов

Этот монитор может содержать компоненты, которые могут нанести ущерб окружающей среде. Необходимо утилизировать монитор после использования.

■■■ Regulatory Information cont.

Корпорация LGE перерабатывает все бракованные мониторы с помощью экологически приемлемого метода утилизации отходов. По всему миру действуют системы утилизации отходов и возврата использованной продукции. Многие компоненты будут вторично использованы и утилизированы, в то время как вредные вещества и тяжелые металлы будут обработаны с помощью экологически приемлемого метода. За более подробной информацией по нашей программе утилизации отходов обращайтесь к местному поставщику или представителю корпорации LG.

Мы ориентируемся на обеспечение экологической безопасности, ставя себе целью глобальную защиту окружающей среды. Дополнительную информацию о нашей политике по охране окружающей среды вы можете найти на нашем сайте:  
[http://www.lge.com/experience/social\\_commitment/environment.jsp](http://www.lge.com/experience/social_commitment/environment.jsp)

■■■ 한국어

환경 보존 정보

LG 전자는 1994년 'LG 환경 선언문'을 발표한 후 현재까지 이를 기업 경영의 이념으로 삼아왔습니다. 이 선언문을 바탕으로 LG 전자는 모든 경영 활동에서 경제성뿐만 아니라 환경성 및 사회성을 주요 의사 결정의 기준으로 삼음으로써 지속적으로 환경 친화적인 경영을 전개하고 있습니다.

본사는 보다 활발한 환경 보존 활동과 더불어 환경 친화적 제품 개발에 주력해 왔습니다. 또한 제품에 포함되는 환경 위해 요소를 최소화하는데에도 노력을 기울이지 않고 있습니다. LG 전자 모니터의 경우 카드뮴을 전혀 사용하지 않는 것에서도 이러한 노력을 알 수 있습니다.

재활용 정보

본 모니터에는 환경에 위해를 주는 부품이 포함되어 있을 수도 있습니다. 따라서 사용이 끝난 모니터는 재활용하는 것이 좋습니다.

폐모니터는 모두 환경 친화적 방식으로 처리됩니다. 현재 세계적으로 운영되고 있는 회수 및 재활용 시스템에는 여러 가지가 있습니다. 대부분의 부품의 경우 재사용

또는 재활용되지만 환경 위해 물질과 중금속은 환경 친화적 방법으로 처리됩니다.

본사의 재활용 프로그램에 대한 자세한 정보는 각 지역의 LG 공급업체나 LG 기업 대표부에 문의하시기 바랍니다.

LG 전자는 기업 개선 정책의 하나로 지구 환경 문제를 채택함으로써 보다 나은 환경을 만들어 나가기 위한 비전과 정책을 수립했습니다. 본사의 친환경 정책에 대한 자세한 정보를 보시려면 아래의 웹 사이트를 방문하십시오.

<http://www.lge.co.kr/about/digitalg/environment/environment.jsp>

:: EPA (U.S.A only) (EPA applied model only)

ENERGYSTAR is a set of power-saving guidelines issued by the U.S. Environmental Protection Agency(EPA).



As an ENERGY STAR Partner LGE U. S. A.,Inc. has determined that this product meets the ENERGY STAR guidelines for energy efficiency.

:: NOM MARK (Mexico only)

