



# LCD TV | PLASMA TV OWNER'S MANUAL

## LCD TV MODEL

26LG30	37LG50
32LG30	42LG50
37LG30	47LG50
42LG30	52LG50
32LG60	32LG70
37LG60	42LG70
42LG60	47LG70
47LG60	52LG70
52LG60	

## PLASMA TV MODELS

42PG10	50PG60F
50PG10	60PG60F
42PG20	42PG20C
50PG20	50PG20C

Please read this manual carefully before operating your set.

Retain it for future reference.

Record model number and serial number of the set.

See the label attached on the back cover and quote this information to your dealer when you require service.

ENERGY STAR is a set of power-saving guidelines issued by the U.S. Environmental Protection Agency(EPA).



As an ENERGY STAR Partner LGE U. S. A.,Inc. has determined that this product meets the ENERGY STAR guidelines for energy efficiency.

P/NO : SAC30708020 (0711-REV00)



# WARNING / CAUTION



**WARNING / CAUTION**  
RISK OF ELECTRIC SHOCK  
DO NOT OPEN



TO REDUCE THE RISK OF ELECTRIC SHOCK  
DO NOT REMOVE COVER (OR BACK). NO  
USER SERVICEABLE PARTS INSIDE. REFER TO  
QUALIFIED SERVICE PERSONNEL.



The lightning flash with arrowhead symbol, within an equilateral triangle, is intended to alert the user to the presence of uninsulated “dangerous voltage” within the product’s enclosure that may be of sufficient magnitude to constitute a risk of electric shock to persons.



The exclamation point within an equilateral triangle is intended to alert the user to the presence of important operating and maintenance (servicing) instructions in the literature accompanying the appliance.

## WARNING/CAUTION

TO REDUCE THE RISK OF FIRE AND ELECTRIC SHOCK, DO NOT EXPOSE THIS PRODUCT TO RAIN OR MOISTURE.

## NOTE TO CABLE/TV INSTALLER

This reminder is provided to call the CATV system installer’s attention to Article 820-40 of the National Electric Code (U.S.A.). The code provides guidelines for proper grounding and, in particular, specifies that the cable ground shall be connected to the grounding system of the building, as close to the point of the cable entry as practical.

## WARNING / CAUTION

To prevent fire or shock hazards, do not expose this product to rain or moisture.

## FCC NOTICE

### Class B digital device

This equipment has been tested and found to comply with the limits for a Class B digital device, pursuant to Part 15 of the FCC Rules. These limits are designed to provide reasonable protection against harmful interference in a residential installation. This equipment generates, uses and can radiate radio frequency energy and, if not installed and used in accordance with the instructions, may cause harmful interference to radio communications. However, there is no guarantee that interference will not occur in a particular installation. If this equipment does cause harmful interference to radio or television reception, which can be determined by turning the equipment off and on, the user is encouraged to try to correct the interference by one or more of the following measures:

- Reorient or relocate the receiving antenna.
- Increase the separation between the equipment and receiver.
- Connect the equipment to an outlet on a circuit different from that to which the receiver is connected.
- Consult the dealer or an experienced radio/TV technician for help.

**Any changes or modifications not expressly approved by the party responsible for compliance could void the user’s authority to operate the equipment.**

## CAUTION

Do not attempt to modify this product in any way without written authorization from LG Electronics. Unauthorized modification could void the user’s authority to operate this product

# SAFETY INSTRUCTIONS

## IMPORTANT SAFETY INSTRUCTIONS

Important safety instructions shall be provided with each apparatus. This information shall be given in a separate booklet or sheet, or be located before any operating instructions in an instruction for installation for use and supplied with the apparatus.

This information shall be given in a language acceptable to the country where the apparatus is intended to be used. The important safety instructions shall be entitled "Important Safety Instructions". The following safety instructions shall be included where applicable, and, when used, shall be verbatim as follows. Additional safety information may be included by adding statements after the end of the following safety instruction list. At the manufacturer's option, a picture or drawing that illustrates the intent of a specific safety instruction may be placed immediately adjacent to that safety instruction:

**Read these instructions.**

**Keep these instructions.**

**Heed all warnings.**

**Follow all instructions.**



- 1** Do not use this apparatus near water.

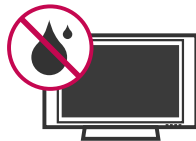

- 2** Clean only with dry cloth.



- 3** Do not block any ventilation openings. Install in accordance with the manufacturer's instructions.



- 4** Do not install near any heat sources such as radiators, heat registers, stoves, or other apparatus (including amplifiers) that produce heat.



- 5** When mounting a TV it on the wall, make sure not to install TV by hanging power and signal cables on the back of the TV.

- 6** Do not defeat the safety purpose of the polarized or grounding-type plug. A polarized plug has two blades with one wider than the other. A grounding type plug has two blades and a third grounding prong. The wide blade or the third prong are provided for your safety. If the provided plug does not fit into your outlet, consult an electrician for replacement of the obsolete outlet.



- 7** Protect the power cord from being walked on or pinched particularly at plugs, convenience receptacles, and the point where they exit from the apparatus.



- 8** Only use attachments/accessories specified by the manufacturer.



- 9** Unplug this apparatus when unused for long periods of time.

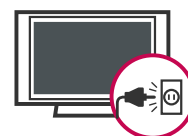

- 10** Use only with the cart, stand, tripod, bracket, or table specified by the manufacturer, or sold with the apparatus. When a cart is used, use caution when moving the cart/apparatus combination to avoid injury from tip-over.

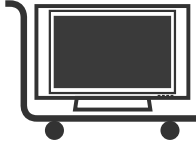

S3125A

- 11** Never touch this apparatus or antenna during a thunder or lightning storm.

- 12** Do not allow a impact shock or any objects to fall into the product, and do not drop onto the screen with something.

- 13** Refer all servicing to qualified service personnel. Servicing is required when the apparatus has been damaged in any way, such as power-supply cord or plug is damaged, liquid has been spilled or objects have fallen into the apparatus, the apparatus has exposed to rain or moisture, does not operate normally, or has been dropped.

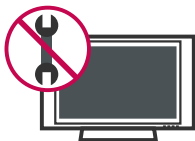

- 14** CAUTION concerning the Power Cord : Most appliances recommend they be placed upon a dedicated circuit; that is, a single outlet circuit which powers only that appliance and has no additional outlets or branch circuits. Check the specification page of this owner's manual to be certain.

Do not overload wall outlets. Overloaded wall outlets, loose or damaged wall outlets, extension cords, frayed power cords, or damaged or cracked wire insulation are dangerous. Any of these conditions could result in electric shock or fire. Periodically examine the cord of your appliance, and if its appearance indicates damage or deterioration, unplug it, discontinue use

of the appliance, and have the cord replaced with an exact replacement part by an authorized servicer. Protect the power cord from physical or mechanical abuse, such as being twisted, kinked, pinched, closed in a door, or walked upon. Pay particular attention to plugs, wall outlets, and the point where the cord exits the appliance.



- 15** Outdoor use marking :  
WARNING - To reduce the risk of fire or electric shock, do not expose this appliance to rain or moisture.



- 16** Wet Location Marking : Apparatus shall not be exposed to dripping or splashing and no objects filled with liquids, such as vases, shall be placed on or over apparatus.



## **17** GROUNDING

Ensure that you connect the earth ground wire to prevent possible electric shock. If grounding methods are not possible, have a qualified electrician install a separate circuit breaker.

Do not try to ground the unit by connecting it to telephone wires, lightening rods, or gas pipes.

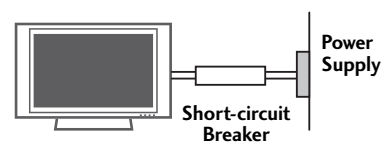

- 18** DISCONNECTING DEVICE FROM MAINS  
Mains plug is the disconnecting device. The plug must remain readily operable.

# CONTENTS

<b>WARNING / CAUTION</b> .....	1
<b>SAFETY INSTRUCTIONS</b> .....	2
<b>FEATURE OF THIS TV</b> .....	6

## PREPARATION

Accessories .....	7
Front Panel Information .....	8
Back Panel Information .....	10
Stand Installation .....	14
Back Cover for Wire Arrangement .....	16
Desktop Pedestal Installation .....	18
VESA Wall Mounting .....	18
Swivel Stand .....	19
Not Using the Desk-Type Stand .....	19
Attaching the TV to a Desk .....	19
How to join the TV Assemble to the wall to protect the TV tumbling .....	20
Antenna or Cable Connection .....	21

## EXTERNAL EQUIPMENT SETUP

HD Receiver Setup .....	22
DVD Setup .....	25
VCR Setup .....	27
Other A/V Source Setup .....	29
PC Setup .....	30
USB In Setup .....	38
Audio Out Setup .....	39

## WATCHING TV / CHANNEL CONTROL

Remote Control Functions .....	40
Turning On TV .....	42
Channel Selection .....	42
Volume Adjustment .....	42
Quick Menu .....	43
Installation Guide .....	44
On-Screen Menus Selection .....	46

Channel Setup	
- Auto Scan (Auto Tuning) .....	48
- Add / Delete Channel (Manual Tuning) .....	49
- Channel Editing .....	50
Input List .....	51
Input Label .....	52
AV Mode .....	53
SimpLink .....	54

## USB

Entry Modes .....	56
Photo List .....	57
Music List .....	61

## PICTURE CONTROL

Picture Size (Aspect Ratio) Control .....	64
Preset Picture Settings	
- Picture Mode - Preset .....	66
- Color Tone - Preset .....	67
Manual Picture Adjustment	
- Picture Mode - User Mode .....	68
- Color Tone - User Mode .....	69
Picture Improvement Technology .....	70
Advanced - Black (Darkness) Level .....	71
Advanced - Eye Care .....	72
Advanced - Film Mode .....	73
Advanced - TruMotion .....	74
TruMotion Demo .....	75
Picture Reset .....	76
Power Indicator .....	77
Image Sticking Minimization (ISM) Method .....	78
Power Saving Picture Mode .....	76

## SOUND & LANGUAGE CONTROL

Auto Volume Leveller (Auto Volume) .....	80
Preset Sound Setting (Sound Mode) .....	81
Sound Setting Adjustment - User Mode .....	82
Clear Voice .....	83
Balance .....	84
TV Speakers On/Off Setup .....	85
Audio Reset .....	86
Stereo/SAP Broadcasts Setup .....	87
Audio Language .....	88
On-Screen Menus Language Selection .....	89
Caption Mode	
- Analog Broadcasting System Captions .....	90
- Digital Broadcasting System Captions .....	91
- Caption Option .....	92

## TIME SETTING

Clock Setting	
- Auto Clock Setup .....	93
- Manual Clock Setup .....	94
Auto On/Off Timer Setting .....	95
Sleep Timer Setting .....	96
Auto Shut-off Setting .....	97

## PARENTAL CONTROL / RATINGS

Set Password & Lock System .....	98
Channel Blocking .....	101
Movie & TV Rating .....	102
Downloadable Rating .....	107
External Input Blocking .....	108
Key lock .....	109

## APPENDIX

Troubleshooting .....	110
Maintenance .....	112
Product Specifications .....	113
Programming the Remote Control .....	116
IR Codes .....	119
External Control Through RS-232C .....	121

# FEATURE OF THIS TV



**SRS** is a trademark of SRS Labs, Inc. TruSurround XT technology is incorporated under license from SRS Labs, Inc.

## USB

LG TV with this logo can play MP3 music from a MP3 player, such as iPod, and JPEG images from a digital camera through the USB device.



With HDMI CEC support of LG's audio/video device connected to the HDMI (high-definition multimedia interface), LG TV with this logo works easily with one remote control.



It has three HDMI ports that connect audio and video devices with one cable and produces the highest quality digital images and sound.



It has 2 HDMI ports that connect audio and video devices with one cable and produces the highest quality digital images and sound.



Manufactured under license from Dolby Laboratories. "Dolby" and the double-D symbol are trademarks of Dolby Laboratories.



High-definition television. High-resolution digital television broadcast and playback system composed of roughly a million or more pixels, 16:9 aspect-ratio screens, and AC3 digital audio. A subset of digital television, HDTV formats include 1080i and 720p resolutions.



LG's own special digital image generator, consisting of a full digital image processor, six different main picture quality factors.

---

## FOR LCD TV

- If the TV feels cold to the touch, there may be a small "flicker" when it is turned on. This is normal, there is nothing wrong with TV.
- Some minute dot defects may be visible on the screen, appearing as tiny red, green, or blue spots. However, they have no adverse effect on the monitor's performance.
- Avoid touching the LCD screen or holding your finger(s) against it for long periods of time. Doing so may produce some temporary distortion effects on the screen.

## On Disposal

- a. The fluorescent lamp used in this product contains a small amount of mercury.
- b. Do not dispose of this product with general household waste.
- c. Disposal of this product must be carried out in accordance to the regulations of your local authority.



# PREPARATION

## ACCESSORIES

Ensure that the following accessories are included with your product. If an accessory is missing, please contact the dealer where you purchased the product.

User must use shielded signal interface cables (D-sub 15 pin cable) with ferrite cores to maintain standard compliance for the product.

The accessories can be different from the figures shown here.

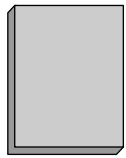

Owner's Manual



CD Manual

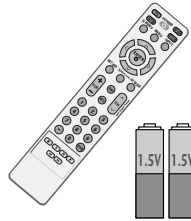

Remote Control,  
Batteries

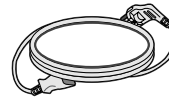

Power Cord



75ohm Round Cable

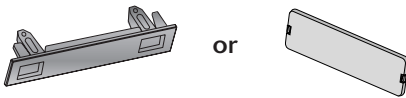

Protection Cover  
(Refer to P.19)

(This accessories can be different from the figures shown here depending on your models.)

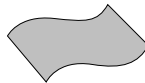

Polishing Cloth

(This feature is not available for all models.)

\* Slightly wipe stained spot on the exterior only with the polishing cloth for the product exterior if there is stain or fingerprint on surface of the exterior.

\* Do not wipe roughly when removing stain. Please be cautions of that excessive pressure may cause scratch or discoloration.

### For Plasma TV models



Cable Management Clip

### Option Extras

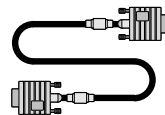

D-sub 15 pin Cable

### For LCD TV models

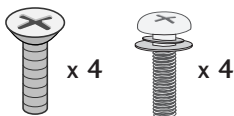

Bolts for stand assembly  
(Refer to P.15)

(Only 26/32/37/42LG30,  
37/42LG50)

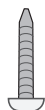

Screw for stand fixing  
(Refer to P.19)

(Only 26/32LG30,  
32LG50)

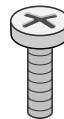

7-Bolts for stand assembly  
(Refer to P.15)

(Only 32/37/42/47/52LG60)

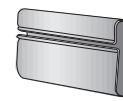

Cable Management  
Clip

# PREPARATION

## FRONT PANEL INFORMATION

- Image shown may differ from your TV
- **NOTE:** If your product has a protection tape attached, remove the tape. And then wipe the product with a cloth (If a polishing cloth is included with your product, use it).

### Plasma TV Model

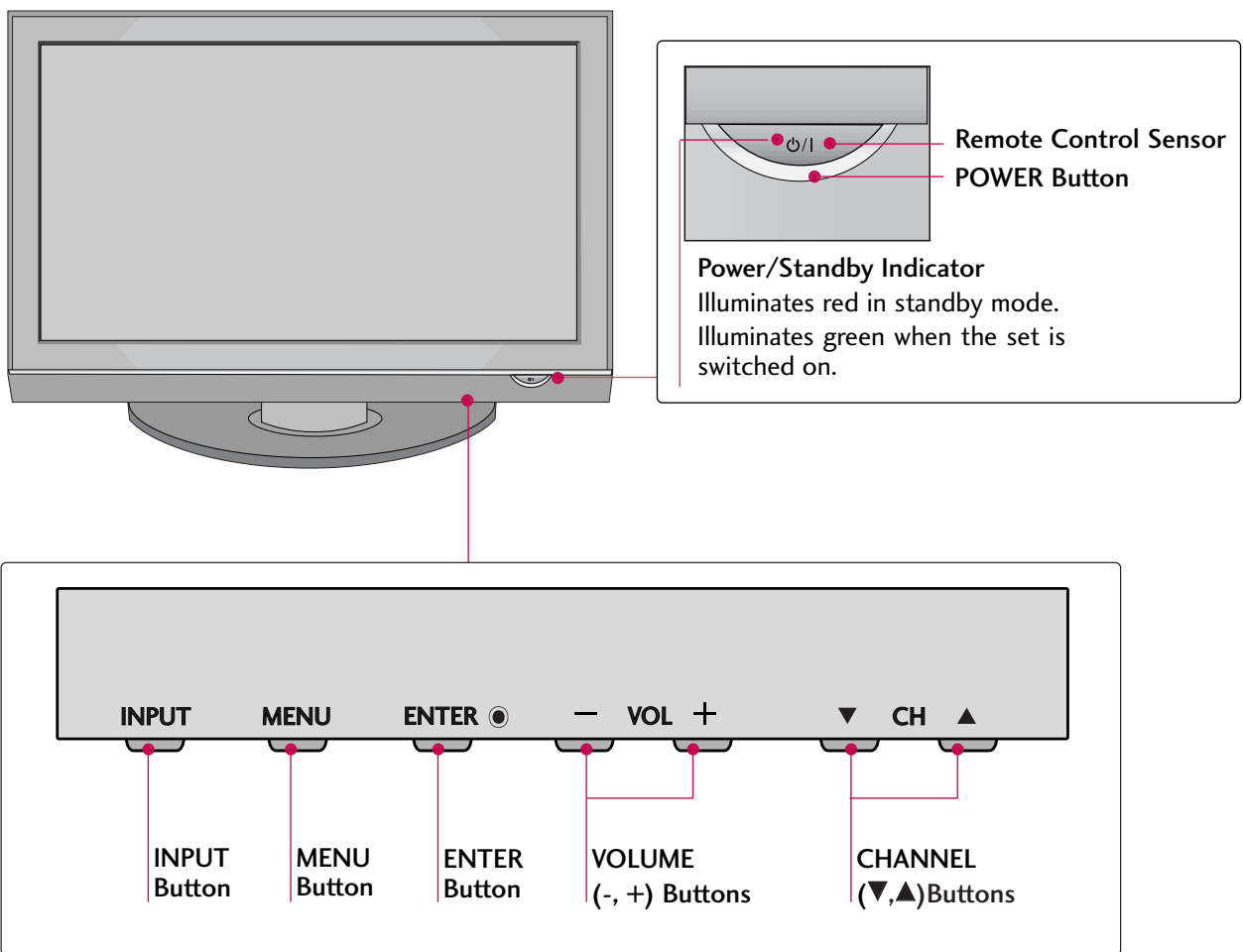

LCD TV Model

26/32/37/42/47/52LG30/50/70

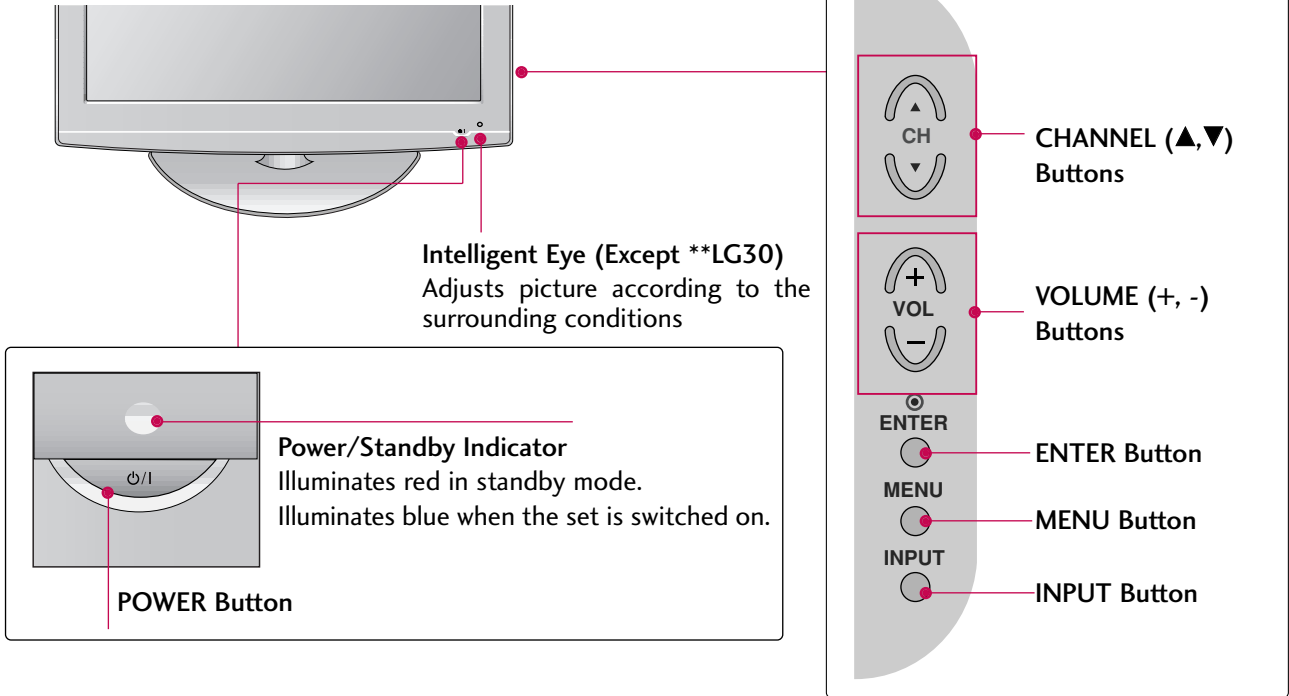

32/37/42/47/52LG60

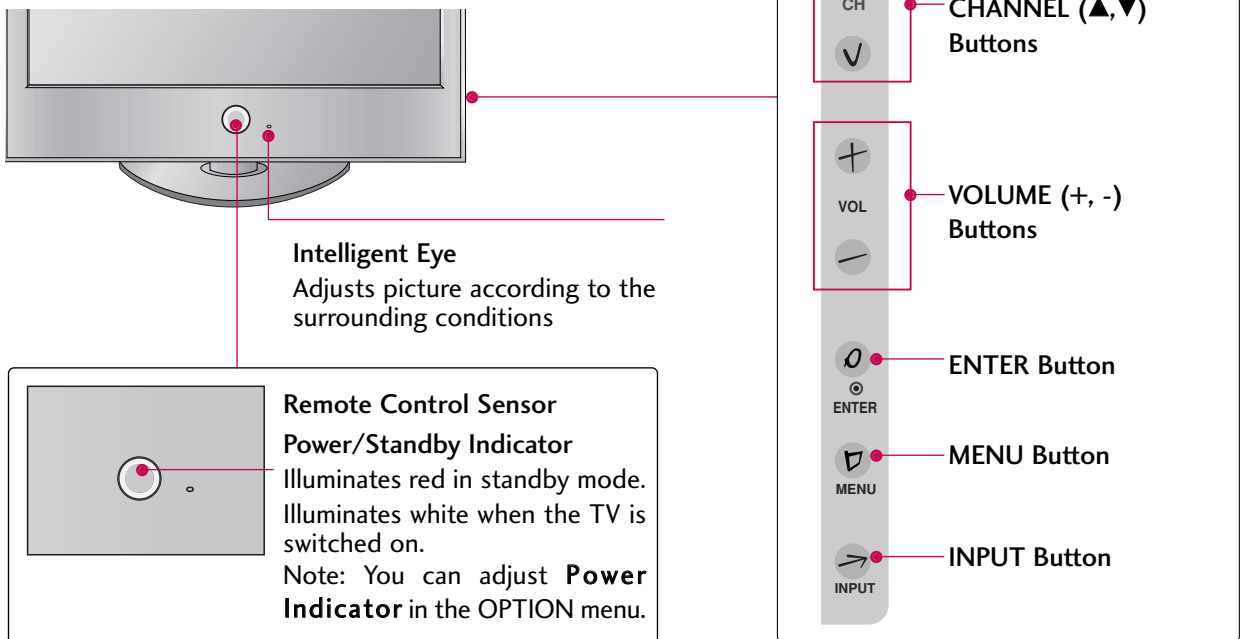

# PREPARATION

## BACK PANEL INFORMATION

■ Image shown may differ from your TV

### Plasma TV Model

PREPARATION

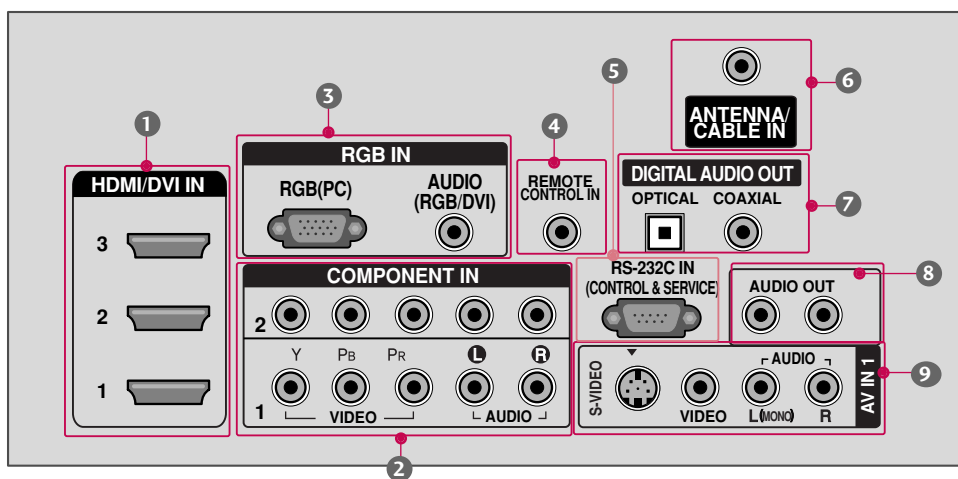
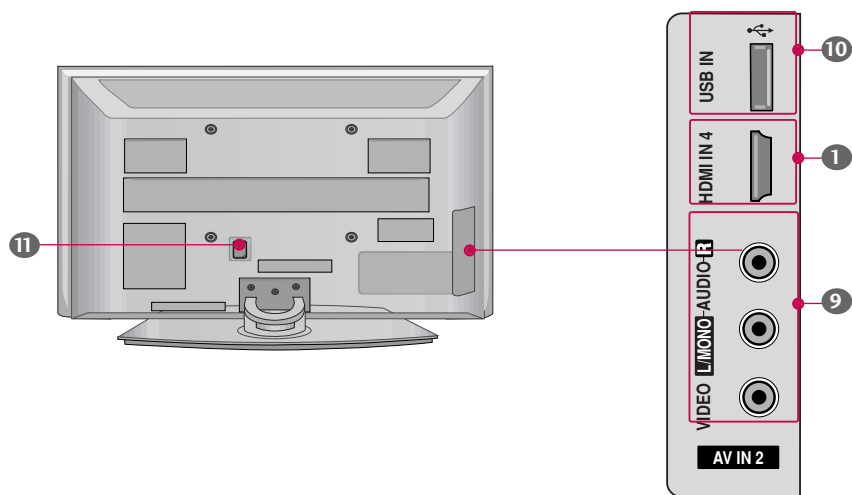

- ① **HDMI/DVI IN, HDMI IN**  
Connect a HDMI signal to HDMI port.  
Or DVI (VIDEO) signal to the HDMI port with a DVI to HDMI cable.
- ② **COMPONENT IN**  
Connect a component video/audio device to these jacks.
- ③ **RGB (PC)**  
Connect the output from a PC.  
**AUDIO (RGB/DVI)**  
Connect the audio from a PC.
- ④ **REMOTE CONTROL PORT**  
Connect your wired remote control.
- ⑤ **RS-232C IN (CONTROL & SERVICE) PORT**  
Connect to the RS-232C port on a PC.
- ⑥ **ANTENNA/CABLE IN**  
Connect over-the air signals to this jack.  
Connect cable signals to this jack.
- ⑦ **DIGITAL AUDIO OUT**  
Connect digital audio to various types of equipment.  
Note: In standby mode, these ports do not work.
- ⑧ **AUDIO OUT**  
Connect analog audio to various types of equipment.
- ⑨ **AV (Audio/Video) IN**  
Connect audio/video output from an external device to these jacks.  
**S-VIDEO**  
Connect S-Video out from an S-VIDEO device.
- ⑩ **USB INPUT**
- ⑪ **Power Cord Socket**  
For operation with AC power.  
Caution: Never attempt to operate the TV on DC power.

# PREPARATION

Image shown may differ from your TV

## LCD TV Model

PREPARATION

26/32/37/42/47/52LG30/50

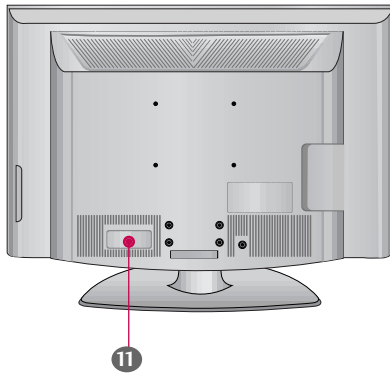

32/37/42/47/52LG60

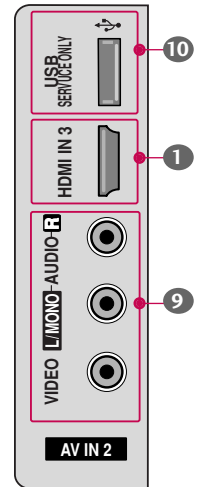
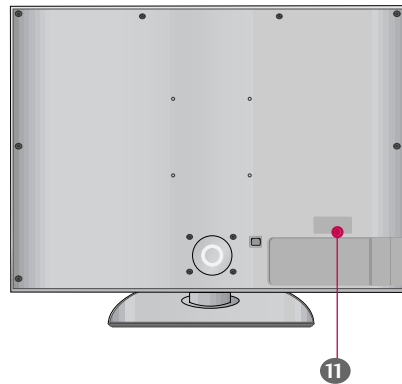

37/42/47/52LG50

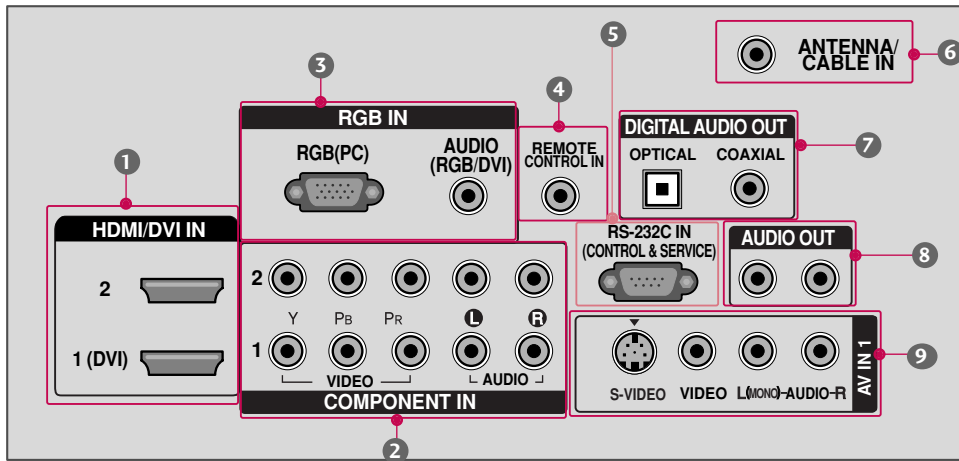

26/32/37/42LG30

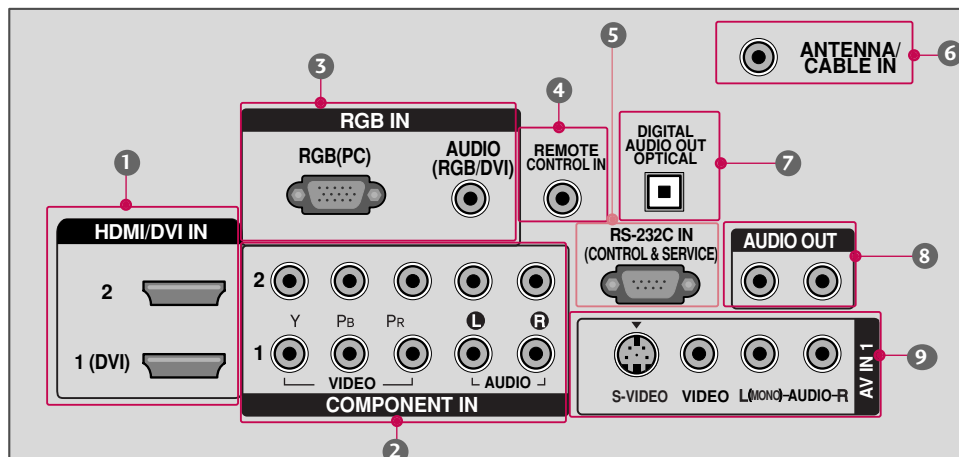

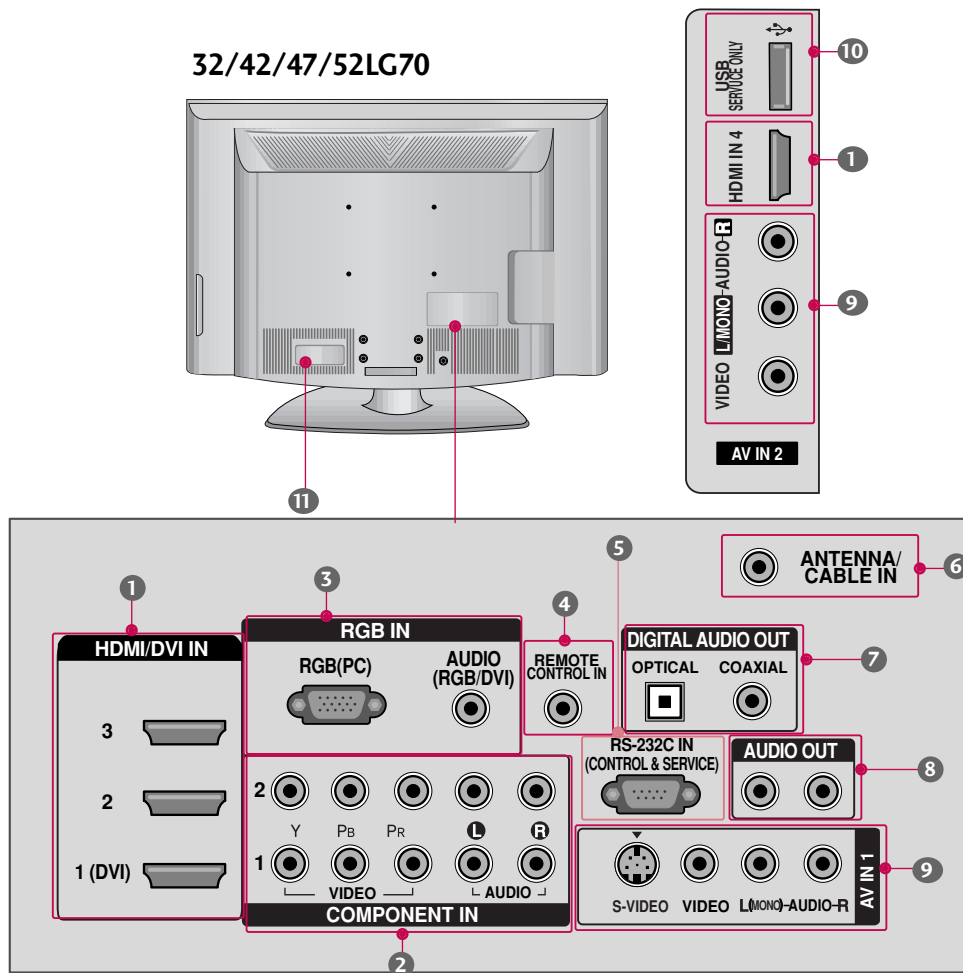

- 1 HDMI/DVI IN, HDMI IN**  
 Connect a HDMI signal to HDMI port.  
 Or DVI (VIDEO) signal to the HDMI port with a DVI to HDMI cable.
- 2 COMPONENT IN**  
 Connect a component video/audio device to these jacks.
- 3 RGB (PC)**  
 Connect the output from a PC.  
**AUDIO (RGB/DVI)**  
 Connect the audio from a PC.
- 4 REMOTE CONTROL PORT**  
 Connect your wired remote control.
- 5 RS-232C IN (CONTROL & SERVICE) PORT**  
 Connect to the RS-232C port on a PC.
- 6 ANTENNA/CABLE IN**  
 Connect over-the air signals to this jack.  
 Connect cable signals to this jack.
- 7 DIGITAL AUDIO OUT**  
 Connect digital audio to various types of equipment.  
 Note: In standby mode, these ports do not work.
- 8 AUDIO OUT**  
 Connect analog audio to various types of equipment.
- 9 AV (Audio/Video) IN**  
 Connect audio/video output from an external device to these jacks.  
**S-VIDEO**  
 Connect S-Video out from an S-VIDEO device.
- 10 USB INPUT**
- 11 Power Cord Socket**  
 For operation with AC power.  
 Caution: Never attempt to operate the TV on DC power.

# PREPARATION

## STAND INSTALLATION

■ Image shown may differ from your TV

### Plasma TV Model

#### 42PG10/20

- 1 Carefully place the TV screen side down on a cushioned surface to protect the screen from damage.

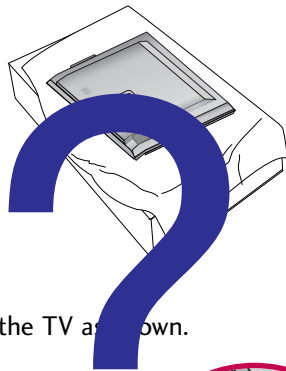

- 2 Assemble the TV stand.

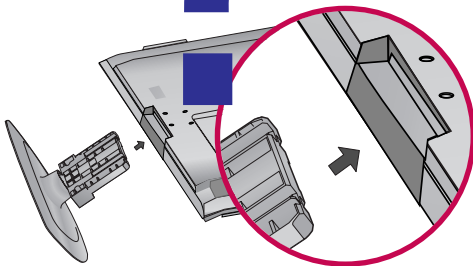

- 3 Fix the 4 bolts securely using the holes in the back of the TV



### LCD TV Model

Only 26/32/37/42LG30, 37/42LG50

- 1 Carefully place the TV screen side down on a cushioned surface to protect the screen from damage.

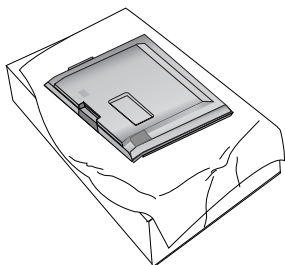

- 2 Assemble the parts of the **STAND BODY** with **COVER BASE** of the TV.

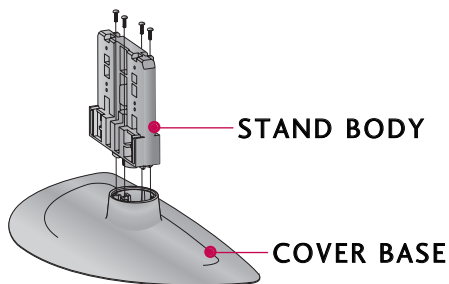

- 3 Assemble the TV as shown.

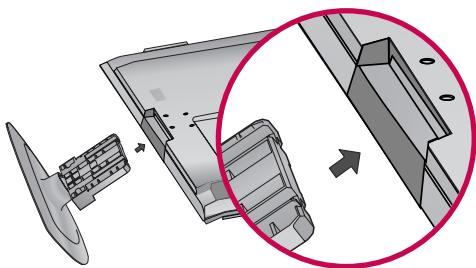

- 4 Fix the 4 bolts securely using the holes in the back of the TV

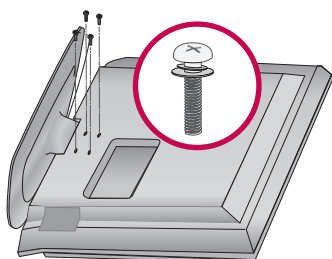

32/37/42/47/52LG60

- 1 Carefully place the TV screen side down on a cushioned surface to protect the screen from damage.

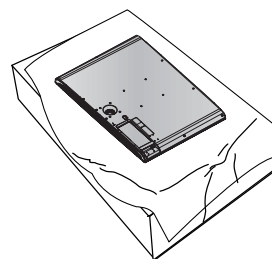

- 2 Assemble the parts of the **STAND BODY** with **COVER BASE** of the TV.

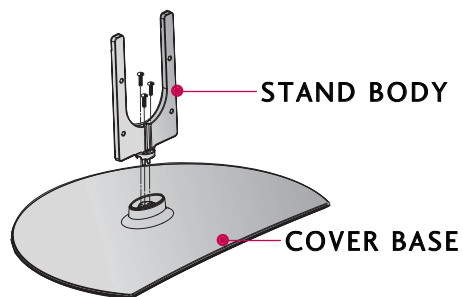

- 3 Assemble the TV as shown.

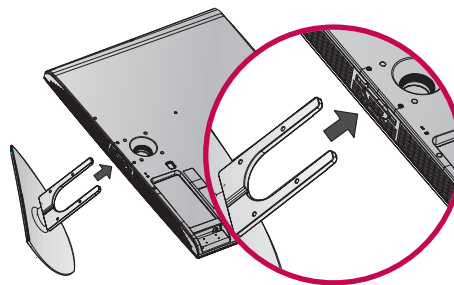

- 4 Fix the 4 bolts securely using the holes in the back of the TV

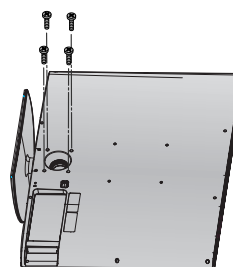

# PREPARATION

## BACK COVER FOR WIRE ARRANGEMENT

■ Image shown may differ from your TV.

### Plasma TV Model

#### 50/60PG60F

- 1 Connect the cables as necessary.  
To connect an additional equipment, see the **EXTERNAL EQUIPMENT SETUP** section.

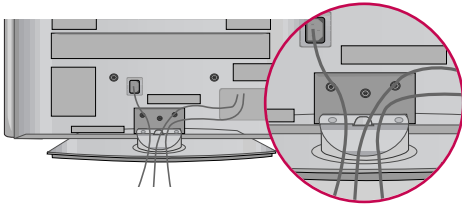

- 2 Install the **CABLE MANAGEMENT CLIP** as shown and manage the cable.

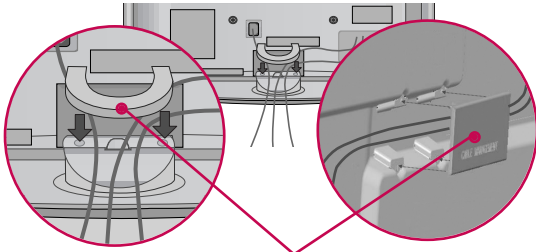

CABLE MANAGEMENT CLIP

### How to remove the CABLE MANAGEMENT CLIP

- ▶ Hold the **CABLE MANAGEMENT CLIP** with both hands and pull it backward.

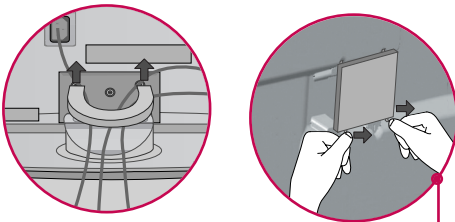

Separate **CABLE MANAGEMENT CLIP** from TV by pressing two latches.

### ! NOTE

- ▶ Do not hold the **CABLE MANAGEMENT CLIP** when moving the TV.  
- If the TV is dropped, you may be injured or the product may be broken.

#### 42/50PG10/20

- 1 Arrange the cables as shown.

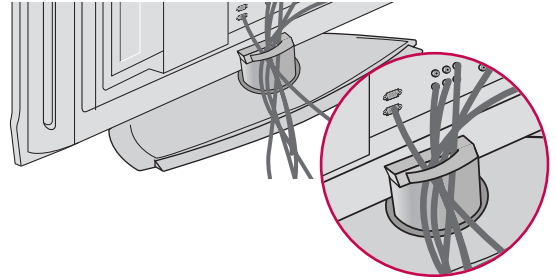

**LCD TV Model**

**26/32/37/42/47/52LG30/50/70**

- 1 Connect the cables as necessary.  
To connect an additional equipment, see the **EXTERNAL EQUIPMENT SETUP** section.

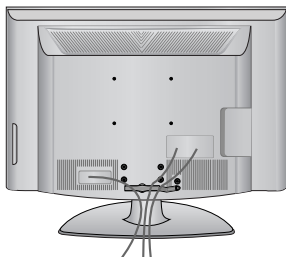

- 2 Install the **CABLE MANAGEMENT CLIP** as shown and manage the cable.

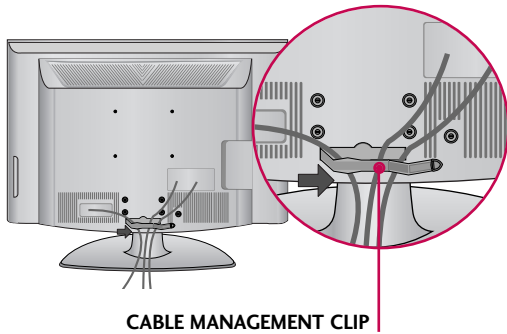

- 3 Fit the **CABLE MANAGEMENT CLIP** as shown.

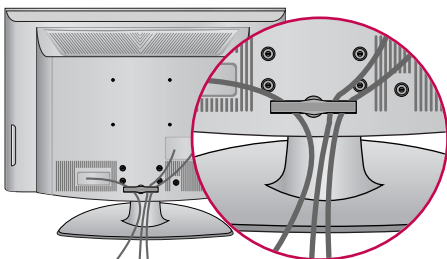

**32/37/42/47/52LG60**

- 1 Connect the cables as necessary.  
To connect an additional equipment, see the **EXTERNAL EQUIPMENT SETUP** section of the manual.

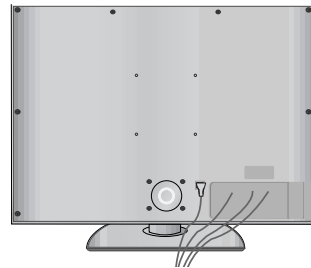

- 2 Bundle the cables together using the supplied **CABLE MANAGEMENT CLIP**.

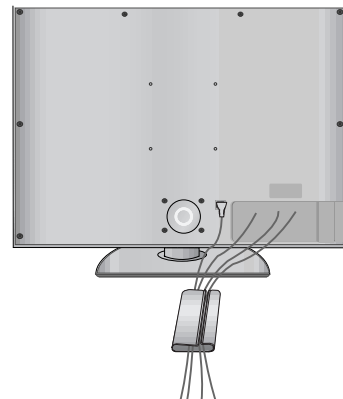

# PREPARATION

PREPARATION

## DESKTOP PEDESTAL INSTALLATION

Image shown may differ from your TV.

For proper ventilation, allow a clearance of 4 inches on all four sides from the wall.

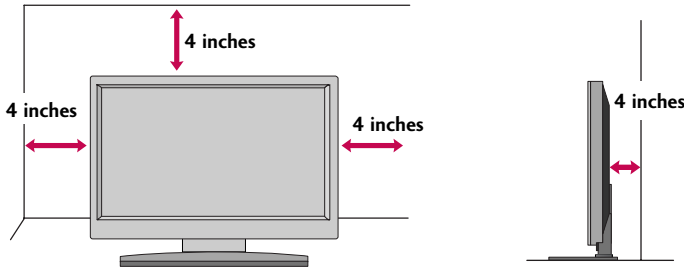

## VESA WALL MOUNTING

This product accepts a VESA-compliant mounting interface pad. (optional)  
There 4 threaded holes are available for attaching the bracket.

### Plasma TV Model

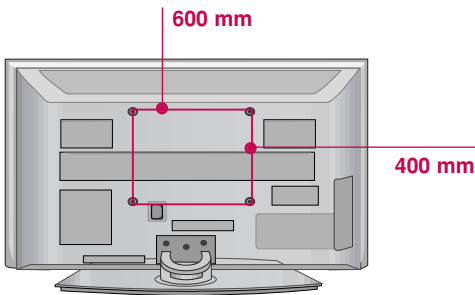

### LCD TV Model

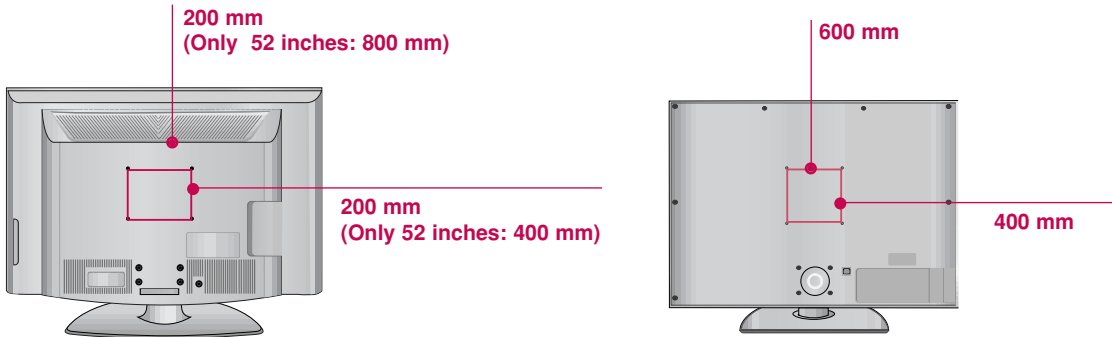

### NOTE

► Screw length needed depends on the wall mount used. For further information, refer to the VESA Wall Mounting Instruction Guide.

## SWIVEL STAND

After installing the TV, you can adjust the TV set manually to the left or right direction by 20 degrees to suit your viewing position.

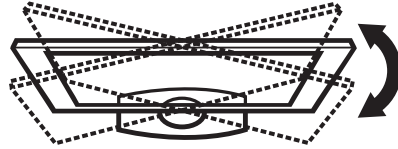

## NOT USING THE DESK-TYPE STAND

When installing the wall-mounted unit, use the protection cover for desk-type stand installation.

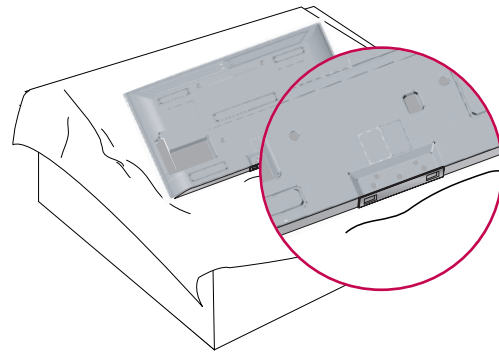

## ATTACHING THE TV TO A DESK (Only 26/32LG30, 32LG50)

The TV must be attached to a desk so it cannot be pulled in a forward/backward direction, potentially causing injury or damaging the product.

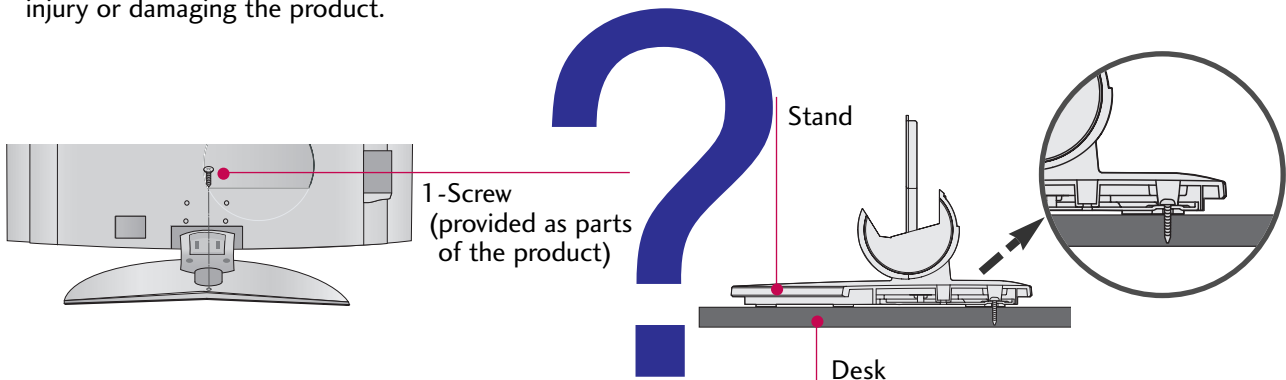

### ⚠ WARNING

- ▶ This apparatus must be securely attached to the floor/wall per installation instructions. Tipping, shaking, or rocking the machine may cause injury/death.

# PREPARATION

## PLEASE SET IT UP CAREFULLY SO THE PRODUCT DOESN'T FALL OVER.

- You should purchase necessary components to prevent TV from falling off of the stand.
- Image shown may differ from your TV.

We recommend that you set up the TV close to a wall so it cannot fall over if pushed backwards. Additionally, we recommend that the TV be attached to a wall so it cannot be pulled in a forward direction, potentially causing injury or damaging the product.

Caution: Please make sure that children don't climb on or hang from the TV.

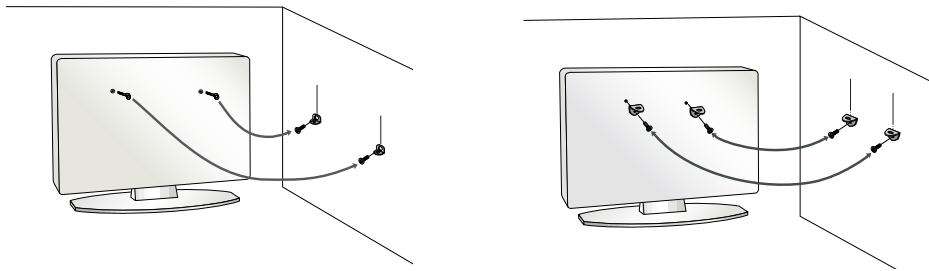

- Insert the eye-bolts (or TV brackets and bolts) to tighten the product to the wall as shown in the picture.

\* If your product has the bolts in the eye-bolts position before inserting the eye-bolts, loosen the bolts.

\* Insert the eye-bolts or TV brackets/bolts and tighten them securely in the upper holes.

Secure the wall brackets with the bolts (not provided as parts of the product, must purchase separately) to the wall. Match the height of the bracket that is mounted on the wall to the holes in the product.

Ensure the eye-bolts or brackets are tightened securely.

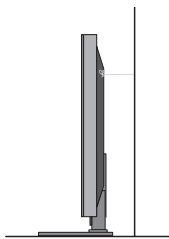

- Use a sturdy rope (not provided as parts of the product, must purchase separately) to tie the product. It is safer to tie the rope so it becomes horizontal between the wall and the product.

### ! NOTE

- ▶ When moving the TV, undo the cords first.
- ▶ Use a platform or cabinet strong and large enough to support the size and weight of the TV
- ▶ To use the TV safely make sure that the height of the bracket on the wall and on the TV is the same.

# ANTENNA OR CABLE CONNECTION

■ Image shown may differ from your TV.

## 1. Antenna (Analog or Digital)

Wall Antenna Socket or Outdoor Antenna without a Cable Box Connections.

For optimum picture quality, adjust antenna direction if needed.

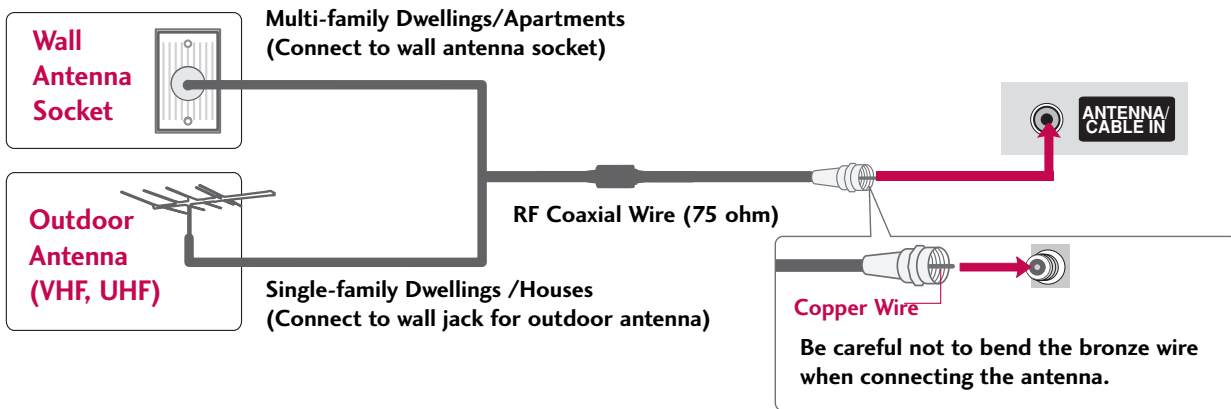

## 2. Cable

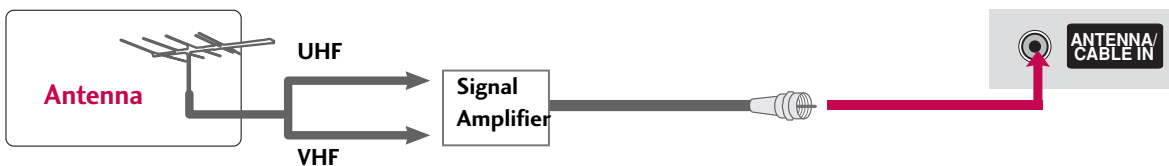
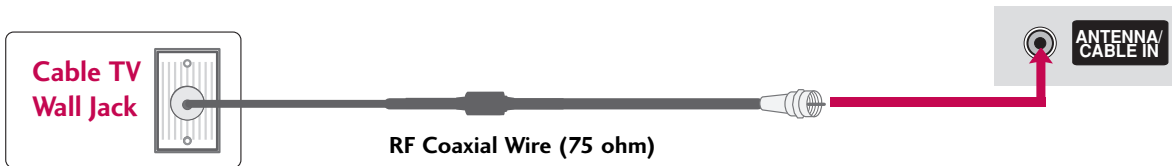

- To improve the picture quality in a poor signal area, please purchase a signal amplifier and install properly.
- If the antenna needs to be split for two TV's, install a 2-Way Signal Splitter.
- If the antenna is not installed properly, contact your dealer for assistance.

**NOTE** ▶ The TV will let you know when the analog, cable, and digital channel scans are complete.

# EXTERNAL EQUIPMENT SETUP

- To prevent the equipment damage, never plug in any power cords until you have finished connecting all equipment.
- This part of EXTERNAL EQUIPMENT SETUP mainly use picture for 37/42/47/52LG50 models.

## HD RECEIVER SETUP

This TV can receive Digital Over-the-air/Cable signals without an external digital set-top box. However, if you do receive digital signals from a digital set-top box or other digital external device, refer to the figure as shown below.

### When connecting Component cable

#### 1. How to connect

- 1 Connect the video outputs (Y, PB, PR) of the digital set top box to the **COMPONENT IN VIDEO 1** jacks on the set. Match the jack colors (Y = green, PB = blue, and PR = red).
- 2 Connect the audio output of the digital set-top box to the **COMPONENT IN AUDIO 1** jacks on the set.

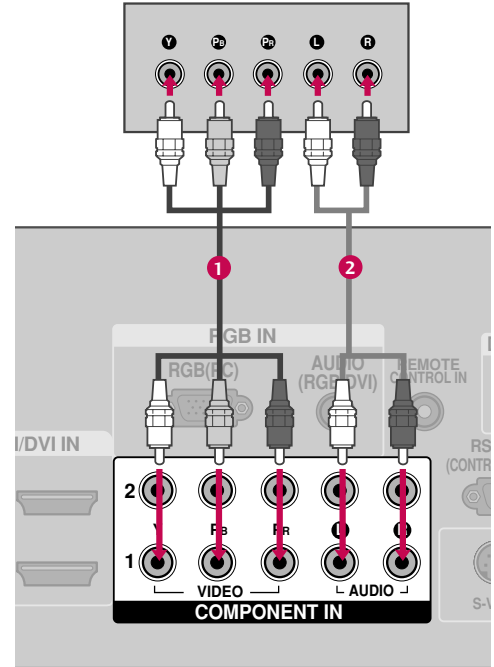

#### 2. How to use

- Turn on the digital set-top box.  
(Refer to the owner's manual for the digital set-top box. operation)
- Select **Component 1** input source by using the **INPUT** button on the remote control.
- If connected to **COMPONENT IN2** input, select **Component 2** input source.

Signal	Component	HDMI
480i	Yes	No
480p	Yes	Yes
720p	Yes	Yes
1080i	Yes	Yes
1080p	Yes	Yes

Y, Cb/PB, Cr/PR

Resolution	Horizontal Frequency(KHz)	Vertical Frequency(Hz)
720x480i	15.73	59.94
	15.73	60.00
720x480p	31.47	59.94
	31.50	60.00
1280x720p	44.96	59.94
	45.00	60.00
1920x1080i	33.72	59.94
	33.75	60.00
1920x1080p	26.97	23.976
	27.00	24.00
	33.71	29.97
	33.75	30.00
	67.432	59.94
	67.50	60.00



## When connecting HDMI cable

### 1. How to connect

- 1 Connect the digital set-top box to **HDMI/DVI IN1**, **2**, **3** or **4** jack on the set.
- 2 No separated audio connection is necessary. HDMI supports both audio and video.

### 2. How to use

- Turn on the digital set-top box.  
(Refer to the owner's manual for the digital set-top box.)
- Select **HDMI1**, **HDMI2**, **HDMI3**, or **HDMI4** input source with using the **INPUT** button on the remote control.

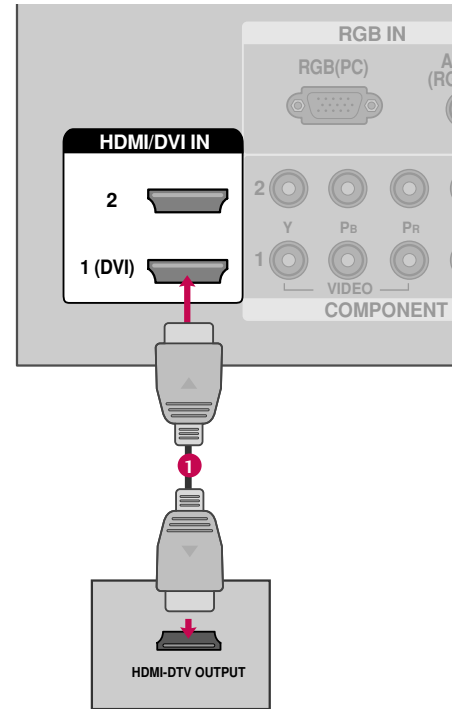

#### HDMI-DTV

Resolution	Horizontal Frequency(KHz)	Vertical Frequency(Hz)
720x480p	31.47	59.94
	31.50	60.00
1280x720p	44.96	59.94
	45.00	60.00
1920x1080i	33.72	59.94
	33.75	60.00
1920x1080p	26.97	23.976
	27.00	24.00
	33.71	29.97
	33.75	30.00
	67.432	59.939
	67.50	60.00

# EXTERNAL EQUIPMENT SETUP

## When connecting HDMI to DVI cable

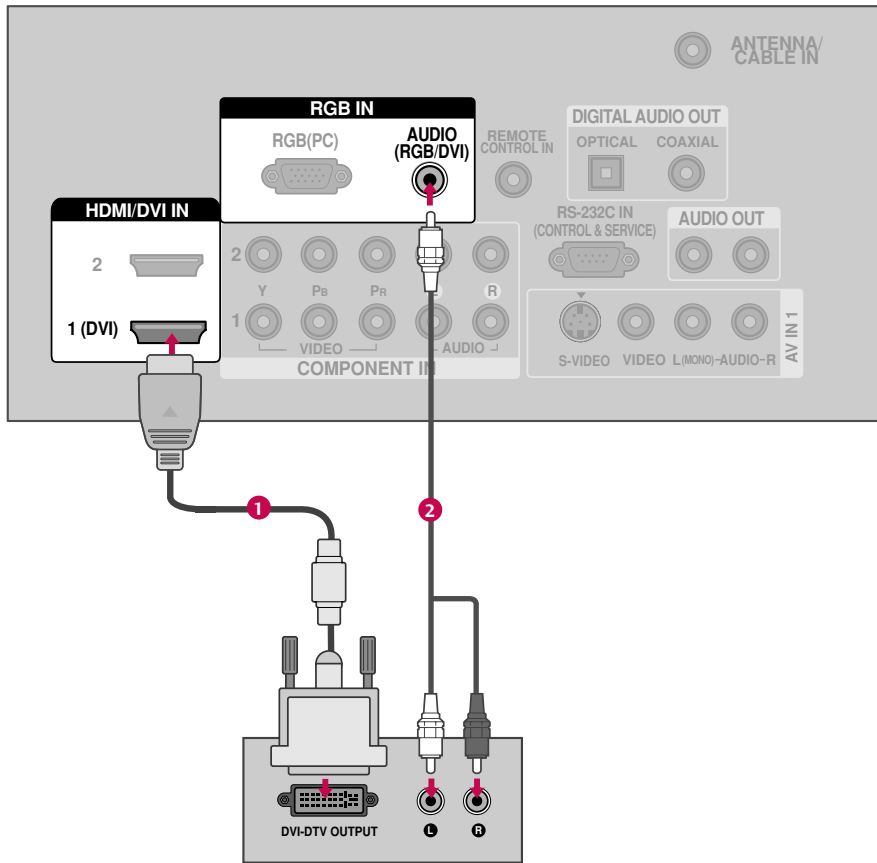

### 1. How to connect

- 1 Connect the DVI output of the digital set-top box to the **HDMI/DVI IN1 (DVI)** jack on the set.
- 2 Connect the audio output of the digital set-top box to the **AUDIO (RGB/DVI)** jack on the set.

### 2. How to use

- Turn on the digital set-top box. (Refer to the owner's manual for the digital set-top box.)
- Select **HDMI1** input source with using the **INPUT** button on the remote control.

# DVD SETUP

## When connecting Component cable

### 1. How to connect

- 1 Connect the video outputs (Y, PB, PR) of the DVD to the **COMPONENT IN VIDEO1** jacks on the set. Match the jack colors (Y = green, PB = blue, and PR = red).
- 2 Connect the audio outputs of the DVD to the **COMPONENT IN AUDIO1** jacks on the set.

### 2. How to use

- Turn on the DVD player, insert a DVD.
- Select **Component 1** input source by using the **INPUT** button on the remote control.
- If connected to **COMPONENT IN 2** input, select **Component 2** input source.
- Refer to the DVD player's manual for operating instructions.

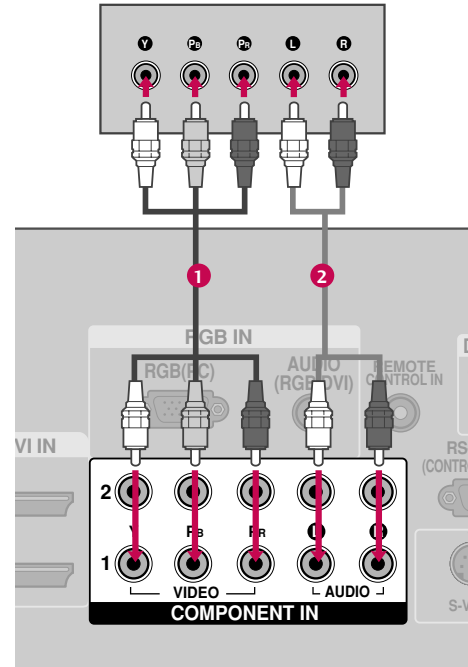

### Component Input ports

To get better picture quality, connect a DVD player to the component input ports as shown below.

Component ports on the TV	Y	P <sub>B</sub>	P <sub>R</sub>
Video output ports on DVD player	Y	P <sub>B</sub>	P <sub>R</sub>
	Y	B-Y	R-Y
	Y	C <sub>b</sub>	C <sub>r</sub>
	Y	P <sub>b</sub>	P <sub>r</sub>

# EXTERNAL EQUIPMENT SETUP

## When connecting with an S-Video cable

### 1. How to connect

- 1 Connect the S-VIDEO output of the DVD to the S-VIDEO input on the set.
- 2 Connect the audio outputs of the DVD to the AUDIO input jacks on the set.

### 2. How to use

- Turn on the DVD player, insert a DVD.
- Select **AV1** input source by using the **INPUT** button on the remote control.
- Refer to the DVD player's manual for operating instructions.

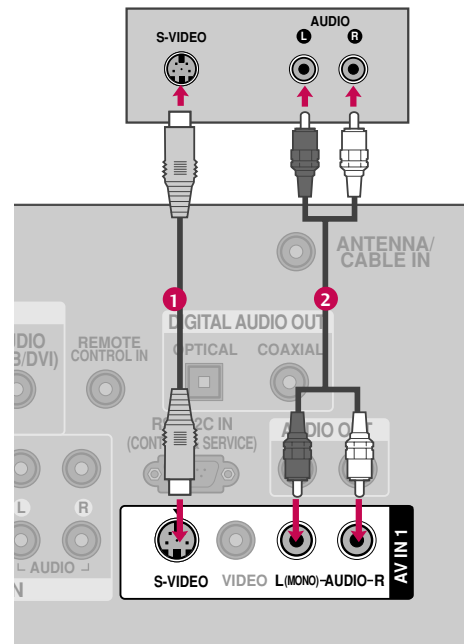

## When connecting HDMI cable

### 1. How to connect

- 1 Connect the HDMI output of the DVD to the HDMI/DVI IN1, 2, 3 or 4 jack on the set.
- 2 No separated audio connection is necessary. HDMI supports both audio and video.

### 2. How to use

- Select **HDMI1**, **HDMI2**, **HDMI3**, or **HDMI4** input source by using the **INPUT** button on the remote control.
- Refer to the DVD player's manual for operating instructions.

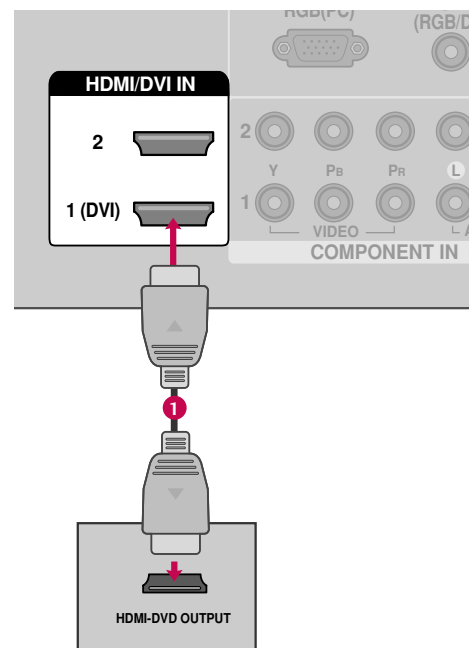

## VCR SETUP

- To avoid picture noise (interference), leave an adequate distance between the VCR and TV.
- Use the ISM feature in the Option menu to avoid having a fixed image remain on the screen for a long period of time (Only Plasma TV model). If the 4:3 picture format is used; the fixed images on the sides of the screen may remain visible on the screen. This phenomenon is common to all manufactures and in consequence the manufactures warranty does not cover the product bearing this phenomenon.

### When connecting with an antenna

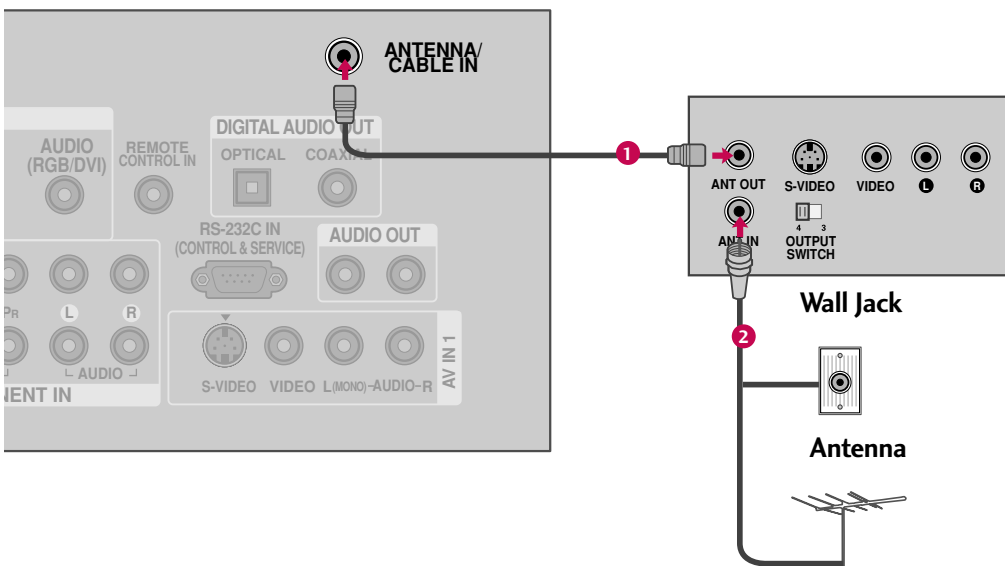

### 1. How to connect

- 1 Connect the RF antenna out socket of the VCR to the **ANTENNA/CABLE IN** socket on the set.
- 2 Connect the antenna cable to the RF antenna in socket of the VCR.

### 2. How to use

- Set VCR output switch to 3 or 4 and then tune TV to the same channel number.
- Insert a video tape into the VCR and press PLAY on the VCR. (Refer to the VCR owner's manual.)

# EXTERNAL EQUIPMENT SETUP

## When connecting with a RCA cable

### 1. How to connect

- 1 Connect the **AUDIO/VIDEO** jacks between TV and VCR. Match the jack colors (Video = yellow, Audio Left = white, and Audio Right = red)

### 2. How to use

- Insert a video tape into the VCR and press PLAY on the VCR. (Refer to the VCR owner's manual.)
- Select **AV1** input source by using the **INPUT** button on the remote control.
- If connected to **AV IN2**, select **AV2** input source.

**NOTE** ▶ If you have a mono VCR, connect the audio cable from the VCR to the **AUDIO L/MONO** jack of the set.

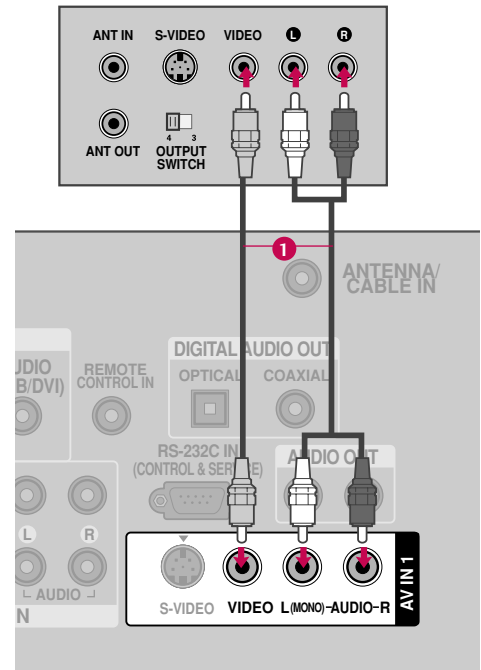

## When connecting with an S-Video cable

### 1. How to connect

- 1 Connect the S-VIDEO output of the VCR to the **S-VIDEO** input on the set.
- 2 Connect the audio outputs of the VCR to the **AUDIO** input jacks on the set.

### 2. How to use

- Insert a video tape into the VCR and press PLAY on the VCR. (Refer to the VCR owner's manual.)
- Select **AV1** input source by using the **INPUT** button on the remote control.

**NOTE** ▶ The picture quality is improved: compared to normal composite (RCA cable) input.

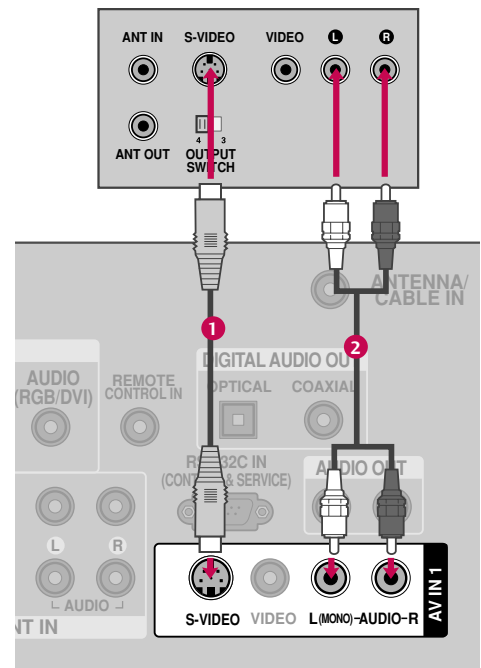

**CAUTION** ▶ Do not connect to both Video and S-Video at the same time. In the event that you connect both Video and the S-Video cables, only the S-Video will work.

# OTHER A/V SOURCE SETUP

## 1. How to connect

- 1 Connect the **AUDIO/VIDEO** jacks between TV and external equipment. Match the jack colors. (Video = yellow, Audio Left = white, and Audio Right = red)

## 2. How to use

- Select **AV2** input source by using the **INPUT** button on the remote control.
- If connected to **AV IN1** input, select **AV1** input source.
- Operate the corresponding external equipment.

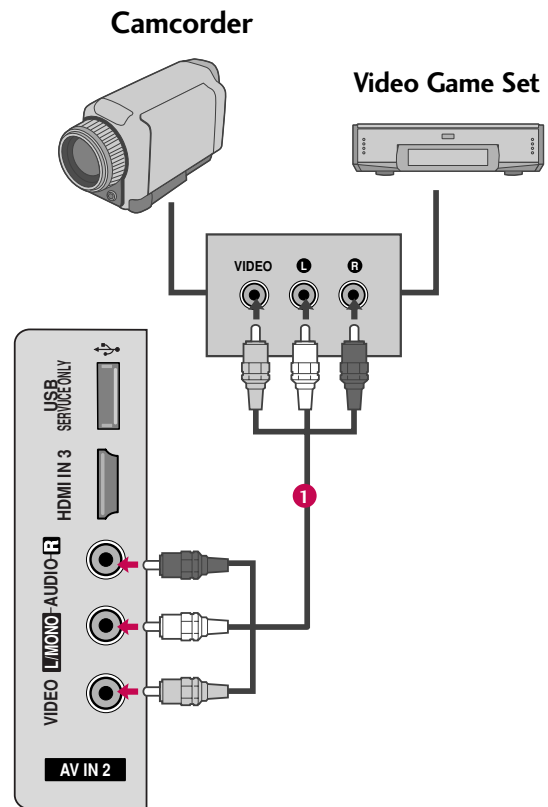

# EXTERNAL EQUIPMENT SETUP

## PC SETUP

This TV provides Plug and Play capability, meaning that the PC adjusts automatically to the TV's settings.

### When connecting D-sub 15 pin cable

#### 1. How to connect

- 1 Connect the RGB output of the PC to the **RGB (PC)** jack on the set.
- 2 Connect the PC audio output to the **AUDIO (RGB/DVI)** jack on the set.

#### 2. How to use

- Turn on the PC and the TV.
- Select **RGB-PC** input source by using the **INPUT** button on the remote control.

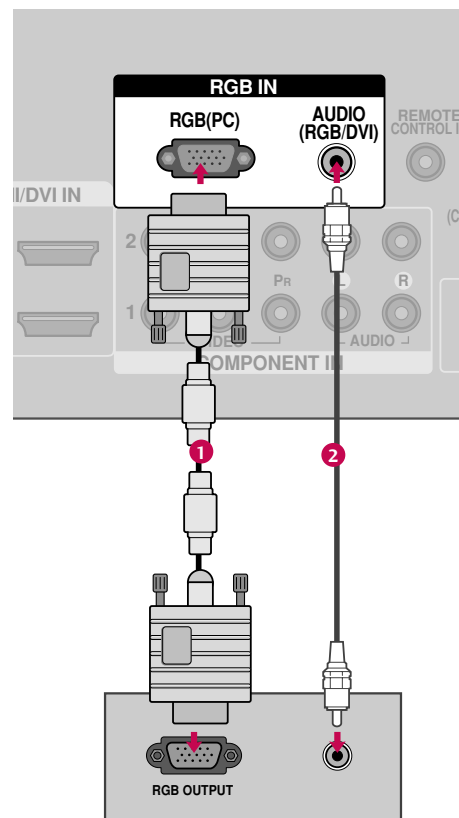



## When connecting HDMI to DVI cable

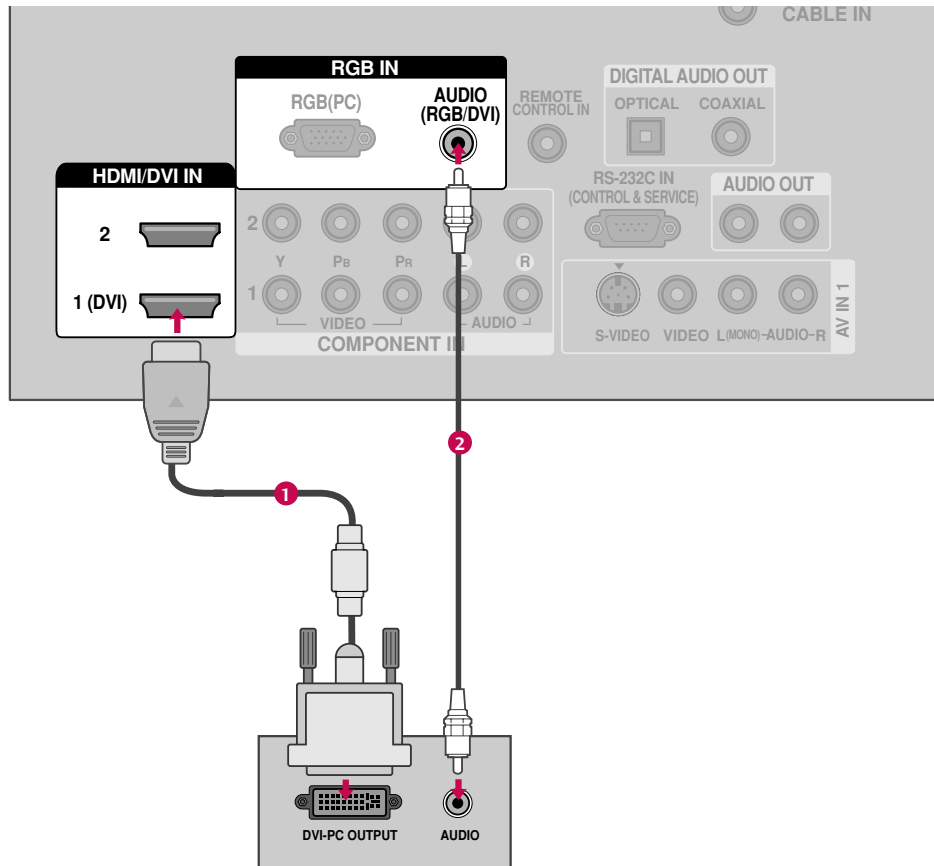

### 1. How to connect

- 1 Connect the DVI output of the PC to the **HDMI/DVI IN1 (DVI)** jack on the set.
- 2 Connect the PC audio output to the **AUDIO (RGB/DVI)** jack on the set.

### 2. How to use

- Turn on the PC and the TV.
- Select **HDMI1** input source with using the **INPUT** button on the remote control.

# EXTERNAL EQUIPMENT SETUP

## ! NOTES

- ▶ For LCD TV: To get the the best picture quality, adjust the PC graphics card to 1366x768.
- ▶ For Plasma TV: To get the the best picture quality, adjust the PC graphics card to 1360x768.
- ▶ Depending on the graphics card, DOS mode may not work if a HDMI to DVI Cable is in use.
- ▶ Check the image on your TV. There may be noise associated with the resolution, vertical pattern, contrast or brightness in PC mode. If noise is present, change the PC output to another resolution, change the refresh rate to another rate or adjust the brightness and contrast on the PICTURE menu until the picture is clear. If the refresh rate of the PC graphic card can not be changed, change the PC graphic card or consult the manufacturer of the PC graphic card.
- ▶ Avoid keeping a fixed image on the screen for a long period of time. The fixed image may become permanently imprinted on the screen.
- ▶ The synchronization input form for Horizontal and Vertical frequencies is separate.

## Supported Display Specifications

**For 26/32/37/42LG30, 42/50PG10, 42/50PG20**

RGB-PC, HDMI-PC

Resolution	Horizontal Frequency(KHz)	Vertical Frequency(Hz)	
640x350	31.469	70.08	* Only RGB-PC mode
720x400	31.469	70.08	
640x480	31.469	59.94	
800x600	37.879	60.31	
1024x768	48.363	60.00	
1280x768	47.776	59.87	
1360x768	47.720	59.799	
1366x768	47.130	59.65	* Only LCD TV

## Supported Display Specifications

For 37/42/47/52LG50, 32/37/42/47/52LG60  
32/42/47/52LG70, 50/60PG60F

RGB-PC, HDMI-PC

Resolution	Horizontal Frequency(KHz)	Vertical Frequency(Hz)
640x350	31.468	70.09
720x400	31.469	70.08
640x480	31.469	59.94
	37.500	75.00
	37.861	72.80
800x600	35.156	56.25
	37.879	60.31
	46.875	75.00
	48.077	72.18
1024x768	48.363	60.00
	56.476	70.06
	60.023	75.02
1280x768	47.776	59.87
	60.289	74.893
* RGB-PC mode only		
1280x1024	63.981	60.02
	79.976	75.025
1360x768	47.712	60.015
1600x1200	75.00	60.00
1920x1080	66.587	59.934

### ! NOTE

- ▶ Depending on graphic card and signal status, there can be some shaking to find best picture in a little time.

# EXTERNAL EQUIPMENT SETUP







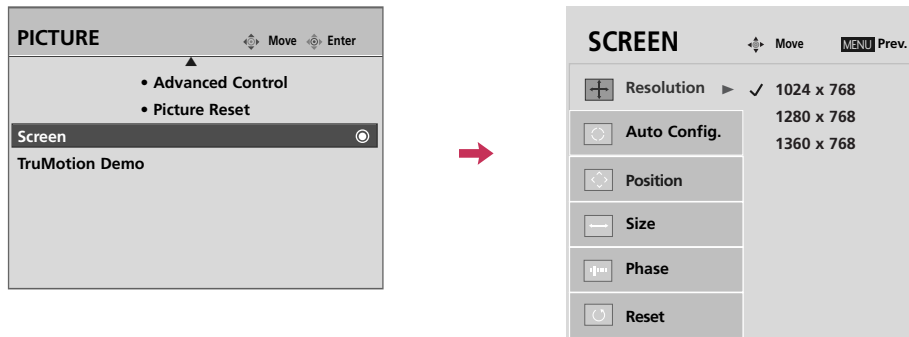

## Screen Setup for PC mode

### Selecting Resolution

When you change the resolution, select the proper resolution in present input to see the best picture appearance. XGA (1024, 1280, 1360) isn't distinguished because of having the same H/V Sync Time. This function is you to select the Default Sync Time.

This feature operates only in RGB-PC mode.



-   Select **PICTURE**.
-   Select **SCREEN**.
-   Select **Resolution**.
-   Select the desired resolution.
-  Return to the previous menu.

## Auto Configure

Automatically adjusts picture position and minimizes image instability. After adjustment, if the image is still not correct, your TV is functioning properly but needs further adjustment.

### Auto configure

This function is for automatic adjustment of the screen position, clock, and phase. The displayed image will be unstable for a few seconds while the auto configuration is in progress.



1   Select **PICTURE**.

2   Select **SCREEN**.

3   Select **Auto Config.**

4   Select **Yes**.

5  Start Auto Configuration.

- If the position of the image is still not correct, try Auto adjustment again.
- If picture needs to be adjusted again after Auto adjustment in RGB-PC, you can adjust the **Position**, **Size** or **Phase**.





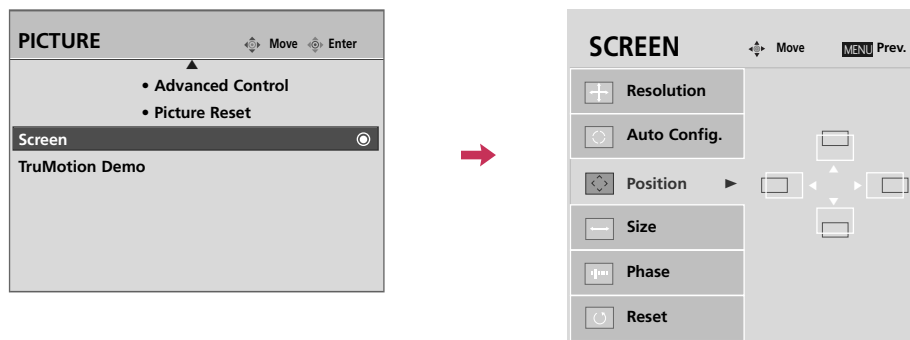

# PREPARATION

## Adjustment for screen Position, Size, and Phase

If the picture is not clear after auto adjustment and especially if characters are still trembling, adjust the picture phase manually.

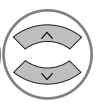
This feature operates only in RGB-PC mode.

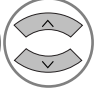



-   Select **PICTURE**.
-   Select **SCREEN**.
-   Select **Position, Size, or Phase**.
-   Make appropriate adjustments.

- **Position:** This function is to adjust picture to left/right and up/down as you prefer.
- **Size:** This function is to minimize any vertical bars or stripes visible on the screen background. And the horizontal screen size will also change. The **Size** adjustment range is **-30 ~ +30**.
- **Phase:** This function allows you to remove any horizontal noise and clear or sharpen the image of characters. The **Phase** adjustment range is **-16 ~ +16**.

## Screen Reset (Reset to original factory values)

Returns to the default settings Resolution, Auto Config., Position, Size and Phase at the factory.

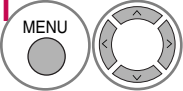
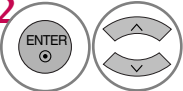
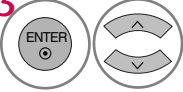
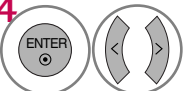

- 1  Select **PICTURE**.
- 2  Select **SCREEN**.
- 3  Select **Reset**.
- 4  Select **Yes**.
- 5 

# EXTERNAL EQUIPMENT SETUP

## USB IN SETUP

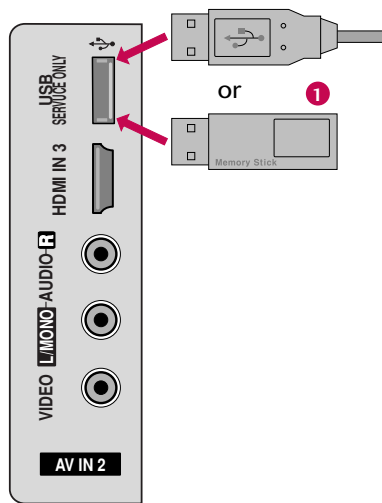

### 1. How to connect

---

- 1 Connect the USB device to the **USB SERVICE ONLY** jack on the side of TV.
- 

### 2. How to use

- After connecting the **USB** jack, you use the USB function.  
(▶ p.56)



# AUDIO OUT SETUP

Send the TV's audio to external audio equipment via the Audio Output port.

## Analog

### 1. How to connect

- 1 Connect audio outputs to the TV's **AUDIO OUT** jacks.
- 2 Set the "TV Speaker option - Off" in the AUDIO menu. (▶ p.85). See the external audio equipment instruction manual for operation.

## Digital

### 1. How to connect

- 1 Connect one end of the optical or coaxial cable to the TV's **OPTICAL** or **COAXIAL** (Except \*\*LG30) port of **DIGITAL AUDIO OUT**.
- 2 Connect the other end of the optical or coaxial cable to the digital audio input on the audio equipment.
- 3 Set the "TV Speaker option - Off" in the AUDIO menu. (▶ p.85). See the external audio equipment instruction manual for operation.

#### ! NOTE

- ▶ When connecting with external audio equipments, such as amplifiers or speakers, please turn the TV speakers off. (▶ p.85)

#### ! CAUTION

- ▶ Do not look into the optical output port. Looking at the laser beam may damage your vision.
- ▶ Block the SPDIF out (optical/coaxial) about the contents with ACP(Audio Copy Protection) function.

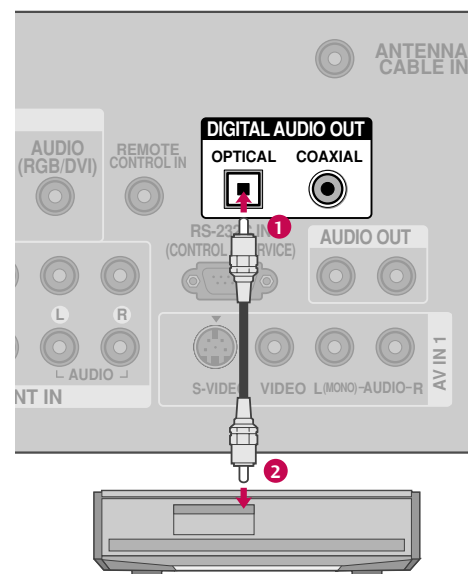
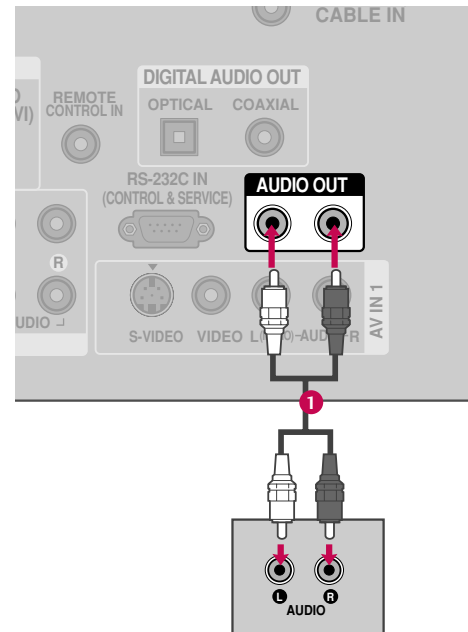

# WATCHING TV / CHANNEL CONTROL

## REMOTE CONTROL FUNCTIONS

When using the remote control, aim it at the remote control sensor on the TV.

**TV/STB/DVD/VCR** Select the remote operating mode: TV, STB, DVD, or VCR.  
\* If the mode of another product is selected, a button on the remote control which is not used for the selected product can control the TV.

**POWER** Turns your TV or any other programmed equipment on or off, depending on the mode.

**Q.MENU** Select the desired quick menu source. ▶ p.43

**MENU** Displays the main menu.

**INPUT** External input modes rotate in regular sequence

**VOLUME UP /DOWN** Increase/decrease the sound level.

**FAV** Scroll through the programmed Favorite channels. ▶ p.43

**MUTE** Switch the sound on or off. ▶ p.42

**CHANNEL UP/DOWN** Select available channels.

**PAGE UP/DOWN** Move from one full set of screen information to the next one.

**NUMBER button**

**— (DASH)** Used to enter a program number for multiple program channels such as 2-1, 2-2, etc.

**BACK** Tune to the last channel viewed.

**VCR/DVD buttons**

- Control video cassette recorders or DVD players.
- Control USB menu (PHOTO LIST and MUSIC LIST.)
- Control the SIMPLINK compatible devices.

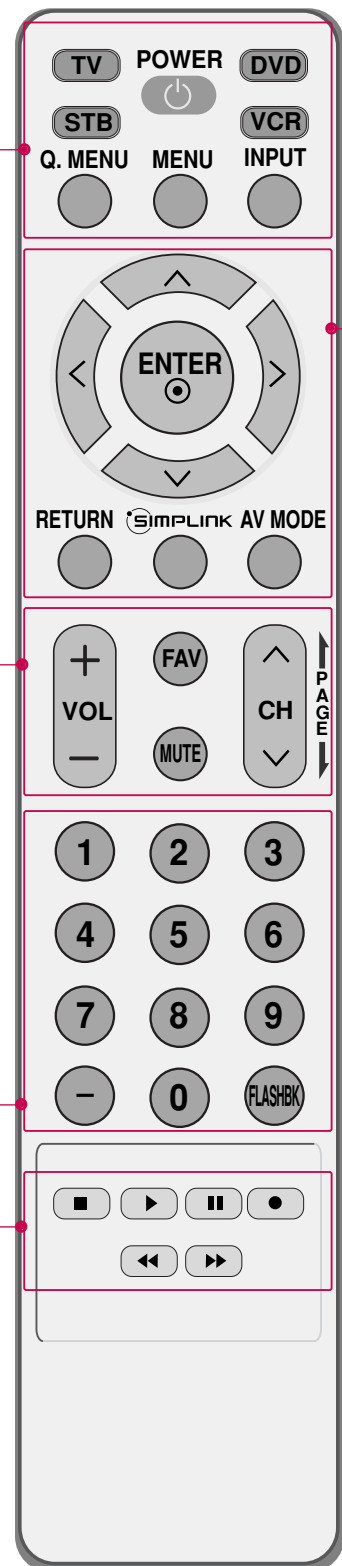

**THUMBSTICK** (Up/Down/Left Right/ENTER) Navigate the on-screen menus and adjust the system settings to your preference.

**RETURN** Clear all on-screen displays and return to TV viewing from any menu.

**SIMPLINK** See a list of AV devices connected to TV.  
When you toggle this button, the SimpLink menu appears at the screen. ► p.54-55

**AV MODE** It helps you select and set images and sounds when connecting AV devices. ► p.53

## Installing Batteries

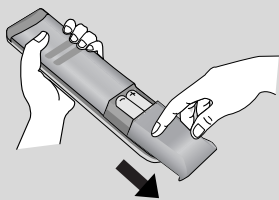

- Open the battery compartment cover on the back side and install the batteries matching correct polarity (+with +,-with -).
- Install two 1.5V AAA batteries. Don't mix old or used batteries with new ones.
- Close cover.

# WATCHING TV / CHANNEL CONTROL

## TURNING ON TV

---

- 1** First, connect power cord correctly.  
At this moment, the TV switches to standby mode.
    - In standby mode to turn TV on, press the  $\phi/|$  , **INPUT**, **CH** ( $\blacktriangle$  or  $\blacktriangledown$ ) button on the TV or press the **POWER**, **INPUT**, **CH** ( $\wedge$   $\vee$  ), **Number (0~9)** button on the remote control.
  - 2** Select the viewing source by using the **INPUT** button on the remote control.
    - This TV is programmed to remember which power state it was last set to, even if the power cord is out.
  - 3** When finished using the TV, press the **POWER** button on the remote control. The TV reverts to standby mode.
- 

### ! NOTE

- ▶ If you intend to be away on vacation, disconnect the power plug from the wall power outlet.

## CHANNEL SELECTION

---

- 1** Press the **CH** ( $\wedge$   $\vee$  ) or **NUMBER** buttons to select a channel number.
- 

## VOLUME ADJUSTMENT

Adjust the volume to suit your personal preference.

---

- 1** Press the **VOL** (+ or -) button to adjust the volume.
  - 2** If you want to switch the sound off, press the **MUTE** button.
  - 3** You can cancel the Mute function by pressing the **MUTE** or **VOL** (+ or -) button.
-

## QUICK MENU

Your TV's OSD (On Screen Display) may differ slightly from what is shown in this manual.

Q.Menu (Quick Menu) is a menu of features which users might use frequently.

- **Aspect Ratio:** Selects your desired picture format.
- **Power Saving** (Only Plasma TV): Adjusts screen brightness to reduce the power consumption of the TV.
- **Brightness** (Only LCD TV): Adjusts screen brightness.
- **Clear Voice:** By differentiating the human sound range from others, it helps users listen to human voices better.
- **Picture Mode:** Selects the factory preset picture depend on the viewing environment.
- **Sound Mode:** Selects the factory preset sound for type of program.
- **Caption:** Select a closed caption.
- **Multi Audio:** Selects MTS sound or changes the audio language.
- **Sleep Time:** Select the amount of time before your TV turns off automatically.
- **Del/Add/Fav:** Select channel you want to add or delete or add the channel to the Favorite List.
- **USB Eject:** Select "USB Eject" in order to eject USB device.

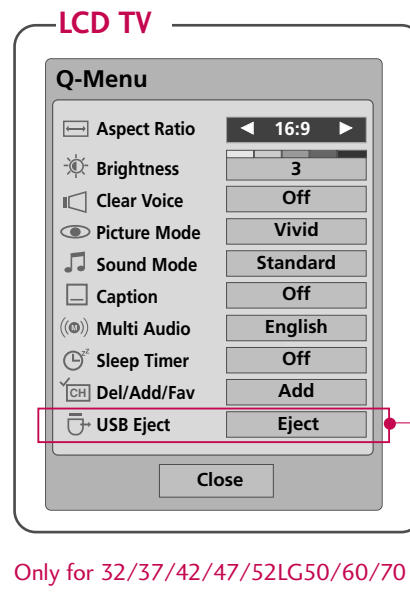
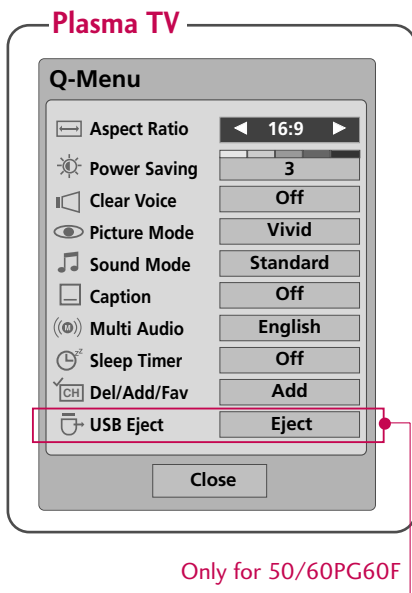

1   Display each menu.

2  Make appropriate adjustments.

3  Return to TV viewing

# WATCHING TV /CHANNEL CONTROL

## INITIAL SETTING

This OSD (On Screen Display) is displayed automatically on the screen as figure after turning on the TV and you can adjust the Location, Time, Language, Auto tuning.

### Step1. Mode setting

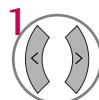

Select **Display Mode** or **Home Mode**.



- **Display Mode:** It maintains the 'Picture mode' optimized for the shop environment. It maintains the picture mode as 'Vivid' at a specific interval.  
It's not available to use Low Power.
- **Home Mode:** You can adjust the 'picture mode' to use.

### Step2. Time setting

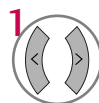

Select **Auto** or **Manual**.



Select desired time option.



## Step3. Option setting

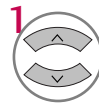
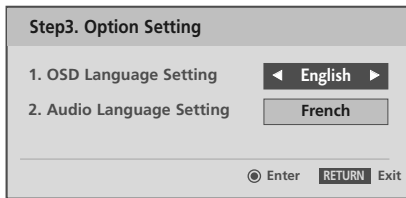

1 Select **OSD Language Setting** or **Audio Language Setting**.

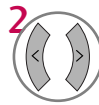

2 Select your desired language.



## Step4. Auto Tuning

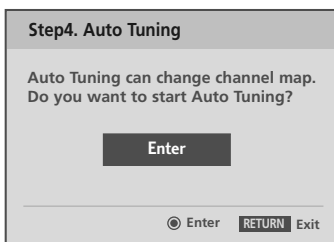

1 Start **Auto Tuning**.

### ! NOTE

- You can also adjust **Initial Setting** in the **OPTION** menu.

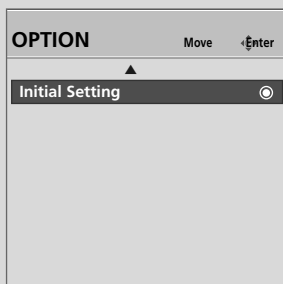

1 Select **OPTION**.



2 Select **Initial Setting**.



# WATCHING TV /CHANNEL CONTROL

## ON-SCREEN MENUS SELECTION

Your TV's OSD (On Screen Display) may differ slightly from that shown in this manual.

\* Only 32/37/42/47/52LG50/60/70, 50/60PG60F

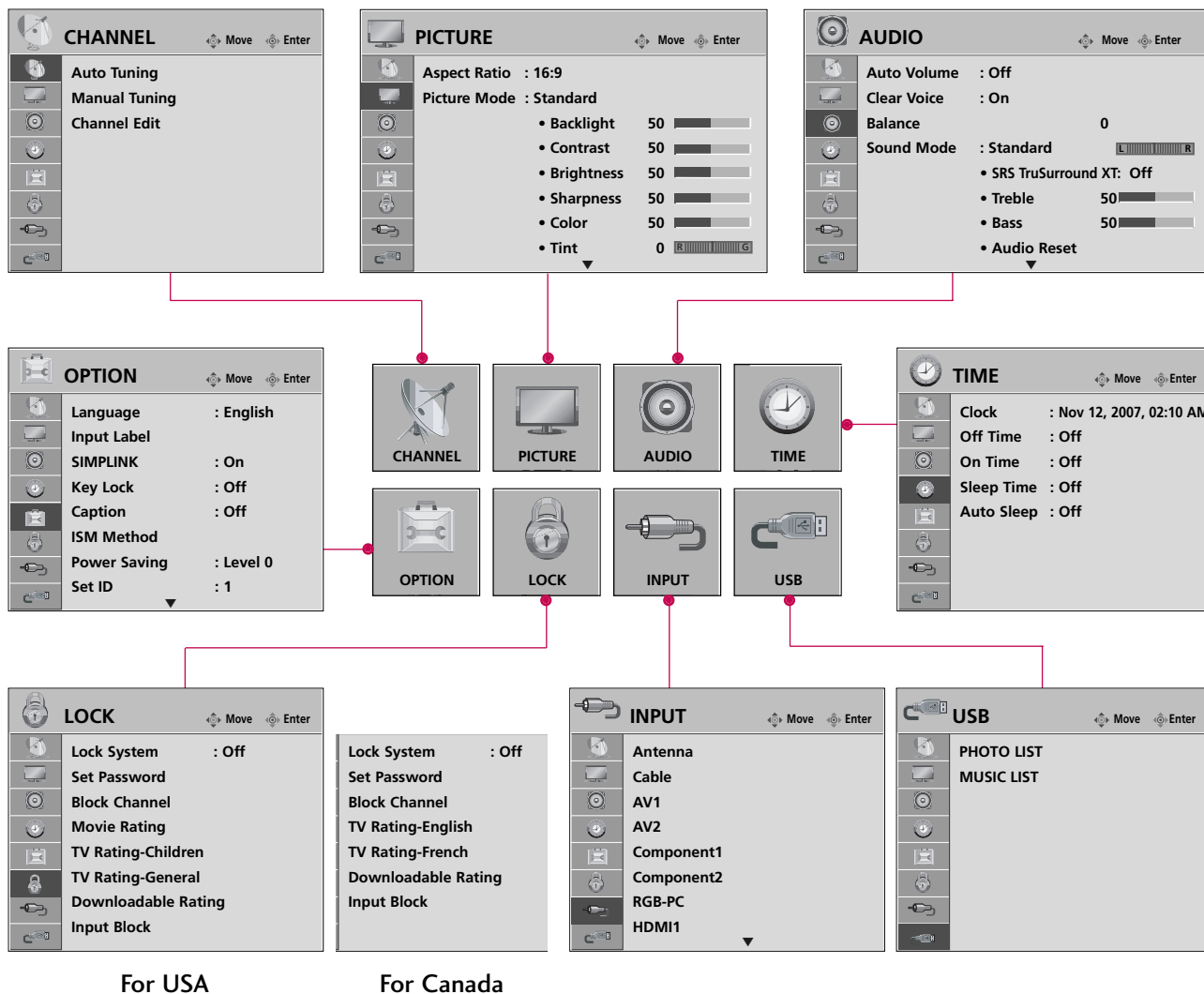

- 1 Display each menu.
- 2 Select a menu item.
- 3 Enter to the pop up menu.
- 4 Return to TV viewing





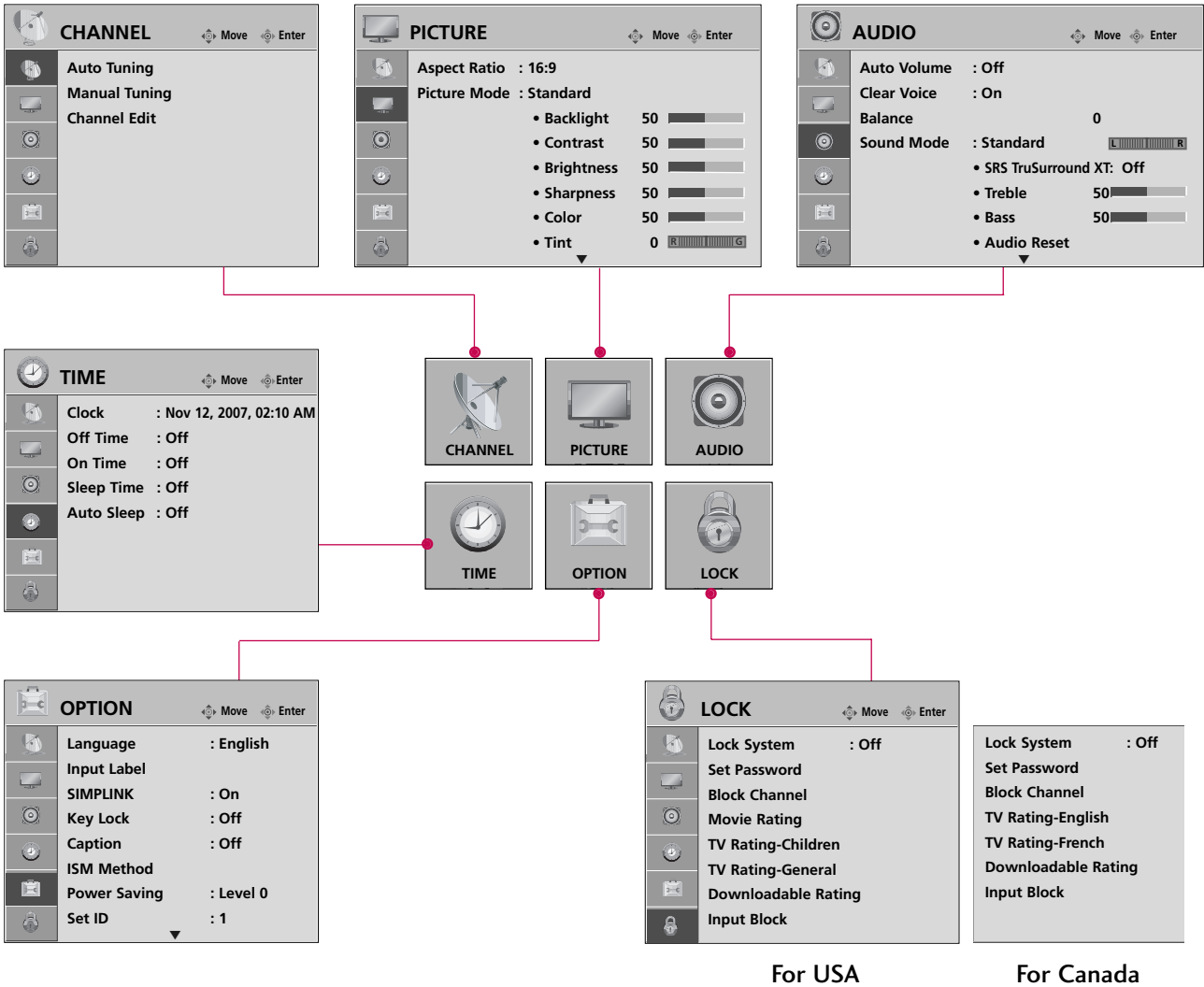

### ! NOTE

- ▶ ISM Method, Power Saving: Only Plasma TV.
- ▶ Backlight: Only LCD TV.
- ▶ TruMotion Demo: Only 32/37/42/47/52LG60/70.
- ▶ Power Indicator: Only 32/37/42/47/52LG60.



Only 26/32/37/42LG30, 42/50/PG10/20



- 1   Display each menu.
- 2   Select a menu item.
- 3  Enter to the pop up menu.
- 4  Return to TV viewing

**NOTE**

- ▶ ISM Method, Power Saving: Only Plasma TV.
- ▶ Backlight: Only LCD TV.

# WATCHING TV /CHANNEL CONTROL







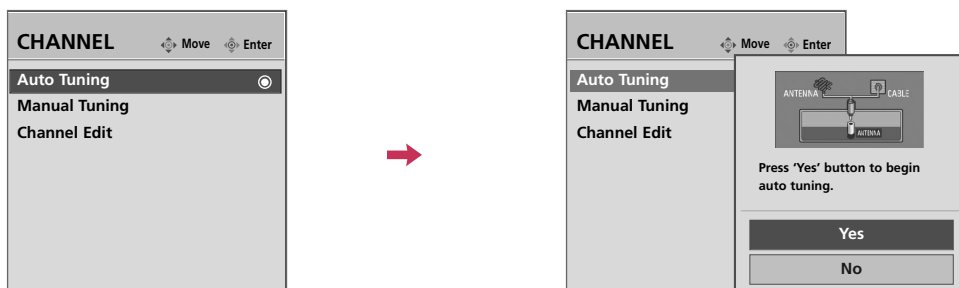

## CHANNEL SETUP

### Auto Scan (Auto Tuning)

Automatically finds all channels available through antenna or cable inputs, and stores them in memory on the channel list.

Run Auto Tuning again after any Antenna/Cable connection changes.





- 1   Select **CHANNEL**.
- 2   Select **Auto Tuning**.
- 3   Select **Yes**.
- 4  Run **Auto tuning**.
- 5  Return to the previous menu.
-  Return to TV viewing

■ A password is required to gain access to Auto Tuning menu if the Lock System is turned on.

## Add/Delete Channel (Manual Tuning)

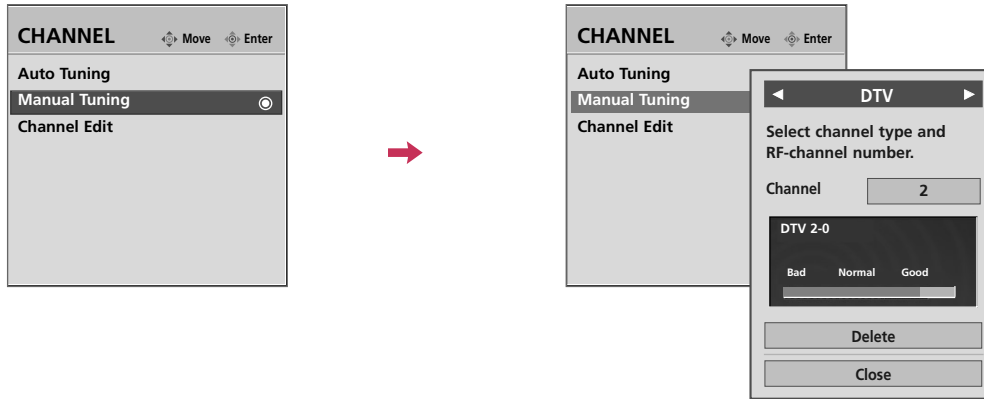
If selecting DTV or CADTV input signal, you can view the on-screen signal strength monitor to see the quality of the signal being received.



- 1   Select **CHANNEL**.
- 2   Select **Manual Tuning**.
- 3   Select **DTV, TV, CADTV, or CATV**.
- 4   Select channel you want to add or delete.
- 5   Select **Add** or **Delete**.
- 6  Return to the previous menu.
-  Return to TV viewing

■ A password is required to gain access to Manual Tuning menu if the Lock System is turned on.

# WATCHING TV / CHANNEL CONTROL

## CHANNEL SETUP





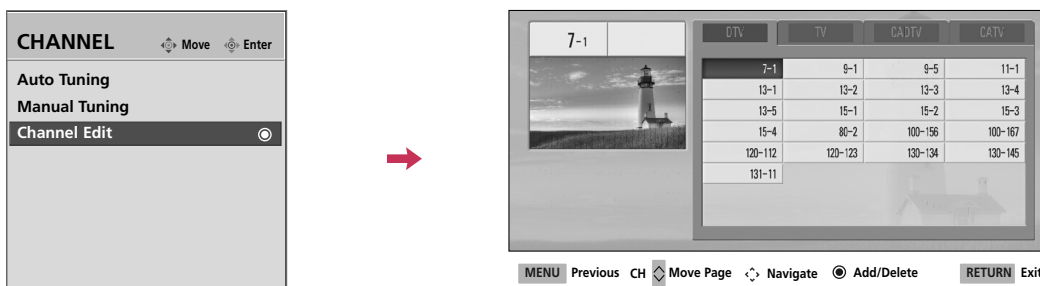

### Channel Editing

From the default channel list created from the Auto Tuning channel search, you can create two different types of channel lists in memory: “custom list” and “favorite channel list”.

A custom list can be created by toggling each channel on or off with **ENTER** button. The channels in the Custom List are displayed in black and the channels deleted from the Custom List are displayed in gray.

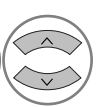
Once a channel is highlighted you can add or delete the channel by referring to the small window at the top-left corner of the screen.

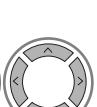

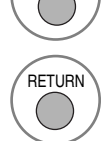
-   Select **CHANNEL**.
-   Select **Channel Edit**.
-   Select a channel.
-  Select channel you want to add or delete.
-  Return to the previous menu.
-  Return to TV viewing