

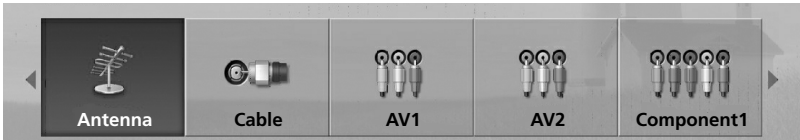

INPUT LIST

Only these input signals which are connected to a TV can be activated and selected.

Input List



1   Select the desired input source.

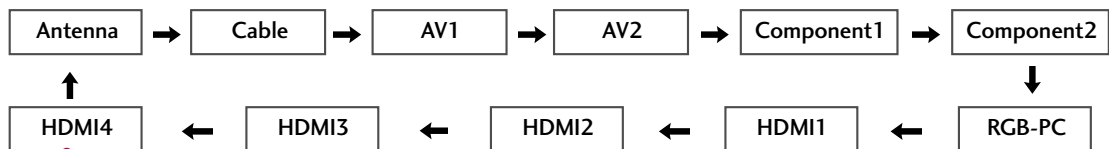

Except 26/32/37/42/47/52LG30/50, 42/50PG10/20

2  Selected input source is linked.

- You can also select the desired input source in the **INPUT** menu (Only 32/37/42/47/52LG50/60/70, 50/60PG60F).

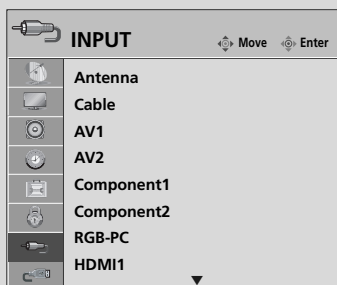

- Antenna:** Select it when watching the DTV/TV.
- Cable:** Select it when watching the CADTV/CATV.
- AV 1-2:** Select it when watching the VCR or external equipment.
- Component 1-2:** Select it when using the DVD or the Digital set-top box depend on connector.
- RGB-PC:** Select it when using PC depend on connector.
- HDMI1-4:** Select it when using DVD, PC or Digital set-top box depend on connector.

WATCHING TV / CHANNEL CONTROL

INPUT LABEL

Sets a label to each input source which is not in use.

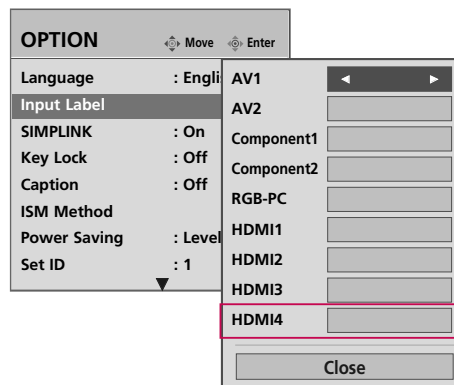
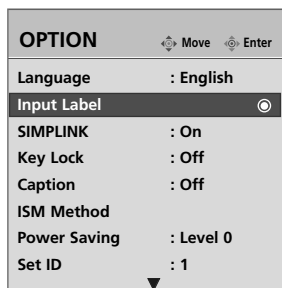

Only for
32/37/42/47/52LG60/70,
50/60PG60F

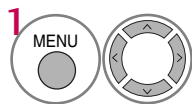

1 Select **OPTION**.

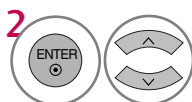

2 Select **Input Label**.

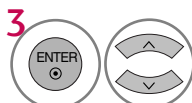

3 Select the source.

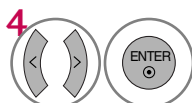

4 Select the label.



5 Return to the previous menu.

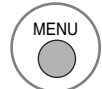

Return to TV viewing

AV MODE

You can select the optimal images and sounds when connecting AV devices to external input.

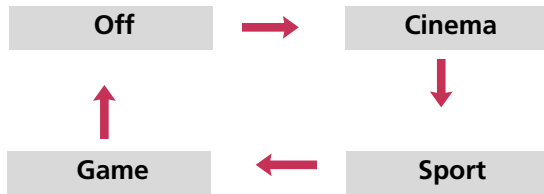

Press the **AV MODE** button repeatedly to select the desired source.



Return to the previous menu.

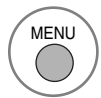

Return to TV viewing

- If you select Cinema Mode in AV mode, Cinema mode will be selected both for Picture and Sound Mode in PICTURE and AUDIO menu respectively.
- If you select “Off” in AV mode, the picture and image which you initially set will be selected.

WATCHING TV / CHANNEL CONTROL



This function operates only with devices with the logo. Please check the logo.

This allows you to control and play other AV devices connected to the display through HDMI cable without additional cables and settings.

If you require the SIMPLINK menu, select “On”.

SIMPLINK function is not supported by HDMI IN 4 input source.

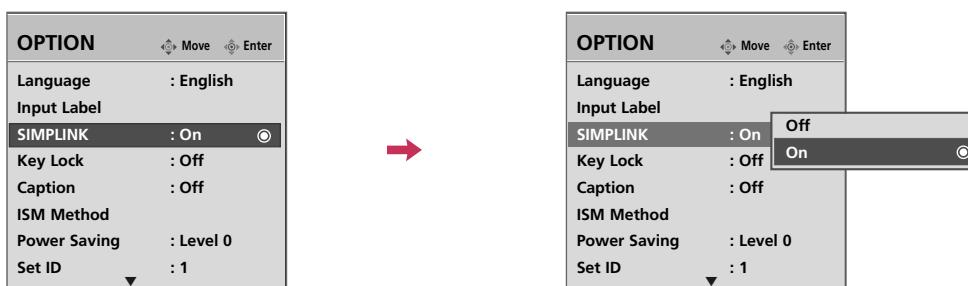











- 1 Select **OPTION**.
- 2 Select **SIMPLINK**.
- 3 Select **On** or **Off**.
- 4 Return to the previous menu.
- Return to TV viewing

! NOTE

- ▶ Connect the HDMI/DVI IN or HDMI IN terminal of the TV to the rear terminal (HDMI terminal) of the SIMPLINK device with the HDMI cable.
- ▶ After connecting the HDMI terminal for the home theater with the SIMPLINK function using the above method, connect the DIGITAL AUDIO OUT terminal on the back of the TV to the DIGITAL AUDIO IN terminal on the back of the SIMPLINK device with the OPTICAL cable.
- ▶ When you switch the Input source with the INPUT button on the remote control, you can stop the operation of device controlled by SIMPLINK.
- ▶ When you select or operate the media device with home theater function, the speaker automatically switches to home theater speaker (HT speaker).
- ▶ When you execute 'PHOTO LIST, MUSIC LIST' function during DVD playback included in home theater supported the Simplink stops and the applicable function is executed after switching the input to TV.

Simplink Functions

- **Direct Play:** After connecting AV devices to the TV, you can directly control the devices and play media without additional settings.
- **Select AV device:** Enables you to select one of the AV devices connected to TV and play it.
- **Disc playback:** Control connected AV devices by pressing the , , , , , , , , , , ENTER buttons and buttons for play, stop, pause, fast reverse, fast forward, chapter skip.
- **Power off all devices:** When you power off the TV, all connected devices are turned off.
- **Switch audio-out:** Offers an easy way to switch audio-out.

(A device, which is connected to the TV through a HDMI cable but does not support Simplink, does not provide this function)

Note: To operate SIMPLINK, the HDMI cable over 1.2 Version with *CEC function should be used. (*CEC: Consumer Electronics Control).

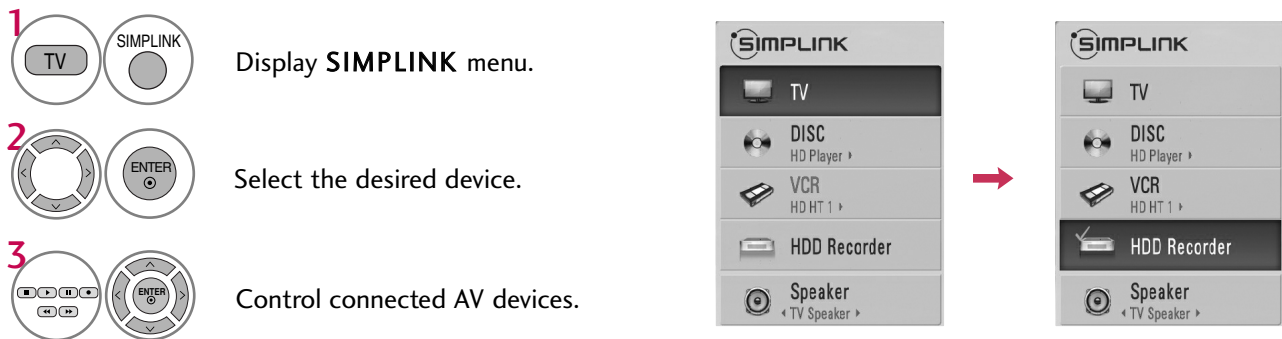

Simplink Menu

- 1 **TV viewing:** Switch to the previous TV channel regardless of the current mode.
- 2 **DISC playback:** Select and play discs. When multiple discs are available, the titles of discs are conveniently displayed at the bottom of the screen.
- 3 **VCR playback:** Control the connected VCR.
- 4 **HDD Recordings playback:** Control recordings stored in HDD.
- 5 **Audio Out to HT speaker/Audio Out to TV:** Select HT speaker or TV speaker for Audio Out.



USB

- This feature is only for 32/37/42/47/52LG50/60/70, 50/60PG60F.

ENTRY MODES

When you connect a USB device, this screen is displayed, automatically.
In USB device, you can not add a new folder or delete the existing folder.

- 1 Connect the USB device to the **USB IN** jacks on the side of TV.

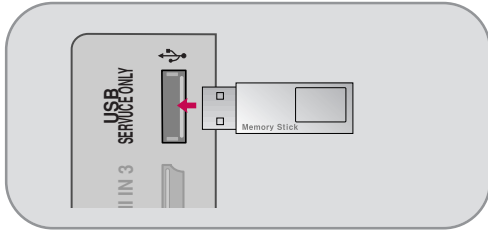

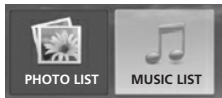

- 2  Select **PHOTO LIST** or **MUSIC LIST**



- 3 

When removing the USB device

Select the USB EJECT menu before removing the USB device.

- 1   Select **USB Eject**.
- 2 

Precautions when using the USB device

- ▶ Only a USB storage device is recognizable.
- ▶ If the USB storage device is connected through a USB hub, the device is not recognizable.
- ▶ A USB storage device using an automatic recognition program may not be recognized.
- ▶ A USB storage device which uses its own driver may not be recognized.
- ▶ In case of a card reader, up to four memory cards are concurrently recognizable.
- ▶ The recognition speed of a USB storage device may depend on each device.
- ▶ Please do not turn off the TV or unplug the USB device when the connected USB storage device is working. When such device is suddenly separated or unplugged, the stored files or the USB storage device may be damaged.
- ▶ Please do not connect the USB storage device which was artificially maneuvered on the PC. The device may cause the product to malfunction or fail to be played. Never forget to use only a USB storage device which has normal music files or image files.
- ▶ Please use only a USB storage device which was formatted as a FAT32 file system provided with the Windows operating system. In case of a storage device formatted as a different utility program which is not supported by Windows, it may not be recognized.
- ▶ Please connect power to a USB storage device which requires an external power supply. If not, the device may not be recognized.
- ▶ Please connect a USB storage device with cable is offered by USB maker. If connected with cable is not offered by USB maker or an excessively long cable, the device may not be recognized.
- ▶ Some USB storage devices may not be supported or operated smoothly.
- ▶ If the name of a folder or file is too long, it will not be displayed or recognized.
- ▶ Please backup the important file because a data of USB device may be damaged. Data management is consumer's responsibility and in consequence the manufactures does not cover the product bearing data damage.

PHOTO LIST

It's available to playback the photo file(*.jpg) in the USB device.



The On Screen Display may be different from your set. Images are an example to assist with the TV operation.



PHOTO (*.JPEG) supporting file

Baseline: width<=4800, height is no limit

- You can play JPEG files only.
- Only baseline scan is supported among JPEG.
- Non-supported files are displayed in the form of icon.

Screen Components

1   Select **USB**.

2    Select **Photo List**.

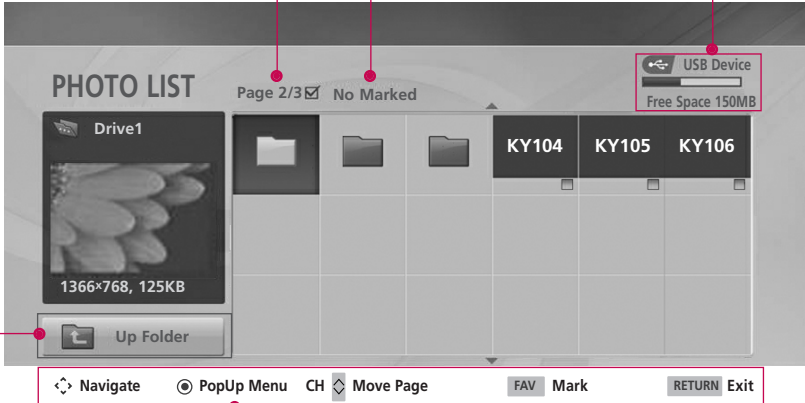







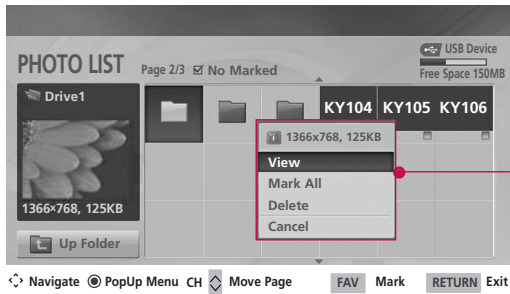
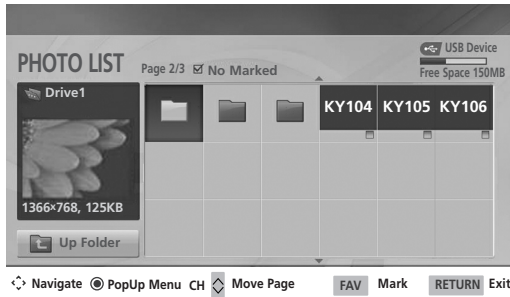

The screenshot shows a 'PHOTO LIST' interface. At the top, it displays 'Page 2/3' and 'No Marked'. A 'USB Device' section shows 'Free Space 150MB'. Below this, there are thumbnails for 'Drive1' (with dimensions 1366x768, 125KB) and folders 'KY104', 'KY105', and 'KY106'. A 'Up Folder' button is visible at the bottom left. A bottom navigation bar contains buttons for 'Navigate', 'PopUp Menu', 'CH', 'Move Page', 'FAV', 'Mark', and 'RETURN Exit'.

- ① Moves to upper level file
- ② Current page/Total pages
- ③ Total number of marked thumbnail photos
- ④ Usable USB memory
- ⑤ Corresponding buttons on the remote control

Photo Selection and PopUp Menu



- ▶ **View:** Display the selected item.
- ▶ **Mark All:** Mark all photos on the screen.
- ▶ **Unmark All:** Deselect all marked photos.
- ▶ **Delete:** Delete the selected photo item.
- ▶ **Cancel:** Close the pop-up menu.

- 1  Select the target folder or drive.
- 2   Select the desired photos.
- 3  Show the PopUp menu.
- 4   Select the desired PopUp menu.
- 5  Return to TV viewing
-  Return to the previous menu.





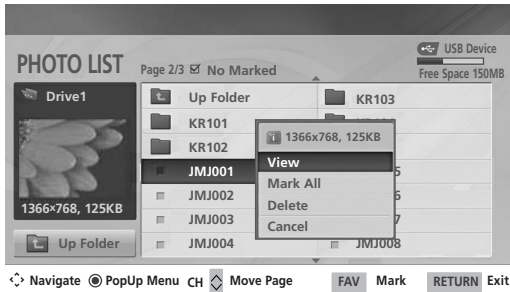
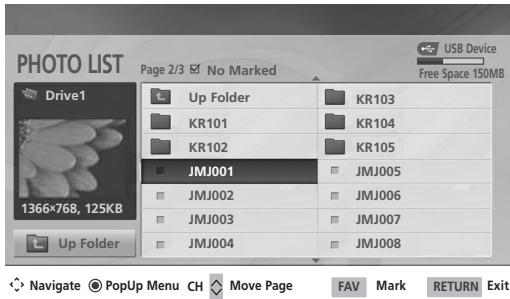

- Use the **CH**   button to navigation in the thumbnail photo page.
- Use the **FAV** button to mark or unmark a photo. When one or more photos are marked, you can view individual photos or a slide show of the marked photos. If no photos are marked, you can view all photos individually or all photos in the folder in a slide show.



Set up the menu in Full-Sized Screen

You can change the settings to display photos stored on a USB device, on a full-sized screen. Detailed operations are available on full-sized photo view screen.



The aspect ratio of a photo may change the size of the photo displayed on the screen in full size.

- 1  Select the target folder or drive.
- 2   Select the desired photos.
- 3  show the PopUp menu.
- 4  Select **View**
- 5  The selected photo is displayed in full size.

- Use the CH   button to navigation in the thumbnail photo page.

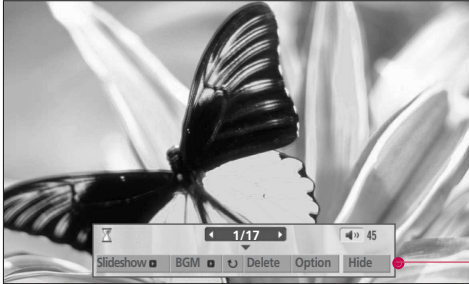

The aspect ratio of a photo may change the size of the photo displayed on the screen in full size.

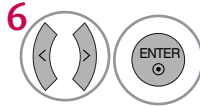

6 Select the **Slideshow**, **BGM**, **Rotate**, **Delete**, **Option**, or **Hide**.

- Use **^** **v** **<** **>** button to select the previous or next photo.
- Use **^** **v** **<** **>** button to select and control the menu on the full-sized screen.

- ▶ **Slideshow** : When no picture is selected, all photos in the current folder are displayed during slide show. When selected, the selected photos are displayed during slide show.
 - Set the time interval of the slide show in **Option**.
- ▶ **BGM** : Listen to music while viewing photos in full size.
 - Set the BGM device and album in **Option**.
- ▶ **Rotate** : Rotate photos.
 - Rotates the photo 90°, 180°, 270°, 360° clockwise.
 - A slide show continues for a maximum of 4 hours. After 4 hours, the slide show will end and go to TV mode or external input mode.
- ▶ **Delete** : Delete photos.
- ▶ **Option** : Set values for **Slide Speed** and **Music Folder**.
 - Use **<** **>** button and **ENTER** button to set values. Then go to **Enter** and press **ENTER** to save the settings.
 - You cannot change **Music Folder** while BGM is playing.
- ▶ **Hide** : Hide the menu on the full-sized screen.
 - To see the menu again on the full-sized screen, press **ENTER** button to display.

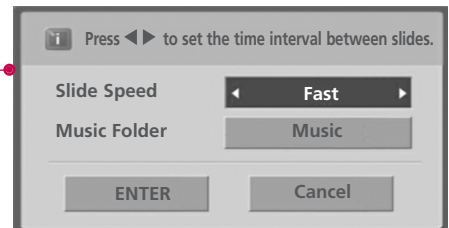

NOTE

- ▶ If it is Progressive JPEG format, some photos may be not decoded.

MUSIC LIST

Purchased music files(*.MP3) may contain copyright restrictions. Playback of these files may not be supported by this model.

Music file on your USB device can be played by this unit.

The On Screen Display may be different from your set. Images are an example to assist with the TV operation.

MUSIC(*.MP3) supporting file
 Bitrate range 8Kbps ~ 320Kbps

- Sampling rate
- MPEG1 : 32000, 44100, 48000Hz
- MPEG2 : 16000, 24000, 22050Hz
- MPEG2.5 : 8000, 11025, 12000Hz

Screen Components

1

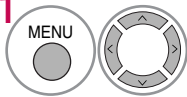

Select **USB**.

2

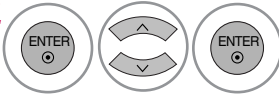

Select **Music List**.

- ① Moves to upper level file
- ② Current page/Total pages
- ③ Total number of marked musics
- ④ Usable USB memory
- ⑤ Corresponding buttons on the remote control

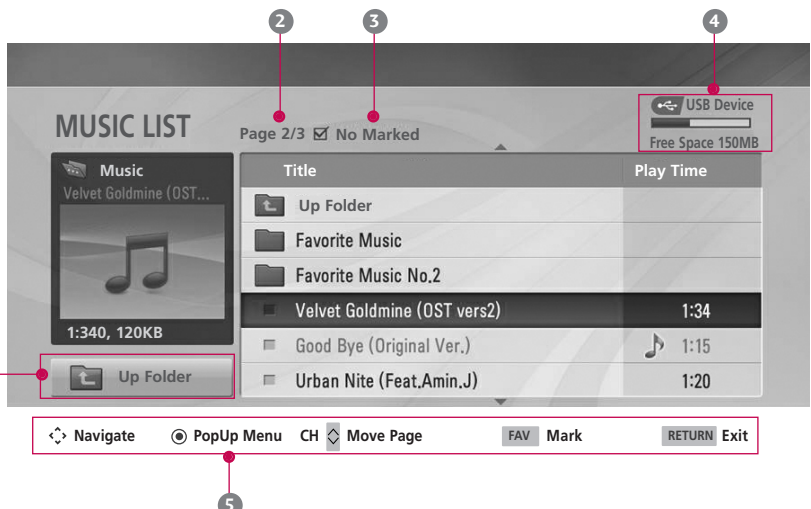





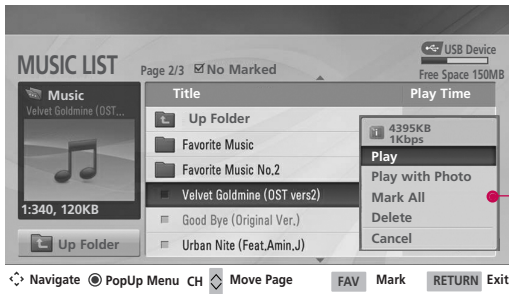
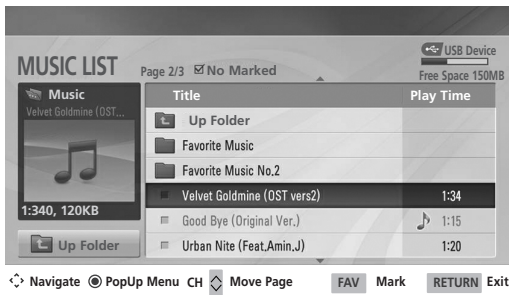

The screenshot shows the 'MUSIC LIST' interface. At the top, it displays 'Page 2/3' and 'No Marked'. A 'USB Device' status bar shows 'Free Space 150MB'. The main content area has a table with columns 'Title' and 'Play Time'. The table lists folders like 'Up Folder', 'Favorite Music', and 'Favorite Music No.2', along with music files such as 'Velvet Goldmine (OST vers2)', 'Good Bye (Original Ver.)', and 'Urban Nite (Feat.Amin.J)'. A 'Music' preview card for 'Velvet Goldmine (OST...)' is shown on the left. At the bottom, a navigation bar includes buttons for 'Navigate', 'PopUp Menu', 'CH', 'Move Page', 'FAV', 'Mark', and 'RETURN Exit'.



Music Selection and PopUp Menu

As shown, up to 6 music titles are listed per page.



- ▶ **Play (During stop)** : Play the selected musics. Once a music finishes playing, the next selected one will be played. When there are no selected musics to play, the next one in the current folder will be played. If you go to a different folder and press the **ENTER** button, the current music in playback will stop.
- ▶ **Play Marked** : Play the selected musics. Once a music finishes playing, the next selected one will be played automatically.
- ▶ **Stop Play (During playback)** : Stop the playing musics.
- ▶ **Play with Photo** : Start playing the selected musics and then move to the Photo List.
- ▶ **Mark All** : Mark all musics in the folder.
- ▶ **Unmark All** : Deselect all marked musics.
- ▶ **Delete** : Delete the selected musics.
- ▶ **Cancel** : Close the pop-up menu.

- 1  Select the target folder or drive.
- 2   Select the desired musics.
- 3  show the PopUp menu.
- 4   Select the desired PopUp menu.

- 5  Return to TV viewing
-  Return to the previous menu.

- Use the **CH** ^ v button to navigation in the thumbnail photo page.
- Use **FAV** button to mark or unmark a music. When one or more music files are marked, the marked musics will be played in sequence. For example, if you want to listen to only one music repeatedly, just mark the music only and play it. If no music is marked, all the music in the folder will be played in sequence.



- If you don't press any button for a while during the playing, the play information box (as shown in the below) will float as a screen saver.

- The 'Screen Saver'?

Screen saver is to prevent screen pixel damage due to an fixed image remaining on the screen for a extended period of time.



! NOTE

- ▶ When music is playing,  is displayed in Back of the music title.
- ▶ A damaged or corrupted music does not play but displays 00:00 in playtime.
- ▶ A music downloaded from a paid service with copyright protection does not start but displays inappropriate information in playtime.
- ▶ If you press **ENTER**,  buttons, screen saver is stopped.
- ▶ The **PLAY**(▶), **Pause**(||),  buttons on the remote control are also available in this mode.
- ▶ It's not available to play MP3 file under 16Kbyte.

PICTURE CONTROL

PICTURE SIZE (ASPECT RATIO) CONTROL

This feature lets you choose the way an analog picture with a 4:3 aspect ratio is displayed on your TV. When you receive an analog picture with a 4:3 aspect ratio on your 16:9 TV, you need to specify how the picture is to be displayed.





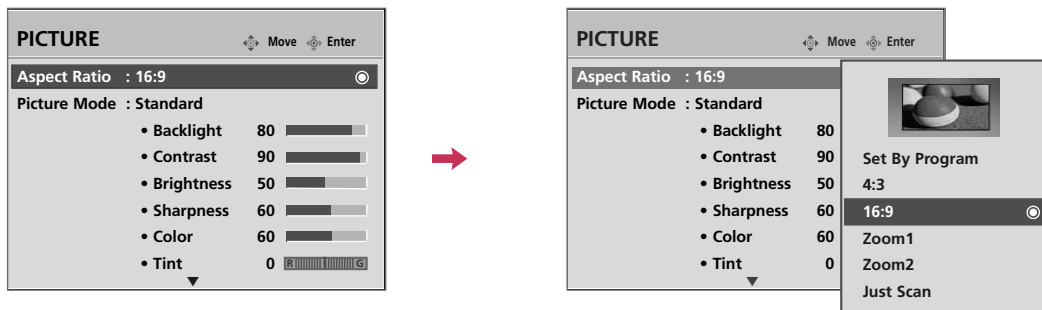

- RGB-PC input source use 4:3 or 16:9 aspect ratio.

NOTE

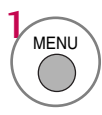
- ▶ If a fixed image is displayed on the screen for a long time, the image may become imprinted on the screen and remain visible.

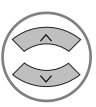
This phenomenon is common to all manufactures and in consequence the manufactures warranty does not cover the product bearing this phenomenon.

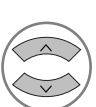

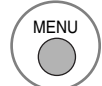
-   Select **PICTURE**.
-   Select **Aspect Ratio**.
-   Select the desired picture format.
-  Return to the previous menu.
-  Return to TV viewing

- You can also adjust **Aspect Ratio** in the **Q-Menu**.

Set by program

Selects the proper picture proportion to match the source's image.

(4:3 → 4:3)



(16:9 → 16:9)



4:3

Choose 4:3 when you want to view a picture with an original 4:3 aspect ratio.



16:9

Adjust the picture horizontally, in a linear proportion to fill the entire screen.



Zoom 1

Choose Zoom 1 when you want to view the picture without any alteration. However, the top and bottom portions of the picture will be cropped.

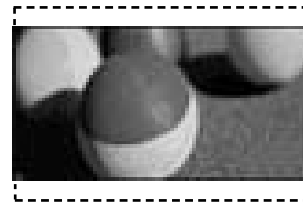

Zoom 2

Choose Zoom 2 when you want the picture to be altered, both vertically extended and cropped. The picture taking a halfway trade off between alteration and screen coverage.

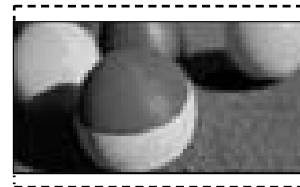

Just Scan

Following selection will lead to you view the picture of best quality without loss of original picture in high resolution image.

Notes: If there are noise in original picture, you can see the noise at the edge.

Just Scan operates only in DTV/CADTV (720p/1080i/1080p), HDMI-DTV, DVI-DTV input source.









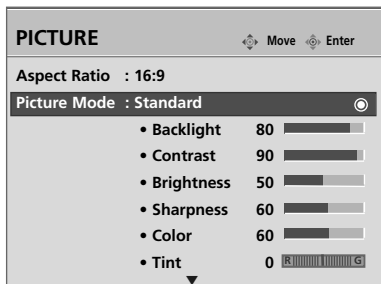

PICTURE CONTROL

PRESET PICTURE SETTINGS

Picture Mode - Preset

Picture Mode adjusts the TV for the best picture appearance. Select the preset value in the Picture Mode menu based on the program category.

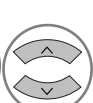

-   Select **PICTURE**.
-   Select **Picture Mode**.
-   Select **Intelligent Eye** (Only 26/32/37/42/47/52LG50/60/70), **Vivid, Standard, Cinema, Sports, or Game**.
-  Return to TV viewing

- **Intelligent Eye, Dynamic, Standard, Mild** Settings are preset for the optimum picture quality at the factory and are not adjustable.
- When selecting **Intelligent Eye** (Only 26/32/37/42/47/52LG50/60/70), the most suitable picture is automatically adjusted according to the surrounding conditions.
- You can also adjust **Picture Mode** in the **Q. Menu**.









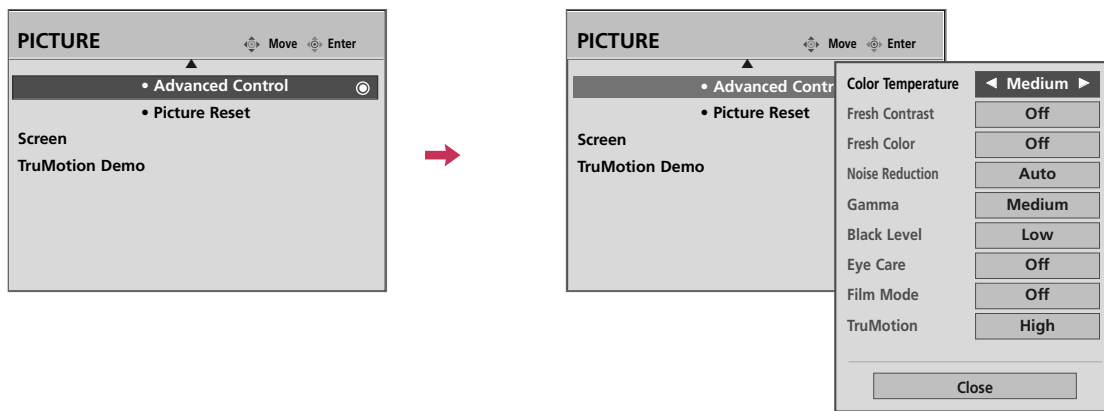

Color Tone - Preset

Choose one of three automatic color adjustments. Set to warm to enhance hotter colors such as red, or set to cool to see less intense colors with more blue.

To initialize values (reset to default settings), select the Cool option.

When selecting Picture Mode options (Dynamic, Standard and Mild), Color Temperature is automatically change.



-   Select **PICTURE**.
-   Select **Advanced Control**.
-   Select **Color Temperature**.
-   Select **Cool, Medium, or Warm**.
-  Return to the previous menu.
-  Return to TV viewing









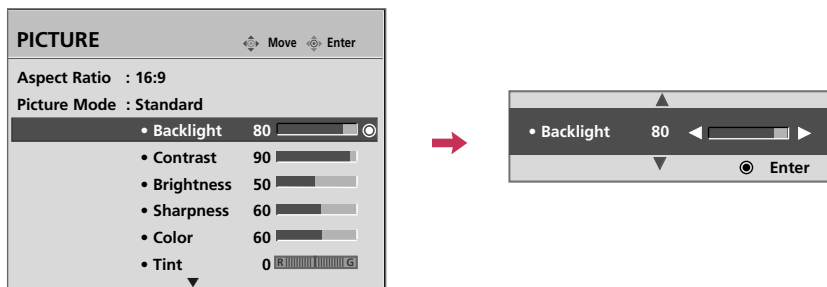

PICTURE CONTROL

MANUAL PICTURE ADJUSTMENT

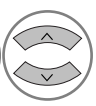
Picture Mode - User Mode

Adjust the picture appearance to suit your preference and viewing situations.
This feature is disabled in "Picture Mode-Intelligent Eye".

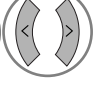
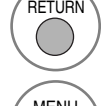







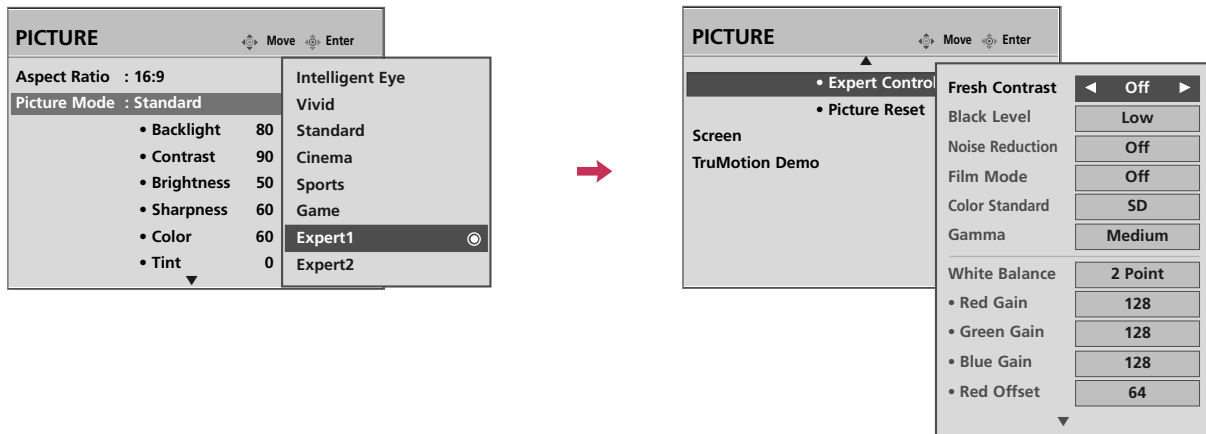







-   Select **PICTURE**.
-   Select **Picture Mode**.
-   Select **Vivid, Standard, Cinema, Sports, or Game**.
-   Select **Backlight (Only LCD TV), Contrast, Brightness, Sharpness, Color, or Tint**.
-   Make appropriate adjustments.
-  Return to the previous menu.
-  Return to TV viewing

Picture Mode - Expert Control

By segmenting categories, **Expert1** and **Expert2** provide more categories which users can set as they see fit, offering the optimal picture quality for users.



- 1   Select **PICTURE**.
- 2   Select **Picture Mode**.
- 3   Select **Expert1** or **Expert2**.
- 4   Select **Expert Control**.
- 5   Select your desired menu option.
- 6   Make appropriate adjustments.
- 7  Return to the previous menu.
-  Return to TV viewing

PICTURE CONTROL

PICTURE IMPROVEMENT TECHNOLOGY

Fresh Contrast: Optimizes the contrast automatically according to the brightness of the reflection.





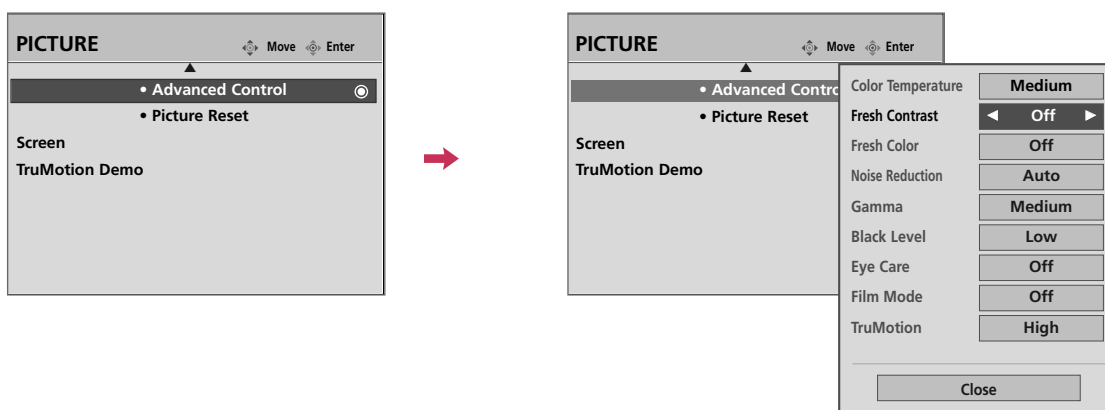

Fresh Color: Adjusts the color of the reflection automatically to reproduce as close as possible natural colors.

Noise Reduction: Removes interference up to the point where it does not damage the original picture.

Gamma: High gamma values display whitish images and low gamma values display high contrast images.

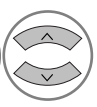

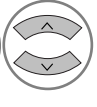
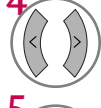







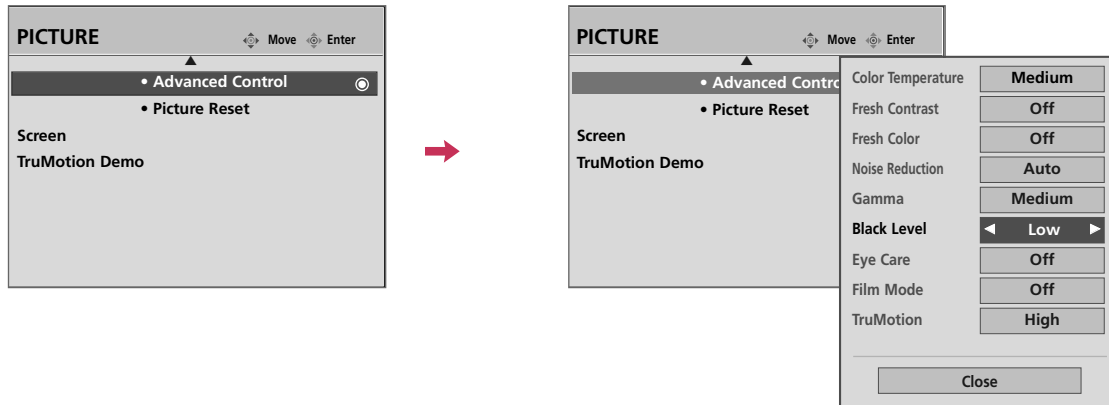

PICTURE CONTROL

-   Select **PICTURE**.
-   Select **Advanced Control**.
-   Select **Fresh Contrast, Fresh Color, Noise Reduction, or Gamma**.
-  Select your desired options.
-  Return to the previous menu.
-  Return to TV viewing

ADVANCED - BLACK (DARKNESS) LEVEL

Adjusting the contrast and the brightness of the screen using the black level of the screen.
This feature operates only in AV1-2, HDMI1-3 (or 4) mode.



- 1   Select **PICTURE**.
- 2   Select **Advanced Control**.
- 3   Select **Black Level**.
- 4   Select **Low** or **High**.
- 5  Return to the previous menu.
-  Return to TV viewing







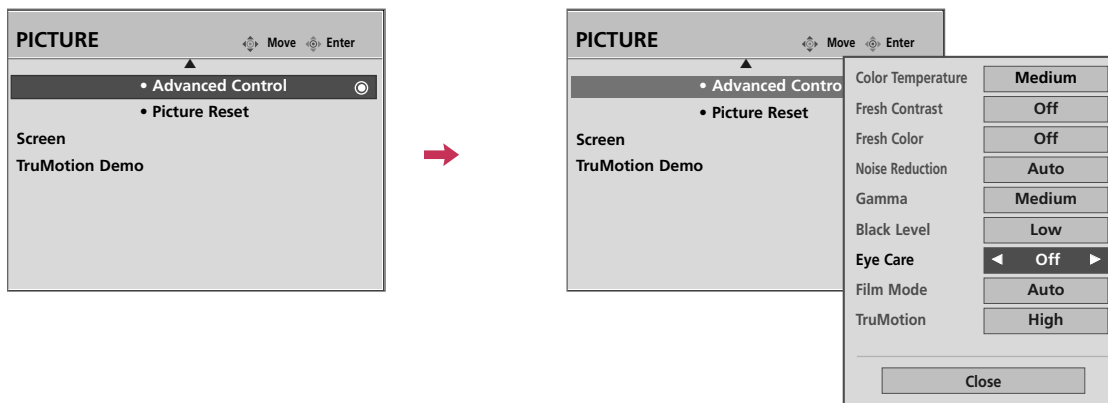

- **Low:** The reflection of the screen gets darker.
- **High:** The reflection of the screen gets brighter.
- **Auto:** Realizing the black level of the screen and set it to High or Low automatically.

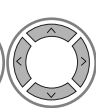
PICTURE CONTROL

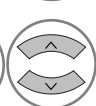
ADVANCED - EYE CARE - Only LCD TV

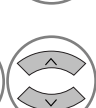
It helps you adjust brightness when the screen is too bright to prevent dazzling.

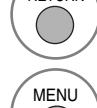

-   Select **PICTURE**.
-   Select **Advanced Control**.
-   Select **Eye Care**.
-   Select **On** or **Off**.
-  Return to the previous menu.
-  Return to TV viewing







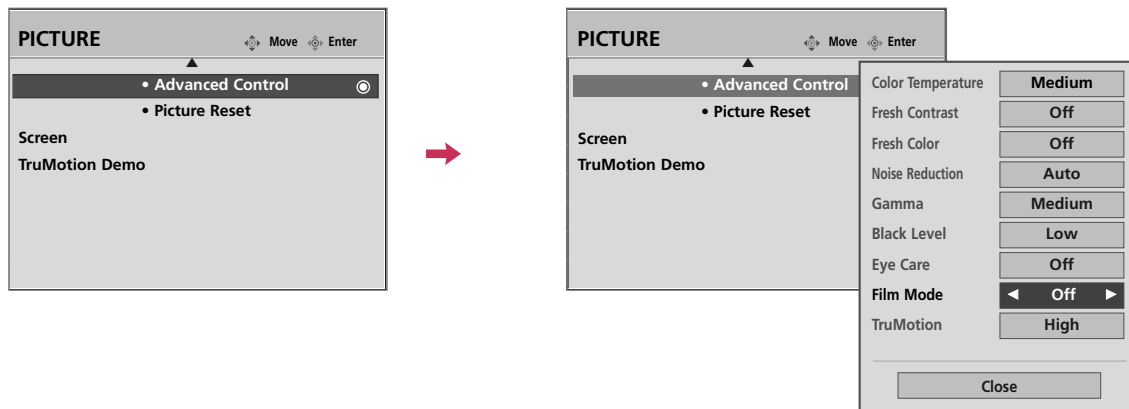

ADVANCED - FILM MODE

Set up the TV for the best picture appearance for viewing movies.

When you operate Film Mode (3:2 Pull-Down Mode or Cinema Correction Mode), the TV will adjust 24 fps video from movies to 30 fps video for display.

This feature operates only in TV (Analog TV/CATV, Digital DTV/CADTV), AV1, AV2, Component 480i/1080i, and HDMI 1080i mode.



-   Select **PICTURE**.
-   Select **Advanced Control**.
-   Select **Film Mode**.
-  Select **On** or **Off**.
-  Return to the previous menu.
-  Return to TV viewing





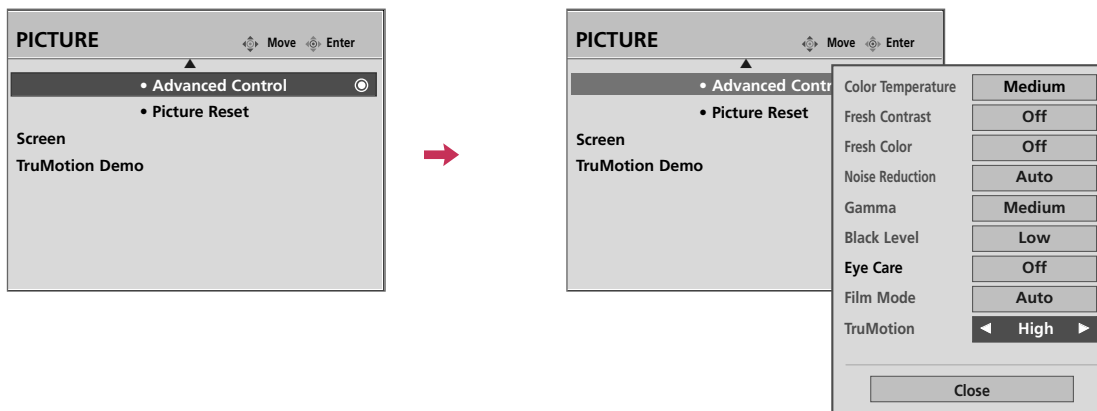

PICTURE CONTROL

ADVANCED - TRUMOTION - Only 32/37/42/47/52LG60/70

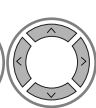
It is used for the best picture quality without any motion blur or judder when you enter a quick image or Film Source.

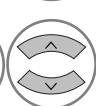
This feature is disable in RGB-PC,HDMI (PC) mode.



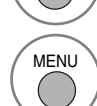





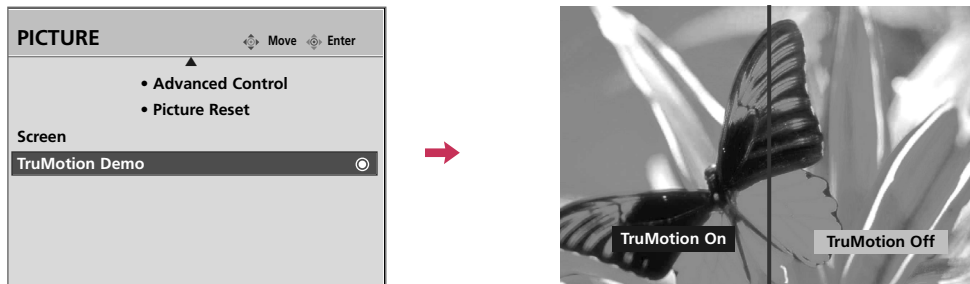

-   Select **PICTURE**.
-   Select **Advanced Control**.
-   Select **TruMotion**.
-  Select **Off, Low, or High**.
-  Return to the previous menu.
-  Return to TV viewing

- **Low:** Set amount of film judder to low.
- **High:** Set amount of film judder to high.

TRUMOTION DEMO - Only 32/37/42/47/52LG60/70

Use it to see the difference between TruMotion Demo on and TruMotion Demo off.
It's not available to use this function in RGB-PC, HDMI (PC) mode.



-   Select **PICTURE**.
-   Select **TruMotion Demo**.
-   Select **TruMotion On** or **Off**.
-  Stop **TruMotion**.





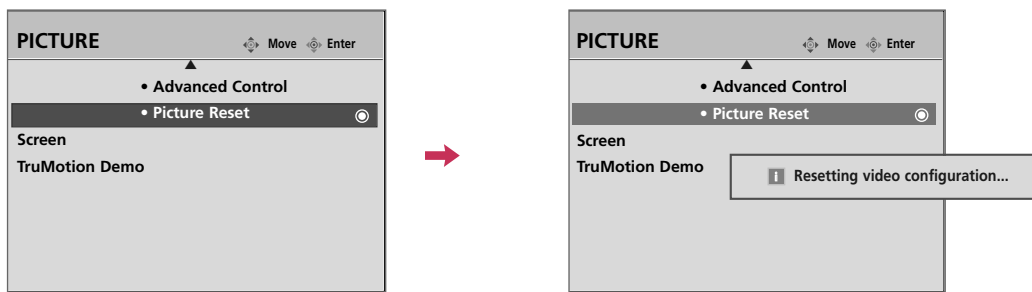

PICTURE CONTROL

PICTURE RESET

Use to quickly reset all the Picture menu options to their original factory preset values.











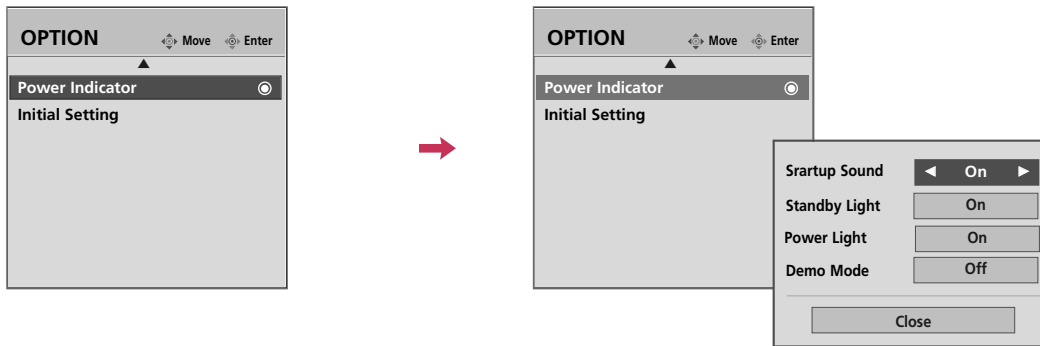

PICTURE CONTROL

-   Select **PICTURE**.
-   Select **Picture Reset**.
-  Initialize the adjusted value.
-  Return to TV viewing

POWER INDICATOR - Only 32/37/42/47/52LG60

It helps you adjust the brightness of moving LED and sound when power is turned on.



- 1   Select **OPTION**.
- 2   Select **Power Indicator**.
- 3   Select **Startup Sound, Standby Light, Power Light or Demo Mode**.
- 4   Select **On** or **Off**.
Select **Off, Low** or **High** (Only **Standby Light**).
- 5  Return to the previous menu.
-  Return to TV viewing







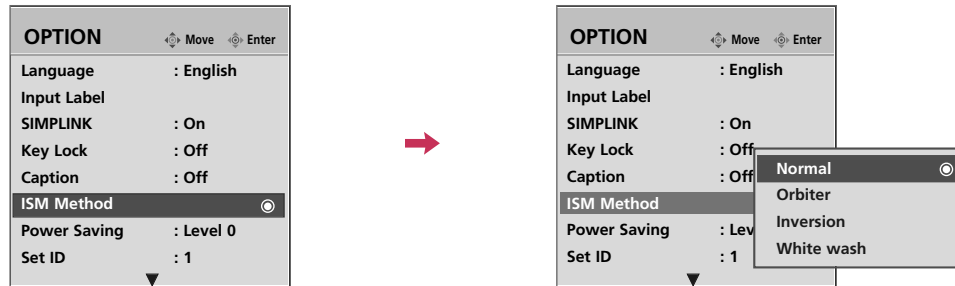

- **Startup Sound:** If you select “On”, there will be a start up sound.
- **Standby Light:** If you select “On”, the Power Button LED will turn red in Stand By mode.
- **Power Light:** If you select “On”, the screen will turn on and the brightness will go down 50%. If you switch off, White LED will gradually dim out and Red LED will turn on.
- **Demo Mode:** It shows how power on/off lighting works.
Red LED gradually fades into White LED and White LED gradually fades into Red LED.

PICTURE CONTROL

IMAGE STICKING MINIMIZATION (ISM) METHOD - *Only Plasma TV*

A frozen still picture from a PC/video game displayed on the screen for prolonged periods will result in a ghost image. Use our unique method to minimize any fixed image on the screen.



- 1   Select **OPTION**.
- 2   Select **ISM Method**.
- 3   Select **Normal, Orbiter, Inversion** or **White wash**.
- 4  Return to the previous menu.
-  Return to TV viewing

- **Normal:** If image sticking is never a problem, ISM is not necessary - set to Normal.
- **Orbiter:** Orbiter may help prevent ghost images. However, it is best not to allow any fixed image to remain on the screen. To avoid a ghost image on the screen, the image will move every 2 minutes.
- **Inversion:** Inversion will automatically invert the plasma display panel color every 30 minutes.
- **White Wash:** White Wash removes ghost images from the screen. Use sparingly. Watch the TV normally for a while before using this feature to see if the ghost image disappears on its own.







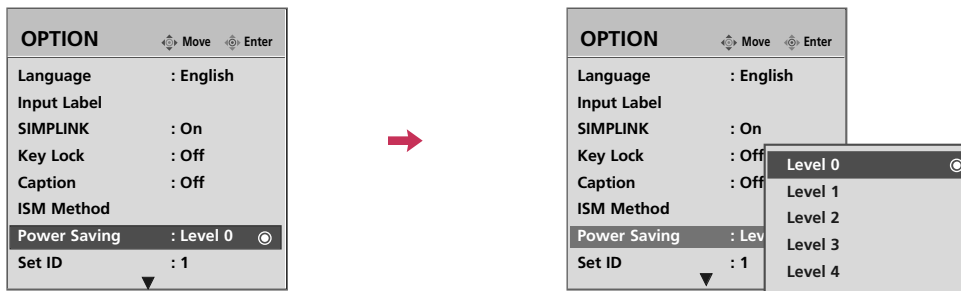

! NOTE

- ▶ An excessive ghosted image may be impossible to clear entirely with White Wash. To return to normal viewing, press the any button.

POWER SAVING PICTURE MODE - *Only Plasma TV*

Low power reduces the plasma display power consumption.



- 1   Select **OPTION**.
- 2   Select **Power Saving**.
- 3   Select **Level 0, Level 1, Level 2, Level 3, or Level 4**.
- 4  Return to the previous menu.
-  Return to TV viewing





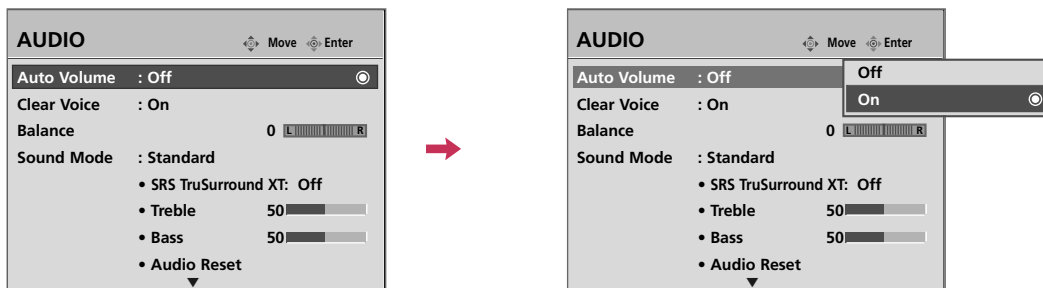

■ Level 0 is the brightest.

SOUND & LANGUAGE CONTROL

AUTO VOLUME LEVELLER (AUTO VOLUME)

Scans for changes in sound levels during commercials, then adjusts the sound to match the specified audio level. Auto Volume makes sure that the volume level remains consistent whether you are watching a commercial or a regular TV program.

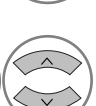

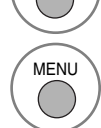





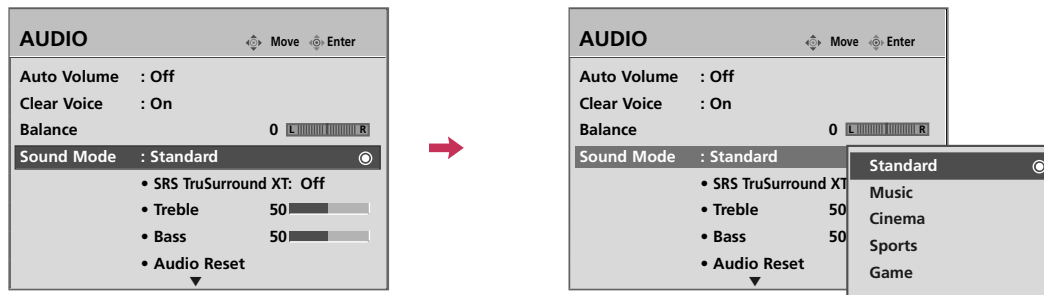

-   Select **AUDIO**.
-   Select **Auto Volume**.
-   Select **On** or **Off**.
-  Return to the previous menu.
-  Return to TV viewing

PRESET SOUND SETTINGS (SOUND MODE)

Sound Mode lets you enjoy the best sound without any special adjustment as the TV sets the appropriate sound options based on the program content.

Standard, Music, Cinema, Sports, and Game are preset for optimum sound quality at the factory and are not adjustable.









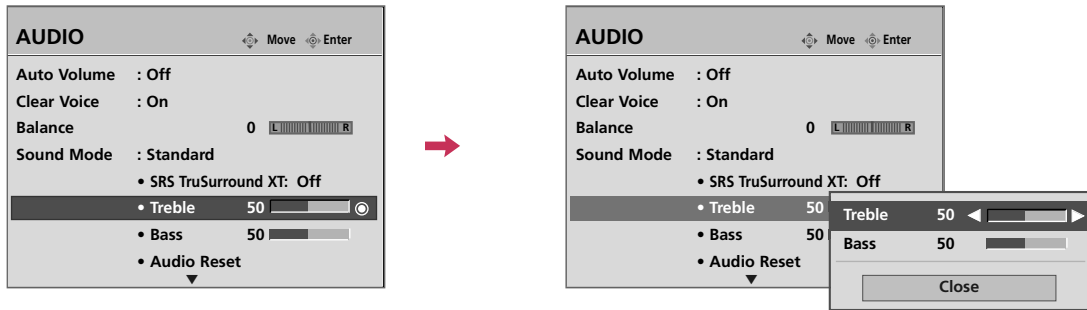

-   Select **AUDIO**.
-   Select **Sound Mode**.
-   Select **Standard, Music, Cinema, Sports, or Game**.
-  Return to the previous menu.
-  Return to TV viewing

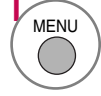

■ You can also adjust **Sound Mode** in the **Q. Menu**.

SOUND SETTING ADJUSTMENT - USER MODE





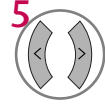

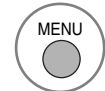
Adjust the sound to suit your taste and room situations.



- 1   Select **AUDIO**.
- 2   Select **Sound Mode**.
- 3   Select **Standard, Music, Cinema, Sports, or Game**.
- 4   Select **Treble or Bass**.

- 5  Make appropriate adjustments.
- 6  Return to the previous menu.
-  Return to TV viewing

SRS TRUSURROUND XT

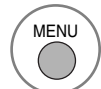





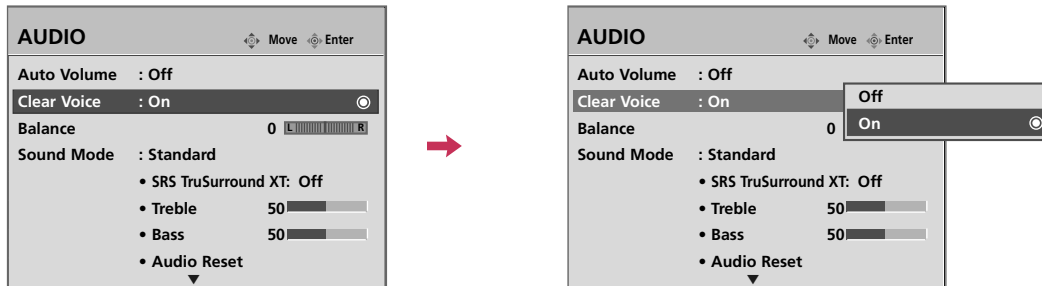

- 1   Select **AUDIO**.
- 2   Select **SRS TruSurround XT**
- 3   Select **On or Off**.
- 4  Return to the previous menu.
-  Return to TV viewing

■ **SRS TruSurround XT:** Takes advantage of any multi-channel format without needing to add extra speakers or equipment. Dialog clarity, bass enrichment, and the addition of stereo audio enhancement produces an immersive sound experience from standard stereo material.

CLEAR VOICE

By differentiating the human sound range from others, it helps users listen to human voices better.



- 1   Select **AUDIO**.
- 2   Select **Clear Voice**.
- 3   Select **On** or **Off**.
- 4  Return to the previous menu.
-  Return to TV viewing





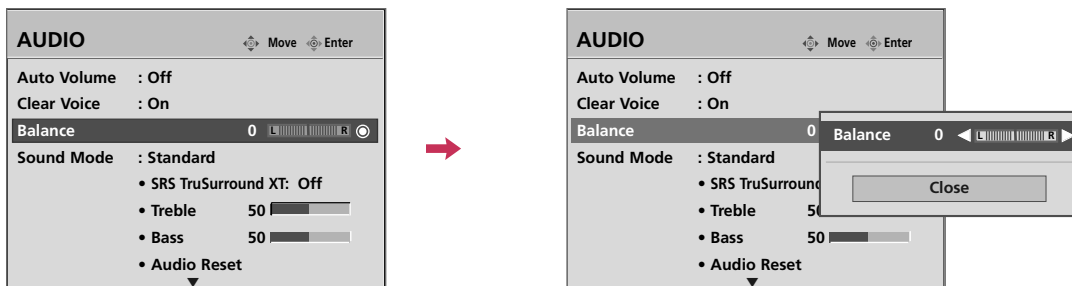

- If you select “Clear Voice-On”, SRS TruSurround XT feature will not work.
- You can also adjust Clear Voice in the Q-Menu.

SOUND & LANGUAGE CONTROL

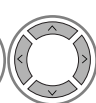
BALANCE

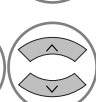
Adjust the left/right sound of speaker to suit your taste and room situations.









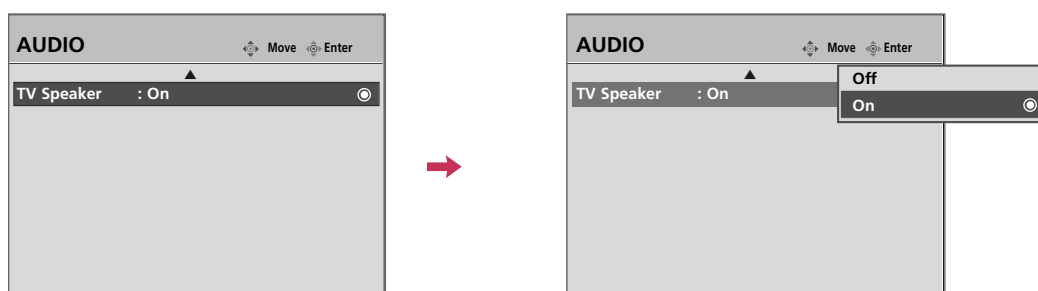

-   Select **AUDIO**.
-   Select **Balance**.
-   Make appropriate adjustments.
-  Return to the previous menu.
-  Return to TV viewing

TV SPEAKERS ON/OFF SETUP

Turn the TV speakers off if using external audio equipment. Feature turns the TV Speakers option On or Off.







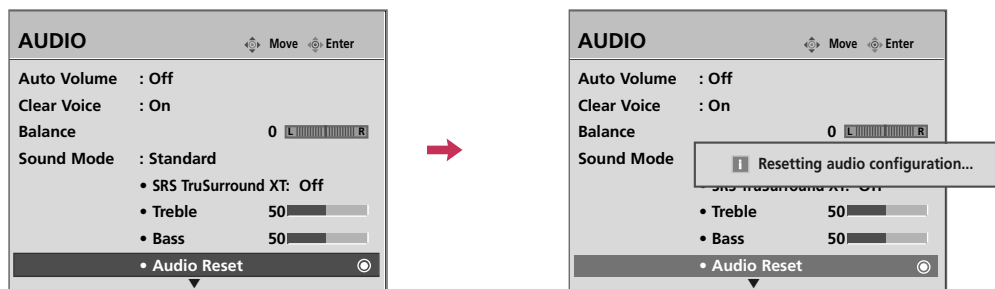

-   Select **AUDIO**.
-   Select **TV Speaker**.
-   Select **On** or **Off**.
-  Return to the previous menu.
-  Return to TV viewing

SOUND & LANGUAGE CONTROL

AUDIO RESET

Returns to the default factory setting for Sound Mode, Auto Volume and Balance.



-   Select **AUDIO**.
-   Select **Audio Reset**.
-  Initialize the adjusted value.
-  Return to TV viewing

STEREO/SAP BROADCAST SETUP

This TV can receive MTS stereo programs and any SAP (Secondary Audio Program) that accompanies the stereo program if the station transmits an additional sound signal as well as the original one and when you select Stereo or SAP on the remote control.

Mono sound is automatically received if the broadcast is only in Mono; even though Stereo or SAP has been selected.

Select Mono if you want to listen to the mono sound in remote areas during stereo/SAP broadcasting.

Stereo or SAP can be received in Analog channel.

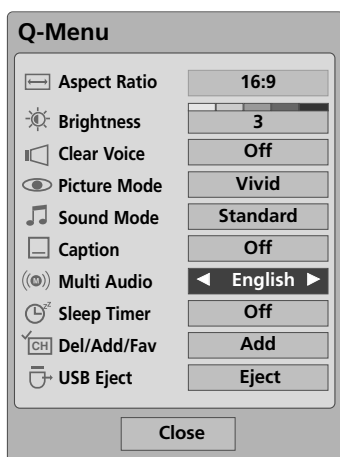

1   Select **Multi Audio**.

2  Analog signal: Select **Mono**, **Stereo**, or **SAP**.
Digital signal: Select other languages.

3  Return to TV viewing

SOUND & LANGUAGE CONTROL

AUDIO LANGUAGE

Other languages may be available if a digital signal is provided by the broadcasting station.

This feature operates only in DTV/CADTV mode.

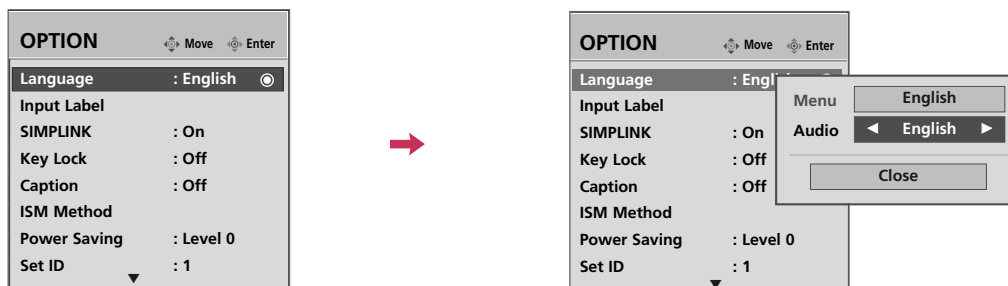







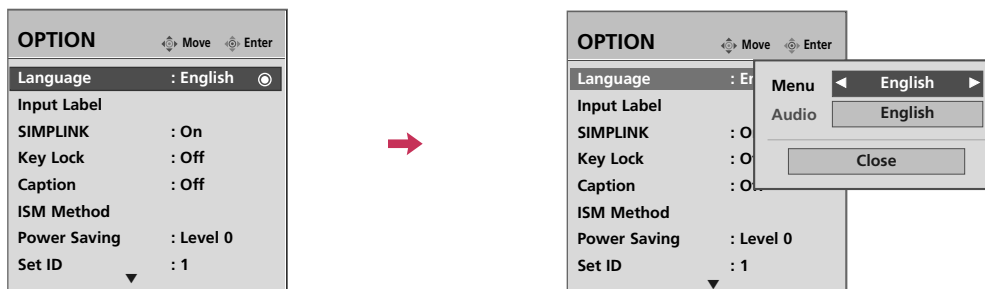

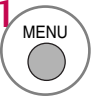
-   Select **OPTION**.
-   Select **Language**.
-   Select **Audio**.
-  Select your desired language:
English, Spanish, or French
-  Return to the previous menu.
-  Return to TV viewing

ON-SCREEN MENUS LANGUAGE SELECTION

The menus can be shown on the screen in the selected language. First select your language.



-   Select **OPTION**.
-   Select **Language**.
-   Select **Menu**.
-  Select your desired language.
From this point on, the on-screen menus will be shown in the selected language.
-  Return to the previous menu.
-  Return to TV viewing

SOUND & LANGUAGE CONTROL

CAPTION MODE

Analog Broadcasting System Captions

Caption must be provided to help people with hearing loss watch TV.







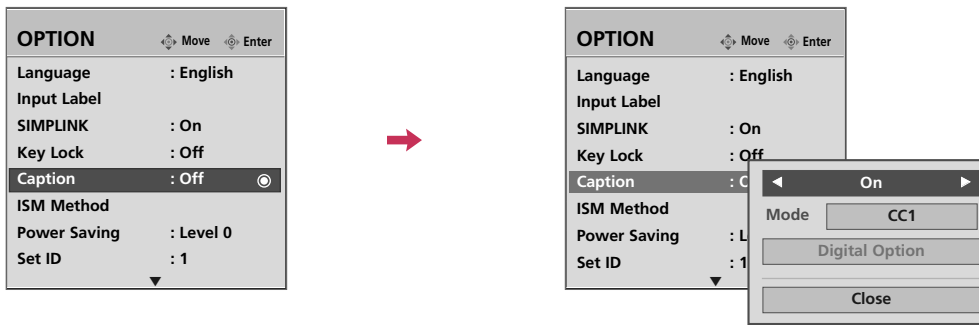

Select a caption mode for displaying captioning information if provided on a program. Analog caption displays information at any position on the screen and is usually the program's dialog.

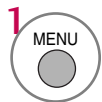
Caption/Text, if provided by the broadcaster, would be available for both digital and analog channels on the Antenna/Cable.

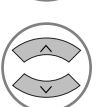
This TV is programmed to memorize the caption/text mode which was last set when you turn the power off.

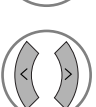
This function is only available when **Caption Mode** is set **On**.

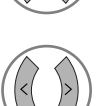

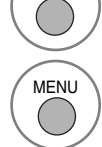
-   Select **OPTION**.
-   Select **Caption**
-   Select **On**.
-   Select **CC1-4** or **Text1-4**.
-  Return to the previous menu.
-  Return to TV viewing

- When selecting **Off**, Sub-menus for Analog, DTV, and Digital Option become disabled.
- **CAPTION**
The term for the words that scroll across the bottom of the TV screen; usually the audio portion of the program provided for the hearing impaired.
- **TEXT**
The term for the words that appear in a large black frame and almost cover the entire screen; usually messages provided by the broadcaster.
- You can also adjust **Aspect Ratio** in the **Q-Menu**.









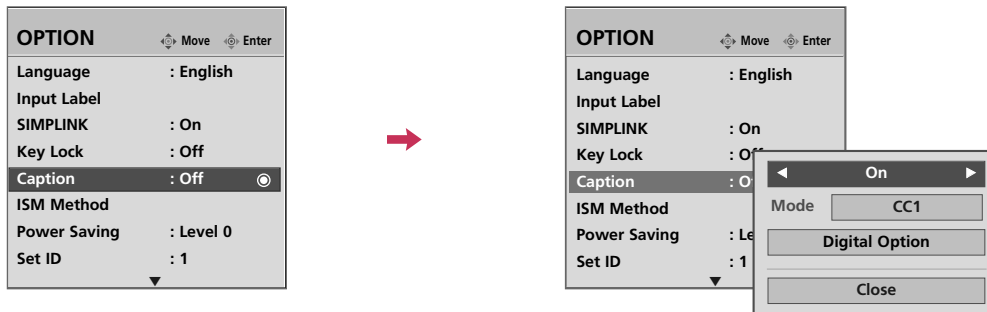

Digital Broadcasting System Captions

Choose the language you want the DTV/CADTV Captions to appear in.

Other Languages can be chosen for digital sources only if they are included on the program.

This function is only available when **Caption Mode** is set **On**.











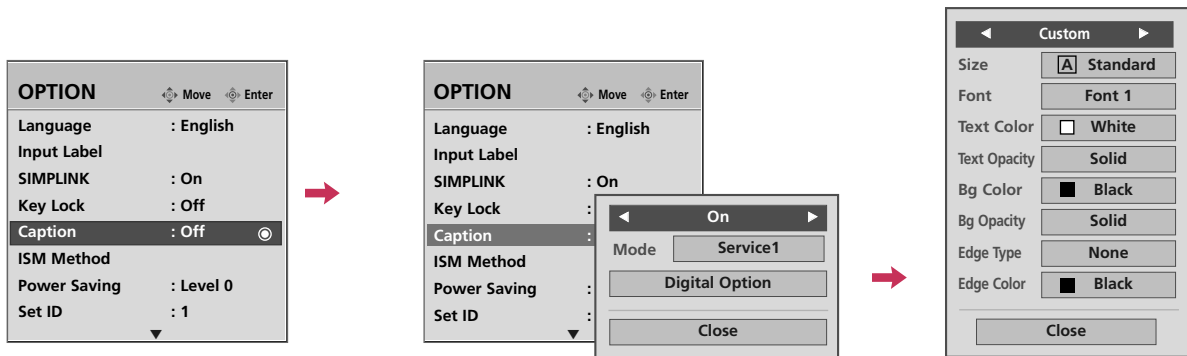





- 1   Select **OPTION**.
- 2   Select **Caption**
- 3   Select **On**.
- 4   Select **CC1-4, Text1-4, or Service1 - 6**.
- 5  Return to the previous menu.
-  Return to TV viewing

SOUND & LANGUAGE CONTROL

Caption Option

Customize the DTV/CADTV captions that appear on your screen.
This function is only available when Caption Mode is set On.



- 1   Select **OPTION**.
- 2   Select **Caption**
- 3   Select **On**.
- 4   Select **Digital Option**.
- 5   Select **Custom**.
- 6   Customize the **Style, Font**, etc., to your preference. A preview icon is provided at the bottom of the screen, use it to see the caption language.
- 7  Return to the previous menu.
-  Return to TV viewing

- **Size:** Set the word size.
- **Font:** Select a typeface for the text.
- **Text Color:** Choose a color for the text.
- **Text Opacity:** Specify the opacity for the text color.
- **Bg (Background) Color:** Select a background color.
- **Bg (Background) Opacity:** Select the opacity for the background color.
- **Edge Type:** Select an edge type.
- **Edge Color:** Select a color for the edges.

TIME SETTING

CLOCK SETTING









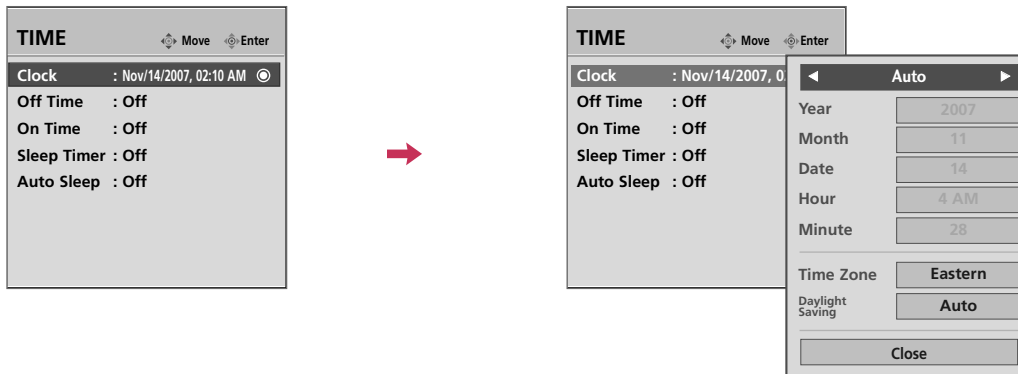



Auto Clock Setup

The time is set automatically from a digital channel signal.

The digital channel signal includes information for the current time provided by the broadcasting station.

Set the clock manually if the current time is set incorrectly by the auto clock function.









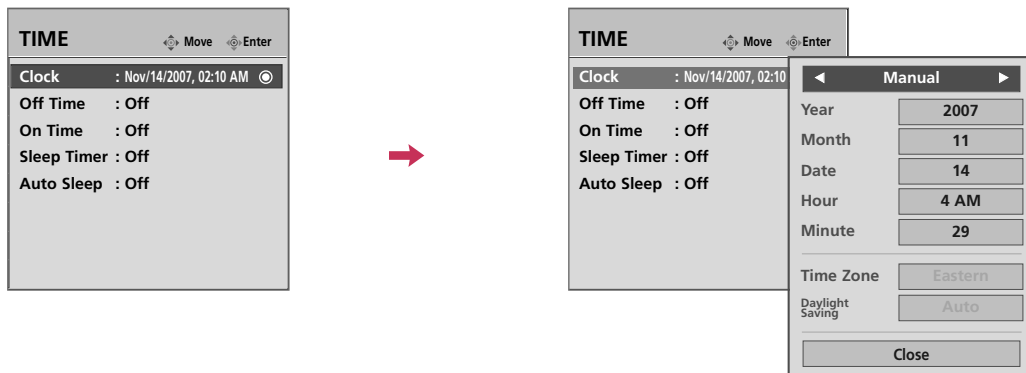

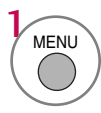
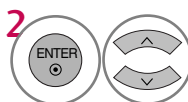
- 1   Select **TIME**.
- 2   Select **Clock**.
- 3   Select **Auto**.
- 4   Select your viewing area time zone.
 - U.S.A: **Eastern, Central, Mountain, Pacific, Alaska, or Hawaii.**
 - Canada: **Eastern, Central, Mountain, Pacific, New F.land, or Atlantic.**
- 5   Select **Auto, Off, or On** (depending on whether or not your viewing area observes Daylight Saving time).
- 6  Return to the previous menu.
-  Return to TV viewing

Manual Clock Setup

If the current time setting is wrong, reset the clock manually.

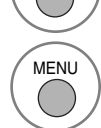

-   Select **TIME**.
-   Select **Clock**.
-   Select **Manual**.
-  Select the Year, Month, Date, Hour, or Minutes option.
-  Set the Year, Month, Date, Hour, or Minutes option.
-  Return to the previous menu.
-  Return to TV viewing

AUTO ON/OFF TIMER SETTING





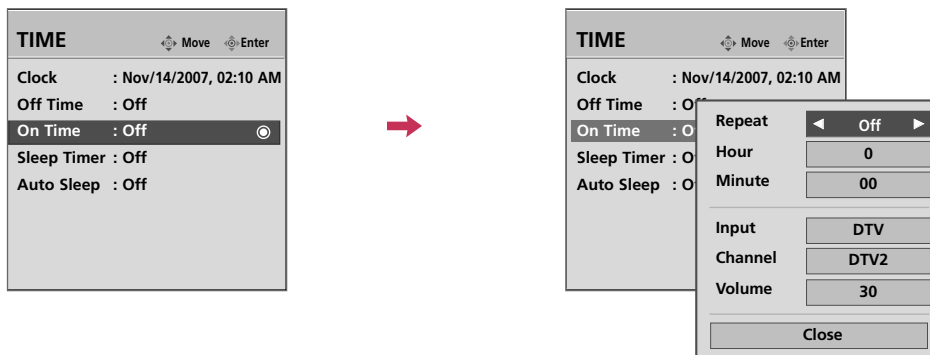

This function operates only if the current time has been set.

The **Off Time** function overrides the **On Time** function if they are both set to the same time.







The TV must be in standby mode for the **On Time** to work.

If you do not press any button within 2 hours after the TV turns on with the **On Time** function, the TV will automatically revert to standby mode.



- 1   Select **TIME**.
- 2   Select **Off time** or **On time**.
- 3   Select **Repeat**.
- 4  Select **Once, Everyday, Mon~Fri, Mon~Sat, Weekend, or Sunday**.
- 5   Select and set **Hour** or **Minute**.
- 6  Return to the previous menu.
-  Return to TV viewing







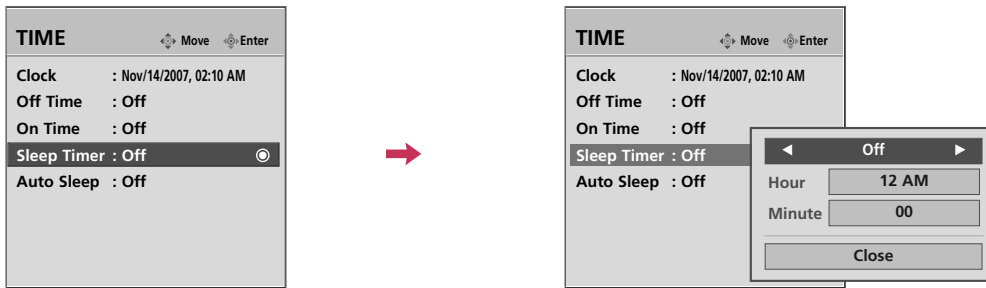

- To cancel **On/Off Time** function, select **Off**.
- Only for **On Time** function

- 1   Select **Input**.
- 2  Select **TV** or **Ext.Device**.
- 3   Set the channel at turn-on.
- 4   Adjust to sound level at turn-on.







SLEEP TIME SETTING

The Sleep Time turns the TV off at the preset time.
 Note that this setting is cleared when the TV is turned off.



- 1   Select **TIME**.
- 2   Select **Sleep Timer**.
- 3   Select **10, 20, 30, 60, 90, 120, 180, 240** minutes or **User**.
- 4  Return to the previous menu.
-  Return to TV viewing

■ Only for **User** option







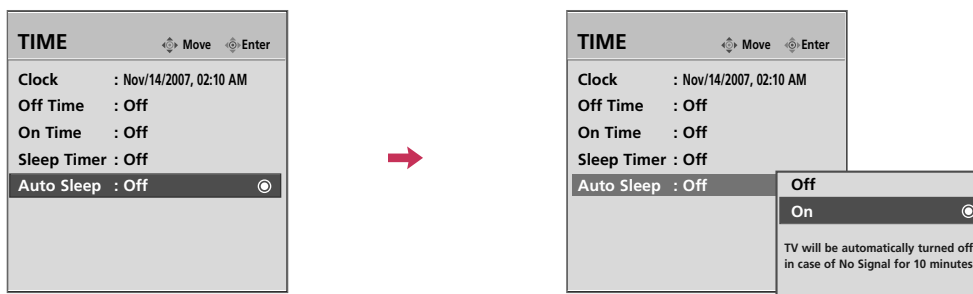

- 1   Select **User**.
- 2   Set the hour.
- 3   Set the minutes.

■ You can also adjust **Sleep Timer** in the **Q-Menu**.

AUTO SHUT-OFF SETTING

TV will be automatically turned off, in case of no signal for 10 minutes.



- 1   Select **TIME**.
- 2   Select **Auto Sleep**.
- 3   Select **On** or **Off**.
- 4  Return to the previous menu.
-  Return to TV viewing

PARENTAL CONTROL / RATINGS

Parental Control can be used to block specific channels, ratings and other viewing sources.

The Parental Control Function (V-Chip) is used to block program viewing based on the ratings sent by the broadcasting station. The default setting is to allow all programs to be viewed. Viewing can be blocked by choosing the type of the program and the categories. It is also possible to block all program viewing for a time period. To use this function, the following must be done :

1. Set ratings and categories to be blocked.
2. Specify a password
3. Enable the lock

V-Chip rating and categories

Rating guidelines are provided by broadcasting stations. Most television programs and television movies can be blocked by TV Rating and/or Individual Categories. Movies that have been shown at the theaters or direct-to-video movies use the Movie Rating System (MPAA) only.

Ratings for Television programs including made-for-TV movies :



- TV-G (General audience)
- TV-PG (Parental guidance suggested)
- TV-14 (Parents strongly cautioned)
- TV-MA (Mature audience only)
- TV-Y (All children)
- TV-Y7 (Children 7 years older)

SET PASSWORD & LOCK SYSTEM

Setting up Your Password

Set up blocking schemes to block specific channels, ratings, and external viewing sources. A password is required to gain access to this menu.



1    Select **LOCK**.



2  Input the password.

- Enter the password as requested.
- The TV is set up with the initial password "0-0-0-0".

Lock System

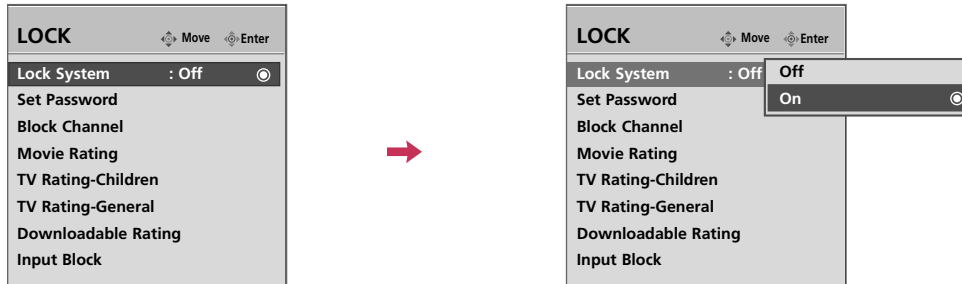
Enables or disables the blocking scheme you set up previously.





1    Select **LOCK**.

2  Input the password.

3  Select **Lock System**.

4   Select **On** or **Off**.

5  Return to the previous menu.

 Return to TV viewing



- When you select **On**, the Lock System is enable.

PARENTAL CONTROL / RATINGS

Set Password

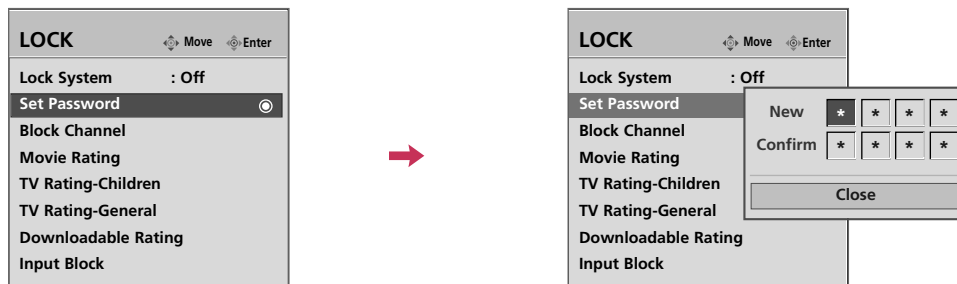
Change the password by inputting a new password twice.



1    Select **LOCK**.

2  Input the password.

3  Select **Set password**.

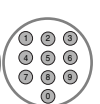
4   Choose any 4 digits for your new password.
As soon as the 4 digits are entered, re-enter the same 4 digits on the **Confirm**.

5  Return to the previous menu.

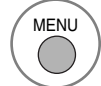
 Return to TV viewing

CHANNEL BLOCKING

Blocks any channels that you do not want to watch or that you do not want your children to watch.

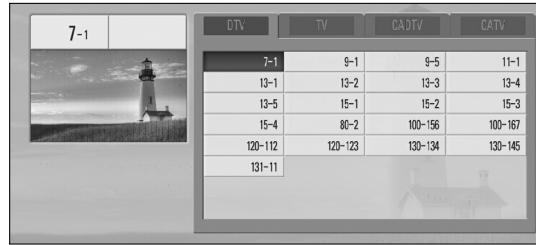

MENU Previous CH Move Page Navigate Block/Unblock RETURN Exit

1 MENU Select **LOCK**.

2 Input the password.

3 Select **Block Channel**.

4 Select a channel to block or unblock it.

5 Block or unblock a channel.

6 RETURN Return to the previous menu.

MENU Return to TV viewing



PARENTAL CONTROL / RATINGS

MOVIE & TV RATING

Movie Rating (MPAA) - Only for USA

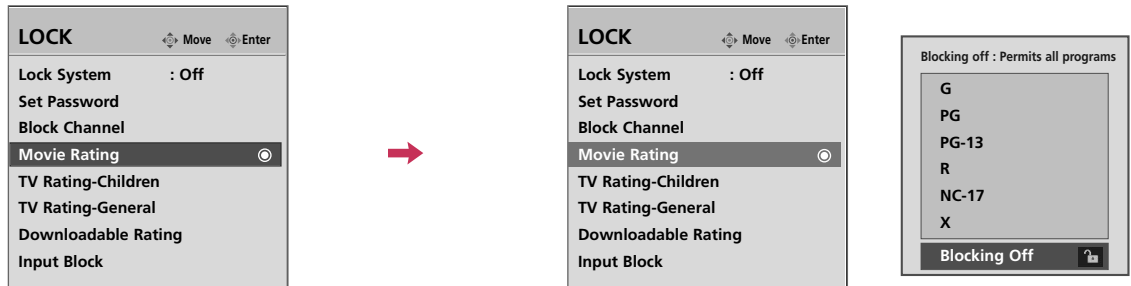
Blocks movies according to the movie ratings limits specified, so children cannot view certain movies. You can set the ratings limit by blocking out all the movies with the ratings above a specified level. Keep in mind that the movie ratings limit only applies to movies shown on TV, not TV programs, such as soap operas.



1    Select **LOCK**.

2  Input the password.

3  Select **Movie Rating**.

4   Select **G, PG, PG-13, R, NC-17 or X**.

5  Return to the previous menu.

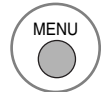

 Return to TV viewing

- G (General audience)
- PG (Parental guidance suggested)
- PG-13 (Parents strongly cautioned)
- R (Restricted)
- NC-17 (No one 17 and under admitted)
- X (Adult only)
- Blocking Off (Permits all programs)
- ▶ If you set PG-13: G and PG movies will be available, PG-13, R, NC-17 and X will be blocked.

TV Rating Children - Only for USA

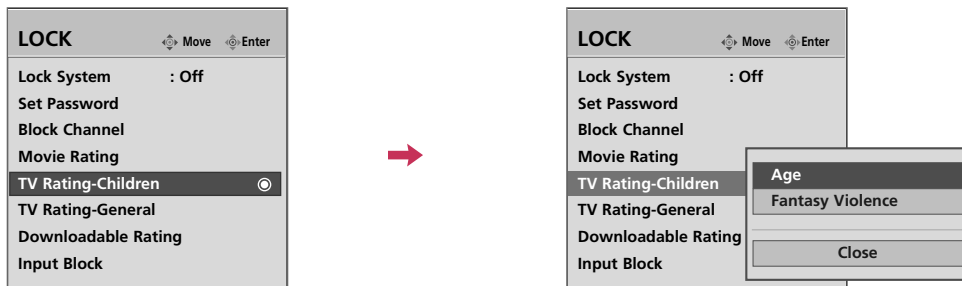
Prevents children from watching certain children's TV programs, according to the ratings limit set. The children rating does not apply to other TV programs. Unless you block certain TV programs intended for mature audiences in the TV Rating - sub menu, your children can view those programs.



1    Select **LOCK**.

2  Input the password.

3  Select **TV Rating-Children**.

4   Select **Age** or **Fantasy Violence**.

5   Select block options.

6  Return to the previous menu.

 Return to TV viewing



- Age (applies to TV-Y, TV-Y7)
- Fantasy Violence (applies to TV-Y7)

PARENTAL CONTROL /RATINGS

TV Rating General - Only for USA

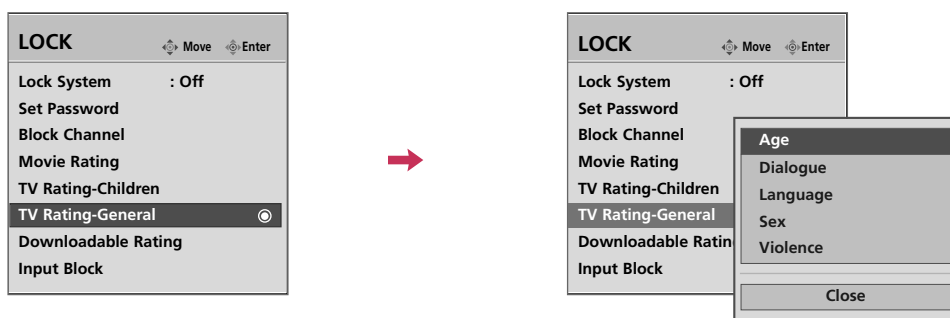
Based on the ratings, blocks certain TV programs that you and your family do not want to view.



1    Select **LOCK**.

2  Input the password.

3  Select **TV Rating-General**.

4   Select **Age, Dialogue, Language, Sex or Violence**.

5   Select block options.

6  Return to the previous menu.



 Return to TV viewing

- Age: Applies to TV-G,TV-PG,TV-14,TV-MA.
- Dialogue-sexual dialogue: Applies to TV-PG,TV-14.
- Language-adult language: Applies to TV-PG, TV-14, TV-MA.
- Sex-sexual situations: Applies to TV-PG, TV-14, TV-MA.
- Violence: Applies to TV-PG, TV-14, TV-MA.

TV Rating English - Only for CANADA

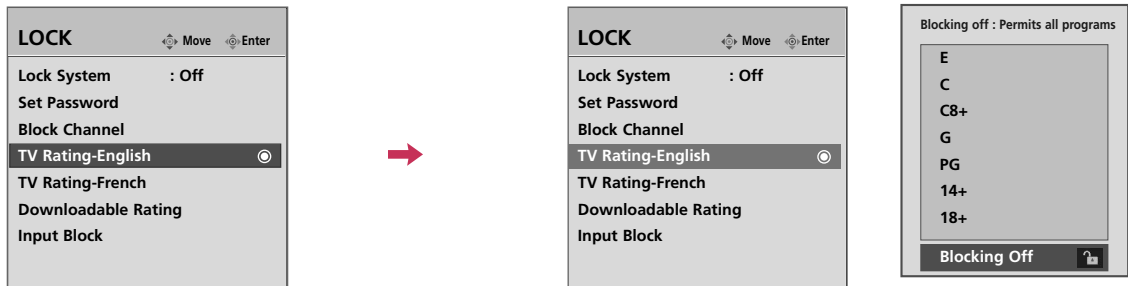

Selecting canadian english language rating system.





1    Select **LOCK**.

2  Input the password.

3  Select **TV Rating-English**.

4   Select **E, C, C8+, G, PG, 14+, 18+, or Blocking Off**.

5  Return to the previous menu.

 Return to TV viewing



- E: Exempt
- C: Children
- C8+: Children eight years and older
- G: General programming, suitable for all audiences
- PG: Parental Guidance
- 14+: Viewers 14 years and older
- 18+: Adult programming
- Blocking Off: Permits all programs

PARENTAL CONTROL / RATINGS

TV Rating French - *Only for CANADA*

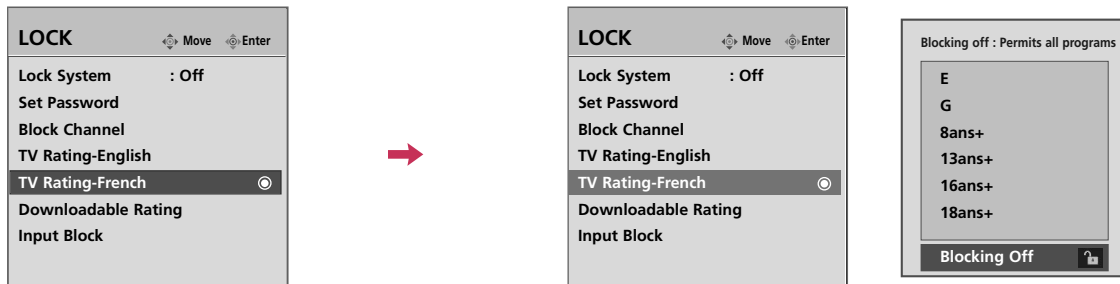

Selecting canadian french language rating system.



1    Select **LOCK**.

2  Input the password.

3  Select **TV Rating-French**.

4   Select **E, G, 8ans+, 13ans+, 16ans+, 18ans+, or Blocking off**.

5  Return to the previous menu.

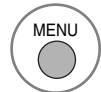

 Return to TV viewing

- E: Exempt
- G: General
- 8ans+: General-Not convenient for little children
- 13ans+: Not convenient for children of 13 years and younger
- 16ans+: Not convenient for children of 16 years and younger
- 18ans+: This programs is only for adults
- Blocking off: Permits all programs

DOWNLOADABLE RATING

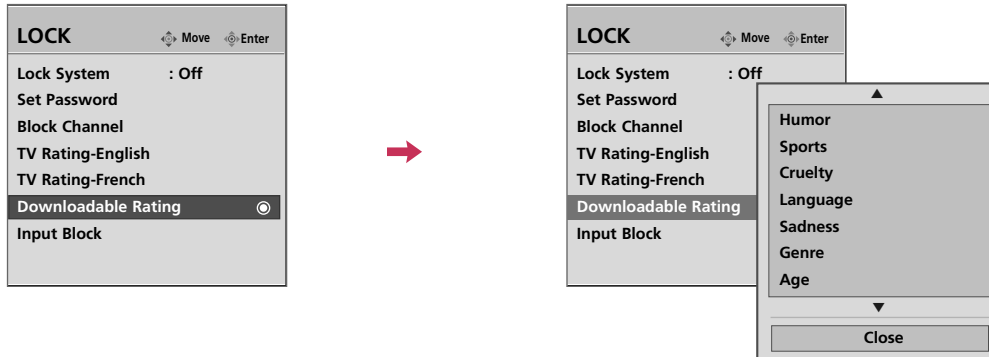

This function may become available in the future and will be available only for digital channel signal. This function operates only when TV has received Region5 Rating data.





1    Select **LOCK**.

2  Input the password.

3  Select **Downloadable Rating**.

4   Select desired **Downloadable Rating** option.

5   Select desired **Humor, Sports, Cruelty, Language, Sadness, Genre, Age, or Movie** option.

6   Select block options.

7  Return to the previous menu.

 Return to TV viewing

■ Based on rating table, your TV's OSD (On Screen Display) may differ slightly from what is shown in this manual.

PARENTAL CONTROL /RATINGS

EXTERNAL INPUT BLOCKING

Enables you to select a source to block from the external source devices you have hooked up.

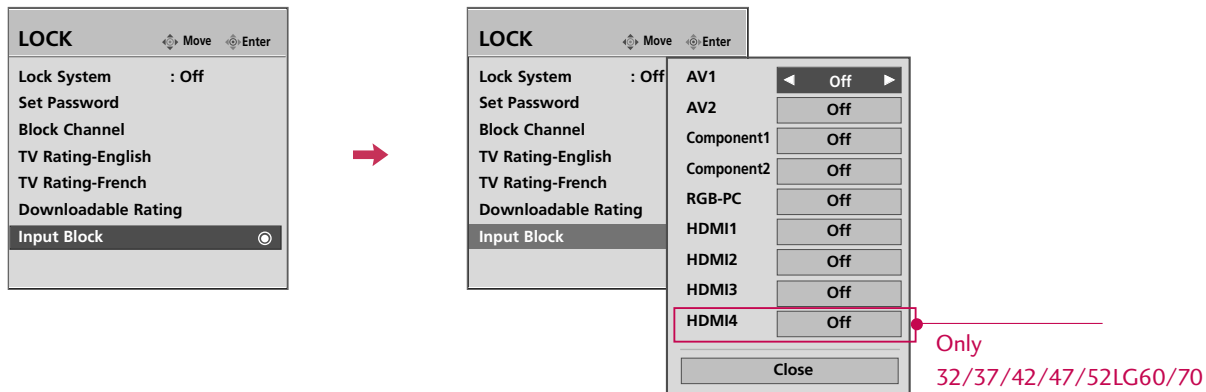

1 MENU Select LOCK.

2 Input the password.

3 Select Input Block.

4 Select input source.

5 Select On or Off.

6 RETURN Return to the previous menu.

MENU Return to TV viewing







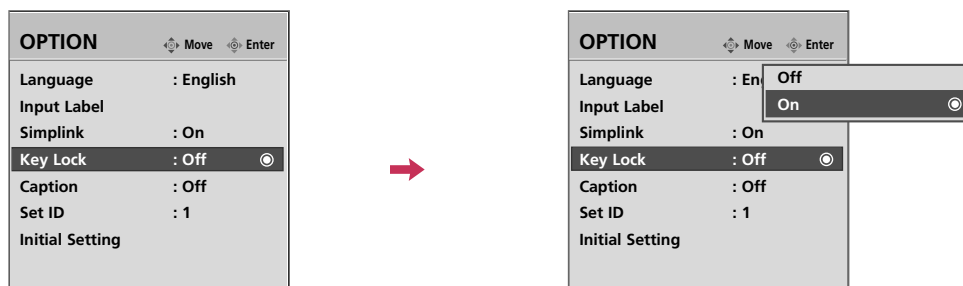

KEY LOCK

The TV can be set up so that it can only be used with the remote control.

This feature can be used to prevent unauthorized viewing by locking out the front panel controls.

This TV is programmed to remember which option it was last set to even if you turn the TV off.



-   Select **OPTION**.
-   Select **Key Lock**.
-   Select **On** or **Off**.
-  Return to the previous menu.
-  Return to TV viewing

- In **Key Lock 'On'**, if the TV is turned off, press the **⏻ / I**, **INPUT**, **CH ▲** or **▼** button on the TV or **POWER**, **INPUT**, **CH ▲ ▼** or **NUMBER** buttons on the remote control.
- With the **Key Lock On**, the display '**Key Lock On**' appears on the screen if any button on the front panel is pressed while viewing the TV.

APPENDIX

TROUBLESHOOTING

The operation does not work normally.

The remote control doesn't work	<ul style="list-style-type: none"> ■ Check to see if there is any object between the product and the remote control causing obstruction. Ensure you are pointing the remote control directly at the TV. ■ Ensure that the batteries are installed with correct polarity (+ to +, - to -). ■ Ensure that the correct remote operating mode is set: TV, VCR etc. ■ Install new batteries.
Power is suddenly turned off	<ul style="list-style-type: none"> ■ Is the sleep timer set? ■ Check the power control settings. Power interrupted. ■ No broadcast on station tuned with Auto off activated.

The video function does not work.

No picture & No sound	<ul style="list-style-type: none"> ■ Check whether the product is turned on. ■ Try another channel. The problem may be with the broadcast. ■ Is the power cord inserted into wall power outlet? ■ Check your antenna direction and/or location. ■ Test the wall power outlet, plug another product's power cord into the outlet where the product's power cord was plugged in.
Picture appears slowly after switching on	<ul style="list-style-type: none"> ■ This is normal, the image is muted during the product startup process. Please contact your service center, if the picture has not appeared after five minutes.
No or poor color or poor picture	<ul style="list-style-type: none"> ■ Adjust Color in menu option. ■ Keep a sufficient distance between the product and the VCR. ■ Try another channel. The problem may be with the broadcast. ■ Are the video cables installed properly? ■ Activate any function to restore the brightness of the picture.
Horizontal/vertical bars or picture shaking	<ul style="list-style-type: none"> ■ Check for local interference such as an electrical appliance or power tool.
Poor reception on some channels	<ul style="list-style-type: none"> ■ Station or cable product experiencing problems, tune to another station. ■ Station signal is weak, reorient antenna to receive weaker station. ■ Check for sources of possible interference.
Lines or streaks in pictures	<ul style="list-style-type: none"> ■ Check antenna (Change the direction of the antenna).

The audio function does not work.

Picture OK & No sound	<ul style="list-style-type: none">■ Press the VOL or VOLUME button.■ Sound muted? Press MUTE button.■ Try another channel. The problem may be with the broadcast.■ Are the audio cables installed properly?
No output from one of the speakers	<ul style="list-style-type: none">■ Adjust Balance in menu option.
Unusual sound from inside the product	<ul style="list-style-type: none">■ A change in ambient humidity or temperature may result in an unusual noise when the product is turned on or off and does not indicate a fault with the product.

There is a problem in PC mode. (Only PC mode applied)

The signal is out of range	<ul style="list-style-type: none">■ Adjust resolution, horizontal frequency, or vertical frequency.■ Check the input source.
Vertical bar or stripe on background & Horizontal Noise & Incorrect position	<ul style="list-style-type: none">■ Work the Auto configure or adjust clock, phase, or H/V position. (Option)
Screen color is unstable or single color	<ul style="list-style-type: none">■ Check the signal cable.■ Reinstall the PC video card.

MAINTENANCE

Early malfunctions can be prevented. Careful and regular cleaning can extend the amount of time you can enjoy your new TV.

Caution: Be sure to turn the power off and unplug the power cord before you begin any cleaning.

Cleaning the Screen

- 1 Here's a great way to keep the dust off your screen for a while. Wet a soft cloth in a mixture of lukewarm water and a little fabric softener or dish washing detergent. Wring the cloth until it's almost dry, and then use it to wipe the screen.
- 2 Make sure the excess water is off the screen, and then let it air-dry before you turn on your TV.

Cleaning the Cabinet

- To remove dirt or dust, wipe the cabinet with a soft, dry, lint-free cloth.
- Please be sure not to use a wet cloth.

Extended Absence

CAUTION

- ▶ If you expect to leave your TV dormant for a long time (such as a vacation), it's a good idea to unplug the power cord to protect against possible damage from lightning or power surges.

PRODUCT SPECIFICATIONS

MODELS		26LG30 (26LG30-UA)	32LG30 (32LG30-UA)
Dimensions (Width x Height x Depth)	With stand	26.1 x 20.0 x 9.1 inches 663.8 x 508.2 x 231.9 mm	31.8 x 23.8 x 9.1 inches 807.7 x 604.2 x 232.0 mm
	Without stand	26.1 x 17.7 x 3.6 inches 663.8 x 449.8 x 91.4 mm	31.8 x 21.4 x 4.0 inches 807.7 x 544.1 x 101.0 mm
Weight	With stand	22.3 pounds / 10.1 kg	29.1 pounds / 13.2 kg
	Without stand	19.0 pounds / 8.6 kg	25.4 pounds / 11.5 kg
MODELS		37LG30 (37LG30-UA)	42LG30 (42LG30-UA)
Dimensions (Width x Height x Depth)	With stand	36.2 x 26.9 x 11.6 inches 919.6 x 682.3 x 293.8 mm	40.7 x 29.2 x 11.6 inches 1032.8 x 742.3 x 293.8 mm
	Without stand	36.2 x 24.0 x 4.5 inches 919.6 x 610.3 x 114.3 mm	40.7 x 26.4 x 4.5 inches 1032.8 x 670.1 x 115.1 mm
Weight	With stand	45.6 pounds / 20.7 kg	51.8 pounds / 23.5 kg
	Without stand	37.9 pounds / 17.2 kg	44.1 pounds / 20.0 kg
MODELS		37LG50 (37LG50-UA)	42LG50 (42LG50-UA)
Dimensions (Width x Height x Depth)	With stand	36.9 x 27.0 x 11.6 inches 936.4 x 684.4 x 293.8 mm	36.9 x 27.0 x 11.6 inches 936.4 x 684.4 x 293.8 mm
	Without stand	36.9 x 24.1 x 3.5 inches 936.4 x 612.8 x 88.0 mm	36.9 x 24.1 x 3.5 inches 936.4 x 612.8 x 88.0 mm
Weight	With stand	40.3 pounds / 18.3 kg	40.3 pounds / 18.3 kg
	Without stand	34.4 pounds / 15.6 kg	34.4 pounds / 15.6 kg
MODELS		47LG50 (47LG50-UA)	52LG50 (52LG50-UA)
Dimensions (Width x Height x Depth)	With stand	45.4 x 31.8 x 12.8 inches 1153.7 x 807.2 x 326.0 mm	50.9 x 35.1 x 13.5 inches 1291.7 x 892.2 x 342.9 mm
	Without stand	45.4 x 29.0 x 4.1 inches 1153.7 x 734.5 x 103.0 mm	50.9 x 32.2 x 4.5 inches 1291.7 x 817.0 x 115.3 mm
Weight	With stand	85.1 pounds / 38.6 kg	87.1 pounds / 39.5 kg
	Without stand	77.0 pounds / 34.9 kg	77.0 pounds / 34.9 kg
Power requirement Television System Program Coverage External Antenna Impedance		AC100-240V ~ 50/60Hz NTSC-M, ATSC, 64 & 256 QAM VHF 2-13, UHF 14-69, CATV 1-135, DTV 2-69, CADTV 1-135 75 ohm	
Environment condition	Operating Temperature Operating Humidity	32 ~ 104°F (0 ~ 40°C) Less than 80%	
	Storage Temperature Storage Humidity	-4 ~ 140°F (-20 ~ 60°C) Less than 85%	

■ The specifications shown above may be changed without prior notice for quality improvement.

APPENDIX

MODELS		32LG60 (32LG60-UA)	37LG60 (37LG60-UA)	42LG60 (42LG60-UA)
Dimensions (Width x Height x Depth)	With stand	31.8 x 23.9x 9.8 inches 806.6 x 606.5 x 249.0mm	36.5 x 27.3 x 11.0 inches 927.0 x 692.8 x 280.5 mm	40.7 x 29.5 x 11.3 inches 1033.4 x 750.0 x 287.6 mm
	Without stand	31.8 x 21.7 x 3.1 inches 806.6 x 552.3 x 79.0 mm	36.5 x 24.8 x 3.5 inches 927.0 x 630.0 x 88.0 mm	40.7 x 27.0x 3.5 inches 1033.4 x 686.8 x 88.5 mm
Weight	With stand	30.2 pounds / 13.7 kg	44.1 pounds / 20.0 kg	54.9 pounds / 24.9 kg
	Without stand	24.7 pounds / 11.2 kg	35.3 pounds / 16.0 kg	45.0 pounds / 20.4 kg
MODELS		47LG60 (47LG60-UA)	52LG60 (52LG60-UA)	
Dimensions (Width x Height x Depth)	With stand	45.4 x 31.8 x 12.8 inches 1153.7 x 807.2 x 326.0 mm	50.9 x 35.1 x 13.5 inches 1291.7 x 892.2 x 342.9 mm	
	Without stand	45.4 x 29.0 x 4.1 inches 1153.7 x 734.5 x 103.0 mm	50.9 x 32.2 x 4.5 inches 1291.7 x 817.0 x 115.3 mm	
Weight	With stand	85.1 pounds / 38.6 kg	87.1 pounds / 39.5 kg	
	Without stand	77.0 pounds / 34.9 kg	77.0 pounds / 34.9 kg	
MODELS		32LG70 (32LG70-UA)	42LG70 (42LG70-UA)	
Dimensions (Width x Height x Depth)	With stand	31.8 x 23.9x 9.8 inches 806.6 x 606.5 x 249.0mm	40.7 x 29.5 x 11.3 inches 1033.4 x 750.0 x 287.6 mm	
	Without stand	31.8 x 21.7 x 3.1 inches 806.6 x 552.3 x 79.0 mm	40.7 x 27.0x 3.5 inches 1033.4 x 686.8 x 88.5 mm	
Weight	With stand	30.2 pounds / 13.7 kg	54.9 pounds / 24.9 kg	
	Without stand	24.7 pounds / 11.2 kg	45.0 pounds / 20.4 kg	
MODELS		47LG70 (47LG70-UA)	52LG70 (52LG70-UA)	
Dimensions (Width x Height x Depth)	With stand	45.4 x 31.8 x 12.8 inches 1153.7 x 807.2 x 326.0 mm	50.9 x 35.1 x 13.5 inches 1291.7 x 892.2 x 342.9 mm	
	Without stand	45.4 x 29.0 x 4.1 inches 1153.7 x 734.5 x 103.0 mm	50.9 x 32.2 x 4.5 inches 1291.7 x 817.0 x 115.3 mm	
Weight	With stand	85.1 pounds / 38.6 kg	87.1 pounds / 39.5 kg	
	Without stand	77.0 pounds / 34.9 kg	77.0 pounds / 34.9 kg	
Power requirement Television System Program Coverage External Antenna Impedance		AC100-240V ~ 50/60Hz NTSC-M, ATSC, 64 & 256 QAM VHF 2-13, UHF 14-69, CATV 1-135, DTV 2-69, CADTV 1-135 75 ohm		
Environment condition	Operating Temperature Operating Humidity	32 ~ 104°F (0 ~ 40°C) Less than 80%		
	Storage Temperature Storage Humidity	-4 ~ 140°F (-20 ~ 60°C) Less than 85%		

■ The specifications shown above may be changed without prior notice for quality improvement.

MODELS		42PG10 (42PG10-UA)	50PG10 (50PG10-UA)
Dimensions (Width x Height x Depth)	With stand	41.3 x 30.2 x 12.2 inches 1048.0 x 766.0 x 310.0 mm	48.9 x 34.9 x 14.6 inches 1242.0 x 887.6 x 370.0 mm
	Without stand	41.3 x 28.1 x 3.3 inches 1048.0 x 713.0 x 83.5 mm	48.9 x 32.6 x 3.5 inches 1242.0 x 827.2 x 88.0 mm
Weight	With stand	61.7 pounds / 28.0 kg	86.6 pounds / 39.3 kg
	Without stand	54.2 pounds / 24.6 kg	76.3 pounds / 34.6 kg
MODELS		42PG20 (42PG20-UA)	50PG20 (50PG20-UA)
Dimensions (Width x Height x Depth)	With stand	41.3 x 30.2 x 12.2 inches 1048.0 x 766.0 x 310.0 mm	48.9 x 34.9 x 14.6 inches 1242.0 x 887.6 x 370.0 mm
	Without stand	41.3 x 28.1 x 3.3 inches 1048.0 x 713.0 x 83.5 mm	48.9 x 32.6 x 3.5 inches 1242.0 x 827.2 x 88.0 mm
Weight	With stand	61.7 pounds / 28.0 kg	86.6 pounds / 39.3 kg
	Without stand	54.2 pounds / 24.6 kg	76.3 pounds / 34.6 kg
MODELS		50PG60F-UA (50PG60F-UA)	60PG60F-UA (60PG60F-UA)
Dimensions (Width x Height x Depth)	With stand	48.9 x 34.9 x 14.6 inches 1242.0 x 887.6 x 370.0 mm	57.3 x 38.8 x 16.3 inches 1455.0 x 985.0 x 414.0 mm
	Without stand	48.9 x 32.6 x 3.5 inches 1242.0 x 827.2 x 88.0 mm	57.3 x 38.5 x 15.8 inches 1455.0 x 914.8 x 82.8 mm
Weight	With stand	86.6 pounds / 39.3 kg	137.6 pounds / 62.4 kg
	Without stand	76.3 pounds / 34.6 kg	127.8 pounds / 58.0 kg
MODELS		50PG70F-UA (50PG70F-UA)	60PG70F-UA (60PG70F-UA)
Dimensions (Width x Height x Depth)	With stand	48.9 x 34.9 x 14.6 inches 1242.0 x 887.6 x 370.0 mm	57.5 x 38.5 x 15.8 inches 1459.4 x 976.8 x 401.0 mm
	Without stand	48.9 x 32.6 x 3.5 inches 1242.0 x 827.2 x 88.0 mm	57.5 x 38.5 x 15.8 inches 1459.4 x 914.8 x 82.8 mm
Weight	With stand	86.6 pounds / 39.3 kg	86.6 pounds / 39.3 kg
	Without stand	76.3 pounds / 34.6 kg	76.3 pounds / 34.6 kg
Power requirement Television System Program Coverage External Antenna Impedance		AC100-240V ~ 50/60Hz NTSC-M, ATSC, 64 & 256 QAM VHF 2-13, UHF 14-69, CATV 1-135, DTV 2-69, CADTV 1-135 75 ohm	
Environment condition	Operating Temperature Operating Humidity	32 ~ 104°F (0 ~ 40°C) Less than 80%	
	Storage Temperature Storage Humidity	-4 ~ 140°F (-20 ~ 60°C) Less than 85%	

■ The specifications shown above may be changed without prior notice for quality improvement.

PROGRAMMING THE REMOTE CONTROL

The provided universal remote control can be programmed to operate most remote-controllable devices. Note that the remote may not control all models of other brands.

Programming a code into a remote mode

- 1** Testing your remote control.
To find out whether your remote control can operate other components without programming, turn on a component such as a STB and press the corresponding mode button (such as **STB**) on the remote control, while pointing at the component. Test the **POWER** and **CH** \wedge \vee buttons to see if the component responds correctly. If the component does not operate correctly, the remote control requires programming to operate the device.
- 2** Switch on the component to be programmed, then press the corresponding mode button (such as **STB**) on the remote control. The remote control button of the desired device is illuminated.
- 3** Press the **MENU** and **MUTE** buttons simultaneously, the remote control is ready to be programmed with the code.
- 4** Enter a code number using the number buttons on the remote control. Programming code numbers for the corresponding component can be found on the following pages. If the code is correct, the device will turn off.
- 5** Press the **MENU** button to store the code.
- 6** Test the remote control functions to see if the component responds correctly. If not, repeat from step 2.

VCR

Brand	Codes	Brand	Codes	Brand	Codes
AIWA	034	MAGNAVOX	031 033 034 041	SAMSUNG	032 040 102 104
AKAI	016 043 046 124 125 146		067 068		105 107 109 112
AMPRO	072	MARANTZ	012 031 033 067 069		113 115 120 122 125
ANAM	031 033 103	MARTA	101	SANSUI	022 043 048 135
AUDIO DYNAMICS	012 023 039 043	MATSUI	027 030	SANYO	003 007 010 014
BROKSONIC	035 037 129	MEI	031 033		102 134
CANON	028 031 033	MEMOREX	003 010 014 031 033 034 053 072 101 102 134 139	SCOTT	017 037 112 129 131
CAPEHART	108			SEARS	003 008 009 010 013 014 017 020 031 042 073 081 101
CRAIG	003 040 135	MGA	045 046 059	SHARP	031 054 149
CURTIS MATHES	031 033 041	MINOLTA	013 020	SHINTOM	024
DAEWOO	005 007 010 064 065 108 110 111 112 116 117 119	MITSUBISHI	013 020 045 046 049 051 059 061 151	SONY	003 009 031 052 056 057 058 076 077 078 149
DAYTRON	108	MTC	034 040	SOUNDESIGN	034
DBX	012 023 039 043	MULTITECH	024 034	STS	013
DYNATECH	034 053	NEC	012 023 039 043 048	SYLVANIA	031 033 034 059 067
ELECTROHOME	059	NORDMENDE	043	SYMPHONIC	034
EMERSON	006 017 025 027 029 031 034 035 036 037 046 101 129 131 138 153	OPTONICA	053 054	TANDY	010 034
FISHER	003 008 009 010	PANASONIC	066 070 074 083 133 140 145	TATUNG	039 043
FUNAI	034			TEAC	034 039 043
GE	031 033 063 072 107 109 144 147	PENTAX	013 020 031 033 063	TECHNICS	031 033 070
GO VIDEO	132 136	PHILCO	031 034 067	TEKNIKA	019 031 033 034 101
HARMAN KARDON	012 045	PHILIPS	031 033 034 054 067 071 101	THOMAS	034
HITACHI	004 018 026 034 043 063 137 150	PILOT	101	TMK	006
INSTANTREPLAY	031 033	PIONEER	013 021 048	TOSHIBA	008 013 042 047 059 082 112 131
JCL	031 033	PORTLAND	108		
JCPENNY	012 013 015 033 040 066 101	PULSAR	072	TOTEVISION	040 101
JENSEN	043	QUARTZ	011 014	UNITECH	040
JVC	012 031 033 043 048 050 055 060 130 150 152	QUASAR	033 066 075 145	VECTOR RESEARCH	012
KENWOOD	014 034 039 043 047 048	RCA	013 020 033 034 040 041 062 063 107 109 140 144 145 147	VICTOR	048
LG (GOLDSTAR)	001 012 013 020 101 106 114 123	REALISTIC	003 008 010 014 031 033 034 040 053 054 101	VIDEO CONCEPTS	012 034 046
LLOYD	034			VIDEOSONIC	040
LXI	003 009 013 014 017 034 101 106	RICO	058	WARDS	003 013 017 024 031 033 034 040 053 054 131
MAGIN	040	RUNCO	148	YAMAHA	012 034 039 043
		SALORA	014	ZENITH	034 048 056 058 072 080 101

APPENDIX

Remote Control Code

HDSTB

Brand	Codes	Brand	Codes	Brand	Codes
ALPHASTAR DSR	123	HOUSTON TRACKER	033 037 039 051	PROSAT	072
AMPLICA	050		057 104	RCA	066 106
BIRDVIEW	051 126 129	HUGHES	068	REALISTIC	043 074
CHANNEL MASTER	013 014 015 018 036 055	JANIEL	060 147	SAMSUNG	123
CHAPARRAL	008 009 012 077	JERROLD	061	SATELLITE SERVICE CO	028 035 047 057 085
CITOH	054	KATHREIN	108	SCIENTIFIC ATLANTA	032 138
CURTIS MATHES	050 145	LEGEND	057	SONY	103
DRAKE	005 006 007 010 011 052 112 116 141	LG	001	STARCAST	041
DX ANTENNA	024 046 056 076	LUTRON	132	SUPER GUIDE	020 124 125
ECHOSTAR	038 040 057 058 093 094 095 096 097 098 099 100 122	LUXOR	062 144	TEECOM	023 026 075 087 088 090 107 130 137
ELECTRO HOME	089	MACOM	010 059 063 064 065	TOSHIBA	002 127
EUROPLUS	114	MEMOREX	057	UNIDEN	016 025 042 043 044 045 048 049 078 079 080 086 101 135 136
FUJITSU	017 021 022 027 133 134	NEXTWAVE	028 124 125	VIEWSTAR	115
GENERAL INSTRUMENT	003 004 016 029 031 059 101	NORSAT	069 070	WINEGARD	128 146
HITACHI	139 140	PACE SKY SATELLITE	143	ZENITH	081 082 083 084 091 120
		PANASONIC	060 142		
		PANSAT	121		
		PERSONAL CABLE	117		
		PHILIPS	071		
		PICO	105		
		PRESIDENT	019 102		
		PRIMESTAR	030 110 111		

DVD

Brand	Codes	Brand	Codes	Brand	Codes
APEX DIGITAL	022	mitsubishi	002	RCA	005 006
DENON	020 014	NAD	023	SAMSUNG	011 015
GE	005 006	ONKYO	008 017	SONY	007
HARMAN KARDON	027	PANASONIC	003 009	THOMPSON	005 006
JVC	012	PHILIPS	013	TOSHIBA	019 008
LG	001 010 016 025	PIONEER	004 026	YAMAHA	009 018
MAGNAVOX	013	PROCEED	021	ZENITH	010 016 025
MARANTZ	024	PROSCAN	005 006		

IR CODES

1. How to Connect

- Connect your wired remote control to the Remote Control port on the TV.

2. Remote Control IR Codes

Output waveform

Single pulse, modulated with 37.917KHz signal at 455KHz

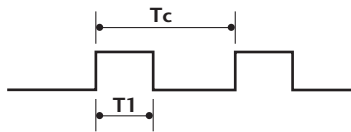

Carrier frequency
 $FCAR = 1/T_c = f_{OSC}/12$
 Duty ratio = $T_1/T_c = 1/3$

Configuration of frame

1st frame

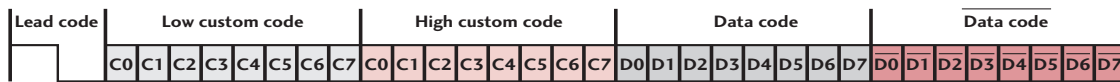

Repeat frame

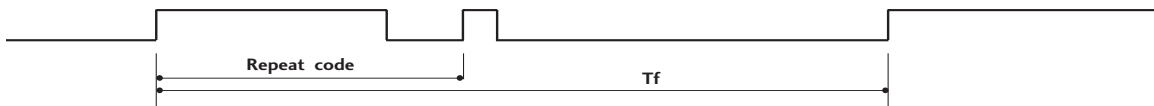

Lead code

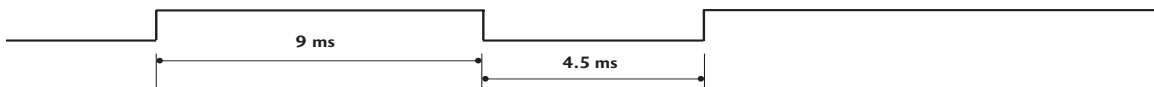

Repeat code

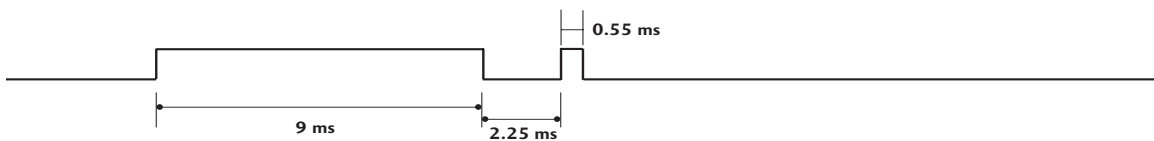

Bit description

Bit "0"

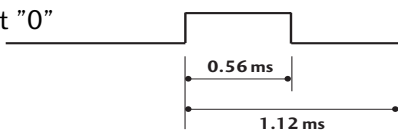

Bit "1"

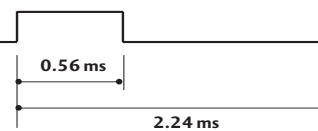

Frame interval: T_f

The waveform is transmitted as long as a key is depressed.

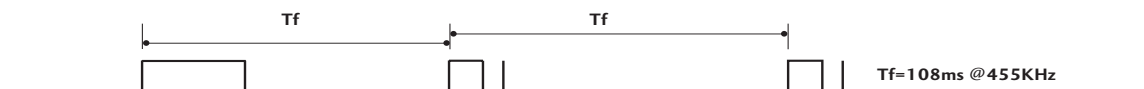

APPENDIX

Code (Hexa)	Function	Note
08	POWER	Remote control Button (Power On/Off)
45	Q.MENU	Remote control Button
43	MENU	Remote control Button
0B	INPUT	Remote control Button
10-19	Number Key 0-9	Remote control Button
4C	- (Dash)	Remote control Button
1A	FLASHBK	Remote control Button
09	MUTE	Remote control Button
02	VOL +	Remote control Button
03	VOL -	Remote control Button
00	CH ^	Remote control Button
01	CH v	Remote control Button
1E	FAV	Remote control Button
40	^	Remote control Button
41	v	Remote control Button
07	<	Remote control Button
06	>	Remote control Button
44	ENTER	Remote control Button
5B	RETURN	Remote control Button
7E	SIMPLINK	Remote control Button
30	AV MODE	Remote control Button
B0	PLAY	Remote control Button
BA	PAUSE	Remote control Button
B1	STOP	Remote control Button
BD	REC	Remote control Button
8F	REW	Remote control Button
8E	FF	Remote control Button

EXTERNAL CONTROL THROUGH RS-232C

The RS-232C port allows you connect the RS-232C input jack to an external control device (such as a computer or an A/V control system) to control the TV's functions externally.

- Note: RS-232C on this unit is intended to be used with third party RS-232C control hardware and software. The instructions below are provided to help with programming software or to test functionality using telenet software.

RS-232C Setup

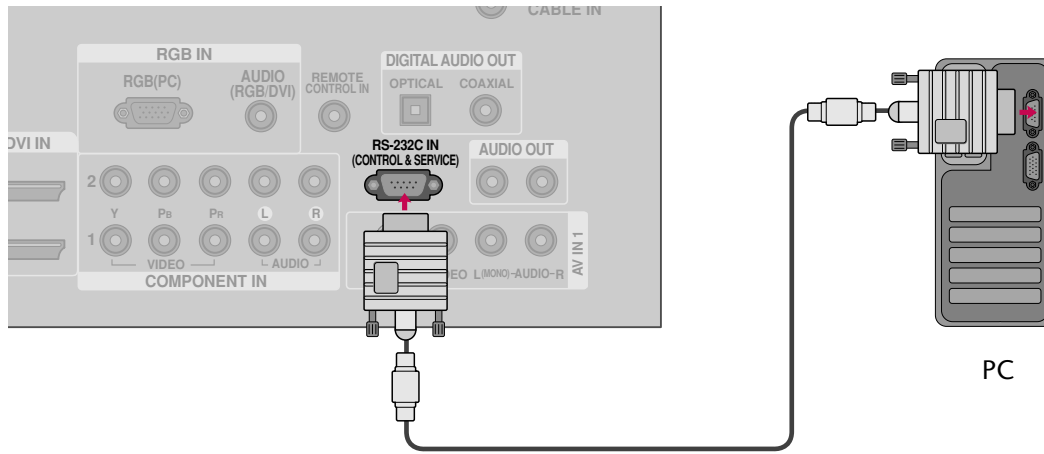

Type of Connector; D-Sub 9-Pin Male

No.	Pin Name
1	No connection
2	RXD (Receive data)
3	TXD (Transmit data)
4	DTR (DTE side ready)
5	GND
6	DSR (DCE side ready)
7	RTS (Ready to send)
8	CTS (Clear to send)
9	No Connection

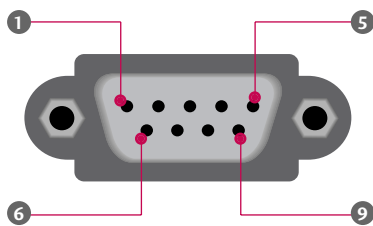

Communication Parameters

- Baud rate : 9600 bps (UART)
- Data length : 8 bits
- Parity : None
- Stop bit : 1 bit
- Communication code : ASCII code
- Use a crossed (reverse) cable.

! NOTE

- ▶ This product has command echo back in the RS-232C Command.

APPENDIX

RS-232C Configurations



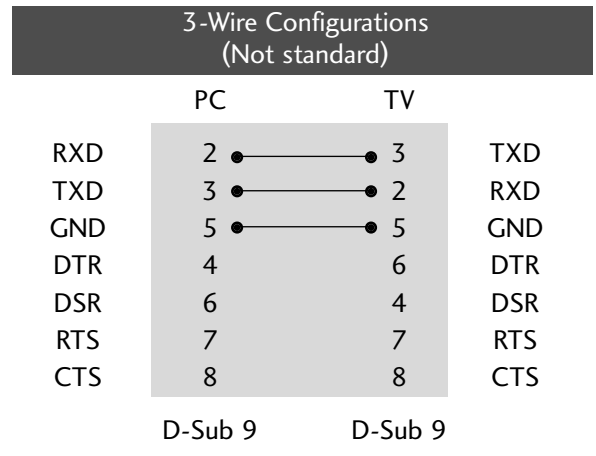
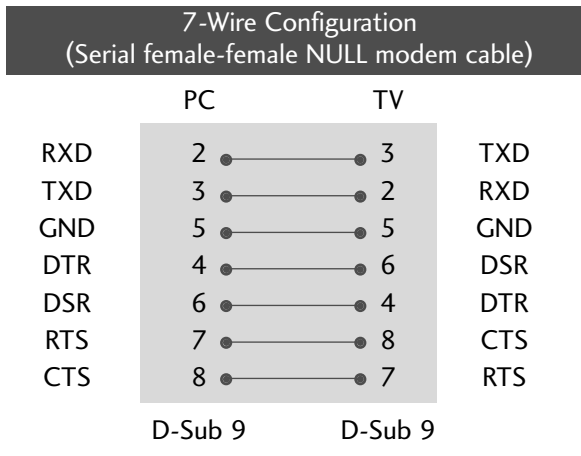



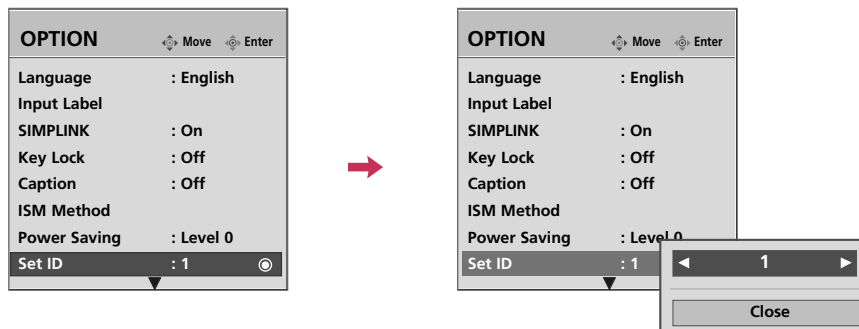

Either cable below can be used.



Set ID

Use this function to specify a TV ID number.
Refer to 'Real Data Mapping'. ► p.125.



- 1   Select **OPTION**.
- 2   Select **Set ID**.
- 3   Choose the desired TV ID number.
The adjustment range of Set ID is 1 ~ 99.
- 4  Return to the previous menu.
-  Return to TV viewing

Command Reference List

	COMMAND1	COMMAND2	DATA (Hexadecimal)		COMMAND1	COMMAND2	DATA (Hexadecimal)
01. Power	k	a	0 ~ 1	15. Treble	k	r	0 ~ 64
02. Input Select	k	b	(▶ p.124)	16. Bass	k	s	0 ~ 64
03. Input Select	x	b	(▶ p.124)	17. Balance	k	t	0 ~ 64
04. Aspect Ratio	k	c	(▶ p.124)	18. Color Temperature	k	u	0 ~ 3
05. Screen Mute	k	d	0 ~ 1	19. Red Adjustment	k	v	0 ~ C8
06. Volume Mute	k	e	0 ~ 1	20. Green Adjustment	k	w	0 ~ C8
07. Volume Control	k	f	0 ~ 64	21. Blue Adjustment	k	\$	0 ~ C8
08. Contrast	k	g	0 ~ 64	22. ISM Method	j	p	(▶ p.126)
09. Brightness	k	h	0 ~ 64	23. Low Power	j	q	0 ~ 1
10. Color	k	i	0 ~ 64	25. Channel Add/Del	m	b	0 ~ 1
11. Tint	k	j	0 ~ 64	26. Key	m	c	(▶ p.127)
12. Sharpness	k	k	0 ~ 64	27. Back Light	m	g	0 ~ 64
13. OSD Select	k	l	0 ~ 1				
14. Remote Control Lock Mode	k	m	0 ~ 1				

Only LCD TV Model

Only Plasma TV Model

	COMMAND1	COMMAND2	DATA0 (Hexadecimal)	DATA1 (Hexadecimal)	DATA2 (Hexadecimal)	DATA3 (Hexadecimal)	DATA4 (Hexadecimal)	DATA5 (Hexadecimal)
24. Channel Tuning	m	a	physical program high	major program low	major low	minor high	minor low	attribute

Transmission / Receiving Protocol

Transmission

[Command1][Command2][][Set ID][][Data][Cr]

[Command 1] : First command to control the set.(j, k, m or x)

[Command 2] : Second command to control the set.

[Set ID] : You can adjust the set ID to choose desired TV ID number in Setup menu. Adjustment range is 1 ~ 99. When selecting Set ID '0', every connected the TV is controlled. Set ID is indicated as decimal (1 ~ 99) on menu and as Hexa decimal (0x0 ~ 0x63) on transmission /receiving protocol.

[DATA] : To transmit the command data.

Transmit the 'FF' data to read status of command.

[Cr] : Carriage Return

ASCII code '0x0D'

[] : ASCII code 'space (0x20)'

* In this model, TV will not send the status during the standby mode.

OK Acknowledgement

[Command2][][Set ID][][OK][Data][x]

The TV transmits ACK (acknowledgement) based on this format when receiving normal data. At this time, if the data is data read mode, it indicates present status data. If the data is data write mode, it returns the data of the PC computer.

* In this model, TV will not send the status during the standby mode.

* Data Format

[Command 2] : Use as command.

[Set ID] : Use the small character, if set ID is 10, it will send the '0', 'a'.

[DATA] : Use the small character, if data is 0 x ab, it will send the 'a', 'b'.

[OK] : Use the large character.

Error Acknowledgement

[Command2][][Set ID][][NG][Data][x]

The TV transmits ACK (acknowledgement) based on this format when receiving abnormal data from non-viable functions or communication errors.

Data1: Illegal Code

Data2: Not supported function

Data3: Wait more time

* In this model, TV will not send the status during the standby mode.

* Data Format

[Command 2] : Use as command.

[Set ID] : Use the small character, if set ID is 10, it will send the '0', 'a'.

[DATA] : Use the small character, if data is 0 x ab, it will send the 'a', 'b'.

[NG] : Use the large character

01. Power (Command: k a)

To control Power On/Off of the TV.

Transmission [k][a][][Set ID][][Data][Cr]

Data 0: Power Off Data 1: Power On

Acknowledgement [a][][Set ID][][OK/NG][Data][x]

* In a like manner, if other functions transmit 'FF' data based on this format, Acknowledgement data feedback presents status about each function.

* Note: In this model, TV will send the Acknowledge after power on processing completion.

There might be a time delay between command and acknowledge.

02. Input Select (Command: k b)

To select input source for the TV.

Transmission [k][b][][Set ID][][Data][Cr]

Data 0: DTV Data 1: Analog
 Data 2: AV1 Data 3: AV2
 Data 4: Component 1 Data 5: Component 2
 Data 7: RGB-PC Data 8: HDMI1
 Data 9: HDMI2

Acknowledgement [b][][Set ID][][OK/NG][Data][x]

* You can select HDMI3 using "command x b".

* If you select input source, we recommend "command x b".

03. Input Select (Command: x b)

To select input source for TV.

Transmission [x][b][][Set ID][][Data][Cr]

Data 00: DTV (Antenna) Data 01: DTV (Cable)
 Data 10: Analog (Antenna) Data 11: Analog (Cable)
 Data 20: AV1 Data 21: AV2
 Data 40: Component 1 Data 41: Component 2
 Data 60: RGB-PC Data 90: HDMI1
 Data 91: HDMI2 Data 92: HDMI3

Acknowledgement [b][][Set ID][][OK/NG][Data][x]

04. Aspect Ratio (Command: k c)

To adjust the screen format.

You can also adjust the screen format using the RATIO button on remote control or in the Picture menu.

Transmission [k][c][][Set ID][][Data][Cr]

Data 1: 4:3 5: Zoom 2
 2: 16:9 6: Set by program
 4: Zoom 1 9: Just scan
 ⋮
 Reserved

Acknowledgement [c][][Set ID][][OK/NG][Data][x]

05. Screen Mute (Command: k d)

To select screen mute on/off.

Transmission [k][d][][Set ID][][Data][Cr]

Data 0: Screen mute off (Picture on)

Data 1: Screen mute on (Picture off)

Acknowledgement [d][][Set ID][][OK/NG][Data][x]

06. Volume Mute (Command: k e)

To control volume mute on/off.

You can also adjust mute using the MUTE button on remote control.

Transmission [k][e][][Set ID][][Data][Cr]

Data 0 : Volume mute on (Volume off)

Data 1 : Volume mute off (Volume on)

Acknowledgement [e][][Set ID][][OK/NG][Data][x]

07. Volume Control (Command: k f)

To adjust volume.

You can also adjust volume with the volume buttons on remote control.

Transmission [k][f][][Set ID][][Data][Cr]

Data Min : 0 ~ Max : 64 (*transmit by Hexadecimal code)

*Refer to 'Real data mapping 1'. See page 125.

Acknowledgement [f][][Set ID][][OK/NG][Data][x]

08. Contrast (Command: k g)

To adjust screen contrast.

You can also adjust contrast in the Picture menu.

Transmission [k][g][][Set ID][][Data][Cr]

Data Min : 0 ~ Max : 64 (*transmit by Hexadecimal code)

*Refer to 'Real data mapping 1'. See page 125.

Acknowledgement [g][][Set ID][][OK/NG][Data][x]

09. Brightness (Command: k h)

To adjust screen brightness.

You can also adjust brightness in the Picture menu.

Transmission [k][h][][Set ID][][Data][Cr]

Data Min : 0 ~ Max : 64 (*transmit by Hexadecimal code)

*Refer to 'Real data mapping 1'. See page 125.

Acknowledgement [h][][Set ID][][OK/NG][Data][x]

10. Color (Command: k i)

To adjust screen color.

You can also adjust color in the Picture menu.

Transmission [k][i][][Set ID][][Data][Cr]

Data Min : 0 ~ Max : 64 (*transmit by Hexadecimal code)

*Refer to 'Real data mapping 1' as shown below.

Acknowledgement [i][][Set ID][][OK/NG][Data][x]

11. Tint (Command: k j)

To adjust screen tint.

You can also adjust tint in the Picture menu.

Transmission [k][j][][Set ID][][Data][Cr]

Data Red: 0 ~ Green: 64 (*transmit by Hexadecimal code)

*Refer to 'Real data mapping 1' as shown below.

Acknowledgement [j][][Set ID][][OK/NG][Data][x]

12. Sharpness (Command: k k)

To adjust screen sharpness.

You can also adjust sharpness in the Picture menu.

Transmission [k][k][][Set ID][][Data][Cr]

Data Min : 0 ~ Max : 64 (*transmit by Hexadecimal code)

*Refer to 'Real data mapping 1' as shown below.

Acknowledgement [k][][Set ID][][OK/NG][Data][x]

13. OSD Select (Command: k l)

To select OSD (On Screen Display) on/off.

Transmission [k][l][][Set ID][][Data][Cr]

Data 0: OSD off Data 1: OSD on

Acknowledgement [l][][Set ID][][OK/NG][Data][x]

14. Remote Control Lock Mode (Command: k m)

To lock the remote control and the front panel controls on the set.

Transmission [k][m][][Set ID][][Data][Cr]

Data 0: Lock off Data 1: Lock on

Acknowledgement [m][][Set ID][][OK/NG][Data][x]

If you're not using the remote control and front panel controls on the TV, use this mode. When main power is on/off, remote control lock is released.

15. Treble (Command: k r)

To adjust treble.

You can also adjust treble in the Audio menu.

Transmission [k][r][][Set ID][][Data][Cr]

Data Min: 0 ~ Max: 64 (*transmit by Hexadecimal code)

*Refer to 'Real data mapping 1' as shown.

Acknowledgement [r][][Set ID][][OK/NG][Data][x]

16. Bass (Command: k s)

To adjust bass.

You can also adjust bass in the Audio menu.

Transmission [k][s][][Set ID][][Data][Cr]

Data Min: 0 ~ Max: 64 (*transmit by Hexadecimal code)

*Refer to 'Real data mapping 1' as shown below.

Acknowledgement [s][][Set ID][][OK/NG][Data][x]

17. Balance (Command: k t)

To adjust balance.

You can also adjust balance in the Audio menu.

Transmission [k][t][][Set ID][][Data][Cr]

Data Min: 0 ~ Max: 64 (*transmit by Hexadecimal code)

*Refer to 'Real data mapping 1' as shown below.

Acknowledgement [t][][Set ID][][OK/NG][Data][x]

18. Color Temperature (Command: k u)

To adjust color temperature.

You can also adjust color temperature in the Picture menu.

Transmission [k][u][][Set ID][][Data][Cr]

Data 0: Medium 1: Cool 2: Warm 3: User

Acknowledgement [u][][Set ID][][OK/NG][Data][x]

19. Red Adjustment (Command: k v)

To adjust red in color temperature

Transmission [k][v][][Set ID][][Data][Cr]

Data Min: 0 ~ Max: C8

*Refer to 'Real data mapping 2' as shown below.

Acknowledgement [v][][Set ID][][OK/NG][Data][x]

20. Green Adjustment (Command: k w)

To adjust green in color temperature.

Transmission [k][w][][Set ID][][Data][Cr]

Data Min: 0 ~ Max: C8

*Refer to 'Real data mapping 2' as shown below.

Acknowledgement [w][][Set ID][][OK/NG][Data][x]

*Real data mapping 1	*Real data mapping 2
0 : Step 0	0 : -20
⋮	5 : -19
A : Step 10 (SET ID 10)	A : -18
⋮	⋮
F : Step 15 (SET ID 15)	5F: -1
10 : Step 16 (SET ID 16)	64: 0
⋮	69: +1
63 : Step 99 (SET ID 99)	⋮
64 : Step 100	C3 : +19
	C8 : +20

21. Blue Adjustment (Command: k \$)

To adjust blue in color temperature.

Transmission [k][\$][][Set ID][][Data][Cr]

Data Min: 0 ~ Max: C8

*Refer to 'Real data mapping 2'. See page 125.

Acknowledgement [\$][][Set ID][][OK/NG][Data][x]

22. ISM Method (Command2: j p)

(Only Plasma TV model)

To avoid having a fixed image remain on screen.

Transmission [j][p][][Set ID][][Data][Cr]

Data 1: Inversion 2: Orbiter

4: White Wash 8: Normal

Acknowledgement [p][][Set ID][][OK/NG][Data][x]

23. Low Power (Command2: j q)

(Only Plasma TV model)

To control the low power function on/off.

Transmission [j][q][][Set ID][][Data][Cr]

Data 0: Low Power off

1: Low Power on

Acknowledgement [q][][Set ID][][OK/NG][Data][x]

24. Channel Tuning (Command: m a)

To tune channel to following physical/major/minor number.

Transmission [m][a][][Set ID][][Data0][][Data1][][Data2][][Data3][][Data4][][Data5][Cr]

Digital channels have a Physical, Major, and Minor channel number. The Physical number is the actual digital channel number, the Major is the number that the channel should be mapped to, and the Minor is the sub-channel. Since the ATSC tuner automatically maps the channel to the Major number, the Physical number is not required when sending a command.

Data 0: Physical Channel Number

NTSC air: 02~45, NTSC cable: 01, 0E~7D

ATSC air: 01~45, ATSC cable: 01~87

Data1 & 2: Major Channel Number

Data1: High byte Data2: Low byte

Two bytes are available for the Major and Minor, normally only the second byte is used.

Data3 & 4: Minor Channel Number

Not needed for NTSC.

Data5:

7	Main/Sub Picture	6	Two/One Part Channel	5	Using Physical Channel	4	Reserved	3	2	1	0	Step
0	Main	0	Two	0	Use	x		0	0	0	0	NTSC Air
1	Sub	1	One	1	No Use	x		0	0	0	1	NTSC Cable
						x		0	0	1	0	ATSC Air
						x		0	0	1	1	ATSC Cable_std
						x		0	1	0	0	ATSC Cable_hrc
						x		0	1	0	1	ATSC Cable_irc
						x		0	1	1	0	ATSC cable_auto
						x		0	1	1	1	Reserved
						x		x	x	x	x	...
						x		1	1	1	1	Reserved

The table above lists the binary code which must be converted to Hexadecimal before sending. For example: The binary code to tune the sub source to an NTSC cable channel is "1000 0001", which translates to "81" in Hex.

- * 7th bit : For which source do you want to change the channel.
- * 6th bit: Use a two part or one part channel. Most cases just use 0 since it's ignored when using NTSC.
- * 5th bit: Use 0 with NTSC since it can only use the physical channel number. Normally use 1 for ATSC since most times it doesn't matter what the physical number is.
- * 4th bit: Set to 0.
- * 3-0 bits: Choose signal type.

* Tune Command Examples:

1. Tune to the analog (NTSC) cable channel 35.

Data 0 = Physical of 35 = 23
 Data 1 & 2 = No Major = 00 00
 Data 3 & 4 = No Minor = 00 00
 Data 5 = 0000 0001 in binary = 01
 Total = ma 00 23 00 00 00 00 01

2. Tune to the digital (ATSC) local channel 30-3.

Data 0 = Don't know Physical = 00
 Data 1 & 2 = Major is 30 = 00 1E
 Data 3 & 4 = Minor is 3 = 00 03
 Data 5 = 0010 0010 in binary = 22
 Total = ma 00 00 00 1E 00 03 22

```
Acknowledgement[a][ ][Set ID][ ][OK][Data0][Data1][Data2][Data3][Data4][x][a][ ][Set ID][ ][NG][Data0][x]
```

25. Channel Add/Del (Command: m b)

To add and delete the channels

```
Transmission [m][b][ ][Set ID][ ][Data][Cr]
```

Data 0: Channel Delete Data 1: Channel Add

```
Acknowledgement [b][ ][Set ID][ ][OK/NG][Data][x]
```

26. Key (Command: m c)

To send IR remote key code.

```
Transmission [m][c][ ][Set ID][ ][Data][Cr]
```

Data Key code: Refer to page 120.

```
Acknowledgement [c][ ][Set ID][ ][OK/NG][Data][x]
```

27. Back Light (Command: m g)

(Only LCD TV model)

To adjust screen back light.

```
Transmission [m][g][ ][Set ID][ ][Data][Cr]
```

Data Min:0 ~ Max:64 (*transmit by Hexadecimal code)

*Refer to 'Real data mapping 1'. See page 125.

```
Acknowledgement [g][ ][Set ID][ ][OK/NG][Data][x]
```

LG Electronics Inc.