

APPENDIX H
: USER'S MANUAL



LCD TV

MODELS: 32LC2DU
37LC2DU
42LC2DU

PLASMA TV

MODELS: 42PC3DU
42PC3DVU
50PC3DU
60PC1D

OWNER'S MANUAL



Internet Home Page : <http://www.lge.com>
<http://www.lg.ca>

ENERGYSTAR is a set of power-saving guidelines issued by the U.S. Environmental Protection Agency(EPA).



As an ENERGY STAR Partner LGE U. S. A.,Inc. has determined that this product meets the ENERGY STAR guidelines for energy efficiency.

Please read this manual carefully before operating your set. Retain it for future reference. Record model number and serial number of the set. See the label attached on the back cover and quote this information to your dealer when you require service.

P/NO : 38289U0527F ©
Printed in Korea

Warning



CAUTION
RISK OF ELECTRIC SHOCK
DO NOT OPEN



WARNING:
TO REDUCE THE RISK OF ELECTRIC SHOCK DO NOT REMOVE COVER (OR BACK). NO USER SERVICEABLE PARTS INSIDE. REFER TO QUALIFIED SERVICE PERSONNEL.

 The lightning flash with arrowhead symbol, within an equilateral triangle, is intended to alert the user to the presence of uninsulated "dangerous voltage" within the product's enclosure that may be of sufficient magnitude to constitute a risk of electric shock to persons.

 The exclamation point within an equilateral triangle is intended to alert the user to the presence of important operating and maintenance (servicing) instructions in the literature accompanying the appliance.

NOTE TO CABLE/TV INSTALLER:

This reminder is provided to call the CATV system installer's attention to Article 820-40 of the National Electric Code (U.S.A.). The code provides guidelines for proper grounding and, in particular, specifies that the cable ground shall be connected to the grounding system of the building, as close to the point of the cable entry as practical.

REGULATORY INFORMATION

This equipment has been tested and found to comply with the limits for a Class B digital device, pursuant to Part 15 of the FCC Rules. These limits are designed to provide reasonable protection against harmful interference in a residential installation. This equipment generates, uses and can radiate radio frequency energy and, if not installed and used in accordance with the instructions, may cause harmful interference to radio communications. However, there is no guarantee that interference will not occur in a particular installation. If this equipment does cause harmful interference to radio or television reception, which can be determined by turning the equipment off and on, the user is encouraged to try to correct the interference by one or more of the following measures:

- Reorient or relocate the receiving antenna.
- Increase the separation between the equipment and receiver.
- Connect the equipment into an outlet on a circuit different from that to which the receiver is connected.
- Consult the dealer or an experienced radio/TV technician for help.

Any changes or modifications not expressly approved by the party responsible for compliance could void the user's authority to operate the equipment.

CAUTION:

Do not attempt to modify this product in any way without written authorization from LG Electronics Corporation. Unauthorized modification could void the user's authority to operate this product.

COMPLIANCE:

The responsible party for this product's compliance is:
LG Electronics U.S.A., Inc.
1000 Sylvan Avenue, Englewood Cliffs, NJ 07632
Phone: 1-800-243-0000
<http://www.lgusa.com>

Safety Instructions

WARNING :

To reduce the risk of fire or electric shock, do not expose this apparatus to rain or moisture.

Apparatus shall not be exposed to dripping or splashing and no objects filled with liquids, such as vases, shall be placed on the apparatus.

IMPORTANT SAFETY INSTRUCTIONS

1. Read these instructions.
2. Keep these instructions.
3. Heed all warnings.
4. Follow all instructions.



5. Do not use this apparatus near water.



6. Clean only with a dry cloth.

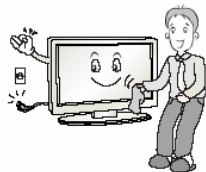

7. Do not block any of the ventilation openings. Install in accordance with the manufacturer's instructions.



8. Do not install near any heat sources such as radiators, heat registers, stoves, or other apparatus (including amplifiers) that produce heat.



9. Do not defeat the safety purpose of the polarized or grounding type plug. A polarized plug has two blades with one wider than the other. A grounding type plug has two blades and a third grounding prong. The wide blade or the third prong is provided for your safety. When the provided plug does not fit into your outlet, consult an electrician for replacement of the obsolete outlet.

10. Protect the power cord from being walked on or pinched particularly at plugs, convenience receptacles, and the point where they exit from the apparatus.



11. Only use the attachments / accessories specified by the manufacturer.

12. Use only with a cart, stand, tripod, bracket, or table specified by the manufacturer, or sold with the apparatus. When a cart is used, use caution when moving the cart / apparatus combination to avoid injury from tip-over.



13. Unplug this apparatus during lightning storms or when unused for long periods of time.



14. Refer all servicing to qualified service personnel. Servicing is required when the apparatus has been damaged in any way, such as power supply cord or plug is damaged, liquid has been spilled or objects have fallen into the apparatus, the apparatus has been exposed to rain or moisture, does not operate normally, or has been dropped.

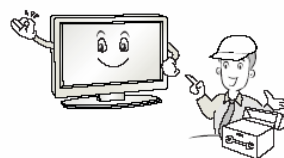

15. DISCONNECTING DEVICE FROM MAINS

Main plug is the disconnecting device. The plug must remain readily operable.

Note

- If the TV feels cold to the touch, there may be a small "flicker" when it is turned on. This is normal, there is nothing wrong with TV.
- Some minute dot defects may be visible on the screen, appearing as tiny red, green, or blue spots. However, they have no adverse effect on the monitor's performance.
- Avoid touching the LCD screen or holding your finger(s) against it for long periods of time. Doing so may produce some temporary distortion effects on the screen.

CAUTION concerning the Power Cord

Most appliances recommend they be placed upon a dedicated circuit; that is, a single outlet circuit which powers only that appliance and has no additional outlets or branch circuits. Check the specification page of this owner's manual to be certain.

Do not overload wall outlets. Overloaded wall outlets, loose or damaged wall outlets, extension cords, frayed power cords, or damaged or cracked wire insulation are dangerous. Any of these conditions could result in electric shock or fire. Periodically examine the cord of your appliance, and if its appearance indicates damage or deterioration, unplug it, discontinue use of the appliance, and have the cord replaced with an exact replacement part by an authorized servicer.

Protect the power cord from physical or mechanical abuse, such as being twisted, kinked, pinched, closed in a door, or walked upon. Pay particular attention to plugs, wall outlets, and the point where the cord exits the appliance.

On Disposal

- The fluorescent lamp used in this product contains a small amount of mercury.
- Do not dispose of this product with general household waste.
Disposal of this product must be carried out in accordance to the regulations of your local authority.

Introduction

Accessories

Ensure that the following accessories are included with your TV. If any accessory is missing, please contact the dealer from where you purchased the product. User must use shielded signal interface cables(D-sub 15 pin cable) with ferrite cores to maintain standard compliance for the product.



Power Cord



75Ω Round Cable

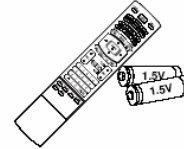

Owner's Manual

Remote Control /
Batteries

For 42PC3DU/3DVU/
50PC3DU



2-Wall brackets



2-eye-bolts

42PC3DU/3DVU only

2-bolts
(Refer p.14)

Option Extras

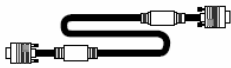

D-sub 15 pin cable

For 32/37/42LC2DU

2-TV brackets
2-Wall bracketsTwister Holder
Arrange the wires
with the twister holder.

2-TV Bracket Bolts

Cable
Management
(Refer p.16)

42LC2DU only

Polishing Cloth
Polish the TV with
the cloth.

32LC2DU only

4-bolts for stand
assembly
See below for detail
information.

[Polishing Cloth]

Slightly wipe stained spot on the exterior only with the cleansing cloths for the product exterior if there is stain or fingerprint on surface of the exterior.
Do not wipe roughly when removing stain. Please be cautious of that excessive power may cause scratch or discoloration.

For 60PC1D

2-TV brackets
2-Wall brackets

4- Bolts



4-RING SPACER

Stand Installation for 32LC2DU

- 1 Carefully place the product screen side down on a cushioned surface that will protect product and screen from damage.

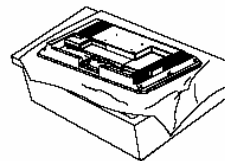

- 2 Place the hook of the stand in the back of the product as shown.

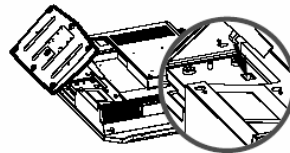

- 3 Install the 4 bolts provided securely, in the back of the product.

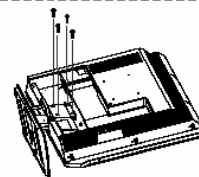

Controls (Model Name: 32/37/42LC2DU)

- This is a simplified representation of front panel.
- This picture shown below may be somewhat different from your TV.

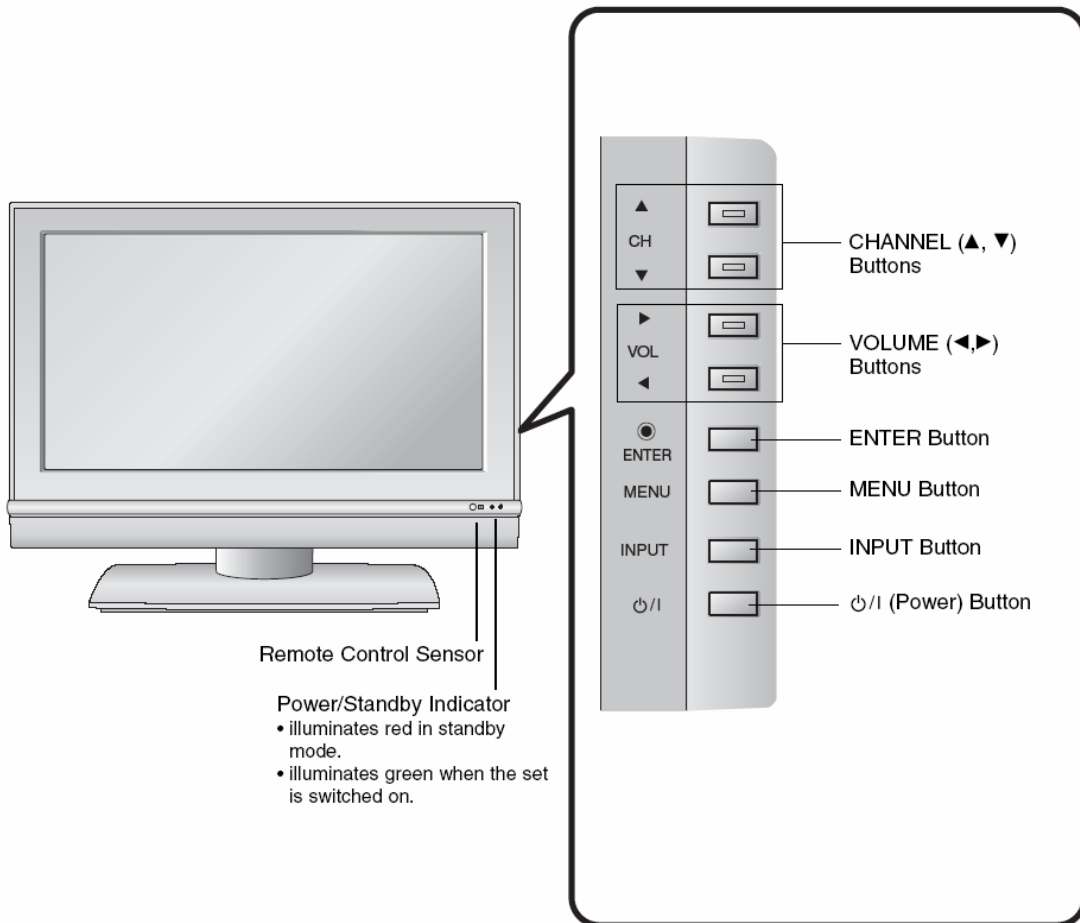

Swivel Stand (42LC2DU Only)

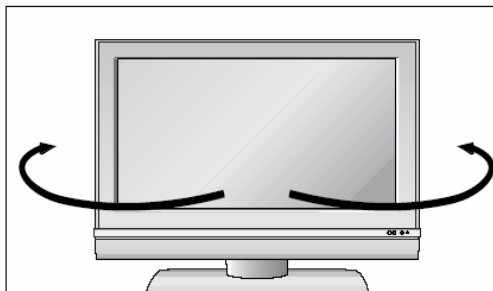

- The TV can be conveniently swivelled on its stand 30° to the left or right to provide the optimum viewing angle.

Connection Options (Model Name: 32/37/42LC2DU)

- This picture shown below may be somewhat different from your TV.

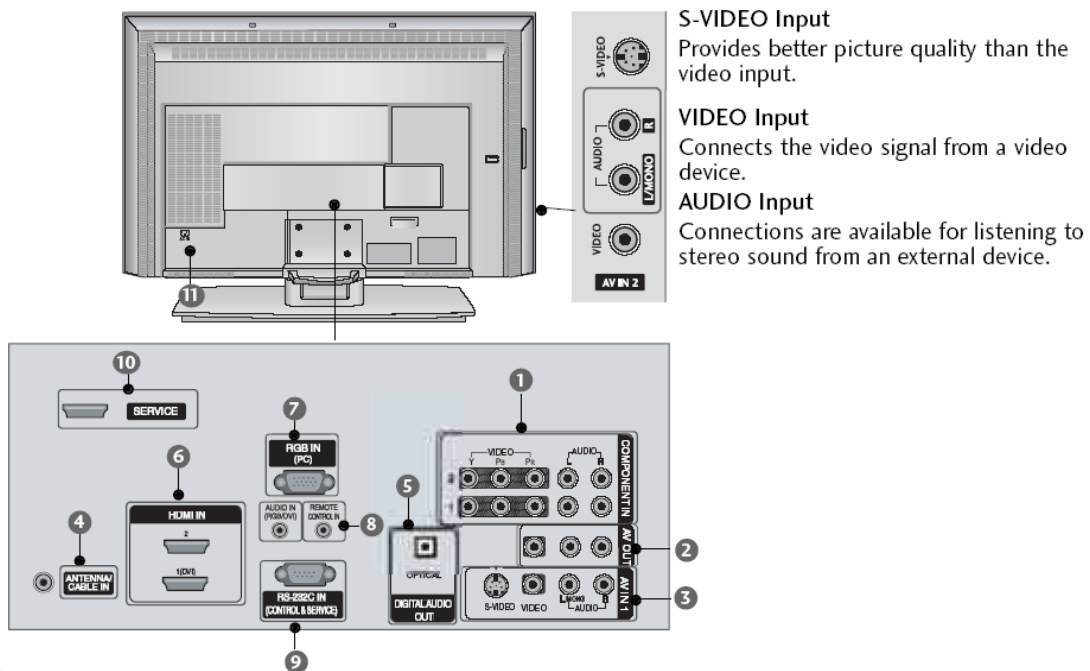

S-VIDEO Input

Provides better picture quality than the video input.

VIDEO Input

Connects the video signal from a video device.

AUDIO Input

Connections are available for listening to stereo sound from an external device.

1 COMPONENT IN

Connect a component video/audio device to these jacks.

2 AV OUT

Connect a second TV or monitor.

3 AV (Audio/Video) IN 1

Connect audio/video output from an external device to these jacks.

S-VIDEO

Connect S-Video out from an S-VIDEO device.

4 ANTENNA/CABLE IN

Connect over-the air signals to this jack.
Connect cable signals to this jack.

5 DIGITAL AUDIO OUT

Connect digital audio from various types of equipment.

Note: In standby mode, these ports do not work.

6 HDMI IN

Connect a HDMI signal.
Or DVI (VIDEO) signal to the this port with a HDMI to DVI cable.

7 RGB IN (PC)

Connect the monitor output from a PC to the appropriate input port.

8 Remote Control Port

Connect your wired remote control.

AUDIO IN (RGB/DVI)

Connect the monitor output from a PC to the appropriate input port.

9 RS-232C IN (CONTROL & SERVICE) PORT

Connect to the RS-232C port on a PC.

10 SERVICE

11 Power Cord Socket

For operation with AC power.

Caution:

Never attempt to operate the TV on DC power.

Basic Connection (For 32/37/42LC2DU)

- 1 Connect the cables as necessary. After connecting the cables neatly, arrange the cables to the Cable Holder.

To connect an additional equipment, see the **External equipment Connections** section.

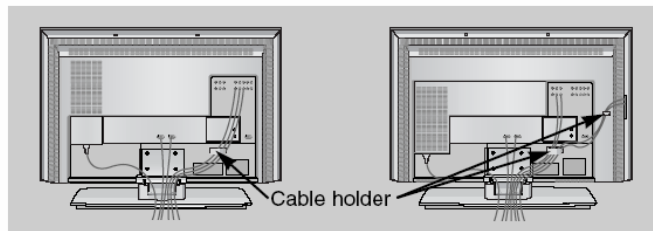

32LC2DU

37/42LC2DU

- 2 Reinstall the **CABLE MANAGEMENT** as shown.

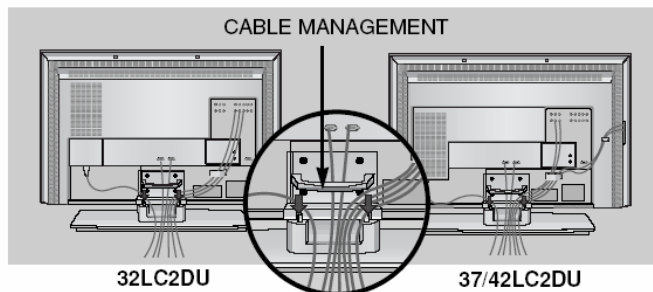

32LC2DU

37/42LC2DU

- 3 Bundle the cables using the supplied twister holder.

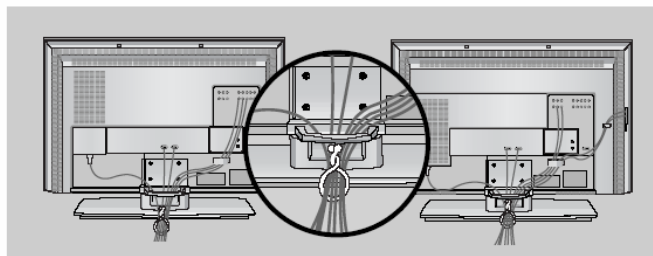

32LC2DU

37/42LC2DU

How to remove the **CABLE MANAGEMENT**

- Hold the **CABLE MANAGEMENT** with both hands and pull it upward.

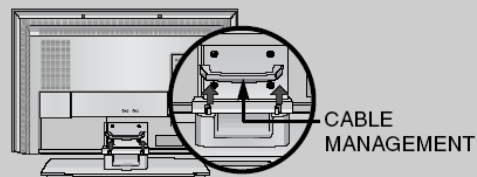

- Do not hold the **CABLE MANAGEMENT** when moving the product.
- If the product is dropped, you may be injured or the product may be broken.

External Equipment Connections

NOTE: All cables shown are not included with the TV

Antenna Or Cable Connection

Analog and Digital TV signals provided on antenna

- Antenna or Cable Service without a Cable Box Connection.
- For optimum picture quality, adjust antenna direction if needed.

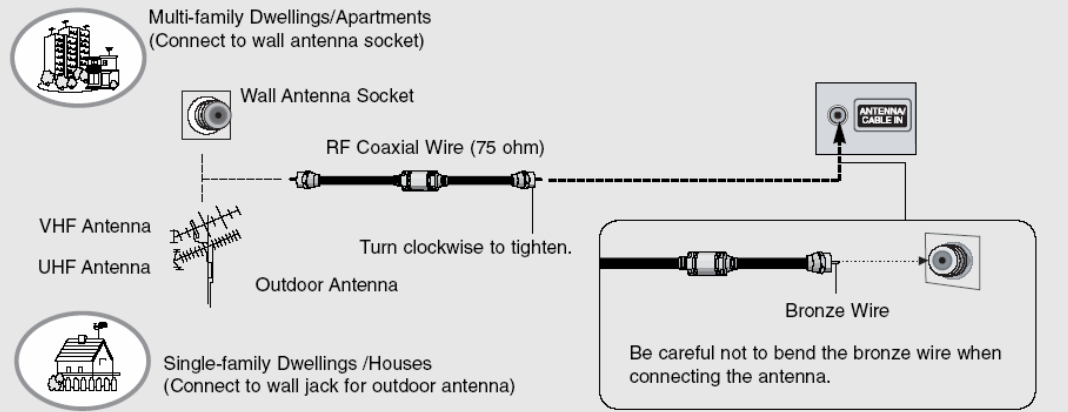

Analog and Digital TV signals provided on cable

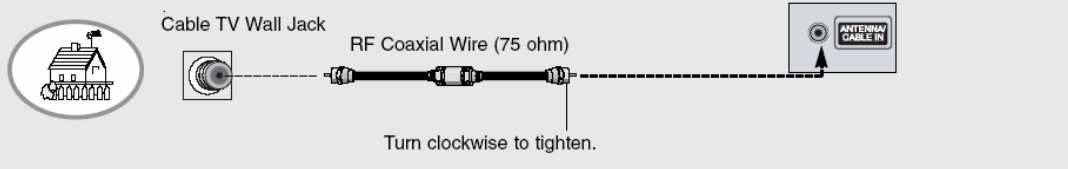

Analog and DTV signals provided on two separate antennas

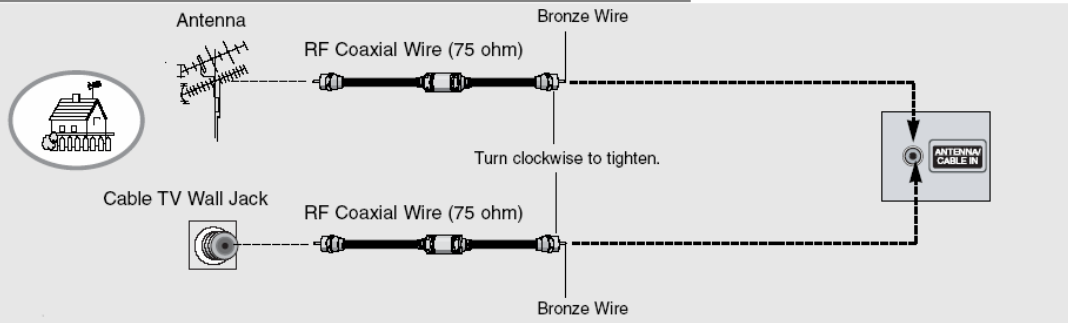

signal amplifier

- In a poor signal area to improve picture quality, purchase and install a signal amplifier.
- If the antenna needs to be split for two TV's, install a "2-Way Signal Splitter" in the connections.
- If the antenna is not installed properly, contact your dealer for assistance.

The diagram shows a 'signal amplifier' with 'VHF' and 'UHF' ports. It is connected to the 'ANTENNA CABLE IN' port on the back of the TV.

VCR Setup

- To avoid picture noise (interference), leave an adequate distance between the VCR and TV.
- Typically a frozen still picture from a VCR. If the 4:3 picture format is used; the fixed images on the sides of the screen may remain visible on the screen.

When connecting with an antenna

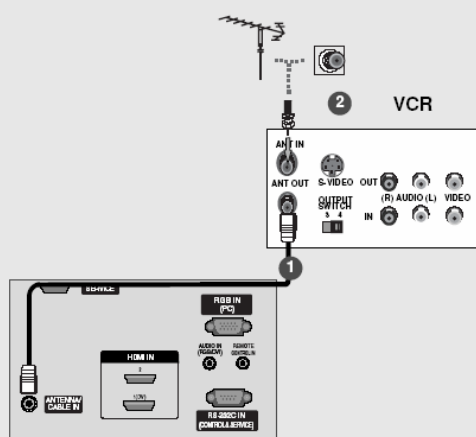

- 1 Connect the RF antenna out socket of the VCR to the **Antenna** socket on the set.
- 2 Connect the antenna cable to the RF antenna in socket of the VCR.
- 3 Set VCR output switch to 3 or 4 and then tune TV to the same channel number.
- 4 Insert a video tape into the VCR and press **PLAY** on the VCR. (Refer to the VCR owner's manual.)

When connecting with a RCA cable

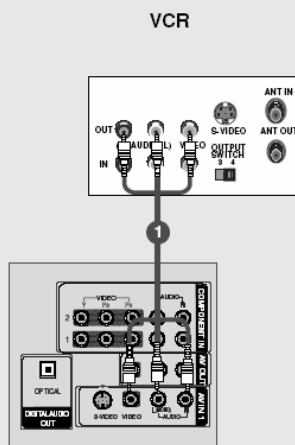

- 1 Connect the **AUDIO/VIDEO** jacks between TV and VCR. Match the jack colors (Video = yellow, Audio Left = white, and Audio Right = red)
- 2 Insert a video tape into the VCR and press **PLAY** on the VCR. (Refer to the VCR owner's manual.)
- 3 Select **AV1** input source using the **INPUT** button on the remote control.
 - If connected to **AV IN2**, select **AV2** input source.



- If you have a mono VCR, connect the audio cable from the VCR to the **AUDIO L/MONO** jack of the set.

DVD Setup

When connecting with a S-Video cable

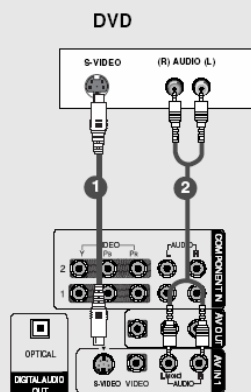

- 1 Connect the S-VIDEO output of the DVD to the S-VIDEO input on the set.
- 2 Connect the audio outputs of the DVD to the **AUDIO** input jacks on the set.
- 3 Turn on the DVD player, insert a DVD.
- 4 Select **AV1** input source with using the **INPUT** button on the remote control.
- If connected to **AV IN2**, select **AV 2** input source.
- 5 Refer to the DVD player's manual for operating instructions.

When connecting with a HDMI cable

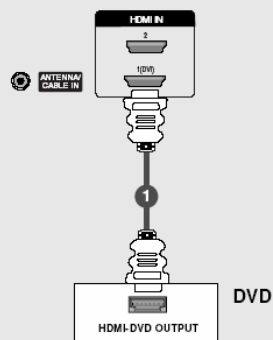

- 1 Connect the HDMI output of the DVD to the **HDMI IN 1(DVI)** or 2 jack on the set.
- 2 Select **HDMI1/DVI** or **HDMI2** input source with using the **INPUT** button on the remote control.
- 3 Refer to the DVD player's manual for operating instructions.



- TV can receive the video and audio signal simultaneously with using a HDMI cable.
- If the DVD supports Auto HDMI function, the DVD output resolution will be automatically set to 1280x720p.
- If the DVD does not support Auto HDMI, you need to set the output resolution appropriately. To get the best picture quality, adjust the output resolution of the DVD to 1280x720p.

When connecting with a component cable

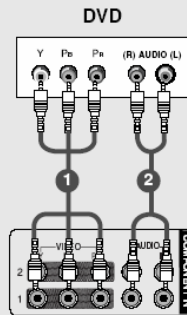

- 1 Connect the video outputs (Y, Pb, Pr) of the DVD to the **COMPONENT IN VIDEO** jacks on the set.
- 2 Connect the audio outputs of the DVD to the **COMPONENT IN AUDIO** jacks on the set.
- 3 Turn on the DVD player, insert a DVD.
- 4 Select **Component 1** input source with using the **INPUT** button on the remote control.
- If connected to **COMPONENT 2**, select **Component 2** input source.
- 5 Refer to the DVD player's manual for operating instructions.



• **Component Input ports**

To get better picture quality, connect a DVD player to the component input ports as shown below.

Component ports on the TV	Y	Pb	Pr
Video output ports on DVD player	Y	Pb	Pr
	Y	B-Y	R-Y
	Y	Cb	Cr
	Y	PB	PR

HDSTB Setup

- This TV can receive Digital Over-the-air/Cable signals without an external digital set-top box. However, if you do receive Digital signals from a digital set-top box or other digital external device, refer to the figure as shown below.

When connecting with a HDMI cable

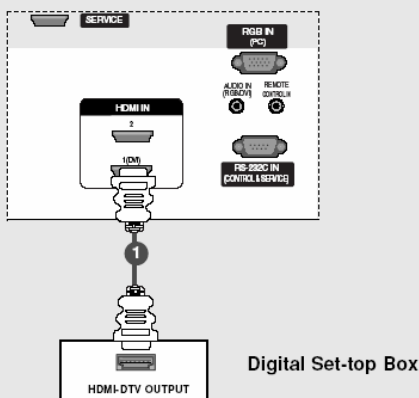

- 1 Connect the HDMI output of the digital set-top box to the **HDMI IN 1(DVI)** or **2** jack on the set.
- 2 Select **HDMI1/DVI** or **HDMI2** input source with using the **INPUT** button on the remote control.
- 3 Turn on the digital set-top box. (Refer to the owner's manual for the digital set-top box.)



- TV can receive the video and audio signal simultaneously using a HDMI cable.
- If the digital set-top box supports Auto HDMI function, output resolution of the digital set-top box will be automatically set to 1280x720p.
- If the digital set-top box does not support Auto HDMI, you need to set the output resolution appropriately. To get the best picture quality, adjust the output resolution of the digital set-top box to 1280x720p.

When connecting with a Component cable

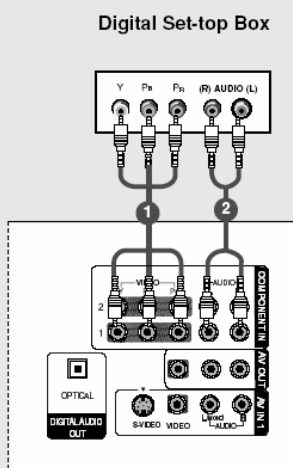

- 1 Connect the video outputs (Y, PB, PR) of the digital set-top box to the **COMPONENT IN VIDEO** jacks on the set.
- 2 Connect the audio output of the digital set-top box to the **COMPONENT IN AUDIO** jacks on the set.
- 3 Turn on the digital set-top box. (Refer to the owner's manual for the digital set-top box.)
- 4 Select **Component 1** input source with using the **INPUT** button on the remote control.
- If connected to **COMPONENT 2**, select **Component 2** input source.



Signal	Component1/2	HDMI1/DVI, HDMI2
480i	Yes	No
480p/720p/1080i	Yes	Yes

When connecting with a HDMI to DVI cable

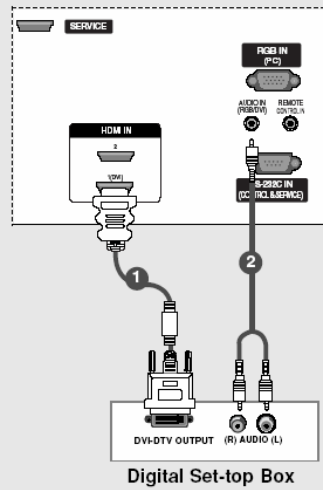

- 1 Connect the DVI output of the digital set-top box to the **HDMI IN 1(DVI)** jack on the set.
- 2 Connect the audio outputs of the set-top box to the **AUDIO IN(RGB/DVI)** jack on the set.
- 3 Turn on the digital set-top box. (Refer to the owner's manual for the digital set-top box.)
- 4 Select **HDMI1/DVI** input source with using the **INPUT** button on the remote control.



- If the digital set-top box has a DVI output and no HDMI output, a separated audio connection is necessary.
- If the digital set-top box supports Auto DVI function, the output resolution of the digital set-top box will be automatically set to 1280x720p.
- If the digital set-top box does not support Auto DVI, you need to set the output resolution appropriately. To get the best picture quality, adjust the output resolution of the digital set-top box to 1280x720p.

PC Setup

- This TV provides Plug and Play capability, meaning that the PC adjusts automatically to the TV's settings.

When connecting with a D-sub 15 pin cable

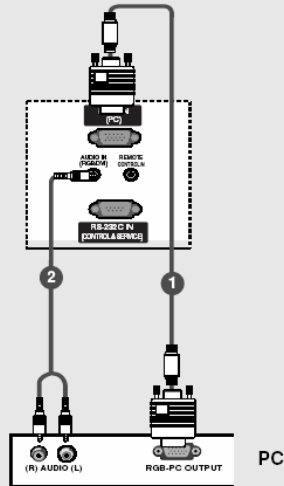

- 1 Connect the RGB output of the PC to the **RGB IN (PC)** jack on the set.
- 2 Connect the PC audio outputs to the **AUDIO IN (RGB/DVI)** jack on the set.
- 3 Turn on the PC and the set.
- 4 Select **RGB-PC** input source with using the **INPUT** button on the remote control.

When connecting with a HDMI to DVI cable

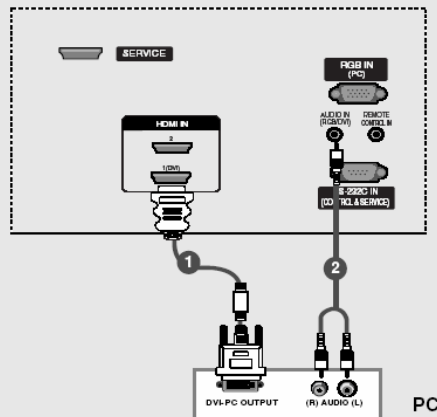

- 1 Connect the DVI output of the PC to the **HDMI IN 1 (DVI)** jack on the set.
- 2 Connect the audio outputs of the PC to the **AUDIO IN (RGB/DVI)** jack on the set.
- 3 Turn on the PC and the set.
- 4 Select **HDMI1/DVI** input source with using the **INPUT** button on the remote control.



- If the PC has a DVI output and no HDMI output, a separated audio connection is necessary.
- If the PC does not support Auto DVI, you need to set the output resolution appropriately. To get the best picture quality, adjust the output resolution of PC graphics card's output resolution to 1024x768, 60Hz.



1. Depending on the graphics card, DOS mode may not work if a HDMI to DVI Cable is in use.
2. When Source Devices connected with HDMI/DVI Input, output PC Resolution (VGA, SVGA, XGA, WXGA), Position and Size may not fit to Screen. Press the ADJUST button to adjust the screen Position of TV SET and contact an PC graphics card service center.
3. When Source Devices connected with HDMI/DVI Input, output TV SET Resolution (480p, 720p, 1080i, 1080p) and TV SET Display fit EIA/CEA-861-B Specification to Screen. If not, refer to the Manual of HDMI/DVI Source Devices or contact your service center.
4. In case HDMI/DVI Source Devices is not connected Cable or poor cable connection, "NO SIGNAL" OSD display in HDMI/DVI Input. In case that Video Resolution is not supported TV SET output in HDMI/DVI Source Devices, "INVALID FORMAT" OSD display. Refer to the Manual of HDMI/DVI Source Devices or contact your service center.
5. Check the image on your TV. There may be noise associated with the resolution, vertical pattern, contrast or brightness in PC, HDMI/DVI mode. If noise is present, change the PC or HDMI/DVI mode to another resolution, change the refresh rate to another rate or adjust the brightness and contrast on the menu until the picture is clear. If the refresh rate of the PC graphic card can not be changed, change the PC graphic card or consult the manufacturer of the PC graphic card.
6. Avoid keeping a fixed image on the TV's screen for a long period of time. The fixed image may become permanently imprinted on the screen.
7. The synchronization input form for Horizontal and Vertical frequencies is separate.

Supported Display Resolution (RGB-PC, HDMI1/DVI, HDMI2 Mode)

Resolution	Horizontal Frequency (kHz)	Vertical Frequency (Hz)	Resolution	Horizontal Frequency (kHz)	Vertical Frequency (Hz)
640x350	31.468	70.08	* 720x480	31.469	59.94
720x400	31.469	70.08		31.500	60.00
640x480	31.469	59.94	*1280x720	44.96	59.94
800x600	37.879	60.31		45.00	60.00
1280x768	47.7	60	*1920x1080i	33.72	59.94
1360x768	47.7	60		33.75	60.00
1366x768	47.1	60	*1920x1080p	27.00	24.00
1024x768	48.363	60.00		33.75	30.00

* This format is only for HDMI-DTV input.

Screen Setup for PC mode

- When RGB connect to PC input and select the RGB-PC, this function is used.
- When HDMI/DVI connect to PC input and select HDMI/DVI input, this function is used.
- After connecting RGB-PC or HDMI/DVI to PC input and checking the screen quality.

* Adjustment for screen Resolution, Position, Size, and Phase



Mini Glossary

Position This function is to adjust picture to left/right and up/down as you prefer.

Size This function is to minimize any vertical bars or stripes visible on the screen background. And the horizontal screen size will also change.

Phase This function allows you to remove any horizontal noise and clear or sharpen the image of characters.

Resolution This function allows you select Resolution of XGA/WXGA.

1 Press the **ADJUST** button and then use **▲ / ▼** button to select **Resolution, POSITION, SIZE, or PHASE.**

2 Press **ENTER** button and then use **▲ / ▼ / ◀ / ▶** buttons to make appropriate adjustments.

- The **PHASE** adjustment range is -16 ~ +16.
(In HDMI/DVI-PC mode, **PHASE** is not available.)
- The **SIZE** adjustment range is -30 ~ +30.
(In HDMI/DVI-PC mode, **SIZE** is not available.)

3 Press **ENTER** button.

* When you change the resolution, select the proper resolution in present input to see the best picture appearance.

* Initializing (Reset to original factory values)



- To initialize the adjusted values

1 Press the **ADJUST** button and then use **▲ / ▼** button to select the **RESET** option.

2 Press **ENTER** button and then use **◀ / ▶** button to select **Yes.**

3 Press **ENTER** button.

Operation

Basic operation

Turning on the TV

1. First, connect power cord correctly. At this moment, the TV switches to standby mode.
In standby mode to turn TV on, press the $\odot/1$, **INPUT**, **CH ▲ / ▼** button on the TV or press the **POWER**, **TV INPUT**, **INPUT**, **CH ▲ / ▼**, Number (0 ~ 9) button on the remote control .
2. Select the viewing source by using **TV INPUT**, **INPUT** button on the remote control.
This TV is programmed to remember which power state it was last set to, even if the power cord is out.
3. When finished using the TV, press the **POWER** button on the remote control. The TV reverts to standby mode.

Volume Adjustment

1. Press the **VOL ▲ / ▼** button to adjust the volume.
2. If you want to switch the sound off, press the **MUTE** button.
3. You can cancel this function by pressing the **MUTE** or **VOL ▲ / ▼** button.

Channel Selection

Press the **CH ▲ / ▼** or **NUMBER** buttons to select a channel number.



- If you intend to be away on vacation, disconnect the power plug from the wall power outlet.

On Screen Menus Language Selection

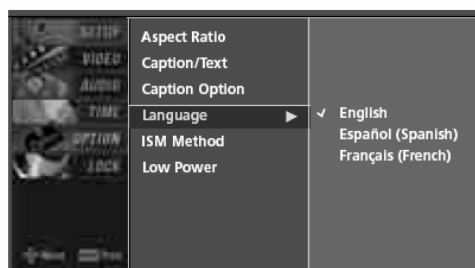
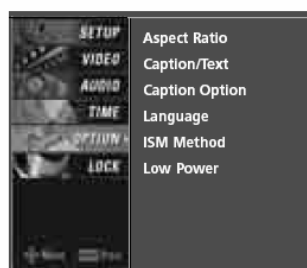

- The menus can be shown on the screen in the selected language. First select your language.

- 1 Press the **MENU** button and then use **▲ / ▼** button to select the **OPTION** menu.
- 2 Press the **▶** button and then use **▲ / ▼** button to select **Language**.
- 3 Press the **▶** button and then use **▲ / ▼** button to select your desired language. From this point on, the on-screen menus will be shown in the selected language.
- 4 Press **EXIT** button to return to TV viewing or press **MENU** button to return to the previous menu.

On Screen Menus Selection and Adjustment

How to adjust the OSD screen

1. Press the **MENU** button and then **▲ / ▼** button to select each menu.
2. Press the **▶** button and then use **▲ / ▼ / ◀ / ▶** button to display the available menus.

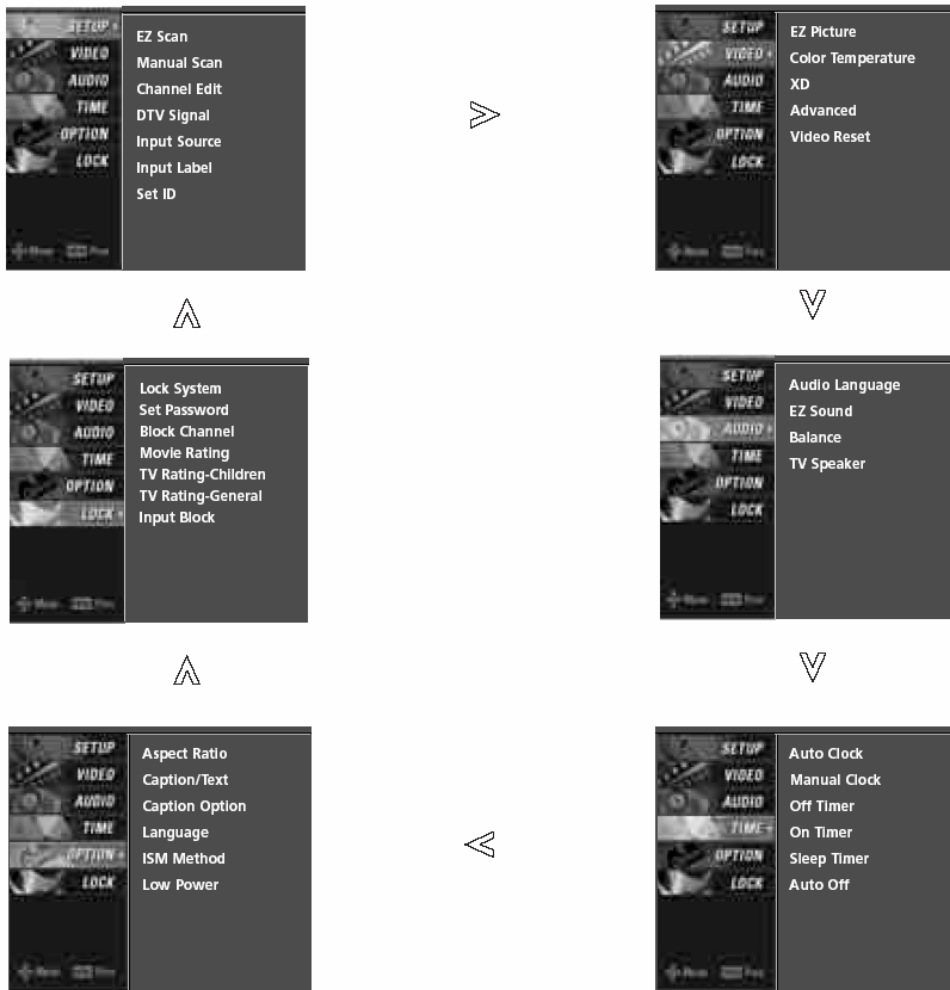

• Your TV's OSD (On Screen Display) may differ slightly from what is shown in this manual.

Setup Menu Options

EZ Scan (Channel Search)

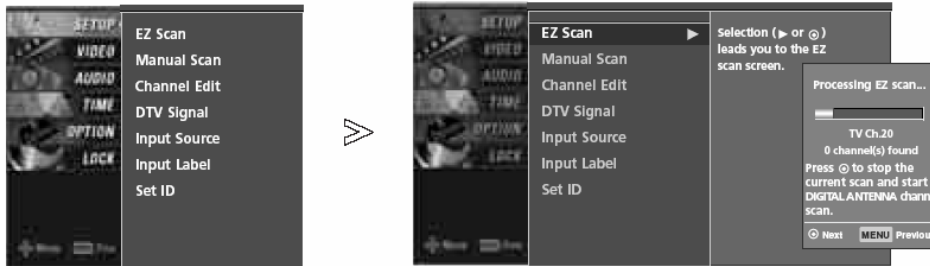

- Automatically finds all channels available through antenna or cable inputs, and stores them in memory on the channel list.
- Run EZ Scan again after any Antenna/Cable connection changes.
- A password is required to gain access to EZ Scan menu if the Lock System is turned on.

- 1 Press the **MENU** button and then use **▲ / ▼** button to select the **SETUP** menu.
- 2 Press the **▶** button and then use **▲ / ▼** button to select **EZ Scan**.
- 3 Press the **ENTER** button to begin the channel search. Allow EZ Scan to complete the channel search cycle for ANTENNA, and CABLE.

Manual Scan



- A password is required to gain access to Manual Scan menu if the Lock System is turned on.

- 1 Press the **MENU** button and then use **▲ / ▼** button to select the **SETUP** menu.
- 2 Press the **▶** button and then use **▲ / ▼** button to select **Manual Scan**.
- 3 Press the **▶** button and then use **▲ / ▼** button to select TV, DTV, CATV, and CADTV.
- 4 Press the **▶** button and then use **▲ / ▼** button to select channel number you want to add or delete.
- 5 Press the **ENTER** button to add or delete for the channel number.
- 6 Press **EXIT** button to return to TV viewing or press **MENU** button to return to the previous menu.

Channel Edit

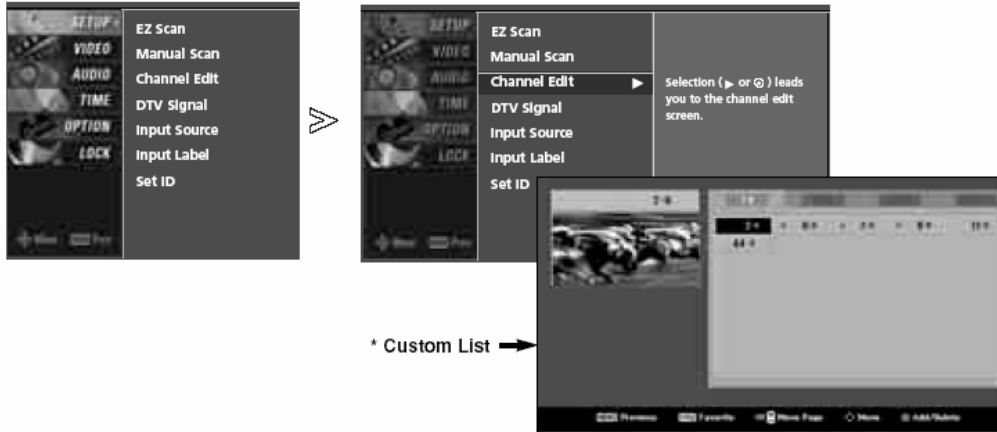

- There are two different ways in order to add or delete scanned channels. One is "Custom List" and the other is "Favorite List" in the channel list. Both of them are available after **EZ Scan** on the **SETUP** menu.
- A Custom List can be created by toggling each channel on or off with **ENTER** button. The channels in the Custom List are displayed in black color, and the channels deleted from the Custom List are displayed in gray color. Once a channel is highlighted you can add or delete the channel by referring to the small window at the top-left corner of the screen. You can create your own Favorite List. Use the **FAV** button on the remote control when a channel is highlighted and then you can add or delete the channel to/from the Favorite List.

- 1** Press the **MENU** button and then use **▲ / ▼** button to select the **SETUP** menu.
- 2** Press the **▶** button and then use **▲ / ▼** button to select **Channel Edit**.
- 3** Press the **▶** button. You will now see a screen filled with channel numbers and a preview picture.
- 4** Use **▲ / ▼ / ◀ / ▶** button to select a channel and then use the **ENTER** button to add or delete it. Press **FAV** button to add the channel to the Favorite List. The heart-mark will appear in front of that channel number.
- 5** Press **EXIT** button to return to TV viewing or press **MENU** button to return to the previous menu.

Setup Menu Options continued

DTV Signal Strength



- Shows how strong your DTV signal is and whether you need to adjust your antenna or digital cable input. The higher the signal strength, the less likely you are to experience picture degradation.

- DTV Signals: Only when the input signal is DTV or CADTV, this function is available.

- 1 Press the **MENU** button and then use **▲** / **▼** button to select the **SETUP** menu.
- 2 Press the **▶** button and then use **▲** / **▼** button to select **DTV Signal**.
- 3 View the on-screen signal strength monitor to see the quality of the signal being received.
- 4 Press **EXIT** button to return to TV viewing or press **MENU** button to return to the previous menu.

Input Source



- Changes the picture source so you can watch your TV, cable TV, VCR, DVD, or any other devices that are connected to your TV.

- 1 Press the **MENU** button and then use **▲** / **▼** button to select the **SETUP** menu.
- 2 Press the **▶** button and then use **▲** / **▼** button to select **Input Source**.
- 3 Press the **▶** button and then use **▲** / **▼** button to select the source: TV, AV1, AV2, Component1, Component2, RGB-PC, HDMI1/DVI, or HDMI2.
 - To toggle RGB-PC, select RGB-PC and press **▶** button.
- 4 Press **EXIT** button to return to TV viewing or press **MENU** button to return to the previous menu.

Input Label



- Sets a label to each input source or lets you skip the input source which is not in use when you press **INPUT** button.

- 1 Press the **MENU** button and then use ▲ / ▼ button to select the **SETUP** menu.
- 2 Press the ► button and then use ▲ / ▼ button to select **Input Label**.
- 3 Press the ► button and then use ▲ / ▼ button to select the source: AV1-2, Component1-2, RGB-PC, HDMI1/DVI or HDMI2.
- 4 Press the ◀ / ▶ button to select the label.
- 5 Press **EXIT** button to return to TV viewing or press **MENU** button to return to the previous menu.

External Control Device Setup

- Connect the RS-232C input jack to an external control device (such as a computer or an A/V control system) and control the Monitor's functions externally.
- Connect the serial port of the control device to the RS-232C jack on the TV back panel.
- RS-232C connection cables are not supplied with the TV.

RS-232C Setup

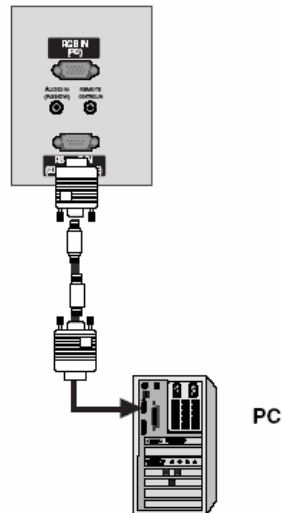

Type of Connector; D-Sub 9-Pin Male

No.	Pin Name
1	No connection
2	RXD (Receive data)
3	TXD (Transmit data)
4	DTR (DTE side ready)
5	GND
6	DSR (DCE side ready)
7	RTS (Ready to send)
8	CTS (Clear to send)
9	No Connection

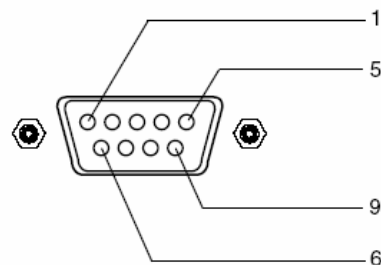

RS-232C Configurations

7-Wire Configurations (Serial female-female NULL modem cable)

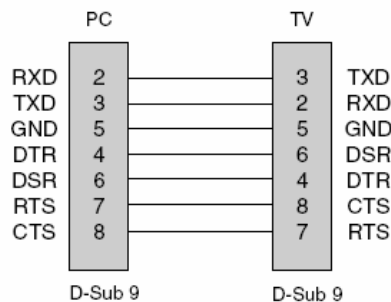

3-Wire Configurations (Not standard)

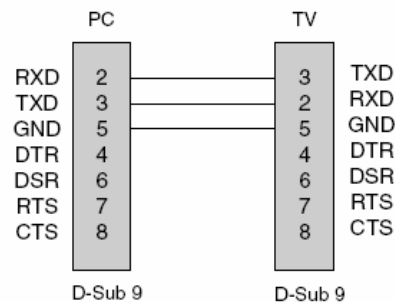

Set ID

- Use this function to specify a TV ID number.
- Refer to 'Real Data Mapping'. See page 55.

1. Press the **MENU** button and then use **▲ / ▼** button to select the **SETUP** menu.
2. Press the **▶** button and then use **▲ / ▼** button to select **Set ID**.
3. Press the **▶** button and then use **▲ / ▼** button to adjust **Set ID** to choose the desired TV ID number. The adjustment range of **Set ID** is 1 ~ 99.
4. Press **EXIT** button to return to TV viewing or press **MENU** button to return to the previous menu.

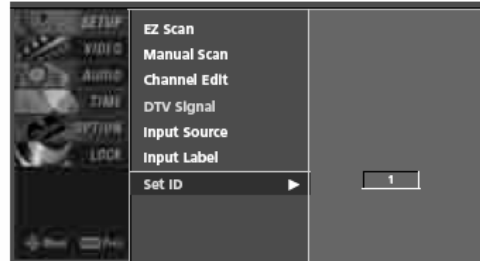

Communication Parameters

- Baud rate : 9600 bps (UART)
- Data length : 8 bits
- Parity : None
- Stop bit : 1 bit
- Communication code : ASCII code

* Use a crossed (reverse) cable.

Command Reference List

	COMMAND 1	COMMAND 2	DATA (Hexadecimal)
01. Power	k	a	0 ~ 1
02. Input Select	k	b	* (Refer to p.55)
03. Aspect Ratio	k	c	* (Refer to p.55)
04. Screen Mute	k	d	0 ~ 1
05. Volume Mute	k	e	0 ~ 1
06. Volume Control	k	f	0 ~ 64
07. Contrast	k	g	0 ~ 64
08. Brightness	k	h	0 ~ 64
09. Color	k	i	0 ~ 64
10. Tint	k	j	0 ~ 64
11. Sharpness	k	k	0 ~ 64
12. OSD Select	k	l	0 ~ 1
13. Remote Control Lock Mode	k	m	0 ~ 1
14. Treble	k	r	0 ~ 64
15. Bass	k	s	0 ~ 64
16. Balance	k	t	0 ~ 64
17. Color Temperature	k	u	0 ~ 3
18. ISM Method	j	p	* (Refer to p.57)
19. Low Power	j	q	0 ~ 1

Transmission / Receiving Protocol

Transmission

[Command1][Command2][][Set ID][][Data][Cr]

- * [Command 1]: First command to control the set.(j,k,m or x)
- * [Command 2]: Second command to control the set.
- * [Set ID]: You can adjust the set ID to choose desired monitor ID number in Setup menu. Adjustment range is 1 ~ 99. When selecting Set ID '0', every connected the TV is controlled. Set ID is indicated as decimal (1~99) on menu and as Hexa decimal (0x0~0x63) on transmission/receiving protocol.
- * [DATA]: To transmit command data.
Transmit 'FF' data to read status of command.
- * [Cr]: Carriage Return
ASCII code '0x0D'
- * []: ASCII code 'space (0x20)'

OK Acknowledgement

[Command2][][Set ID][][OK][Data][x]

* The Monitor transmits ACK (acknowledgement) based on this format when receiving normal data. At this time, if the data is data read mode, it indicates present status data. If the data is data write mode, it returns the data of the PC computer.

Error Acknowledgement

[Command2][][Set ID][][NG][Data][x]

* The Monitor transmits ACK (acknowledgement) based on this format when receiving abnormal data from non-viable functions or communication errors.

- Data 1: Illegal Code
2: Not supported function
3: Wait more time

	COM- MAND 1	COM- MAND 2	DATA 0 (Hexadecimal)	DATA 1 (Hexadecimal)	DATA 2 (Hexadecimal)	DATA 3 (Hexadecimal)	DATA 4 (Hexadecimal)	DATA 5 (Hexadecimal)
20. Channel Tuning	m	a	physical/program high	major/program low	major low	minor high	minor low	attribute
21. Channel Add/Del	m	b	00 ~ 01					
22. Key	m	c	key code					
23. Input Select	x	b	* (Refer to p.58)					

Troubleshooting Checklist

The operation does not work normally.	
The remote control doesn't work	<ul style="list-style-type: none"> • Check to see if there is any object between the product and the remote control causing obstruction. • Are batteries installed with correct polarity (+ to +, - to -)? • Correct remote operating mode set: TV, VCR etc.? • Install new batteries.
Power is suddenly turned off	<ul style="list-style-type: none"> • Is the sleep timer set? • Check the power control settings. Power interrupted • No broadcast on station tuned with Auto off activated.

The video function does not work.	
No picture & No sound	<ul style="list-style-type: none"> • Check whether the product is turned on. • Try another channel. The problem may be with the broadcast. • Is the power cord inserted into wall power outlet? • Check your antenna direction and/or location. • Test the wall power outlet, plug another product's power cord into the outlet where the product's power cord was plugged in.
Picture appears slowly after switching on	<ul style="list-style-type: none"> • This is normal, the image is muted during the product startup process. Please contact your service center, if the picture has not appeared after five minutes.
No or poor color or poor picture	<ul style="list-style-type: none"> • Adjust Color in menu option. • Keep a sufficient distance between the product and the VCR. • Try another channel. The problem may be with the broadcast. • Are the video cables installed properly? • Activate any function to restore the brightness of the picture.
Horizontal/vertical bars or picture shaking	<ul style="list-style-type: none"> • Check for local interference such as an electrical appliance or power tool.
Poor reception on some channels	<ul style="list-style-type: none"> • Station or cable product experiencing problems, tune to another station. • Station signal is weak, reorient antenna to receive weaker station. • Check for sources of possible interference.
Lines or streaks in pictures	<ul style="list-style-type: none"> • Check antenna (Change the direction of the antenna).

The audio function does not work.	
Picture OK & No sound	<ul style="list-style-type: none"> • Press the VOL or VOLUME button. • Sound muted? Press MUTE button. • Try another channel. The problem may be with the broadcast. • Are the audio cables installed properly?
No output from one of the speakers	<ul style="list-style-type: none"> • Adjust Balance in menu option.
Unusual sound from inside the product	<ul style="list-style-type: none"> • A change in ambient humidity or temperature may result in an unusual noise when the product is turned on or off and does not indicate a fault with the product.

There is a problem in PC mode. (Only PC mode applied)	
The signal is out of range.	<ul style="list-style-type: none"> • Adjust resolution, horizontal frequency, or vertical frequency. • Check it whether the signal cable is connected or loose. • Check the input source.
Vertical bar or stripe on background & Horizontal Noise & Incorrect position	<ul style="list-style-type: none"> • Work the Auto configure or adjust clock, phase, or H/V position. (Option)
Screen color is unstable or single color	<ul style="list-style-type: none"> • Check the signal cable. • Reinstall the PC video card.

Maintenance

- Early malfunctions can be prevented. Careful and regular cleaning can extend the amount of time you will have your new TV. Be sure to turn the power off and unplug the power cord before you begin any cleaning.

Cleaning the Screen

1. Here's a great way to keep the dust off your screen for a while. Wet a soft cloth in a mixture of lukewarm water and a little fabric softener or dish washing detergent. Wring the cloth until it's almost dry, and then use it to wipe the screen.
2. Make sure the excess water is off the screen, and then let it air-dry before you turn on your TV.

Cleaning the Cabinet

To remove dirt or dust, wipe the cabinet with a soft, dry, lint-free cloth.
Please do not use a wet cloth.

Extended Absence



If you expect to leave your TV dormant for a long time (such as a vacation), it's a good idea to unplug the power cord to protect against possible damage from lightning or power surges.

Product Specifications

60PC1D (60PC1D-UE)	Dimensions (Width x Height x Depth)	with stand	60.8 x 40.8 x 16.0 inches 1544.0 x 1035.5 x 408.2 mm
		without stand	60.8 x 38.4 x 4.7 inches 1544.0 x 977.0 x 119.2 mm
	Weight	with stand	163 pounds / 74.0 kg
		without stand	137.3 pounds / 62.26 kg
42PC3DU (42PC3DU-UE)	Dimensions (Width x Height x Depth)	with stand	44.4 x 29.5x 15.0 inches 1129.0 x 748.5 x 380.0 mm
		without stand	44.4 x 27.4 x 4.1 inches 1129.0 x 695 x 103.7 mm
	Weight	with stand	64.4 pounds / 29.2 kg
		without stand	55.8 pounds / 25.3 kg
42PC3DVU (42PC3DVU-UE)	Dimensions (Width x Height x Depth)	with stand	44.4 x 29.5x 15.0 inches 1129.0 x 748.5 x 380.0 mm
		without stand	44.4 x 27.4 x 4.1 inches 1129.0 x 695 x 103.7 mm
	Weight	with stand	62.6 pounds / 28.4 kg
		without stand	54.0 pounds / 24.5 kg
50PC3DU (50PC3DU-UE)	Dimensions (Width x Height x Depth)	with stand	51.3 x 34.3 x 14.0 inches 1302.6 x 872.0 x 355.8 mm
		without stand	51.3 x 31.9 x 4.2 inches 1302.6 x 810.0 x 107.7 mm
	Weight	with stand	114.4 pounds / 51.9 kg
		without stand	95.0 pounds / 43.1 kg
Power requirement		AC100-240V ~ 50/60Hz	
Television System		NTSC-M, ATSC, 64 & 256 QAM	
Program Coverage		VHF 2 ~ 13, UHF 14 ~ 69, CATV 1 ~ 135, CADTV 1 ~ 135, DTV 2 ~ 69	
External Antenna Impedance		75 Ω	
Environmental condition	Operating Temperature		32 ~ 104°F (0 ~ 40°C)
	Operating Humidity		Less than 80%
	Storage Temperature		-4 ~ 140°F (-20 ~ 60°C)
	Storage Humidity		Less than 85%

• The specifications shown above may be changed without prior notice for quality improvement.

32LC2DU (32LC2DU-UE)	Dimensions (Width x Height x Depth)	with stand	31.9 x 24.8 x 9.3 inches 811 x 630 x 235 mm
		without stand	31.9 x 22.3 x 4.9 inches 811.0 x 566.8 x 123.5 mm
	Weight	with stand	48.3 pounds / 21.9 kg
		without stand	40.8 pounds / 18.5 kg
37LC2DU (37LC2DU-UE)	Dimensions (Width x Height x Depth)	with stand	37.2 x 28.7 x 11.3 inches 944 x 729 x 286 mm
		without stand	37.2 x 26.0 x 5.1 inches 944.0 x 659.3 x 129.7 mm
	Weight	with stand	65.0 pounds / 29.5 kg
		without stand	54.9 pounds / 24.9 kg
42LC2DU (42LC2DU-UE)	Dimensions (Width x Height x Depth)	with stand	41.5 x 32.0 x 11.9 inches 1054 x 813 x 302 mm
		without stand	41.5 x 29.4x 5.4 inches 1054.0 x 746.0 x 136.8 mm
	Weight	with stand	81.6 pounds / 37.0 kg
		without stand	67.0 pounds / 30.4 kg
Power requirement		AC100-240V ~ 50/60Hz	
Television System		NTSC-M, ATSC, 64 & 256 QAM	
Program Coverage		VHF 2 ~ 13, UHF 14 ~ 69, CATV 1 ~ 135, CADTV 1 ~ 135, DTV 2 ~ 69	
External Antenna Impedance		75 Ω	
Environmental condition	Operating Temperature		32 ~ 104°F (0 ~ 40°C)
	Operating Humidity		Less than 80%
	Storage Temperature		-4 ~ 140°F (-20 ~ 60°C)
	Storage Humidity		Less than 85%

- The specifications shown above may be changed without prior notice for quality improvement.

