



LCD TV OWNER'S MANUAL

26LG40
32LG40

Please read this manual carefully before operating your set and retain it for future reference.
Write the model number and serial number from the label on the back cabinet on the front or back of this manual.

ENERGY STAR is a set of power-saving guidelines issued by the U.S. Environmental Protection Agency(EPA).



As an ENERGY STAR Partner LGE U. S. A.,Inc. has determined that this product meets the ENERGY STAR guidelines for energy efficiency.

P/NO : SAC31712401 (0802-REV00)

www.lgusa.com / www.lg.ca

WARNING / CAUTION



TO REDUCE THE RISK OF ELECTRIC SHOCK DO NOT REMOVE COVER (OR BACK). NO USER SERVICEABLE PARTS INSIDE. REFER TO QUALIFIED SERVICE PERSONNEL.

 The lightning flash with arrowhead symbol, within an equilateral triangle, is intended to alert the user to the presence of uninsulated “dangerous voltage” within the product’s enclosure that may be of sufficient magnitude to constitute a risk of electric shock to persons.

 The exclamation point within an equilateral triangle is intended to alert the user to the presence of important operating and maintenance (servicing) instructions in the literature accompanying the appliance.

WARNING/CAUTION

TO REDUCE THE RISK OF FIRE AND ELECTRIC SHOCK, DO NOT EXPOSE THIS PRODUCT TO RAIN OR MOISTURE.

NOTE TO CABLE/TV INSTALLER

This reminder is provided to call the CATV system installer’s attention to Article 820-40 of the National Electric Code (U.S.A.). The code provides guidelines for proper grounding and, in particular, specifies that the cable ground shall be connected to the grounding system of the building, as close to the point of the cable entry as practical.

WARNING / CAUTION

To prevent fire or shock hazards, do not expose this product to rain or moisture.

FCC NOTICE

Class B digital device

This equipment has been tested and found to comply with the limits for a Class B digital device, pursuant to Part 15 of the FCC Rules. These limits are designed to provide reasonable protection against harmful interference in a residential installation. This equipment generates, uses and can radiate radio frequency energy and, if not installed and used in accordance with the instructions, may cause harmful interference to radio communications. However, there is no guarantee that interference will not occur in a particular installation. If this equipment does cause harmful interference to radio or television reception, which can be determined by turning the equipment off and on, the user is encouraged to try to correct the interference by one or more of the following measures:

- Reorient or relocate the receiving antenna.
- Increase the separation between the equipment and receiver.
- Connect the equipment to an outlet on a circuit different from that to which the receiver is connected.
- Consult the dealer or an experienced radio/TV technician for help.

Any changes or modifications not expressly approved by the party responsible for compliance could void the user’s authority to operate the equipment.

CAUTION

Do not attempt to modify this product in any way without written authorization from LG Electronics. Unauthorized modification could void the user’s authority to operate this product

SAFETY INSTRUCTIONS

IMPORTANT SAFETY INSTRUCTIONS

Important safety instructions shall be provided with each apparatus. This information shall be given in a separate booklet or sheet, or be located before any operating instructions in an instruction for installation for use and supplied with the apparatus.

This information shall be given in a language acceptable to the country where the apparatus is intended to be used. The important safety instructions shall be entitled "Important Safety Instructions". The following safety instructions shall be included where applicable, and, when used, shall be verbatim as follows. Additional safety information may be included by adding statements after the end of the following safety instruction list. At the manufacturer's option, a picture or drawing that illustrates the intent of a specific safety instruction may be placed immediately adjacent to that safety instruction:

Read these instructions.
Keep these instructions.
Heed all warnings.
Follow all instructions.



- 1 Do not use this apparatus near water.



- 2 Clean only with dry cloth.



- 3 Do not block any ventilation openings. Install in accordance with the manufacturer's instructions.



- 4 Do not install near any heat sources such as radiators, heat registers, stoves, or other apparatus (including amplifiers) that produce heat.



- 5 When mounting a TV it on the wall, make sure not to install TV by the hanging power and signal cables on the back of the TV.

- 6 Do not defeat the safety purpose of the polarized or grounding-type plug. A polarized plug has two blades with one wider than the other. A grounding type plug has two blades and a third grounding prong. The wide blade or the third prong are provided for your safety. If the provided plug does not fit into your outlet, consult an electrician for replacement of the obsolete outlet.



- 7 Protect the power cord from being walked on or pinched particularly at plugs, convenience receptacles, and the point where they exit from the apparatus.



- 8 Only use attachments/accessories specified by the manufacturer.

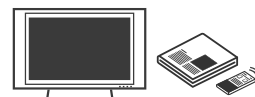

- 9 Unplug this apparatus when unused for long periods of time.

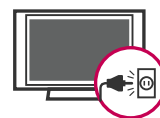

- 10 Use only with the cart, stand, tripod, bracket, or table specified by the manufacturer, or sold with the apparatus. When a cart is used, use caution when moving the cart/apparatus combination to avoid injury from tip-over.



- 11 Never touch this apparatus or antenna during a thunder or lightning storm.

- 12 Do not allow a impact shock or any objects to fall into the product, and do not drop onto the screen with something.

- 13 Refer all servicing to qualified service personnel. Servicing is required when the apparatus has been damaged in any way, such as power-supply cord or plug is damaged, liquid has been spilled or objects have fallen into the apparatus, the apparatus has exposed to rain or moisture, does not operate normally, or has been dropped.



- 14 CAUTION concerning the Power Cord : Most appliances recommend they be placed upon a dedicated circuit; that is, a single outlet circuit which powers only that appliance and has no additional outlets or branch circuits. Check the specification page of this owner's manual to be certain.

Do not overload wall outlets. Overloaded wall outlets, loose or damaged wall outlets, extension cords, frayed power cords, or damaged or cracked wire insulation are dangerous. Any of these conditions could result in electric shock or fire. Periodically examine the cord of your appliance, and if its appearance indicates damage or deterioration, unplug it, discontinue use

of the appliance, and have the cord replaced with an exact replacement part by an authorized servicer. Protect the power cord from physical or mechanical abuse, such as being twisted, kinked, pinched, closed in a door, or walked upon. Pay particular attention to plugs, wall outlets, and the point where the cord exits the appliance.



- 15 Outdoor use marking :
WARNING - To reduce the risk of fire or electric shock, do not expose this appliance to rain or moisture.



- 16 Wet Location Marking : Apparatus shall not be exposed to dripping or splashing and no objects filled with liquids, such as vases, shall be placed on or over apparatus.



17 GROUNDING

Ensure that you connect the earth ground wire to prevent possible electric shock. If grounding methods are not possible, have a qualified electrician install a separate circuit breaker.

Do not try to ground the unit by connecting it to telephone wires, lightening rods, or gas pipes.

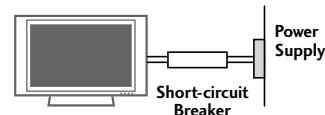

- 18 DISCONNECTING DEVICE FROM MAINS
Mains plug is the disconnecting device. The plug must remain readily operable.

CONTENTS

WARNING / CAUTION	1
SAFETY INSTRUCTIONS	2

PREPARATION

Accessories	7
Front Panel Information	8
Back Panel Information	10
Stand Installation	12
Cable Management	13
Desktop Pedestal Installation	14
Swivel Stand	14
VESA Wall Mounting	14
Protection Cover	15
Attaching the TV to a Desk	16
Positioning your Display	16
Kensington Security System	16
Antenna or Cable Connection	17

EXTERNAL EQUIPMENT SETUP

HD Receiver Setup	18
DVD Setup	23
VCR Setup	26
Headphone Setup	29
Other A/V Source Setup	29
Audio out Connection	30
PC Setup	31

WATCHING TV / CHANNEL CONTROL

Remote Control Functions	38
Turning On TV	40
Channel Selection	40
Volume Adjustment	40
Quick Menu	41
Initial Setting	42
On-Screen Menus Selection	44

Channel Setup	
- Auto Scan (Auto Tuning)	45
- Add / Delete Channel (Manual Tuning)	46
- Channel Editing	47
Input List	48
Input Label	49

PICTURE CONTROL

Picture Size (Aspect Ratio) Control	50
Preset Picture Settings	
- Picture Mode - Preset	52
- Color Tone - Preset	53
Manual Picture Adjustment	
- Picture Mode - User Mode	54
Picture Improvement Technology	55
Advanced Control - Black (Darkness) Level	56
Advanced Control - Eye Care	57
Advanced Control - Real Cinema	58
Picture Reset	59
Power Indicator	60

SOUND & LANGUAGE CONTROL

Auto Volume Leveler (Auto Volume)	61
Preset Sound Setting (Sound Mode)	62
Sound Setting Adjustment - User Mode	63
Balance	64
TV Speakers On/Off Setup	65
Audio Reset	66
Stereo/SAP Broadcasts Setup	67
Audio Language	68
On-Screen Menus Language Selection	69
Caption Mode	
- Analog Broadcasting System Captions	70
- Digital Broadcasting System Captions	71
- Caption Option	72

TIME SETTING

Clock Setting	
- Auto Clock Setup	73
- Manual Clock Setup	74
Auto On/Off Time Setting	75
Sleep Timer Setting	76
Auto Shut-off Setting	77

PARENTAL CONTROL / RATINGS

Set Password & Lock System	78
Channel Blocking	81
Movie & TV Rating	82
Downloadable Rating	87
External Input Blocking	88
Key Lock	89

APPENDIX

Troubleshooting	90
Maintenance	92
Product Specifications	93
External Control Through RS-232C	94
Open Source License	100



Manufactured under license from Dolby Laboratories. "Dolby" and the double-D symbol are trademarks of Dolby Laboratories.



is a trademark of DVD format/Logo Licensing Corporation.

This product incorporates copy protection technology that is protected by U.S. and foreign patents, including patent number 5,315,448 and 6,836,549, and other intellectual property rights. The use of Macrovision's copy protection technology in the product must be authorized by Macrovision. Reverse engineering or disassembly is prohibited."

-
- If the TV feels cold to the touch, there may be a small "flicker" when it is turned on. This is normal, there is nothing wrong with TV.
 - Some minute dot defects may be visible on the screen, appearing as tiny red, green, or blue spots. However, they have no adverse effect on the monitor's performance.
 - Avoid touching the LCD screen or holding your finger(s) against it for long periods of time. Doing so may produce some temporary distortion effects on the screen.

On Disposal

The fluorescent lamp used in this product contains a small amount of mercury. Do not dispose of this product with general household waste. Disposal of this product must be carried out in accordance to the regulations of your local authority.

PREPARATION

ACCESSORIES

Ensure that the following accessories are included with your TV. If an accessory is missing, please contact the dealer where you purchased the TV.

The accessories included may differ from the images below.



Owner's Manual



CD Manual

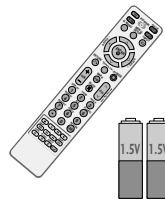

Remote Control,
Batteries

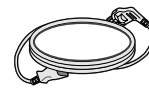

Power Cord

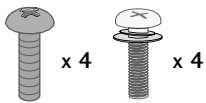

Bolts for stand assembly
(Refer to P.12)



Screw for stand fixing
(Refer to P.16)

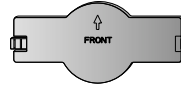

Protection Cover



Cable Management
Clip



Polishing Cloth
(This feature is not available
for all models.)

- * Wipe spots on the exterior only with the polishing cloth.
- * Do not wipe roughly when removing stain. Please be cautious of that excessive pressure may cause scratch or discoloration.

Option Extras

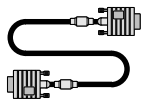

D-sub 15 pin Cable

When using the VGA (D-sub 15 pin cable) PC connection, the user must use shielded signal interface cables with ferrite cores to maintain standards compliance.

PREPARATION

FRONT PANEL INFORMATION

- Image shown may differ from your TV.
- **NOTE:** If your TV has a protection tape attached, remove the tape. And then wipe the TV with a cloth (If a polishing cloth is included with your product, use it).

PREPARATION

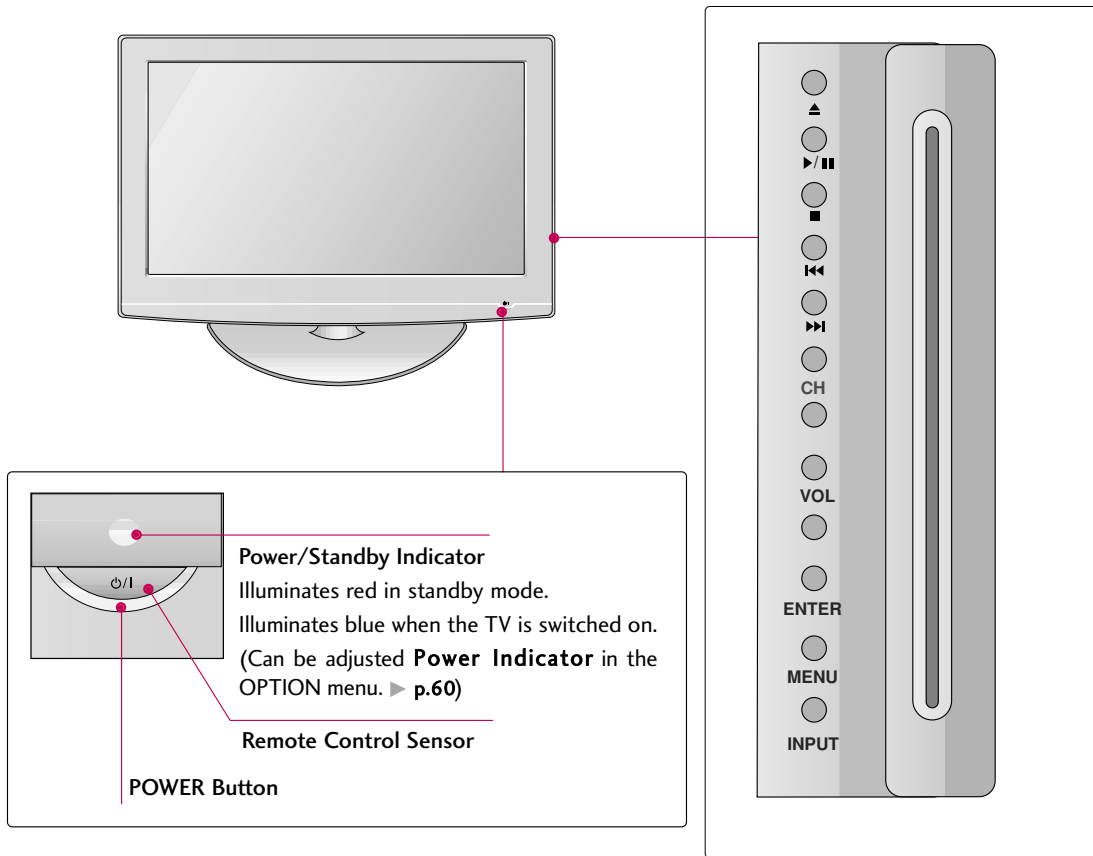

BACK PANEL INFORMATION

- Image shown may differ from your TV.

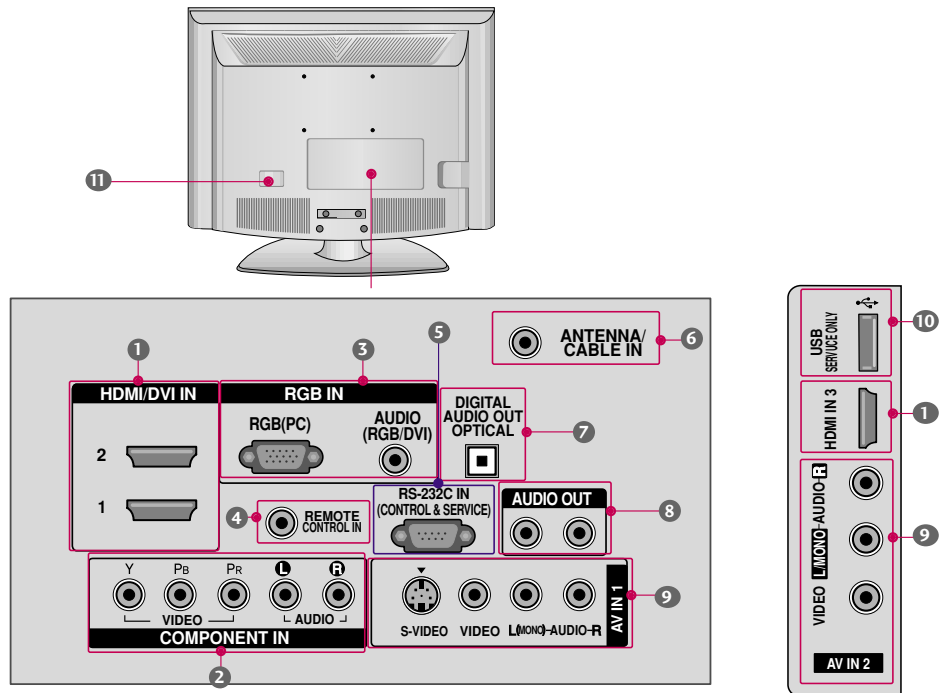

- HDMI/DVI IN, HDMI IN**
Digital Connection. Supports HD video and Digital audio. Doesn't support 480i.
Accepts DVI video using an adapter or HDMI to DVI cable (not included)
- COMPONENT IN**
Analog Connection. Supports HD.
Uses a red, green, and blue cable for video & red and white for audio.
- RGB (PC)**
Analog PC Connection. Uses a D-sub 15 pin cable (VGA cable).
AUDIO (RGB/DVI)
1/8" headphone jack for analog PC audio input.
- REMOTE CONTROL PORT**
For a wired remote control.
- RS-232C IN (CONTROL & SERVICE) PORT**
Used by third party devices.
- ANTENNA/CABLE IN**
Connect over-the air signals to this jack.
Connect cable signals to this jack.
- DIGITAL AUDIO OUT OPTICAL**
Digital audio output for use with amps and home theater systems.
Includes an optical connection.
Note: In standby mode, these ports do not work.
- AUDIO OUT**
Analog audio output for use with amps and home theater systems.
- AV (Audio/Video) IN**
Analog composite connection. Supports standard definition video only (480i).
S-VIDEO
Better quality than standard composition. Supports standard definition video only (480i).
- USB SERVICE ONLY**
Used for software updates.
- Power Cord Socket**
For operation with AC power.
Caution: Never attempt to operate the TV on DC power.

PREPARATION

STAND INSTALLATION

■ Image shown may differ from your TV

- 1 Carefully place the TV screen side down on a cushioned surface to protect the screen from damage.

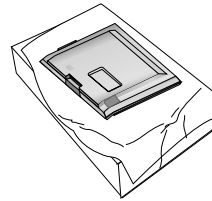

- 2 Assemble the parts of the **STAND BODY** with **COVER BASE** of the TV.

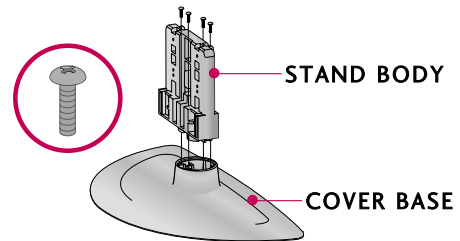

- 3 Assemble the TV as shown.

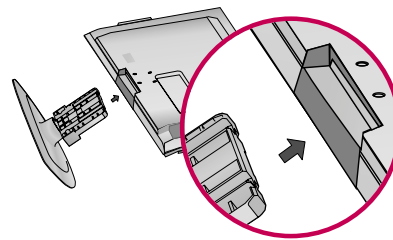

- 4 Fix the 4 bolts securely using the holes in the back of the TV.

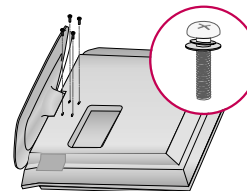

CABLE MANAGEMENT

■ Image shown may differ from your TV

- 1 Align the hole with the tab on the **CABLE MANAGEMENT CLIP**.
Turn the **CABLE MANAGEMENT CLIP** as shown.
Note: This cable management can be broken by excessive pressure.

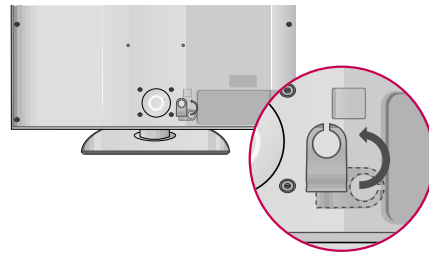
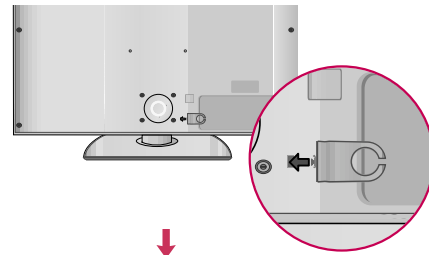

- 2 Connect the cables as necessary.
To connect additional equipment, see the **EXTERNAL EQUIPMENT SETUP** section.

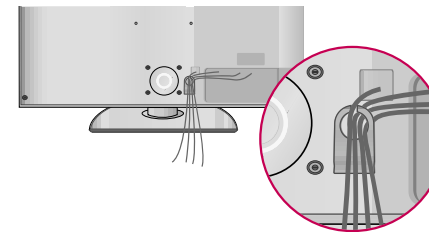

PREPARATION

DESKTOP PEDESTAL INSTALLATION

- Image shown may differ from your TV.

For proper ventilation, allow a clearance of 4 inches on all four sides from the wall.

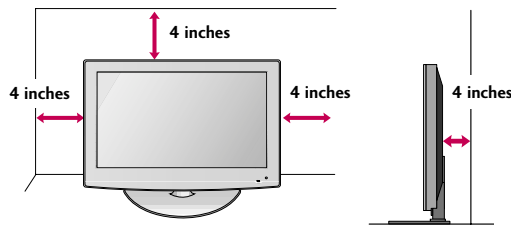

CAUTION ▶ Ensure adequate ventilation by following the clearance recommendations.

SWIVEL STAND

After installing the TV, you can adjust the TV set manually to the left or right direction by 20 degrees to suit your viewing position.

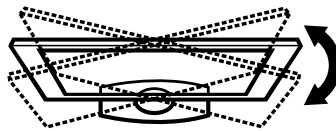

VESA WALL MOUNTING

This TV accepts VESA FDMI compliant mounts via the four screw holes on the back of the TV. These mounts are sold by third parties and not available from LG. Refer to the instructions included with the mount for more info.

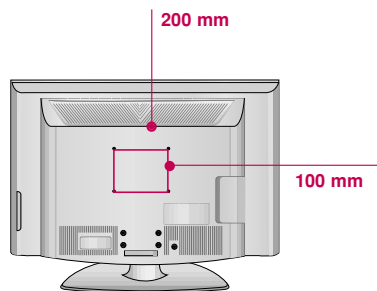

NOTE

- ▶ Screw length needed depends on the wall mount used. For further information, refer to the instructions included with the mount.

PROTECTION COVER

- Image shown may differ from your TV.

You can remove the stand before installing the TV on a wall mount by performing the previous stand instructions in reverse. After removing the stand, install the included **protection cover** over the hole for the stand.

Insert the **PROTECTION COVER** into the TV until clicking sound.

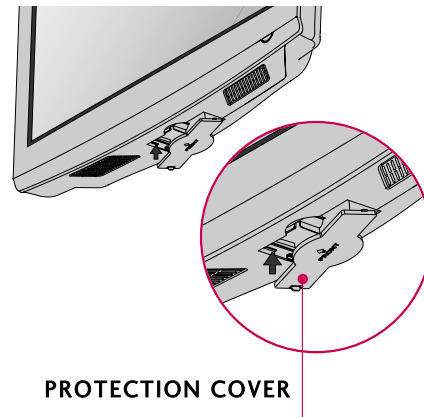

ATTACHING THE TV TO A DESK

The TV must be attached to a desk so it cannot be pulled in a forward/backward direction, potentially causing injury or damaging the product.

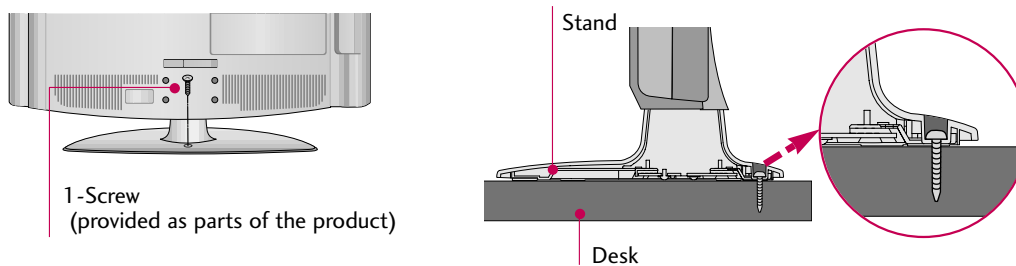

⚠ WARNING

- ▶ To prevent TV from falling over, the TV should be securely attached to the floor/wall per installation instructions. Tipping, shaking, or rocking the machine may cause injury.

PREPARATION

SECURING THE TV TO THE WALL TO PREVENT FALLING

PREPARATION

- You should purchase necessary components to prevent TV from falling off of the stand.
- Image shown may differ from your TV.

We recommend that you set up the TV close to a wall so it cannot fall over if pushed backwards. Additionally, we recommend that the TV be attached to a wall so it cannot be pulled in a forward direction, potentially causing injury or damaging the product.

Caution: Please make sure that children don't climb on or hang from the TV.

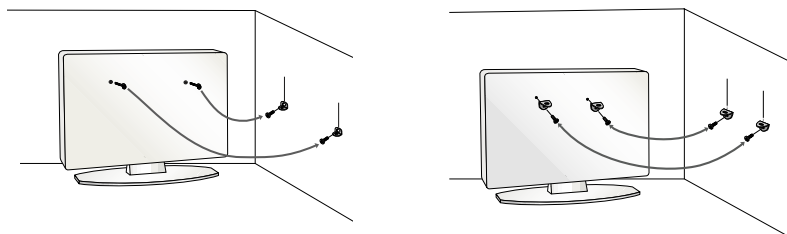

- Insert the eye-bolts (or TV brackets and bolts) to tighten the product to the wall as shown in the picture.
 - * If your product has the bolts in the eye-bolts position before inserting the eye-bolts, loosen the bolts.
 - * Insert the eye-bolts or TV brackets/bolts and tighten them securely in the upper holes.
- Secure the wall brackets with the bolts (not provided as parts of the product, must purchase separately) to the wall. Match the height of the bracket that is mounted on the wall to the holes in the product.
- Ensure the eye-bolts or brackets are tightened securely.

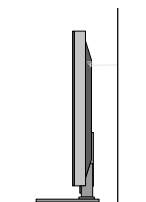

- Use a sturdy rope (not provided as parts of the product, must purchase separately) to tie the product. It is safer to tie the rope so it becomes horizontal between the wall and the product.

! NOTE

- ▶ Use a platform or cabinet strong enough and large enough to support the size and weight of the TV.
- ▶ To use the TV safely make sure that the height of the bracket on the wall and the one on the TV are the same.

- To prevent damage do not connect to the power outlet until all connections are made between the devices.
- Image shown may differ from your TV.

ANTENNA OR CABLE CONNECTION

1. Antenna (Analog or Digital)

Wall Antenna Socket or Outdoor Antenna without a Cable Box Connections.

For optimum picture quality, adjust antenna direction if needed.

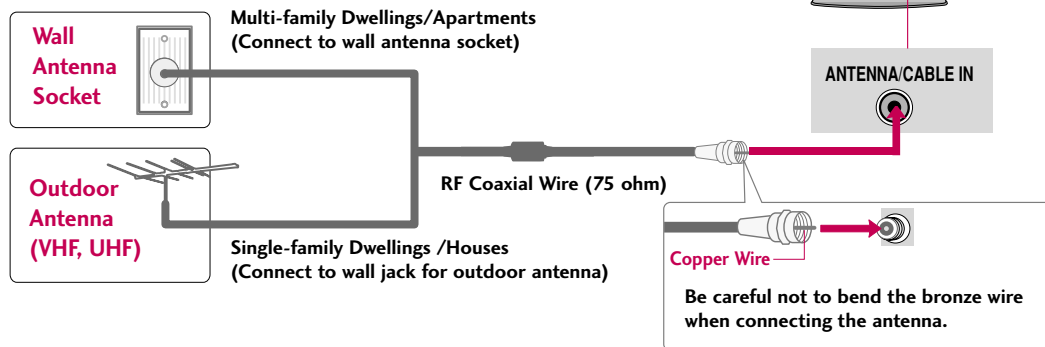

2. Cable

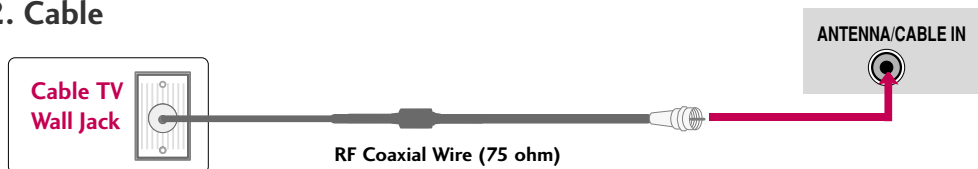

- To improve the picture quality in a poor signal area, please purchase a signal amplifier and install properly.
- If the antenna needs to be split for two TV's, install a 2-Way Signal Splitter.
- If the antenna is not installed properly, contact your dealer for assistance.

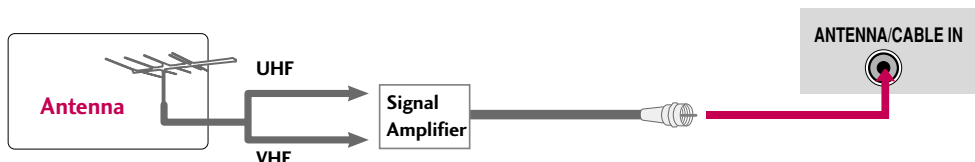

EXTERNAL EQUIPMENT SETUP

- To prevent the equipment damage, never plug in any power cords until you have finished connecting all equipment.

HD RECEIVER SETUP

This TV can receive Digital Over-the-air/Cable signals without an external digital set-top box. However, if you do receive digital signals from a digital set-top box or other digital external device, refer to the figure as shown below.

Component Connection

1. How to connect

- 1 Connect the video outputs (Y, Pb, Pr) of the digital set-top box to the **COMPONENT IN VIDEO** jacks on the TV. Match the jack colors (Y = green, Pb = blue, and PR = red).
- 2 Connect the audio output of the digital set-top box to the **COMPONENT IN AUDIO** jacks on the TV.

2. How to use

- Turn on the digital set-top box.
(Refer to the owner's manual for the digital set-top box. operation)
- Select the **Component** input source on the TV using the **INPUT** button on the remote control.

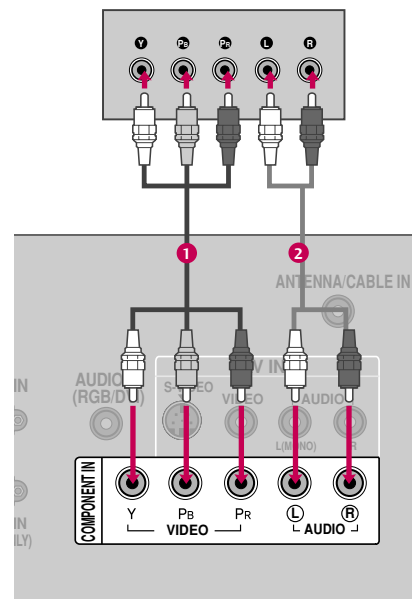

Supported Resolutions

Signal	Component	HDMI
480i	Yes	No
480p	Yes	Yes
720p	Yes	Yes
1080i	Yes	Yes
1080p	Yes	Yes

Y, CB/PB, CR/PR

Resolution	Horizontal Frequency(KHz)	Vertical Frequency(Hz)
720x480i	15.73	59.94
	15.73	60.00
720x480p	31.47	59.94
	31.50	60.00
1280x720p	44.96	59.94
	45.00	60.00
1920x1080i	33.72	59.94
	33.75	60.00
1920x1080p	26.97	23.94
	27.00	24.00
	33.71	29.97
	33.75	30.00
	67.43	59.94
	67.50	60.00

HDMI Connection

1. How to connect

- 1 Connect the digital set-top box to **HDMI/DVI IN1**, **2**, or **3** jack on the TV.
- 2 No separate audio connection is necessary. HDMI supports both audio and video.

2. How to use

- Turn on the digital set-top box.
(Refer to the owner's manual for the digital set-top box.)
- Select the **HDMI1**, **HDMI2**, or **HDMI3** input source on the TV using the **INPUT** button on the remote control.

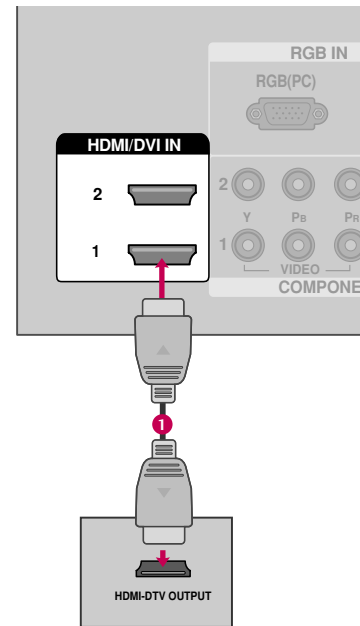

EXTERNAL EQUIPMENT SETUP

HDMI-DTV

Resolution	Horizontal Frequency(KHz)	Vertical Frequency(Hz)
720x480p	31.47	59.94
	31.50	60.00
1280x720p	44.96	59.94
	45.00	60.00
1920x1080i	33.72	59.94
	33.75	60.00
1920x1080p	26.97	23.976
	27.00	24.00
	33.71	29.97
	33.75	30.00
	67.432	59.939
	67.50	60.00

EXTERNAL EQUIPMENT SETUP

DVI to HDMI Connection

EXTERNAL EQUIPMENT SETUP

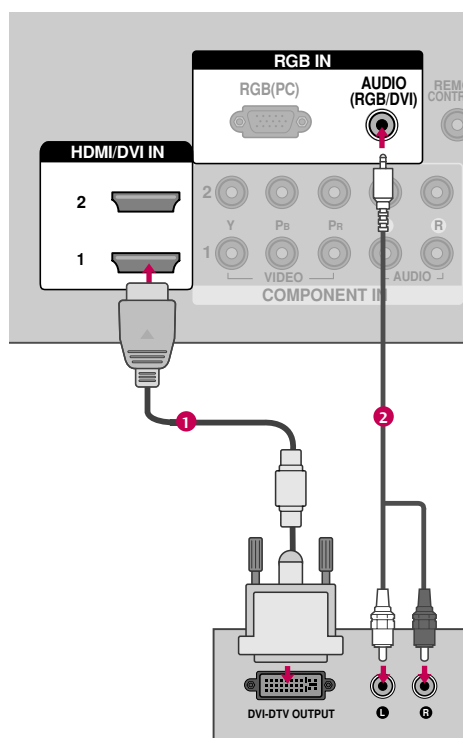

1. How to connect

- 1 Connect the DVI output of the digital set-top box to the **HDMI/DVI IN** or **HDMI/DVI IN 1/2/3** jack on the TV.
- 2 Connect the PC audio output to the **AUDIO IN (RGB/DVI)** or **AUDIO (RGB/DVI)** jack on the TV.

2. How to use

- Turn on the digital set-top box.
(Refer to the owner's manual for the digital set-top box.)
- Select the **HDMI** or **HDMI1/2/3** input source on the TV using the **INPUT** button on the remote control.

NOTE

- ▶ A DVI to HDMI cable or adapter is required for this connection. DVI doesn't support audio, so a separate audio connection is necessary.

DVD SETUP

Component Connection

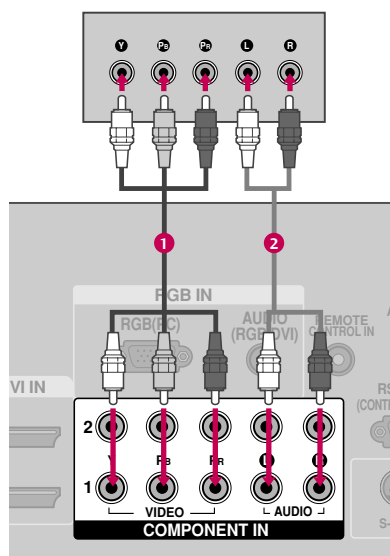

1. How to connect

- 1 Connect the video outputs (Y, Pb, Pr) of the DVD to the **COMPONENT IN VIDEO** or **COMPONENT IN VIDEO1** jacks on the TV. Match the jack colors (Y = green, Pb = blue, and Pr = red).
- 2 Connect the audio outputs of the DVD to the **COMPONENT IN AUDIO** or **COMPONENT IN AUDIO1** jacks on the TV.

2. How to use

- Turn on the DVD player, insert a DVD.
- Select the **Component** or **Component 1** input source on the TV using the **INPUT** button on the remote control.
- If connected to **COMPONENT IN 2** input, select the **Component 2** input source on the TV.
- Refer to the DVD player's manual for operating instructions.

Component Input ports

To get better picture quality, connect a DVD player to the component input ports as shown below.

Component ports on the TV	Y	P _B	P _R
Video output ports on DVD player	Y	P _B	P _R
	Y	B-Y	R-Y
	Y	C _b	C _r
	Y	P _b	P _r

EXTERNAL EQUIPMENT SETUP

S-Video Connection

1. How to connect

- 1 Connect the S-VIDEO output of the DVD to the **S-VIDEO** input on the TV.
- 2 Connect the audio outputs of the DVD to the **AUDIO** input jacks on the TV.

2. How to use

- Turn on the DVD player, insert a DVD.
- Select the **AV** or **AV1** input source on the TV using the **INPUT** button on the remote control.
- Refer to the DVD player's manual for operating instructions.

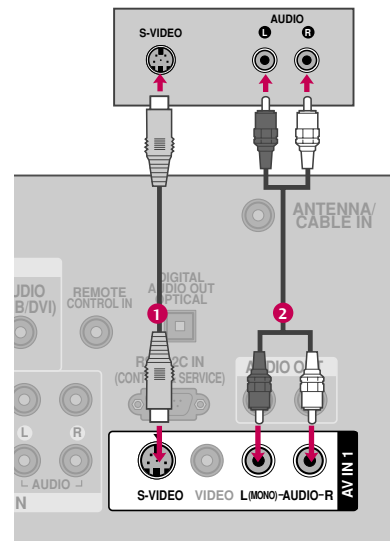

HDMI Connection

1. How to connect

- 1 Connect the HDMI output of the DVD to the **HDMI/DVI IN** or **HDMI/DVI IN 1/2/3** jack on the TV.
- 2 No separated audio connection is necessary. HDMI supports both audio and video.

2. How to use

- Select the **HDMI** or **HDMI 1/2/3** input source on the TV using the **INPUT** button on the remote control.
- Refer to the DVD player's manual for operating instructions.

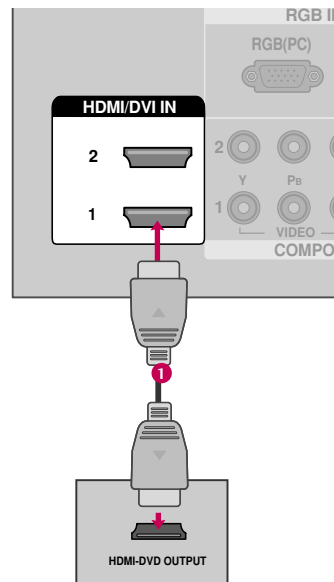

VCR SETUP

- To avoid picture noise (interference), leave an adequate distance between the VCR and TV.
- If the 4:3 picture format is used; the fixed images on the sides of the screen may remain visible on the screen. This phenomenon is common to all TVs and is not covered by warranty.

Antenna Connection

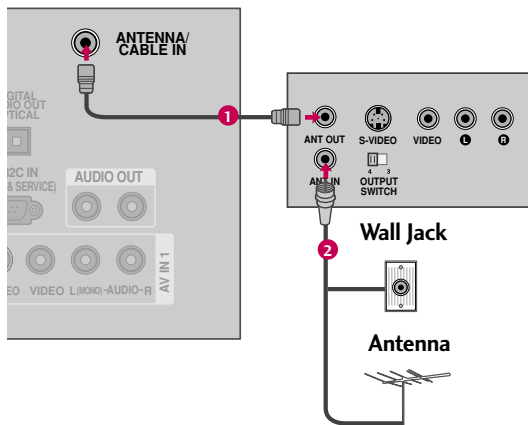

1. How to connect

- 1 Connect the RF antenna out socket of the VCR to the **ANTENNA/CABLE IN** socket on the TV.
- 2 Connect the antenna cable to the RF antenna in socket of the VCR.

2. How to use

- Set VCR output switch to 3 or 4 and then tune TV to the same channel number.
- Insert a video tape into the VCR and press PLAY on the VCR. (Refer to the VCR owner's manual.)

EXTERNAL EQUIPMENT SETUP

Composite (RCA) Connection

1. How to connect

- 1 Connect the **AUDIO/VIDEO** jacks between TV and VCR. Match the jack colors (Video = yellow, Audio Left = white, and Audio Right = red)

2. How to use

- Insert a video tape into the VCR and press PLAY on the VCR. (Refer to the VCR owner's manual.)
- Select the **AV** or **AV1** input source on the TV using the **INPUT** button on the remote control.
- If connected to **AV IN2**, select **AV2** input source on the TV.

NOTE

- ▶ If you have a mono VCR, connect the audio cable from the VCR to the **AUDIO L/MONO** jack of the TV.

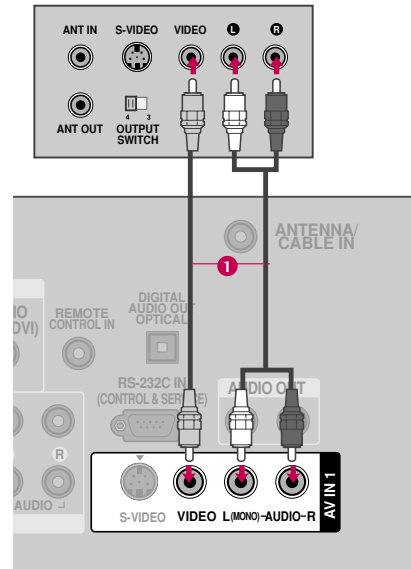

S-Video Connection

1. How to connect

- 1 Connect the S-VIDEO output of the VCR to the **S-VIDEO** input on the TV.
- 2 Connect the audio outputs of the VCR to the **AUDIO** input jacks on the TV.

2. How to use

- Insert a video tape into the VCR and press PLAY on the VCR. (Refer to the VCR owner's manual.)
- Select the **AV** or **AV1** input source on the TV using the **INPUT** button on the remote control.

NOTE

- ▶ The picture quality is improved: compared to normal composite (RCA cable) input.

CAUTION

- ▶ Do not connect to both Video and S-Video at the same time. In the event that you connect both Video and the S-Video cables, only the S-Video will work.

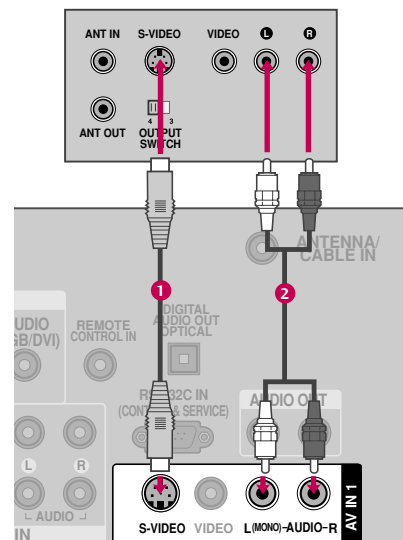

OTHER A/V SOURCE SETUP

1. How to connect

- 1 Connect the **AUDIO/VIDEO** jacks between TV and external equipment. Match the jack colors. (Video = yellow, Audio Left = white, and Audio Right = red)

2. How to use

- Select the **AV2** input source on the TV using the **INPUT** button on the remote control.
- If connected to **AV IN1** input, select the **AV1** input source on the TV.
- Operate the corresponding external equipment.

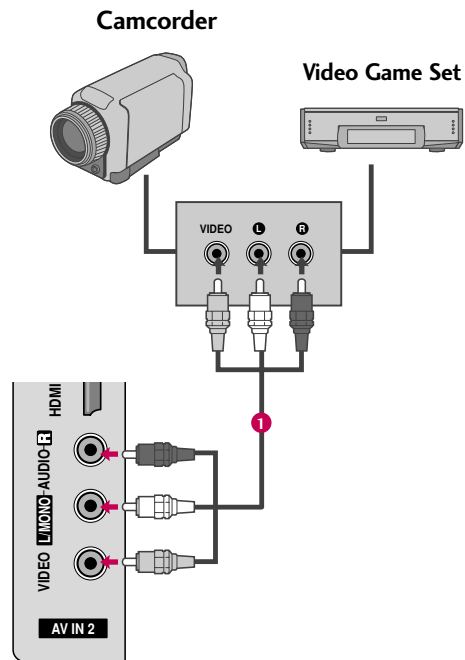

EXTERNAL EQUIPMENT SETUP

AUDIO OUT CONNECTION

Send the TV's audio to external audio equipment via the Audio Output port.

Analog

1. How to connect

- 1 Connect audio outputs to the TV's **AUDIO OUT** jacks.
- 2 Set the "TV Speaker option - Off" in the **AUDIO** menu. (▶ p.65). See the external audio equipment instruction manual for operation.

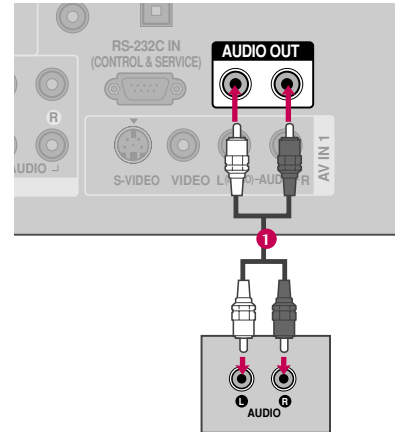

Digital

1. How to connect

- 1 Connect one end of the optical or coaxial cable to the TV's **OPTICAL** port of **DIGITAL AUDIO OUT**.
- 2 Connect the other end of the optical cable to the digital audio input on the audio equipment.
- 3 Set the "TV Speaker option - Off" in the **AUDIO** menu. (▶ p.65). See the external audio equipment instruction manual for operation.

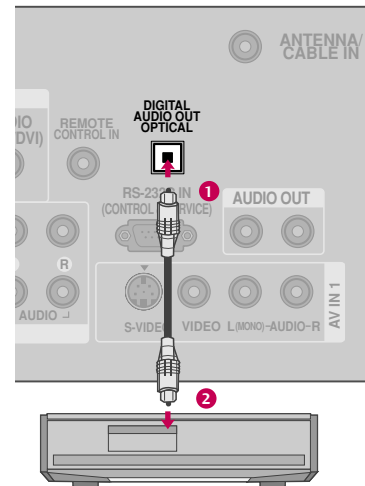

NOTE

- ▶ When connecting with external audio equipments, such as amplifiers or speakers, you can turn the TV speakers off in the menu. (▶ p.65)

CAUTION

- ▶ Do not look into the optical output port. Looking at the laser beam may damage your vision.
- ▶ Block the SPDIF out (optical) about the contents with ACP(Audio Copy Protection) function.

PC SETUP

This TV provides Plug and Play capability, meaning that the PC adjusts automatically to the TV's settings.

VGA (D-Sub 15 pin) Connection

1. How to connect

- 1 Connect the VGA output of the PC to the **RGB (PC)** jack on the TV.
- 2 Connect the PC audio output to the **AUDIO (RGB/DVI)** jack on the TV.

2. How to use

- Turn on the PC and the TV.
- Select the **RGB-PC** input source on the TV using the **INPUT** button on the remote control.

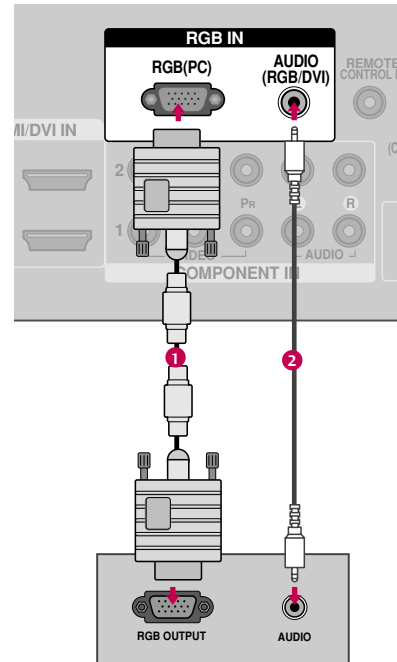

EXTERNAL EQUIPMENT SETUP

DVI to HDMI Connection

1. How to connect

- 1 Connect the DVI output of the PC to the **HDMI/DVI IN 1 or 2** jack on the TV.
- 2 Connect the PC audio output to the **AUDIO (RGB/DVI)** jack on the TV.

2. How to use

- Turn on the PC and the TV.
- Select the **HDMI 1, 2** or **3** input source on the TV using the **INPUT** button on the remote control.

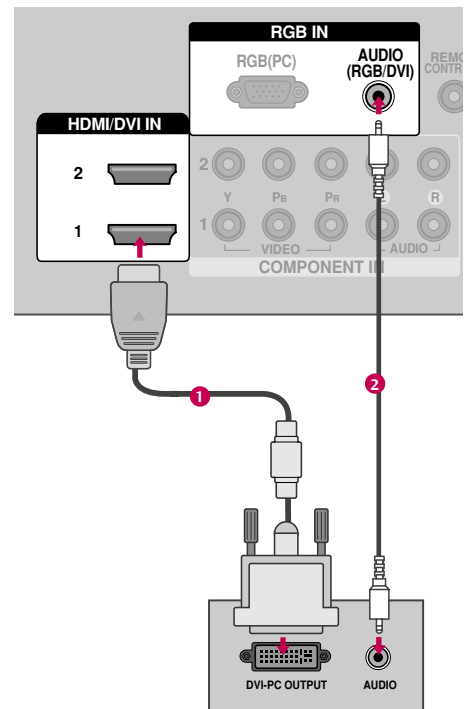



! NOTES

- ▶ To get the the best picture quality, adjust the PC graphics card to 1360x768 (26LG30).
- ▶ Depending on the graphics card, DOS mode may not work if a HDMI to DVI Cable is in use.
- ▶ In PC mode, there may be noise associated with the resolution, vertical pattern, contrast or brightness. If noise is present, change the PC output to another resolution, change the refresh rate to another rate or adjust the brightness and contrast on the PICTURE menu until the picture is clear.
- ▶ Avoid keeping a fixed image on the screen for a long period of time. The fixed image may become permanently imprinted on the screen.
- ▶ The synchronization input form for Horizontal and Vertical frequencies is separate.

Supported Display Specifications (RGB-PC, HDMI-PC)

Resolution	Horizontal Frequency(KHz)	Vertical Frequency(Hz)
640x350	31.469	70.08 ●
720x400	31.469	70.08 ●
640x480	31.469	59.94
800x600	37.879	60.31
1024x768	48.363	60.00
1280x768	47.776	59.87
1360x768	47.720	59.799
1366x768	47.130	59.65

* Only RGB-PC mode

EXTERNAL EQUIPMENT SETUP





Screen Setup for PC mode

Selecting Resolution

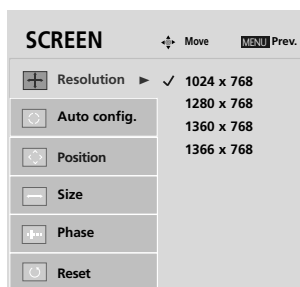
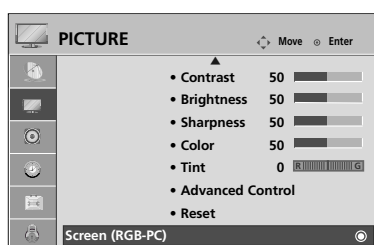
You can choose the resolution in RGB-PC mode.
The **Position**, **Phase**, and **Size** can also be adjusted.

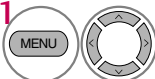
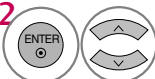
EXTERNAL EQUIPMENT SETUP









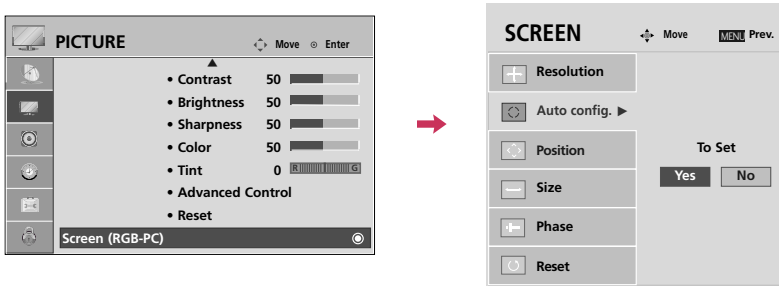

-  Select **PICTURE**.
-  Select **Screen (RGB-PC)**.
-  Select **Resolution**.
-  Select the desired resolution.
- 

Auto Configure

Automatically adjusts picture position and minimizes image instability. After adjustment, if the image is still not correct, try using the manual settings or a different resolution or refresh rate on the PC.



- 1   Select **PICTURE**.
- 2   Select **Screen (RGB-PC)**.
- 3   Select **Auto config..**
- 4   Select **Yes**.
- 5  Start Auto Configuration.

- If the position of the image is still not correct, try Auto adjustment again.
- If picture needs to be adjusted again after Auto adjustment in RGB-PC, you can adjust the **Position, Size** or **Phase**.

EXTERNAL EQUIPMENT SETUP







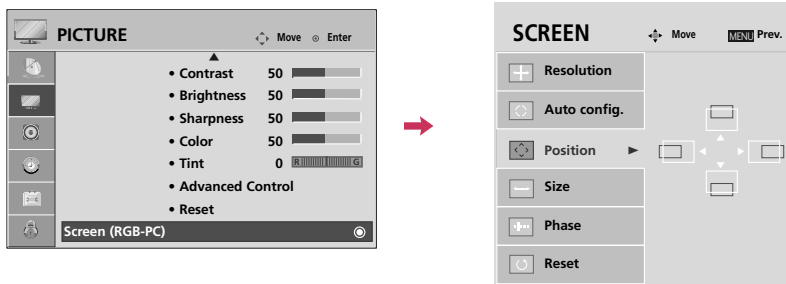

Adjustment for screen Position, Size, and Phase

If the picture is not clear after auto adjustment and especially if characters are still trembling, adjust the picture phase manually.

This feature operates only in RGB-PC mode.

EXTERNAL EQUIPMENT SETUP











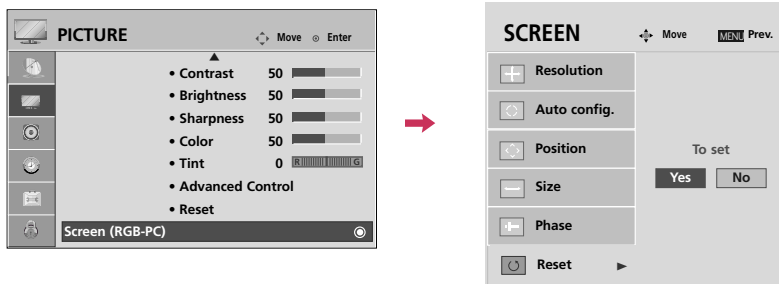

-   Select **PICTURE**.
-   Select **Screen (RGB-PC)**.
-   Select **Position, Size, or Phase**.
-   Make appropriate adjustments.
- 

- **Position:** This function is to adjust picture to left/right and up/down as you prefer.
- **Size:** This function is to minimize any vertical bars or stripes visible on the screen background. And the horizontal screen size will also change.
- **Phase:** This function allows you to remove any horizontal noise and clear or sharpen the image of characters.

Screen Reset (Reset to original factory values)

Returns **Position**, **Size**, and **Phase** to the default factory settings.
This feature operates only in RGB-PC mode.



- 1   Select **PICTURE**.
- 2   Select **Screen (RGB-PC)**.
- 3   Select **Reset**.
- 4   Select **Yes**.
- 5 

WATCHING TV / CHANNEL CONTROL

REMOTE CONTROL FUNCTIONS

When using the remote control, aim it at the remote control sensor on the TV.

WATCHING TV / CHANNEL CONTROL

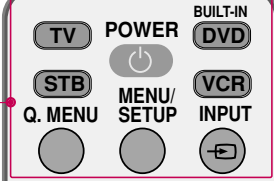
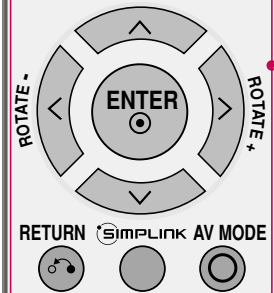
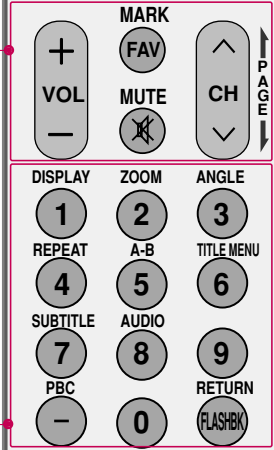
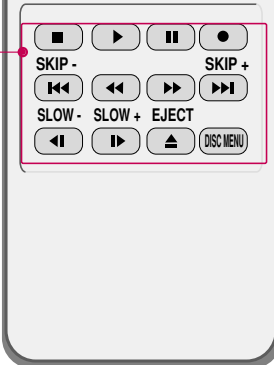
<p>TV/STB/DVD/VCR Select the remote operating mode: TV, STB, DVD, or VCR.</p> <p>POWER Turns your TV or any other programmed equipment on or off, depending on the mode.</p> <p>Q.MENU Select the desired quick menu source. ▶ p.51</p> <p>MENU Displays the main menu. Clear all on-screen displays and return to TV viewing from any menu.</p> <p>INPUT External input modes rotate in regular sequence.</p>	
<p>VOLUME UP /DOWN Increase/decrease the sound level.</p> <p>FAV Scroll through the programmed Favorite channels. ▶ p.51</p> <p>MUTE Switch the sound on or off. ▶ p.50</p> <p>CHANNEL UP/DOWN Select available channels.</p> <p>PAGE UP/DOWN Move from one full set of screen information to the next one.</p>	
<p>NUMBER button</p> <p>— (DASH) Used to enter a program number for multiple program channels such as 2-1, 2-2, etc.</p> <p>FLASHBK Tune to the last channel viewed.</p>	
<p>VCR/DVD, USB, SIMPLINK Control buttons</p> <ul style="list-style-type: none"> • Control video cassette recorders or DVD players. • Control USB menu (PHOTO LIST and MUSIC LIST.) • Control the SIMPLINK compatible devices. 	

THUMBSTICK (Up/Down/Left Right/ENTER) Navigate the on-screen menus and adjust the system settings to your preference.

RETURN Allows the user to move return one step in an interactive application or other user interaction function.

SIMPLINK See a list of AV devices connected to TV.
When you toggle this button, the SIMPLINK menu appears at the screen. ► p.62-63

AV MODE It helps you select and set images and sounds. ► p.61

Installing Batteries

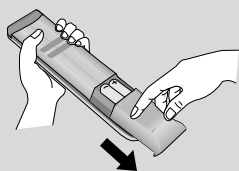

- Open the battery compartment cover on the back side and install the batteries matching correct polarity (+with +,-with -).
- Install two 1.5V AAA batteries. Don't mix old or used batteries with new ones.
- Close cover.

WATCHING TV / CHANNEL CONTROL

TURNING ON TV

- 1 First, connect power cord correctly.
At this moment, the TV switches to standby mode.
 - In standby mode to turn TV on, press the $\phi/|$, **INPUT**, **CH (+ or -)** button on the TV or press the **POWER**, **INPUT**, **TV**, **CH (+ or -)**, **Number (0~9)** button on the remote control.
- 2 Select the viewing source by using the **INPUT** button on the remote control.
 - This TV is programmed to remember which power state it was last set to, even if the power cord is out.
- 3 When finished using the TV, press the **POWER** button on the remote control. The TV reverts to standby mode.

! NOTE

- ▶ If you intend to be away on vacation, disconnect the power plug from the wall power outlet.

CHANNEL SELECTION

- 1 Press the **CH (+ or -)** or **NUMBER** buttons to select a channel number.

VOLUME ADJUSTMENT

Adjust the volume to suit your personal preference.





- 1 Press the **VOL (+ or -)** button to adjust the volume.
- 2 If you want to switch the sound off, press the **MUTE** button.
- 3 You can cancel the Mute function by pressing the **MUTE** or **VOL (+ or -)** button.

QUICK MENU

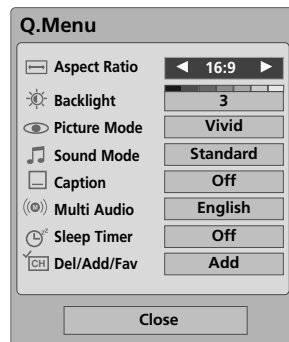
Your TV's OSD (On Screen Display) may differ slightly from what is shown in this manual. Q.Menu (Quick Menu) is a menu of features which users might use frequently.

- **Aspect Ratio:** Selects your desired picture format.
- **Backlight:** Adjust the brightness of LCD panel to control the brightness of the screen.
- **Picture Mode:** Selects the factory preset picture depend on the viewing environment.
- **Sound Mode:** Selects the factory preset sound for type of program.
- **Caption:** Select on or off.
- **Multi Audio:** Changes the audio language (Digital signal).
SAP: Selects MTS sound (Analog signal).
- **Sleep Timer:** Select the amount of time before your TV turns off automatically.
- **Del/Add/Fav:** Select channel you want to add/delete or add the channel to the Favorite List.



-   Display each menu.
-  Make appropriate adjustments.
-  Return to TV viewing

WATCHING TV / CHANNEL CONTROL

INITIAL SETTING

This Function guides the user to easily set the essential items for viewing the TV for the first time when purchasing the TV. It will be displayed on the screen when turning the TV on for the first time. It can also be activated from the user menus.

- **In-Store Mode:** Picture mode is set to "Vivid". Customers can adjust the "Picture Mode" manually while inspecting the TV, but the TV will automatically return to **Vivid** preset after 5 minutes.
- **Home Mode:** Picture mode is set to "Vivid" and user can change it to whatever they wish.



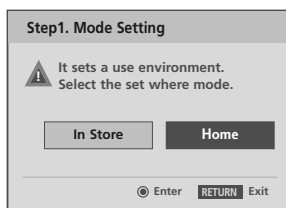

Step1. Mode setting

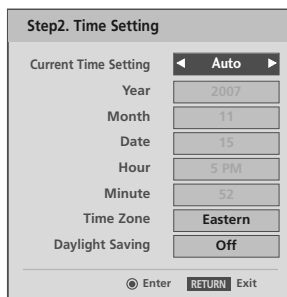

- 1  Select **Home Mode**.
- 2 

Step2. Time setting



- 1  Select **Auto** or **Manual**.
- 2   Select desired time option.
- 3 

Step3. Option setting

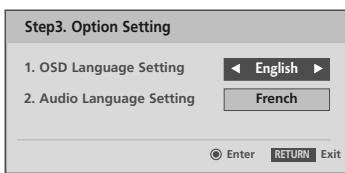

Select **OSD Language Setting** or **Audio Language Setting**.



Select your desired language.



Step4. Auto Tuning

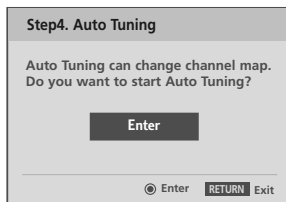

Start **Auto Tuning**.

! NOTE

- You can also adjust **Initial Setting** in the **OPTION** menu.





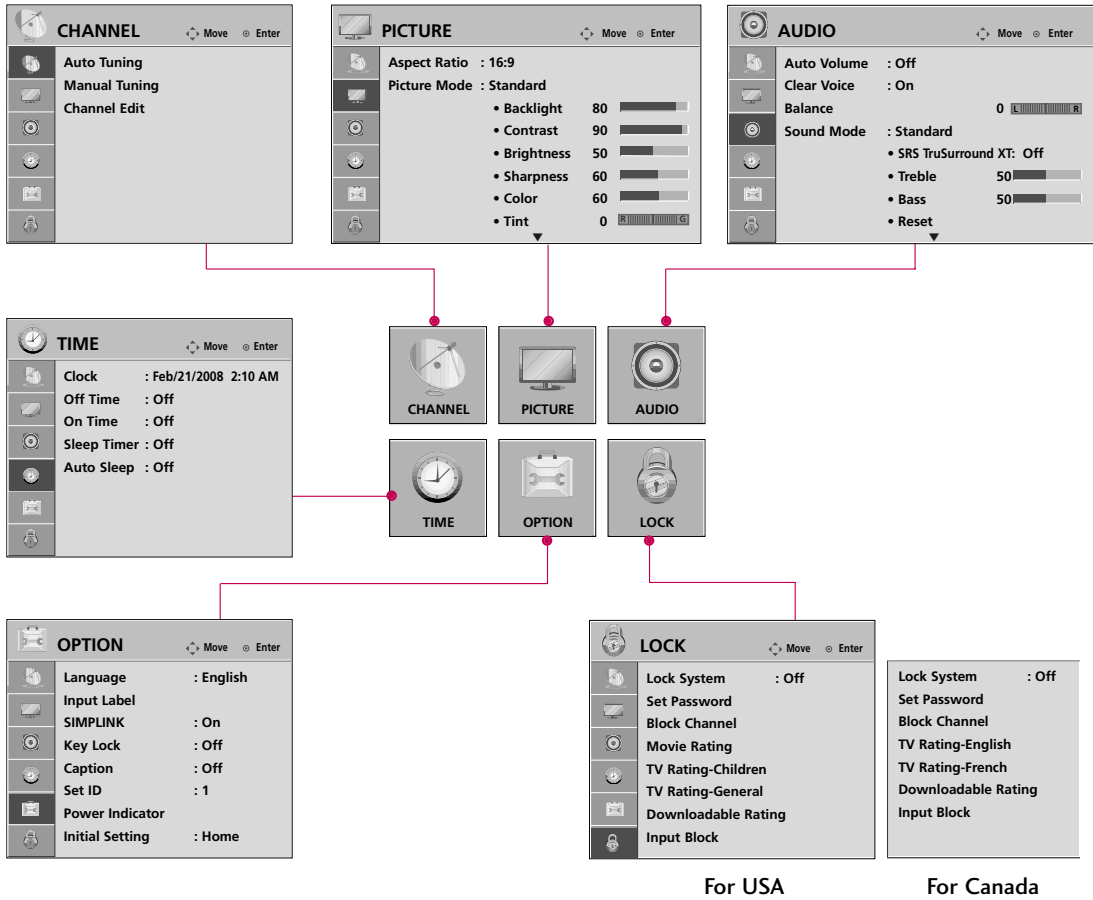

WATCHING TV / CHANNEL CONTROL

ON-SCREEN MENUS SELECTION

Your TV's OSD (On Screen Display) may differ slightly from that shown in this manual.

WATCHING TV / CHANNEL CONTROL



- 1   Display each menu.
- 2   Select a menu item.
- 3  Enter to the pop up menu.
- 4  Return to TV viewing.







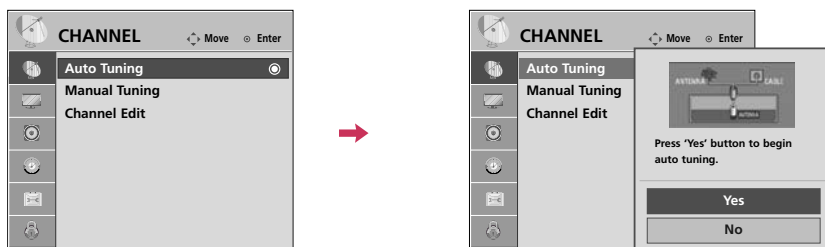

CHANNEL SETUP

Auto Scan (Auto Tuning)

Automatically finds all channels available through antenna or cable inputs, and stores them in memory on the channel list.

Run Auto Tuning again after any Antenna/Cable connection changes.



- 1   Select **CHANNEL**.
- 2   Select **Auto Tuning**.
- 3   Select **Yes**.
- 4  Run **Auto tuning**.
- 5  Return to the previous menu.
-  Return to TV viewing.

- A password is required to gain access to Auto Tuning menu if the Lock System is turned on.







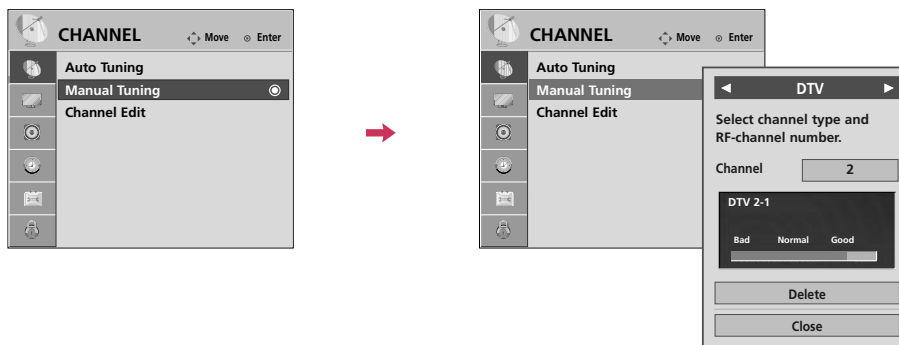



WATCHING TV / CHANNEL CONTROL

Add/Delete Channel (Manual Tuning)

If selecting DTV or CADTV input signal, you can view the on-screen signal strength monitor to see the quality of the signal being received.



WATCHING TV / CHANNEL CONTROL

-   Select **CHANNEL**.
-   Select **Manual Tuning**.
-   Select **DTV, TV, CADTV, or CATV**.
-   Select channel you want to add or delete.
-   Select **Add** or **Delete**.
-  Return to the previous menu.
-  Return to TV viewing.







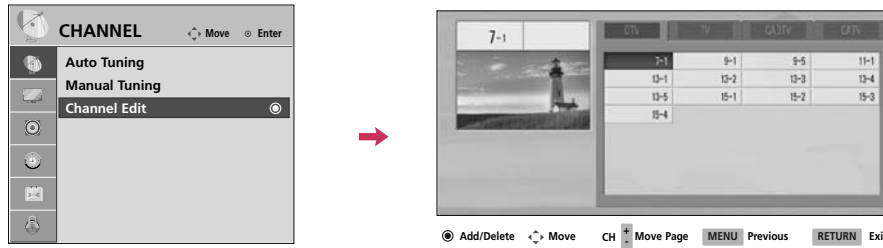

■ A password is required to gain access to Manual Tuning menu if the Lock System is turned on.

Channel Editing

A custom list can be created by toggling each channel on or off with **ENTER** button. The channels in the Custom List are displayed in black and the channels deleted from the Custom List are displayed in gray.

Once a channel is highlighted you can add or delete the channel by referring to the small window at the top-right corner of the screen.



- 1   Select **CHANNEL**.
- 2   Select **Channel Edit**.
- 3   Select a channel.
- 4  Select channel you want to add or delete.
- 5  Return to the previous menu.
-  Return to TV viewing.

WATCHING TV / CHANNEL CONTROL

INPUT LIST

19/22LG30

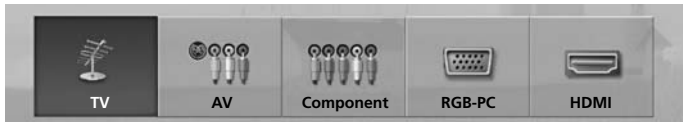

26LG30



WATCHING TV / CHANNEL CONTROL

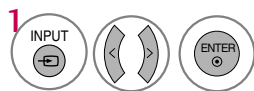

Select the desired input source.

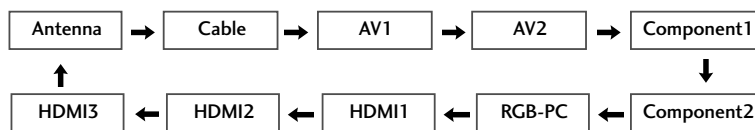

ie)

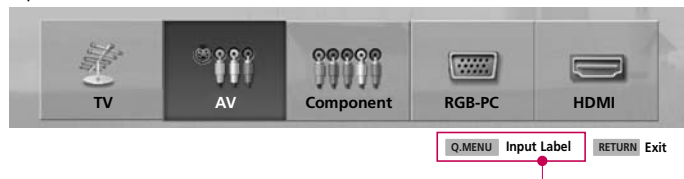

Select a desired input source (except **Antenna**, **Cable** or **TV**). Then, you can select your desired Input Label with using Q.MENU button. ► **p.49**







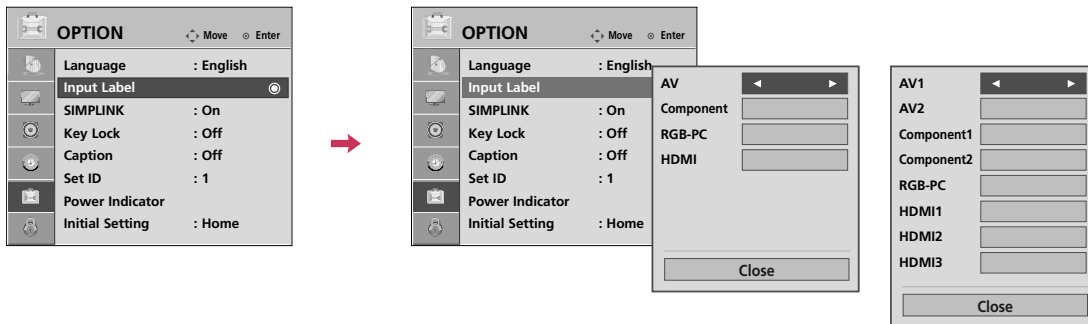

- **Antenna:** Select it to watch over-the-air broadcasts.
- **Cable:** Select it to watch cable and digital cable.
- **TV:** Select it to watch over-the-air, cable and digital cable broadcasts.
- **AV:** Select them to watch a VCR or other external equipment.
- **Component:** Select them to watch DVD or a Digital set-top box.
- **RGB-PC:** Select it to view PC input.
- **HDMI:** Select them to watch high definition devices.

INPUT LABEL







You can set a label for each input source when it's not in use.



With using OPTION menu

- 1   Select **OPTION**.
- 2   Select **Input Label**.
- 3   Select the source.
- 4  Select the label.
- 5  Return to the previous menu.
-  Return to TV viewing

With using INPUT button

- 1   Select the source.
- 2   Select the label.
- 3  Return to the previous menu.
-  Return to TV viewing

WATCHING TV / CHANNEL CONTROL

AV MODE

You can select the optimal images and sounds.

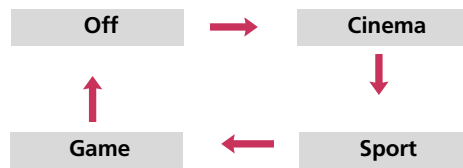

WATCHING TV / CHANNEL CONTROL



1 Press the **AV MODE** button repeatedly to select the desired source.



- If you select “**Cinema**” in AV mode, **Cinema** will be selected both for “**PICTURE** menu - Picture Mode” and “**AUDIO** menu - Sound Mode” respectively.
- If you select “**Off**” in AV mode, the “**Picture Mode**” and “**Sound Mode**” return to previous selected value.









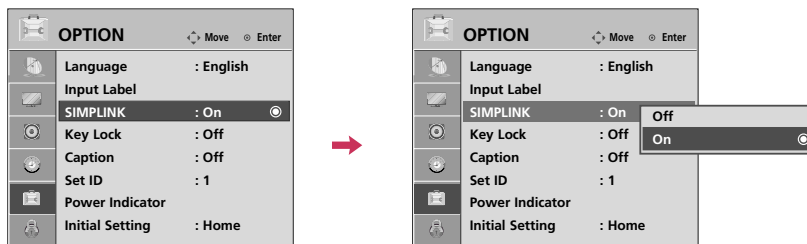

This function operates only with devices with the SIMPLINK logo.

The TV might not function properly when using it with other products with HDMI-CEC function.

This allows you to control and play other AV devices connected with HDMI cable without additional cables and settings.

To start using SIMPLINK, turn it on in the user menus.



- 1   Select **OPTION**.
- 2   Select **SIMPLINK**.
- 3   Select **On** or **Off**.
- 4  Return to the previous menu.
-  Return to TV viewing.

! NOTE

- ▶ Connect the HDMI/DVI IN or HDMI IN terminal of the TV to the rear terminal (HDMI terminal) of the SIMPLINK device with the HDMI cable.
- ▶ When you switch the Input source with the INPUT button on the remote control, the SIMPLINK device will stop.
- ▶ When you select a device with home theater functionality, the sound output automatically switches to the home theater speakers.
- ▶ If a connected SIMPLINK home theater system doesn't play the audio from the TV, connect the DIGITAL AUDIO OUT terminal on the back of the TV to the DIGITAL AUDIO IN terminal on the back of the SIMPLINK device with an OPTICAL cable.

WATCHING TV / CHANNEL CONTROL

SIMPLINK Functions

- **Direct Play:** After connecting AV devices to the TV, you can directly control the devices and play media without additional settings.
- **Select AV device:** Enables you to select one of the AV devices connected to TV.
- **Disc playback:** Control connected AV devices by pressing the \wedge \vee \lt \gt , ENTER, \blacktriangleright , \blacksquare , \blacksquare , \ll and \gg buttons.
- **Power off all devices:** When you power off the TV, all connected devices are turned off.
- **Switch audio-out:** Offers an easy way to switch audio-out.
- **Sync Power on:** When you play the connected AV device, TV will automatically turn on.

(A device, which is connected to the TV through a HDMI cable but does not support SIMPLINK, does not provide this function)

Note: To operate SIMPLINK, an HDMI cable over Version 1.2 with *CEC function should be used. (*CEC: Consumer Electronics Control).



SIMPLINK Menu

① **TV viewing:** Switch to the previous TV channel regardless of the current mode.

② **DISC playback:** Select and play discs. When multiple discs are available, the titles of discs are conveniently displayed at the bottom of the screen.

③ **VCR playback:** Control the connected VCR.

④ **HDD Recordings playback:** Control recordings stored in HDD.

⑤ **Audio Out to Home Theater speaker/Audio Out to TV:** Select Home Theater speaker or TV speaker for Audio Out.



▶ When no device is connected (displayed in gray)

▶ Selected Device

▶ When a device is connected (displayed in bright color)

DVD OPERATION

DVD operation

Notes on Discs

Symbol Used in this Manual

DVD-V DVD and finalized DVD±R/RW

VCD Video CDs

CD Audio CDs

MP3 MP3 Discs

WMA WMA Discs

JPEG JPEG Discs

DivX DivX Discs

⊘ may appear on your TV display during operation and indicates that the function explained in this owner's manual is not available on that specific DVD video disc.

On handling discs

- Do not touch the playback side of the disc.

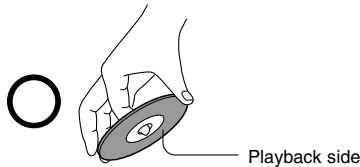

- Do not attach paper or tape to discs.



On cleaning discs

- Fingerprints and dust on the disc cause picture and sound deterioration. Wipe the disc from the center outwards with a soft cloth. Always keep the disc clean.

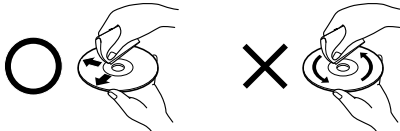

- Do not use any type of solvent such as thinner, benzene, commercially available cleaners or antistatic spray for vinyl LPs. It may damage the disc.

On storing discs

- Do not store discs in a place subject to direct sunlight or near heat sources.
- Do not store discs in places subject to moisture and dust such as a bathroom or near a humidifier.
- Store discs vertically in a case. Stacking or placing objects on discs outside of their case may cause warping.



Structure of disc contents

Normally, DVD video discs are divided into titles, and the titles are sub-divided into chapters. Video CDs and Audio CDs are divided into tracks.

DVD video disc

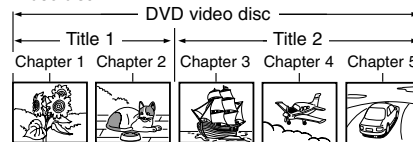

Video CD/Audio CD

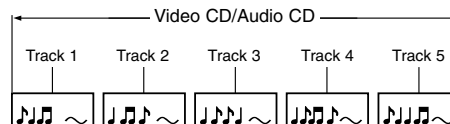

Each title, chapter or track is assigned a number, which is called "title number", "chapter number" or "track number" respectively. There may be discs that do not have these numbers.

- Title:** When two or more movies are recorded on a disc, the disc is divided into two or more parts. Each part is called a "TITLE".
- Chapter:** The titles can be subdivided into many sections. Each section is called a "CHAPTER".
- Track:** An audio CD can contain several items. These are assigned to the tracks.

Note

- If an MP3 or JPEG file CD is created using an incorrect method, the player may not be able to recognize it. If this happens, try reburning another CD after setting up the disc writing parameters correctly on your PC.

Types of Playable Discs

- DVD (8 cm / 12 cm disc)
- Video CD (VCD) (8 cm / 12 cm disc)
- Audio CD (8 cm / 12 cm disc)

In addition, this unit plays DivX file, DVD -R, DVD +R, DVD -RW, DVD +RW, Kodak Picture CDs, SVCD, and CD-R / CD-RW that contains audio titles, MP3, WMA, and/or JPEG files.

Note

- Depending on the conditions of the recording equipment or the CD-R/RW (or DVD -R, DVD +R, DVD -RW, DVD +RW) disc itself, some CD-R/RW (or DVD -R, DVD +R, DVD -RW, DVD +RW) discs cannot be played on the unit.

Regional code of the DVD player and DVDs



This DVD player is designed and manufactured for playback of region "2" encoded DVD software. The region code on the labels of some DVD discs indicates which type of player can play those discs. This unit can play only DVD discs labeled "2" or "ALL". If you try to play any other discs, the message "Check Regional Code" will appear on the TV screen. Some DVD discs may not have a region code label even though their playback is prohibited by area limits.

Manufactured under license from Dolby Laboratories. "Dolby" and the double-D symbol are trademarks of Dolby Laboratories. "DTS" and "DTS Digital Surround" are trademarks of Digital Theater System, Inc.

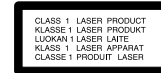

CAUTION:

This Digital Video Disc Player employs a Laser System. To ensure proper use of this product, please read this owner's manual carefully and retain for future reference should the unit require maintenance, contact an authorized service location (see service procedure). Use of controls, adjustments, or the performance of procedures other than those specified herein may result in hazardous radiation exposure. To prevent direct exposure to laser beam, do not try to open the enclosure. Visible laser radiation when open. DO NOT STARE INTO BEAM.

CAUTION: The apparatus should not be exposed to water (dripping or splashing) and no objects filled with liquids, such as vases, should be placed on the apparatus.

Screen Saver

The screen saver appears when you leave the DVD player in Stop mode for about five minutes. If the Screen Saver is displayed for five minutes, the DVD Player automatically turns itself off.

Last Scene Memory

This player memorizes last scene from the last disc that is viewed. The last scene remains in memory even if you remove the disc from the player or turn off the set. If you load a disc that has the scene memorized, the scene is automatically recalled.

Note:

This player does not memorize the scene of a disc if you switch off the player before commencing to play the disc.

Note

- Except DVD mode the **PLAY** button must be pressed after inserting the disk to switch to **DVD** mode.

DVD OPERATION

DVD Menu options - LANGUAGE

By using the DVD menu, you can make various adjustments to items such as picture and sound. You can also set a language for the subtitles and the DVD menu, among other things.

Menu Language



- Select your preferred language for the DVD menus and on screen displays messages.

- 1 Press the **MENU** button twice and then use the **▲ / ▼** button to select **Language**.
- 2 Press the **▶** button and then use **▲ / ▼** button to select **Menu Language**.
- 3 Press the **▶** button and then use **▲ / ▼** button to select your desired language.
- 4 Press the **OK** button.
The menus and on screen displays will appear in the selected language.
- 5 Press the **EXIT** button to exit the menu.

Disc Audio / Disc Subtitle / Disc Menu

DVD-V



- Select the language you prefer for the **Disc Audio / Disc Subtitle / Disc Menu**.
- **Original:** Refers to the original language in which the disc was recorded.
- **Other:** To select another language, press number buttons then **OK** button to enter the corresponding 4-digit number according to the language code list in the **REFERENCE** chapter. (Refer to P.62) If you enter the wrong language code, press **CLEAR** button.

- 1 Press the **MENU** button twice and then use the **▲ / ▼** button to select **Language**.
- 2 Press the **▶** button and then use **▲ / ▼** button to select **Disc Audio / Disc Subtitle / Disc Menu**.
- 3 Press the **▶** button and then use **▲ / ▼** button to select your desired language.
- 4 Press the **OK** button.
- 5 Press the **EXIT** button to exit the menu.

DVD Menu options - DISPLAY

Progressive Scan

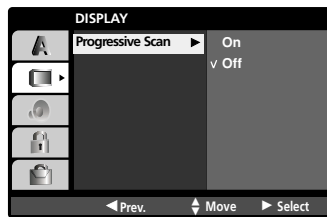

- *Progressive Scan Video provides the highest quality pictures with less flickering. Set **Progressive Scan** to **On**.*

- 1 Press the **MENU** button twice and then use the ▲ / ▼ button to select **DISPLAY**.
- 2 Press the ► button to select **Progressive Scan**.
- 3 Press the ► button and then use ▲ / ▼ button to select **On** or **Off**.
- 4 Press the **OK** button.
- 5 Press the **EXIT** button to exit the menu.

DVD OPERATION

DVD Menu options - AUDIO

Each DVD disc has a variety of audio output options.
Set the player's AUDIO options according to the type of audio system you use.

Dolby Digital / DTS / MPEG DVD-V DivX

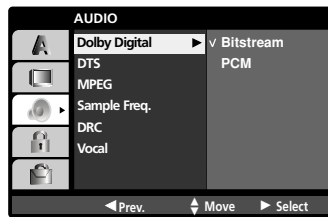

• **Bitstream:** Select **Bitstream** if you connect the DVD Player's DIGITAL OUT jack to an amplifier or other equipment with a Dolby Digital, DTS or MPEG decoder.

• **PCM (Pulse Code Modulation):** Select when connected to a two-channel digital stereo amplifier. DVDs encoded in Dolby Digital, DTS or MPEG will be automatically down-mixed to two-channel PCM audio.

- 1 Press the **MENU** button twice and then use the **▲ / ▼** button to select **AUDIO**.
- 2 Press the **▶** button and then use **▲ / ▼** button to select **Dolby Digital / DTS / MPEG**.
- 3 Press the **▶** button and then use **▲ / ▼** button to select **Bitstream** or **PCM**.
- 4 Press the **OK** button.
- 5 Press the **EXIT** button to exit the menu.

Sample Freq. (Frequency) DVD-V

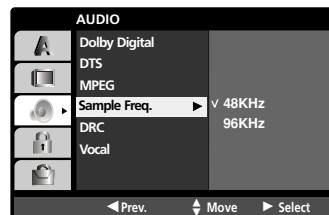

- If your receiver or amplifier is **NOT** capable of handling 96 kHz signals, select 48 kHz. When this choice is made, this unit automatically converts any 96 kHz signals to 48 kHz so your system can decode them.

If your receiver or amplifier is capable of handling 96 kHz signals, select 96 kHz. When this choice is made, this unit passes each type of signal through without any further processing.

Check the documentation for your amplifier to verify its capabilities.

- 1 Press the **MENU** button twice and then use the **▲ / ▼** button to select **AUDIO**.
- 2 Press the **▶** button and then use **▲ / ▼** button to select **Sample Freq.**
- 3 Press the **▶** button and then use **▲ / ▼** button to select **48KHz** or **96KHz**.
- 4 Press the **OK** button.
- 5 Press the **EXIT** button to exit the menu.

DRC (Dynamic Range Control)

DVD-V DivX



- With the DVD format, you can hear a program's soundtrack in the most accurate and realistic presentation possible, thanks to digital audio technology. However, you may wish to compress the dynamic range of the audio output (the difference between the loudest sounds and the quietest ones). This allows you to listen to a movie at a lower volume without losing clarity of sound. Set **DRC** to **On** for this effect.

- 1 Press the **MENU** button twice and then use the **▲** / **▼** button to select **AUDIO**.
- 2 Press the **▶** button and then use **▲** / **▼** button to select **DRC**.
- 3 Press the **▶** button and then use **▲** / **▼** button to select **On** or **Off**.
- 4 Press the **OK** button.
- 5 Press the **EXIT** button to exit the menu.

Vocal

DVD-V



- Set to **On** only when a multi-channel karaoke DVD is playing. The karaoke channels on the disc mix into normal stereo sound.
- **Vocal** setting works when the **Dolby Digital** mode is set to "**PCM**" in the DVD menu.

- 1 Press the **MENU** button twice and then use the **▲** / **▼** button to select **AUDIO**.
- 2 Press the **▶** button and then use **▲** / **▼** button to select **Vocal**.
- 3 Press the **▶** button and then use **▲** / **▼** button to select **On** or **Off**.
- 4 Press the **OK** button.
- 5 Press the **EXIT** button to exit the menu.

DVD OPERATION

DVD Menu options - LOCK

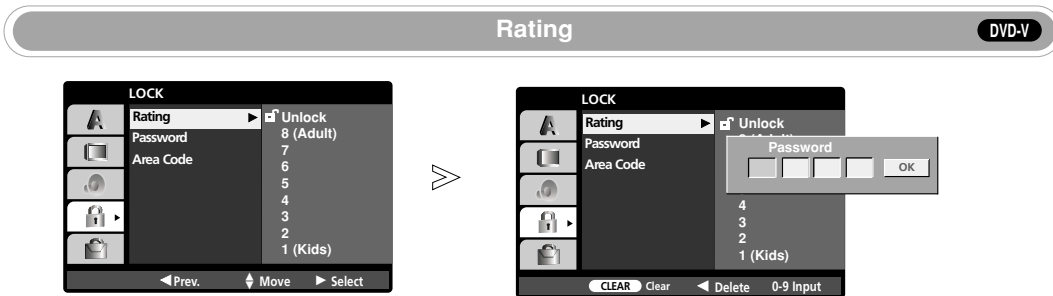

DVD OPERATION

- Some movies contain scenes that may not be suitable for children to view. Many of these discs contain parental control information that applies to the complete disc or to certain scenes on the disc. Movies and scenes are rated from 1 to 8, depending on the country. Some discs offer more suitable scenes as an alternative.

The parental control feature allows you to block access to scenes below the rating you input, thereby preventing your children from being able to view material you believe is unsuitable.

- 1 Press the **MENU** button twice and then use the **▲ / ▼** button to select **LOCK**.
- 2 Press the **▶** button and then use **▲ / ▼** button to select **Rating**.
- 3 Press the **▶** button.
To access the **Rating**, you must input the 4-digit password you created. If you have not yet entered a password you are prompted to do so. Input a 4-digit password and press **OK** button. Enter it again and press **OK** button to verify. If you make a mistake before pressing **OK** button, press **CLEAR** button.
- 4 Select a rating from 1 to 8 using the **▲ / ▼** button.
Rating 1-8: Rating 1 has the most restrictions and rating 8 is the least restrictive.
Unlock : If you select unlock, parental control is not active and the disc plays in full.
- 5 Press the **OK** button.
- 6 Press the **EXIT** button to exit the menu.

Note

- a. If you set a rating for the player, all disc scenes with the same rating or lower are played. Higher rated scenes are not played unless an alternate scene is available on the disc. The alternative must have the same rating or a lower one. If no suitable alternative is found, playback stops. You must enter the 4-digit password or change the rating level in order to play the disc.

Password (Security Code)

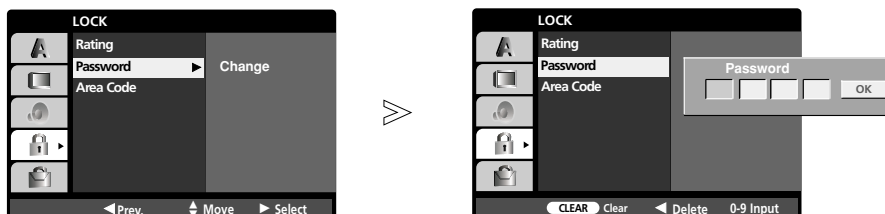

- You can enter or change password.

1 Press the **MENU** button twice and then use the **▲ / ▼** button to select **LOCK**.

2 Press the **▶** button and then use **▲ / ▼** button to select **Password**.

3 Press the **▶** and **OK** button.

In case of "New"

Input a 4-digit password and press **OK** button. Enter it again and press **OK** button to verify. If you make a mistake before pressing **OK** button, press **CLEAR** button.

In case of "Change"

1. Input the 4-digit password you created.

2. Input the new 4-digit password and press **OK** button. Enter it again and press **OK** button to verify. If you make a mistake before pressing **OK** button, press **CLEAR** button.

4 Press the **EXIT** button to exit the menu.

If you forget your Password

If you forget your password you can clear it using the following steps:

1. Press the **MENU** button twice to display the DVD menu.

2. Input the 6-digit number "**210499**" and the password is cleared.

3. Enter a new password as described above.

Area Code

DVD-V

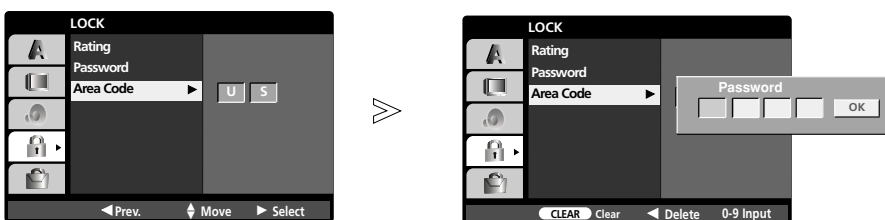

- Enter the code of the country/area whose standards were used to rate the DVD video disc, based on the list in the "**REFERENCE**" chapter. (Refer to P.62)

1 Press the **MENU** button twice and then use the **▲ / ▼** button to select **LOCK**.

2 Press the **▶** button and then use **▲ / ▼** button to select **Area Code**.

3 Press the **▶** button.

To access the **Area Code**, you must input the 4-digit password you created. If you have not yet entered a password you are prompted to do so.

Input a 4-digit password and press **OK** button. Enter it again and press **OK** button to verify. If you make a mistake before pressing **OK** button, press **CLEAR** button.

4 Select the first character using **▲ / ▼** button and press **OK** button.

5 Select the second character using **▲ / ▼** button and press **OK** button to confirm your country code selection.

6 Press the **EXIT** button to exit the menu.

DVD OPERATION

DVD Menu options - OTHERS

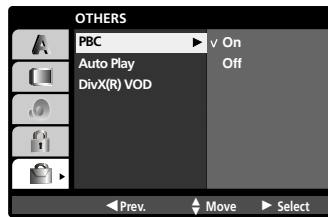

- Set Playback Control (PBC) to **On** or **Off**.
- On:** Video CDs with **PBC** are played according to the **PBC**.
- Off:** Video CDs with **PBC** are played the same way as Audio CDs.

- 1 Press the **MENU** button twice and then use the **▲ / ▼** button to select **OTHERS**.
- 2 Press the **▶** button and then use **▲ / ▼** button to select **PBC**.
- 3 Press the **▶** button and then use **▲ / ▼** button to select **On** or **Off**.
- 4 Press the **OK** button.
- 5 Press the **EXIT** button to exit the menu.

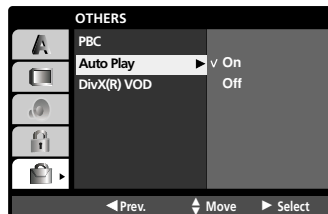

- You can set up the DVD Player so a DVD disc automatically starts playing whenever the DVD is inserted. If **Auto Play** mode is set to **On**, this DVD player will search for title that has the longest playback time and then play back the title automatically.

- 1 Press the **MENU** button twice and then use the **▲ / ▼** button to select **OTHERS**.
- 2 Press the **▶** button and then use **▲ / ▼** button to select **Auto Play**.
- 3 Press the **▶** button and then use **▲ / ▼** button to select **On** or **Off**.
- 4 Press the **OK** button.
- 5 Press the **EXIT** button to exit the menu.



Note

- a. The Auto Play function may not work for some DVDs.
- b. When you load and play back again the same disc in the tray, Playback starts from the location where you stopped playback because **Last scene memory** function works prior to **Auto Play** function.

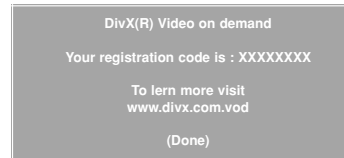
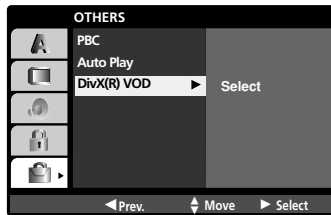

- You can show the DivX DRM (Digital Right Management) Registration code for your unit only. The Registration code is used for VOD (Video-On-Demand) service agent. You can purchase or rental an encrypt movie file.

- 1 Press the **MENU** button twice and then use the ▲ / ▼ button to select **OTHERS**.
- 2 Press the ► button and then use ▲ / ▼ button to select **DivX(R) VOD**.
- 3 Press the ► and **OK** button.
- 4 Press the **EXIT** button to exit the menu.

Note

- a. If you rent the DivX VOD file, it has several options of viewing limits as show below.

- Display the number which you can watch the file.

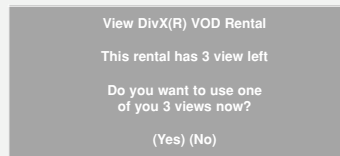

- The rental has been expired.

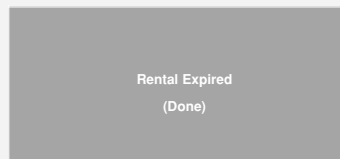

- Display the authorization error.

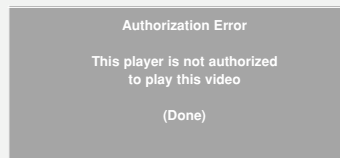

DVD OPERATION

Playing a DVD or Video CD

Basic Playback

DVD-V VCD DivX

- 1 Press the **POWER** button to turn the unit on.
- 2 Press **OPEN/CLOSE** button to open the disc tray and load your chosen disc in the tray, with the playback side down.
- 3 Press **OPEN/CLOSE** button to close the tray. Playback starts automatically. If playback does not start, press **▶ PLAY** button.

Stop Playback

DVD-V VCD DivX

- 1 Press the **■ STOP** button to stop playback. At this time the DVD video player stops playback temporarily and maintains the current playback position.
If you **▶ PLAY** button is pressed, playback will resume from the location where you stopped playback.
- 2 Press the **■ STOP** button again to stop playback fully.
At this time if you press **▶ PLAY** button, the disc playback starts from the beginning.

Pause Playback (Still mode)

DVD-V VCD DivX

- 1 Press **⏸ PAUSE/STEP** button during playback.
- 2 Press the **▶ PLAY** button again to return to normal playback.

Still Picture and Frame-by-Frame Playback

DVD-V VCD DivX

- 1 Press **⏸ PAUSE/STEP** button on the remote control during playback. Advance the picture frame-by-frame by pressing **⏸ PAUSE/STEP** button repeatedly.
- 2 To exit still motion mode, press **▶ PLAY** button.

Fast Forward/Backward

DVD-V VCD DivX

- 1 Press **⏮ SCAN** or **⏭ SCAN** button during playback.
- 2 Press **⏮ SCAN** or **⏭ SCAN** button repeatedly to select the required speed.
 - **DVD, DivX disc:** X2, X4, X16 or X100
 - **Video CD:** X2, X4 or X8
- 3 Press the **▶ PLAY** button again to return to normal playback.

Slow Motion

DVD-V VCD DivX

- 1 Press **II PAUSE/STEP** button on the remote control during playback. The DVD player will now go into PAUSE mode.
- 2 Use the **◀◀ SCAN** or **▶▶ SCAN** button to select the required speed: **◀◀ 1/16**, **◀◀ 1/8**, **◀◀ 1/4**, or **◀◀ 1/2** (backward), or **▶▶ 1/16**, **▶▶ 1/8**, **▶▶ 1/4**, or **▶▶ 1/2** (forward). With a DivX Disc and Video CD, the Slow speed changes: **▶▶ 1/16**, **▶▶ 1/8**, **▶▶ 1/4** or **▶▶ 1/2** (forward).
- 3 To exit Slow Motion mode, press **▶ PLAY** button.



Note

- a. There is no sound during fast or slow playback for DVDs or Video CDs.
- b. Slow motion playback in reverse is not possible with Video CDs and DivX Discs.

Moving to another CHAPTER/TRACK

DVD-V VCD DivX

- 1 When a title on a disc has more than one chapter or a disc has more than one track, you can move to another chapter/track as follows:
 - Press **◀◀ SKIP** or **▶▶ SKIP** button briefly during playback to select the next chapter/track or to return to the beginning of the current chapter/track.
 - Press **◀◀ SKIP** button twice briefly to step back to the previous chapter/track.
 - To go directly to any chapter during DVD playback, press **DISPLAY** button and press **▲ / ▼** to select the chapter/track icon. Then, input the chapter/track number or use **◀ / ▶**.

Repeat Playback

DVD-V VCD DivX

- You can play a specific title, chapter, or track repeatedly.

- 1 Press the **▶◀ REPEAT** button during playback. Each time you press the **▶◀ REPEAT** button, the repeat mode changes as follows.
 - DVD Video Discs : **↻ Chapter** → **↻ Title** → **↻ Off**
 - Video CDs, DivX discs : **↻ Track** → **↻ All** → **↻ Off**



Note

- a. On a Video CD with PBC, you must set **PBC** to **Off** on the DVD menu to use the repeat function.
- b. If you press **▶▶ SKIP** button once during Repeat Chapter (Track) playback, the repeat playback cancels.

DVD OPERATION

Playing a DVD or Video CD

Disc Menu

DVD-V

- 1 Press the **DISC MENU** button during playback.
- 2 Use the **▲ / ▼ / ◀ / ▶** button or **OK** button to select the desired menu option.

Title Menu

DVD-V

- 1 Press the **TITLE** button during playback.
- 2 Use the **▲ / ▼ / ◀ / ▶** button or **OK** button to select the desired item.



Note

- a. The unit may not be able to select the disc or title menu depending on a sort of DVD disc.

On-Screen Display

- 1** Press **DISPLAY** button during playback.
- 2** Use **▲ / ▼** button to select an item.
- 3** Press **◀ / ▶** button to change the setting. You can also use the number buttons if appropriate (e.g. inputting the title number). For some functions, press **OK** to execute the setting. Some discs may not provide all of the features shown below.

DVD-V	Items	Selection Method
• Title Number	◀ 1 / 3 ▶	• ◀ / ▶, Numbers → OK
• Chapter Number	1 / 12	• ◀ / ▶, Numbers → OK
• Time search	0:20:09	• Numbers → OK
• Audio language and Digital Audio Output mode	1 ENG D DD 3/2.1CH	• ◀ / ▶ or AUDIO
• Subtitle language	1 ENG	• ◀ / ▶ or SUB_T
• Angle	1 / 3	• ◀ / ▶ or ANGLE
• Sound	3D SUR	• ◀ / ▶

VCD	Items	Selection Method
• Track Number (or PBC mode)	◀ 1 / 3 ▶	• ◀ / ▶, Numbers → OK
• Time search	0:20:09	• Numbers → OK
• Audio Channel	Stereo	• ◀ / ▶ or AUDIO
• Sound	3D SUR	• ◀ / ▶

DivX	Items	Selection Method
• Track Number	◀ 1 / 3 ▶	• ◀ / ▶, Numbers → OK
• Time search	0:20:09	• Numbers → OK
• Audio language and Digital Audio Output mode	1 MP3 2 / 0 CH	• ◀ / ▶ or AUDIO
• Subtitle language	1 ENG	• ◀ / ▶ or SUB_T
• Sound	3D SUR	• ◀ / ▶



DVD OPERATION

Playing a DVD or Video CD

A-B Repeat Playback

DVD-V VCD DivX

- **A-B** repeat playback allows you to repeat material between two selected points.

- 1 Press the **A-B** button to select the start point during playback. “A*” is displayed on the TV screen and the starting point of your selected segment is set up.
- 2 Press the **A-B** button again to select the end point. “AB” is displayed on the TV screen and the ending point is set up. Playback starts at the point that you selected. Playback stops at the end point, returns to Point **A** automatically, then starts again.
- 3 Repeatedly press the **A-B** button again to resume normal playback. “**Off**” appears on the screen.

Random Playback

VCD

- 1 Press **RANDOM** button during playback. The unit automatically begins random playback and **RANDOM** appears on the TV screen.
- 2 Press **RANDOM** button again to normal.
 - By pressing **SKIP** button during random playback, the unit selects another title (track) and resumes random playback.



Note

- a. On a Video CD with PBC, You must set **PBC** to **Off** on the DVD menu to use the random function

Camera Angle

DVD-V

- If the scene was recorded from multiple angles, you can easily change the camera angle of the scene you are currently watching.

- 1 Press the **ANGLE** button during playback.
- 2 Repeatedly press the **ANGLE** button to select the desired angle.



Note

- a. You can only change the angle for DVDs that provide multiple angles of scenes.
- b. The angle function will not work on DVD video discs that do not contain scenes recorded at different angles.
- c. The number of angles varies from disc to disc.

Subtitles

DVD-V DivX

- 1 Press **SUB_T** button repeatedly during playback to see the different subtitle languages. If a subtitle language is selected, the selected subtitle language is played whenever you start a new disc playback. (The disc must contain the selected language)



Note

- a. The subtitle file of the DivX file is displayed only smi, srt and sub.
- b. If there is no information or there is a code that can not read in the DivX file, " 1 " etc are displayed.

Marker Search

DVD-V VCD DivX

- You can start playback from up to nine memorized points.

■ To enter a Marker 1 / 9

Press **MARKER** button during playback at the desired point on the disc . The **MARKER** icon appears on the TV screen briefly. Repeat to enter up to nine markers.

■ To Recall or Clear a Marked Scene

1. During disc playback, press **SEARCH** button. The **MARKER SEARCH** menu appears on the screen.
2. Within 10 seconds, press **◀ / ▶** button to select a marker number that you want to recall or clear.
3. Press **OK** button and playback starts from the marked scene. Or, Press **CLEAR** button and the marker number is erased from the list.
4. You can play any marker by inputting its number on the **MARKER SEARCH** menu.

Zoom

DVD-V VCD DivX

- Use zoom to enlarge the video image.

- 1 Press **ZOOM** button during playback or still playback. The square frame appears briefly in the right bottom of the picture.
- 2 Each press of the **ZOOM** button changes the TV screen in the sequence:
100% → 400% → 1600% → Screen fit mode → 100%
 - **Screen fit mode :**
You can change the way the image appears on the screen when you're playing a DVD movie. Press **▲ / ▼** button to select between Normal, Enhanced, and Maximum.
- 3 Use the **▲ / ▼ / ▶ / ◀** button to move through the zoomed picture.
- 4 To resume normal playback, press **CLEAR** button.



Note

- a. Zoom may not work on some DVDs.
- b. Screen fit mode is available for playing the DVD disc, VR disc and movie file.

DVD OPERATION

Playing an Audio CD or MP3/WMA Disc

- The DVD player can play MP3/WMA formatted recordings on CD-ROM, CD-R, or CD-RW discs.

■ Audio CD CD

1. Once you insert an audio CD a menu appears on the TV screen.
2. Press **▲ / ▼** button to select a track then press **▶ PLAY** or **OK** button. Playback starts.

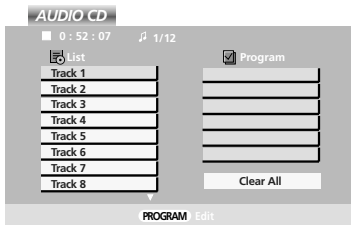

■ MP3 / WMA MP3 WMA

1. Press **▲ / ▼** button to select a folder, and press **OK** button to see the folder contents.
2. Press **▲ / ▼** button to select a track then press **▶ PLAY** or **OK** button. Playback starts.

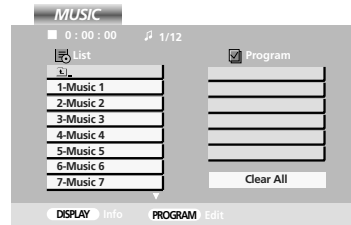

■ ID3 TAG

- When playing a file containing information such as track titles, you can see the information by pressing **DISPLAY** button. [Title, Artist, Album, Year, Comment]
- If there is no information, **NO ID3 TAG** appear on the display.

Pause Playback (Still mode) CD MP3 WMA

- 1 Press **II PAUSE/STEP** button during playback.
- 2 To return to playback, press **▶ PLAY, OK** or press **II PAUSE/STEP** button again.

Fast Forward/Backward CD MP3 WMA

- 1 Press **◀◀ SCAN** or **▶▶ SCAN** button during playback.
- 2 Press **◀◀ SCAN** or **▶▶ SCAN** button repeatedly to select the required speed.
 - X2, X4 or X8
- 3 Press the **▶ PLAY** button again to return to normal playback.

Moving to another Track CD MP3 WMA

- 1 Press **I◀◀ SKIP** or **▶▶I SKIP** button briefly during playback to go to the next track or to return to the beginning of the current track.
- 2 Press **I◀◀ SKIP** button twice briefly to go back to the previous track.
- 3 You can play any track by inputting its number.

Repeat Playback

CD MP3 WMA

- You can play a track/all on a disc.

- 1 Press the **REPEAT** button during playback.
- 2 Each time you press the **REPEAT** button, the repeat mode changes as follows.
 ↻Track → ↻All → (Off)
 - If you press **SKIP** button once during repeat track playback, the repeat playback cancels.

A-B Repeat Playback

CD

- **A-B** repeat playback allows you to repeat material between two selected points.

- 1 Press the **A-B** button to select the start point during playback. “**A**” is displayed on the TV screen and the starting point of your selected segment is set up.
- 2 Press the **A-B** button again to select the end point. “**A B**” is displayed on the TV screen and the ending point is set up. Playback starts at the point that you selected. Playback stops at the end point, returns to Point **A** automatically, then starts again.
- 3 To exit the sequence and return to normal play, press **A-B** button again. The Repeat icon disappears from the menu screen.

Random Playback

CD MP3 WMA

- 1 Press **RANDOM** button during playback. The unit automatically begins random playback and **RANDOM** button appears on the TV screen.
- 2 Press **RANDOM** button again to normal.
 - By pressing **SKIP** button during random playback, the unit selects another track and resumes random playback.

3D Surround

CD

To produce a 3D surround effect that simulates multi-channel audio from two stereo speakers (instead of the five+ speakers normally required for multi-channel audio from a home theater system).

- 1 Press **AUDIO** button during playback. “**3D SUR.**” appears on the menu screen.
- 2 To return to normal playback, press **AUDIO** button repeatedly until “**3D SUR.**” disappears from the menu screen.

■ **MP3 / WMA disc compatibility with this player is limited as follows:**

- Sampling frequency: within 8 - 48 kHz (MP3), within 32 - 48kHz (WMA)
- Bit rate: within 8 - 320kbps (MP3), 32 - 192kbps (WMA)
- The player cannot read an MP3/WMA file that has a file extension other than “.mp3” / “.wma”.
- CD-R physical format should be ISO 9660 or JOLIET file.
- If you record MP3 / WMA files using software that cannot create a file system (eg. Direct-CD) it is impossible to playback MP3 / WMA files. We recommend that you use Easy-CD Creator, which creates an ISO 9660 file system.
- File names should have a maximum of 8 letters and must incorporate an .mp3 or .wma extension.
- They should not contain special letters such as / ? * : “ < > | etc.
- The total number of files on the disc should be less than 650.
- Play a MP3 file that made by user for personal purpose. Use other MP3 Player if an MP3 file is protected by copyright.

DVD OPERATION

Programmed Playback

- The program function enables you to store your favorite tracks from any disc in the player memory. A program can contain 30 tracks.

- 1 Insert a disc.
- 2 Press **PROGRAM** button.
The **E** mark will appear to the right of the word **Program** on the right side of the menu screen.
 - Press **PROGRAM** button again, then the **E** mark will disappear to exit the Program Edit mode.

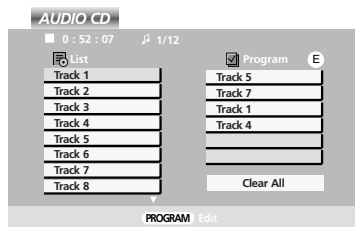

Audio CD Menu

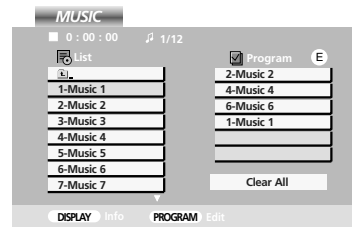

MP3/WMA Menu

- **Video CD:** Press **PROGRAM** button while playback is stopped. The program menu appears. Press **PROGRAM** button again and hold it down for a few seconds to exit the menu.

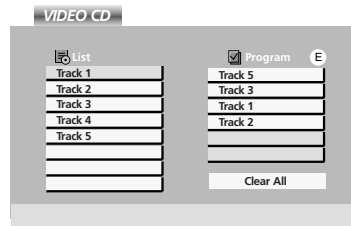

Note

- a. On a Video CD with **PBC**, you must set **PBC** to **Off** on the setup menu to use the programmed playback.

- 3 Select a track on the **List**, then press **OK** button to place the selected track on the **Program** list. Repeat to place additional tracks on the list.
- 4 Press **▶** button.
Select the track you want to start playing on the **Program** list.
- 5 Press **PLAY** or **OK** button to start.
Playback begins in the order in which you programmed the tracks. Playback stops after all of the tracks on the **Program** list have played once.
- 6 To resume normal playback from programmed playback, select a track on the **List** and then press **PLAY** button.

Repeat Programmed Tracks

1. Press the **▶◀ REPEAT** button during playback.
2. Each time you press the **▶◀ REPEAT** button, the repeat mode changes as follows.
↻ **Track** → ↻ **All** → (Off)

Erasing a Track from Program list

1. Use **▲ / ▼ / ▶** button to select the track that you wish to erase from the Program list.
2. Press **CLEAR** button. Repeat to erase additional tracks on the list.

Erasing the Complete Program list

1. Press **▶** button to move to the **Program** list.
2. Use **▲ / ▼** button to select **Clear All**, then press **OK** button.



Note

- a. The programs are also cleared when the disc is removed.

Viewing a JPEG Disc

- Using this DVD Player you can view Kodak PICTURE CDs and discs with JPEG files.

- 1 Insert a disc and close the tray. The **PHOTO** menu appears on the TV screen.

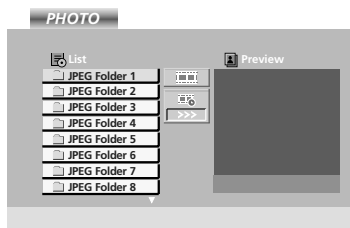

- 2 Press **▲ / ▼** button to select a folder, and press **OK** button. A list of files in the folder appears. If you are in a file list and want to return to the previous Folder list, use the **▲ / ▼** button on the remote to highlight  and press **OK** button.
 - Press **DISC MENU** button to move to the next page
 - On a disc with MP3/WMA and JPEG you can switch MP3/WMA and JPEG. Press **TITLE** button and MUSIC or PHOTO word on top of the menu is highlighted.
- 3 If you want to view a particular file, press **▲ / ▼** button to highlight a file and press **OK** or **▶ PLAY** button. Viewing the file proceeding starts.
 - While viewing a file, you can press **■ STOP** button to move to the previous **PHOTO** menu.
 - While viewing a file, if you press **RETURN** button, information of file is hidden.

■ Slide Show

1. Use **▲ / ▼ / ◀ / ▶** button to highlight the  (Slide Show) then press **OK** button.

■ Slide Speed

There are three slide speed options :

>>> (Fast) → **>>** (Normal) → **>** (Slow)

1. Use **▲ / ▼ / ◀ / ▶** button to highlight the Speed. Then, use **◀ / ▶** button to select the option you want to use then press **OK** button.

■ Still Picture

1. Press **|| PAUSE/STEP** button during slide show. The player will now go into PAUSE mode.
2. To return to the slide show, press **▶ PLAY** or press **|| PAUSE/STEP** button again.

■ Moving to another File

1. Press **I◀◀ SKIP** , **▶▶ SKIP** , **◀ / ▶** button once while viewing a picture to advance to the next or previous file.

■ Zoom

1. Press **ZOOM** button during playback or still playback. The square frame appears briefly in the right bottom of the picture.
2. Each press of the **ZOOM** button changes the TV screen in the sequence:
100% → 400% → 1600% → 100%
3. Use the **▲ / ▼ / ◀ / ▶** buttons to move through the zoomed picture.
4. To resume normal playback, press **CLEAR** button.

■ To rotate picture

1. Press **▲ / ▼** button during showing a picture to rotate the picture clockwise or counter clockwise.

DVD OPERATION

Viewing a JPEG Disc

■ To listen to MP3/WMA music watching picture

You can display files while listening to MP3/WMA music files recorded on the same disc.

1. Insert the disc containing the two types of file in the player.
2. Press **TITLE** button to display **PHOTO** menu.
3. Press **▲** / **▼** button to select a photo file.
4. Use **▶** button to select  icon then press **OK** button.

Playback starts. The playback will continue until **■ STOP** button is pressed.

- To listen to only the desired music watching picture, programmed the desired tracks from the **MUSIC** menu and then proceed as above.

■ JPEG disc compatibility with this player is limited as follows:

- Depending upon the size and number of JPEG files, it could take a long time for the DVD player to read the disc's contents. If you don't see an on-screen display after several minutes, some of the files may be too large — reduce the resolution of the JPEG files to less than 2M pixels as 2760 x 2048 pixels and burn another disc.
- The total number of files and folders on the disc should be less than 650.
- Some discs may be incompatible due to a different recording format or the condition of disc.
- Ensure that all the selected files have the ".jpg" extensions when copying into the CD layout.
- If the files have ".jpe" or ".jpeg" extensions, please rename them as ".jpg" file.
- File names without ".jpg" extension will not be able to be read by this DVD player. Even though the files are shown as JPEG image files in Windows Explorer.

Playing a DVD VR format Disc

- This unit will play DVD-R/RW discs recorded using the DVD-Video format that have been finalized using a DVD-recorder.
- This unit will play DVD-RW discs recorded using the Video Recording (VR) format.

- 1 Insert a disc and close the tray. The DVD-VR menu appears on the TV screen.

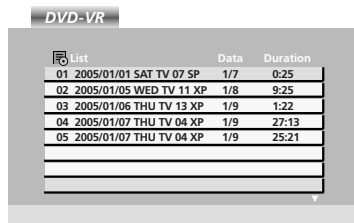

List	Data	Duration
01	2005/01/01 SAT TV 07 SP	1/7 0:25
02	2005/01/05 WED TV 11 XP	1/8 9:25
03	2005/01/06 THU TV 13 XP	1/9 1:22
04	2005/01/07 THU TV 04 XP	1/9 27:13
05	2005/01/07 THU TV 04 XP	1/9 25:21

- 2 Press **▲** / **▼** button to select a track then press **▶ PLAY** or **OK** button and playback starts.



Note

- a. Unfinalized DVD-R/RW discs cannot be played in this player.
- b. Some DVD-VR disc are made with CPRM data by DVD RECORDER. Player does not support these kinds of discs and display the **CHECK DISC**.

• What is 'CPRM'?

CPRM is a copy protection system (with scramble system) only allowing the recording of 'copy once' broadcast programs. CPRM stands for Content Protection for Recordable Media.

This player is CPRM compatible, which means that you can record copy-once broadcast programs, but you cannot then make a copy of those recordings. CPRM recordings can only be made on DVD-RW discs formatted in VR mode, and CPRM recordings can only be played on players that are specifically compatible with CPRM.

Playing a DivX Movie Disc

- Using this DVD Player you can play DivX (Digital Internet Video eXpress) disc.

- 1 Insert a disc and close the tray. The **MOVIE** menu appears on the TV screen.

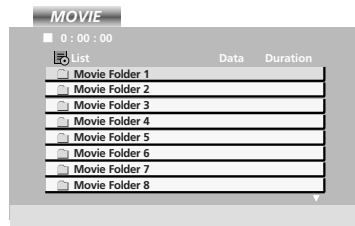

- 2 Press ▲ / ▼ button to select a folder, and press **OK** button. A list of files in the folder appears. If you are in a file list and want to return to the Folder list, use the ▲ / ▼ button on the remote to highlight **⏪** and press **OK** button.
- 3 If you want to view a particular file, press ▲ / ▼ button to highlight a file and press **OK** or **▶ PLAY** button.
- 4 Press **■ STOP** button to exit.

- On a CD with MP3/WMA, JPEG and MOVIE file, you can switch **MUSIC**, **PHOTO** and **MOVIE** menu. Press **TITLE** button and **MUSIC**, **PHOTO** and **MOVIE** word on top of the menu is highlighted.

■ DivX disc compatibility with this player is limited as follows:

- Available resolution size of the DivX file is under 720x576 (W x H) pixel.
- The file name of the DivX subtitle is available by 56 characters.
- If there is impossible code to express in the DivX file, it may be displayed as " _ " mark on the display.
- If the number of the screen frame is over 30 per 1 second, this unit may not operate normally.
- If the video and audio structure of recorded file is not interleaved, either video or audio is outputted.
- If the file is recorded with **GMC**, the unit supports only 1-point of the record level.

What is 'GMC'?

GMC is the acronym for Global Motion Compensation. It is an encoding tool specified in MPEG4 standard. Some MPEG4 encoders, like DivX or Xvid, have this option. There are different levels of GMC encoding, usually called 1-point, 2-point, or 3-point GMC.

- Playable DivX file : ".avi", ".mpg", ".mpeg"
- Playable Codec format
"DIVX3.xx", "DIVX4.xx", "DIVX5.xx", "XVID", "MP43", "3IVX"
- Playable Audio format
"AC3", "DTS", "PCM", "MP3", "WMA"
- Sampling frequency: within 8 - 48 kHz (MP3), within 32 - 48kHz (WMA)
- Bit rate: within 8 - 320kbps (MP3), 32 - 192kbps (WMA)

PICTURE CONTROL

PICTURE SIZE (ASPECT RATIO) CONTROL

This feature lets you choose the way an analog picture with a 4:3 aspect ratio is displayed on your TV.

- RGB-PC input source use 4:3 or 16:9 aspect ratio.

! NOTE

- ▶ If a fixed image is displayed on the screen for a long time, the image could become imprinted on the screen and remain visible.

This phenomenon is common to all manufacturers and is not covered by warranty. Although, after watching video that did not fill the screen, any after-image from the black bars will normally dissipate after a few minutes.

PICTURE CONTROL

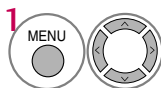
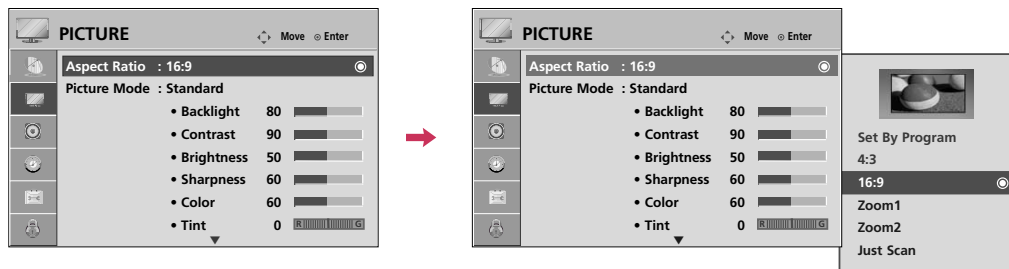

Select **PICTURE**.

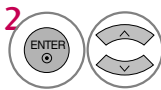

Select **Aspect Ratio**.

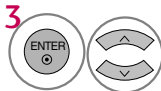

Select the desired picture format.



Return to the previous menu.



Return to TV viewing.

- You can also adjust **Aspect Ratio** in the **Q-Menu**.