

APPENDIX H
: USER'S MANUAL



Digital LCD TV

OWNER'S MANUAL | 32LP1DC



**Please read this manual carefully before operating your set.
Retain it for future reference.
Record model number and serial number of the set.
See the label attached on the back cover and quote
this information to your dealer
when you require service.**

P/NO : 3828TUL298C(0411-REV00)
Printed in Korea

Warning



CAUTION
RISK OF ELECTRIC SHOCK
DO NOT OPEN



WARNING:

TO REDUCE THE RISK OF ELECTRIC SHOCK DO NOT REMOVE COVER (OR BACK). NO USER SERVICEABLE PARTS INSIDE. REFER TO QUALIFIED SERVICE PERSONNEL.



The lightning flash with arrowhead symbol, within an equilateral triangle, is intended to alert the user to the presence of uninsulated "dangerous voltage" within the product's enclosure that may be of sufficient magnitude to constitute a risk of electric shock to persons.



The exclamation point within an equilateral triangle is intended to alert the user to the presence of important operating and maintenance (servicing) instructions in the literature accompanying the appliance.

NOTE TO CABLE/TV INSTALLER:

This reminder is provided to call the CATV system installer's attention to Article 820-40 of the National Electric Code (U.S.A.). The code provides guidelines for proper grounding and, in particular, specifies that the cable ground shall be connected to the grounding system of the building, as close to the point of the cable entry as practical.

REGULATORY INFORMATION

This equipment has been tested and found to comply with the limits for a Class B digital device, pursuant to Part 15 of the FCC Rules. These limits are designed to provide reasonable protection against harmful interference in a residential installation. This equipment generates, uses and can radiate radio frequency energy and, if not installed and used in accordance with the instructions, may cause harmful interference to radio communications. However, there is no guarantee that interference will not occur in a particular installation. If this equipment does cause harmful interference to radio or television reception, which can be determined by turning the equipment off and on, the user is encouraged to try to correct the interference by one or more of the following measures:

- Reorient or relocate the receiving antenna.
- Increase the separation between the equipment and receiver.
- Connect the equipment into an outlet on a circuit different from that to which the receiver is connected.
- Consult the dealer or an experienced radio/TV technician for help.

Any changes or modifications not expressly approved by the party responsible for compliance could void the user's authority to operate the equipment.

CAUTION:

Do not attempt to modify this product in any way without written authorization from LG Electronics Corporation. Unauthorized modification could void the user's authority to operate this product.

U.S.A. only -----

COMPLIANCE:

The responsible party for this product's compliance is:
LG Electronics U.S.A., Inc.
1000 Sylvan Avenue, Englewood Cliffs, NJ 07632
Phone: 1-201-816-2000
<http://www.lgusa.com>

Safety Instructions

WARNING :

To Reduce The Risk Of Fire Or Electric Shock, Do Not Expose This Apparatus To Rain Or Moisture.

Apparatus shall not be exposed to dripping or splashing and no objects filled with liquids, such as vases, shall be placed on the apparatus.

IMPORTANT SAFETY INSTRUCTIONS

1. Read these instructions.

2. Keep these instructions.

3. Heed all warnings.



4. Follow all instructions.

5. Do not use this apparatus near water.



6. Clean only with a dry cloth.



7. Do not block any of the ventilation openings. Install in accordance with the manufacturer's instructions.



8. Do not install near any heat sources such as radiators, heat registers, stoves, or other apparatus (including amplifiers) that produce heat.



9. Do not defeat the safety purpose of the polarized or grounding type plug. A polarized plug has two blades with one wider than the other. A grounding type plug has two blades and a third grounding prong. The wide blade or the third prong is provided for your safety. When the provided plug does not fit into your outlet, consult an electrician for replacement of the obsolete outlet.

10. protect the power cord from being walked on or pinched particularly at plugs, convenience receptacles, and the point where they exit from the apparatus.



11. Only use the attachments / accessories specified by the manufacturer.

Safety Instructions continued

12. Use only with a cart, stand, tripod, bracket, or table specified by the manufacturer, or sold with the apparatus. When a cart is used, use caution when moving the cart / apparatus combination to avoid injury from tip-over.



14. Refer all servicing to qualified service personnel. Servicing is required when the apparatus has been damaged in any way, such as power supply cord or plug is damaged, liquid has been spilled or objects have fallen into the apparatus, the apparatus has been exposed to rain or moisture, does not operate normally, or has been dropped.

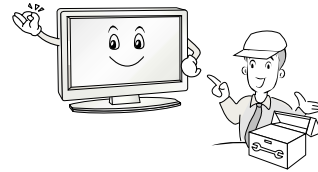

13. Unplug this apparatus during lightning storms or when unused for long periods of time.



Note

- If the TV feels cold to the touch, there may be a small "flicker" when when it is turned on. This is normal, there is nothing wrong with TV.
- Some minute dot defects may be visible on the screen, appearing as tiny red, green, or blue spots. However, they have no adverse effect on the monitor's performance.
- Avoid touching the LCD screen or holding your finger(s) against it for long periods of time. Doing so may produce some temporary distortion effects on the screen.

CAUTION concerning the Power Cord

Most appliances recommend they be placed upon a dedicated circuit; that is, a single outlet circuit which powers only that appliance and has no additional outlets or branch circuits. Check the specification page of this owner's manual to be certain.

Do not overload wall outlets. Overloaded wall outlets, loose or damaged wall outlets, extension cords, frayed power cords, or damaged or cracked wire insulation are dangerous. Any of these conditions could result in electric shock or fire. Periodically examine the cord of your appliance, and if its appearance indicates damage or deterioration, unplug it, discontinue use of the appliance, and have the cord replaced with an exact replacement part by an authorized servicer.

Protect the power cord from physical or mechanical abuse, such as being twisted, kinked, pinched, closed in a door, or walked upon. Pay particular attention to plugs, wall outlets, and the point where the cord exits the appliance.

On Disposal

- a. The fluorescent lamp used in this product contains a small amount of mercury.
- b. Do not dispose of this product with general household waste.
Disposal of this product must be carried out in accordance to the regulations of your local authority.

Introduction

Controls

- This is a simplified representation of front panel.
- Here shown may be somewhat different from your TV.

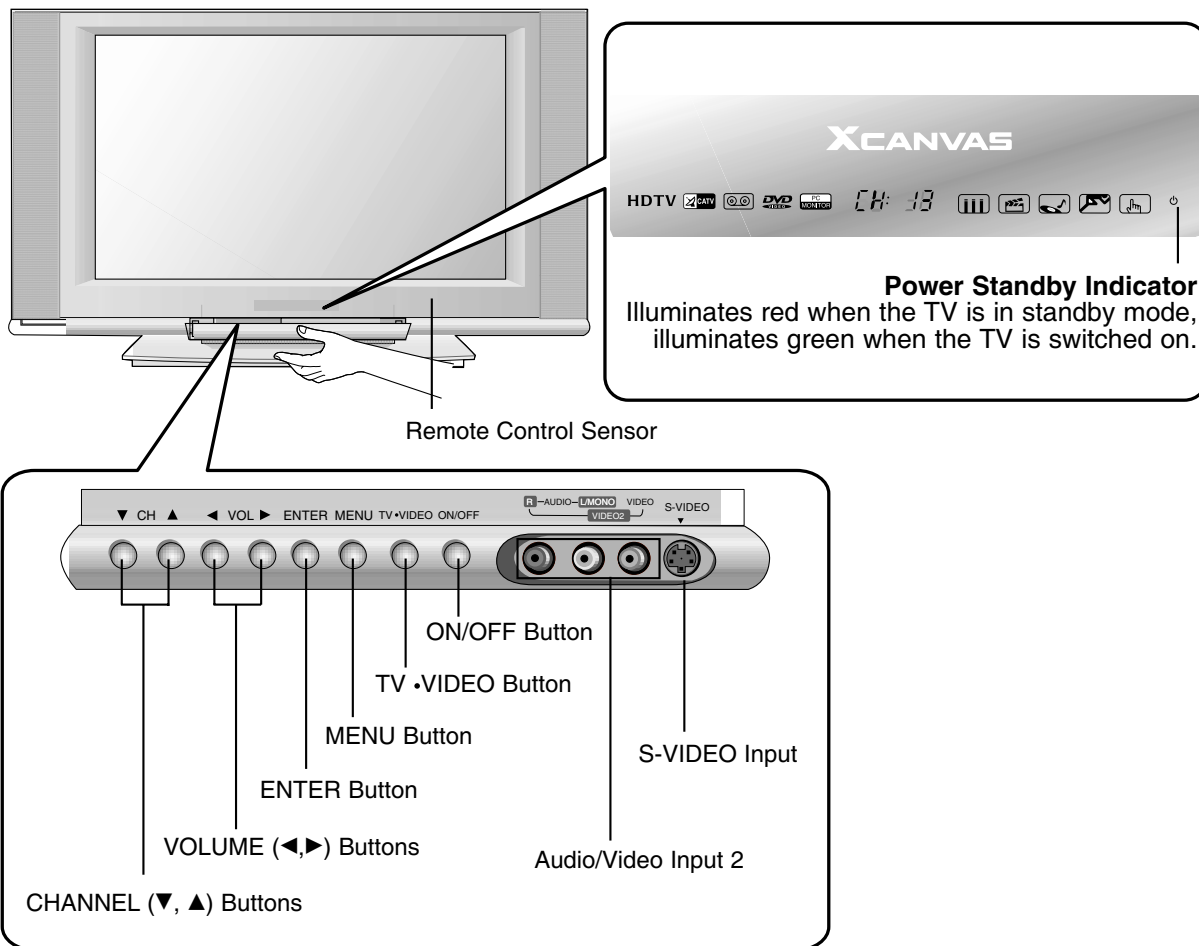

Accessories

Ensure that the following accessories are included with your TV. If any accessory is missing, please contact the dealer from where you purchased the product.

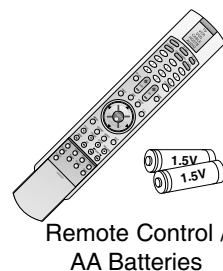
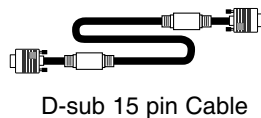
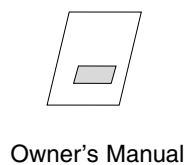

Connection Options

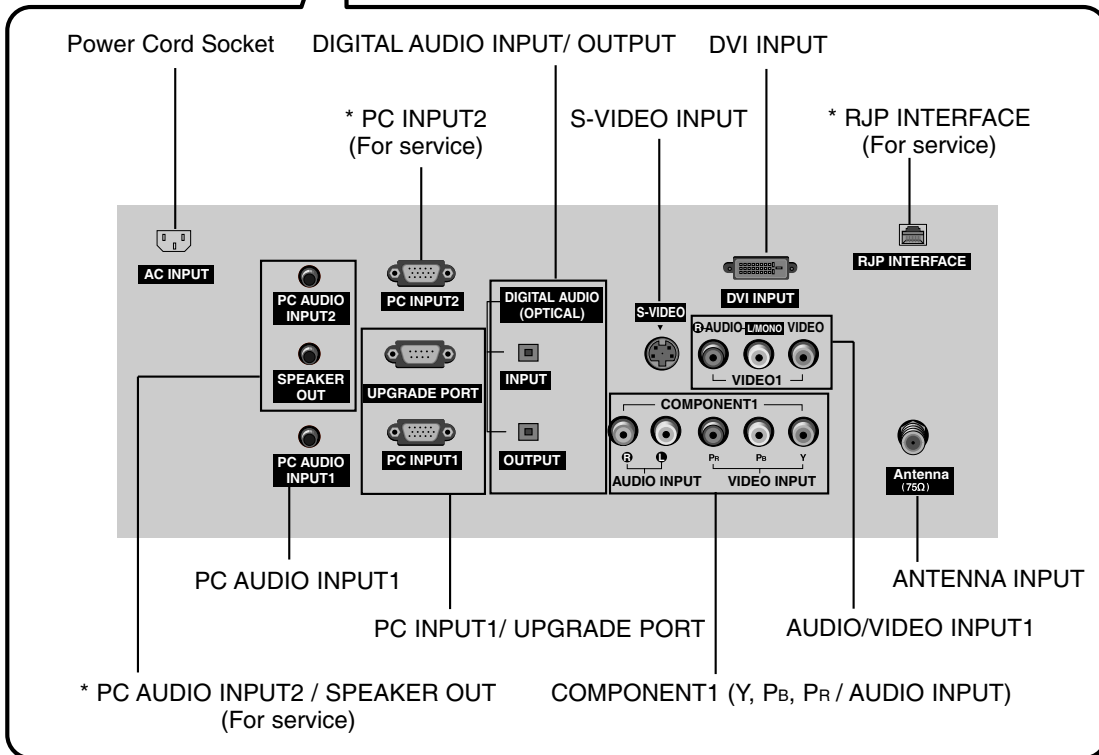
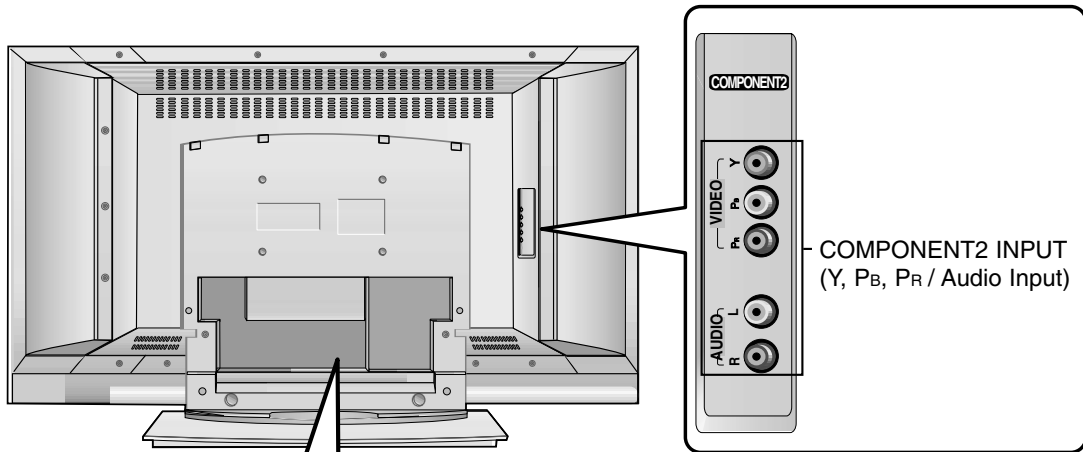

* For Service Jacks: PC INPUT2, PC AUDIO INPUT2, SPEAKER OUT, and RJP INTERFACE
Be careful not to use this jack. Just contact your dealer or service center.

Installation

Various Installation

Wall Mount: Horizontal installation



For proper ventilation, allow a clearance of 4" on each side and 2" from the wall. Detailed installation instructions are available from your dealer, see the optional Tilt Wall Mounting Bracket Installation and Setup Guide.

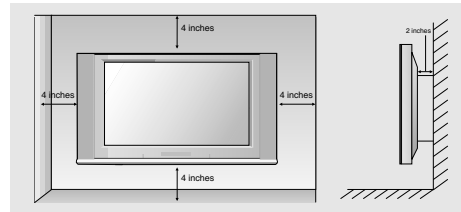

Desktop Pedestal Installation

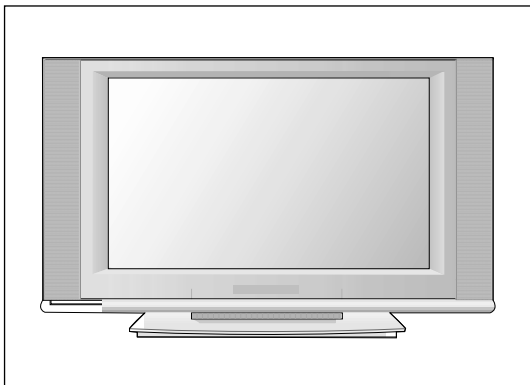

For proper ventilation, allow a clearance of 4" on each side and the top, and 2" from the wall.

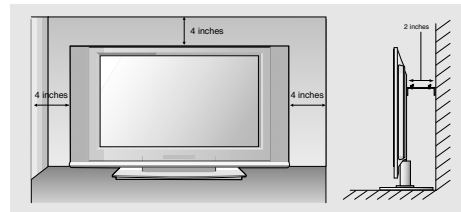

Power Cord Connection

- Connect the power cord correctly as shown.

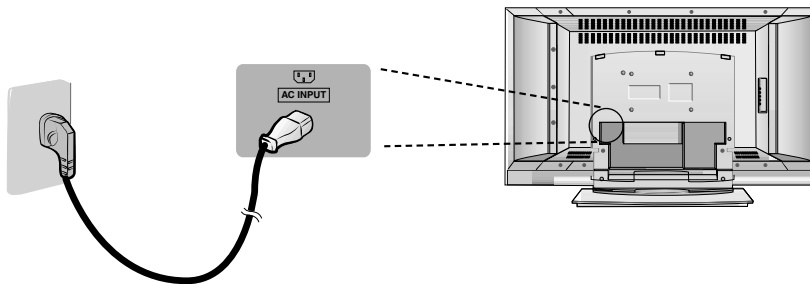

How to use rear AV cover

- 1** Hold the cover with both hands and pull it backward.

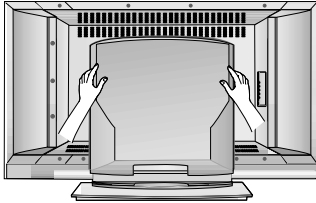

- 2** Install wires as necessary.
(To install various wires, refer to p.14~20.)

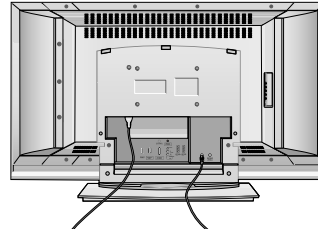

- 3** Align the holes on the TV back panel with the four protuberance on the rear AV cover and insert.

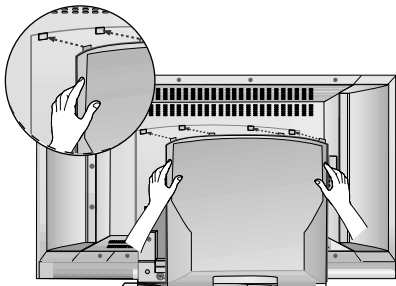

- 4** Reinstall the cover such as open it.

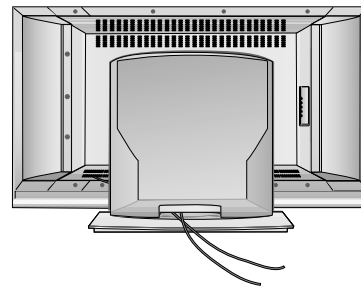

Wire Arrangement

- Pull the cables through the hole on the set.

Swivel Stand

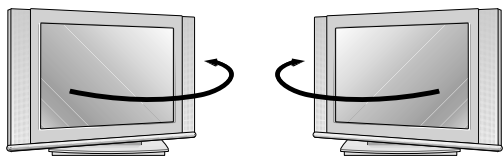

- The TV can be conveniently swiveled on its stand 90° to the left or right to provide the optimum viewing angle.

External Equipment Connections

Antenna Connection

- Antenna or Cable Service without a Cable Box Connections
- For optimum picture quality, adjust antenna direction if needed.

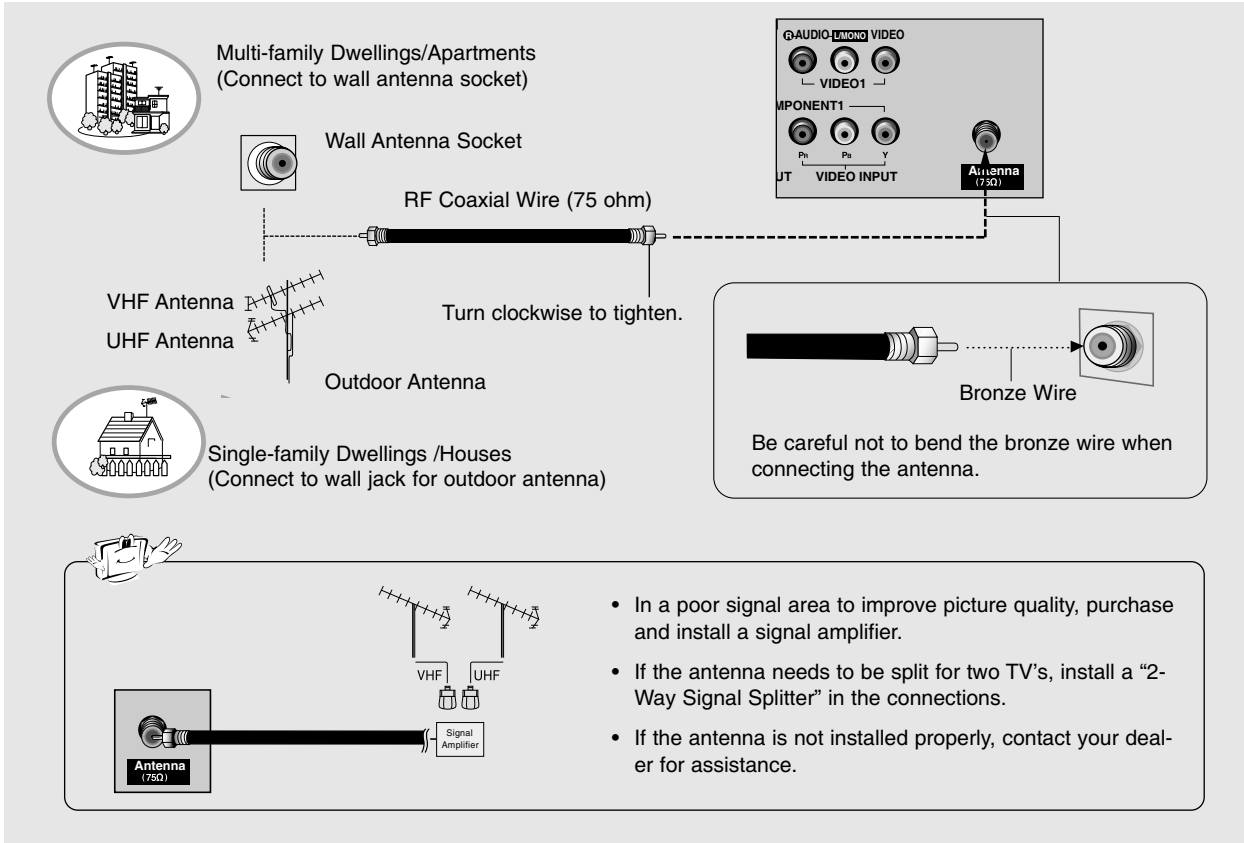

NOTE: If you are not sure of the type of signal(s) you are receiving, let EZ Scan complete all the channel signal-type searches. The TV will let you know when the analog, cable, and digital channel scans are complete.

External AV Source Setup

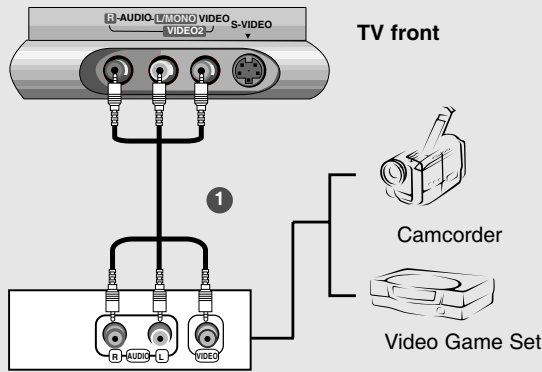

- 1 Connect the **AUDIO/VIDEO** jacks between TV and external equipment. Match the jack colours (Video = yellow, Audio Left = white, and Audio Right = red).
- 2 Select **Video 2** input source with using the **TV/VIDEO** button on the remote control.
- If connected to VIDEO1 input (the back side), select **Video 1** input source.
- 3 Operate the corresponding external equipment. Refer to external equipment operating guide.

Digital Audio Output

- Send the TV's audio to external audio equipment (stereo system) via the Digital Audio Output Optical port.

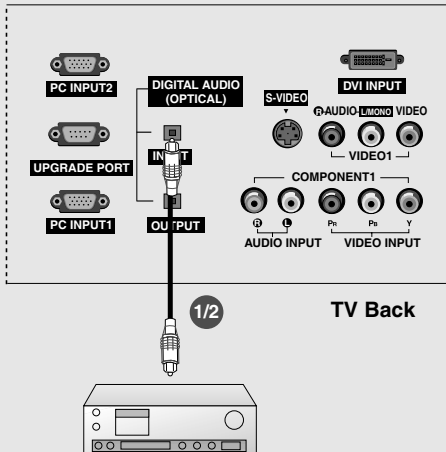

- 1 Connect one end of an optical cable to the TV Digital Audio Optical Output port.
- 2 Connect the other end of the optical cable to the digital audio optical input on the audio equipment.
- 3 Set the "**TV Speaker** option - **Off**" in the AUDIO menu. Refer to page 35.
See the external audio equipment instruction manual for operation.



CAUTION

Do not look into the optical output port. Looking at the laser beam may damage your vision.

PC Setup

- This TV provides Plug and Play capability, meaning that the PC adjusts automatically to the TV's settings. The TV sends configuration information (EDID) to the PC using the Video Electronics Standard Association (VESA) Display Data Channel (DDC) protocol.

When connecting with a D-sub 15 pin cable

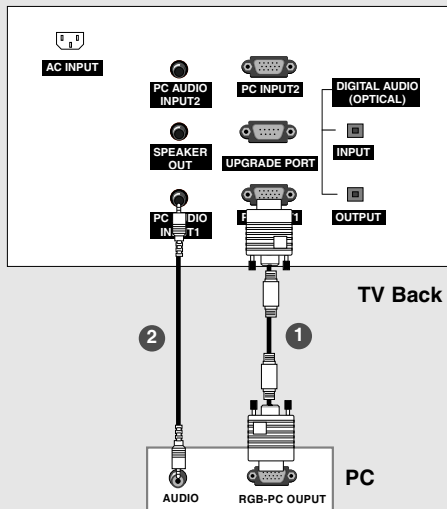

- 1 Connect the RGB output of the PC to the **PC INPUT1** jack on the set.
- 2 Connect the PC audio outputs to the **PC AUDIO INPUT1** jack on the set.
- 3 Turn on the PC and the set.
- 4 Select **RGB1-PC** input source in main input option of SETUP menu. (Refer to P.28)

When connecting with a DVI cable

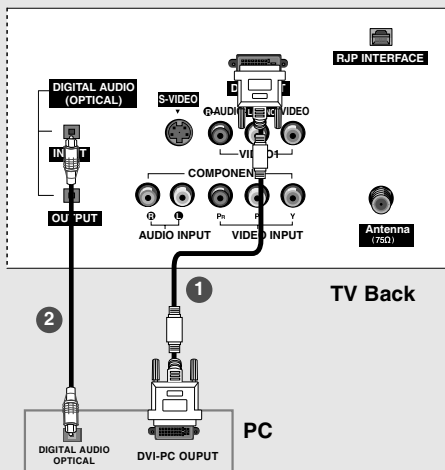

- 1 Connect the DVI output of the PC to the **DVI INPUT** jack on the set.
- 2 Connect the PC audio outputs to the **DIGITAL AUDIO INPUT** jack on the set.
- 3 Turn on the PC and the set.
- 4 Select **DVI-PC** input source in main input option of SETUP menu. (Refer to P.28)



1. To get the best picture quality, adjust the PC graphics card to 1024x768, 60Hz.
 2. If the graphic card on the PC does not output analog and digital RGB simultaneously, connect only one of either PC INPUT or DVI INPUT to display the PC on the TV.
If the graphic card on the PC does output analog and digital RGB simultaneously, set the TV to either RGB or DVI; (the other mode is set to Plug and Play automatically by the TV.)
 3. If using a sound card, adjust the PC sound as required.
 4. Check the image on your TV. There may be noise associated with the resolution, vertical pattern, contrast or brightness in PC mode. If noise is present, change the PC mode to another resolution, change the refresh rate to another rate or adjust the brightness and contrast on the menu until the picture is clear. If the refresh rate of the PC graphic card can not be changed, change the PC graphic card or consult the manufacturer of the PC graphic card.
 5. Avoid keeping a fixed image on the TV's screen for a long period of time. The fixed image may become permanently imprinted on the screen.
 6. The synchronization input form for Horizontal and Vertical frequencies is separate.
- * DPM (Display Power Management) Mode
When the PC is in the power saving mode, automatically the set goes into DPM mode to save the energy.
- * Use the supplied signal cable with the set. Otherwise, DPM mode may not work.

Monitor Display Specifications (RGB1-PC / DVI-PC Mode)

Resolution	Horizontal Frequency (KHz)	Vertical Frequency (Hz)
640x350	31.468	70.09
	31.469	70.08
720x400	37.927	85.03
	31.469	59.94
640x480	37.861	72.80
	37.500	75.00
800x600	35.156	56.25
	37.879	60.31
	48.077	72.18
	46.875	75.00
1024x768	48.363	60.00
	56.476	70.06
	60.023	75.02

Split Zoom (DTV 720p, or 1080i mode only)

- Enlarges the picture with correct proportions.
- When enlarging the picture, the image may become distorted.



1. Press the **ZOOM** button in DTV 720p, or 1080i modes.
2. Use the ▲ / ▼ / ◀ / ▶ buttons to select the screen split zoom section.
3. To return to normal viewing, press the **ZOOM** button again.

External Control Device Setup

- Connect the RS-232C input jack to an external control device (such as a computer or an A/V control system) and control the Monitor's functions externally.
- Connect the serial port of the control device to the RS-232C jack on the TV back panel.
- RS-232C connection cables are not supplied with the TV.

RS-232C Setup

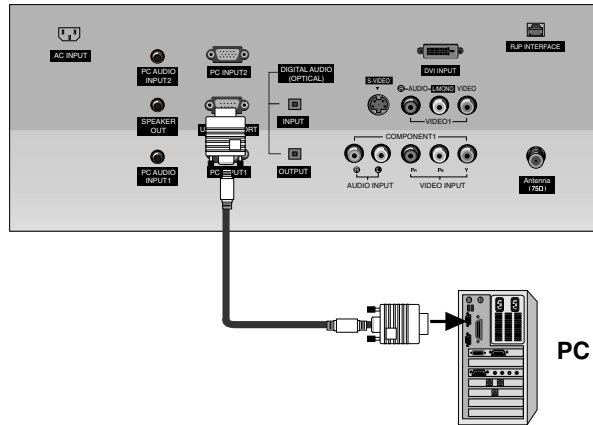

Type of Connector; D-Sub 9-Pin Male

No.	Pin Name
1	No connection
2	RXD (Receive data)
3	TXD (Transmit data)
4	DTR (DTE side ready)
5	GND
6	DSR (DCE side ready)
7	RTS (Ready to send)
8	CTS (Clear to send)
9	No Connection

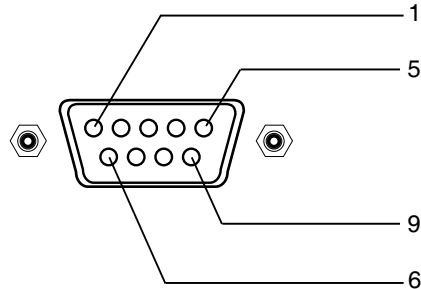

RS-232C Configurations

7-Wire Configurations (Standard RS-232C cable)

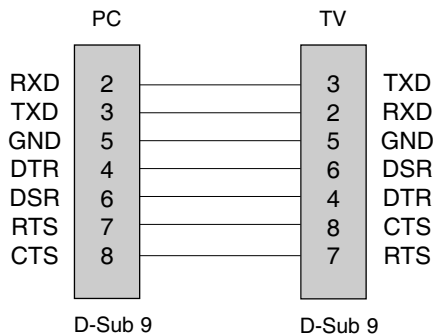

3-Wire Configurations (Not standard)

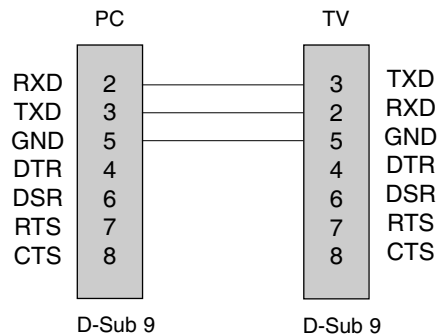

Set ID

- Use this function to specify a monitor ID number.
- Refer to 'Real Data Mapping'. See page 50.

1. Press the **MENU** button and then use ▲ / ▼ button to select the **SETUP** menu.
2. Press the ► button and then use ▲ / ▼ button to select **SET ID**.
3. Press the ► button and then use ▲ / ▼ button to adjust **SET ID** to choose the desired monitor ID number. The adjustment range of **SET ID** is 1 ~ 99.
4. Press **EXIT** button to return to TV viewing or press **MENU** button to return to the previous menu.

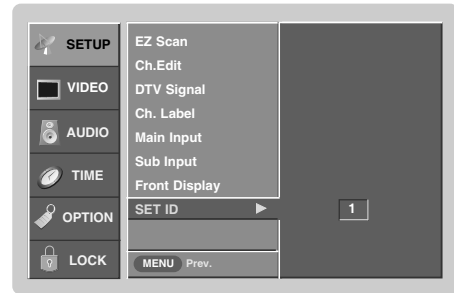

Communication Parameters

- Baud rate : 9600 bps (UART)
- Data length : 8 bits
- Parity : None
- Stop bit : 1 bit
- Communication code : ASCII code

* Use a crossed (reverse) cable.

Transmission / Receiving Protocol

Transmission

[Command1][Command2][][Set ID][][Data][Cr]

- * [Command 1]: First command to control the set. (j or k)
- * [Command 2]: Second command to control the set.
- * [Set ID]: You can adjust the set ID to choose desired monitor ID number in Setup menu. Adjustment range is 1 ~ 99. When selecting Set ID '0', every connected the TV is controlled. Set ID is indicated as decimal (1~99) on menu and as Hexa decimal (0x0~0x63) on transmission/receiving protocol.
- * [DATA]: To transmit command data.
Transmit 'FF' data to read status of command.
- * [Cr]: Carriage Return
ASCII code '0x0D'
- * []: ASCII code 'space (0x20)'

OK Acknowledgement

[Command2][][Set ID][][OK][Data][x]

- * The Monitor transmits ACK (acknowledgement) based on this format when receiving normal data. At this time, if the data is data read mode, it indicates present status data. If the data is data write mode, it returns the data of the PC computer.

Error Acknowledgement

[Command2][][Set ID][][NG][Data][x]

- * The Monitor transmits ACK (acknowledgement) based on this format when receiving abnormal data from non-viable functions or communication errors.

- Data
- 1: Illegal Code
 - 2: Not supported function
 - 3: Wait more time

Command Reference List

	COMMAND 1	COMMAND 2	DATA (Hexadecimal)
01. Power	k	a	0 ~ 1
02. Input Select	k	b	0 ~ 9
03. Aspect Ratio	k	c	1 ~ 1F
04. Screen Mute	k	d	0 ~ 1
05. Volume Mute	k	e	0 ~ 1
06. Volume Control	k	f	0 ~ 64
07. Contrast	k	g	0 ~ 64
08. Brightness	k	h	0 ~ 64
09. Color	k	i	0 ~ 64
10. Tint	k	j	0 ~ 64
11. Sharpness	k	k	0 ~ 64
12. OSD Select	k	l	0 ~ 1
13. Remote Control Lock Mode	k	m	0 ~ 1
14. PIP/Twin	k	n	0 ~ 3
15. PIP Position	k	q	0 ~ 3
16. Treble	k	r	0 ~ 64
17. Bass	k	s	0 ~ 64
18. Balance	k	t	0 ~ 64
19. Color Temperature	k	u	0 ~ 2
20. PIP Input Source	k	y	0 ~ 3

	COM- MAND 1	COM- MAND 2	DATA 0 (Hexadecimal)	DATA 1 (Hexadecimal)	DATA 2 (Hexadecimal)	DATA 3 (Hexadecimal)
21. Channel Tuning	m	a	01 ~ 87	01 ~ 87	00 ~ FE	00 ~ 15
22. Channel Add/Del	m	b	00 ~ 01			
23. Key	m	c				

Troubleshooting Checklist

No picture & No sound

- Check whether the TV is turned on.
- Try another channel. The problem may be with the broadcast.
- Is the power cord inserted into wall power outlet?
- Check your antenna direction and/or location.
- Test the wall power outlet, plug another product's power cord into the outlet where the TV's power cord was plugged in.

Picture OK & No sound

- Press the **VOLUME** (▶) button.
- Sound muted? Press **MUTE** button.
- Try another channel. The problem may be with the broadcast.
- Are the audio cables installed properly?

The remote control doesn't work

- Check to see if there is any object between the TV and the remote control causing obstruction.
- Are batteries installed with correct polarity (+ to +, - to -)?
- Correct remote operating mode set: TV, VCR etc.?
- Install new batteries.

Picture appears slowly after switching on

- This is normal, the image is muted during the TV startup process. Please contact your service center, if the picture has not appeared after five minutes.

No or poor color or poor picture

- Select **Color** in the **Video** menu and press the **VOLUME** (▶) button.
- Keep a sufficient distance between the TV and the VCR.
- Try another channel. The problem may be with the broadcast.
- Are the video cables installed properly?
- Activate any function to restore the brightness of the picture. (If still picture is on the screen for more than 5 minutes, the screen gets dark.)

Horizontal/vertical bars or picture shaking

- Check for local interference such as an electrical appliance or power tool.

No output from one of the speakers

- Adjust **Balance** in the **AUDIO** menu.

Unusual sound from inside the TV

- A change in ambient humidity or temperature may result in an unusual noise when the plasma display is turned on or off and does not indicate a fault with the TV.

Poor reception on some channels

- Station or cable TV experiencing problems, tune to another station.
- Station signal is weak, reorient antenna to receive weaker station.
- Check for sources of possible interference.

Poor stereo sound

- Check the kind of input signal and select **Mono, Stereo, SAP** with **SAP** the button.

Lines or streaks in pictures

- Check antenna (Change the direction of the antenna).

Power is suddenly turned off

- Is the sleep timer set?
 - Check the power control settings. /Power interrupted
 - No broadcast on station tuned with Auto off activated.
-

Maintenance

- Early malfunctions can be prevented. Careful and regular cleaning can extend the amount of time you will have your new TV. Be sure to turn the power off and unplug the power cord before you begin any cleaning.

Cleaning the Screen

1. Here's a great way to keep the dust off your screen for a while. Wet a soft cloth in a mixture of lukewarm water and a little fabric softener or dish washing detergent. Wring the cloth until it's almost dry, and then use it to wipe the screen.
2. Make sure the excess water is off the screen, and then let it air-dry before you turn on your TV.

Cleaning the Cabinet

To remove dirt or dust, wipe the cabinet with a soft, dry, lint-free cloth. Please be sure not to use a wet cloth.

Extended Absence



If you expect to leave your TV dormant for a long time (such as a vacation), it's a good idea to unplug the power cord to protect against possible damage from lightning or power surges.

Product Specifications

MODEL	32LP1DC
Width (inches / mm)	40.12 / 1019
Height (inches / mm)	24.7 / 627.5
Depth (inches / mm)	8.03 / 204
Weight (pounds / kg)	73.4 / 32
Power requirement	AC 100-240V~ 50/60Hz 2.0A
Television System	NTSC-M, ATSC
Program Coverage	VHF 2 ~ 13, UHF 14 ~ 69, CATV 1 ~ 125, CADTV 1 ~ 135. DTV 2 ~ 69
External Antenna Impedance	75 Ω

- The specifications shown above may be changed without prior notice for quality improvement.

