



# OWNER'S MANUAL LED LCD TV

Please read this manual carefully before operating your set and retain it for future reference.

32LS5700	32LS5750	42LM6200	42LM6250	42LM6700	47LM7600
42LS5700	42LS5750	47LM6200	47LM6250	47LM6700	55LM7600
47LS5700	47LS5750	55LM6200	55LM6250	55LM6700	
55LS5700	55LS5750	65LM6200			

# IMPORTANT SAFETY INSTRUCTIONS

Always comply with the following precautions to avoid dangerous situations and ensure peak performance of your product.

ENGLISH





**WARNING / CAUTION**

**RISK OF ELECTRIC SHOCK  
DO NOT OPEN**



TO REDUCE THE RISK OF ELECTRIC SHOCK DO NOT REMOVE COVER (OR BACK). NO USER SERVICEABLE PARTS INSIDE. REFER TO QUALIFIED SERVICE PERSONNEL.

 The lightning flash with arrowhead symbol, within an equilateral triangle, is intended to alert the user to the presence of uninsulated "dangerous voltage" within the product's enclosure that may be of sufficient magnitude to constitute a risk of electric shock to persons.

 The exclamation point within an equilateral triangle is intended to alert the user to the presence of important operating and maintenance (servicing) instructions in the literature accompanying the appliance.

**WARNING/CAUTION**

- TO REDUCE THE RISK OF FIRE AND ELECTRIC SHOCK, DO NOT EXPOSE THIS PRODUCT TO RAIN OR MOISTURE.

Read these instructions.  
Keep these instructions.  
Heed all warnings.  
Follow all instructions.



- Do not use this apparatus near water.



- Clean only with a dry cloth.



- Do not block any ventilation openings. Install in accordance with the manufacturer's instructions.

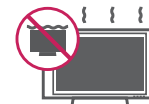

- Do not install near any heat sources such as radiators, heat registers, stoves, or other apparatus (including amplifiers) that produce heat.



- Do not defeat the safety purpose of the polarized or grounding-type plug. A polarized plug has two blades with one wider than the other. A grounding type plug has two blades and a third grounding prong. The wide blade or the third prong are provided for your safety. If the provided plug does not fit into your outlet, consult an electrician for replacement of the obsolete outlet (Can differ by country).



- Protect the power cord from being walked on or pinched particularly at plugs, convenience receptacles, and the point where they exit from the apparatus.



- Only use attachments/accessories specified by the manufacturer.



- Use only with a cart, stand, tripod, bracket, or table specified by the manufacturer, or sold with the apparatus. When a cart is used, use caution when moving the cart/apparatus combination to avoid injury from tip-over.



- Unplug this apparatus during lightning storms or when unused for long periods of time.

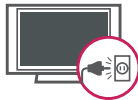

- Refer all servicing to qualified service personnel. Servicing is required when the apparatus has been damaged in any way, such as power-supply cord or plug is damaged, liquid has been spilled or objects have fallen into the apparatus, the apparatus has been exposed to rain or moisture, does not operate normally, or has been dropped.



- Never touch this apparatus or antenna during a thunder or lightning storm.
- When mounting a TV on the wall, make sure not to install the TV by hanging the power and signal cables on the back of the TV.

- Do not allow an impact shock or any objects to fall into the product, and do not drop anything onto the screen.

- CAUTION concerning the Power Cord (Can differ by country):

It is recommended that appliances be placed upon a dedicated circuit; that is, a single outlet circuit which powers only that appliance and has no additional outlets or branch circuits. Check the specification page of this owner's manual to be certain. Do not connect too many appliances to the same AC power outlet as this could result in fire or electric shock. Do not overload wall outlets. Overloaded wall outlets, loose or damaged wall outlets, extension cords, frayed power cords, or damaged or cracked wire insulation are dangerous. Any of these conditions could result in electric shock or fire. Periodically examine the cord of your appliance, and if its appearance indicates damage or deterioration, unplug it, discontinue use of the appliance, and have the cord replaced with an exact replacement part by an authorized service. Protect the power cord from physical or mechanical abuse, such as being twisted, kinked, pinched, closed in a door, or walked upon. Pay particular attention to plugs, wall outlets, and the point where the cord exits the appliance. Do not move the TV with the power cord plugged in. Do not use a damaged or loose power cord. Be sure do grasp the plug when unplugging the power cord. Do not pull on the power cord to unplug the TV.



- **Warning** - To reduce the risk of fire or electrical shock, do not expose this product to rain, moisture or other liquids. Do not touch the TV with wet hands. Do not install this product near flammable objects such as gasoline or candles, or expose the TV to direct air conditioning.



- Do not expose to dripping or splashing and do not place objects filled with liquids, such as vases, cups, etc. on or over the apparatus (e.g. on shelves above the unit).



• **Grounding**

Ensure that you connect the earth ground wire to prevent possible electric shock (i.e. a TV with a three-prong grounded AC plug must be connected to a three-prong grounded AC outlet). If grounding methods are not possible, have a qualified electrician install a separate circuit breaker. Do not try to ground the unit by connecting it to telephone wires, lightening rods, or gas pipes.

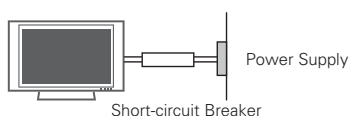

• **DISCONNECTING DEVICE FROM THE MAIN POWER**

The power outlet must remain readily accessed in the event the device needs to be unplugged.

- As long as this unit is connected to the AC wall outlet, it is not disconnected from the AC power source even if the unit is turned off.
- Do not attempt to modify this product in any way without written authorization from LG Electronics. Unauthorized modification could void the user's authority to operate this product.
- **ANTENNAS Outdoor antenna grounding** (Can differ by country):  
If an outdoor antenna is installed, follow the precautions below. An outdoor antenna system should not be located in the vicinity of overhead power lines or other electric light or power circuits, or where it can come in contact with such power lines or circuits as death or serious injury can occur. Be sure the antenna system is grounded so as to provide some protection against voltage surges and built-up static charges. Section 810 of

the National Electrical Code (NEC) in the U.S.A. provides information with respect to proper grounding of the mast and supporting structure, grounding of the lead-in wire to an antenna discharge unit, size of grounding conductors, location of antenna discharge unit, connection to grounding electrodes and requirements for the grounding electrode.

**Antenna grounding according to the National Electrical Code, ANSI/NFPA 70**

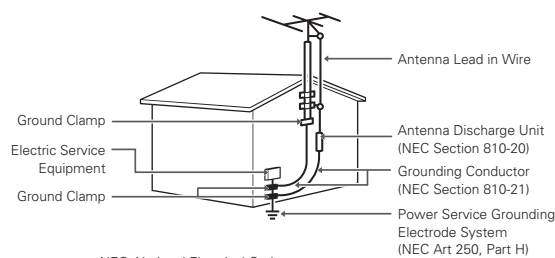

NEC: National Electrical Code

• **Cleaning**

When cleaning, unplug the power cord and wipe gently with a soft cloth to prevent scratching. Do not spray water or other liquids directly on the TV as electric shock may occur. Do not clean with chemicals such as alcohol, thinners or benzine.

• **Moving**

Make sure the product is turned off, unplugged and all cables have been removed. It may take 2 or more people to carry larger TVs. Do not press or put stress on the front panel of the TV.

• **Ventilation**

Install your TV where there is proper ventilation. Do not install in a confined space such as a bookcase. Do not cover the product with cloth or other materials while plugged. Do not install in excessively dusty places.

- If you smell smoke or other odours coming from the TV, unplug the power cord contact an authorized service center.
- Do not press strongly upon the panel with hand or sharp object such as nail, pencil or pen, or make a scratch on it.
- Keep the product away from direct sunlight.



• **Dot Defect**

The Plasma or LCD panel is a high technology product with resolution of two million to six million pixels. In a very few cases, you could see fine dots on the screen while you're viewing the TV. Those dots are deactivated pixels and do not affect the performance and reliability of the TV.

• **Generated Sound**

**"Cracking" noise:** A cracking noise that occurs when watching or turning off the TV is generated by plastic thermal contraction due to temperature and humidity. This noise is common for products where thermal deformation is required.

**Electrical circuit humming/panel buzzing:** A low level noise is generated from a high-speed switching circuit, which supplies a large amount of current to operate a product. It varies depending on the product.

This generated sound does not affect the performance and reliability of the product.

- Take care not to touch the ventilation openings. When watching the TV for a long period, the ventilation openings may become hot. This does not affect the performance of the product or cause defects in the product.

• **Viewing 3D Imaging (For 3D TV)**

- The vision of young children may still be developing. 3D contents should not be viewed by children under the age of 5. All other children's viewing of 3D content should be supervised by a responsible adult.
- Some viewers may experience symptoms of discomfort such as nausea, eye strain, fatigue and dizziness when viewing 3D content. All viewers should take regular breaks to help avoid these symptoms. If you experience any symptoms of discomfort, discontinue viewing and take a break until the symptoms go away. If symptoms continue, consult a doctor.
- Following the guideline below may lessen the likelihood of experiencing such discomfort:
  - Viewing angle: watch 3D contents at the eye level of the center of the TV screen.
  - Viewing distance: watch 3D contents from the minimum distance of 2 times the diagonal size of the TV screen.

- If the TV feels cold to the touch, there may be a small "flicker" when it is turned on. This is normal, there is nothing wrong with TV. Some minute dot defects may be visible on the screen, appearing as tiny red, green, or blue spots. However, they have no adverse effect on the TV's performance. Avoid touching the LCD screen or holding your finger(s) against it for long periods of time. Doing so may produce some temporary distortion effects on the screen.

**DISPOSAL (Hg lamp only used in LCD TVs)**

The fluorescent lamp used in this product contains a small amount of mercury. Do not dispose of this product with general household waste. Disposal of this product must be carried out in accordance to the regulations of your local authority.

**Preventing "Image burn" or "Burn-in" on your TV screen**

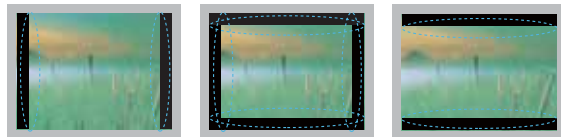

- If a fixed image displays on the TV screen for a long period of time, it will be imprinted and become a permanent disfigurement on the screen. This is "image burn" or "burn-in" and not covered by the warranty.
- If the aspect ratio of the TV is set to 4:3 for a long period of time, image burn may occur on the letterboxed area of the screen.
- Avoid displaying a fixed image on the TV screen for a long period of time (2 or more hours for LCD, 1 or more hours for the Plasma TV) to prevent image burn.

**For USA and Canada**

**NOTE TO CABLE/TV INSTALLER**

This reminder is provided to call the CATV system installer's attention to Article 820-40 of the National Electric Code (U.S.A.). The code provides guidelines for proper grounding and, in particular, specifies that the cable ground shall be connected to the grounding system of the building, as close to the point of the cable entry as practical.

ENGLISH

# TABLE OF CONTENTS

## 2 IMPORTANT SAFETY INSTRUCTIONS

## 6 TABLE OF CONTENTS

## 7 INSTALLATION PROCEDURE

## 7 ASSEMBLING AND PREPARING

- 7 Unpacking
- 9 Optional Extras
- 10 Parts and buttons
- 11 Lifting and moving the TV
- 12 Setting up the TV
  - 12 - Attaching the stand
  - 13 - Mounting on a table
  - 14 - Mounting on a wall
  - 15 - Tidying cables

## 16 MAKING CONNECTIONS

- 16 Connecting to an antenna or cable
- 17 Connecting to a HD receiver, DVD, or VCR player
  - 17 - HDMI Connection
  - 18 - DVI to HDMI Connection
  - 19 - Component Connection
  - 20 - Composite Connection
- 21 Connecting to a PC
  - 21 - HDMI Connection, DVI to HDMI Connection or RGB Connection
- 23 Connecting to an Audio System
  - 23 - Digital Optical Audio Connection
- 24 Connecting to a USB

## 25 REMOTE CONTROL

- 25 Magic Remote Control Functions
- 26 - Registering Magic Remote Control
- 26 - How to use Magic Remote Control
- 26 - Precautions to Take when Using the Magic Remote Control

## 27 WATCHING TV

- 27 Turning the TV on for the first time

## 27 USING THE USER GUIDE

## 28 ENTERTAINMENT

- 28 Network Connection
  - 28 - Connecting to a wired network
  - 30 - Connecting to a wireless network

## 31 TROUBLESHOOTING

## 31 OPEN SOURCE SOFTWARE NOTICE

## 32 SPECIFICATIONS

## 35 MAINTENANCE

- 35 Cleaning Your TV
  - 35 - Screen and frame
  - 35 - Cabinet and stand
  - 35 - Power cord



### NOTE

- Image shown may differ from your TV.
- Your TV's OSD (On Screen Display) may differ slightly from that shown in this manual.
- The available menus and options may differ from the input source or product model that you are using.
- New features may be added to this TV in the future.

## INSTALLATION PROCEDURE

- 1 Open the package and make sure all the accessories are included.
- 2 Attach the stand to the TV set.
- 3 Connect an external device to the TV set.
- 4 Make sure the network connection is available.

You can use the TV functions only when the network connection is made.

## ASSEMBLING AND PREPARING

### Unpacking

Check your product box for the following items. If there are any missing accessories, contact the local dealer where you purchased your product. The illustrations in this manual may differ from the actual product and item.

#### NOTE

- The items supplied with your product may vary depending on the model.
- Product specifications or contents of this manual may be changed without prior notice due to upgrade of product functions.
- For an optimal connection, HDMI cables and USB devices should have bezels less than 10 mm (0.39 inches) thick and 18 mm (0.7 inches) width.
- Use an extension cable that supports USB 2.0 if the USB cable or USB memory stick does not fit into your TV's USB port.

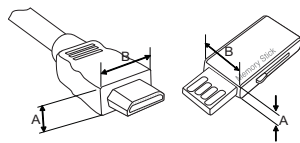

\*A ≤ 10 mm (0.39 inches)

\*B ≤ 18 mm (0.7 inches)

#### CAUTION

- Do not use any unapproved items to ensure the safety and product life span.
- Any damages or injuries by using unapproved items are not covered by the warranty.
- In case of some model, the thin film on screen is a part of TV, So don't take it off.

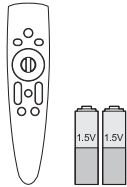

**Magic Remote Control,  
Batteries (AA)**  
(See p.25)

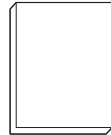

**Owner's manual**

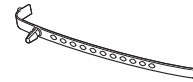

**Cable holder**  
(See p.15)



**Screws for assembly**  
8 EA, M4 x 20  
(See p.12)



**Screw for fixing**  
(Except 55LM6700)  
(See p.13)



**Ring spacers**  
4 EA  
(See p.15)

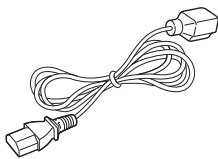

**Power Cord**

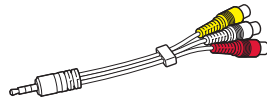

**Composite gender cable**  
(See p.19, 20)

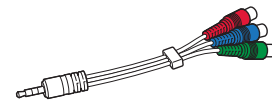

**Component gender cable**  
(See p.19)



**Cinema 3D Glasses**  
(Except LS5700, LS5750 series)  
The number of 3D glasses may differ depending on the model or country.



**Polishing cloth**  
(Depending on model)  
Gently wipe the spots on the cabinet with the polishing cloth.

ENGLISH



## Optional Extras

Optional extras can be changed or modified for quality improvement without any notification. Contact your dealer for buying these items. These device only works with compatible LG TV.



**AG-F2\*\***

Cinema 3D Glasses

The model name or design may be changed depending on the upgrade of product functions, manufacturer’s circumstances or policies.



**AN-WF100**

Wi-Fi dongle



**AN-MR300**

Magic Remote Control

Compatibility	LS5700 LS5750	LM6200 LM6250	LM6700	LM7600
<b>AG-F2**</b> Cinema 3D Glasses		●	●	●
<b>AN-WF100</b> Wi-Fi Dongle		●		●
<b>AN-MR300</b> Magic Remote Control	●	●	●	●

## Parts and buttons

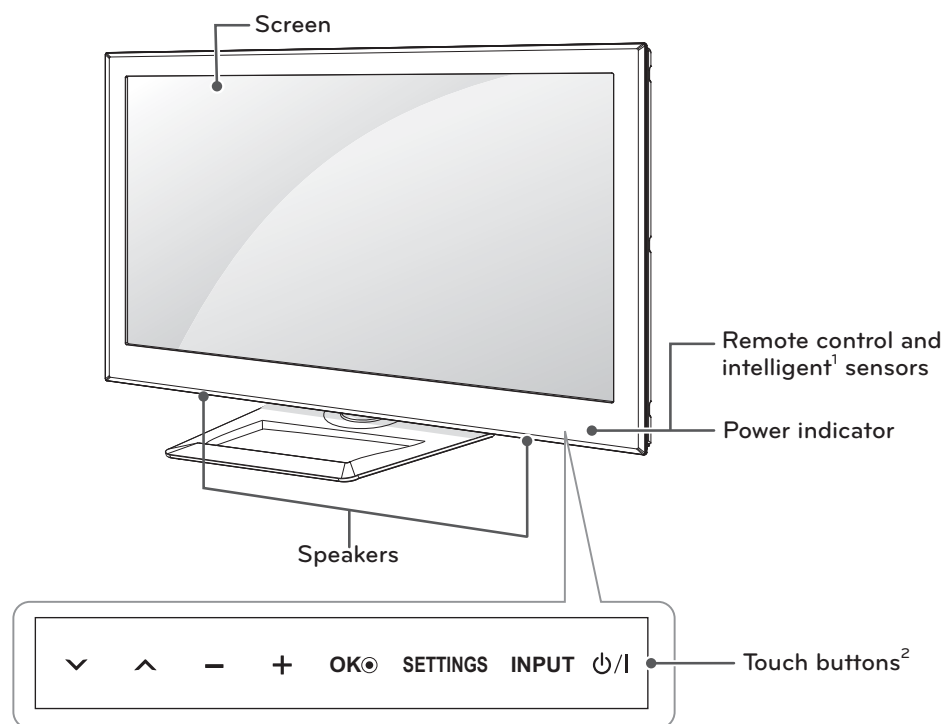

ENGLISH

Touch Button	Description
∨ ^	Scrolls through the saved channels.
- +	Adjusts the volume level.
OK ●	Selects the highlighted menu option or confirms an input.
SETTINGS	Accesses the main menu, or saves your input and exits the menus.
INPUT	Changes the input source.
⏻ / I	Turns the power on or off.

- 1 Intelligent sensor - Adjusts the image quality and brightness based on the surrounding environment.
- 2 All of the buttons are touch sensitive and can be operated through simple touch with your finger.



### NOTE

- You can set the power indicator light to on or off by selecting **OPTION** in the main menus.

## Lifting and moving the TV

When moving or lifting the TV, read the following to prevent the TV from being scratched or damaged and for safe transportation regardless of its type and size.

### CAUTION

- Avoid touching the screen at all times, as this may result in damage to the screen.
- It is recommended to move the TV in the box or packing material that the TV originally came in.
- Before moving or lifting the TV, disconnect the power cord and all cables.
- When holding the TV, the screen should face away from you to avoid damage.



- Hold the top and bottom of the TV frame firmly. Make sure not to hold the transparent part, speaker, or speaker grill area.

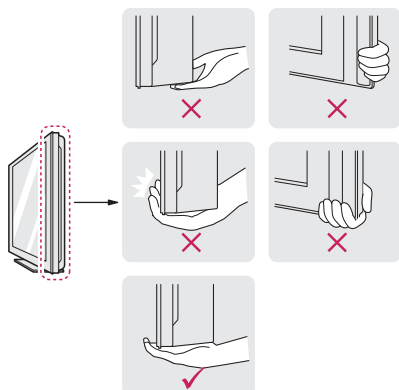

- When transporting a large TV, there should be at least 2 people.
- When transporting the TV by hand, hold the TV as shown in the following illustration.

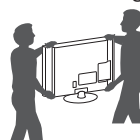

- When transporting the TV, do not expose the TV to jolts or excessive vibration.
- When transporting the TV, keep the TV upright, never turn the TV on its side or tilt towards the left or right.

## Setting up the TV

Put your TV on a pedestal stand and mount the TV on a table or wall.

### Attaching the stand

If you are not mounting the TV to a wall, use the following instructions to attach the stand.

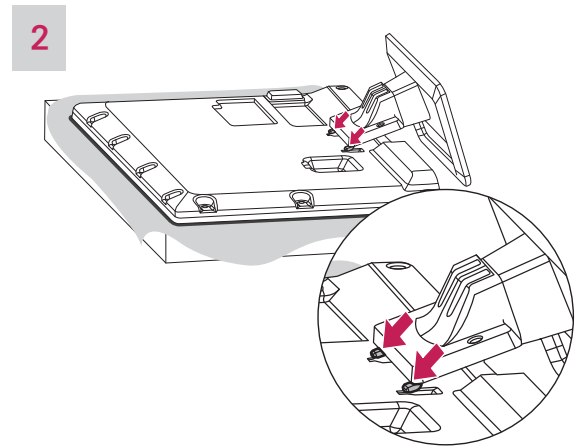
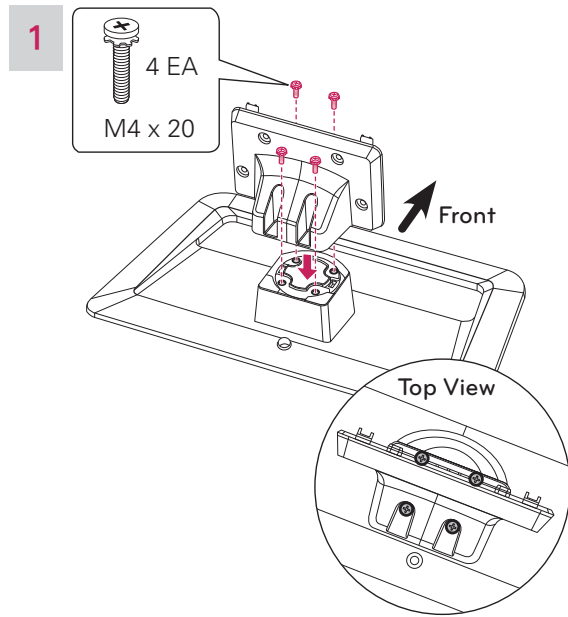

**! CAUTION**

- When attaching the stand to the TV set, place the screen facing down on a cushioned table or flat surface to protect the screen from scratches.

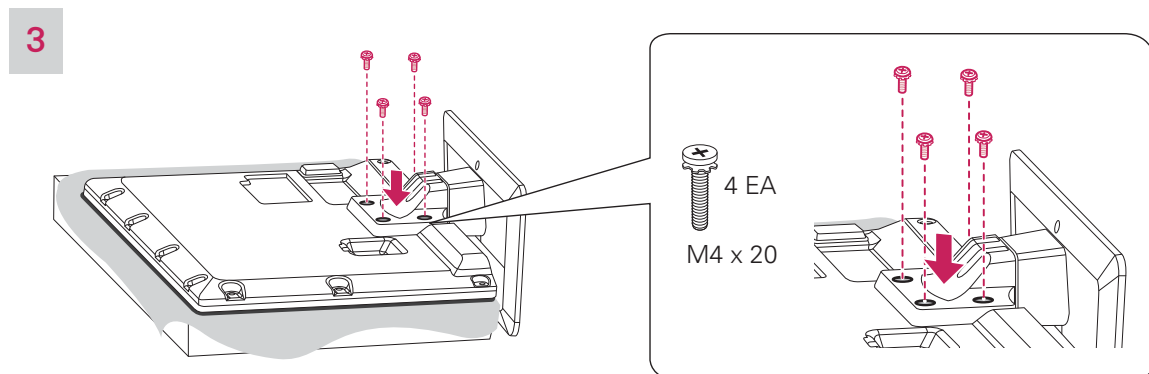

**! NOTE**

- Remove the stand before installing the TV on a wall mount by performing the stand attachment in reverse.

**! CAUTION**

- Tighten the screws firmly to prevent the TV from tilting forward. Do not over tighten.

## Mounting on a table

- 1 Lift and tilt the TV into its upright position on a table.
  - Leave a 10 cm (4 inches) (minimum) space from the wall for proper ventilation.

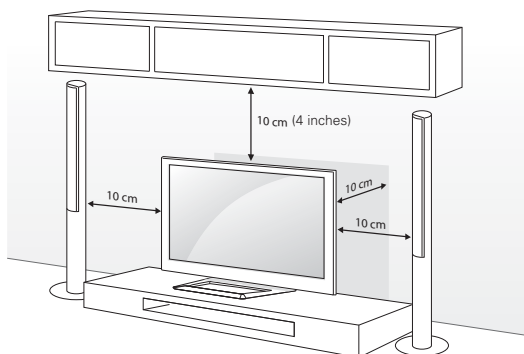

- 2 Connect the power cord to a wall outlet.

### CAUTION

- Do not place the TV near or on sources of heat, as this may result in fire or other damage.

### NOTE

- Swivel 20 degrees to the left or right and adjust the angle of the TV to suit your view.
- When adjusting the angle of the TV, watch out for your fingers.

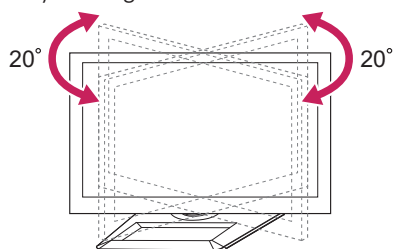

## Securing the TV to a table

(Except 55LM6700)

Fix the TV to a table to prevent from tilting forward, damage, and potential injury.

Mount the TV on a table, and then insert and tighten the supplied screw on the rear of the stand.

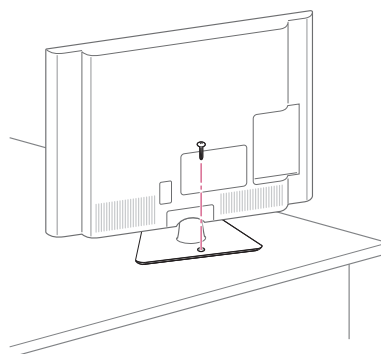

### WARNING

- To prevent TV from falling over, the TV should be securely attached to the floor/wall per installation instructions. Tipping, shaking, or rocking the TV may cause injury.

Securing the TV to a wall (optional)

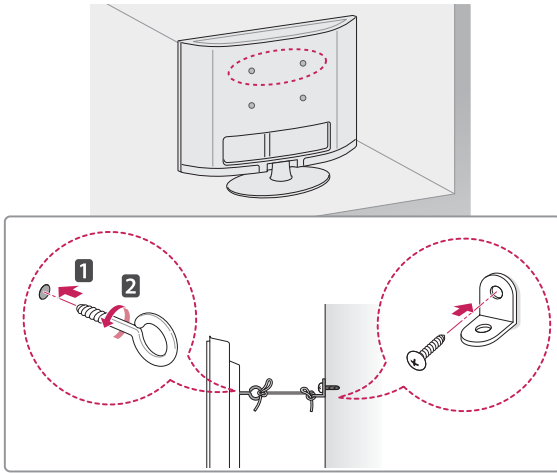

- 1 Insert and tighten the eye-bolts, or TV brackets and bolts on the back of the TV.
  - If there are bolts inserted at the eye-bolts position, remove the bolts first.
- 2 Mount the wall brackets with the bolts to the wall.
 

Match the location of the wall bracket and the eye-bolts on the rear of the TV.
- 3 Connect the eye-bolts and wall brackets tightly with a sturdy rope.
 

Make sure to keep the rope horizontal with the flat surface.



**CAUTION**

- Make sure that children do not climb on or hang on the TV.



**NOTE**

- Use a platform or cabinet that is strong and large enough to support the TV securely.
- Brackets, bolts and ropes are optional. You can obtain additional accessories from your local dealer.

Mounting on a wall

Attach an optional wall mount bracket at the rear of the TV carefully and install the wall mount bracket on a solid wall perpendicular to the floor. When you attach the TV to other building materials, please contact qualified personnel. LG recommends that wall mounting be performed by a qualified professional installer.

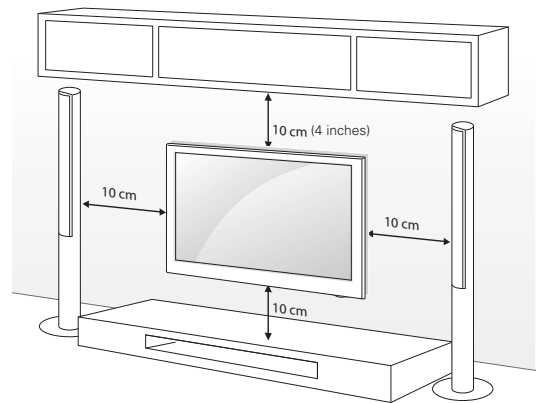

Make sure to use screws and wall mount bracket that meet the VESA standard. Standard dimensions for the wall mount kits are described in the following table.

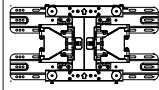
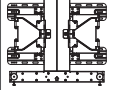
<b>Model</b>	32LS5700 42LS5700 32LS5750 42LS5750 42LM6200 42LM6250 42LM6700	47LS5700 55LS5700 47LS5750 55LS5750 47LM6200 55LM6200 65LM6200 47LM6250 55LM6250 47LM6700 55LM6700 47LM7600 55LM7600
<b>VESA</b>	200 x 200	400 x 400
<b>Standard screw</b>	M6	M6
<b>Number of screws</b>	4	4
<b>Wall mount bracket (optional)</b>	LSW200BX, LSW200BXG 	LSW400BX, LSW400BXG 

### ! CAUTION

- Disconnect the power first, and then move or install the TV. Otherwise electric shock may occur.
- If you install the TV on a ceiling or slanted wall, it may fall and result in severe injury. Use an authorized LG wall mount and contact the local dealer or qualified personnel.
- Do not over tighten the screws as this may cause damage to the TV and void your warranty.
- Use the screws and wall mounts that meet the VESA standard. Any damages or injuries by misuse or using an improper accessory are not covered by the warranty.

### ! NOTE

- Use the screws that are listed on the VESA standard screw specifications.
- The wall mount kit includes an installation manual and necessary parts.
- The wall mount bracket is optional. You can obtain additional accessories from your local dealer.
- The length of screws may differ depending on the wall mount. Make sure to use the proper length.
- For more information, refer to the manual supplied with the wall mount.

### ! NOTE

- Place the ring spacers on the set before installing the wall mounting bracket so that the inclination of the backside of the set can be adjusted perpendicularly.

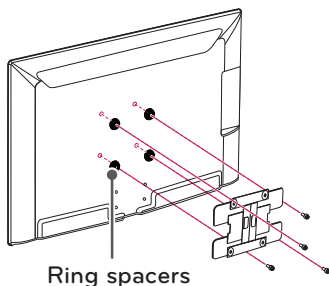

## Tidying cables

- 1 Gather and bind the cables with the cable holder.

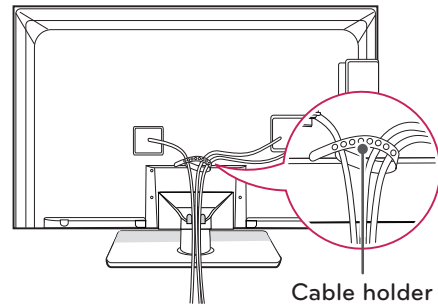

### ! CAUTION

- Do not move the TV by holding the cable holder, as the cable holders may break, and injuries and damage to the TV may occur.

## MAKING CONNECTIONS

Connect various external devices to the TV and switch input modes to select an external device. For more information on external device's connection, refer to the manual provided with each device.

Available external devices are: HD receivers, DVD players, VCRs, audio systems, USB storage devices, PC, gaming devices, and other external devices.

### NOTE

- If you record a TV program on a DVD recorder or VCR, make sure to connect the TV signal input cable to the TV through a DVD recorder or VCR. For more information on recording, refer to the manual provided with the connected device.
- The external device connection may differ from the model.
- Connect external devices to the TV regardless of the order of the TV port.
- If you connect a gaming device to the TV, use the cable supplied with the gaming device.
- Refer to the external equipment's manual for operating instructions.

## Connecting to an antenna or cable

Connect an antenna, cable, or cable box to watch TV while referring to the following. The illustrations may differ from the actual items and a RF cable is optional.

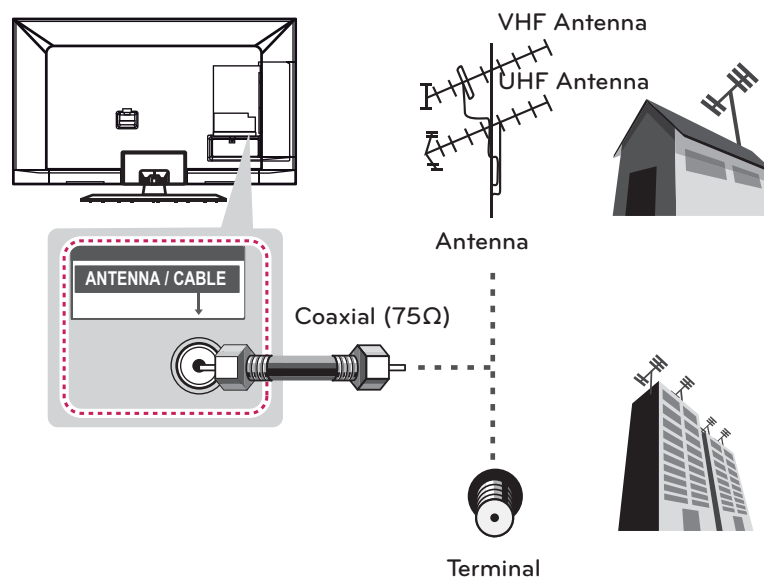

### CAUTION

- Make sure not to bend the copper wire of the RF cable.

Copper wire

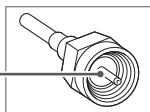

- Complete all connections between devices, and then connect the power cord to the power outlet to prevent damage to your TV.

### NOTE

- Use a signal splitter to use more than 2 TVs.
- Visit <http://lgknowledgebase.com> for more information about the antenna and cable connection. Search for antenna.



## Connecting to a HD receiver, DVD, or VCR player

Connect a HD receiver, DVD, or VCR player to the TV and select an appropriate input mode.

### HDMI Connection

**HDMI is the best way to connect a device.**

Transmits the digital video and audio signals from an external device to the TV. Connect the external device and the TV with the HDMI cable as shown in the following illustration.

**NOTE**

- Use the latest High Speed HDMI™ Cable with CEC (Customer Electronics Control) function.
- High Speed HDMI™ Cables are tested to carry an HD signal up to 1080p and higher.

Choose any HDMI input port to connect.  
It does not matter which port you use.

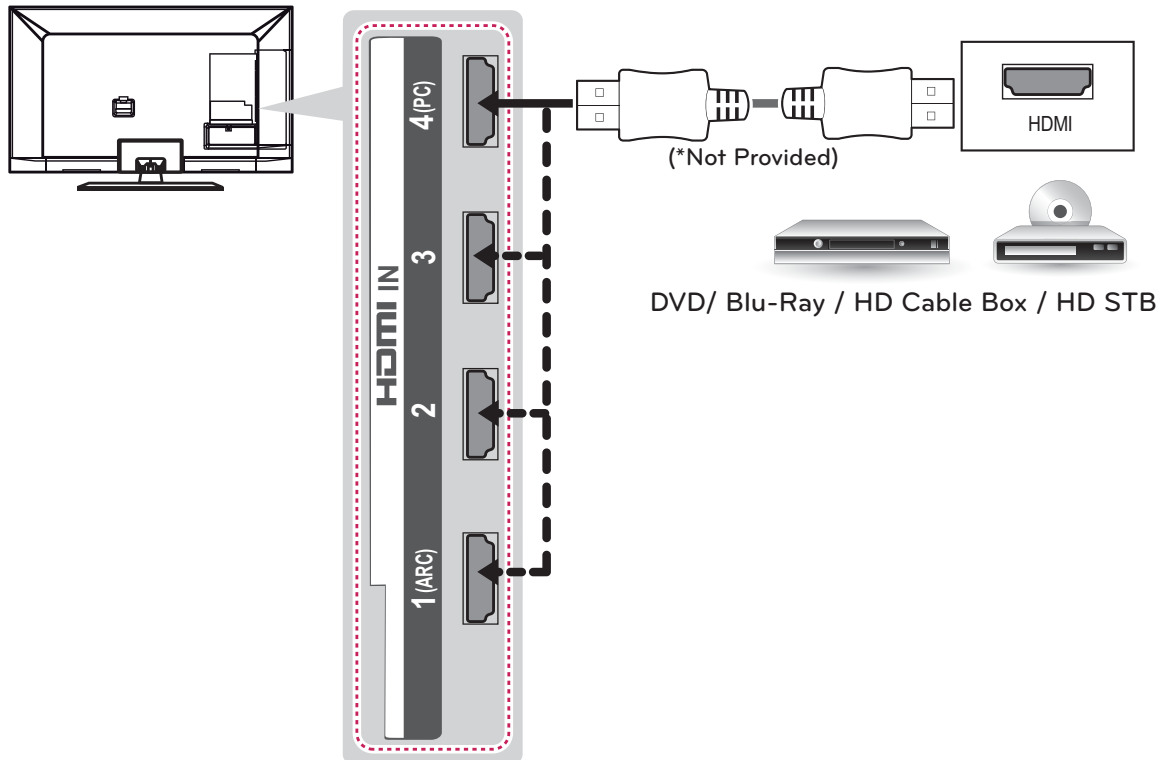

ENGLISH

**NOTE**

- DTV Audio Supported Codec: MPEG, Dolby Digital
- HDMI Audio Supported Format: Dolby Digital, PCM (Up to 192 KHz, 32k/44.1k/48k/88k/96k/176k/192k) -> Not supported DTS.

**ARC (Audio Return Channel)**

- An external audio device that supports SIMPLINK and ARC must be connected using HDMI input 1 (ARC) port.
- When connected with a high-speed HDMI cable, the external audio device that supports ARC outputs optical SPDIF without additional optical audio cable and supports the SIMPLINK function.

## DVI to HDMI Connection

Transmits the digital video signal from an external device to the TV. Connect the external device and the TV with the DVI-HDMI cable as shown in the following illustration. To transmit an audio signal, connect an audio cable.

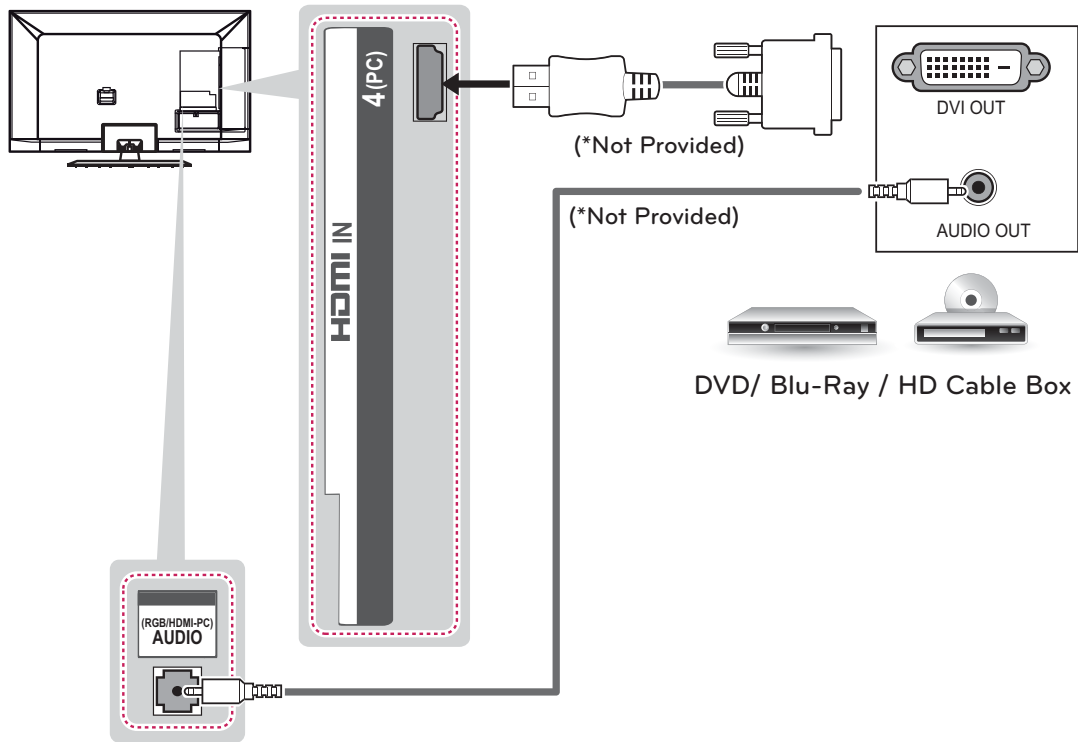

ENGLISH

## Component Connection

Transmits the analog video and audio signals from an external device to the TV. Connect the external device and the TV with the component cable as shown in the following illustration.

**NOTE**

- If cables are installed incorrectly, it could cause the image to display in black and white or with distorted color.
- Check to ensure the cable are matched with the corresponding color connection.

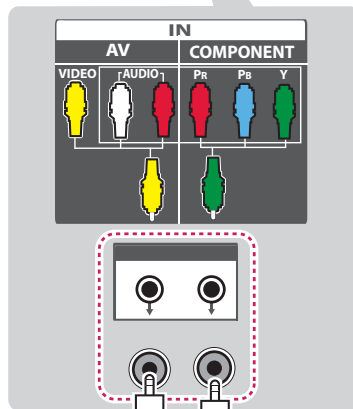
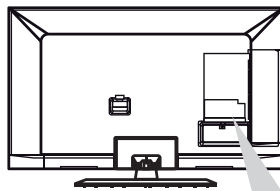

(Use the composite gender cable provided.) (Use the component gender cable provided.)

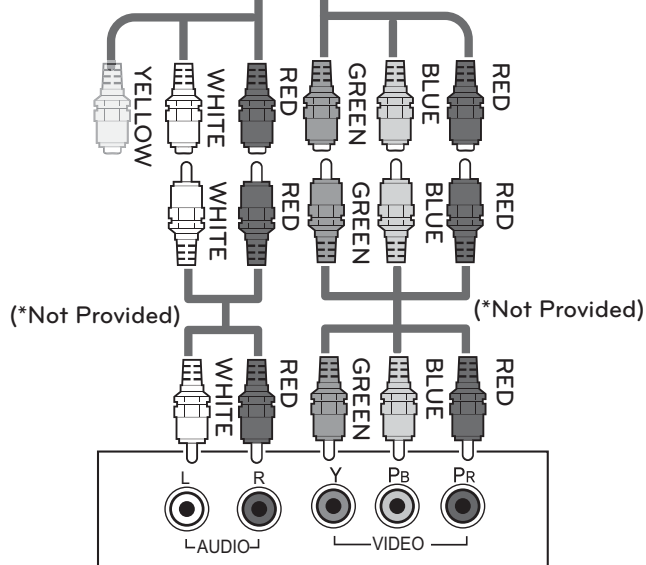

DVD/ Blu-Ray / HD Cable Box

## Composite Connection

Transmits the analog video and audio signals from an external device to the TV. Connect the external device and the TV with the composite cable as shown in the following illustration.

**NOTE**

- If you have a mono VCR, connect the audio cable from the VCR to the AUDIO L/MONO jack of the TV.
- Check to ensure the cable are matched with the corresponding color connection.

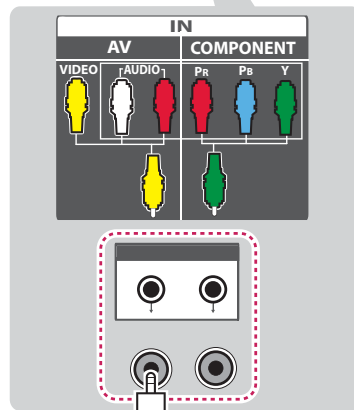
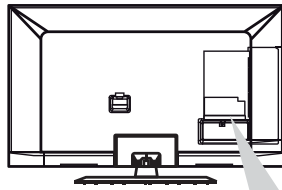

(Use the composite gender cable provided.)

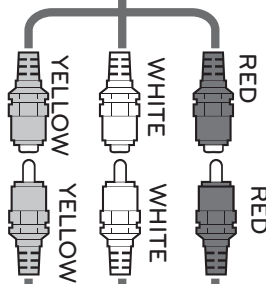

(\*Not Provided)

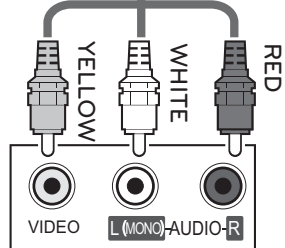

VCR / DVD/ Blu-Ray / HD Cable Box

## Connecting to a PC

### ! NOTE

- It is recommended to use the TV with the HDMI connection for the best image quality.
- Depending on the graphics card, DOS mode may not work if a HDMI to DVI Cable is in use.
- In PC mode, there may be noise associated with the resolution, vertical pattern, contrast or brightness. If noise is present, change the PC output to another resolution, change the refresh rate to another rate or adjust the brightness and contrast on the PICTURE menu until the picture is clear.
- The synchronization input form for Horizontal and Vertical frequencies is separate.
- Depending on the graphics card, some resolution settings may not allow the image to be positioned on the screen properly.

## HDMI Connection, DVI to HDMI Connection or RGB Connection

Choose method A, B, or C to make connection.

### Method A: HDMI Connection

Choose any HDMI input port to connect.  
It does not matter which port you use.

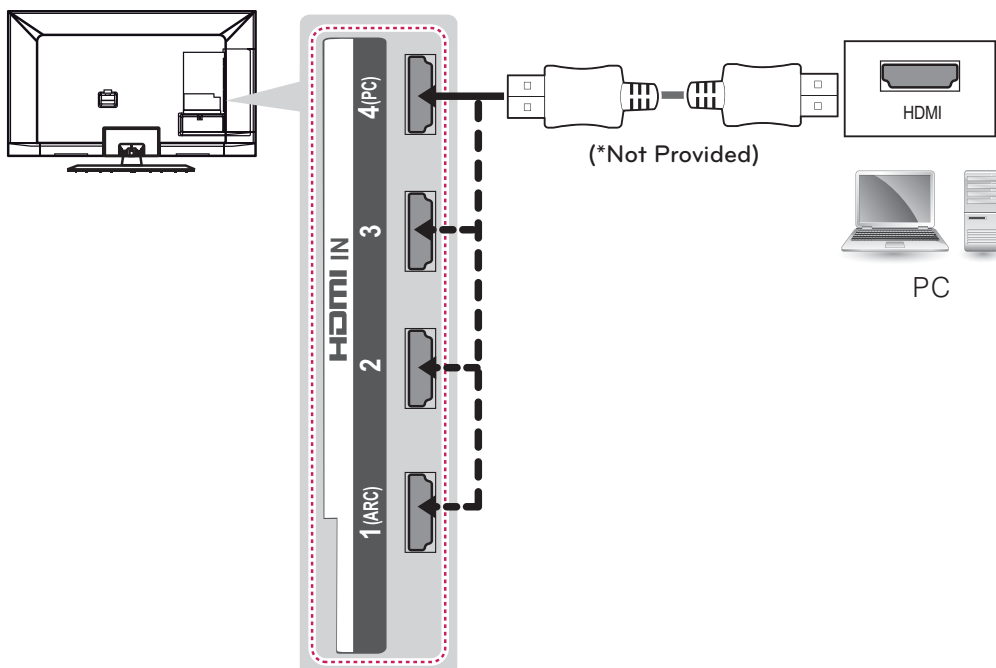

Method B: DVI to HDMI Connection

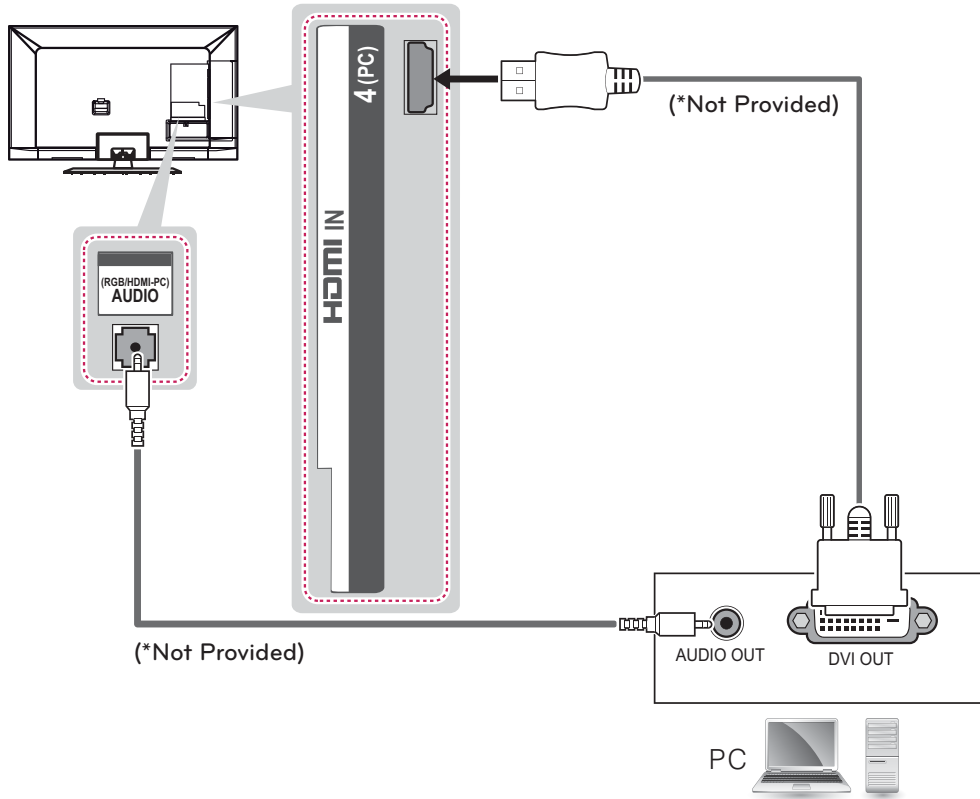

Method C: RGB Connection

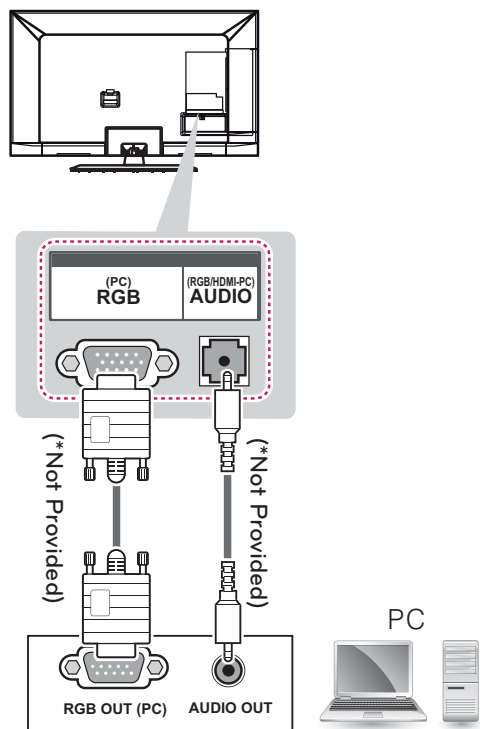

## Connecting to an Audio System

Use an optional external audio system instead of the built-in speaker.

### ! NOTE

- If you use an optional external audio device instead of the built-in speaker, set the TV speaker feature to off.

### Digital Optical Audio Connection

Transmits the digital audio signal from the TV to an external device. Connect the external device and the TV with the optical audio cable as shown in the following illustration.

### ! NOTE

- Do not look into the optical output port. Looking at the laser beam may damage your vision.
- Audio with ACP (Audio Copy Protection) function may block digital audio output.

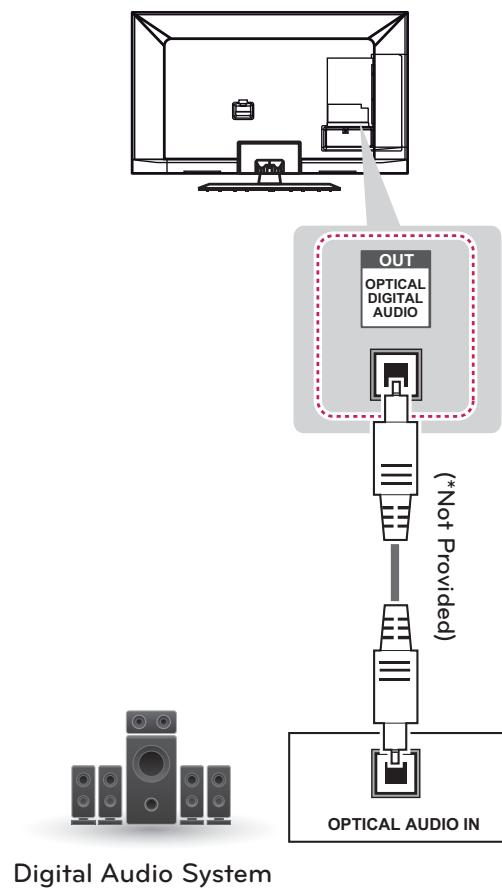

## Connecting to a USB

Connect a USB storage device such as a USB flash memory, external hard drive, or a USB memory card reader to the TV and access the Smart Share menu to use various multimedia files.

**NOTE**

- To store apps in the USB storage device, make sure that it is connected to the USB IN 3 USB Apps port.
- To use USB Hub device, make sure that it is connected to the USB IN 2 USB Hub port.

Choose any USB input port to connect.  
It does not matter which port you use.

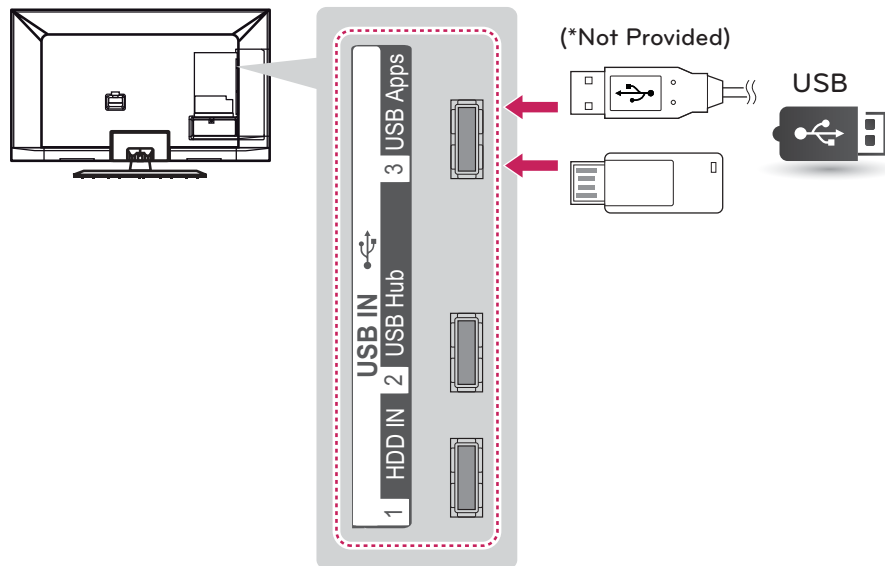



# REMOTE CONTROL

## Magic Remote Control Functions

Please read this manual carefully and use the TV correctly.

When the message "Magic remote control battery is low. Change the battery." is displayed, replace the battery.

To replace batteries, open the battery cover, replace batteries (1.5 V AA) matching ⊕ and ⊖ ends to the label inside the compartment, and close the battery cover. Be sure to point the remote control at the remote control sensor on the TV.

To remove the batteries, perform the installation actions in reverse.

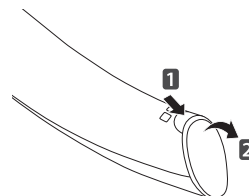

**CAUTION**

- Do not mix old and new batteries, as this may damage the remote control.

Make sure to point the remote control at the remote control sensor on the TV.

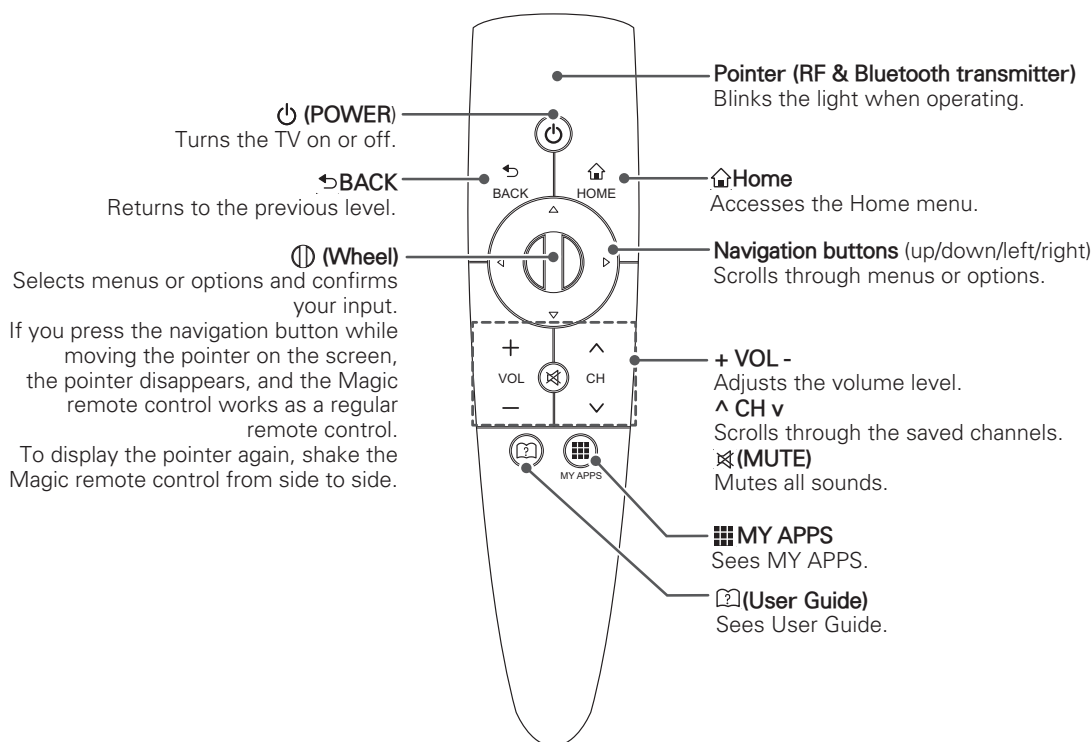

ENGLISH

1	If you press <b>WHEEL</b> on the Magic remote control, the following screen appears. Views the information of the current program and screen.
2	If you press <b>WHEEL</b> on the Magic remote control, the following screen appears. Set the channel you want. You can press the CH button on the remote control to set the channel.
3	If you move the Magic remote control on the bottom of the screen. You can select Quick Menu.

## Registering Magic Remote Control

The Magic Remote Control operates by pairing with your TV.

Register the Magic Remote Control to use it.

### How to register the Magic Remote Control

	<p>To register the remote control, press the <b>Ⓢ (Wheel)</b> button on the remote control while aiming it at your TV.</p>
---	--

### How to Re-register the Magic Remote Control after Registration Failure

	<p>Reset the remote control by pressing and holding both the <b>BACK ↶</b> and <b>HOME 🏠</b> buttons for 5 seconds. (Once the reset is complete, the light on the Pointer blinks.) Then repeat the above procedure to register the remote control.</p>
--	--

## How to use Magic Remote Control

<p>1</p> 	<p>Press <b>Ⓢ (Wheel)</b> button if there is no pointer on your TV screen. The pointer will then appear on the screen.</p> <p>» If the pointer has not been used for a certain period of time, it will disappear.</p>
--	---

<p>2</p> 	<p>You can move the pointer by aiming the Pointer Receiver of the remote control at your TV then move it left, right, up or down.</p> <p>» If the pointer does not work properly after clicking the <b>Ⓢ (Wheel)</b> button, leave the remote control for 10 seconds then use it again.</p>
--	---

## Precautions to Take when Using the Magic Remote Control

- Use the remote control within the maximum communication distance (10 m, 32.8ft). Using the remote control beyond this distance, or with an object obstructing it, may cause a communication failure.
- A communication failure may occur due to nearby devices. Electrical devices such as a microwave oven or wireless LAN product may cause interference, as this will use the same bandwidth (2.4 GHz) as the Magic Remote Control.
- The Magic Remote Control may be damaged or may malfunction if it is dropped or receives a heavy impact.
- Take care not to bump into nearby furniture or other people when using the Magic Remote Control.
- Manufacturer and installer cannot provide service related to human safety as the applicable wireless device has possibility of electric wave interference.
- It is recommended that an Access Point (AP) be located more than 1 m (3.28 ft) away from the TV. If the AP is installed closer than 1 m (3.28 ft), the magic remote control may not perform as expected due to frequency interference.

## WATCHING TV

### Turning the TV on for the first time

When you turn the TV on for the first time, the Initial setting screen appears. Select a language and customize the basic settings.

- 1 Connect the power cord to a power outlet.
- 2 In Standby mode, press the power button on the remote control to turn the TV on.  
The Initial setting screen appears if you turn the TV on for the first time.

#### NOTE

- You can also access **Initial Setting** by accessing **OPTION** in the main menu.

- 3 Follow the on-screen instructions to customize your TV settings according to your preferences.

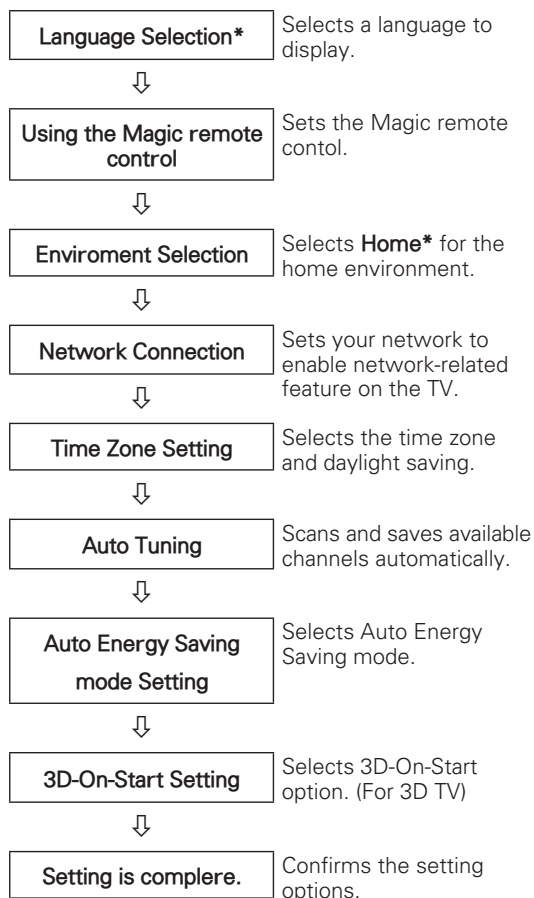

#### NOTE

- To display images in the best quality for your home environment, select **Home\***.
- **Store\*** is suitable for the retail environment.
- If you select **Store\***, the any customized settings will switch back to the default settings of **Store\*** in 5 minutes.
- Power Indicator feature is disabled in Store Demo mode.

- 4 When the basic settings are complete, press **⏪ (Wheel)**.

#### NOTE

- If you do not complete the Initial setting, it will appear whenever the TV turns on.
- Disconnect the power cord from the power outlet when you do not use the TV for a long period of time.

- 5 To turn the TV off, press the power button on the remote control.

## USING THE USER GUIDE

User Guide allows you to more easily access the detailed TV information.

- 1 Move the Magic remote control on the bottom of the screen.
- 2 Select **SETTINGS** and press **⏪ (Wheel)**.
- 3 Move the Magic remote control, select **SUPPORT** and press **⏪ (Wheel)**.
- 4 Move the Magic remote control, select **User Guide** and press **⏪ (Wheel)**.

#### NOTE

- You can also access the User Guide by pressing **⏪ (User Guide)** in the remote control.

# ENTERTAINMENT

## Network Connection

### Connecting to a wired network

Connect the TV to a local area network (LAN) via the LAN port as shown in the following illustration and set up the network settings.

After making a physical connection, a small number of home networks may require the TV network settings to be adjusted. For most home networks, the TV will connect to automatically without any adjustments.

For detail information, contact your internet provider or router manual.

1

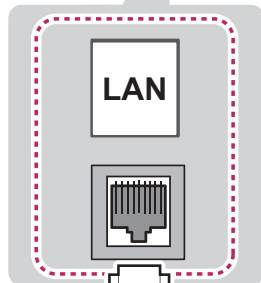
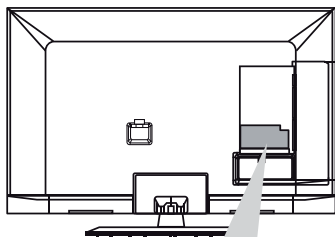

(\*Not Provided)

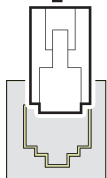

External modem / Wall outlet / PC

2



### CAUTION

- Do not connect a modular phone cable to the LAN port.
- Since there are various connection methods, please follow the specifications of your telecommunication carrier or internet service provider.
- After connecting the LAN port, use the Premium or LG Apps menu.

ENGLISH

To set up the network settings: (Even if your TV has already connected automatically, running setup again will not harm anything)

- 1 Press **SETTINGS** to access the Home menu.
- 2 Press the Navigation buttons to scroll to **NETWORK**.
- 3 Press the Navigation buttons to select **Network Connection** and press **⏪ (Wheel)**.
- 4 Press the Navigation buttons to select **IP Auto Setting** or **IP Manual Setting** and press **⏪ (Wheel)**.

### NOTE

- If the network setting screen do not appear automatically, press **SETTINGS** → **NETWORK** → **Network Connection**.
- If the network settings are not set correctly, the functions or services that require the network connection may not work properly.
- If the options in **Network Connection** are not set properly, check your Internet connection and contact your Internet service provider.
- To use Internet on TV, you must have active broadband Internet connection at all times.
- If you cannot access the Internet, check the network status of your computer.
- If the auto IP setting of the router expires, when using **IP Auto Setting**, you may experience temporary network disconnection. Refer to the owner's manual of the router for details.

- If selecting **IP Manual Setting**, press the Navigation and Number buttons. IP addresses will need to be input manually.
- **IP Auto Setting**: Select this if there is a DHCP server (Router) on the local area network (LAN) via wired connection, the TV will automatically be allocated an IP address. If you're using a broadband router or broadband modem that has a DHCP (Dynamic Host Configuration Protocol) server function. The IP address will automatically be determined.
- **IP Manual Setting**: Select if there is no DHCP server on the network or you want to set the IP address manually.

- 4 When you are finished, press **Enter**.

## Connecting to a wireless network

The LG Wireless LAN for Broadband/DLNA Adaptor allows the TV to connect to a wireless LAN network.

The network configuration and connection method may vary depending on the equipment in use and the network environment. Refer to the setup instructions supplied with your access point or wireless router for detailed connection steps and network settings.

Setting up the AP (Access Point) or the wireless router is required before connecting the TV to the network. The easiest method is the WPS button method (Third method in this section).

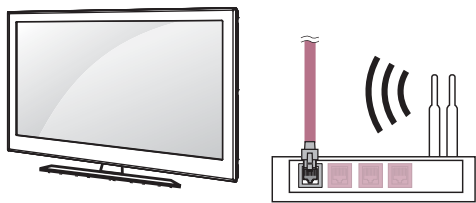

Wireless line sharer

ENGLISH



### NOTE

- For enjoying pictures, music, or video stored on a PC using the router, a wired connection is recommended.
- When the wireless port of the router is used, there may be restrictions on some functions.
- It is recommended that an Access Point (AP) be located more than 1 m (3.28 ft) away from the TV. If the AP is installed closer than 1 m, the magic motion remote control may not perform as expected due to frequency interference.

# TROUBLESHOOTING

## General

Problem	Resolution
Cannot control the TV with the remote control.	<ul style="list-style-type: none"> <li>• Check the remote control sensor on the product and try again.</li> <li>• Check if there is any obstacle between the product and the remote control.</li> <li>• Check if the batteries are still working and properly installed (⊕ to ⊕, ⊖ to ⊖).</li> </ul>
No image display and no sound is produced.	<ul style="list-style-type: none"> <li>• Check if the product is turned on.</li> <li>• Check if the power cord is connected to a wall outlet.</li> <li>• Check if there is a problem in the wall outlet by connecting other products.</li> </ul>
The TV turns off suddenly.	<ul style="list-style-type: none"> <li>• Check the power control settings. The power supply may be interrupted.</li> <li>• Check if the Auto sleep feature is activated in the Time settings.</li> <li>• If there is no signal while the TV is on, the TV will turn off automatically after 15 minutes of inactivity.</li> </ul>

## OPEN SOURCE SOFTWARE NOTICE

To obtain the source code under GPL, LGPL, MPL and other open source licenses, that is contained in this product, please visit <http://opensource.lge.com>.

In addition to the source code, all referred license terms, warranty disclaimers and copyright notices are available for download.

# SPECIFICATIONS

Product specifications may be changed without prior notice due to upgrade of product functions.

Power requirement	USA, Canada, Mexico: AC 120 V ~ 50 / 60 Hz Other Country: AC 100 - 240 V ~ 50 / 60 Hz	
Television System	NTSC-M, ATSC, 64 & 256 QAM	
Program Coverage	VHF 2-13, UHF 14-69, CATV 1-135, DTV 2-69, CADTV 1-135	
External Antenna Impedance	75 $\Omega$	
Environment condition	Operating Temperature	0 - 40 °C
	Operating Humidity	Less than 80 %
	Storage Temperature	-20 - 60 °C
	Storage Humidity	Less than 85 %

MODELS		32LS5700 (32LS5700-UA)	42LS5700 (42LS5700-UA)
		32LS5750 (32LS5750-UA)	42LS5750 (42LS5750-UA)
Dimensions (Width x Height x Depth)	With stand	1171.9 mm x 770.9 mm x 289.8 mm (46.1 inch x 30.3 inch x 11.4 inch)	979.0 mm x 660.0 mm x 269.0 mm (38.5 inch x 25.9 inch x 10.5 inch)
	Without stand	1171.9 mm x 712.2 mm x 52.5 mm (46.1 inch x 28.0 inch x 2.0 inch)	979.0 mm x 593.0 mm x 35.5 mm (38.5 inch x 23.3 inch x 1.3 inch)
Weight	With stand	29.8 kg (65.6 lbs)	15.1 kg (33.2 lbs)
	Without stand	27.5 kg (60.6 lbs)	12.7 kg (27.9 lbs)
Current Value / Power consumption		0.7 A / 70 W	1.1 A / 110 W

MODELS		47LS5700 (47LS5700-UA)	55LS5700 (55LS5700-UA)
		47LS5750 (47LS5750-UA)	55LS5750 (55LS5750-UA)
Dimensions (Width x Height x Depth)	With stand	1089.0 mm x 720.0 mm x 269.0 mm (42.8 inch x 28.3 inch x 10.5 inch)	1171.9 mm x 770.9 mm x 289.8 mm (46.1 inch x 30.3 inch x 11.4 inch)
	Without stand	1089.0 mm x 655.0 mm x 35.5 mm (42.8 inch x 25.7 inch x 1.3 inch)	1171.9 mm x 712.2 mm x 52.5 mm (46.1 inch x 28.0 inch x 2.0 inch)
Weight	With stand	17.8 kg (39.2 lbs)	29.8 kg (65.6 lbs)
	Without stand	15.4 kg (33.9 lbs)	27.5 kg (60.6 lbs)
Current Value / Power consumption		1.4 A / 140 W	1.6 A / 160 W



MODELS		42LM6200 (42LM6200-UA)	47LM6200 (47LM6200-UA)
		42LM6250 (42LM6250-UA)	47LM6250 (47LM6250-UA)
Dimensions (Width x Height x Depth)	With stand	1171.9 mm x 770.9 mm x 289.8 mm (46.1 inch x 30.3 inch x 11.4 inch)	1171.9 mm x 770.9 mm x 289.8 mm (46.1 inch x 30.3 inch x 11.4 inch)
	Without stand	1171.9 mm x 712.2 mm x 52.5 mm (46.1 inch x 28.0 inch x 2.0 inch)	1171.9 mm x 712.2 mm x 52.5 mm (46.1 inch x 28.0 inch x 2.0 inch)
Weight	With stand	29.8 kg (65.6 lbs)	29.8 kg (65.6 lbs)
	Without stand	27.5 kg (60.6 lbs)	27.5 kg (60.6 lbs)
Current Value / Power consumption		1.1 A / 110 W	1.4 A / 140 W
MODELS		55LM6200 (55LM6200-UA)	65LM6200 (65LM6200-UA)
		55LM6250 (55LM6250-UA)	
Dimensions (Width x Height x Depth)	With stand	1390.8 mm x 905.2 mm x 334.7 mm (54.7 inch x 35.6 inch x 13.1 inch)	1171.9 mm x 770.9 mm x 289.8 mm (46.1 inch x 30.3 inch x 11.4 inch)
	Without stand	1390.8 mm x 835.5 mm x 52.5 mm (54.7 inch x 32.8 inch x 2.0 inch)	1171.9 mm x 712.2 mm x 52.5 mm (46.1 inch x 28.0 inch x 2.0 inch)
Weight	With stand	42.6 kg (93.9 lbs)	29.8 kg (65.6 lbs)
	Without stand	38.5 kg (84.8 lbs)	27.5 kg (60.6 lbs)
Current Value / Power consumption		1.6 A / 160 W	1.7 A / 170 W
MODELS		42LM6700 (42LM6700-UA)	47LM6700 (47LM6700-UA)
Dimensions (Width x Height x Depth)	With stand	1171.9 mm x 770.9 mm x 289.8 mm (46.1 inch x 30.3 inch x 11.4 inch)	1171.9 mm x 770.9 mm x 289.8 mm (46.1 inch x 30.3 inch x 11.4 inch)
	Without stand	1171.9 mm x 712.2 mm x 52.5 mm (46.1 inch x 28.0 inch x 2.0 inch)	1171.9 mm x 712.2 mm x 52.5 mm (46.1 inch x 28.0 inch x 2.0 inch)
Weight	With stand	29.8 kg (65.6 lbs)	29.8 kg (65.6 lbs)
	Without stand	27.5 kg (60.6 lbs)	27.5 kg (60.6 lbs)
Current Value / Power consumption		1.1 A / 110 W	1.4 A / 140 W
MODELS		55LM6700 (55LM6700-UA)	
Dimensions (Width x Height x Depth)	With stand	1232.0 mm x 795.0 mm x 54.5 mm (48.5 inch x 31.2 inch x 2.1 inch)	
	Without stand	1232.0 mm x 716.0 mm x 54.5 mm (48.5 inch x 28.1 inch x 2.1 inch)	
Weight	With stand	25.0 kg (55.1 lbs)	
	Without stand	21.3 kg (46.9 lbs)	
Current Value / Power consumption		1.6 A / 160 W	
MODELS		47LM7600 (47LM7600-UA)	55LM7600 (55LM7600-UA)
Dimensions (Width x Height x Depth)	With stand	1171.9 mm x 770.9 mm x 289.8 mm (46.1 inch x 30.3 inch x 11.4 inch)	1171.9 mm x 770.9 mm x 289.8 mm (46.1 inch x 30.3 inch x 11.4 inch)
	Without stand	1171.9 mm x 712.2 mm x 52.5 mm (46.1 inch x 28.0 inch x 2.0 inch)	1171.9 mm x 712.2 mm x 52.5 mm (46.1 inch x 28.0 inch x 2.0 inch)
Weight	With stand	29.8 kg (65.6 lbs)	29.8 kg (65.6 lbs)
	Without stand	27.5 kg (60.6 lbs)	27.5 kg (60.6 lbs)
Current Value / Power consumption		1.4 A / 140 W	1.6 A / 160 W

**Wireless LAN for Broadband/DLNA Adaptor SPEC**

This device only works with compatible LG TV.

<b>Standard</b>	IEEE802.11a/b/g/n
<b>Frequency Range</b>	2402 to 2483 MHz 5150 to 5250 MHz 5725 to 5850 MHz
<b>Modulation</b>	CCK / OFDM / MIMO
<b>Output Power (Typical)</b>	802.11a: 14 dBm 802.11b: 17 dBm 802.11g: 14 dBm 802.11n: 13 dBm
<b>Data rate</b>	802.11a/g: 54 Mbps 802.11b: 11 Mbps 802.11n: 300 Mbps
<b>Antenna Gain (Typical)</b>	2402 to 2483 MHz: 1.17 dBi 5150 to 5250 MHz: 4.67 dBi 5725 to 5850 MHz: 3.30 dBi
<b>Occupied bandwidth</b>	802.11a/b/g: HT20 802.11n: HT20/40

Because band channel used by the country could be different, the user can not change or adjust the operating frequency and this product is set for the regional frequency table.

- FCC ID of Wi-Fi module inside TV  
FCC ID: BEJTWFM003D



ENGLISH

**RF module (BM-LDS302) specification**

For TV By using a 2.4 GHz bandwidth radio frequency(RF).

- Output: 10 dBm or lower
- Maximum Communication Distance: Line of Open Sight approx. 10 m (30 ft)
- Bandwidth: 2.4 GHz (2.400 GHz ~ 2.4835 GHz)
- Transfer Rate: 3 Mbps
- FCC ID of RF module inside TV  
FCC ID: BEJLDS302



# MAINTENANCE

Update and clean your TV regularly to keep the best performance and to extend the product lifespan.

## Cleaning Your TV



### CAUTION

- Make sure to turn the power off and disconnect the power cord and all other cables first.
- When the TV is left unattended and unused for a long time, disconnect the power cord from the wall outlet to prevent possible damage from lightning or power surges.

## Screen and frame

To remove dust or light dirt, wipe the surface with a dry, clean, and soft cloth.

To remove major dirt, wipe the surface with a soft cloth dampened in clean water or a diluted mild detergent. Then wipe immediately with a dry cloth.



### CAUTION

- Do not push, rub, or hit the surface with your fingernail or a sharp object, as this may result in scratches on the screen and image distortions.
- Do not use any chemicals, such as waxes, benzene, alcohol, thinners, insecticides, air fresheners, lubricants, as these may damage the screen's finish and cause discoloration.

## Cabinet and stand

To remove dust or light dirt, wipe the cabinet with a dry, clean, and soft cloth.

To remove major dirt, wipe the cabinet with a soft cloth dampened in a clean water or water containing a small amount of mild detergent. Then wipe immediately with a dry cloth.



### CAUTION

- Do not spray liquid onto the surface. If water enters the TV, it may result in fire, electric shock, or malfunction.
- Do not use any chemicals as this may deteriorate the surface.

## Power cord

Remove the accumulated dust or dirt on the power cord regularly.

## ) **Federal Communications Commission(FCC) Statement**

You are cautioned that changes or modifications not expressly approved by the part responsible

for compliance could void the user's authority to operate the equipment.

This equipment has been tested and found to comply with the limits for a Class B digital device, pursuant to part 15 of the FCC rules.

These limits are designed to provide reasonable protection against harmful interference in a residential installation.

This equipment generates, uses and can radiate radio frequency energy and, if not installed and used in accordance with the instructions, may cause harmful interference to radio communications.

However, there is no guarantee that interference will not occur in a particular installation.

If this equipment does cause harmful interference to radio or television reception, which can be determined by turning the equipment off and on, the user is encouraged to try to correct the

interference by one or more of the following measures:

- . Reorient or relocate the receiving antenna.
- . Increase the separation between the equipment and receiver.
- . Connect the equipment into an outlet on a circuit different from that to which the receiver is connected
- . Consult the dealer or an experienced radio/TV technician for help.

This device complies with Part 15 of the FCC Rules.

Operation is subject to the following two conditions:

- 1) this device may not cause harmful interference, and
- 2) this device must accept any interference received, including interference that may cause undesired operation of the device.

### **Indoor use only**

FCC Caution: Any changes or modifications not expressly approved by the party responsible for compliance could void the user's authority to operate this equipment.

### **Caution: Exposure to Radio Frequency Radiation.**

1. This device and its antenna must not be co-located or operating in conjunction with any other antenna or transmitter.
  
2. This equipment complies with FCC RF radiation exposure limits set forth for an uncontrolled environment. This equipment should be installed and operated with a minimum distance of 20 centimeters between the radiator and your body.



### LG Customer Information Center

For inquires or comments, visit [www.lg.com](http://www.lg.com) or call;

**1-800-243-0000** USA, Consumer User

**1-888-865-3026** USA, Commercial User

**1-888-542-2623** CANADA

Register your product Online!

[www.lg.com](http://www.lg.com)

The model and serial number of the TV is located on the back and/or one side of the TV. Record it below should you ever need service.

MODEL \_\_\_\_\_

SERIAL \_\_\_\_\_

(For LS5700/LM6700/LM7600 series, 42/47/55LS5750, 42/47/55LM6200 USA, Canada, Mexico)



This product qualifies for ENERGY STAR in the "factory default (Home Use)" setting.

Changing the factory default settings or enabling other features may increase power consumption that could exceed the limits necessary to qualify for ENERGY STAR.