



APPENDIX G
: USER'S MANUAL



LG

Life's Good

OWNER'S MANUAL

LED LCD TV / LCD TV / PLASMA TV

Please read this manual carefully before operating the set and retain it for future reference.

LED LCD TV MODELS

19LV2500	32LV3400
22LV2500	32LV3500
26LV2500	37LV3500
32LV2500	42LV3500
26LV2520	47LV3500
32LV2520	55LV3500
42LW5000	32LV3520
47LW5300	42LV3520
55LW5300	55LV5300

LCD TV MODELS

26LK330	32LK450
32LK330	37LK450
32LK430	42LK450
42LK430	47LK450
	42LK520
	47LK520
	55LK520

PLASMA TV MODELS

42PW340	42PW350U
50PW340	50PW350U
42PW350	42PW350R
50PW350	50PW350R
50PZ200	
60PZ200	

LICENSES

Supported licenses may differ by model. For more information about licenses, visit www.lg.com.



Manufactured under license from Dolby Laboratories. "Dolby" and the double-D symbol are trademarks of Dolby Laboratories.



HDMI, the HDMI logo and High-Definition Multimedia Interface are trademarks or registered trademarks of HDMI Licensing LLC.



ABOUT DIVX VIDEO: DivX® is a digital video format created by DivX, Inc. This is an official DivX Certified® device that plays DivX video. Visit www.divx.com for more information and software tools to convert your files into DivX video.

ABOUT DIVX VIDEO-ON-DEMAND: This DivX Certified® device must be registered in order to play purchased DivX Video-on-Demand (VOD) movies. To obtain your registration code, locate the DivX VOD section in your device setup menu. Go to vod.divx.com for more information on how to complete your registration.

"DivX Certified® to play DivX® video up to HD 1080p, including premium content."

"DivX®, DivX Certified® and associated logos are registered trademarks of DivX, Inc. and are used under license."

"Covered by one or more of the following U.S. patents:
7,295,673; 7,460,668; 7,515,710; 7,519,274"



NOTE

- : Plasma TV : LED LCD TV, LCD TV
- Image shown may differ from your TV.
- Your TV's OSD (On Screen Display) may differ slightly from that shown in this manual.

IMPORTANT SAFETY INSTRUCTIONS

Always comply with the following precautions to avoid dangerous situations and ensure peak performance of your product.





WARNING / CAUTION

RISK OF ELECTRIC SHOCK
DO NOT OPEN



TO REDUCE THE RISK OF ELECTRIC SHOCK DO NOT REMOVE COVER (OR BACK). NO USER SERVICEABLE PARTS INSIDE. REFER TO QUALIFIED SERVICE PERSONNEL.

 The lightning flash with arrowhead symbol, within an equilateral triangle, is intended to alert the user to the presence of uninsulated "dangerous voltage" within the product's enclosure that may be of sufficient magnitude to constitute a risk of electric shock to persons.

 The exclamation point within an equilateral triangle is intended to alert the user to the presence of important operating and maintenance (servicing) instructions in the literature accompanying the appliance.

WARNING/CAUTION

- TO REDUCE THE RISK OF FIRE AND ELECTRIC SHOCK, DO NOT EXPOSE THIS PRODUCT TO RAIN OR MOISTURE.

Read these instructions.
Keep these instructions.
Heed all warning.
Follow all instruction.



- Do not use this apparatus near water.



- Clean only with dry cloth.



- Do not block any ventilation openings. Install in accordance with the manufacturer's instructions.



- Do not install near any heat sources such as radiators, heat registers, stoves, or other apparatus (including amplifiers) that produce heat.



- Do not defeat the safety purpose of the polarized or grounding-type plug. A polarized plug has two blades with one wider than the other. A grounding-type plug has two blades and a third grounding prong. The wide blade or the third prong are provided for your safety. If the provided plug does not fit into your outlet, consult an electrician for replacement of the obsolete outlet. (Can differ by country)

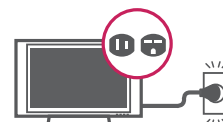

- Protect the power cord from being walked on or pinched particularly at plugs, convenience receptacles, and the point where they exit from the apparatus.



- Only use attachments/accessories specified by the manufacturer.



- Use only with a cart, stand, tripod, bracket, or table specified by the manufacturer, or sold with the apparatus. When a cart is used, use caution when moving the cart/apparatus combination to avoid injury from tip-over.



- Unplug this apparatus during lightning storms or when unused for long periods of time.

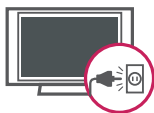

- Refer all servicing to qualified service personnel. Servicing is required when the apparatus has been damaged in any way, such as power-supply cord or plug is damaged, liquid has been spilled or objects have fallen into the apparatus, the apparatus has been exposed to rain or moisture, does not operate normally, or has been dropped.



- Never touch this apparatus or antenna during a thunder or lightning storm.
- When mounting a TV on the wall, make sure not to install the TV by hanging the power and signal cables on the back of the TV.

- Do not allow an impact shock or any objects to fall into the product, and do not drop anything onto the screen.
- **CAUTION** concerning the Power Cord: It is recommended that appliances be placed upon a dedicated circuit; that is, a single outlet circuit which powers only that appliance and has no additional outlets or branch circuits. Check the specification page of this owner's manual to be certain. Do not connect too many appliances to the same AC power outlet as this could result in fire or electric shock. Do not overload wall outlets. Overloaded wall outlets, loose or damaged wall outlets, extension cords, frayed power cords, or damaged or cracked wire insulation are dangerous. Any of these conditions could result in electric shock or fire. Periodically examine the cord of your appliance, and if its appearance indicates damage or deterioration, unplug it, discontinue use of the appliance, and have the cord replaced with an exact replacement part by an authorized service. Protect the power cord from physical or mechanical abuse, such as being twisted, kinked, pinched, closed in a door, or walked upon. Pay particular attention to plugs, wall outlets, and the point where the cord exits the appliance. Do not move the TV with the power cord plugged in. Do not use a damaged or loose power cord. Be sure do grasp the plug when unplugging the power cord. Do not pull on the power cord to unplug the TV.



- **Warning** - To reduce the risk of fire or electrical shock, do not expose this product to rain, moisture or other liquids. Do not touch the TV with wet hands. Do not install this product near flammable objects such as gasoline or candles, or expose the TV to direct air conditioning.



- Do not expose to dripping or splashing and do not place objects filled with liquids, such as vases, cups, etc. on or over the apparatus (e.g. on shelves above the unit).



Grounding

Ensure that you connect the earth ground wire to prevent possible electric shock (i.e. a TV with a three-prong grounded AC plug must be connected to a three-prong grounded AC outlet). If grounding methods are not possible, have a qualified electrician install a separate circuit breaker. Do not try to ground the unit by connecting it to telephone wires, lightening rods, or gas pipes.

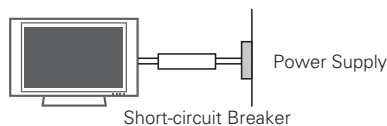

DISCONNECTING DEVICE FROM THE MAIN POWER

The power outlet must remain readily accessed in the event the device needs to be unplugged.

- As long as this unit is connected to the AC wall outlet, it is not disconnected from the AC power source even if the unit is turned off.
- Do not attempt to modify this product in any way without written authorization from LG Electronics. Unauthorized modification could void the user’s authority to operate this product.

ANTENNAS Outdoor antenna grounding

(Can differ by country):

If an outdoor antenna is installed, follow the precautions below. An outdoor antenna system should not be located in the vicinity of overhead power lines or other electric light or power circuits, or where it can come in contact with such power lines or circuits as death or serious injury can occur. Be sure the antenna system is grounded so as to provide some protection against voltage surges and built-up static charges. Section 810 of the National Electrical Code (NEC) in the

U.S.A. provides information with respect to proper grounding of the mast and supporting structure, grounding of the lead-in wire to an antenna discharge unit, size of grounding conductors, location of antenna discharge unit, connection to grounding electrodes and requirements for the grounding electrode.

Antenna grounding according to the National Electrical Code, ANSI/NFPA 70

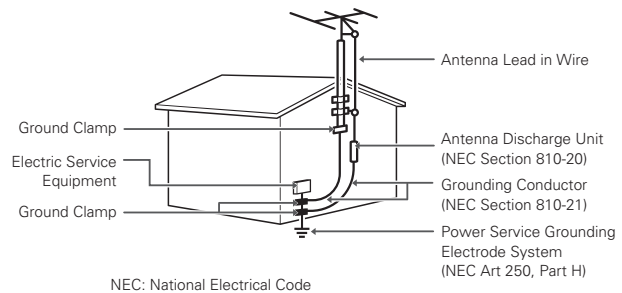

Cleaning

When cleaning, unplug the power cord and wipe gently with a soft cloth to prevent scratching. Do not spray water or other liquids directly on the TV as electric shock may occur. Do not clean with chemicals such as alcohol, thinners or benzine.

Moving

Make sure the product is turned off, unplugged and all cables have been removed. It may take 2 or more people to carry larger TVs. Do not press or put stress on the front panel of the TV.

Ventilation

Install your TV where there is proper ventilation. Do not install in a confined space such as a bookcase. Do not cover the product with cloth or other materials while plugged. Do not install in excessively dusty places.

- If you smell smoke or other odors coming from the TV, unplug the power cord contact an authorized service center.
- Do not press strongly upon the panel with hand or sharp object such as nail, pencil or pen, or make a scratch on it.
- Keep the product away from direct sunlight.



- **Dot Defect**

The Plasma or LCD panel is a high technology product with resolution of two million to six million pixels. In a very few cases, you could see fine dots on the screen while you're viewing the TV. Those dots are deactivated pixels and do not affect the performance and reliability of the TV.

- **Generated Sound**

"Cracking" noise: A cracking noise that occurs when watching or turning off the TV is generated by plastic thermal contraction due to temperature and humidity. This noise is common for products where thermal deformation is required.

Electrical circuit humming/panel buzzing: A low level noise is generated from a high-speed switching circuit, which supplies a large amount of current to operate a product. It varies depending on the product.

This generated sound does not affect the performance and reliability of the product.

- Take care not to touch the ventilation openings. When watching the TV for a long period, the ventilation openings may become hot. This does not affect the performance of the product or cause defects in the product.

- **Viewing 3D Imaging (For 3D TV)**

- When viewing 3D imaging, watch the TV from an effective viewing angle and within the appropriate distance. If you exceed this viewing angle or distance, you may not be able to view the 3D imaging. Furthermore, the 3D imaging may not display if it is viewed while you are lying down.
- If you watch the 3D imaging too closely or for a long period of time, it may harm your eyesight.
- Watching the TV or playing video games that incorporate 3D imaging with the 3D glasses for a long period of time can cause drowsiness, headaches or fatigue to you and/or your eyes. If you have a headache, or otherwise feel fatigued or drowsy, stop watching the TV and take a rest.
- Pregnant woman, seniors, persons with heart problems or persons who experience frequent drowsiness should refrain from watching 3D TV.
- Some 3D imaging may cause you to duck or dodge the image displayed in the video.

Therefore, it is best if you do not watch 3D TV near fragile objects or near any objects that can be knocked over easily.

- Please prevent children under the age of 5 from watching 3D TV. It may affect their vision development.
- Warning for photosensitization seizure: Some viewers may experience a seizure or epilepsy when exposed to certain factors, including flashing lights or images in TV or video games. If you or anybody from your family has a history of epilepsy or seizure, please consult with your doctor before watching 3D TV.

Also certain symptoms can occur in unspecified conditions without any previous history. If you experience any of the following symptoms, immediately stop watching the 3D imaging and consult a doctor: dizziness or lightheadedness, visual transition or altered vision, visual or facial instability, such as eye or muscle twitching, unconscious action, convulsion, loss of conscience, confusion or disorientation, loss of directional sense, cramps, or nausea. Parents should monitor their children, including teenagers, for these symptoms as they may be more sensitive to the effects of watching 3D TV.

Risk of photosensitization seizure can be reduced with the following actions.

- Take frequent breaks from watching 3D TV.
- For those who have vision that is different in each eye, they should watch the TV after taking vision correction measures.
- Watch the TV so that your eyes are on the same level as the 3D screen and refrain from sitting too closely to the TV.
- Do not watch the 3D imaging when tired or sick, and avoid watching the 3D imaging for a long period of time.
- Do not wear the 3D glasses for any other purpose than viewing 3D imaging on a 3D TV.
- Some viewers may feel disoriented after watching 3D TV. Therefore, after you watch 3D TV, take a moment to regain awareness of your situation before moving.



If the TV feels cold to the touch, there may be a small “flicker” when it is turned on. This is normal, there is nothing wrong with TV. Some minute dot defects may be visible on the screen, appearing as tiny red, green, or blue spots. However, they have no adverse effect on the TV’s performance. Avoid touching the LCD screen or holding your finger(s) against it for long periods of time. Doing so may produce some temporary distortion effects on the screen.

DISPOSAL (Hg lamp only used in LCD TVs)

The fluorescent lamp used in this product contains a small amount of mercury. Do not dispose of this product with general household waste. Disposal of this product must be carried out in accordance to the regulations of your local authority.

For USA and Canada

FCC NOTICE

This equipment has been tested and found to comply with the limits for a Class B digital device, pursuant to Part 15 of the FCC Rules. These limits are designed to provide reasonable protection against harmful interference in a residential installation. This equipment generates, uses and can radiate radio frequency energy and, if not installed and used in accordance with the instructions, may cause harmful interference to radio communications. However, there is no guarantee that interference will not occur in a particular installation. If this equipment does cause harmful interference to radio or television reception, which can be determined by turning the equipment off and on, the user is encouraged to try to correct the interference by one or more of the following measures:

- Reorient or relocate the receiving antenna.
- Increase the separation between the equipment and the receiver.
- Connect the equipment to an outlet on a circuit different from that to which the receiver is connected.
- Consult the dealer or an experienced radio/TV technician for help.

This device complies with part 15 of the FCC Rules. Operation is subject to the following two conditions: (1) this device may not cause harmful interference and (2) this device must accept any interference received, including interference that may cause undesired operation of the device.

Any changes or modifications in construction of this device which are not expressly approved by the party responsible for compliance could void the user’s authority to operate the equipment.

NOTE TO CABLE/TV INSTALLER

This reminder is provided to call the CATV system installer’s attention to Article 820-40 of the National Electric Code (U.S.A.). The code provides guidelines for proper grounding and, in particular, specifies that the cable ground shall be connected to the grounding system of the building, as close to the point of the cable entry as practical.

TABLE OF CONTENTS

2 LICENSES

3 IMPORTANT SAFETY INSTRUCTIONS

8 TABLE OF CONTENTS

10 ASSEMBLING AND PREPARING

- 10 Unpacking
- 14 Optional Extras
- 15 Parts and buttons
- 24 Lifting and moving the TV
- 24 Setting up the TV
 - 24 - Attaching the stand
 - 29 - Mounting on a table
 - 31 - Mounting on a wall
 - 32 - Tidying cables

33 REMOTE CONTROL

37 WATCHING TV

- 37 Connecting to an antenna or cable
 - 37 - Connecting an antenna or basic cable
 - 37 - Connecting a cable box
- 38 Connecting to the AC/DC adapter
- 38 Turning the TV on for the first time
- 39 Watching TV
- 39 Managing channels
 - 39 - Setting up channels
 - 40 - Using favorite channels
 - 41 - Checking current program info
- 43 Using additional options
 - 43 - Adjusting aspect ratio
 - 44 - Changing AV modes
 - 44 - Using the input list
 - 45 - Locking the buttons on the TV (Child Lock)

- 45 Using the quick menu
- 46 Using the customer support
 - 46 - Testing the Picture / Sound
 - 46 - Using the product or service information

47 3D IMAGING (FOR 3D TV)

- 47 3D Technology
 - 48 - When using 3D Glasses
 - 48 - 3D Imaging Viewing Range
- 49 Viewing 3D Imaging

51 ENTERTAINMENT

- 51 - Connecting USB storage devices
- 52 - Browsing files
- 54 - Viewing Videos
- 57 - DivX registration code
- 58 - Viewing Photos
- 60 - Listening to music

62 CUSTOMIZING TV SETTINGS

- 62 The Main Menu
- 63 Customizing Settings
 - 63 - CHANNEL Settings
 - 64 - PICTURE Settings
 - 68 - AUDIO Settings
 - 69 - TIME Settings
 - 70 - LOCK Settings
 - 72 - OPTION Settings

74 MAKING CONNECTIONS

- 75 Connection Overview
- 76 Connecting to a HD receiver, DVD or VCR player
 - 76 - HDMI Connection
 - 76 - DVI to HDMI Connection
 - 77 - Component Connection
 - 77 - Composite Connection

- 78 Connecting to a PC
- 78 - HDMI Connection
- 78 - DVI to HDMI Connection
- 79 - RGB Connection
- 80 Connecting to an Audio System
- 80 - Digital optical audio connection
- 80 Connecting to a USB
- 80 Connecting to a Headphone (🎧)
- 81 SIMPLINK Connection
- 81 - Activating and Using the SIMPLINK menus

82 MAINTENANCE

- 82 Cleaning Your TV
- 82 - Screen and frame
- 82 - Cabinet and stand
- 82 - Power cord
- 82 Preventing “Image burn” or “Burn-in” on your TV screen

83 TROUBLESHOOTING

85 SPECIFICATIONS

92 IR CODES

94 EXTERNAL CONTROL DEVICE SETUP

102 OPEN SOURCE LICENSE

ASSEMBLING AND PREPARING

Unpacking

Check your product box for the following items. If there are any missing accessories, contact the local dealer where you purchased your product. The illustrations in this manual may differ from the actual product and item.

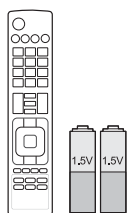

Remote control and batteries (AAA)

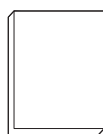

Owner's manual



CD manual



Polishing cloth¹
(Depending on model)

- 1 Gently wipe the spots on the cabinet with the polishing cloth.

PW340, PW350, PW350U, PW350R, PZ200 series

(Other models)

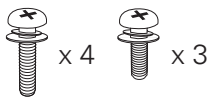

M4 x 26 M5 x 14.5

Screw for assembly

(For 60PZ200)

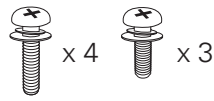

M4 x 28 M5 x 24

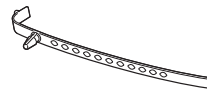

Cable holder



Power Cord holder

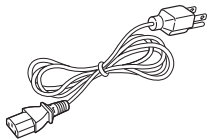

Power Cord

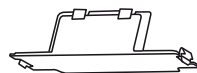

Protection cover

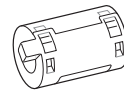

Ferrite core
(Depending on model)



Protection cover tape

32LV2500, 32LV2520, LV3400, LV3500, LV3520, LW5000, LW5300 series

(32LV2500, 32LV2520) (Other models) (Except LV3400 series)



M4 x 14 M4 x 12

Screw for assembly

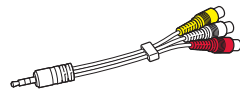

Composite gender cable

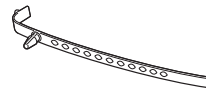

Cable holder
(Depending on model)



Screw for fixing

(For 32LV2500, 32LV2520, 32LV3400, 32/37LV3500, 32LV3520)

(For LW5000, LW5300 series)



3D Glasses¹
(AG-P110, AG-F110)

1 The number of 3D glasses may differ depending on the model.

19/22/26LV2500, 26LV2520 series

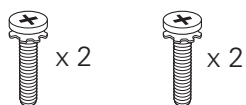

M4 x 16 M4 x 6

Screw for assembly

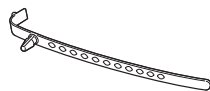

Cable holder
(Depending on model)

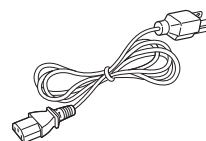

Power Cord

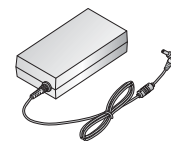

AC/DC Adapter

LK330, LK430, LK450, LK520 series

(Except 47LK450,
47/55LK520)

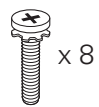

M4 x 20

Screw for assembly

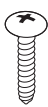

Screw for fixing

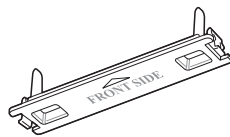

Protection cover

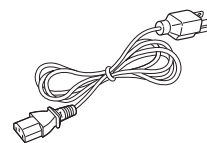

Power Cord



CAUTION

- Do not use any unapproved items to ensure the safety and product life span.
- Any damages or injuries by using unapproved items are not covered by the warranty.

NOTE

- The items supplied with your product may vary depending on the model.
- Product specifications or contents of this manual may be changed without prior notice due to upgrade of product functions.
- () How to use the ferrite core

1 Use the ferrite core to reduce the electromagnetic interference in the PC audio cable.
Wind the PC audio cable on the ferrite core thrice. Place the ferrite core close to the TV.

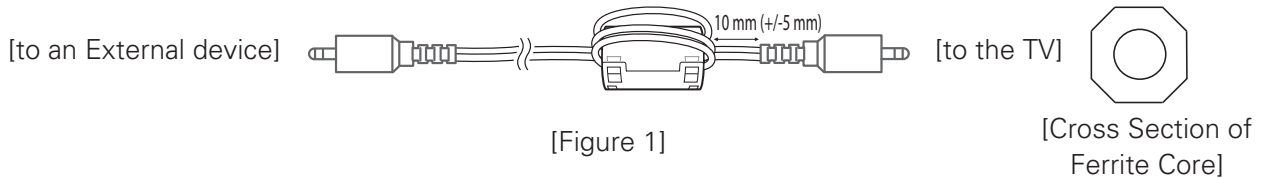

2 Use the ferrite core to reduce the electromagnetic interference in the power cable.
Wind the power cable on the ferrite core once. Place the ferrite core close to the TV.

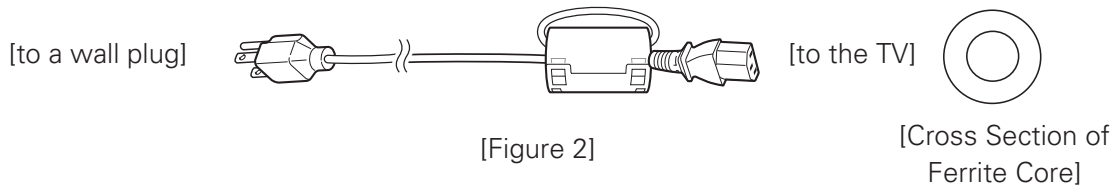

3 Use the ferrite core to reduce the electromagnetic interference in the power cable.
Wind the power cable on the ferrite core once. Place the ferrite core close to the TV and a wall plug.

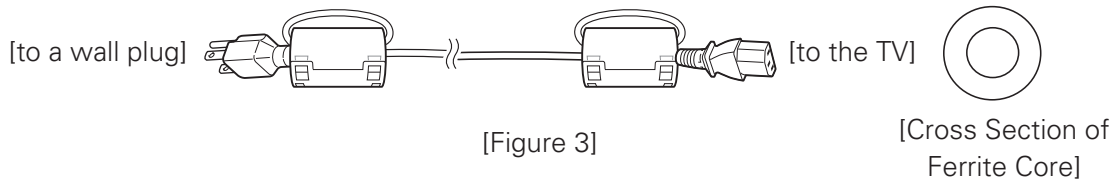

- If there is one ferrite core, follow as shown in Figure 1.
- If there are two ferrite cores, follow as shown in Figures 1 and 2.
- If there are three ferrite cores, follow as shown in Figures 1 and 3.

- () For an optimal connection, HDMI cables and USB devices should have bezels less than 10 mm (0.39 inches) thick and 18 mm (0.7 inches) width.

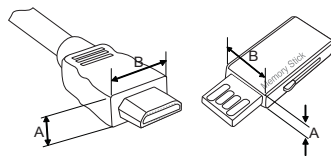

*A ≦ 10 mm (0.39 inches)

*B ≦ 18 mm (0.7 inches)

Optional Extras

Optional extras can be changed or modified for quality improvement without any notification.

Contact your dealer for buying these items.

This device only works with compatible LG Plasma TV, LED LCD TV or LCD TV.



3D Glasses¹
(AG-S230, AG-S250, AG-S270)



3D Glasses²
(AG-P110, AG-F110)

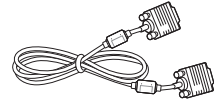

D-sub 15 pin signal cable³

- 1 Supports PW340, PW350, PW350R, PW350U, PZ200 series
- 2 Supports LW5000, LW5300 series
- 3 When using the VGA (D-sub 15 pin signal cable) PC connection, use the shielded signal interface cable with a ferrite core to maintain standards compliance for the product.

Parts and buttons

PW340, PW350, PW350U, PW350R, PZ200 series

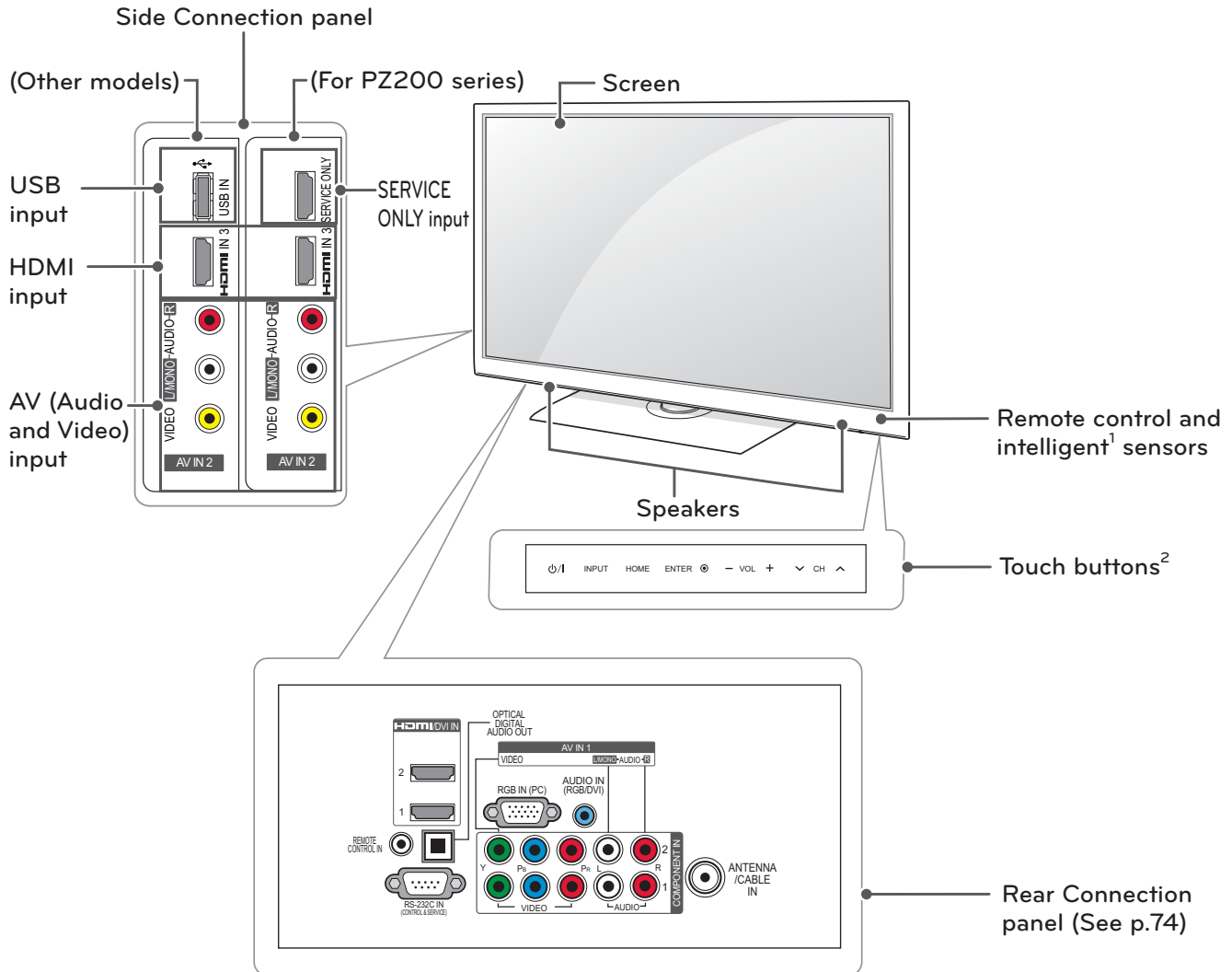

Touch button ²	Description
⏻/⏻	Turns the power on or off.
INPUT	Changes the input source.
HOME	Accesses the main menus, or saves your input and exits the menus.
ENTER ◉	Selects the highlighted menu option or confirms an input.
- VOL +	Adjusts the volume level.
∨ CH ^	Scrolls through the saved channels.

- 1 Intelligent sensor - Adjusts the image quality and brightness based on the surrounding environment.
- 2 All of the buttons are touch sensitive and can be operated through simple touch with your finger.

32LV2500, 32LV2520, LV3500, LV3520, LW5000, LW5300 series

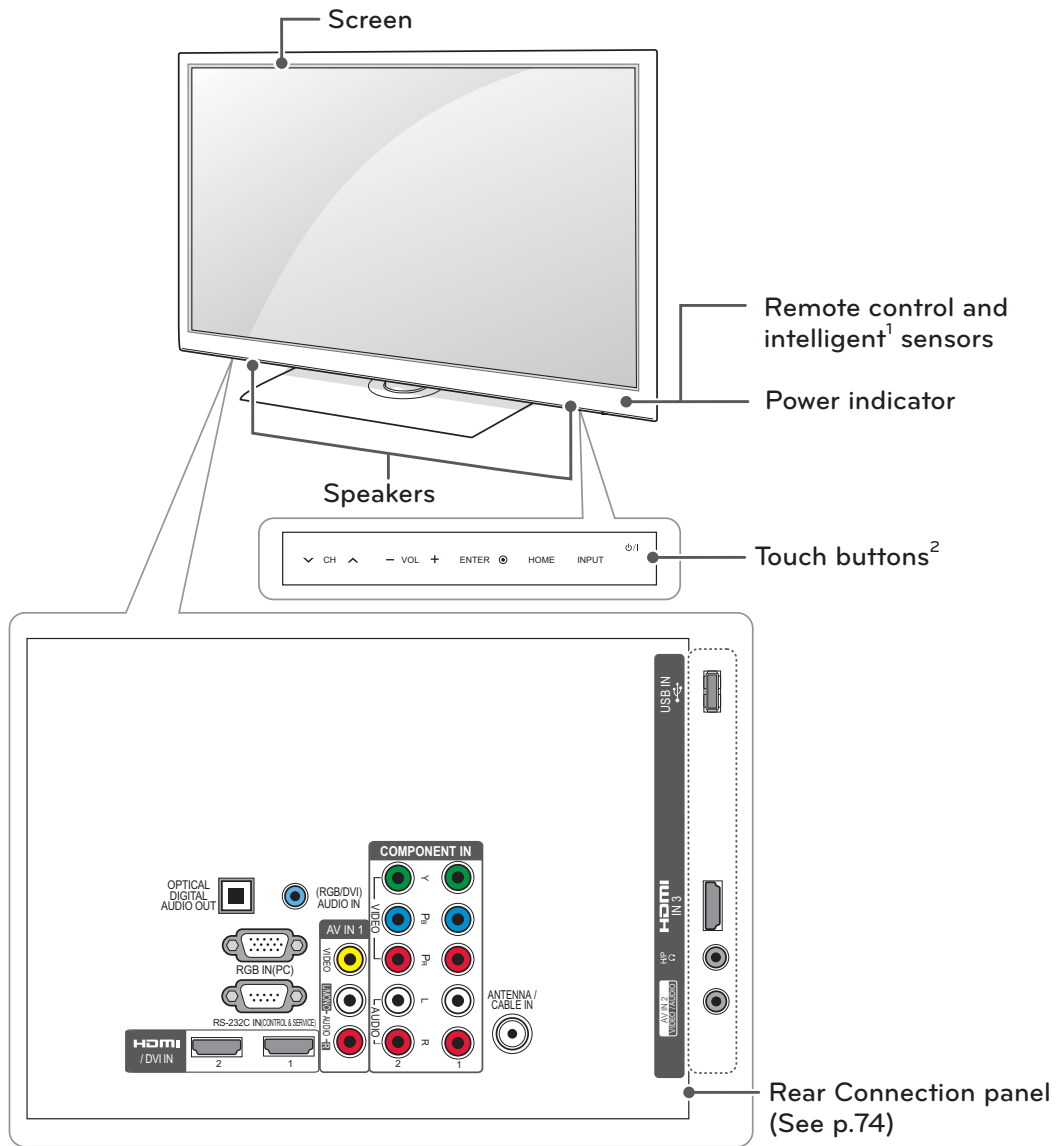

ENGLISH

Touch button ²	Description
⏻/⏪	Turns the power on or off.
INPUT	Changes the input source.
HOME	Accesses the main menus, or saves your input and exits the menus.
ENTER ◉	Selects the highlighted menu option or confirms an input.
- VOL +	Adjusts the volume level.
√ CH ^	Scrolls through the saved channels.

- 1 Intelligent sensor - Adjusts the image quality and brightness based on the surrounding environment.
- 2 All of the buttons are touch sensitive and can be operated through simple touch with your finger.

NOTE

- You can set the power indicator light to on or off by selecting **OPTION** in the main menus.

LV3400 series

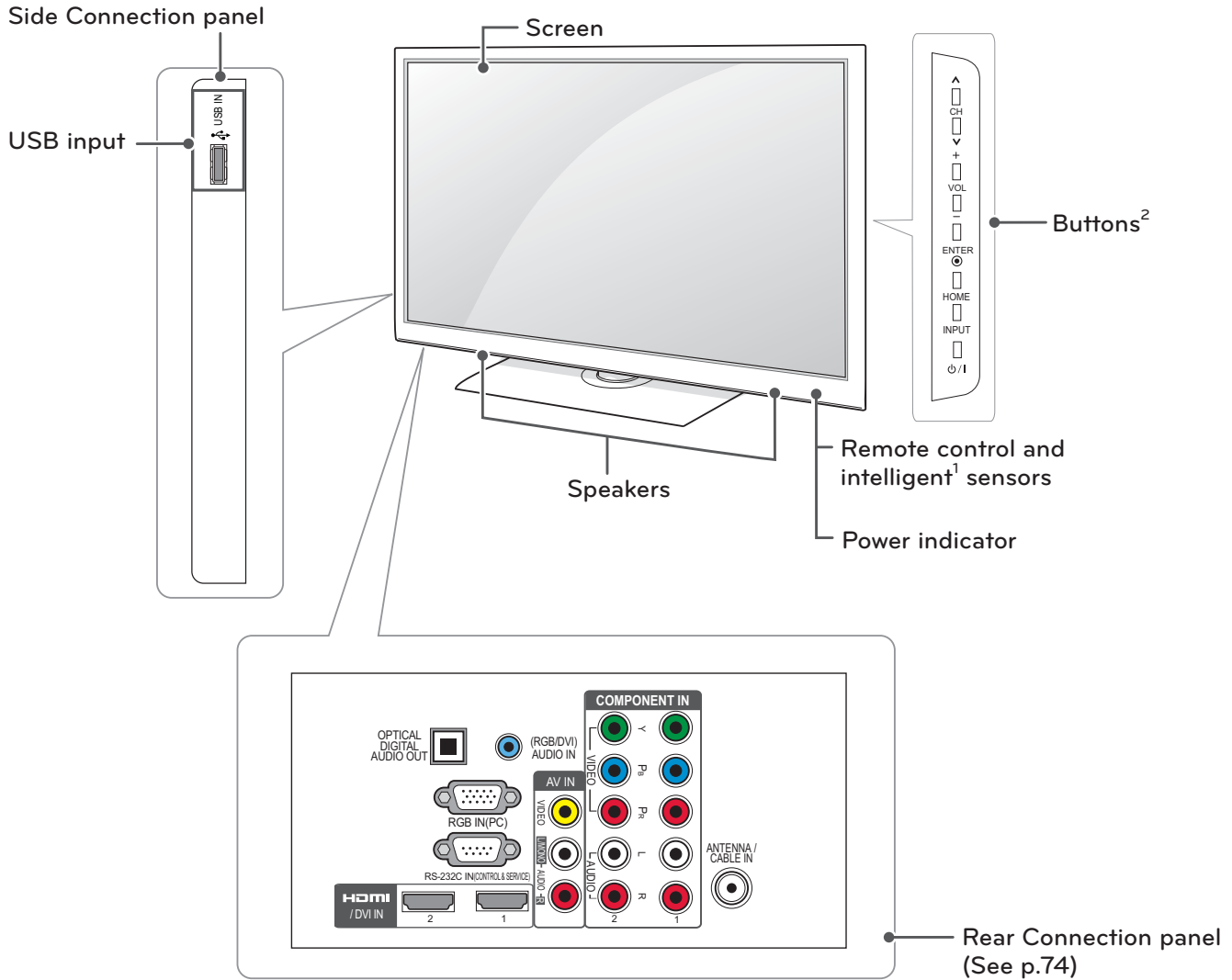

ENGLISH

Button ²	Description
⏻ / I	Turns the power on or off.
INPUT	Changes the input source.
HOME	Accesses the main menus, or saves your input and exits the menus.
ENTER ●	Selects the highlighted menu option or confirms an input.
- VOL +	Adjusts the volume level.
∨ CH ^	Scrolls through the saved channels.

1 Intelligent sensor - Adjusts the image quality and brightness based on the surrounding environment.

NOTE

- You can set the power indicator light to on or off by selecting **OPTION** in the main menus.

19/22/26LV2500, 26LV2520 series

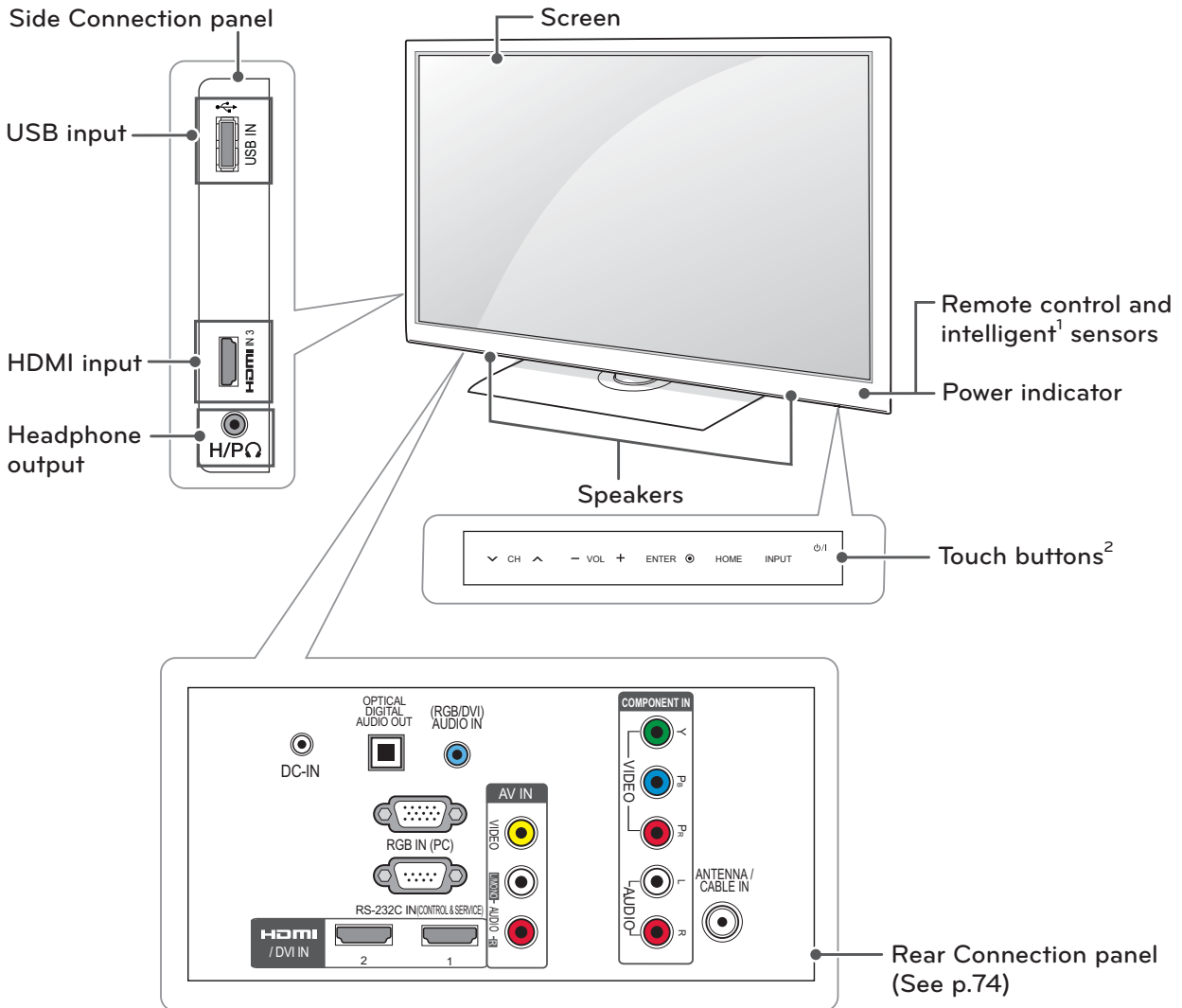

ENGLISH

Touch button ²	Description
⏻/⏪	Turns the power on or off.
INPUT	Changes the input source.
HOME	Accesses the main menus, or saves your input and exits the menus.
ENTER ◉	Selects the highlighted menu option or confirms an input.
- VOL +	Adjusts the volume level.
√ CH ^	Scrolls through the saved channels.

- 1 Intelligent sensor - Adjusts the image quality and brightness based on the surrounding environment.
- 2 All of the buttons are touch sensitive and can be operated through simple touch with your finger.

NOTE

- You can set the power indicator light to on or off by selecting **OPTION** in the main menus.

LK450 series

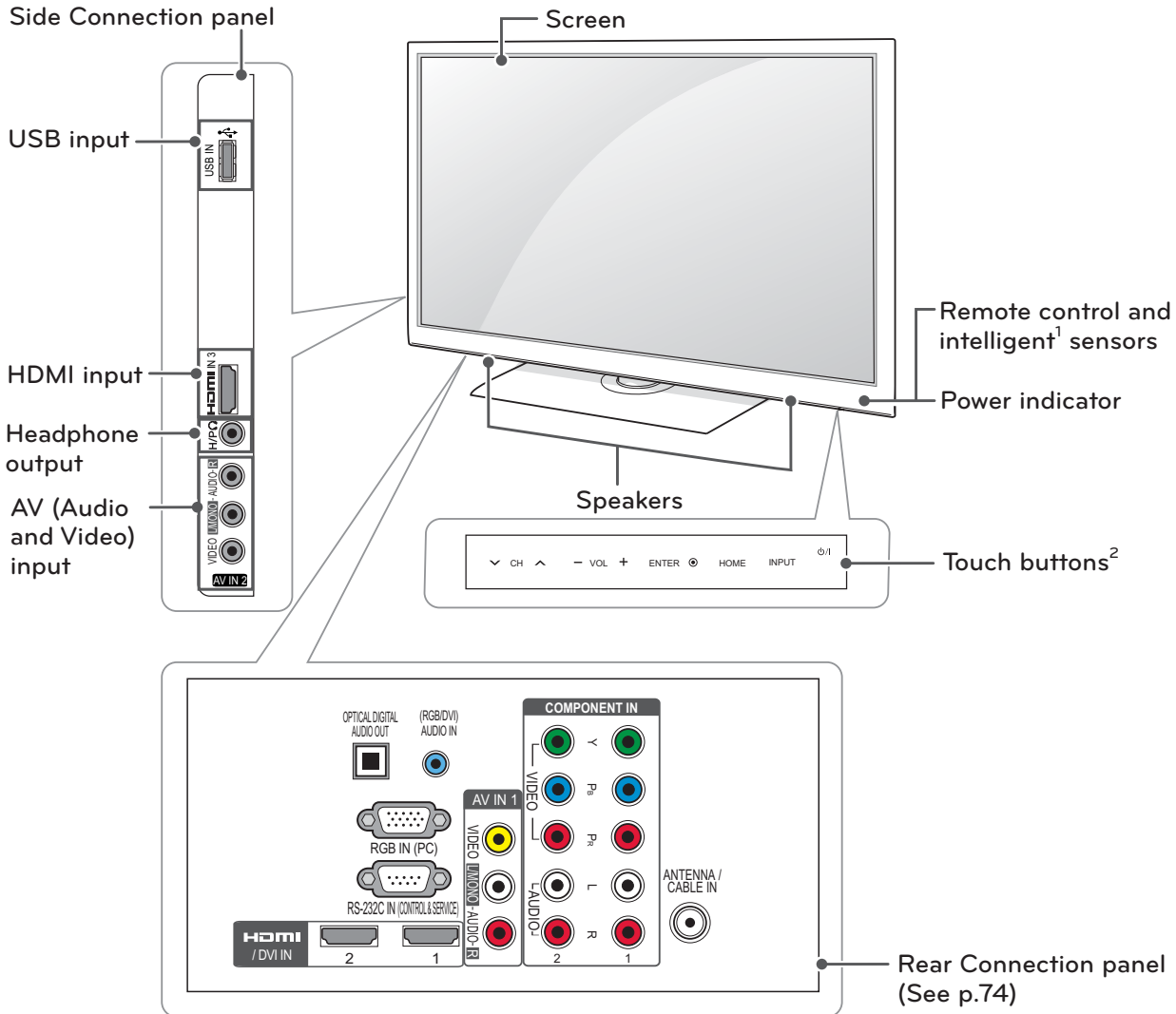

ENGLISH

Touch button ²	Description
⏻ / I	Turns the power on or off.
INPUT	Changes the input source.
HOME	Accesses the main menus, or saves your input and exits the menus.
ENTER ●	Selects the highlighted menu option or confirms an input.
- VOL +	Adjusts the volume level.
√ CH ^	Scrolls through the saved channels.

- 1 Intelligent sensor - Adjusts the image quality and brightness based on the surrounding environment.
- 2 All of the buttons are touch sensitive and can be operated through simple touch with your finger.

NOTE

- You can set the power indicator light to on or off by selecting **OPTION** in the main menus.

26LK330

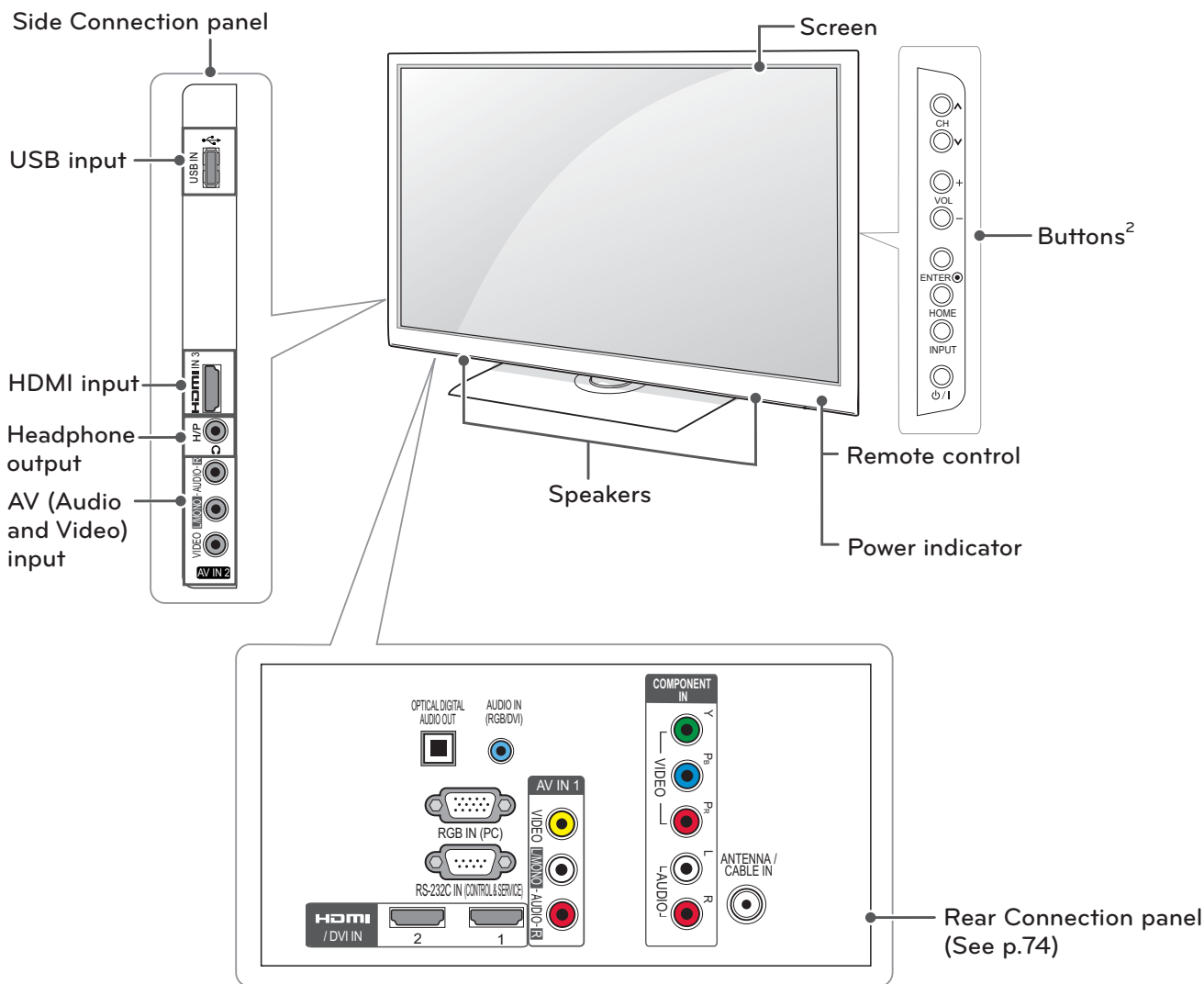

ENGLISH

Button ²	Description
⏻/⏪	Turns the power on or off.
INPUT	Changes the input source.
HOME	Accesses the main menus, or saves your input and exits the menus.
ENTER ◉	Selects the highlighted menu option or confirms an input.
- VOL +	Adjusts the volume level.
√ CH ^	Scrolls through the saved channels.



NOTE

- You can set the power indicator light to on or off by selecting **OPTION** in the main menus.

32LK330

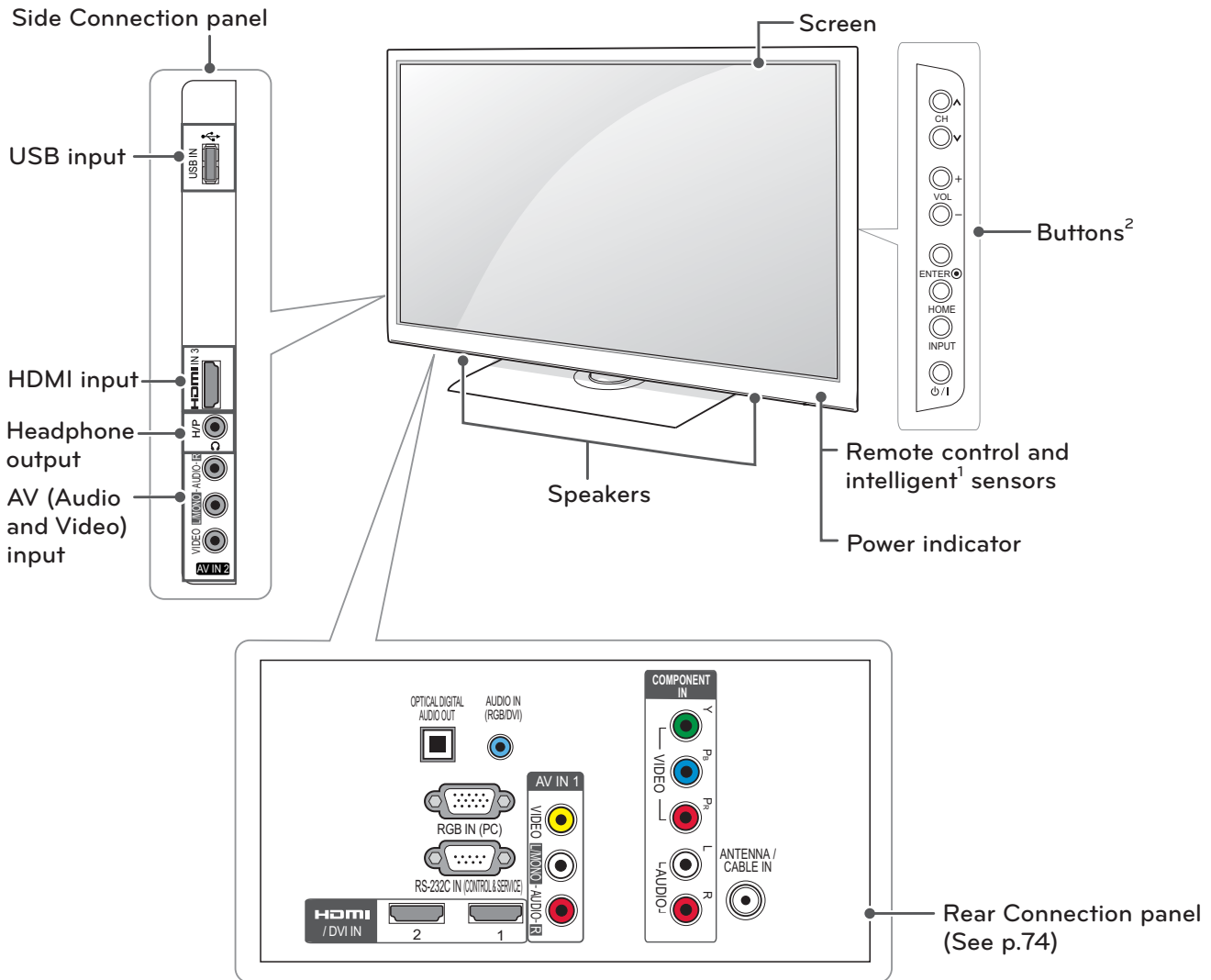

ENGLISH

Button ²	Description
⏻ / I	Turns the power on or off.
INPUT	Changes the input source.
HOME	Accesses the main menus, or saves your input and exits the menus.
ENTER ◉	Selects the highlighted menu option or confirms an input.
- VOL +	Adjusts the volume level.
√ CH ^	Scrolls through the saved channels.

1 Intelligent sensor - Adjusts the image quality and brightness based on the surrounding environment.

NOTE

- You can set the power indicator light to on or off by selecting **OPTION** in the main menus.

LK430 series

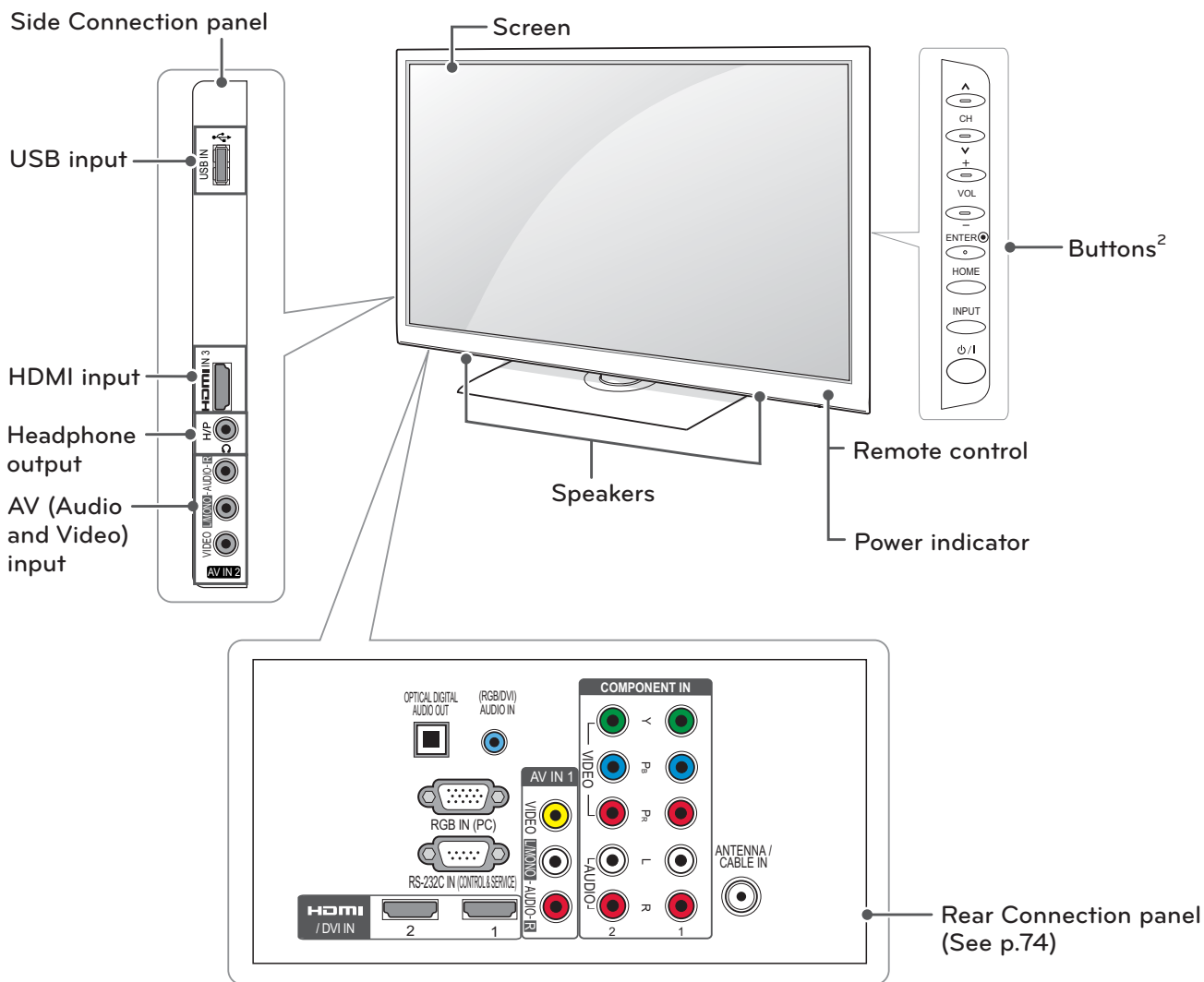

ENGLISH

Button ²	Description
⏻/⏻	Turns the power on or off.
INPUT	Changes the input source.
HOME	Accesses the main menus, or saves your input and exits the menus.
ENTER ◉	Selects the highlighted menu option or confirms an input.
- VOL +	Adjusts the volume level.
∨ CH ∧	Scrolls through the saved channels.



NOTE

- You can set the power indicator light to on or off by selecting **OPTION** in the main menus.

LK520 series

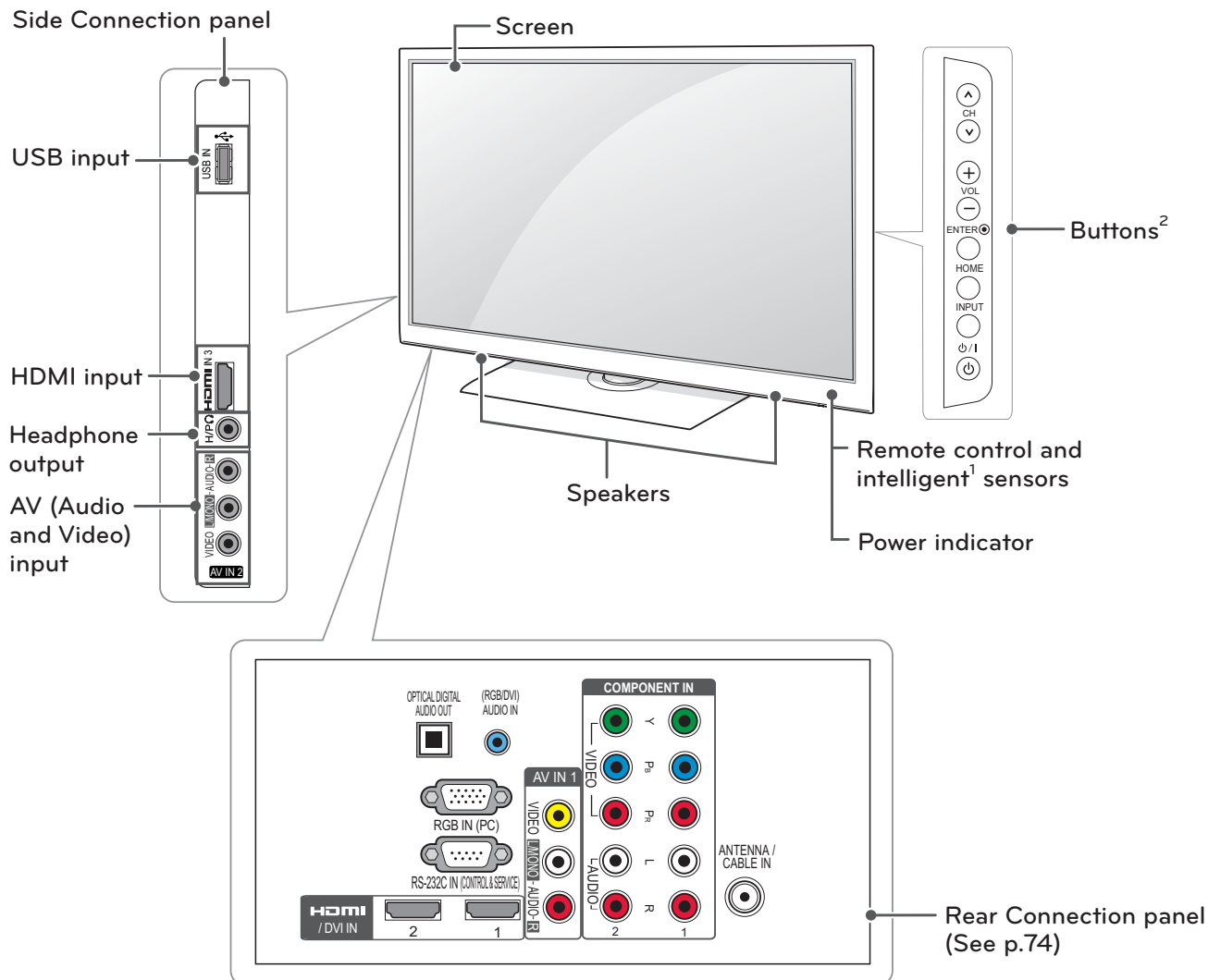

ENGLISH

Button ²	Description
⏻ / I	Turns the power on or off.
INPUT	Changes the input source.
HOME	Accesses the main menus, or saves your input and exits the menus.
ENTER ◉	Selects the highlighted menu option or confirms an input.
- VOL +	Adjusts the volume level.
√ CH ^	Scrolls through the saved channels.

1 Intelligent sensor - Adjusts the image quality and brightness based on the surrounding environment.

NOTE

- You can set the power indicator light to on or off by selecting **OPTION** in the main menus.

Lifting and moving the TV

When moving or lifting the TV, read the following to prevent the TV from being scratched or damaged and for safe transportation regardless of its type and size.



CAUTION

- Avoid touching the screen at all times, as this may result in damage to the screen.

- It is recommended to move the TV in the box or packing material that the TV originally came in.
- Before moving or lifting the TV, disconnect the power cord and all cables.
- When holding the TV, the screen should face away from you to prevent damage.



- Hold the top and bottom of the TV frame firmly. Make sure not to hold the transparent part, speaker, or speaker grill area.

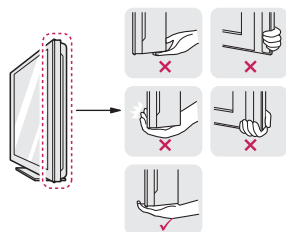

- When transporting a large TV, there should be at least 2 people.
- When transporting the TV by hand, hold the TV as shown in the following illustration.

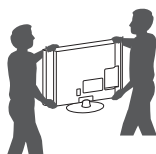

- When transporting the TV, do not expose the TV to jolts or excessive vibration.
- When transporting the TV, keep the TV upright, never turn the TV on its side or tilt towards the left or right.

Setting up the TV

Put your TV on a pedestal stand and mount the TV on a table or wall.

Attaching the stand

If you are not mounting the TV to a wall, use the following instructions to attach the stand.

PW340, PW350, PW350U, PW350R, PZ200 series

- 1 Lay the TV with the screen side down on a flat surface.



CAUTION

- Lay a foam mat or soft protective cloth on the surface to protect the screen from damage. Make sure no objects press against the screen.

- 2 Assemble the parts of the STAND BODY with the STAND BASE of the TV.

Model	Screw for assembly	Number of screws
42/50PW340 42/50PW350 42/50PW350U 42/50PW350R 50PZ200	M5 x 14.5	3
60PZ200	M5 x 24	3

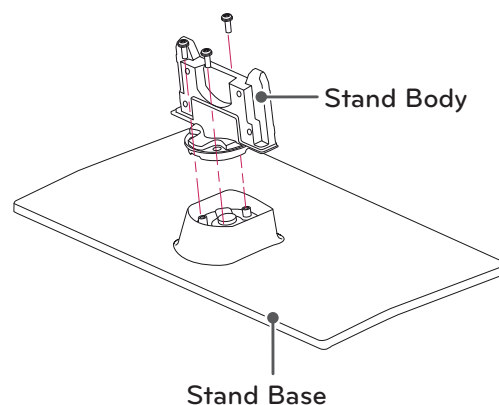

- 3 Secure the TV and the stand with the 4 screws.

Model	Screw for assembly	Number of screws
42/50PW340 42/50PW350 42/50PW350U 42/50PW350R 50PZ200	M4 x 26	4
60PZ200	M4 x 28	4

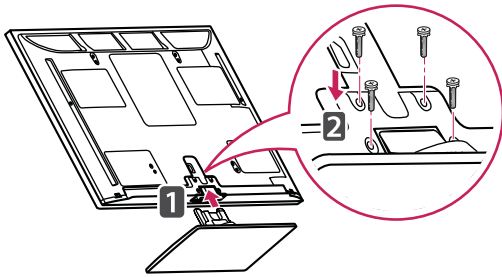

CAUTION

- Tighten the screws firmly to prevent the TV from tilting forward. Do not over tighten.

To detach the stand,

- 1 Lay the TV with the screen side down on a flat surface.
- 2 Remove the 4 screws and pull the stand away from the TV.

Model	Screw for assembly	Number of screws
42/50PW340 42/50PW350 42/50PW350U 42/50PW350R 50PZ200	M4 x 26	4
60PZ200	M4 x 28	4

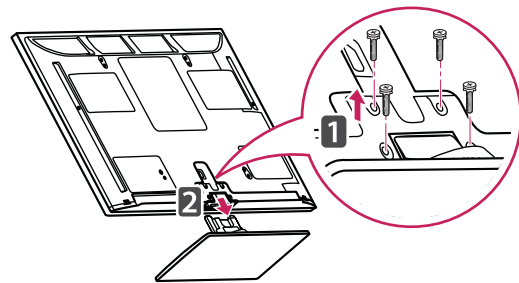

- 3 Push the supplied protection cover into the opening at the bottom of the TV until it locks in place.

Attach the protection cover tape.

- This will protect the opening from accumulating dust and dirt.
- When installing the wall mounting bracket, use the Protection cover.

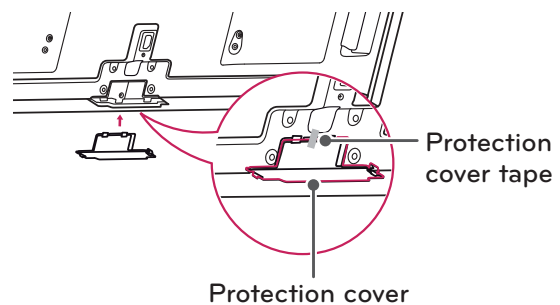

32LV2500, 32LV2520, LV3400, LV3500,
LV3520, LW5000, LW5300 series

- 1 Lay the TV with the screen side down on a flat surface.



CAUTION

- Lay a foam mat or soft protective cloth on the surface to protect the screen from damage. Make sure no objects press against the screen.

- 2 Assemble the parts of the STAND BODY with the STAND BASE of the TV.

Model	Screw for assembly	Number of screws
32LV2500 32LV2520	M4 x 14	4

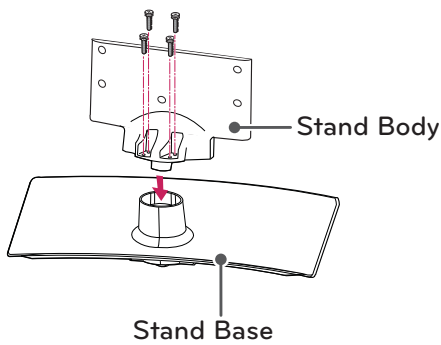

Model	Screw for assembly	Number of screws
LV3400, LV3500, LV3520, LW5000, LW5300 series	M4 x 12	4

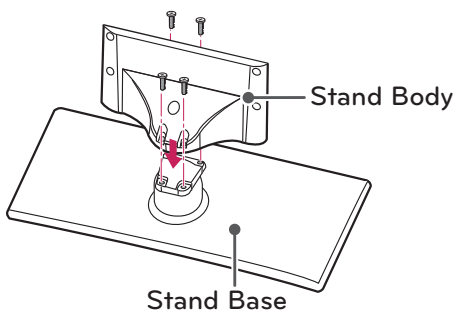

- 3 Secure the TV and the stand with the 4 screws.

Model	Screw for assembly	Number of screws
32LV2500 32LV2520	M4 x 14	4
LV3400, LV3500, LV3520, LW5000, LW5300 series	M4 x 12	4

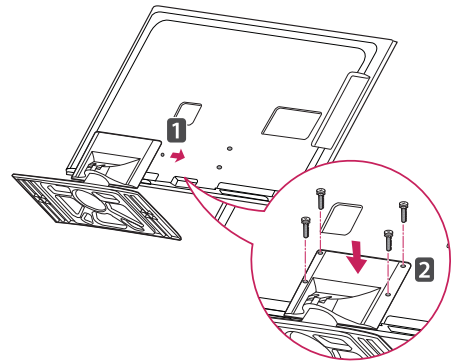

CAUTION

- Tighten the screws firmly to prevent the TV from tilting forward. Do not over tighten.

To detach the stand,

- 1 Lay the TV with the screen side down on a flat surface.
- 2 Remove the 4 screws and pull the stand away from the TV.

Model	Screw for assembly	Number of screws
32LV2500 32LV2520	M4 x 14	4
LV3400, LV3500, LV3520, LW5000, LW5300 series	M4 x 12	4

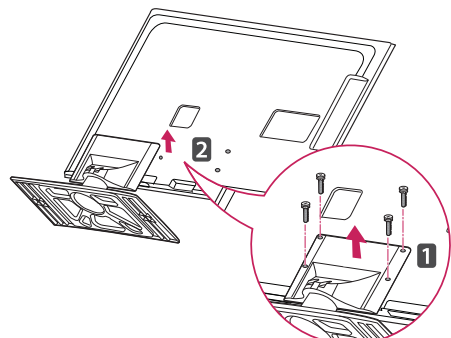

19/22/26LV2500, 26LV2520 series

- 1 Lay the TV with the screen side down on a flat surface.



CAUTION

- Lay a foam mat or soft protective cloth on the surface to protect the screen from damage. Make sure no objects press against the screen.

- 2 Assemble the parts of the STAND BODY with the STAND BASE of the TV.

Screw for assembly	Number of screws
M4 x 6	2

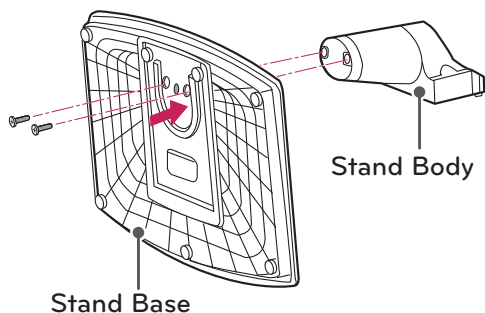

- 3 Secure the TV and the stand with the 2 screws.

Screw for assembly	Number of screws
M4 x 16	2

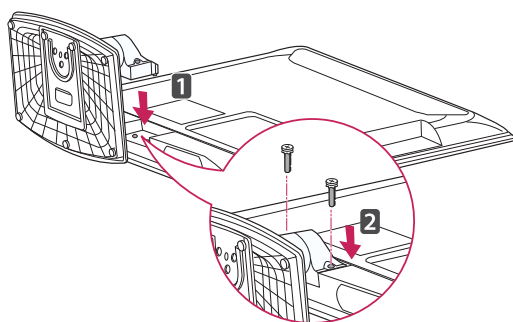

CAUTION

- Tighten the screws firmly to prevent the TV from tilting forward. Do not over tighten.

To detach the stand,

- 1 Lay the TV with the screen side down on a flat surface.
- 2 Remove the 2 screws and pull the stand away from the TV.

Screw for assembly	Number of screws
M4 x 16	2

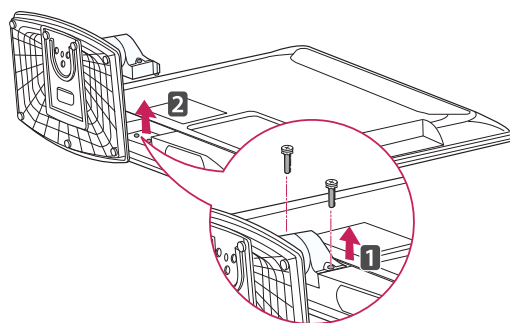

LK330, LK430, LK450, LK520 series

- 1 Lay the TV with the screen side down on a flat surface.



CAUTION

- Lay a foam mat or soft protective cloth on the surface to protect the screen from damage. Make sure no objects press against the screen.

- 2 Assemble the parts of the STAND BODY with the STAND BASE of the TV.

Screw for assembly	Number of screws
M4 x 20	4

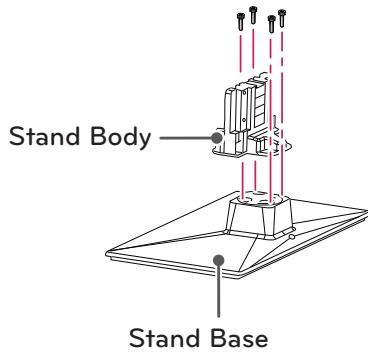

- 3 Secure the TV and the stand with the 4 screws.

Screw for assembly	Number of screws
M4 x 20	4

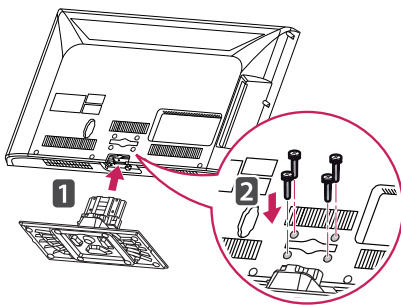

CAUTION

- Tighten the screws firmly to prevent the TV from tilting forward. Do not over tighten.

To detach the stand,

- 1 Lay the TV with the screen side down on a flat surface.
- 2 Remove the 4 screws and pull the stand away from the TV.

Screw for assembly	Number of screws
M4 x 20	4

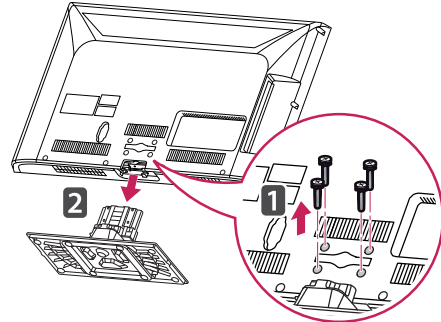

- 3 Push the supplied protection cover into the opening at the bottom of the TV until it locks in place. This will protect the opening from accumulating dust and dirt. When installing the wall mounting bracket, use the Protection cover.

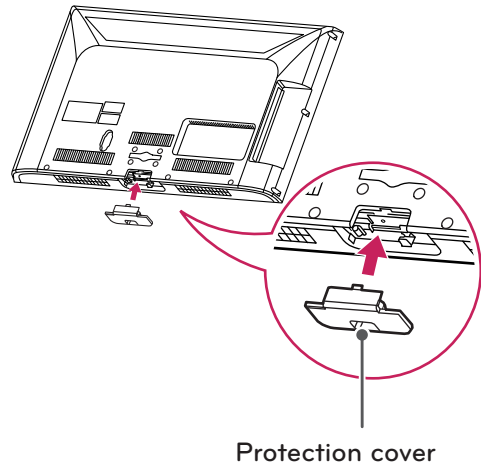

Mounting on a table

- Lift and tilt the TV into its upright position on a table.
 - Leave a 10 cm (4 inches) (minimum) space from the wall for proper ventilation.

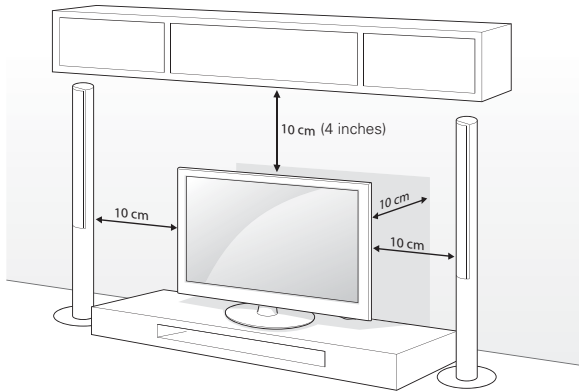

- Connect the power cord to a wall outlet.



CAUTION

- Do not place the TV near or on sources of heat, as this may result in fire or other damage.



NOTE

- Swivel 20 degrees to the left or right and adjust the angle of the TV to suit your view.

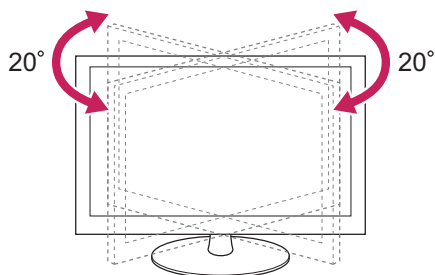

Securing the TV to a table

(For 26/32LK330, 32/42LK430, 32/37/42LK450, 42LK520, 32LV2500, 32LV2520, 32LV3400, 32/37LV3500, 32LV3520)

Fix the TV to a table to prevent from tilting forward, damage, and potential injury. Mount the TV on a table, and then insert and tighten the supplied screw on the rear of the stand.

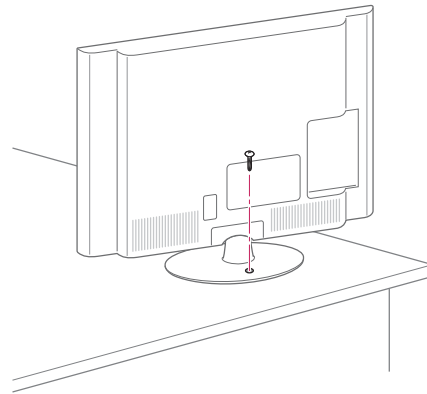

WARNING

- To prevent TV from falling over, the TV should be securely attached to the floor/wall per installation instructions. Tipping, shaking, or rocking the TV may cause injury.

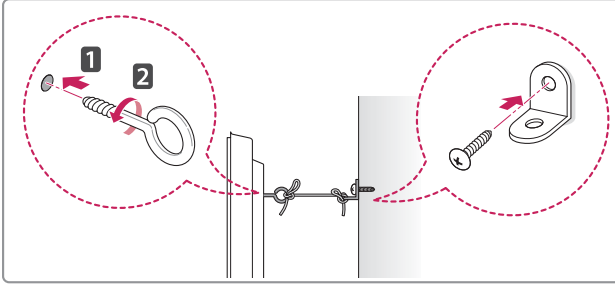
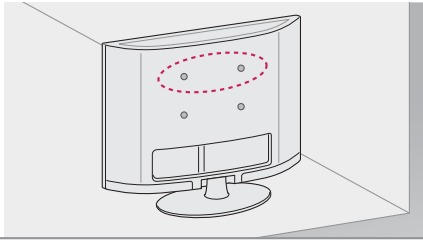
Securing the TV to a wall (optional)

- 1 Insert and tighten the eye-bolts, or TV brackets and bolts on the back of the TV.
 - If there are bolts inserted at the eye-bolts position, remove the bolts first.
- 2 Mount the wall brackets with the bolts to the wall. Match the location of the wall bracket and the eye-bolts on the rear of the TV.
- 3 Connect the eye-bolts and wall brackets tightly with a sturdy rope. Make sure to keep the rope horizontal with the flat surface.

**CAUTION**

- Make sure that children do not climb on or hang on the TV.

**NOTE**

- Use a platform or cabinet that is strong and large enough to support the TV securely.
- Brackets, bolts and ropes are optional. You can obtain additional accessories from your local dealer.

Using the Kensington security system (optional)

The Kensington security system connector is located at the rear of the TV. For more information of installation and using, refer to the manual provided with the Kensington security system or visit <http://www.kensington.com>.

Connect the Kensington security system cable between the TV and a table.

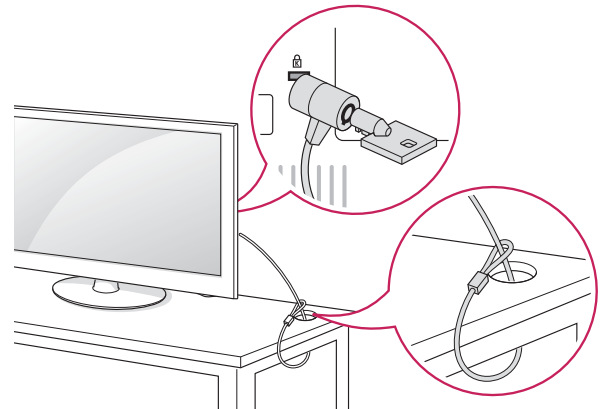
**NOTE**

- The Kensington security system is optional. You can obtain additional accessories from your local dealer.

Mounting on a wall

Attach an optional wall mount bracket at the rear of the TV carefully and install the wall mount bracket on a solid wall perpendicular to the floor. When you attach the TV to other building materials, please contact qualified personnel. We recommend that you use an LG brand wall mount when mounting the TV to a wall.

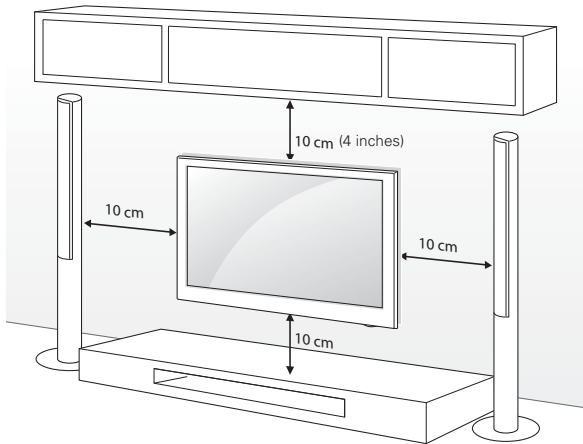

Make sure to use screws and wall mounts that meet the VESA standard. Standard dimensions for the wall mount kits are described in the following table.

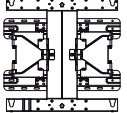
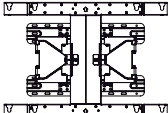
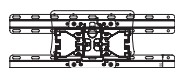
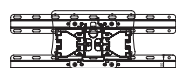
Model	42/50PW340 42/50PW350 42/50PW350U 42/50PW350R 50PZ200	60PZ200
VESA	400 x 400	600 x 400
Standard screw	M6	M8
Number of screws	4	4
Wall mount bracket (optional)	PSW400B, PSW400BG, DSW400BG 	PSW600B 
Model	19/22/26LV2500 26LV2520 26LK330	32LV2500 32LV2520 32LV3400 32LV3500 32LV3520 32LK330 32LK430 32LK450
VESA	100 x 100	200 x 100
Standard screw	M4	M4
Number of screws	4	4
Wall mount bracket (optional)	LSW100B, LSW100BG 	LSW100B, LSW100BG 

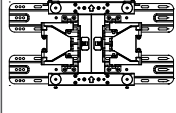
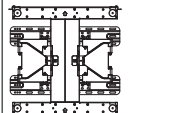
Model	37LV3500 42LK430 37/42/47LK450 42/47LK520	42/47/55LV3500 42LV3520 55LK520 42LW5000 47/55LW5300
VESA	200 x 200	400 x 400
Standard screw	M6	M6
Number of screws	4	4
Wall mount bracket (optional)	LSW200B, LSW200BG 	LSW400B, LSW400BG, DSW400BG 

CAUTION

- Disconnect the power first, and then move or install the TV. Otherwise electric shock may occur.
- If you install the TV on a ceiling or slanted wall, it may fall and result in severe injury. Use an authorized LG wall mount and contact the local dealer or qualified personnel.
- Do not over tighten the screws as this may cause damage to the TV and void your warranty.
- Use the screws and wall mounts that meet the VESA standard. Any damages or injuries by misuse or using an improper accessory are not covered by the warranty.

NOTE

- Use the screws that are listed on the VESA standard screw specifications.
- The wall mount kit includes an installation manual and necessary parts.
- The wall mount bracket is optional. You can obtain additional accessories from your local dealer.
- The length of screws may differ depending on the wall mount. Make sure to use the proper length.
- For more information, refer to the manual supplied with the wall mount.

Tidying cables

PW340, PW350, PW350U, PW350R, PZ200 series

- 1 Install the power cord holder and power cord. It will help prevent the power cable from being removed by accident.

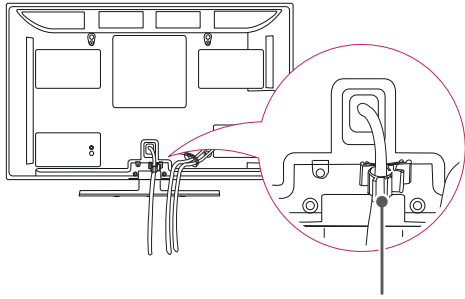

Power cord holder

- 2 Gather and bind the cables with the cable holder.

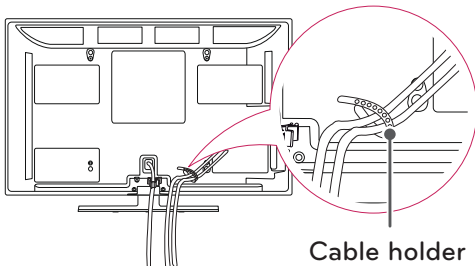

Cable holder



CAUTION

- Do not move the TV by holding the cable holder and power cord holder, as the cable holders may break, and injuries and damage to the TV may occur.

19/22/26LV2500, 26LV2520 series

- 1 Gather and bind the cables with the cable holder.

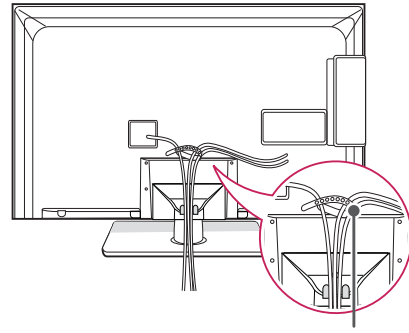

Cable holder

32LV2500, 32LV2520, LV3400, LV3500, LV3520, LW5000, LW5300 series

- 1 Gather and bind the cables with the cable holder on the TV back cover.

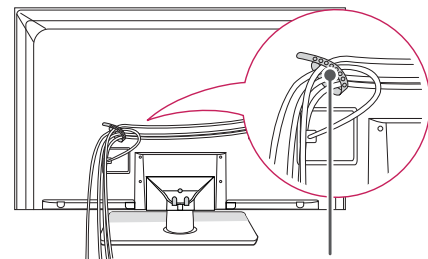

Cable holder

LK330, LK430, LK450, LK520 series

- 1 Gather and bind the cables with the cable management clip.
- 2 Fix the cable management clip firmly to the TV.

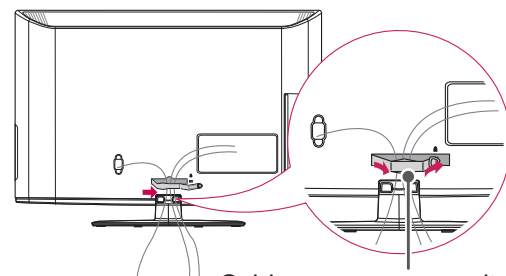

Cable management clip

REMOTE CONTROL

The descriptions in this manual are based on the buttons on the remote control. Please read this manual carefully and use the TV correctly.

To replace batteries, open the battery cover, replace batteries (1.5 V AAA) matching the ⊕ and ⊖ ends to the label inside the compartment, and close the battery cover. To remove the batteries, perform the installation actions in reverse.

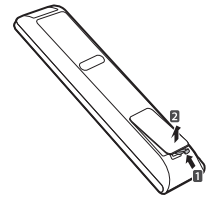

CAUTION

- Do not mix old and new batteries, as this may damage the remote control.

Make sure to point the remote control toward at the remote control sensor on the TV.



- ⏻ (POWER)**
Turns the TV on or off.
- ENERGY SAVING** (See p.64)
Adjusts the Energy Saving settings.
- AV MODE** (See p.44)
Selects an AV mode.
- INPUT** (See p.44)
Rotates through inputs.
Also switches the TV on from standby.
- TV**
Returns to the last TV channel.



- Number button**
Enters numbers.
- LIST** (See p.40)
Accesses the saved channel list.
- VIEW**
Alternates between the two last channels selected (pressing repeatedly).



- Number button**
Enters numbers.
- LIST** (See p.40)
Accesses the saved channel list.
- (Dash)**
Inserts a dash between numbers such as 2-1 and 2-2.
- FLASHBK**
Alternates between the two last channels selected (pressing repeatedly).

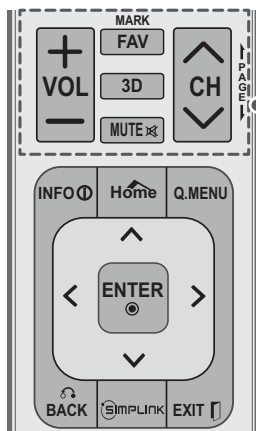

VOL
Adjusts the volume level.

MARK
Selects a menu or option.
FAV (See p.40)
Accesses your favorite channel list.

3D (For 3D TV) (See p.47)
Used for viewing 3D video.

MUTE
Mutes all sounds.

CH
Scrolls through the saved channels.

PAGE
Moves to the previous or next screen.

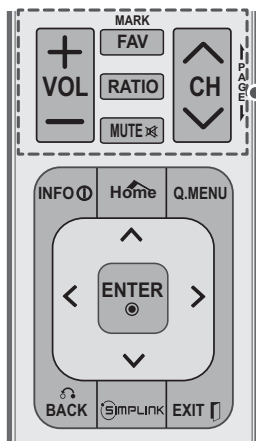

VOL
Adjusts the volume level.

MARK
Selects a menu or option.
FAV (See p.40)
Accesses your favorite channel list.

RATIO (See p.43)
Resizes an image.

MUTE
Mutes all sounds.

CH
Scrolls through the saved channels.

PAGE
Moves to the previous or next screen.

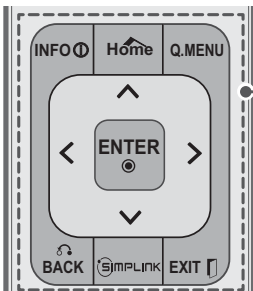

INFO (See p.41)

Views the information of the current program and screen.

Home

Accesses the main menus, or saves your input and exit the menus.

●. MENU (See p.45)

Accesses the quick menu.

Navigation buttons (up/down/left/right)

Scrolls through menus or options.

BACK

Allows the user to move back one step in an interactive application or other user interaction function.

SIMPLINK (See p.81)

Accesses the AV devices connected to the TV;
Opens the SIMPLINK menu.

EXIT

Clears all on-screen displays and returns to TV viewing.



Colored buttons

These access special functions in some menus.

3D SETTING (For 3D TV) (See p.49)

Used for viewing 3D video.

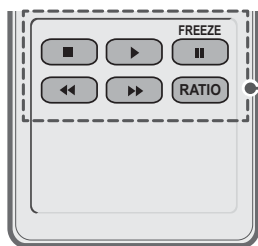

Control buttons

Controls the SIMPLINK compatible devices (USB, SIMPLINK).

FREEZE ()

Freezes the current frame (Not supported when using USB Mode and Simplink.).

RATIO (See p.43)

Resizes an image.

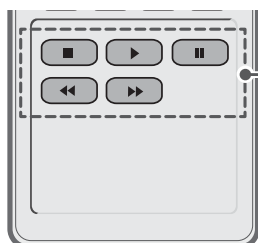
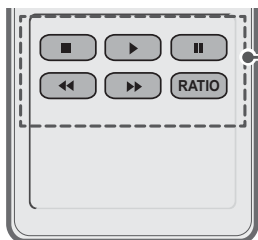

WATCHING TV

Connecting to an antenna or cable

Connect an antenna, cable, or cable box to watch TV while referring to the following. The illustrations may differ from the actual items and a RF cable is optional.

Connecting an antenna or basic cable

Connect the TV to a wall antenna socket with an RF cable (75 Ω).

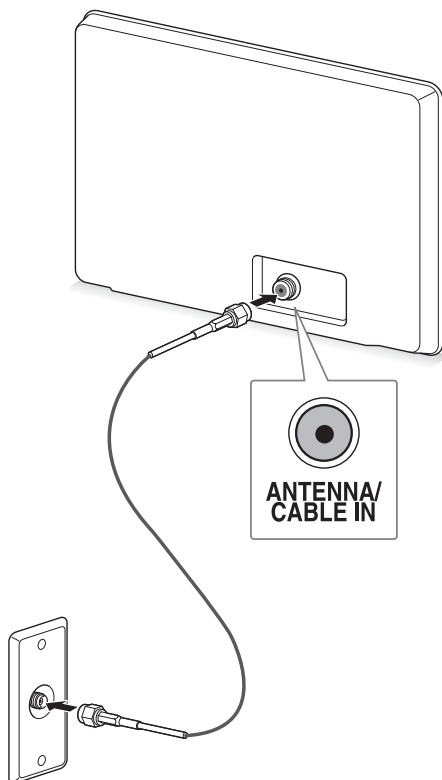

NOTE

- Use a signal splitter to use more than 2 TVs.
- Visit <http://lgknowledgebase.com> for more information about the antenna and cable connection. Search for antenna.

Connecting a cable box

Connect the TV to a cable box and the cable box to a wall antenna socket with 2 RF cables (75 Ω).

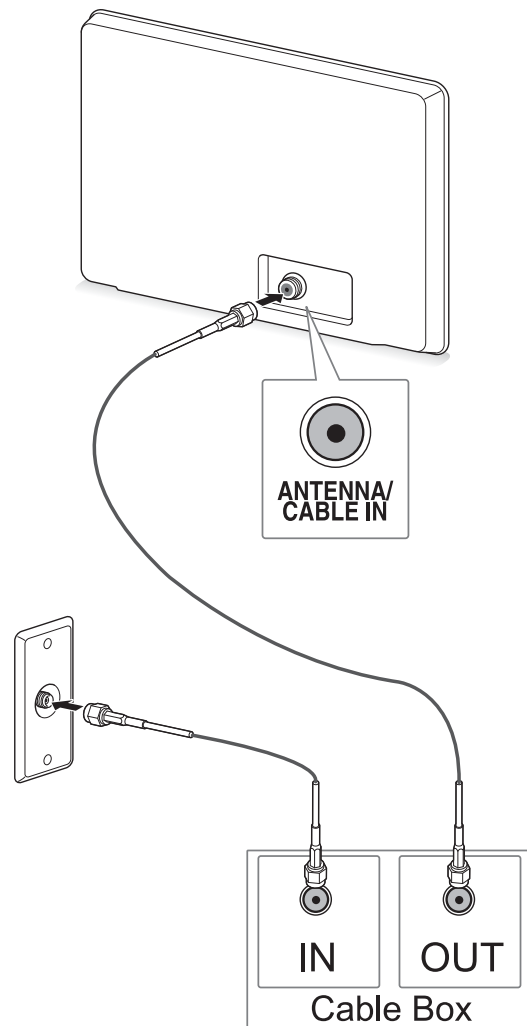

CAUTION

- Make sure not to bend the copper wire of the RF cable.

Copper wire

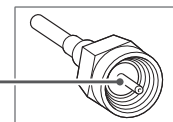

- Complete all connections between devices, and then connect the power cord to the power outlet to prevent damage to your TV.

Connecting to the AC/DC adapter

(For 19/22/26LV2500, 26LV2520)

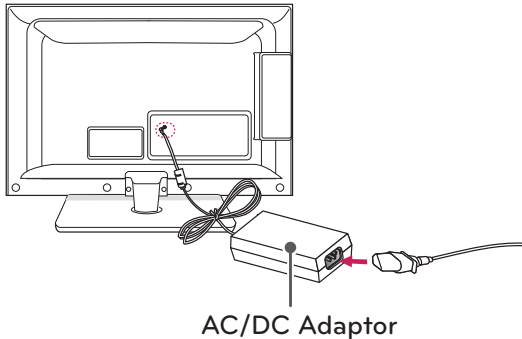

- 1 Connect the AC/DC adapter plug to the power input jack on the TV.
- 2 Connect the power cord to the AC/DC adapter first, then plug the power cord into the wall power outlet.

CAUTION

- Please be sure to connect the TV to the AC/DC power adapter before connecting the TV's power plug to a wall power outlet.

Turning the TV on for the first time

When you turn the TV on for the first time, the Initial setting screen appears. Select a language and customize the basic settings.

- 1 Connect the power cord to a power outlet. The Power indicator turns red and the TV switches to Standby mode.
- 2 In Standby mode, press the power button on the remote control to turn the TV on. The Initial setting screen appears if you turn the TV on for the first time.

NOTE

- You can also access **Initial Setting** by accessing **OPTION** in the main menu.

- 3 Follow the on-screen instructions to customize your TV settings according to your preferences.

Language	Selects a language to display.
↓	
Mode Setting	Selects Home Use for the home environment.
↓	
Power Indicator	Sets the standby light. (For LED LCD TV)
↓	
Time Zone	Selects the time zone and daylight saving.
↓	
Auto Tuning	Scans and saves available channels automatically.

NOTE

- To display images in the best quality for your home environment, select **Home Use**.
- **Store Demo** is suitable for the retail environment.
- If you select **Store Demo**, any customized settings will switch back to the default settings of **Store Demo** in 5 minutes.
- **Power Indicator** feature is disabled in Store Demo mode.

- 4 When the basic settings are complete, press **ENTER**.

NOTE

- If you do not complete the Initial setting, it will appear whenever the TV turns on.
- Disconnect the power cord from the power outlet when you do not use the TV for a long period of time.

- 5 To turn the TV off, press the power button on the remote control.

Watching TV

- 1 In Standby mode, press the power button on the remote control to turn the TV on.
- 2 Press **INPUT** and select TV.
- 3 Control the TV using the following buttons while you are watching TV.

Button	Description
CH (^, v)	Scrolls through saved channels.
LIST ¹	Selects a channel on the saved channel list.
0 - 9	Selects a channel by entering numbers.
VOL (+, -)	Adjusts the volume level.
MUTE	Mutes all sounds.
AV MODE ²	Selects an AV mode (See p.44).
●.MENU	Accesses the quick menus (See p.45).
FLASHBK or ●.VIEW	Alternates between the last two channels selected.
RATIO	Resizes an image (See p.43).
FREEZE	Freezes the current frame while you are watching TV ().

- 1 The Lock icon () appears in front of a channel blocked with parental control.
- 2 Each **AV mode** has the optimized image and sound settings. If you select **Off**, the image and sound settings will be restored to the previously customized settings.
- 4 To turn the TV off, press the power button on the remote control.
The TV switches to Standby mode.

Managing channels

*The Digital broadcasting (DTV, Cable DTV) is not available for Philippines.

Setting up channels

Storing channels

To store channels automatically,

- 1 Press **Home** to access the main menus.
- 2 Press the Navigation buttons to scroll to **CHANNEL** and press **ENTER**.
- 3 Press the Navigation buttons to scroll to **Auto Tuning** and press **ENTER**.
- 4 Select **Start** to start automatic tuning.
The TV scans and saves available channels automatically.



NOTE

- If the TV scans and saves channels, the previously saved channels will be overwritten.

- 5 When you are finished, press **EXIT**.
When you return to the previous menu, press **BACK**.

To store channels manually,

- 1 Press **Home** to access the main menus.
- 2 Press the Navigation buttons to scroll to **CHANNEL** and press **ENTER**.
- 3 Press the Navigation buttons to scroll to **Manual Tuning** and press **ENTER**.
- 4 Scroll through the channel types, and then add or delete channels.
- 5 When you are finished, press **EXIT**.
When you return to the previous menu, press **BACK**.



NOTE

- If the TV scans a blocked channel, you will be prompted to enter your password to keep the channel scanned.
- You can store up to 1000 channels. The number of channels that you can store differs depending on the broadcasting signal environment.
- The channels are stored in the order of **DTV**, **TV**, **Cable DTV** and **Cable TV**.

Editing your channel list

- 1 Press **Home** to access the main menus.
- 2 Press the Navigation buttons to scroll to **CHANNEL** and press **ENTER**.
- 3 Press the Navigation buttons to scroll to **Channel Edit** and press **ENTER**.
- 4 Edit channels using the following buttons.

Button	Description
^	Highlights the channel type.
^, v, <, >	Scrolls through channel types or channels.
ENTER	Selects the highlighted channel to view.
CH (^, v)	Moves to the previous or next page.
Blue button	Adds or deletes a channel. The deleted channel displays in blue.
FAV	Registers or cancels the current channel in favorite channel list.
●.MENU	Selects your desired favorite channel group.
Yellow button	Blocks or unblocks a channel.

- 5 When you are finished, press **EXIT**.
When you return to the previous menu, press **BACK**.

Selecting a channel on the channel list

- 1 Press **LIST** to access the channel list.
 - To move to the previous or next page, press **CH (^, v)**.
 - To tune to the "CHANNEL menu - Channel Edit", press **Blue** button.
- 2 Select a channel you want and press **ENTER**.



NOTE

- The Lock icon (🔒) appears in front of a channel blocked with parental control.
- If you select the blocked channel, you will be prompted to enter your password.

Using favorite channels

Add the channels that you watch frequently to the favorite list.

Setting up your favorite list

- 1 Select a channel to add to the favorite list.
- 2 Press **FAV**.
- 3 Press the Navigation buttons to select your desired favorite channel group.
- 4 Press the **Yellow** button to register or cancel the current channel in favorite channel list. Press the **Blue** button to move to **Channel Edit**.
- 5 Press the Navigation buttons to scroll to **Favorite**.
- 6 Press **ENTER** to add the selected channel to the favorite list.
- 7 When you are finished, press **EXIT**.



NOTE

- You can also setup Favorite List in the **CHANNEL** menu - **Channel Edit**.

Selecting a channel on the favorite list

- 1 Press **FAV** to access the favorite list.
 - To move to the previous or next page, press **CH (^, v)**.
- 2 Select a channel you want and press **ENTER**.

Checking current program info

Press **ENTER** to view the information of the currently program while you are watching.
The following information appears at the top of the screen.

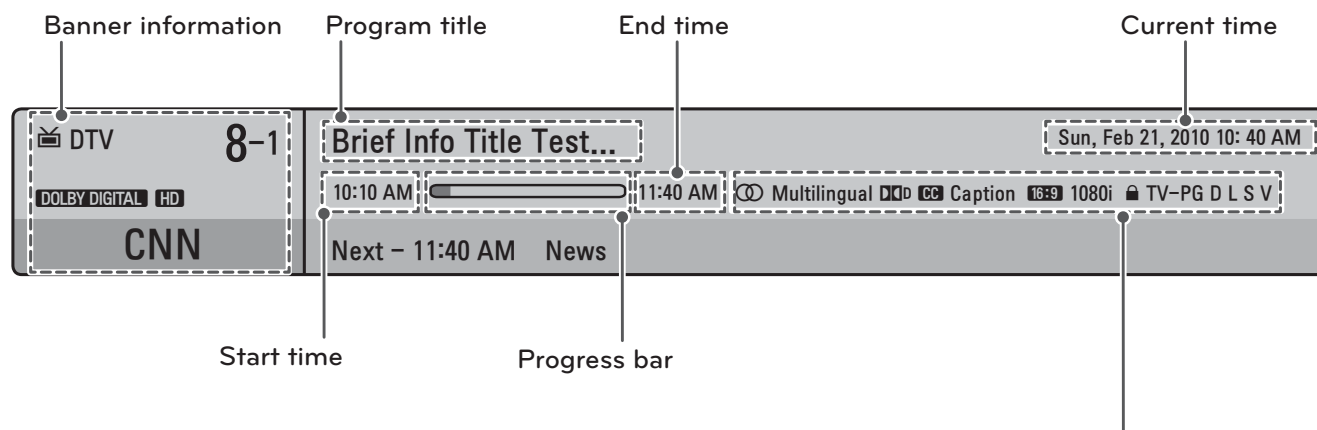

Icon	Description
Multilingual	The program contains two or more audio language services. You can change the audio language using the quick menu.
Dolby Digital	The program contains a Dolby Digital audio signal in TV and HDMI input sources.
Caption	The program contains one or more language caption services. You can change the caption language using the quick menu.
Aspect ratio	The original aspect ratio of the video is 4:3. The original aspect ratio of the video is 16:9 (wide).
Resolution	The video resolution is 720 x 480i. The video resolution is 720 x 480p. The video resolution is 1280 x 720p. The video resolution is 1920 x 1080i. The video resolution is 1920 x 1080p.
Rating	The program contains Rating information. See "LOCK Settings" on p.70.

DTV 8-1 CNN Ch. Change Next Watch

Brief Info Title Test...

10:10 AM 11:40 AM Multilingual CC Caption 16:9 1080i 14 TV-PG D L S V

No information

Sarah Bradley, Steve Gray and Brendon Pongia present the latest in fashion, the arts, entertainment, lifestyle and cooking, with regular and special guests.

Sarah Bradley, Steve Gray and Brendon Pongia present the latest in fashion, the arts, entertainment, lifestyle and cooking, Up

Down

Button	Description
INFO	Shows current channel information.
< or >	Shows previous or next channel information.
^ or v	Changes a channel.

Using additional options

Adjusting aspect ratio

Resize an image to fit at its optimal size by pressing **RATIO** while you are watching TV.

! NOTE

- You can also change the image size by pressing **MENU** or accessing **Aspect Ratio** in the **PICTURE** menu.
- The available ratio varies depending on the input source.
 - The input sources: HDMI-PC and RGB-PC support 4:3 and 16:9.
 - The input sources: HDMI-PC 1920 X 1080 supports all of the aspect ratios.

- **16:9:** Resizes images to fit the screen width.



- **Just Scan:** Displays video images in the original size without cutting off the edges.

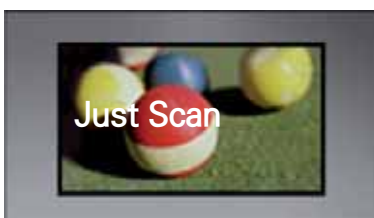

! NOTE

- If you select **Just Scan**, you may see image noises at the edge or edges of the screen.
- The input sources: DTV, Component, HDMI-DTV, and DVI-DTV (720p/1080i/1080p) support Just Scan.

- **4:3:** Resizes images to the previous standard 4:3.



- **Set By Program:** Displays images in the same aspect ratio as the original image.

(4:3 → 4:3)



(16:9 → 16:9)

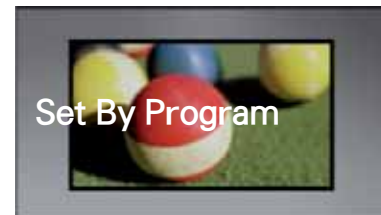

- **Zoom:** Formats an image to fit the screen width. The top and bottom of the image may not appear.



! NOTE

If you access, **Aspect Ratio** in the **Quick** menus,

- Press **<** or **>** to stretch an image vertically.
- Press **▲** or **▼** to move the zoom focus up or down.

- **Cinema Zoom:** Formats an image to the cinemascope ratio, 2.35:1.
 - To change the ratio of the cinema zoom, press **<** or **>** and its range is from 1 to 16.
 - To move the zoom focus up or down, press **▲** or **▼**.



! NOTE

- If you enlarge or reduce an image, the image may be distorted.

Changing AV modes

Each **AV mode** has optimized image and sound settings. Press **AV MODE** repeatedly to select an appropriate mode.

Mode	Description
Off	Changes to the previously customized settings.
Cinema	Uses the optimized image and sound settings for a cinematic look.
Sport	Uses the optimized image and sound settings for dynamic action sports.
Game	Uses the optimized image and sound settings for fast gaming. When playing a video game using PlayStation or Xbox, it is recommended to use the Game mode. When in Game mode, functions related to picture quality will be optimized for playing games.

Using the input list

Selecting an input source

- Press **INPUT** to access the input sources.
 - The connected device displays on each input source.



NOTE

- You can also access the input source list by selecting **INPUT** in the **Home** menu.

- Press the Navigation buttons to scroll to one of the input sources and press **ENTER**.



Input source	Description
TV	Watch TV over the air, cable, and digital cable broadcast.
USB	Play media files from a thumb drive.
AV	Watch video from a VCR or other external devices.
Component	Watch video from a DVD or other external devices, or through a digital set-top box.

RGB-PC	Use the TV as a computer monitor.
HDMI	Watches video from a HTS or other high definition devices.

- The disconnected input sources will be gray.
- To add an input label, press the **Blue** button. You can easily identify a device connected to each input source.
 - If you connect a new external device to the TV, a pop-up window appears. Select Yes on the pop-up window to switch to that input source.
 - To access the SIMPLINK, press the **Red** button. If you select "SIMPLINK and On", the pop-up window for the HDMI input will not display. ()

Adding an Input label

Add a label to an input source so that you can easily identify a device connected to each input source.

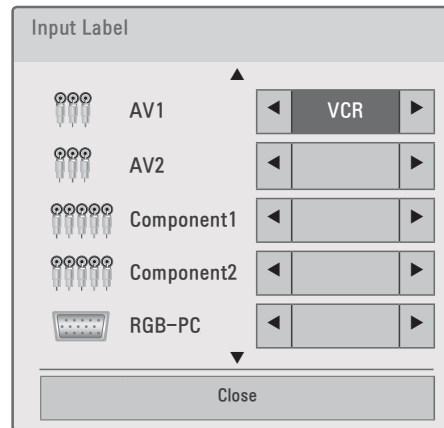

- Press **INPUT** to access the input sources.
- Press the Navigation buttons to scroll to one of the input sources.
- Press the **Blue** button.
- Press the Navigation buttons to scroll to one of the input labels and press **ENTER**.
- When you are finished, press **EXIT**. When you return to the previous menu, press **BACK**.

Locking the buttons on the TV (Child Lock)

Lock the buttons on the TV to prevent any unwanted operations or accidents by children.

- 1 Press **Home** to access the main menus.
- 2 Press the Navigation buttons to scroll to **LOCK** and press **ENTER**.
- 3 Input password.
- 4 Press the Navigation buttons to scroll to **Key Lock** and press **ENTER**.
- 5 Select **On** to activate the **Key lock** feature.
- To deactivate the **Key lock** feature, select **Off**.
- 6 When you are finished, press **EXIT**.
When you return to the previous menu, press **BACK**.

NOTE

- The TV is programmed to remember the last setting after you turn the TV off.
- If you turn the TV off with the Key lock feature activated, **INPUT**, **CH** (^, v) or Number buttons on the remote control.
- If you press any button on the TV with the Key lock feature activated, **Key Lock** appears on the screen.

Using the quick menu

Customize frequently used menus.

- 1 Press **MENU** to access the quick menus.
- 2 Press the Navigation buttons to scroll through the following menus.

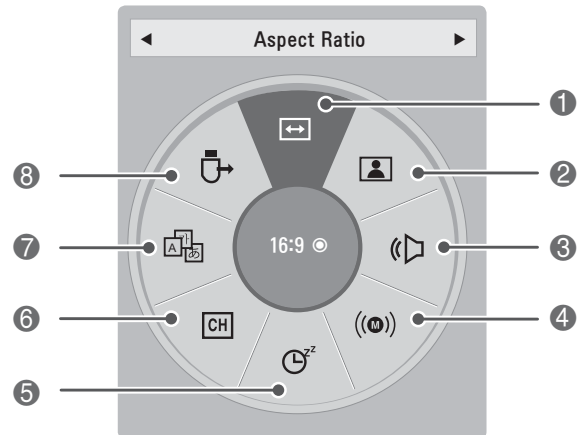

	Menu	Description
1	Aspect Ratio	Changes the image size.
2	Picture Mode (Depending on model)	Changes the image mode.
3	Sound Mode	Changes the sound mode.
4	Multi Audio	Changes the audio language (Digital signal).
	SAP	Changes the MTS sound (Analog signal).
5	Sleep Timer	Sets the length of time until the TV to turns off.
6	Del/Add	Edits the channels to add or delete the channel.
7	Caption	Activates or deactivate the subtitles.
8	USB Device	Ejects a USB device when a USB device is connected.

NOTE

- The available menus and options may differ from the input source that you are using.

- 3 Press the Navigation buttons to scroll to the option you want.
- 4 When you are finished, press **MENU**.

Using the customer support

Testing the Picture / Sound

To execute picture and sound tests.

- 1 Press **Home** to access the main menus.
- 2 Press the **Red** button to access **Customer Support**.
- 3 Press the Navigation buttons to scroll **Picture Test** or **Sound Test** and press **ENTER**.
- 4 If you have any problem, press the Navigation buttons to scroll to **Yes** and press **ENTER**.
- 5 When you are finished, press **EXIT**.
When you return to the previous menu, press **BACK**.

Using the product or service information

To check the product or service information

- 1 Press **Home** to access the main menus.
- 2 Press the **Red** button to access **Customer Support** and press **ENTER**.
- 3 Press the Navigation buttons to scroll **Product/Service Info.**
You can check the various product/Service information based on your model.
- 4 When you are finished, press **EXIT**.
When you return to the previous menu, press **BACK**.

3D IMAGING (FOR 3D TV)

3D Technology

This TV can display in 3D via 3D broadcasting or when the TV is connected to a compatible device, such as a Blu-ray 3D Player. The viewer must wear compatible 3D glasses in order to see these images in 3D format.



WARNING

- When watching 3D images, you should maintain a distance of at least twice the screen width, and you should also be able to see all of the screen at eye level.
- If you watch the 3D imaging too closely or for a long period of time, it may harm your eyesight.
- Watching the TV or playing video games that incorporate 3D imaging with the 3D glasses for a long period of time can cause drowsiness, headaches or fatigue to you and/or your eyes. If you have a headache, or otherwise feel fatigued or drowsy, stop watching the TV and take a rest.
- Pregnant woman, seniors, persons with heart problems or persons who experience frequent drowsiness should refrain from watching 3D TV.
- Some 3D imaging may cause you to duck or dodge the image displayed in the video. Therefore, it is best if you do not watch 3D TV near fragile objects or near any objects that can be knocked over easily.
- Please prevent children under the age of 5 from watching 3D TV. It may affect their vision development.
- Warning for photosensitization seizure: Some viewers may experience a seizure or epilepsy when exposed to certain factors, including flashing lights or images in TV or video games. If you or anybody from your family has a history of epilepsy or seizure, please consult with your doctor before watching 3D TV.
Also certain symptoms can occur in unspecified conditions without any previous history. If you experience any of the following

symptoms, immediately stop watching the 3D imaging and consult a doctor: dizziness or lightheadedness, visual transition or altered vision, visual or facial instability, such as eye or muscle twitching, unconscious action, convulsion, loss of conscience, confusion or disorientation, loss of directional sense, cramps, or nausea. Parents should monitor their children, including teenagers, for these symptoms as they may be more sensitive to the effects of watching 3D TV.

- Risk of photosensitization seizure can be reduced with the following actions.
 - » Take frequent breaks from watching 3D TV.
 - » For those who have vision that is different in each eye, they should watch the TV after taking vision correction measures.
 - » Watch the TV so that your eyes are on the same level as the 3D screen and refrain from sitting too closely to the TV.
 - » Do not watch the 3D imaging when tired or sick, and avoid watching the 3D imaging for a long period of time.
 - » Do not wear the 3D glasses for any other purpose than viewing 3D imaging on a 3D TV.
 - » Some viewers may feel disoriented after watching 3D TV. Therefore, after you watch 3D TV, take a moment to regain awareness of your situation before moving.

**NOTE**

- To watch the TV in 3D, you must put on your 3D glasses. For best results, you should wear LG Brand 3D glasses. The 3D imaging may not display properly when using another brand of 3D glasses. Please see the 3D glasses manual for instructions on how to use the 3D glasses.
- After powering on the TV, a few seconds may be needed for your TV to calibrate.
- It may take a moment for you to see the 3D imaging if you look away from the TV and then revert your eyes back to the 3D program. (For Plasma TV)
- If there is an obstacle between the TV and the 3D glasses, the 3D imaging may not display properly. (For Plasma TV)
- Do not use the TV in close proximity to other electronic equipments and RF equipments. (For Plasma TV)
- When watching 2D images, it is recommended to take off the 3D glasses. If you watch 2D images with the 3D glasses on, you may see distorted images.

When using 3D Glasses**CAUTION**

- 3D glasses are sold separately. Refer to the 3D glasses manual for operating instructions.
- Do not use the 3D glasses to replace your corrective glasses, sunglasses or protective goggles.
- Do not store the 3D glasses in hot or cold locations.
- Do not drop objects onto the 3D glasses. Do not drop or bend the glasses.
- Since the lenses of the 3D glasses are easily scratched, make sure to clean only with a soft cloth. Shake off any dust before using the cloth since the glasses are easily scratched.

3D Imaging Viewing Range

(For Plasma TV)

TV size, viewing angle & other circumstances may change the viewing distance and the angle of view.

Viewing Distance	Viewing Angle
2 m - 10 m (6.5 ft - 32.8 ft)	120 ° (When the viewing distance is 2 m (6.5 ft))

Viewing 3D Imaging

View 3D mode for 3D images

- 1 Play the 3D video or select 3D channel.
(2D to 3D mode is available with all contents.)
- 2 Press 3D and select same type in your displayed picture on the screen.
(Select type on "3D Video" tab.)



NOTE

- Turn on the 3D mode automatically for HDMI input playing the 3D blueray titles.

- 3 Press **ENTER** on displayed information window.

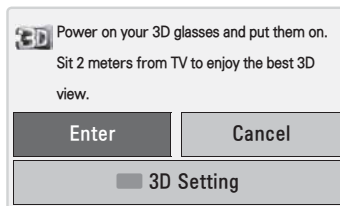

or

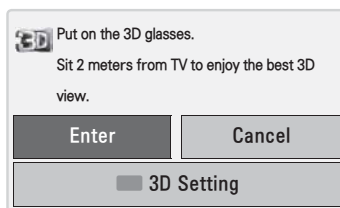

- 4 To turn off the 3D mode, press 3D and select **ENTER**.

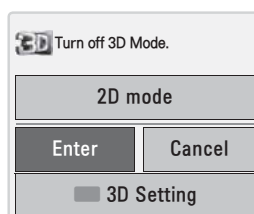

View 2D mode for 3D images

- 1 Play the 3D video or select 3D channel.
- 2 Press 3D and select same type in your displayed picture on the screen.
(Select type on "2D Video" tab.)



- 3 To turn off the 2D mode, press 3D and select **ENTER**.

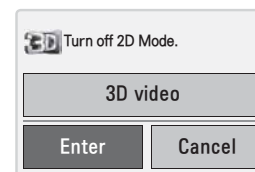

Using 3D quick menu option

- 1 Press **3D SETTING**.
- 2 Use the following options while viewing 3D imaging.

Button (Depending on model)	Description
3D Picture Size	Cuts off the outer edges of the picture and stretch it to fit the full screen in 3D mode.
3D Depth	Adjusts the distance between the object and the background in the picture to enhance the 3D effect in 2D to 3D mode.
3D Viewpoint	Brings the picture (including both the object and background images) to the front or back to enhance the 3D effect in 3D mode.
3D Picture Balance	Adjusts the color and brightness difference between the right and left sides of the picture in 3D mode.
3D Picture Correction	Changes the order of images in the right and left sides of the picture in 3D mode.

**CAUTION**

- Some menus may not work while watching the TV in 3D.
- The 3D imaging mode is disabled automatically when switching DTV channels.
- The screen may not be displayed properly if you view 2D DTV images in 3D imaging mode.
- 3D effect can be seen when 3D Mode is selected appropriately for the 3D input signal supplied to the TV.
- For *.mpo files (3D camera files), the 3D imaging mode is enabled automatically.
- 3D may not be displayed properly for some PC graphics cards.

**NOTE**

()

- If you select 3D mode, "Power indicator" is turned off automatically.
- While watching 3D imaging, you cannot adjust video/audio settings using the menu.
- You can only choose "Standard → Cinema → Game" with the **AV MODE** button on the remote control. **AV Mode** is set as **Standard** while playing in 3D.
- If you'd like to play the BGM using *.mpo file(3D camera file), In advance, the contents path for BGM should be set on full-sized photo view screen which isn't *.mpo file(3D camera file).
- Picture mode is set as Standard, Energy Saving Off if entering to 3D mode.

ENTERTAINMENT

Connecting USB storage devices

Connect USB storage devices such as a USB flash drive or external hard drive to the TV and use multimedia features (See "Browsing files" on p. 52). Connect a USB flash drive or USB memory card reader to the TV as shown in the following illustration.

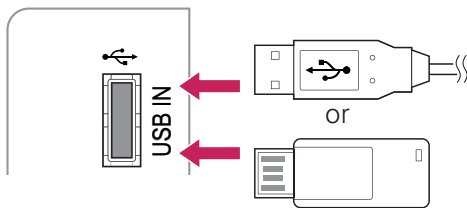

To disconnect a USB storage device, make sure to end the connection properly to prevent damages to the TV or files.

- 1 Press **●.MENU** to access the quick menus.
- 2 Press the Navigation buttons to scroll to **USB Device** and press **ENTER**.
- 3 Disconnect the USB storage device only when the message says that it is safe to remove.



CAUTION

- Do not turn the TV off or remove a USB storage device while the USB storage device is connected to the TV, as this could result in loss of files or damage to the USB storage device.
- Back up your files saved on a USB storage device frequently, as you may lose or damage the files and this may be not covered by the warranty.

Tips for using USB storage devices

- The TV recognizes only a USB storage device.
- If you connect a USB storage device to the TV through a USB hub, your TV may not recognize the USB storage device.
- The TV may not recognize a USB storage device that requires a special driver.
- The recognition speed of a USB storage device may differ depending on the device.
- Only use a USB storage device which has normal music or image files.
- Use only USB storage devices that are formatted as a FAT 32 or NTFS file system.
- If you format a USB storage device as a NTFS file system, you cannot delete the saved files.
- You may need to connect a USB storage device to an external power supply with a power adapter.
- If the TV does not recognize a connected USB storage device, replace the cable and try again. Do not use an excessively long cable.
- The TV does not support some USB storage devices properly.
- You can use a multi-partition (up to 4) USB storage device.
- You can use up to 4 USB storage devices at a time by using a USB multi-card reader.
- The file alignment method of a USB storage device is similar to the one of Window XP.
- You cannot create or delete a folder saved in a USB storage device directly on the TV.
- The number of characters for a file name is up to 100 English characters.
- If there are too many folders and files in one folder, it may not operate properly.
- The recommended capacity for a USB external hard disk is 1 TB or less and for a USB storage device is 32 GB or less.
- If a USB external hard disk with the Energy Saving feature does not work, turn the USB external hard disk off and on again to make it work properly. For more information, refer to the user manual of the USB external hard disk.
- USB storage devices below USB 2.0 are supported as well. But they may not work properly in the movie list.
- The electrostatic can cause USB device's malfunction. In this case, USB Device has to be plugged again.

Browsing files

Access the photo, music, or movie lists and browse files.

- 1 Connect a USB storage device.
- 2 Press **Home** to access the main menu.
- 3 Press the Navigation buttons to scroll to **MY MEDIA** and press **ENTER**.
- 4 Press Navigation buttons to scroll to **MOVIE LIST**, **PHOTO LIST**, or **MUSIC LIST** and press **ENTER**.

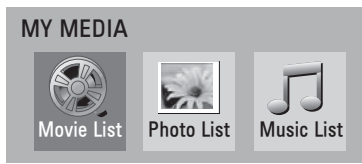

- 5 Select **Drive1** to access the connected USB storage device.
- 6 Press the Navigation buttons to Select a folder/ file you want.

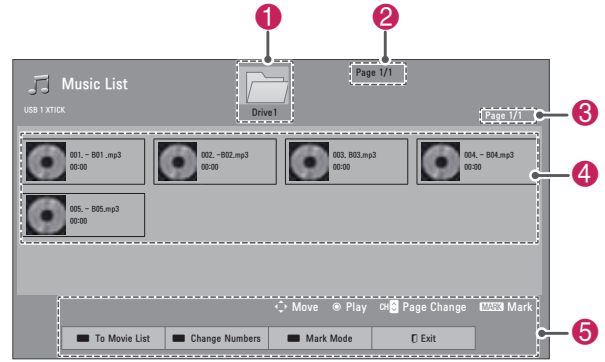

No.	Description
1	Moves to the upper level folder.
2	Current page number/total number of pages
3	Current page number/total number of pages
4	Contents under the folder focused on 1
5	Available buttons on the remote control
Button	Description
Green button	Moves to Photo List , Music List , or Movie List .
Yellow button	Change Numbers: Changes the number or thumbnails displayed at a time.
Blue button	Allows you to mark certain files.

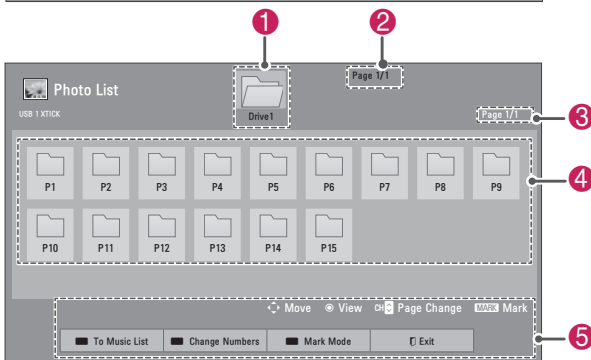
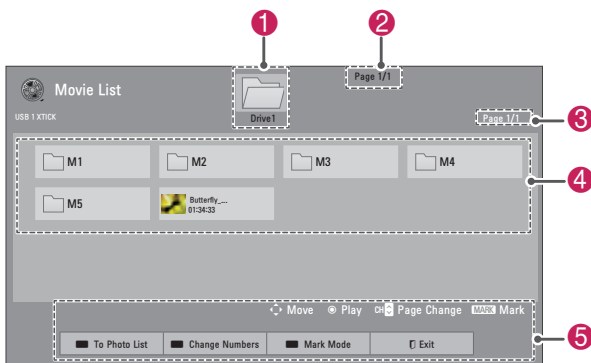

Tips for using USB storage devices

Type	Supported File Formats
Video	<ul style="list-style-type: none"> • MPG, MPEG, DAT, TS, TRP, TP, VOD, MP4, MOV, MKV, DivX, AVI, Motion JPEG (AVI, MP4, MKV), ASF, WMV, FLV • Resolution: under 1920 pixel (width) x 1080 pixel (height) • Frame Rate: under 30 frame/sec (1920 x 1080), under 60 frame/sec (1280 x 720) • Max bitrate of playable movie file: 20 Mbps (Mega bit per second) • Bit rate of audio format: within 32 kbps to 320 kbps (MP3) • Supported subtitle format: *.smi, *.srt, *.sub (MicroDVD, SubViewer 1.0/2.0), *.ass, *.ssa, *.txt (TMPlayer), *.psb (PowerDivX)

Type	Supported File Formats			
Photo	<ul style="list-style-type: none"> • JPG • Available size Baseline: 64 pixel (W) x 64 pixel (H) - 15360 pixel (W) x 8640 pixel (H) Progressive: 64 pixel (W) x 64 pixel (H) - 1920 pixel (W) x 1440 pixel (H) * Do not use the progressive option when saving JPG files on your PC. • It may take some time to open high-resolution images in full screen. 			
	For 3D TV			
		File Extensions	Item	Profile
	2D	jpeg jpg jpe	Supported file format	<ul style="list-style-type: none"> • SOF0: baseline • SOF1: Extend Sequential • SOF2: Progressive
			Photo size	<ul style="list-style-type: none"> • Min: 64 x 64 • Max - Normal Type: 15360 (W) x 8640 (H) • Progressive Type: 1920 (W) x 1440 (H)
3D	mpo	Supported file format	<ul style="list-style-type: none"> • mpo 	
		Photo size	<ul style="list-style-type: none"> • 4:3 size: 3,648 x 2,736 2,592 x 1,944 2,048 x 1,536 • 3:2 size: 3,648 x 2,432 	
Music	<ul style="list-style-type: none"> • MP3 • Bit rate range 32 Kbps - 320 Kbps • Sampling rate (Sampling Frequency) MPEG1 layer 3: 32 kHz, 44.1 kHz, 48 kHz MPEG2 layer 3: 16 kHz, 22.05 kHz, 24 kHz MPEG2.5 layer 3: 8 kHz, 11.025 kHz, 12 kHz * A copy-protected file will not play. 			

Viewing Videos

Your TV can display video files from a USB storage device.

- 1 Press **Home** to access the main menus.
- 2 Press the Navigation buttons to scroll to **MY MEDIA** and press **ENTER**.
- 3 Press the Navigation buttons to scroll to **Movie List** and press **ENTER**.
- 4 Select **Drive1** to access the connected USB storage device.
- 5 Press the Navigation buttons to scroll to a folder/file you want and press **ENTER**.
- 6 Play a movie by using the following menus/ buttons.



Button	Description
Navigation button	Scrolls through the files.
ENTER	Plays the highlighted file or enters the mark mode.
CH (▲, ▼)	Moves to the previous or next page.
MARK	Enters the mark mode.
Menu	Description
Play Marked	Plays the selected video.
Mark All	Selects all files.
Unmark All	Clears all of your selections.
Exit Mark Mode	Exit the Mark Mode.

NOTE

- : Abnormal files are displayed using this graphic.
- : Non-supported files are displayed using this graphic.

- 7 Control playback by using the following buttons.



Button	Description
	Stops the playback.
	Plays a video.
	Pauses or resumes the playback.
	Scans backward in a file.
	Scans forward in a file.
	Plays videos in slow motion.
	Skips to specific points in a file during playback. The time of a specific point will appear on the status bar. In some files, this function may not work properly.
ENERGY SAVING	Increases or decreases the brightness of your screen.
●.MENU	Shows the Option menu (See p.55).
AV MODE	Selects the desired source.
BACK	Hides the menu on screen. To see the menu again, press ENTER button to display.
EXIT	Returns to TV viewing.

Tips for playing video files

- Some user-created subtitles may not work properly.
- Subtitles may not display some special characters or HTML tags.
- Subtitles in the non-supported languages are unavailable.
- The time information in an external subtitle file should be arranged in ascending order to play.

- The screen may suffer from temporary interruptions such as image stoppage or faster playback when you change the audio language.
- If you play a damaged video file, the video file may not be played correctly or some player functions may not be unavailable.
- The TV may not properly play the video files produced with certain encoders.
- If the recorded file does not have video or audio, either video or audio is not outputted.
- If the TV plays the recorded file without video or audio, either video or audio is not outputted.
- The TV may not smoothly play the video files with a resolution higher than the supported resolution for each frame.
- The TV may not properly play the video files not included on the specified type and format.
- The TV may not play the files encoded with GMC (Global Motion Compensation) or quarter-pel motion estimation.
- The TV supports the only files saved in ASCII code in subtitles.
- The maximum number of characters displayed on each subtitle line is 250 (Korean), 500 (English), and 500 (Numbers).
- The TV supports the only 10,000 sync blocks within the subtitle file.
- The TV supports the H.264 codec up to the profile level 4.1.
- The TV does not support DTS audio codec.
- The TV cannot play a video file whose size is larger than 30 GB.
- If you play a video file through the USB connection that does not support the high speed, the video player may not work properly.
- The TV supports a USB storage device whose version is lower than 2.0. However, the USB storage device may not work properly in the movie list.
- The video file and its subtitle should be in the same folder and the name of the video file and subtitle should be identical.
- You can adjust the image by using **ENERGY SAVING** and **AV MODE**. But you cannot customize image options of each mode.
- The TV may not play the video files in the supported file format depending on the encoded condition.

- The TV will not play the video files that has a damaged index or no index.

Q.MENU options for movie list

- 1 Press **●**. **MENU**.
A pop-up window will appear.
- 2 Press the Navigation buttons to scroll to movie list option and press **ENTER**.
- 3 Press the Navigation buttons to scroll to one of the following options and press **ENTER**.

Set Video Play.

Option	Description	
Picture Size	Selects your desired picture format for videos. <ul style="list-style-type: none"> • Full Mode: Files are played in full screen mode according to the aspect ratio of video. • Original Mode: Files are played in their native size. 	
Audio Language	Changes the Language Group of the audio for video files. Files with a single audio track cannot be selected.	
Subtitle Language	The subtitles can be turned on or off.	
Language	Activated for SMI subtitles and can select the language within the subtitle.	
Code Page	Subtitle font selection. When set to default, contents are displayed in the language set in "Option - Language - Menu Language."	
	Subtitle Language Group	Supported Language
	Latin1	English, Spanish, French
	Korean	English, Korean
Sync	If the video is not synchronized with the captions, it can be adjusted by 0.5 second.	
Position	Move the location of the subtitles.	
Size	Changes the subtitle font size.	
Repeat	Turn on/off repeat function of movie playback. When turned on, the file within the folder will be played back repeatedly. When turned off, if the next file name is similar to the previous file, it can be played sequentially.	

**NOTE**

- When replaying a video file after stopping, select "Yes" to restart where it previously stopped.
- If continuous series files exist within the folder, the next file will automatically be played. But, this excludes cases when the Repeat function of Movie List Option is turned "On" (See p.55) or when set as **Play Marked**.

Set Video.

Allows you to change Video presets. (Refer to "PICTURE Settings" on p.64).

Set Audio.

Allows you to change Audio presets. (Refer to "AUDIO Settings" on p.68).

DivX registration code

Registering the DivX code

The DivX registration code allows you to rent or purchase the latest movies at www.divx.com/vod. To play a rented or purchased DivX file, the file's registration code should be same as your TV's DivX registration code.

- 1 Press **Home** to access the main menus.
- 2 Press the Navigation buttons to scroll to **MY MEDIA** and press **ENTER**.
- 3 Press the **Blue** button.
- 4 Press the Navigation buttons to scroll to **DivX VOD Registration** and press **ENTER**.
- 5 View the registration code of your TV.

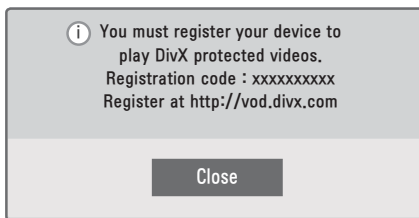

- 6 When you are finished, press **ENTER**.

! NOTE

- While you are checking the registration code, some buttons may not work.
- If you use the DivX registration code of another device, you cannot play the rented or purchased DivX file. Make sure to use the DivX registration code assigned to your TV.
- The video or audio files that are not converted by the standard DivX codec may be corrupted or not be played.
- The DivX VOD code allows you to activate up to 6 devices under one account.

Deactivating the DivX feature

You can deactivate all of the devices through the web server and block devices from activating. Delete the existing authentication information to receive a new DivX user authentication for the TV. Once this function is executed, a DivX user authentication is required again to see DivX DRM files.

- 1 Press **Home** to access the main menus.
- 2 Press the Navigation buttons to scroll to **MY MEDIA** and press **ENTER**.
- 3 Press the **Blue** button.
- 4 Press the Navigation buttons to scroll to **DivX Deregistration** and press **ENTER**.
- 5 Select **Yes** to confirm.

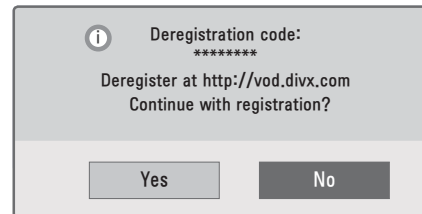

- 6 When you are finished, press **EXIT**. When you return to the previous menu, press **BACK**.

Viewing Photos



You can view image files saved on a USB storage device. The displays on the screen may differ based on the model.

- 1 Press **Home** to access the main menus.
- 2 Press the Navigation buttons to scroll to **MY MEDIA** and press **ENTER**.
- 3 Press the Navigation buttons to scroll to **Photo List** and press **ENTER**.
- 4 Select **Drive1** to access the connected USB storage device.
- 5 Press the Navigation buttons to scroll to a folder/file you want and press **ENTER**.
- 6 View photos by using the following menus/ buttons.



Button	Description
Navigation button	Scrolls the file.
ENTER	Views the highlighted file or enters the mark mode.
CH (▲, ▼)	Moves to the previous or next page.
MARK	Enters the mark mode.
Menu	Description
View Marked	Views the selected photo.
Mark All	Selects all files
Unmark All	Clears all of your selections.
Exit Mark Mode	Exits the Mark Mode.

NOTE

-  : Abnormal files are displayed using this graphic.
-  : Non-supported files are displayed using this graphic.

- 7 The following options are available while viewing photos.

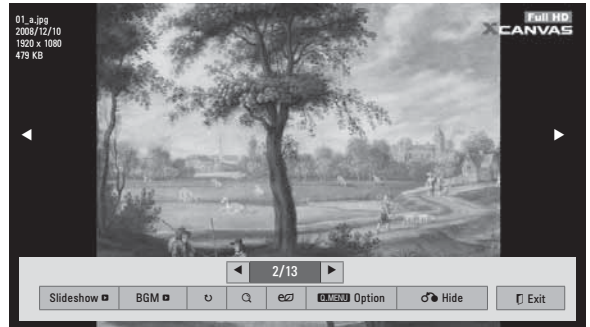

Option	Description
Slideshow	<ul style="list-style-type: none"> • Starts or stops a slideshow with selected photos. • If there are no selected photos, all photos saved in the current folder display during a slideshow. • To set a slideshow speed, select Option.
BGM (Background Music)	<ul style="list-style-type: none"> • Turns the background music on or off. To set the background music folder, select Option. <div style="border: 1px solid black; padding: 5px; margin-top: 10px;"> <p>NOTE</p> <ul style="list-style-type: none"> • You can't change or set-up the BGM while viewing the *.mpo files (3D camera file). </div>
⌚ (Rotate)	<p>Rotates photos clockwise (90°, 180°, 270°, 360°).</p> <div style="border: 1px solid black; padding: 5px; margin-top: 10px;"> <p>NOTE</p> <ul style="list-style-type: none"> • The supported photo size is limited. You cannot rotate a photo if the resolution of the rotated width is larger than the supported resolution size. </div>
🔍 (Zoom In)	Views the photo by zoom in 2, 4 times by using Blue button.
🔋 (ENERGY SAVING)	Increases or decreases the brightness of your screen.
Option	Shows the Option menu (See p.59).
Hide	Hides the option window. To display the options, press ENTER .
Exit	Moves to the previous menu screen.

! NOTE

- Option values changed in Photo List do not affect Movie List and Music List.
- Option values changed in Photo List or Music List are changed likewise in Photo List and Music List, but not Movie List.

Q.MENU options for photo list

- 1 Press **•**. **MENU**.
A pop-up window will appear.
- 2 Press the Navigation buttons to scroll to photo list option and press **ENTER**.
- 3 Press the Navigation buttons to scroll to one of the following options and press **ENTER**.

Set Photo View.

Option	Description
Slide Speed	Selects a slideshow speed (Fast, Medium, Slow).
BGM	Selects a music folder for the background music. <ul style="list-style-type: none"> • Repeat • Random <div style="border: 1px solid black; padding: 5px; margin-top: 10px;"> ! NOTE <ul style="list-style-type: none"> • You cannot change the music folder while the background music is playing. </div>

Set Video.

Allows you to change Video presets. (Refer to "PICTURE Settings" on p.64).

Set Audio.

Allows you to change Audio presets. (Refer to "AUDIO Settings" on p.68).

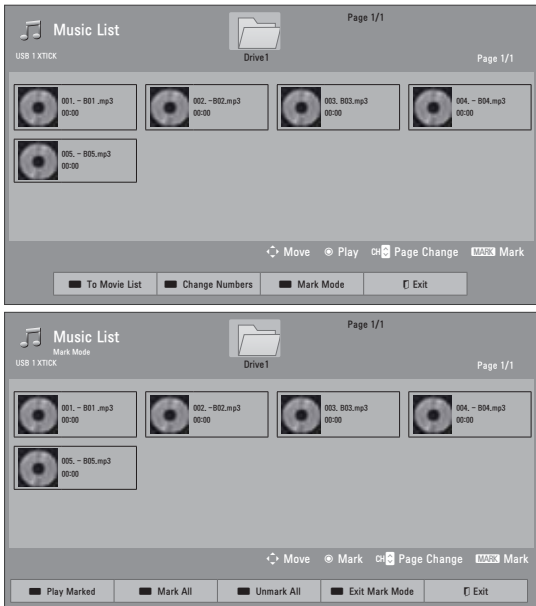

Listening to music

- 1 Press **Home** to access the main menus.
- 2 Press the Navigation buttons to scroll to **MY MEDIA** and press **ENTER**.
- 3 Press the Navigation buttons to scroll to **Music List** and press **ENTER**.
- 4 Select **Drive1** to access the connected USB storage device.
- 5 Press the Navigation buttons to scroll to a folder/file you want and press **ENTER**.
- 6 Play music by using the following menus/ buttons.









Button	Description
Navigation button	Scrolls through the files.
ENTER	Plays the highlighted file or enters the mark mode.
CH (⤴, ⤵)	Moves to the previous or next page.
MARK	Enters the mark mode.
Menu	Description
Play Marked	Plays the selected music file.
Mark All	Selects all files.
Unmark All	Clears all of your selections.
Exit Mark Mode	Exits the Mark Mode.

NOTE

- : Abnormal files are displayed using this graphic.
- : Non-supported files are displayed using this graphic.

- 7 Control playback by using the following buttons.

Button	Description
	Stops playback.
	Plays a music file.
	Pauses or resumes playback.
	Skips to the previous file.
	Skips to the next file.
Play with Photo	Displays photos during playback.
 (ENERGY SAVING)	Increases or decreases the brightness of your screen.
Option	Shows the Option menu (See p.61).
Hide	Hides the option window. To display the options, press ENTER .
Exit	Moves to the previous menu screen.

Q.MENU options for music list

- 1 Press **●**. **MENU**.
A pop-up window will appear.
- 2 Press the Navigation buttons to scroll to music list option and press **ENTER**.
- 3 Press the Navigation buttons to scroll to one of the following options and press **ENTER**.

! NOTE

- Option values changed in Movie List does not affect the Photo List and Music List.
- Option value changed in Photo List and Music List are changed likewise in Photo List and Music List.

Set Audio Play.

Select Repeat or Random option.

Set Audio.

Allows you to change Audio presets. (Refer to "AUDIO Settings" on p.68).

! NOTE

- The TV will not play copy protected files.
- If the TV is not in use for some time during playback, the information box as a screensaver will appear to prevent image burn.

To return to the Music list screen, press **ENTER** or **BACK**.

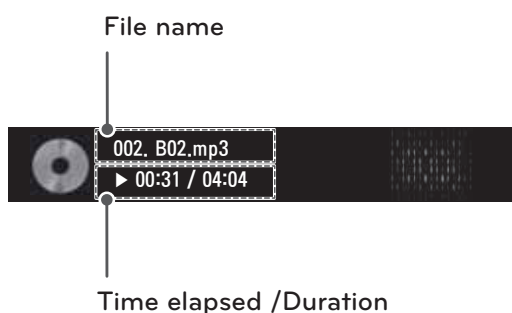

CUSTOMIZING TV SETTINGS

The Main Menu

- 1 Press **Home** to access the main menu.
- 2 Press the Navigation buttons to scroll to one of the following menus and press **ENTER**.
- 3 Press the Navigation buttons to scroll to the setting or option you want and press **ENTER**.
- 4 When you are finished, press **EXIT**.

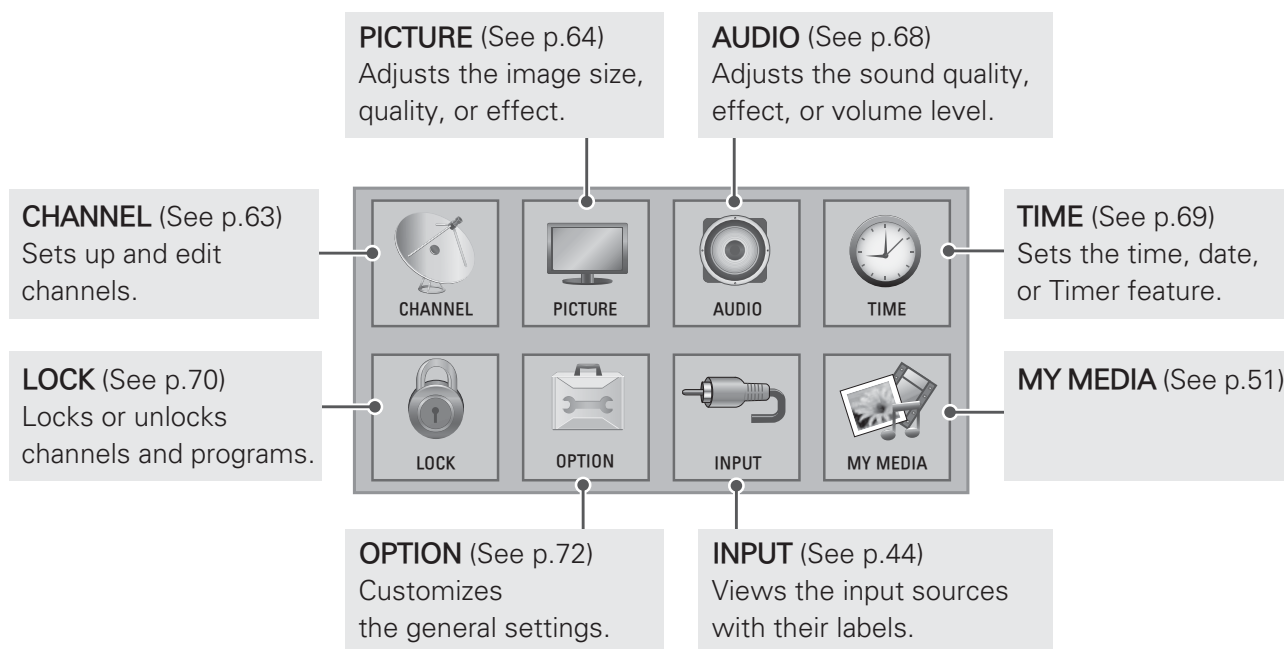

Customizing Settings

CHANNEL Settings

- 1 Press **Home** to access the main menus.
- 2 Press the Navigation buttons to scroll to **CHANNEL** and press **ENTER**.
- 3 Press the Navigation buttons to scroll to the setting or option you want and press **ENTER**.
- To return to the previous level, press **BACK**.
- 4 When you are finished, press **EXIT**.

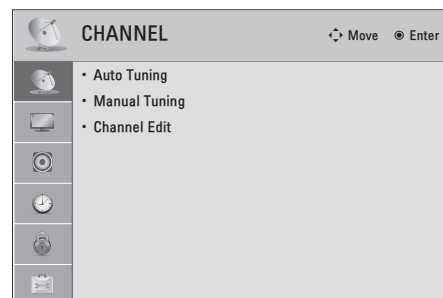

The available channel settings are described in the following.

Setting	Description
Auto Tuning	Tunes and stores all available channels through antennas or cable inputs (See p.39).
Manual Tuning	Tunes and stores the channels you want manually (See p.39).
Channel Edit	Adds or deletes channels on the channel (See p.40).



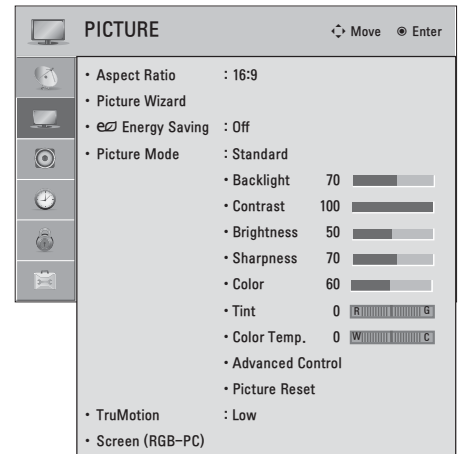

PICTURE Settings

- 1 Press **Home** to access the main menus.
- 2 Press the Navigation buttons to scroll to **CHANNEL** and press **ENTER**.
- 3 Press the Navigation buttons to scroll to the setting or option you want and press **ENTER**.
- To return to the previous level, press **BACK**.
- 4 When you are finished, press **EXIT**.



The available picture settings are described in the following.

Setting	Description												
Aspect Ratio	Changes the image size to view images at its optimal size (See p.43).												
Picture Wizard	Adjusts the image quality and calibrates the screen. The customized options will be saved as Expert1 in the Picture Mode . <div style="border: 1px solid black; padding: 5px;"> <p>NOTE</p> <ul style="list-style-type: none"> • If you use Picture Wizard, the Energy saving feature will turn off automatically. • To reset changes made by Picture Wizard, operate Picture Reset when Picture Mode is on Expert1. </div>												
Energy Saving	Reduces the power consumption by adjusting the screen brightness. <div style="border: 1px solid black; padding: 5px;"> <p>NOTE</p> <ul style="list-style-type: none"> • When selecting Auto or Maximum, Backlight will not work. </div> <table border="1" style="width: 100%; border-collapse: collapse;"> <thead> <tr> <th colspan="2">Option</th> </tr> </thead> <tbody> <tr> <td>Auto ()</td> <td>The backlight is adjusted automatically corresponding to the surroundings when selecting Auto using the Intelligent sensor feature.</td> </tr> <tr> <td>Intelligent sensor ()</td> <td>The most suitable picture is automatically adjusted according to the surrounding conditions.</td> </tr> <tr> <td>Off</td> <td>Select if this feature is not necessary.</td> </tr> <tr> <td>Minimum/ Medium/ Maximum</td> <td>Selects the brightness level.</td> </tr> <tr> <td>Screen off</td> <td>The screen turns off in 3 seconds. Pressing any button of the remote control will turn on the screen again.</td> </tr> </tbody> </table>	Option		Auto ()	The backlight is adjusted automatically corresponding to the surroundings when selecting Auto using the Intelligent sensor feature.	Intelligent sensor ()	The most suitable picture is automatically adjusted according to the surrounding conditions.	Off	Select if this feature is not necessary.	Minimum/ Medium/ Maximum	Selects the brightness level.	Screen off	The screen turns off in 3 seconds. Pressing any button of the remote control will turn on the screen again.
Option													
Auto ()	The backlight is adjusted automatically corresponding to the surroundings when selecting Auto using the Intelligent sensor feature.												
Intelligent sensor ()	The most suitable picture is automatically adjusted according to the surrounding conditions.												
Off	Select if this feature is not necessary.												
Minimum/ Medium/ Maximum	Selects the brightness level.												
Screen off	The screen turns off in 3 seconds. Pressing any button of the remote control will turn on the screen again.												





Setting	Description				
Picture Mode	Selects one of the preset image or customizes options in each mode for the best TV screen performance. You are also able to customize advanced options of each mode. The available preset picture modes vary depending on the TV.				
	Mode				
	Intelligent Sensor ()	Sets the TV to adjust the image settings, such as contrast, brightness, sharpness, color, or tint, automatically corresponding to the surrounding environments.			
	Vivid	Adjusts the video image for the retail environment by enhancing the contrast, brightness, color, and sharpness.			
	Standard	Adjusts the image for the normal environment.			
	APS ()	Maximizes video images reducing power consumption without hurting picture quality.			
	Cinema	Optimizes the video image for a cinematic look to enjoy movies as if you are in a movie theater.			
	Sport	Optimizes video images for high and dynamic actions by emphasizing primary colors such as white, grass, or sky blue.			
	Game	Optimizes the video image for a fast gaming screen such as PCs or games.			
	Photo (Depending on model)	Optimizes the still image like a photo file in USB mode. » e.g.) when connecting the external device like a DSLR.			
	Expert	Adjusts the detailed video image settings for video experts as well as general viewers.			
<div style="border: 1px solid black; padding: 5px;"> <p> NOTE</p> <ul style="list-style-type: none"> If you select Intelligent Sensor, the option of the Energy saving feature will switch to Auto automatically (). </div>					
TruMotion (Depending on model)	Advance video technology that provides clearer, smoother images, even during fast action scenes creating a more stable structure for a crisper picture. TruMotion works with all inputs except PC mode. If you enable "TruMotion", noise may appear on the screen. If this occurs, set "TruMotion" to "Off". If you select "Picture Mode-Game", set "TruMotion" to "Off".				
	Option				
	High	Provides smoother picture movement.			
	Low	Provides smooth picture movement. Use this setting for standard use.			
	Off	Turn off TruMotion operation.			
	User	<table border="1" style="width: 100%;"> <tr> <td>De-Judder</td> <td>Adjusts noise of the screen.</td> </tr> <tr> <td>De-Blur</td> <td>Adjusts after-image of the screen.</td> </tr> </table>	De-Judder	Adjusts noise of the screen.	De-Blur
De-Judder	Adjusts noise of the screen.				
De-Blur	Adjusts after-image of the screen.				
SCREEN (RGB-PC)	Customizes the PC display options.				
	Option				
	Resolution	Selects a proper resolution when your PC uses 1024 X 768, 1280 X 768, or 1360 X 768 resolution.			
	Auto Configure	Sets the TV to optimize the options automatically for the TV display.			
	Position	Locates the image at the proper position.			
	Size	Adjusts the image size.			
	Phase	Eliminates horizontal streaking.			
	Reset	Restores the options to the default setting.			

Basic Image Options

Setting	Description
Backlight ()	Adjusts the brightness of the screen by controlling the LCD backlight. If you decrease the brightness level, the screen becomes darker and the power consumption will be reduced without any video signal loss. <div style="border: 1px solid black; padding: 5px;"> <p>NOTE</p> <ul style="list-style-type: none"> If you use the "Energy saving - Off, Minimum, Medium", Backlight will be available. </div>
Contrast	Increases or decreases the amplitude of the video signal. You may use Contrast when the bright part of the picture is saturated.
Brightness	Adjusts the base level of the signal in the picture.
Sharpness	Adjusts the level of crispness in the edges between the light and dark areas of the picture. The lower the level, the softer the image.
Color	Adjusts intensity of all colors.
Tint	Adjusts the balance between red and green levels.
Color Temp.	Sets to warm to enhance hotter colors such as red, or set to cool to enhance cooler colors such as blue.
Advanced Control	Customizes the advanced options.
Picture Reset	Restores the options of each mode to the factory default.

Advanced Image Options (Depending on model)

Setting	Description
Dynamic Contrast	Adjusts the contrast to keep it at the best level according to the brightness of the screen. The picture is improved by making bright parts brighter and dark parts darker.
Dynamic Color	Adjusts screen colors so that they look livelier, richer and clearer. This feature enhances hue, saturation and luminance so that red, blue and green white look more vivid.
Skin Color	It detects the skin area of video and adjusts it to express a natural skin color.
Noise Reduction	Reduces screen noise without compromising video quality.
Digital Noise Reduction	Removes noise caused by compressing video.
Gamma	You can adjust brightness of dark area and middle gray level area of the picture. <ul style="list-style-type: none"> » Low: Make the dark and middle gray level areas brighter. » Medium: Express the original picture level. » High: Make the dark and middle gray level area darker.
Black Level	Sets black level of the screen to proper level. <ul style="list-style-type: none"> » Low: The reflection of the screen gets darker. » High: The reflection of the screen gets brighter.
Clear White	Makes the white area of screen brighter and more white.
Eye Care	Adjusts the brightness of the screen to prevent the screen from being too bright. Dims extremely bright pictures. This feature is enabled in "Picture Mode-Standard, Sport, Game".
Real Cinema or Film Mode	Makes video clips recorded in film look more natural by eliminating judder effect. DVD and Blu-ray movies are filmed at 24 frames per second (fps). With LG Real Cinema, every frame is consistently processed 5 times in 1/24 of a second producing 120 fps with TruMotion or 2 times in 1/24 of a second producing 48 fps without TruMotion, thus totally eliminating the judder effect. This function can also work when TruMotion is off.

Setting	Description
Color Gamut	<p>Advanced Control Maximizes the utilization of color to increase color quality.</p> <ul style="list-style-type: none"> » Standard: Displays standard set of colors. » Wide: Increase number of colors used.
	<p>Expert Control Displays color domain of the signal.</p> <ul style="list-style-type: none"> » Standard: Displays standard set of colors. » Wide: Increase number of colors used. » EBU: Mode to display EBU standard color area. () » SMPTE: Mode to display SMPTE standard color area. () » BT709: Mode to display BT709 standard color area. ()
Edge Enhancer	Shows clearer and distinctive yet natural edges of the video. This function works well over Sharpness UI 60 value.
xvYCC	This is produces richer colors. This feature represents rich colors as much as a conventional video signal. This function is enabled in "Picture mode - Cinema, Expert" when xvYCC signal is inputted through HDMI.
Color Filter	This is the function to filter the specific colors of the video. You can use the RGB filter to set color saturation and hue accurately.
Expert Pattern	This is the pattern used for expert adjustment. This function is enabled in "Picture Mode - Expert" when you watch DTV.
Color Temperature	<p>Adjusts the overall color of the screen by changing the white baseline.</p> <div style="display: flex; align-items: flex-start;"> <div style="flex: 1;">  </div> <div style="flex: 2;"> <p>a. Gamma : Select Low, Medium, High b. Method : 2 Points</p> <ul style="list-style-type: none"> • Pattern: Inner, Outer • Red/Green/Blue Contrast, Red/Green/Blue Brightness </div> <div style="flex: 1;"> <p>c. Method : 20 Point IRE</p> <ul style="list-style-type: none"> • IRE (Institute of Radio Engineers) is the unit to display the size of the video signal and can be set among 0, 5, 10, 15 - 100 Plasma TV. You can adjust Red, Green or Blue according to each setting. • Red/Green/Blue: The adjustment range is -50 - +50. </div> </div>
	<div style="display: flex; align-items: flex-start;"> <div style="flex: 1;">  </div> <div style="flex: 2;"> <p>d. Apply to all inputs</p> </div> <div style="flex: 1;"> <p>c. Method : 10 Point IRE</p> <ul style="list-style-type: none"> • Pattern: Inner, Outer • IRE (Institute of Radio Engineers) is the unit to display the size of the video signal and can be set among 0, 10, 20, 30 - 100. You can adjust Red, Green or Blue according to each setting. • Luminance: This function displays calculated luminance value for 2.2 gamma. You can input luminance value you want at 100 IRE, than the target luminance value for 2.2 gamma is displayed at every 10 steps from 10 IRE to 90 IRE. • Red/Green/Blue: The adjustment range is -50 - +50. </div> </div>
Color Management System	<p>As the tool used by the experts to make adjustments by using the test patterns, this does not affect other colors but can be used to selectively adjust the 6 color areas (Red/Green/Blue/Cyan/Magenta/Yellow). Color difference may not be distinctive even when you make the adjustments for the general video. Adjusts Red/Green/Blue/Yellow/Cyan/Magenta. Red/Green/Blue/Yellow/Cyan/Magenta Color: The adjustment range is -30 - +30. Red/Green/Blue/Yellow/Cyan/Magenta Tint: The adjustment range is -30 - +30. This feature is disable in RGB-PC and HDMI-PC mode.</p>

AUDIO Settings

- 1 Press **Home** to access the main menus.
- 2 Press the Navigation buttons to scroll to **AUDIO** and press **ENTER**.
- 3 Press the Navigation buttons to scroll to the setting or option you want and press **ENTER**.
 - To return to the previous level, press **BACK**.
- 4 When you are finished, press **EXIT**.

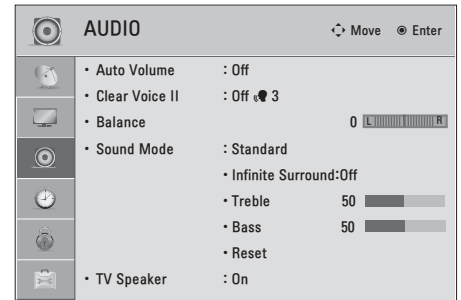

The available audio settings are described in the following.

Setting	Description																						
Auto Volume	Activates the Auto Volume feature to keep the volume level consistent whenever you change channels. The volume level may not be consistent due to different signal conditions of broadcasting stations.																						
Clear Voice II	Sets whether to enhance human voice clarity. You can adjust the level of clarity when you set this feature on.																						
Balance	Adjusts balance between the left and right speakers according to your room environment.																						
Sound Mode	Selects one of the preset sound modes or customizes options in each mode. <table border="1" style="width: 100%; border-collapse: collapse;"> <thead> <tr> <th colspan="2">Mode</th> </tr> </thead> <tbody> <tr> <td>Standard</td> <td>Select when you want standard-quality sound.</td> </tr> <tr> <td>Music</td> <td>Select when you listen to music.</td> </tr> <tr> <td>Cinema</td> <td>Select when you watch movies.</td> </tr> <tr> <td>Sport</td> <td>Select when you watch sports events.</td> </tr> <tr> <td>Game</td> <td>Select when you play games.</td> </tr> </tbody> </table> <div style="border: 1px solid black; padding: 10px; margin-top: 10px;"> <p>NOTE</p> <ul style="list-style-type: none"> • If sound quality or volume is not at the level you want, it is recommended to use a separate home theater system or amplifier to cope with different user environments. • If the Clear Voice II feature is on, Infinite Surround will not be activated. </div> <table border="1" style="width: 100%; border-collapse: collapse; margin-top: 10px;"> <thead> <tr> <th colspan="2">Option</th> </tr> </thead> <tbody> <tr> <td>Infinite Surround</td> <td>Infinite Surround is a patented LG proprietary sound processing technology that strives immersive 5.1 surround sound with just two front speakers.</td> </tr> <tr> <td>Treble</td> <td>Controls the dominant sounds in the output. When you turn up the treble, it will increase the output to the higher frequency range.</td> </tr> <tr> <td>Bass</td> <td>Controls the softer sounds in the output. When you turn up the bass, it will increase the output to the lower frequency range.</td> </tr> <tr> <td>Reset</td> <td>Resets the sound mode to the default setting.</td> </tr> </tbody> </table>	Mode		Standard	Select when you want standard-quality sound.	Music	Select when you listen to music.	Cinema	Select when you watch movies.	Sport	Select when you watch sports events.	Game	Select when you play games.	Option		Infinite Surround	Infinite Surround is a patented LG proprietary sound processing technology that strives immersive 5.1 surround sound with just two front speakers.	Treble	Controls the dominant sounds in the output. When you turn up the treble, it will increase the output to the higher frequency range.	Bass	Controls the softer sounds in the output. When you turn up the bass, it will increase the output to the lower frequency range.	Reset	Resets the sound mode to the default setting.
Mode																							
Standard	Select when you want standard-quality sound.																						
Music	Select when you listen to music.																						
Cinema	Select when you watch movies.																						
Sport	Select when you watch sports events.																						
Game	Select when you play games.																						
Option																							
Infinite Surround	Infinite Surround is a patented LG proprietary sound processing technology that strives immersive 5.1 surround sound with just two front speakers.																						
Treble	Controls the dominant sounds in the output. When you turn up the treble, it will increase the output to the higher frequency range.																						
Bass	Controls the softer sounds in the output. When you turn up the bass, it will increase the output to the lower frequency range.																						
Reset	Resets the sound mode to the default setting.																						
TV Speaker	Turns on the internal speaker of the TV when using an external Hi-Fi system. You can use the TV speaker as an audio output device even if there is no video input.																						

TIME Settings

- 1 Press **Home** to access the main menus.
- 2 Press the Navigation buttons to scroll to **TIME** and press **ENTER**.
- 3 Press the Navigation buttons to scroll to the setting or option you want and press **ENTER**.
- To return to the previous level, press **BACK**.
- 4 When you are finished, press **EXIT**.

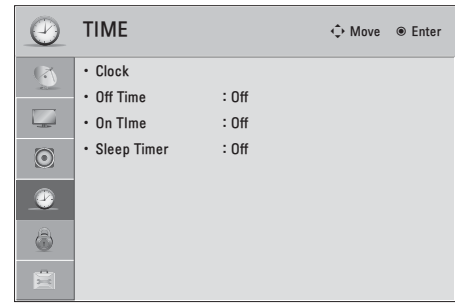

The available time settings are described in the following

Setting	Description
Clock	Sets the time, date, time zone, and daylight-saving time feature. The time will be set automatically according to a digital channel signal which includes time information provided by the broadcasting station. If not, set the time and date manually.
Off Time/On Time	Sets the time to turn on or off the TV automatically. To use this function, you should set the current time and date in advance. <div style="border: 1px solid black; padding: 5px;"> <p>NOTE</p> <ul style="list-style-type: none"> • If you do not press any button within 2 hours after the TV turns on by the On Time feature, the TV enters the Standby mode automatically. • If you set both Off time and On time features to the same time, the Off time feature overrides the On time feature. </div>
Sleep Timer	Sets the length of time until the TV to turns off. When you turn the TV off and turn it on again, the Sleep timer feature will be set to off.

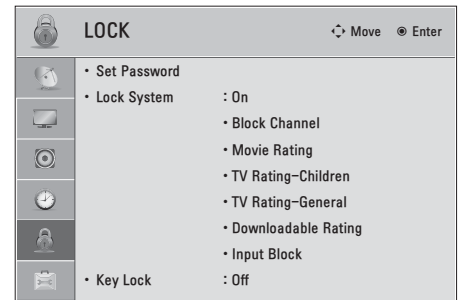

LOCK Settings

- 1 Press **Home** to access the main menus.
- 2 Press the Navigation buttons to scroll to **LOCK** and press **ENTER**.
- 3 Press the Navigation buttons to scroll to the setting or option you want and press **ENTER**.
 - To return to the previous level, press **BACK**.
- 4 When you are finished, press **EXIT**.



The available lock settings are described in the following.

Setting	Description	
Lock System	Activates or deactivates the lock system.	
Set Password	Changes the 4-digit password. The default PIN is "0 0 0 0". If you forget your password, press "0-3-2-5" on the remote control.	
Block Channel	Blocks the channels that contain inappropriate contents for children by pressing the Yellow button. The Lock icon appears in front of the blocked channels. The channels can be selected but the screen blank and the audio is muted. To watch a locked channel, enter the password.	
Movie Rating	Blocks the movies that are only broadcasted on the TV and contain inappropriate contents, based on the Motion Picture Association of America (MPAA) rating.	
	Rating	
	G	General audiences – All ages admitted
	PG	Parental guidance suggested – Some material may not be suitable for children
	PG-13	Parents strongly cautioned – Some material may be inappropriate for children under 13
	R	Restricted – Under 17 requires accompanying parent or adult guardian
	NC-17	No one 17 and under admitted
	X	Adults only
Blocking Off	Permits all programs	
TV Rating-Children (Depending on model)	Blocks the children's TV programs that parents do not want their children to watch. To block other TV programs, you should set the TV Rating-General feature.	
	Rating	
	Age	TV-Y (All children, including children from ages 2-6) TV-Y7 (Directed to older children, suitable for children age 6 and above)
	Fantasy Violence	TV-Y7 (Directed to older children – Fantasy violence, suitable for children age 6 and above, containing more intense or combative fantasy violence)

Setting	Description
TV Rating-General (Depending on model)	Blocks the TV programs that you want based on the ratings by using the Parental Control Function (V-Chip).  NOTE <ul style="list-style-type: none"> The V-Chip electronically reads TV program ratings and allows parents to block program that are unsuitable for children.
	Rating
	Age TV-G (General audience, suitable for all ages) TV-PG (Parental guidance suggested, containing material that are unsuitable for younger children) TV-14 (Parents strongly cautioned, containing material that are unsuitable for children age 14 and under) TV-MA (Mature audience only, unsuitable for children age under 17)
	Dialog (suggestive dialogue) TV-PG or TV-14
	Language (coarse language) TV-PG, TV-14, or TV-MA
	Sex (sexual situation) TV-PG, TV-14, or TV-MA
	Violence TV-PG, TV-14, or TV-MA
TV Rating-English (Depending on model)	Selecting Canadian English rating system.
	Rating
	E Exempt
	C Children
	C8+ Children eight years and older
	G General programming, suitable for all audiences
	PG Parental Guidance
	14+ Viewers 14 years and older
	18+ Adult programming
Blocking Off Permits all programs	
TV Rating-French (Depending on model)	Selecting Canadian French rating system.
	Rating
	E Exempt
	G General
	8ans+ General-Not convenient for little children
	13ans+ Not convenient for children of 13 years and younger
	16ans+ Not convenient for children of 16 years and younger
	18ans+ This programs is only for adults
Blocking Off Permits all programs	
Downloadable Rating	This function operates only when TV has received Region5 Rating data. The name of the rating option may differ.  NOTE <ul style="list-style-type: none"> This feature is available only for digital channels.
Input Block	Blocks the input sources.
Key Lock	Locks or unlocks the buttons on the TV.



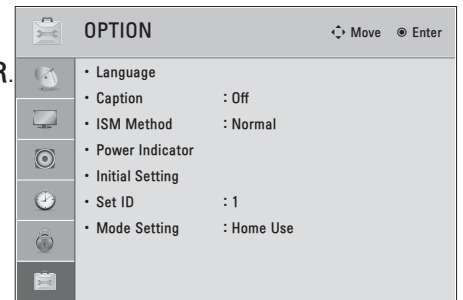

OPTION Settings

- 1 Press **Home** to access the main menus.
- 2 Press the Navigation buttons to scroll to **OPTION** and press **ENTER**.
- 3 Press the Navigation buttons to scroll to the setting or option you want and press **ENTER**.
 - To return to the previous level, press **BACK**.
- 4 When you are finished, press **EXIT**.



The available general settings are described in the following.

Setting	Description
Language	Selects a desired language.
	Option
	Menu Language Selects a language for the display text.
Audio Language Selects an audio language for your program. This feature operates only in the DTV or CADTV mode.	
Caption	Sets whether to display captions and customize your option in each mode.
	Mode
	CC 1-4 (Closed Captioning) Displays the audio portion of a TV program as text on the TV screen. CC1 is the most common mode in use.
	Text 1-4 - Field 1 data channels: two Captions (CC1, CC2) and two Text (T1, T2). - Field 2 data channels: two Captions (CC3, CC4) and two Text (T1, T2).
	Service 1-6 This is only available for the digital broadcasting system.
	Option (For DTV, CADTV)
	Size Selects the word size.
	Font Selects a typeface for the text.
	Text Color Selects a color for the text.
	Text Opacity Adjusts the opacity for the text color.
	Bg Color Selects a background color.
	Bg Opacity Adjusts the opacity for the background color.
	Edge Type Selects an edge type.
	Edge Color Selects a color for the edges.
Power Indicator (LED LCD TV)	Sets to turn on or off the indicator light on the TV.
	Option
	Standby Light Sets to turn on or off the indicator light in Standby mode.
Power Light Sets to turn on or off the indicator light when you turn on the power.	

Setting	Description	
ISM Method 	Prevents image sticking or removes a ghost image. A frozen still picture displayed on the screen for prolonged periods can result in a ghost image.	
	Mode	
	Normal	Sets it if image sticking is never a problem.
	Orbiter	Avoids a ghost image on the screen. The image will move every 2 minutes to help prevent ghost images. However, it is best not to allow any fixed image to remain on the screen.
	Color Wash	Removes a ghost image on the screen. The color block with the screen moved a little and the white pattern are alternately displayed. It is difficult to see the after image on all colors. Once it has been corrected it will not be visible in any color.
White Wash	Removes a ghost image on the screen. Use sparingly. Watch the TV normally for a while before using this feature to see if the ghost image disappears on its own.	
<div style="border: 1px solid black; padding: 5px;">  NOTE <ul style="list-style-type: none"> An excessive ghosted image may be impossible to clear entirely with White Wash. To return to normal viewing, press the any button. </div>		
Initial Setting	Resets the TV to factory default and erases all stored channels. Customizes the TV settings to suit your preference. The initial setup screen will appear when you turn on the TV for the first time.	
	<div style="border: 1px solid black; padding: 5px;">  NOTE <ul style="list-style-type: none"> When selecting "Lock System - On" in the LOCK menu, the message to enter the password appears. If you forget your password, press "0-3-2-5" on the remote control. </div>	
	Setting	
	Language	Selects a desired language.
	Mode Setting	Selects Home Use for the home environment. Selects Store Demo for the retail environment. Selects Demo Mode to set to show special features of the TV. You can cancel the demo mode by pressing any buttons except the Volume and Mute buttons.
	<div style="border: 1px solid black; padding: 5px;">  NOTE <ul style="list-style-type: none"> When selecting Store Demo, Demo Mode will be activated. </div>	
	Power Indicator (LED LCD TV)	Turns the power indicator light on or off.
	Time Zone	Sets the time zone and daylight saving.
Auto Tuning	Scans and saves available channels automatically.	
Set ID	Adds an ID to the connected devices.	
Mode Setting	Default selection is "Home Use". We recommend setting the TV to "Home Use" mode for the best picture in your home environment.	
	Option	
	Home Use	Selects it for the home environment.
	Store Demo	Selects it for the retail environment.
	Demo Mode	Sets to show special features of the TV. You can cancel the demo mode by pressing any buttons except the Volume and Mute buttons.

MAKING CONNECTIONS

Connect various external devices to the TV and switch input modes to select an external device. For more information of external device's connection, refer to the manual provided with each device.

Available external devices are: HD receivers, DVD players, VCRs, audio systems, USB storage devices, PC, gaming devices, and other external devices.

**NOTE**

- If you record a TV program on a DVD recorder or VCR, make sure to connect the TV signal input cable to the TV through a DVD recorder or VCR. For more information of recording, refer to the manual provided with the connected device.
- The external device connection may differ from the model.
- Connect external devices to the TV regardless of the order of the TV port.

Connection Overview

Connect various external devices to the ports on the TV back panel.

- 1 Find an external device you want to connect to your TV as shown on the following illustration.
- 2 Check the connection type of the external device.
- 3 Go to the appropriate illustration and check the connection details.

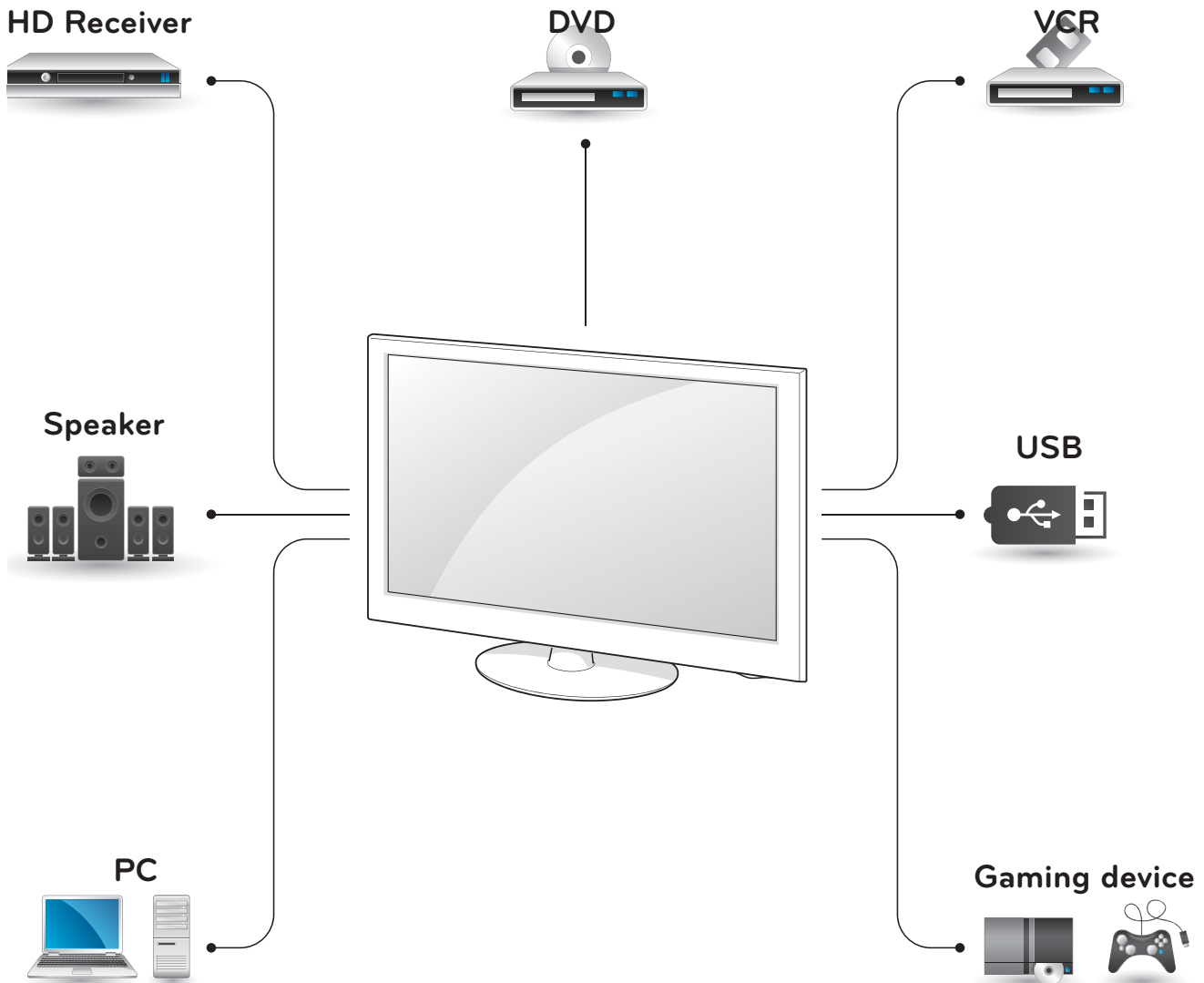

HDMI – See p.76

DVI – See p.76

Component – See p.77

Composite – See p.77

Digital – See p.80

RGB – See p.79

Memory storage – See p.80

Memory card reader – See p.80



NOTE

- If you connect a gaming device to the TV, use the cable supplied with the gaming device.
- Refer to the external equipment's manual for operating instructions.

- This part of MAKING CONNECTIONS mainly uses picture for PW350, LV3500 series.

Connecting to a HD receiver, DVD or VCR player

Connect a HD receiver, DVD, or VCR player to the TV and select an appropriate input mode.

HDMI Connection

Transmits the digital video and audio signals from an external device to the TV. Connect the external device and the TV with the HDMI cable as shown in the following illustration.

NOTE

- Use the latest High Speed HDMI™ Cable with CEC (Customer Electronics Control) function.
- High Speed HDMI™ Cables are tested to carry an HD signal up to 1080p and higher.

PW350 series

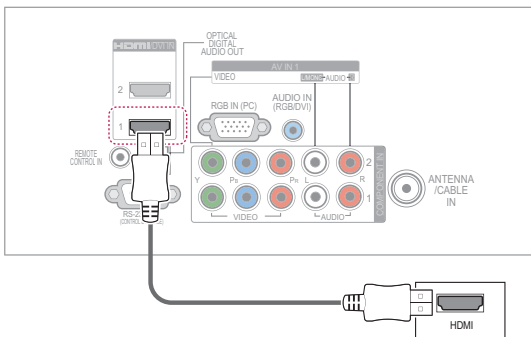

LV3500 series

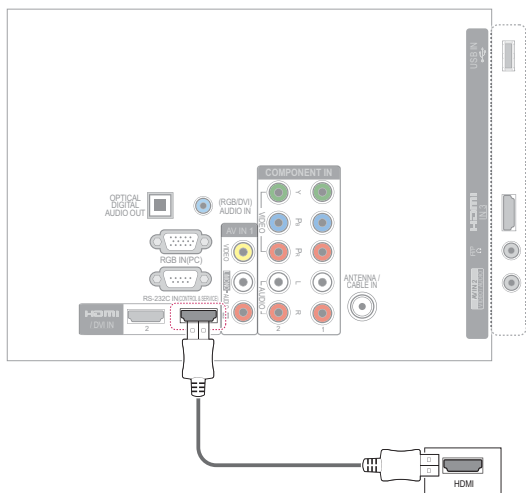

DVI to HDMI Connection

Transmits the digital video signal from an external device to the TV. Connect the external device and the TV with the DVI-HDMI cable as shown in the following illustration. To transmit an audio signal, connect an audio cable.

PW350 series

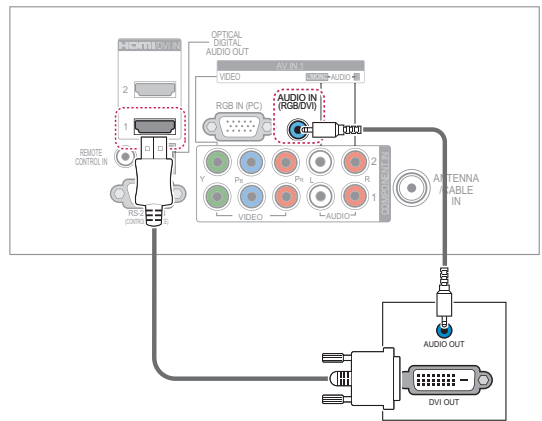

LV3500 series

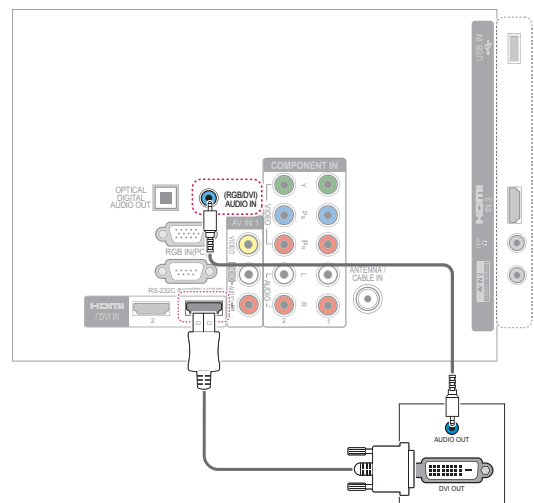

Component Connection

Transmits the analog video and audio signals from an external device to the TV. Connect the external device and the TV with the component cable as shown in the following illustration.

PW350 series

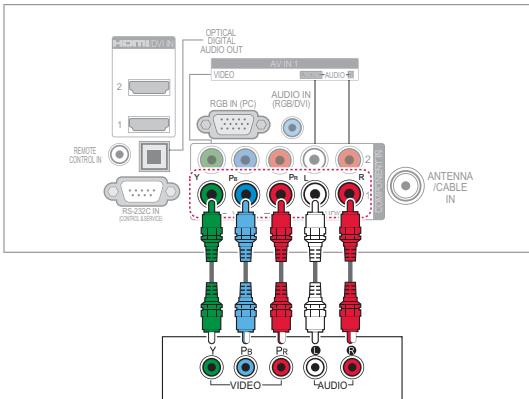

LV3500 series

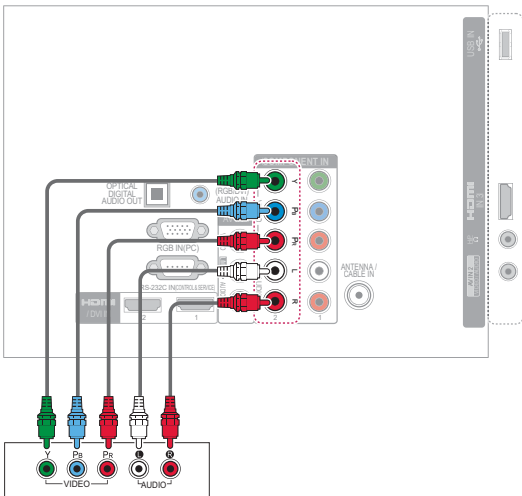

! NOTE

- If cables are installed incorrectly, it could cause the image to display in black and white or with distorted color. Check to ensure the cable are matched with the corresponding color connection.

Composite Connection

Transmits the analog video and audio signals from an external device to the TV. Connect the external device and the TV with the composite cable as shown in the following illustration.

! NOTE

- If you have a mono VCR, connect the audio cable from the VCR to the AUDIO L/MONO jack of the TV.

PW350 series

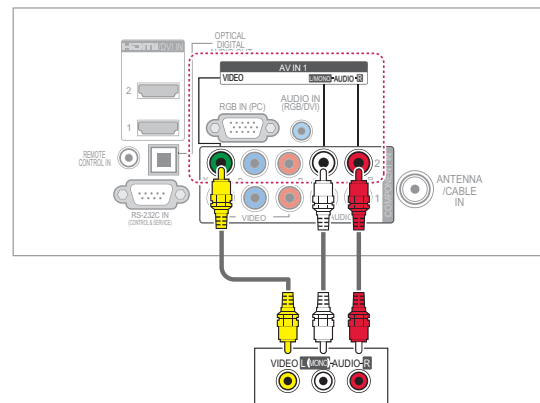

LV3500 series

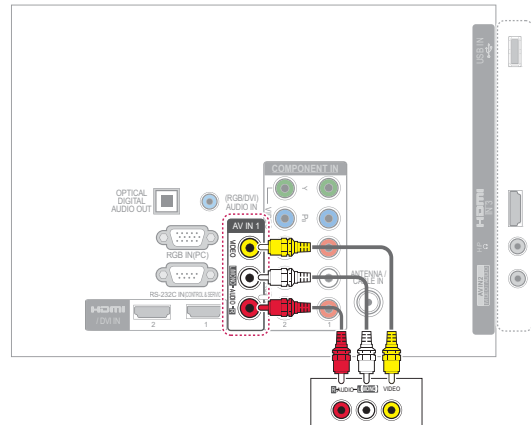

(For only 32LV2500, 32LV2520, LV3500, LV3520, LW5000, LW5300 series)

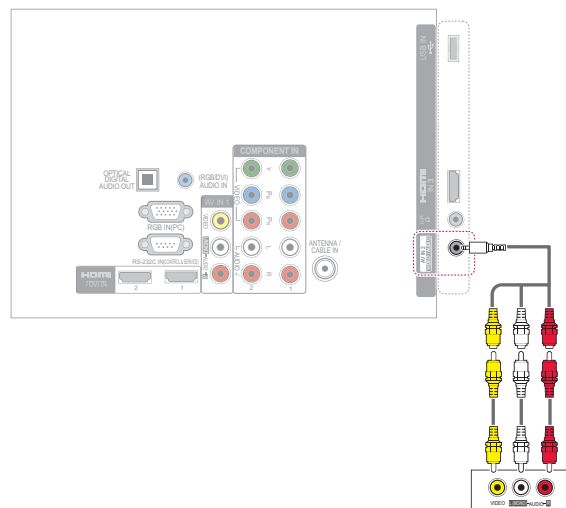

Connecting to a PC

NOTE

- It is recommended to use the TV set with the HDMI connection for the best image quality.

HDMI Connection

Transmits the digital video and audio signals from your PC to the TV. Connect the PC and the TV with the HDMI cable as shown in the following illustration.

PW350 series

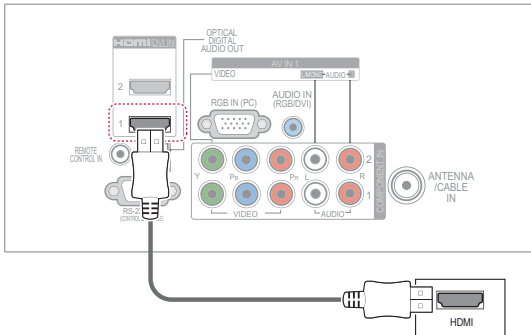

LV3500 series

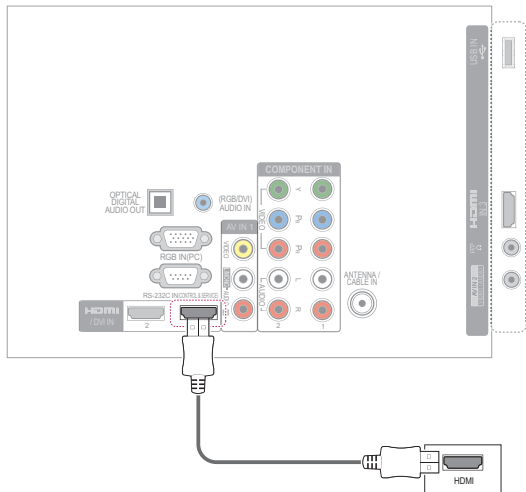

DVI to HDMI Connection

Transmits the digital video signal from your PC to the TV. Connect the PC and the TV with the DVI-HDMI cable as shown in the following illustration. To transmit an audio signal, connect an audio cable.

PW350 series

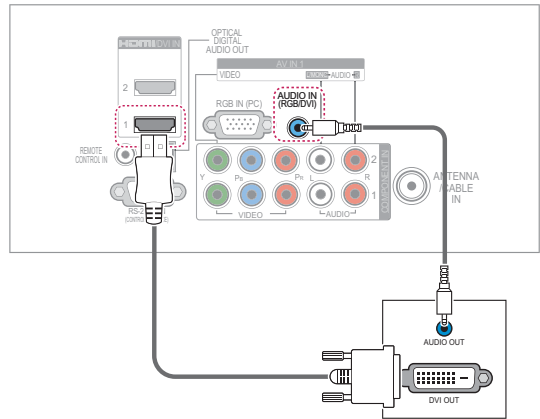

LV3500 series

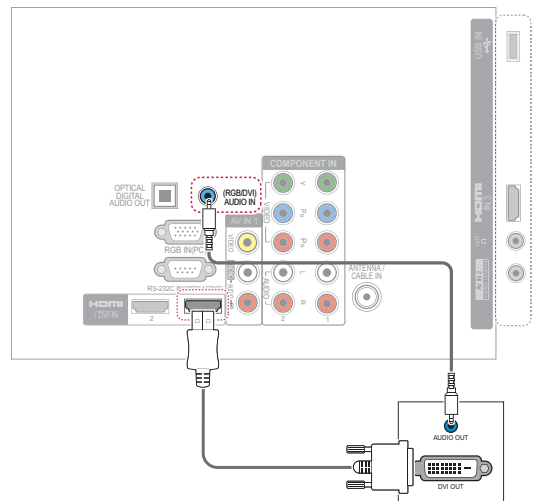

RGB Connection

Transmits the analog video signal from your PC to the TV. Connect the PC and the TV with the D-sub 15 pin signal cable as shown in the following illustrations. To transmit an audio signal, connect an audio cable.

PW350 series

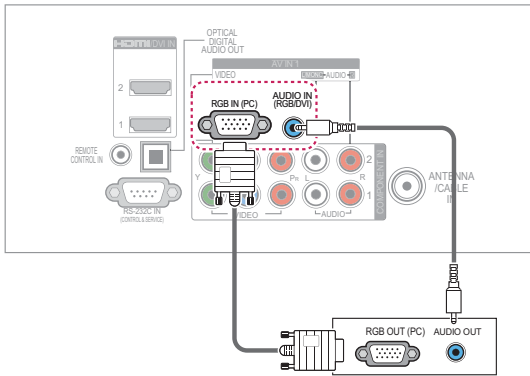

LV3500 series

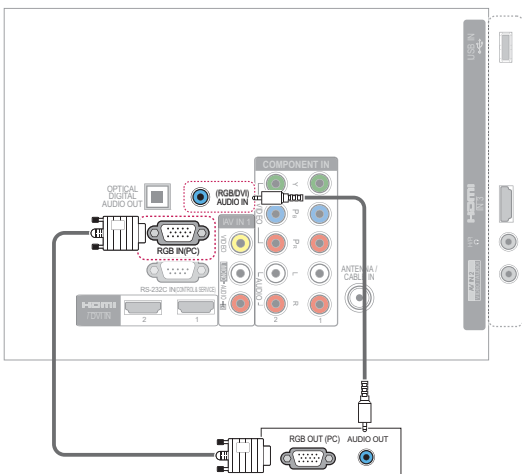

NOTE

- To get the best picture quality, adjust the PC graphics card to

LCD	Resolution
22LV2500, LV3500, LV3520, LW5000, LW5300, LK430, LK450, LK520 series	1920x1080
Other models	1360x768

Plasma	Resolution
PZ200 series	1920x1080
Other models	1024x768

- Depending on the graphics card, DOS mode may not work if a HDMI to DVI Cable is in use.
- In PC mode, there may be noise associated with the resolution, vertical pattern, contrast or brightness.
- If noise is present, change the PC output to another resolution, change the refresh rate to another rate or adjust the brightness and contrast on the PICTURE menu until the picture is clear.
- Avoid keeping a fixed image on the screen for a long period of time. The fixed image may become permanently imprinted on the screen.
- The synchronization input form for Horizontal and Vertical frequencies is separate.
- Depending on the graphics card, some resolution settings may not allow the image to be positioned on the screen properly.
- When selecting HDMI-PC, set the "Input Label - PC" in the INPUT menu.

Connecting to an Audio System

Use an optional external audio system instead of the built-in speaker.

! NOTE

- If you use an optional external audio device instead of the built-in speaker, set the TV speaker feature to off (See p.68).

Digital optical audio connection

Transmits the digital audio signal from the TV to an external device. Connect the external device and the TV with the optical audio cable as shown in the following illustration.

PW350 series

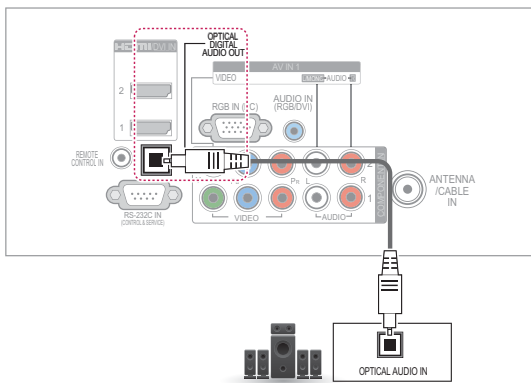

LV3500 series

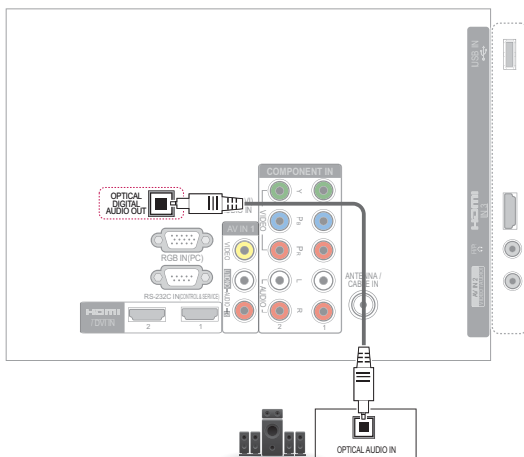

Connecting to a USB

Connect a USB storage device such as a USB flash memory, external hard drive or a USB memory card reader to the TV and access the My media menu to use various multimedia files. See "Connecting USB storage devices" on p.51 and "Browsing files" on p. 52.

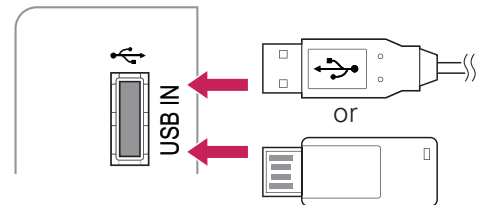

Connecting to a Headphone (LCD)

Listen to the sound through a headphone.

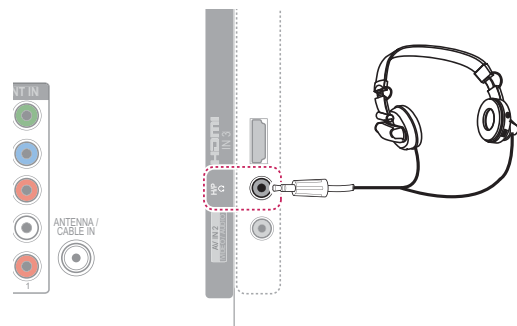

! NOTE

- AUDIO menu options are disabled when connecting a headphone.
- When changing AV MODE with a headphone connected, the change is applied to video but not to audio.
- Optical Digital Audio Out is not available when connecting a headphone.
- Headphone impedance: 16 Ω
- Max audio output: 10 mW to 15 mW
- Headphone jack size: 0.35 cm (0.13 inches)

SIMPLINK Connection

Use the TV remote control to play and control the AV device connected with the HDMI cable through HDMI-CEC. Your TV only works with the devices that support HDMI-CEC. But only devices with the **SIMPLINK** logo are fully supported.

Connect one end of the HDMI cable to the HDMI/DVI IN or HDMI IN terminal on the rear of the TV and the other end to the SIMPLINK device.

NOTE

- If the connected device does not support HDMI-CEC, the SIMPLINK feature is unavailable.
- To operate SIMPLINK, you should use an High Speed HDMI cable with the CEC (Consumer Electronics Control) function.
- SIMPLINK may not work properly if you a third-party device that has an HDMI-CEC function.

Activating and Using the SIMPLINK menus

- 1 Press **SIMPLINK** to access the SIMPLINK menus.
- 2 Press the Navigation buttons to select to **On**.
- 3 Press the Navigation buttons to scroll to one of the devices and press **ENTER**.

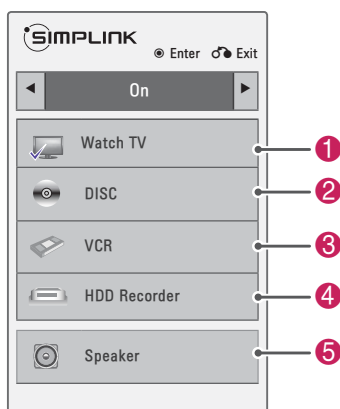

No.	Description
①	Displays the previously viewed TV channel.
②	Plays discs. When multiple discs are available, the title of the disc appears at the bottom of the screen.
③	Controls the connected VCR.
④	HDD recordings playback: Controls the recording stored in HDD.
⑤	Audio out to home theater speaker or Audio out to TV: Changes the audio output between Home theater speaker and TV speaker.

- A check mark appears in front of the selected device.
 - Available devices display in a bright color.
 - Unavailable devices display in grey.
- 4 Control the selected AV device.
 - Direct Play: After connecting AV devices to the TV, you can directly control the devices and play media without additional settings.
 - Select AV device: Enables you to select one of the AV devices connected to the TV.
 - Disc playback: Control connected AV devices by pressing the Navigation buttons, **ENTER**, **▶**, **■**, **||**, **◀** and **▶▶**.
 - Power off all devices: When you power off the TV, all connected devices are turned off.
 - Switch audio-out: Offers an easy way to switch audio-out.
 - Sync Power on: When the equipment with SIMPLINK function connected HDMI terminal starts to play, The TV will automatically turn on.

NOTE

- If you change the input source by pressing **INPUT**, the progressing function of the SIMPLINK device will stop.
- If you select a device that has the home theater feature, the sound output automatically switches to the home theater speaker and the TV speaker turns off.
- If a connected SIMPLINK home theater system does not play the audio from the TV, connect the DIGITAL AUDIO OUT terminal on the rear of the TV to the DIGITAL AUDIO IN terminal on the back of the SIMPLINK device with an optical cable.

MAINTENANCE

Update and clean your TV regularly to keep the best performance and to extend the product lifespan.

Cleaning Your TV



CAUTION

- Make sure to turn the power off and disconnect the power cord and all other cables first.
- When the TV is left unattended and unused for a long time, disconnect the power cord from the wall outlet to prevent possible damage from lightning or power surges.

Screen and frame

To remove dust or light dirt, wipe the surface with a dry, clean, and soft cloth.

To remove major dirt, wipe the surface with a soft cloth dampened in clean water or a diluted mild detergent. Then wipe immediately with a dry cloth.



CAUTION

- Do not push, rub, or hit the surface with your fingernail or a sharp object, as this may result in scratches on the screen and image distortions.
- Do not use any chemicals, such as waxes, benzene, alcohol, thinners, insecticides, air fresheners, lubricants, as these may damage the screen's finish and cause discoloration.

Cabinet and stand

To remove dust or light dirt, wipe the cabinet with a dry, clean, and soft cloth.

To remove major dirt, wipe the cabinet with a soft cloth dampened in a clean water or water containing a small amount of mild detergent. Then wipe immediately with a dry cloth.



CAUTION

- Do not spray liquid onto the surface. If water enters the TV, it may result in fire, electric shock, or malfunction.
- Do not use any chemicals as this may deteriorate the surface.

Power cord

Remove the accumulated dust or dirt on the power cord regularly.

Preventing "Image burn" or "Burn-in" on your TV screen

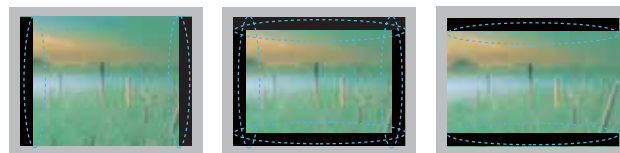

- If a fixed image displays on the TV screen for a long period of time, it will be imprinted and become a permanent disfigurement on the screen. This is "image burn" or "burn-in" and not covered by the warranty.
- If the aspect ratio of the TV is set to 4:3 for a long period of time, image burn may occur on the letterboxed area of the screen.
- Avoid displaying a fixed image on the TV screen for a long period of time (2 or more hours for LCD, 1 or more hours for the Plasma TV) to prevent image burn.

TROUBLESHOOTING

General

Problem	Resolution
Cannot control the TV with the remote control.	<ul style="list-style-type: none"> • Check the remote control sensor on the product and try again. • Check if there is any obstacle between the product and the remote control. • Check if the batteries are still working and properly installed (⊕ to ⊕, ⊖ to ⊖). • Check if the appropriate input mode such as TV or VCR is set for using the remote control.
No image display and no sound is produced.	<ul style="list-style-type: none"> • Check if the product is turned on. • Check if the power cord is connected to a wall outlet. • Check if there is a problem in the wall outlet by connecting other products.
Image appears slowly when the TV turns on.	<ul style="list-style-type: none"> • The image is muted during the product startup process. This is normal. If the image does not appear in a few minutes, unplug the TV for 30 seconds and try again. If the image still does not appear, contact the authorized service center in your local area.
Cannot connect external devices.	<ul style="list-style-type: none"> • Refer to the "Connection Overview" and connect an external device.
The TV turns off suddenly.	<ul style="list-style-type: none"> • Check the power control settings. The power supply may be interrupted. • Check if the Auto sleep feature is activated in the Time settings. Refer to the "Sleep Timer". • If there is no signal while the TV is on, the TV will turn off automatically after 15 minutes of inactivity.

Audio

Problem	Resolution
No sound is produced while images are displaying.	<ul style="list-style-type: none"> • Press VOL + or - button. • Check if the sound is muted by pressing MUTE. • Scroll to other channels. There may a problem with the broadcast. • Check if the TV Speaker feature is activated in the menu option.
No output from one of the speakers	<ul style="list-style-type: none"> • Adjust Balance in the menu option.
Unusual sound from inside the TV is produced.	<ul style="list-style-type: none"> • A change in ambient humidity or temperature may result in an unusual noise when the product turns on or off. There is no problem with your product.

Video

Problem	Resolution
An image displays in black and white or the color quality is poor.	<ul style="list-style-type: none"> Adjust the color setting in the menu option. Keep a sufficient distance between this product and other electronic products. Scroll to other channels. There may a problem with the broadcast.
Horizontal or vertical bars appears or images blur	<ul style="list-style-type: none"> Check if there are local interferences such as an electrical appliance or power tool.
Lines or streaks appear on images	<ul style="list-style-type: none"> Check the antenna or aim the antenna to the proper direction.
Afterimages (ghosts) appear when the product turns off	<ul style="list-style-type: none"> Pixels may have been damaged from a fixed image displayed for a long time (image burn). Use a screen saver to prevent the pixel damage on the screen.
The power is on but the screen appears extremely dark.	<ul style="list-style-type: none"> Adjust the brightness and contrast in the menu option.
"No Signal" appears on the screen.	<ul style="list-style-type: none"> Check if the signal cable is connected between the TV and products properly. Check the selected input source by pressing INPUT.
Black spots appear on the screen.	<ul style="list-style-type: none"> Several pixels in red, green, white, or black may appear on the screen that can attribute to the characteristics of the LCD panel. This is normal.
The display offset is wrong.	<ul style="list-style-type: none"> Adjust the position setting in the Picture menu. Check if the video card resolution and frequency are supported by the product. If the frequency is out of range, set to the recommended resolution using the display settings on the external device.
Thin lines appear in the background of the screen.	<ul style="list-style-type: none"> Check the video cable connections.
Horizontal noises appear or characters blur.	<ul style="list-style-type: none"> Adjust the Phase setting in the menu option. Refer to the "SCREEN (RGB-PC)".
The reception on some channels is poor	<ul style="list-style-type: none"> Scroll to other channels. There may a problem with the broadcast. The station signal may be weak. Aim the antenna to the proper direction. Check if there is local interferences such as an electrical appliance or power tool.

Movie

Problem	Resolution
The file does not appear on the Movie List.	<ul style="list-style-type: none"> Check whether the extension is supported.
Message is displayed saying "This file is invalid" or the audio is working normally but the video is not working normally.	<ul style="list-style-type: none"> Check whether the file is playing normally on a PC. (Check whether the file is damaged.) Check whether the resolution is supported. Check whether the video/audio codec is supported. Check whether the frame rate is supported.
Message is displayed saying "Unsupported Audio" or the video is working normally but the audio is not working normally.	<ul style="list-style-type: none"> Check whether the file is playing normally on a PC. (Check whether the file is damaged.) Check whether the audio codec is supported. Check whether the bit rate is supported. Check whether the sample rate is supported.
Subtitle is not working.	<ul style="list-style-type: none"> Check whether the file is playing normally on a PC. (Check whether the file is damaged.) Check whether the video file and subtitle file name are the same. Check whether the video file and subtitle file are located in the same folder. Check whether the subtitle file is supported. Check whether the language is supported. (When you open the subtitle file in Memo Pad, you can check the language of the subtitle file.)

SPECIFICATIONS

Product specifications may be changed without prior notice due to upgrade of product functions.

Television System		NTSC-M, ATSC, 64 & 256 QAM
Program Coverage		VHF 2-13, UHF 14-69, CATV 1-135, DTV 2-69, CADTV 1-135
External Antenna Impedance		75 Ω
Environment condition	Operating Temperature	0 - 40 °C
	Operating Humidity	Less than 80 %
	Storage Temperature	-20 - 60 °C
	Storage Humidity	Less than 85 %

MODELS		42PW340 (42PW340-UB)	50PW340 (50PW340-UB)
		42PW350 (42PW350-UE)	50PW350 (50PW350-UE)
		42PW350U (42PW350U-UC)	50PW350U (50PW350U-UC)
		42PW350R (42PW350R-MA)	50PW350R (50PW350R-MA)
Dimensions (W x H x D)	With stand	991.8 mm x 667.0 mm x 230.5 mm (39.0 inch x 26.2 inch x 9.0 inch)	1176.1 mm x 774.7 mm x 289.8 mm (46.3inch x 30.5 inch x 11.4 inch)
	Without stand	991.8 mm x 613.8 mm x 52.5 mm (39.0 inch x 24.1 inch x 2.0 inch)	1176.1 mm x 716.5 mm x 52.5 mm (46.3 inch x 28.2 inch x 2.0 inch)
Weight	With stand	21.5 kg (47.3 lbs)	29.6 kg (65.2 lbs)
	Without stand	20.0 kg (44.0 lbs)	27.3 kg (60.1 lbs)
Current Value / Power consumption		2.3 A / 230 W	3.0 A / 300 W
Power requirement		AC100 - 240 V ~ 50/60 Hz	

MODELS		50PZ200 (50PZ200-UA)	60PZ200 (60PZ200-UA)
Dimensions (W x H x D)	With stand	1171.9 mm x 770.9 mm x 289.8 mm (46.1 inch x 30.3 inch x 11.4 inch)	1390.8 mm x 905.2 mm x 334.7 mm (54.7 inch x 35.6 inch x 13.1 inch)
	Without stand	1171.9 mm x 712.2 mm x 52.5 mm (46.1 inch x 28.0 inch x 2.0 inch)	1390.8 mm x 835.5 mm x 52.5 mm (54.7 inch x 32.8 inch x 2.0 inch)
Weight	With stand	29.8 kg (65.6 lbs)	42.6 kg (93.9 lbs)
	Without stand	27.5 kg (60.6 lbs)	38.5 kg (84.8 lbs)
Current Value / Power consumption		3.5 A / 350 W	5.3 A / 530 W
Power requirement		AC100 - 240 V ~ 50/60 Hz	

MODELS		42LW5000 (42LW5000-UC)
Dimensions (W x H x D)	With stand	998.0 mm x 684.0 mm x 256.0 mm (39.2 inch x 26.9 inch x 10.0 inch)
	Without stand	998.0 mm x 615.0 mm x 30.4 mm (39.2 inch x 24.2 inch x 1.1 inch)
Weight	With stand	15.5 kg (34.1 lbs)
	Without stand	13.3 kg (29.3 lbs)
Current Value / Power consumption		1.1 A / 110 W
Power requirement		USA, Canada, Mexico: AC 120 V ~ 50 / 60 Hz Other Country: AC 100 - 240 V ~ 50 / 60 Hz

MODELS		47LW5300 (47LW5300-UC)	55LW5300 (55LW5300-UC)
Dimensions (W x H x D)	With stand	1108.0 mm x 746.0 mm x 256.0 mm (43.6 inch x 29.3 inch x 10.0 inch)	1286.0 mm x 847.0 mm x 338.0 mm (50.6 inch x 33.3 inch x 13.3 inch)
	Without stand	1108.0 mm x 677.0 mm x 30.4 mm (43.6 inch x 26.6 inch x 1.1 inch)	1286.0 mm x 778.0 mm x 30.4 mm (50.6 inch x 30.6 inch x 1.1 inch)
Weight	With stand	20.9 kg (46.0 lbs)	25.5 kg (56.2 lbs)
	Without stand	18.7 kg (41.2 lbs)	21.4 kg (47.1 lbs)
Current Value / Power consumption		1.4 A / 140 W	1.6 A / 160 W
Power requirement		USA, Canada, Mexico: AC 120 V ~ 50 / 60 Hz Other Country: AC 100 - 240 V ~ 50 / 60 Hz	

MODELS		19LV2500 (19LV2500-UA)	22LV2500 (22LV2500-UA)	26LV2520 (26LV2520-UC)
				26LV2500 (26LV2500-UA)
Dimensions (W x H x D)	With stand	455.2 mm x 354.5 mm x 150.7 mm (17.9 inch x 13.9 inch x 5.9 inch)	471.2 mm x 365.9 mm x 155.4 mm (18.5 inch x 14.4 inch x 6.1 inch)	635.6 mm x 475.0 mm x 178.0 mm (25.0 inch x 18.7 inch x 7.0 inch)
	Without stand	455.2 mm x 313.1 mm x 40.9 mm (17.9 inch x 12.3 inch x 1.6 inch)	471.2 mm x 315.5 mm x 40.9 mm (18.5 inch x 12.4 inch x 1.6 inch)	635.6 mm x 413.5 mm x 40.9 mm (25.0 inch x 16.2 inch x 1.6 inch)
Weight	With stand	2.7 kg (5.9 lbs)	3.4 kg (7.4 lbs)	5.4 kg (11.9 lbs)
	Without stand	2.5 kg (5.5 lbs)	3.2 kg (7.0 lbs)	5.0 kg (11.0 lbs)
Current Value / Power consumption		1.4 A / 38 W	1.7 A / 40 W	1.8 A / 50 W
Power requirement		24 V ===, 1.4 A	24 V ===, 1.7 A	24 V ===, 1.8 A
Adapter (DC Power)		In: AC 100 - 240 V ~ 50/60 Hz Out: DC 24 V, 2.5 A		

MODELS		32LV2520 (32LV2520-UC)
		32LV2500 (32LV2500-UA)
Dimensions (W x H x D)	With stand	777.0 mm x 552.0 mm x 234.0 mm (30.5 inch x 21.7 inch x 9.2 inch)
	Without stand	777.0 mm x 501.0 mm x 35.4 mm (30.5 inch x 19.7 inch x 1.3 inch)
Weight	With stand	11.9 kg (26.2 lbs)
	Without stand	10.7 kg (23.5 lbs)
Current Value / Power consumption		0.7 A / 70 W
Power requirement		USA, Canada, Mexico: AC 120 V ~ 50 / 60 Hz Other Country: AC 100 - 240 V ~ 50 / 60 Hz

MODELS		32LV3400 (32LV3400-UA)
Dimensions (W x H x D)	With stand	768.0 mm x 555.0 mm x 240.0 mm (30.2 inch x 21.8 inch x 9.4 inch)
	Without stand	768.0 mm x 492.0 mm x 45.0 mm (30.2 inch x 19.3 inch x 1.7 inch)
Weight	With stand	11.0 kg (24.2 lbs)
	Without stand	9.3 kg (20.5 lbs)
Current Value / Power consumption		0.8 A / 80 W
Power requirement		USA, Canada, Mexico: AC 120 V ~ 50 / 60 Hz Other Country: AC 100 - 240 V ~ 50 / 60 Hz

MODELS		32LV3500 (32LV3500-UA)	37LV3500 (37LV3500-UA)
		32LV3520 (32LV3520-UC)	
Dimensions (W x H x D)	With stand	764.0 mm x 545.0 mm x 240.0 mm (30.0 inch x 21.4 inch x 9.4 inch)	888.0 mm x 614.0 mm x 240.0 mm (34.9 inch x 24.1 inch x 9.4 inch)
	Without stand	764.0 mm x 484.0 mm x 35.4 mm (30.0 inch x 19.0 inch x 1.3 inch)	888.0 mm x 553.0 mm x 35.4 mm (34.9 inch x 21.7 inch x 1.3 inch)
Weight	With stand	11.4 kg (25.1 lbs)	13.5 kg (29.7 lbs)
	Without stand	9.6 kg (21.1 lbs)	11.7 kg (25.7 lbs)
Current Value / Power consumption		0.8 A / 80 W	1.0 A / 100 W
Power requirement		USA, Canada, Mexico: AC 120 V ~ 50 / 60 Hz Other Country: AC 100 - 240 V ~ 50 / 60 Hz	

MODELS		42LV3500 (42LV3500-UA)	47LV3500 (47LV3500-UA)
		42LV3520 (42LV3520-UC)	
Dimensions (W x H x D)	With stand	998.0 mm x 684.0 mm x 256.0 mm (39.2 inch x 26.9 inch x 10.0 inch)	1108.0 mm x 746.0 mm x 256.0 mm (43.6 inch x 29.3 inch x 10.0 inch)
	Without stand	998.0 mm x 615.0 mm x 30.4 mm (39.2 inch x 24.2 inch x 1.1 inch)	1108.0 mm x 677.0 mm x 30.4 mm (43.6 inch x 26.6 inch x 1.1 inch)
Weight	With stand	15.5 kg (34.1 lbs)	20.9 kg (46.0 lbs)
	Without stand	13.3 kg (29.3 lbs)	18.7 kg (41.2 lbs)
Current Value / Power consumption		1.1 A / 110 W	1.4 A / 140 W
Power requirement		USA, Canada, Mexico: AC 120 V ~ 50 / 60 Hz Other Country: AC 100 - 240 V ~ 50 / 60 Hz	

MODELS		55LV3500 (55LV3500-UA)
Dimensions (W x H x D)	With stand	1286.0 mm x 847.0 mm x 338.0 mm (50.6 inch x 33.3 inch x 13.3 inch)
	Without stand	1286.0 mm x 778.0 mm x 30.4 mm (50.6 inch x 30.6 inch x 1.1 inch)
Weight	With stand	25.5 kg (56.2 lbs)
	Without stand	21.4 kg (47.1 lbs)
Current Value / Power consumption		1.6 A / 160 W
Power requirement		USA, Canada, Mexico: AC 120 V ~ 50 / 60 Hz Other Country: AC 100 - 240 V ~ 50 / 60 Hz

MODELS		26LK330 (26LK330-UB)	32LK330 (32LK330-UB)
Dimensions (W x H x D)	With stand	663.0 mm x 484.0 mm x 206.8 mm (26.1 inch x 19.0 inch x 8.1 inch)	800.0 mm x 565.0 mm x 206.8 mm (31.4 inch x 22.2 inch x 8.1 inch)
	Without stand	663.0 mm x 423.0 mm x 79.9 mm (26.1 inch x 16.6 inch x 3.1 inch)	800.0 mm x 509.0 mm x 73.8 mm (31.4 inch x 20.0 inch x 2.9 inch)
Weight	With stand	7.3 kg (16.0 lbs)	9.2 kg (20.2 lbs)
	Without stand	6.2 kg (13.6 lbs)	8.2 kg (18.0 lbs)
Current Value / Power consumption		1.0 A / 100 W	1.2 A / 120 W
Power requirement		AC100 - 240 V ~ 50/60 Hz	

MODELS		32LK430 (32LK430-UA)	42LK430 (42LK430-UA)
Dimensions (W x H x D)	With stand	799.0 mm x 555.0 mm x 207.0 mm (31.4 inch x 21.8 inch x 8.1 inch)	1023.0 mm x 685.0 mm x 261.0 mm (40.2 inch x 26.9 inch x 10.2 inch)
	Without stand	799.0 mm x 506.0 mm x 73.5 mm (31.4 inch x 19.9 inch x 2.8 inch)	1023.0 mm x 635.0 mm x 76.6 mm (40.2 inch x 25.0 inch x 3.0 inch)
Weight	With stand	9.1 kg (20.0 lbs)	15.1 kg (33.2 lbs)
	Without stand	8.1 kg (17.8 lbs)	13.5 kg (29.7 lbs)
Current Value / Power consumption		1.2 A / 120 W	1.8 A / 180 W
Power requirement		AC100 - 240 V ~ 50/60 Hz	

MODELS		32LK450 (32LK450-UB)	37LK450 (37LK450-UB)
Dimensions (W x H x D)	With stand	795.0 mm x 568.0 mm x 207.0 mm (31.2 inch x 22.3 inch x 8.1 inch)	913.0 mm x 639.0 mm x 265.0 mm (35.9 inch x 25.1 inch x 10.4 inch)
	Without stand	795.0 mm x 504.0 mm x 73.5 mm (31.2 inch x 19.8 inch x 2.8 inch)	913.0 mm x 571.0 mm x 77.4 mm (35.9 inch x 22.4 inch x 3.0 inch)
Weight	With stand	9.6 kg (21.1 lbs)	12.8 kg (28.2 lbs)
	Without stand	8.5 kg (18.7 lbs)	11.1 kg (24.4 lbs)
Current Value / Power consumption		1.2 A / 120 W	1.6 A / 160 W
Power requirement		AC100 - 240 V ~ 50/60 Hz	

MODELS		42LK450 (42LK450-UB)	47LK450 (47LK450-UB)
Dimensions (W x H x D)	With stand	1019.0 mm x 698.0 mm x 265.0 mm (40.1 inch x 27.4 inch x 10.4 inch)	1132.0 mm x 762.0 mm x 265.0 mm (44.5 inch x 30.0 inch x 10.4 inch)
	Without stand	1019.0 mm x 631.0 mm x 76.5 mm (40.1 inch x 24.8 inch x 3.0 inch)	1132.0 mm x 695.0 mm x 76.5 mm (44.5 inch x 27.3 inch x 3.0 inch)
Weight	With stand	15.1 kg (33.2 lbs)	19.0 kg (41.8 lbs)
	Without stand	13.4 kg (29.5 lbs)	17.3 kg (38.1 lbs)
Current Value / Power consumption		1.8 A / 180 W	2.3 A / 230 W
Power requirement		AC100 - 240 V ~ 50/60 Hz	

MODELS		42LK520 (42LK520-UA)	47LK520 (47LK520-UA)
Dimensions (W x H x D)	With stand	1024.0 mm x 685.0 mm x 261.0 mm (40.3 inch x 26.9 inch x 10.2 inch)	1137.0 mm x 758.0 x 270.0 mm (44.7 inch x 29.8 inch x 10.6 inch)
	Without stand	1024.0 mm x 621.0 mm x 76.8 mm (40.3 inch x 24.4 inch x 3.0 inch)	1137.0 mm x 685.0 mm x 76.8 mm (44.7 inch x 26.9 inch x 3.0 inch)
Weight	With stand	15.5 kg (34.1 lbs)	20.3 kg (44.7 lbs)
	Without stand	13.9 kg (30.6 lbs)	18.3 kg (40.3 lbs)
Current Value / Power consumption		2.0 A / 200 W	2.5 A / 250 W
Power requirement		AC100 - 240 V ~ 50/60 Hz	

MODELS		55LK520 (55LK520-UA)
Dimensions (W x H x D)	With stand	1329.0 mm x 872.0 mm x 330.0 mm (52.3 inch x 34.3 inch x 12.9 inch)
	Without stand	1329.0 mm x 796.0 mm x 96.5 mm (52.3 inch x 31.3 inch x 3.7 inch)
Weight	With stand	33.0 kg (72.7 lbs)
	Without stand	29.8 kg (65.6 lbs)
Current Value / Power consumption		3.2 A / 320 W
Power requirement		AC100 - 240 V ~ 50/60 Hz

RF module (BM-LDS201) specification (For PW340, PW350, PW350U, PW350R, PZ200 series)

For TV By using a 2.4 GHz bandwidth radio frequency(RF).

- Output: 1 dBm or lower
- Maximum Communication Distance: 10 m (30 ft) in an open space
- Bandwidth: 2.4 GHz (2.4035 GHz - 2.4783 GHz)
- Transfer Rate: 250 kbps
- FCC ID of RF module inside TV
FCC ID: BEJLDS201



RGB (PC), HDMI (PC) supported mode ()

Resolution	Horizontal Frequency (KHz)	Vertical Frequency (Hz)
720x400	31.469	70.08
640x480	31.469	59.94
800x600	37.879	60.31
1024x768	48.363	60.00
1360x768	47.712	60.015
1280x1024	63.981	60.02
1920x1080 RGB-PC	66.587	59.934
1920x1080 HDMI-PC	67.5	60.00

For 50/60PZ200

RGB (PC), HDMI (PC) supported mode ()

Resolution	Horizontal Frequency (KHz)	Vertical Frequency (Hz)
720x400	31.469	70.08
640x480	31.469	59.94
800x600	37.879	60.31
1024x768	48.363	60.00
1360x768	47.712	60.015
1280x768 RGB-PC	47.776	59.870
1280x1024	63.981	60.02
1920x1080 RGB-PC	66.587	59.934
1920x1080 HDMI-PC	67.5	60.00

For 22LV2500, 32/37/42/47/55LV3500, 32/42LV3520, 42LW5000, 47/55LW5300, 32/42LK430, 32/37/42/47LK450, 42/47/55LK520

HDMI (DTV) supported mode ( )

Resolution	Horizontal Frequency (KHz)	Vertical Frequency (Hz)
720x480p	31.47 31.50	59.94 60.00
1280x720p	44.96 45.00	59.94 60.00
1920x1080i	33.72 33.75	59.94 60.00
1920x1080p	26.97 27.00 33.71 33.75 67.432 67.50	23.976 24.00 29.97 30.00 59.94 60.00

Component port connecting information

Component ports on the TV	Y	P _B	P _R
---------------------------	---	----------------	----------------

Video output ports on DVD player	Y	P _B	P _R
	Y	B-Y	R-Y
	Y	Cb	Cr
	Y	Pb	Pr

Component supported mode ( )

Resolution	Horizontal Frequency (KHz)	Vertical Frequency (Hz)
720x480i	15.73 15.73	59.94 60.00
720x480p	31.47 31.50	59.94 60.00
1280x720p	44.96 45.00	59.94 60.00
1920x1080i	33.72 33.75	59.94 60.00
1920x1080p	26.97 27.00 33.71 33.75 67.432 67.50	23.976 24.00 29.97 30.00 59.94 60.00

Video Supported Formats

Extension name	File	Video Decoder	Audio Codec	Max Resolution
mpg, mpeg		MPEG1, MPEG2	MP2, MP3, Dolby Digital, LPCM	1920 x 1080 @ 30p (Only Motion JPEG 640x480@30p)
dat		MPEG1	MP2	
ts, trp, tp		MPEG2, H.264, AVS, VC1	MP2, MP3, Dolby Digital, AAC, HE-AAC	
vob		MPEG1, 2	MP2, MP3, Dolby Digital, LPCM	
mp4, mov		MPEG4, DivX 3.11, DivX 4.12, DivX 5.x, DivX 6, Xvid 1.00, Xvid 1.01, Xvid 1.02, Xvid 1.03, Xvid 1.10-beta1/2H.264	AAC, HE-AAC, MP3	
mkv		H.264, MPEG-1,2,4	MP2, MP3, Dolby Digital, AAC HE-AAC, LPCM	
divx, avi		MPEG2, MPEG4, DivX 3.11, DivX 4, DivX 5, DivX 6, Xvid 1.00, Xvid 1.01, Xvid 1.02, Xvid 1.03, Xvid 1.10-beta1/2H.264	MP2, MP3, Dolby Digital, LPCM, ADPCM, AAC, HE-AAC	
Motion JPEG (avi, mp4, mkv)		JPEG	LPCM, ADPCM	
asf, wmv		VC1	WMA	
flv		Sorenson H.263, H264	MP3, AAC	

3D Supported Formats (For 3D TV)

	Signal	Resolution	Horizontal Frequency (kHz)	Vertical Frequency (Hz)	Playable 3D video format
HDMI Input	720p	1280x720	44.96 / 45.00	59.94 / 60.00	Top & Bottom, Side by Side
			89.90 / 90.00		HDMI 3D Frame Packing
	1080i	1920x1080	33.72 / 33.75	30.00	Top & Bottom, Side by Side
			67.432 / 67.50		Top & Bottom, Side by Side, Checker Board Single Frame Sequential
	1080p	1920x1080	27.00	24.00	Top & Bottom, Side by Side, Checker Board
			53.95 / 54.00	23.98 / 24.00	HDMI 3D Frame Packing
			33.75	30.00	Top & Bottom, Side by Side Checker Board
USB Input	1080p	1920x1080	33.75	30.00	Top & Bottom, Side by Side Checker Board, MPO (Photo)
	Resolution				Playable 3D video format
	Other Resolution (For Plasma TV)				Top & Bottom, Side by Side
PC Input (PZ200, LW5000, LW5300 series)	1920x1080		66.587	59.93	Top & Bottom, Side by Side
Component (For Plasma TV)	720p	1280x720	44.96 / 45.00	59.94 / 60.00	Top & Bottom, Side by Side
	1080i	1920x1080	33.72 / 33.75	59.94 / 60.00	
	Signal				Playable 3D video format
DTV	720p, 1080i				Top & Bottom, Side by Side

IR CODES

(Depending on model)

How to Connect

Connect your wired remote control to the Remote Control port on the TV.

Remote Control IR Codes

Output waveform

Single pulse, modulated with 37.917kHz signal at 455kHz

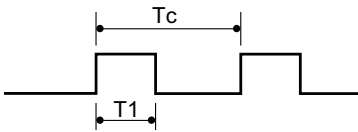

Frame configuration

1st frame

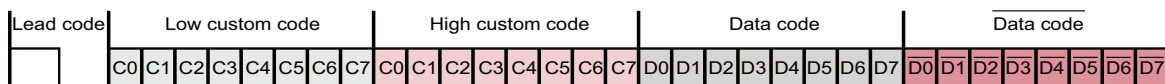

Repeat frame

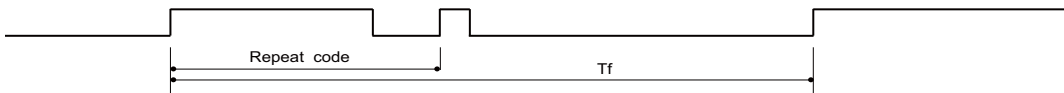

Lead code

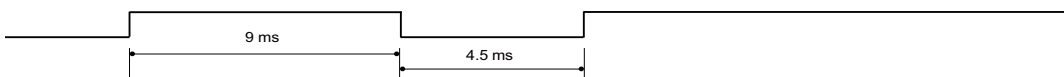

Repeat code

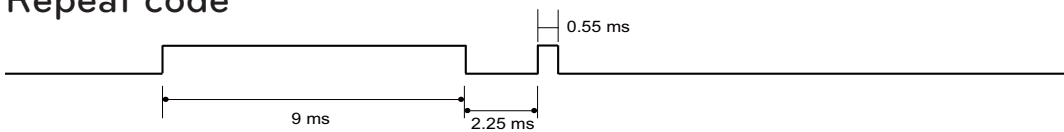

Bit description

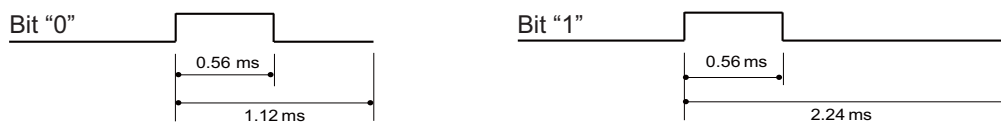

Frame interval: Tf

The waveform is transmitted as long as a key is depressed.

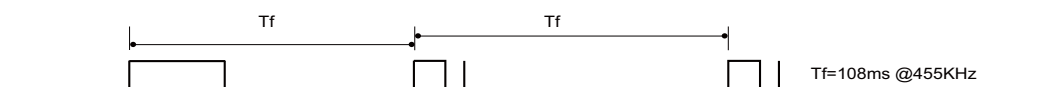

Code (Hexa)	Function	Note	Code (Hexa)	Function	Note
08	POWER	Remote control Button (Power On/Off)	0F	TV	Remote control Button
			DC	3D	Remote control Button
45	Q.MENU	Remote control Button	5B	EXIT	Remote control Button
43	Home	Remote control Button	D6	TV	Discrete IR Code (TV Input Selection)
0B	INPUT	Remote control Button			
10 - 19	Number Key 0-9	Remote control Button	C4	POWER ON	Discrete IR Code (Only Power On)
4C	- (Dash)/LIST	Remote control Button			
1A	FLASHBK or Q.VIEW	Remote control Button	C5	POWER OFF	Discrete IR Code (Only Power Off)
9	MUTE/DELETE	Remote control Button			
2	VOL +	Remote control Button	5A	AV1	Discrete IR Code (AV1 Input Selection)
3	VOL -	Remote control Button			
0	CH ▲	Remote control Button	D0	AV2	Discrete IR Code (AV2 Input Selection)
1	CH ▼	Remote control Button			
1E	FAV/MARK	Remote control Button	BF	COMPONENT1	Discrete IR Code (Component1 Input Selection)
40	▲	Remote control Button			
41	▼	Remote control Button	D4	COMPONENT2	Discrete IR Code (Component2 Input Selection)
7	<	Remote control Button			
6	>	Remote control Button	D5	RGB-PC	Discrete IR Code (RGB-PC Input Selection)
44	ENTER	Remote control Button			
28	BACK	Remote control Button	CE	HDMI1	Discrete IR Code (HDMI1 Input Selection)
79	RATIO	Remote control Button			
BA ()	FREEZE	Remote control Button	CC	HDMI2	Discrete IR Code (HDMI2 Input Selection)
95	ENERGY SAVING	Remote control Button			
7E	SIMPLINK	Remote control Button	E9	HDMI3	Discrete IR Code (HDMI3 Input Selection)
AA	INFO	Remote control Button			
30	AV MODE	Remote control Button	DA	HDMI4	Discrete IR Code (HDMI4 Input Selection)
72	RED	Remote control Button			
71	GREEN	Remote control Button	76	Ratio 4:3	Discrete IR Code (Only 4:3 Mode)
63	YELLOW	Remote control Button			
61	BLUE	Remote control Button	77	Ratio 16:9	Discrete IR Code (Only 16:9 Mode)
B1	■	Remote control Button			
B0	▶	Remote control Button	AF	Ratio Zoom	Discrete IR Code (Only Zoom Mode)
BA	▬	Remote control Button			
8E	▶▶	Remote control Button			
8F	◀◀	Remote control Button			

EXTERNAL CONTROL DEVICE SETUP

RS-232C Setup

Connect the RS-232C (serial port) input jack to an external control device (such as a computer or an A/V control system) to control the product's functions externally.

Connect the serial port of the control device to the RS-232C jack on the product back panel.

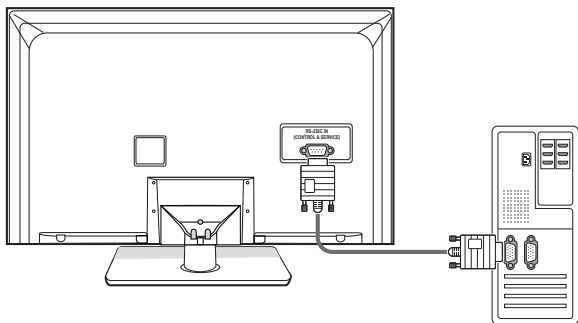

NOTE

- RS-232C on this unit is intended to be used with third party RS-232C control hardware and software. The instructions below are provided to help with programming software or to test functionality using telenet software. RS-232C connection cables are not supplied with the product.

Type of connector; D-Sub 9-Pin Male

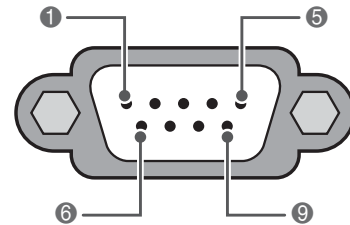

RS-232C IN
(CONTROL & SERVICE)

No.	Pin name
1	No connection
2	RXD (Receive data)
3	TXD (Transmit data)
4	DTR (DTE side ready)
5	GND
6	DSR (DCE side ready)
7	RTS (Ready to send)
8	CTS (Clear to send)
9	No Connection

RS-232C configurations

7-Wire Configuration

(Serial female-female NULL modem cable)

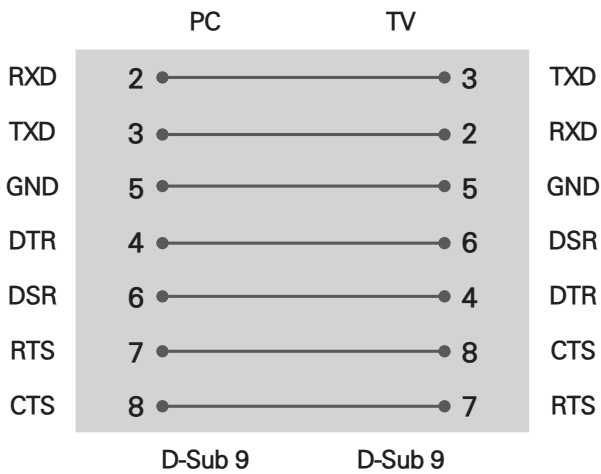

3-Wire Configurations(Not standard)

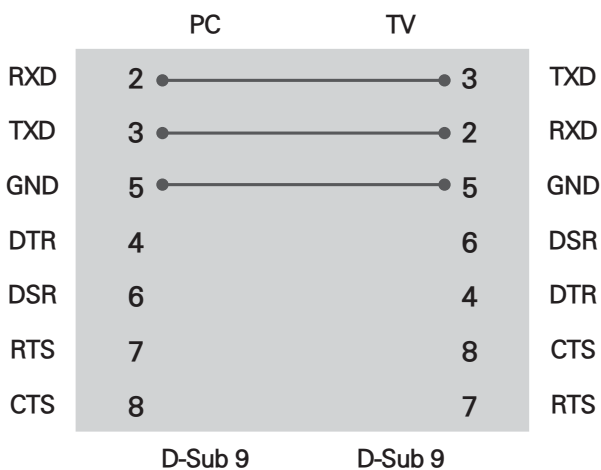

Set ID

Set ID number.

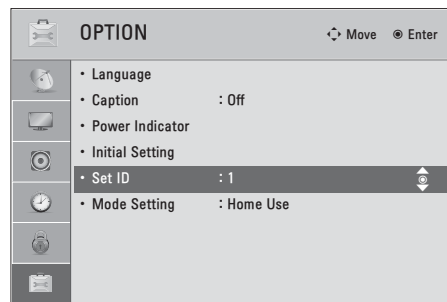



- 1 Press **Home** to access the main menus.
- 2 Press the Navigation buttons to scroll to **OPTION** and press **ENTER**.
- 3 Press the Navigation buttons to scroll to **Set ID** and press **ENTER**.
- 4 Scroll left or right to select a set ID number and select **CLOSE**. The adjustment range is 1-99.
- 5 When you are finished, press **EXIT**.

*Real data mapping
 0 : Step 0
 :
 A : Step 10 (SET ID 10)
 :
 F : Step 15 (SET ID 15)
 10 : Step 16 (SET ID 16)
 :
 63 : Step 99 (SET ID 99)
 64 : Step 100

Communication Parameters

- Baud rate: 9600 bps (UART)
- Data length: 8 bits
- Parity : None
- Stop bit: 1 bit
- Communication code: ASCII code
- Use a crossed (reverse) cable.

Command reference list

	COMMAND1	COMMAND2	DATA (Hexadecimal)		COMMAND1	COMMAND2	DATA (Hexadecimal)
01. Power	k	a	00 - 01	14. Treble	k	r	00 - 64
02. Input Select	x	b	(See p.98)	15. Bass	k	s	00 - 64
03. Aspect Ratio	k	c	(See p.98)	16. Balance	k	t	00 - 64
04. Screen Mute	k	d	00 - 01	17. 3D (For 3D TV)	x	t	(See p.99)
05. Volume Mute	k	e	00 - 01	18. Color Temperature	x	u	00 - 64
06. Volume Control	k	f	00 - 64	19. Extended 3D (For 3D TV)	x	v	(See p.99)
07. Contrast	k	g	00 - 64	20. ISM Method ()	j	p	(See p.100)
08. Brightness	k	h	00 - 64	21. Energy Saving	j	q	(See p.100)
09. Color	k	i	00 - 64	22. Auto Configuration	j	u	(See p.100)
10. Tint	k	j	00 - 64	24. Channel Add/Del	m	b	00 - 01
11. Sharpness	k	k	00 - 64	25. Key	m	c	(See p.100)
12. OSD Select	k	l	00 - 01	26. Backlight ()	m	g	00 - 64
13. Remote Control Lock Mode	k	m	00 - 01				

	COMMAND1	COMMAND2	DATA00 (Hexadecimal)	DATA01 (Hexadecimal)	DATA02 (Hexadecimal)	DATA03 (Hexadecimal)	DATA04 (Hexadecimal)	DATA05 (Hexadecimal)
23. Channel Tuning	m	a	physical program high	major program low	major low	minor high	minor low	attribute

Transmission / Receiving protocol

Transmission

[Command1][Command2][][Set ID][][Data][Cr]

[Command 1] : First command to control the set.(j, k, m or x)

[Command 2] : Second command to control the set.

[Set ID] : You can adjust the set ID to choose desired set ID number in Option menu. Adjustment range is 1~ 99. When selecting Set ID '0', every connected the set is controlled. Set ID is indicated as decimal (1~ 99) on menu and as Hexa decimal (0x0~ 0x63) on transmission /receiving protocol.

[DATA] : To transmit the command data.

Transmit the 'FF' data to read status of command.

[Cr] : Carriage Return

ASCII code '0x0D'

[] : ASCII code 'space (0x20)'

* In this model, set will not send the status during the standby mode.

OK Acknowledgement

[Command2][][Set ID][][OK][Data][x]

The set transmits ACK (acknowledgement) based on this format when receiving normal data. At this time, if the data is data read mode, it indicates present status data. If the data is data write mode, it returns the data of the PC computer.

* In this model, set will not send the status during the standby mode.

* Data Format

[Command 2] : Use as command.

[Set ID] : Use the small character, if set ID is 10, it will send the '0', 'a'.

[DATA] : Use the small character, if data is 0 x ab, it will send the 'a', 'b'.

[OK] : Use the large character.

Error Acknowledgement

[Command2][][Set ID][][NG][Data][x]

The set transmits ACK (acknowledgement) based on this format when receiving abnormal data from non-viable functions or communication errors.

Data1: Illegal Code

Data2: Not supported function

Data3: Wait more time

* In this model, set will not send the status during the standby mode.

* Data Format

[Command 2] : Use as command.

[Set ID] : Use the small character, if set ID is 10, it will send the '0', 'a'.

[DATA] : Use the small character, if data is 0 x ab, it will send the 'a', 'b'.

[NG] : Use the large character

01. Power (Command: k a)

To control Power On/Off of the set.

Transmission [k][a][][Set ID][][Data][Cr]

Data 00: Power Off Data 01: Power On

Acknowledgement [a][][Set ID][][OK/NG][Data][x]

- * In a like manner, if other functions transmit 'FF' data based on this format, Acknowledgement data feedback presents status about each function.
- * Note: In this model, set will send the Acknowledge after power on processing completion.
There might be a time delay between command and acknowledge.

02. Input Select (Command: x b)

To select input source for set.

Transmission [x][b][][Set ID][][Data][Cr]

Data 00: DTV (Antenna) Data 01: DTV (Cable)
Data 10: Analog (Antenna) Data 11: Analog (Cable)
Data 20: AV or AV1 Data 21: AV2
Data 40: Component or Component1
Data 41: Component2
Data 60: RGB-PC Data 90: HDMI1
Data 91: HDMI2 Data 92: HDMI3
Data 93: HDMI4

Acknowledgement [b][][Set ID][][OK/NG][Data][x]

- * Use the feature depending on your model.

03. Aspect Ratio (Command: k c)

To adjust the screen format.

Transmission [k][c][][Set ID][][Data][Cr]

Data 01: 4:3 Data: 09: Just scan
Data 02: 16:9 Data: 10: Cinema Zoom 1
Data 04: Zoom :
Data 06: Set by program Data 1F: Cinema Zoom16

Acknowledgement [c][][Set ID][][OK/NG][Data][x]

04. Screen Mute (Command: k d)

To select screen mute on/off.

Transmission [k][d][][Set ID][][Data][Cr]

Data 00: Screen mute off (Picture on), Video-out Mute off
Data 01: Screen mute on (Picture off)
Data 10: Video-out Mute on

Acknowledgement [d][][Set ID][][OK/NG][Data][x]

- * In case of Video-out Mute on only, TV will display On Screen Display (OSD). But, in case of screen mute on, TV will not display On Screen Display (OSD).

05. Volume Mute (Command: k e)

To control volume mute on/off.

You can also adjust mute using the MUTE button on remote control.

Transmission [k][e][][Set ID][][Data][Cr]

Data 00: Volume mute on (Volume off)
Data 01: Volume mute off (Volume on)

Acknowledgement [e][][Set ID][][OK/NG][Data][x]

06. Volume Control (Command: k f)

To adjust volume.

You can also adjust volume with the volume buttons on remote control.

Transmission [k][f][][Set ID][][Data][Cr]

Data Min: 00 ~ Max: 64 (*transmit by Hexadecimal code)

*Refer to "Real data mapping".

Acknowledgement [f][][Set ID][][OK/NG][Data][x]

07. Contrast (Command: k g)

To adjust screen contrast.

You can also adjust contrast in the PICTURE menu.

Transmission [k][g][][Set ID][][Data][Cr]

Data Min: 00 ~ Max: 64 (*transmit by Hexadecimal code)

*Refer to "Real data mapping".

Acknowledgement [g][][Set ID][][OK/NG][Data][x]

08. Brightness (Command: k h)

To adjust screen brightness.

You can also adjust brightness in the PICTURE menu.

Transmission [k][h][][Set ID][][Data][Cr]

Data Min: 00 ~ Max: 64 (*transmit by Hexadecimal code)

*Refer to "Real data mapping".

Acknowledgement [h][][Set ID][][OK/NG][Data][x]

09. Color (Command: k i)

To adjust screen color.

You can also adjust color in the PICTURE menu.

Transmission [k][i][][Set ID][][Data][Cr]

Data Min: 00 ~ Max: 64 (*transmit by Hexadecimal code)

*Refer to "Real data mapping".

Acknowledgement [i][][Set ID][][OK/NG][Data][x]

10. Tint (Command: k j)

To adjust screen tint.

You can also adjust tint in the PICTURE menu.

Transmission [k][j][][Set ID][][Data][Cr]

Data Red: 00 ~ Green: 64 (*transmit by Hexadecimal code)

*Refer to "Real data mapping".

Acknowledgement [j][][Set ID][][OK/NG][Data][x]

11. Sharpness (Command: k k)

To adjust screen sharpness.

You can also adjust sharpness in the PICTURE menu.

Transmission [k][k][][Set ID][][Data][Cr]

Data Min: 00 ~ Max: 64 (*transmit by Hexadecimal code)

*Refer to "Real data mapping".

Acknowledgement [k][][Set ID][][OK/NG][Data][x]

12. OSD Select (Command: k l)

To select OSD (On Screen Display) on/off.

Transmission [k][l][][Set ID][][Data][Cr]

Data 00: OSD off Data 01: OSD on

Acknowledgement [l][][Set ID][][OK/NG][Data][x]

13. Remote Control Lock Mode (Command: k m)

To lock the remote control and the front panel controls on the set.

Transmission [k][m][][Set ID][][Data][Cr]

Data 00: Lock off Data 01: Lock on

Acknowledgement [m][][Set ID][][OK/NG][Data][x]

If you're not using the remote control and front panel controls on the Monitor set, use this mode. When main power is on/off, remote control lock is released. If Key Lock is on in the standby mode, TV will not turn on by POWER button of remote control and on the TV.

14. Treble (Command: k r)

To adjust treble.

You can also adjust treble in the AUDIO menu.

Transmission [k][r][][Set ID][][Data][Cr]

Data Min: 00 ~ Max: 64 (*transmit by Hexadecimal code)

*Refer to "Real data mapping".

Acknowledgement [r][][Set ID][][OK/NG][Data][x]

15. Bass (Command: k s)

To adjust bass.

You can also adjust bass in the AUDIO menu.

Transmission [k][s][][Set ID][][Data][Cr]

Data Min: 00 ~ Max: 64 (*transmit by Hexadecimal code)

*Refer to "Real data mapping".

Acknowledgement [s][][Set ID][][OK/NG][Data][x]

16. Balance (Command: k t)

To adjust balance.

You can also adjust balance in the AUDIO menu.

Transmission [k][t][][Set ID][][Data][Cr]

Data Min: 00 ~ Max: 64 (*transmit by Hexadecimal code)

*Refer to "Real data mapping".

Acknowledgement [t][][Set ID][][OK/NG][Data][x]

17. 3D (Command: x t) (For 3D TV)

To change 3D mode for TV.

Transmission [x][t][][Set ID][][Data01][][Data02][][Data03][][Data04][Cr]

Data1

00: 3D On 01: 3D Off
02: 3D to 2D 03: 2D to 3D

Data2

00: Top and Bottom 01: Side by Side
02: Check Board 03: Frame Sequential

Data3

00: Right to Left
01: Left to Right

Data4

3D Depth: Min : 00 ~ Max : 14
(*transmit by Hexadecimal code)

*If data1 is 00(3D On), data4 has no meaning.

*If data1 is 01(3D Off) or 02(3D to 2D), data2, data3 and data4 have no meaning.

*If data1 is 03(2D to 3D), data2 and data3 have no meaning.

Data 1	Data 2	Data 3	Data 4
00	o	o	x
01	x	x	x
02	x	x	x
03	x	x	o

x : Don't care

Acknowledgement [t][][OK][Data01][Data02][Data03][Data04][x][t][][NG][Data01][x]

18. Color Temperature (Command: x u)

To adjust color temperature.

You can also adjust color temperature in the PICTURE menu.

Transmission [x][u][][Set ID][][Data][Cr]

Data Min: 00 ~ Max: 64 (*transmit by Hexadecimal code)

*Refer to "Real data mapping".

Acknowledgement [u][][Set ID][][OK/NG][Data][x]

19. Extended 3D (Command: x v) (For 3D TV)

To change 3D option for TV.

Transmission [x][v][][Set ID][][Data01][][Data02][Cr]

Data1: 3D option

00: 3D Picture Correction
01: 3D Depth (2D to 3D Only)
02: 3D Viewpoint
03: 3D Picture Size
04: 3D Picture Balance
05: 3D Optimization

Data2: It has own range for each 3D option determined by Data1.

1) When Data1 is 00
00: Right to Left 01: Left to Right

2) When Data1 is 01, 02

Data Min: 00 ~ Max: 14 (*transmit by Hexadecimal code)

3) When Data1 is 03
00: Just Scan 01: 16:9

4) When Data1 is 04
00: Off 01: On

5) When Data1 is 05

Data Min: 00 ~ Max: 02 (*transmit by Hexadecimal code)

Acknowledgement [v][][OK][Data1][Data2][x][v][][NG][Data1][x]

* Use the feature depending on your model.

20. ISM Method (Command: j p) ()

To avoid having a fixed image remain on screen.

Transmission [j][p][][Set ID][][Data][Cr]

Data 02: Orbiter
04: White Wash
08: Normal
20: Color Wash

Acknowledgement [p][][Set ID][][OK/NG][Data][x]

21. Energy Saving (Command: j q)

To control the energy saving function.

Transmission [j][q][][Set ID][][Data][Cr]

Data 00: off
01: Minimum
02: Medium
03: Maximum
04: Auto/Intelligent sensor (depending on model)
05: Screen off

Acknowledgement [q][][Set ID][][OK/NG][Data][x]

22. Auto Configuration (Command: j u)

To adjust picture position and minimize image shaking automatically. Auto configuration only works in RGB-PC mode.

Transmission [j][u][][Set ID][][Data][Cr]

Data 01: To set

Acknowledgement [u][][Set ID][][OK/NG][Data][x]

23. Channel Tuning (Command: m a)

To tune channel to following physical/major/minor number.

Transmission [m][a][][Set ID][][Data00][][Data01][][Data02][][Data03][][Data04][][Data05][Cr]

Digital channels have a Physical, Major, and Minor channel number. The Physical number is the actual digital channel number, the Major is the number that the channel should be mapped to, and the Minor is the sub-channel. Since the ATSC tuner automatically maps the channel to the Major number, the Physical number is not required when sending a command.

Data 00: Physical Channel Number
NTSC air: 02~45, NTSC cable: 01, 0E~7D
ATSC air: 01~45, ATSC cable: 01~87

Data 01 & 02: Major Channel Number
Data 01: High byte Data 02: Low byte

Two bytes are available for the Major and Minor, normally only the second byte is used.

Data 03 & 04: Minor Channel Number
Not needed for NTSC.

The table above lists the binary code which must be converted to Hexadecimal before sending. For example:

The binary code to tune the sub source to an NTSC cable channel is "1000 0001", which translates to "81" in Hex.

- * 7th bit : For which source do you want to change the channel.

- * 6th bit: Use a two part or one part channel. Most cases just use 0 since it's ignored when using NTSC.
- * 5th bit: Use 0 with NTSC since it can only use the physical channel number. Normally use 1 for ATSC since most times it doesn't matter what the physical number is.
- * 4th bit: Set to 0.
- * 3-0 bits: Choose signal type.

* Tune Command Examples:

1. Tune to the analog (NTSC) cable channel 35.

Data 00 = Physical of 35 = 23

Data 01 & 02 = No Major = 00 00

Data 03 & 04 = No Minor = 00 00

Data 05 = 0000 0001 in binary = 01

Total = ma 00 23 00 00 00 01

2. Tune to the digital (ATSC) local channel 30-3.

Data 00 = Don't know Physical = 00

Data 01 & 02 = Major is 30 = 00 1E

Data 03 & 04 = Minor is 3 = 00 03

Data 05 = 0010 0010 in binary = 22

Total = ma 00 00 00 1E 00 03 22

- * Use the feature depending on your model.

24. Channel Add/Del (Command: m b)

To add and delete the channels.

Transmission [m][b][][Set ID][][Data][Cr]

Data 00: Channel Delete Data 01: Channel Add

Acknowledgement [b][][Set ID][][OK/NG][Data][x]

25. Key (Command: m c)

To send IR remote key code.

Transmission [m][c][][Set ID][][Data][Cr]

Acknowledgement [c][][Set ID][][OK/NG][Data][x]

When TV is in the standby mode, TV will turn on by POWER button of remote control only.

26. Backlight (Command: m g) ()

To adjust screen backlight.

Transmission [m][g][][Set ID][][Data][Cr]

Data Min:00 ~ Max:64 (*transmit by Hexadecimal code)

*Refer to "Real data mapping".

Acknowledgement [g][][Set ID][][OK/NG][Data][x]

* Table List (Channel Tuning)

7	Main/Sub Picture	6	Two/One Part Channel	5	Using Physical Channel	4 Reserved	3	2	1	0	Step
0	Main	0	Two	0	Use	x	0	0	0	0	NTSC Air
1	Sub	1	One	1	No Use	x	0	0	0	1	NTSC Cable
						x	0	0	1	0	ATSC Air
						x	0	0	1	1	ATSC Cable_std
						x	0	1	0	0	ATSC Cable_hrc
						x	0	1	0	1	ATSC Cable_irc
						x	0	1	1	0	ATSC cable_auto
						x	0	1	1	1	Reserved
						x	x	x	x	x	...
						x	1	1	1	1	Reserved

OPEN SOURCE LICENSE

Open source software notice

Please be informed that LG Electronics products may contain open source software listed in the tables below.

License	Component
OpenSSL license	- openssl
MIT license	- libcurl - ncurses
expat license	- expat
Freetype license	- freetype
JPEG license	- libjpeg
Zlib/libpng license	- libmng - libpng - md5 checksum - tinyxml - zlib
X.net license	- libicu
BSD license	- strace - xySSL
RSA data security license	- MD5

ENGLISH

LG Electronics products may also contain open source software listed as Components in the table below, and you may download the complete source code thereof free of charge, from LG Electronics website (<http://opensource.lge.com>) for a period of three (3) years from our last shipment of this product. Please be informed that the open source software is subject to the terms and conditions of the applicable open source licenses, which are provided to you hereinbelow.

License	Component
GNU GPL v2.0	- Linux kernel 2.6 - busybox - e2fsprogs - gdbserver - jfsutils - mtd-utils - procps - u-boot - udhcpc
GNU LGPL v2.1	- directFB - gconv - glibc
MPL 1.1	- nanox

GNU GENERAL PUBLIC LICENSE

Version 2, June 1991

Copyright (C) 1989, 1991 Free Software Foundation, Inc.
51 Franklin Street, Fifth Floor, Boston, MA 02110-1301, USA
Everyone is permitted to copy and distribute verbatim copies
of this license document, but changing it is not allowed.

Preamble

The licenses for most software are designed to take away your freedom to share and change it. By contrast, the GNU General Public License is intended to guarantee your freedom to share and change free software—to make sure the software is free for all its users. This General Public License applies to most of the Free Software Foundation’s software and to any other program whose authors commit to using it. (Some other Free Software Foundation software is covered by the GNU Lesser General Public License instead.) You can apply it to your programs, too.

When we speak of free software, we are referring to freedom, not price. Our General Public Licenses are designed to make sure that you have the freedom to distribute copies of free software (and charge for this service if you wish), that you receive source code or can get it if you want it, that you can change the software or use pieces of it in new free programs; and that you know you can do these things.

To protect your rights, we need to make restrictions that forbid anyone to deny you these rights or to ask you to surrender the rights. These restrictions translate to certain responsibilities for you if you distribute copies of the software, or if you modify it.

For example, if you distribute copies of such a program, whether gratis or for a fee, you must give the recipients all the rights that you have. You must make sure that they, too, receive or can get the source code. And you must show them these terms so they know their rights.

We protect your rights with two steps: (1) copyright the software, and (2) offer you this license which gives you legal permission to copy, distribute and/or modify the software.

Also, for each author’s protection and ours, we want to make certain that everyone understands that there is no warranty for this free software. If the software is modified by someone else and passed on, we want its recipients to know that what they have is not the original, so that any problems introduced by others will not reflect on the original authors’ reputations.

Finally, any free program is threatened constantly by software patents. We wish to avoid the danger that redistributors of a free program will individually obtain patent licenses, in effect making the program proprietary. To prevent this, we have made it clear that any patent must be licensed for everyone’s free use or not licensed at all.

The precise terms and conditions for copying, distribution and modification follow.

TERMS AND CONDITIONS FOR COPYING, DISTRIBUTION AND MODIFICATION

0. This License applies to any program or other work which contains a notice placed by the copyright holder saying it may be distributed under the terms of this General Public License. The “Program”, below, refers to any such program or work, and a “work based on the Program” means either the Program or any derivative work under copyright law: that is to say, a work containing the Program or a portion of it, either verbatim or with modifications and/or translated into another language. (Hereinafter, translation is included without limitation in the term “modification”.) Each licensee is addressed as “you”.

Activities other than copying, distribution and modification are not covered by this License; they are outside its scope. The act of running the Program is not restricted, and the output from the Program is covered only if its contents constitute a work based on the Program (independent of having been made by running the Program). Whether that is true depends on what the Program does.

1. You may copy and distribute verbatim copies of the Program's source code as you receive it, in any medium, provided that you conspicuously and appropriately publish on each copy an appropriate copyright notice and disclaimer of warranty; keep intact all the notices that refer to this License and to the absence of any warranty; and give any other recipients of the Program a copy of this License along with the Program.

You may charge a fee for the physical act of transferring a copy, and you may at your option offer warranty protection in exchange for a fee.

2. You may modify your copy or copies of the Program or any portion of it, thus forming a work based on the Program, and copy and distribute such modifications or work under the terms of Section 1 above, provided that you also meet all of these conditions:

a) You must cause the modified files to carry prominent notices stating that you changed the files and the date of any change.

b) You must cause any work that you distribute or publish, that in whole or in part contains or is derived from the Program or any part thereof, to be licensed as a whole at no charge to all third parties under the terms of this License.

c) If the modified program normally reads commands interactively when run, you must cause it, when started running for such interactive use in the most ordinary way, to print or display an announcement including an appropriate copyright notice and a notice that there is no warranty (or else, saying that you provide a warranty) and that users may redistribute the program under these conditions, and telling the user how to view a copy of this License. (Exception: if the Program itself is interactive but does not normally print such an announcement, your work based on the Program is not required to print an announcement.)

These requirements apply to the modified work as a whole. If identifiable sections of that work are not derived from the Program, and can be reasonably considered independent and separate works in themselves, then this License, and its terms, do not apply to those sections when you distribute them as separate works. But when you distribute the same sections as part of a whole which is a work based on the Program, the distribution of the whole must be on the terms of this License, whose permissions for other licensees extend to the entire whole, and thus to each and every part regardless of who wrote it.

Thus, it is not the intent of this section to claim rights or contest your rights to work written entirely by you; rather, the intent is to exercise the right to control the distribution of derivative or collective works based on the Program.

In addition, mere aggregation of another work not based on the Program with the Program (or with a work based on the Program) on a volume of a storage or distribution medium does not bring the other work under the scope of this License.

3. You may copy and distribute the Program (or a work based on it, under Section 2) in object code or executable form under the terms of Sections 1 and 2 above provided that you also do one of the following:

a) Accompany it with the complete corresponding machine-readable source code, which must be distributed under the terms of Sections 1 and 2 above on a medium customarily used for software interchange; or,

b) Accompany it with a written offer, valid for at least three years, to give any third party, for a charge no more than your cost of physically performing source distribution, a complete machine-readable copy of the corresponding source code, to be distributed under the terms of Sections 1 and 2 above on a medium customarily used for software interchange; or,

c) Accompany it with the information you received as to the offer to distribute corresponding source code. (This alternative is allowed only for noncommercial distribution and only if you received the program in object code or executable form with such an offer, in accord with Subsection b above.)

The source code for a work means the preferred form of the work for making modifications to it. For an executable work, complete source code means all the source code for all modules it contains, plus any associated interface definition files, plus the scripts used to control compilation and installation of the executable. However, as a special exception, the source code distributed need not include anything that is normally distributed (in either source or binary form) with the major components (compiler, kernel, and so on) of the operating system on which the executable runs, unless that component itself accompanies the executable.

If distribution of executable or object code is made by offering access to copy from a designated place, then offering equivalent access to copy the source code from the same place counts as distribution of the source code, even though third parties are not compelled to copy the source along with the object code.

4. You may not copy, modify, sublicense, or distribute the Program except as expressly provided under this License. Any attempt otherwise to copy, modify, sublicense or distribute the Program is void, and will automatically terminate your rights under this License. However, parties who have received copies, or rights, from you under this License will not have their licenses terminated so long as such parties remain in full compliance.

5. You are not required to accept this License, since you have not signed it. However, nothing else grants you permission to modify or distribute the Program or its derivative works. These actions are prohibited by law if you do not accept this License. Therefore, by modifying or distributing the Program (or any work based on the Program), you indicate your acceptance of this License to do so, and all its terms and conditions for copying, distributing or modifying the Program or works based on it.

6. Each time you redistribute the Program (or any work based on the Program), the recipient automatically receives a license from the original licensor to copy, distribute or modify the Program subject to these terms and conditions. You may not impose any further restrictions on the recipients' exercise of the rights granted herein. You are not responsible for enforcing compliance by third parties to this License.

7. If, as a consequence of a court judgment or allegation of patent infringement or for any other reason (not limited to patent issues), conditions are imposed on you (whether by court order, agreement or otherwise) that contradict the conditions of this License, they do not excuse you from the conditions of this License. If you cannot distribute so as to satisfy simultaneously your obligations under this License and any other pertinent obligations, then as a consequence you may not distribute the Program at all. For example, if a patent license would not permit royalty-free redistribution of the Program by all those who receive copies directly or indirectly through you, then the only way you could satisfy both it and this License would be to refrain entirely from distribution of the Program.

If any portion of this section is held invalid or unenforceable under any particular circumstance, the balance of the section is intended to apply and the section as a whole is intended to apply in other circumstances.

It is not the purpose of this section to induce you to infringe any patents or other property right claims or to contest validity of any such claims; this section has the sole purpose of protecting the integrity of the free software distribution system, which is implemented by public license practices. Many people have made generous contributions to the wide range of software distributed through that system in reliance on consistent application of that system; it is up to the author/donor to decide if he or she is willing to distribute software through any other system and a licensee cannot impose that choice.

This section is intended to make thoroughly clear what is believed to be a consequence of the rest of this License.

8. If the distribution and/or use of the Program is restricted in certain countries either by patents or by copyrighted interfaces, the original copyright holder who places the Program under this License may add an explicit geographical distribution limitation excluding those countries, so that distribution is permitted only in or among countries not thus excluded. In such case, this License incorporates the limitation as if written in the body of this License.

9. The Free Software Foundation may publish revised and/or new versions of the General Public License from time to time. Such new versions will be similar in spirit to the present version, but may differ in detail to address new problems or concerns.

Each version is given a distinguishing version number. If the Program specifies a version number of this License which

applies to it and “any later version”, you have the option of following the terms and conditions either of that version or of any later version published by the Free Software Foundation. If the Program does not specify a version number of this License, you may choose any version ever published by the Free Software Foundation.

10. If you wish to incorporate parts of the Program into other free programs whose distribution conditions are different, write to the author to ask for permission. For software which is copyrighted by the Free Software Foundation, write to the Free Software Foundation; we sometimes make exceptions for this. Our decision will be guided by the two goals of preserving the free status of all derivatives of our free software and of promoting the sharing and reuse of software generally.

NO WARRANTY

11. BECAUSE THE PROGRAM IS LICENSED FREE OF CHARGE, THERE IS NO WARRANTY FOR THE PROGRAM, TO THE EXTENT PERMITTED BY APPLICABLE LAW. EXCEPT WHEN OTHERWISE STATED IN WRITING THE COPYRIGHT HOLDERS AND/OR OTHER PARTIES PROVIDE THE PROGRAM “AS IS” WITHOUT WARRANTY OF ANY KIND, EITHER EXPRESSED OR IMPLIED, INCLUDING, BUT NOT LIMITED TO, THE IMPLIED WARRANTIES OF MERCHANTABILITY AND FITNESS FOR A PARTICULAR PURPOSE. THE ENTIRE RISK AS TO THE QUALITY AND PERFORMANCE OF THE PROGRAM IS WITH YOU. SHOULD THE PROGRAM PROVE DEFECTIVE, YOU ASSUME THE COST OF ALL NECESSARY SERVICING, REPAIR OR CORRECTION.

12. IN NO EVENT UNLESS REQUIRED BY APPLICABLE LAW OR AGREED TO IN WRITING WILL ANY COPYRIGHT HOLDER, OR ANY OTHER PARTY WHO MAY MODIFY AND/OR REDISTRIBUTE THE PROGRAM AS PERMITTED ABOVE, BE LIABLE TO YOU FOR DAMAGES, INCLUDING ANY GENERAL, SPECIAL, INCIDENTAL OR CONSEQUENTIAL DAMAGES ARISING OUT OF THE USE OR INABILITY TO USE THE PROGRAM (INCLUDING BUT NOT LIMITED TO LOSS OF DATA OR DATA BEING RENDERED INACCURATE OR LOSSES SUSTAINED BY YOU OR THIRD PARTIES OR A FAILURE OF THE PROGRAM TO OPERATE WITH ANY OTHER PROGRAMS), EVEN IF SUCH HOLDER OR OTHER PARTY HAS BEEN ADVISED OF THE POSSIBILITY OF SUCH DAMAGES.

END OF TERMS AND CONDITIONS

GNU Lesser General Public License

Version 2.1, February 1999

Copyright (C) 1991, 1999 Free Software Foundation, Inc. 59 Temple Place, Suite 330, Boston, MA 02111-1307 USA
Everyone is permitted to copy and distribute verbatim copies of this license document, but changing it is not allowed.

[This is the first released version of the Lesser GPL. It also counts as the successor of the GNU Library Public License, version 2, hence the version number 2.1.]

Preamble

The licenses for most software are designed to take away your freedom to share and change it. By contrast, the GNU General Public Licenses are intended to guarantee your freedom to share and change free software—to make sure the software is free for all its users.

This license, the Lesser General Public License, applies to some specially designated software packages—typically libraries—of the Free Software Foundation and other authors who decide to use it. You can use it too, but we suggest you first think carefully about whether this license or the ordinary General Public License is the better strategy to use in any particular case, based on the explanations below.

When we speak of free software, we are referring to freedom of use, not price. Our General Public Licenses are designed to make sure that you have the freedom to distribute copies of free software (and charge for this service if you wish); that you receive source code or can get it if you want it; that you can change the software and use pieces of it in new free programs; and that you are informed that you can do these things.

To protect your rights, we need to make restrictions that forbid distributors to deny you these rights or to ask you to

surrender these rights. These restrictions translate to certain responsibilities for you if you distribute copies of the library or if you modify it.

For example, if you distribute copies of the library, whether gratis or for a fee, you must give the recipients all the rights that we gave you. You must make sure that they, too, receive or can get the source code. If you link other code with the library, you must provide complete object files to the recipients, so that they can relink them with the library after making changes to the library and recompiling it. And you must show them these terms so they know their rights.

We protect your rights with a two-step method: (1) we copyright the library, and (2) we offer you this license, which gives you legal permission to copy, distribute and/or modify the library.

To protect each distributor, we want to make it very clear that there is no warranty for the free library. Also, if the library is modified by someone else and passed on, the recipients should know that what they have is not the original version, so that the original author's reputation will not be affected by problems that might be introduced by others.

Finally, software patents pose a constant threat to the existence of any free program. We wish to make sure that a company cannot effectively restrict the users of a free program by obtaining a restrictive license from a patent holder. Therefore, we insist that any patent license obtained for a version of the library must be consistent with the full freedom of use specified in this license.

Most GNU software, including some libraries, is covered by the ordinary GNU General Public License. This license, the GNU Lesser General Public License, applies to certain designated libraries, and is quite different from the ordinary General Public License. We use this license for certain libraries in order to permit linking those libraries into non-free programs.

When a program is linked with a library, whether statically or using a shared library, the combination of the two is legally speaking a combined work, a derivative of the original library. The ordinary General Public License therefore permits such linking only if the entire combination fits its criteria of freedom. The Lesser General Public License permits more lax criteria for linking other code with the library.

We call this license the "Lesser" General Public License because it does Less to protect the user's freedom than the ordinary General Public License. It also provides other free software developers Less of an advantage over competing non-free programs. These disadvantages are the reason we use the ordinary General Public License for many libraries. However, the Lesser license provides advantages in certain special circumstances.

For example, on rare occasions, there may be a special need to encourage the widest possible use of a certain library, so that it becomes a de-facto standard. To achieve this, non-free programs must be allowed to use the library. A more frequent case is that a free library does the same job as widely used non-free libraries. In this case, there is little to gain by limiting the free library to free software only, so we use the Lesser General Public License.

In other cases, permission to use a particular library in non-free programs enables a greater number of people to use a large body of free software. For example, permission to use the GNU C Library in non-free programs enables many more people to use the whole GNU operating system, as well as its variant, the GNU/Linux operating system.

Although the Lesser General Public License is Less protective of the users' freedom, it does ensure that the user of a program that is linked with the Library has the freedom and the wherewithal to run that program using a modified version of the Library.

The precise terms and conditions for copying, distribution and modification follow. Pay close attention to the difference between a "work based on the library" and a "work that uses the library". The former contains code derived from the library, whereas the latter must be combined with the library in order to run.

TERMS AND CONDITIONS FOR COPYING, DISTRIBUTION AND MODIFICATION

0. This License Agreement applies to any software library or other program which contains a notice placed by the copyright holder or other authorized party saying it may be distributed under the terms of this Lesser General Public License (also called "this License"). Each licensee is addressed as "you".

A “library” means a collection of software functions and/or data prepared so as to be conveniently linked with application programs (which use some of those functions and data) to form executables.

The “Library”, below, refers to any such software library or work which has been distributed under these terms. A “work based on the Library” means either the Library or any derivative work under copyright law: that is to say, a work containing the Library or a portion of it, either verbatim or with modifications and/or translated straightforwardly into another language. (Hereinafter, translation is included without limitation in the term “modification”.)

“Source code” for a work means the preferred form of the work for making modifications to it. For a library, complete source code means all the source code for all modules it contains, plus any associated interface definition files, plus the scripts used to control compilation and installation of the library.

Activities other than copying, distribution and modification are not covered by this License; they are outside its scope. The act of running a program using the Library is not restricted, and output from such a program is covered only if its contents constitute a work based on the Library (independent of the use of the Library in a tool for writing it). Whether that is true depends on what the Library does and what the program that uses the Library does.

1. You may copy and distribute verbatim copies of the Library’s complete source code as you receive it, in any medium, provided that you conspicuously and appropriately publish on each copy an appropriate copyright notice and disclaimer of warranty; keep intact all the notices that refer to this License and to the absence of any warranty; and distribute a copy of this License along with the Library.

You may charge a fee for the physical act of transferring a copy, and you may at your option offer warranty protection in exchange for a fee.

2. You may modify your copy or copies of the Library or any portion of it, thus forming a work based on the Library, and copy and distribute such modifications or work under the terms of Section 1 above, provided that you also meet all of these conditions:

- a) The modified work must itself be a software library.
- b) You must cause the files modified to carry prominent notices stating that you changed the files and the date of any change.
- c) You must cause the whole of the work to be licensed at no charge to all third parties under the terms of this License.
- d) If a facility in the modified Library refers to a function or a table of data to be supplied by an application program that uses the facility, other than as an argument passed when the facility is invoked, then you must make a good faith effort to ensure that, in the event an application does not supply such function or table, the facility still operates, and performs whatever part of its purpose remains meaningful.

(For example, a function in a library to compute square roots has a purpose that is entirely well-defined independent of the application. Therefore, Subsection 2d requires that any application-supplied function or table used by this function must be optional: if the application does not supply it, the square root function must still compute square roots.)

These requirements apply to the modified work as a whole. If identifiable sections of that work are not derived from the Library, and can be reasonably considered independent and separate works in themselves, then this License, and its terms, do not apply to those sections when you distribute them as separate works. But when you distribute the same sections as part of a whole which is a work based on the Library, the distribution of the whole must be on the terms of this License, whose permissions for other licensees extend to the entire whole, and thus to each and every part regardless of who wrote it.

Thus, it is not the intent of this section to claim rights or contest your rights to work written entirely by you; rather, the intent is to exercise the right to control the distribution of derivative or collective works based on the Library.

In addition, mere aggregation of another work not based on the Library with the Library (or with a work based on the

Library) on a volume of a storage or distribution medium does not bring the other work under the scope of this License.

3. You may opt to apply the terms of the ordinary GNU General Public License instead of this License to a given copy of the Library. To do this, you must alter all the notices that refer to this License, so that they refer to the ordinary GNU General Public License, version 2, instead of to this License. (If a newer version than version 2 of the ordinary GNU General Public License has appeared, then you can specify that version instead if you wish.) Do not make any other change in these notices.

Once this change is made in a given copy, it is irreversible for that copy, so the ordinary GNU General Public License applies to all subsequent copies and derivative works made from that copy.

This option is useful when you wish to copy part of the code of the Library into a program that is not a library.

4. You may copy and distribute the Library (or a portion or derivative of it, under Section 2) in object code or executable form under the terms of Sections 1 and 2 above provided that you accompany it with the complete corresponding machine-readable source code, which must be distributed under the terms of Sections 1 and 2 above on a medium customarily used for software interchange.

If distribution of object code is made by offering access to copy from a designated place, then offering equivalent access to copy the source code from the same place satisfies the requirement to distribute the source code, even though third parties are not compelled to copy the source along with the object code.

5. A program that contains no derivative of any portion of the Library, but is designed to work with the Library by being compiled or linked with it, is called a “work that uses the Library”. Such a work, in isolation, is not a derivative work of the Library, and therefore falls outside the scope of this License.

However, linking a “work that uses the Library” with the Library creates an executable that is a derivative of the Library (because it contains portions of the Library), rather than a “work that uses the library”. The executable is therefore covered by this License. Section 6 states terms for distribution of such executables.

When a “work that uses the Library” uses material from a header file that is part of the Library, the object code for the work may be a derivative work of the Library even though the source code is not. Whether this is true is especially significant if the work can be linked without the Library, or if the work is itself a library. The threshold for this to be true is not precisely defined by law.

If such an object file uses only numerical parameters, data structure layouts and accessors, and small macros and small inline functions (ten lines or less in length), then the use of the object file is unrestricted, regardless of whether it is legally a derivative work. (Executables containing this object code plus portions of the Library will still fall under Section 6.)

Otherwise, if the work is a derivative of the Library, you may distribute the object code for the work under the terms of Section 6. Any executables containing that work also fall under Section 6, whether or not they are linked directly with the Library itself.

6. As an exception to the Sections above, you may also combine or link a “work that uses the Library” with the Library to produce a work containing portions of the Library, and distribute that work under terms of your choice, provided that the terms permit modification of the work for the customer’s own use and reverse engineering for debugging such modifications.

You must give prominent notice with each copy of the work that the Library is used in it and that the Library and its use are covered by this License. You must supply a copy of this License. If the work during execution displays copyright notices, you must include the copyright notice for the Library among them, as well as a reference directing the user to the copy of this License. Also, you must do one of these things:

a) Accompany the work with the complete corresponding machine-readable source code for the Library including whatever changes were used in the work (which must be distributed under Sections 1 and 2 above); and, if the work is an executable linked with the Library, with the complete machine-readable “work that uses the Library”, as object code and/

or source code, so that the user can modify the Library and then relink to produce a modified executable containing the modified Library. (It is understood that the user who changes the contents of definitions files in the Library will not necessarily be able to recompile the application to use the modified definitions.)

b) Use a suitable shared library mechanism for linking with the Library. A suitable mechanism is one that (1) uses at run time a copy of the library already present on the user's computer system, rather than copying library functions into the executable, and (2) will operate properly with a modified version of the library, if the user installs one, as long as the modified version is interface-compatible with the version that the work was made with.

c) Accompany the work with a written offer, valid for at least three years, to give the same user the materials specified in Subsection 6a, above, for a charge no more than the cost of performing this distribution.

d) If distribution of the work is made by offering access to copy from a designated place, offer equivalent access to copy the above specified materials from the same place.

e) Verify that the user has already received a copy of these materials or that you have already sent this user a copy.

For an executable, the required form of the "work that uses the Library" must include any data and utility programs needed for reproducing the executable from it. However, as a special exception, the materials to be distributed need not include anything that is normally distributed (in either source or binary form) with the major components (compiler, kernel, and so on) of the operating system on which the executable runs, unless that component itself accompanies the executable.

It may happen that this requirement contradicts the license restrictions of other proprietary libraries that do not normally accompany the operating system. Such a contradiction means you cannot use both them and the Library together in an executable that you distribute.

7. You may place library facilities that are a work based on the Library side-by-side in a single library together with other library facilities not covered by this License, and distribute such a combined library, provided that the separate distribution of the work based on the Library and of the other library facilities is otherwise permitted, and provided that you do these two things:

a) Accompany the combined library with a copy of the same work based on the Library, uncombined with any other library facilities. This must be distributed under the terms of the Sections above.

b) Give prominent notice with the combined library of the fact that part of it is a work based on the Library, and explaining where to find the accompanying uncombined form of the same work.

8. You may not copy, modify, sublicense, link with, or distribute the Library except as expressly provided under this License. Any attempt otherwise to copy, modify, sublicense, link with, or distribute the Library is void, and will automatically terminate your rights under this License. However, parties who have received copies, or rights, from you under this License will not have their licenses terminated so long as such parties remain in full compliance.

9. You are not required to accept this License, since you have not signed it. However, nothing else grants you permission to modify or distribute the Library or its derivative works. These actions are prohibited by law if you do not accept this License. Therefore, by modifying or distributing the Library (or any work based on the Library), you indicate your acceptance of this License to do so, and all its terms and conditions for copying, distributing or modifying the Library or works based on it.

10. Each time you redistribute the Library (or any work based on the Library), the recipient automatically receives a license from the original licensor to copy, distribute, link with or modify the Library subject to these terms and conditions. You may not impose any further restrictions on the recipients' exercise of the rights granted herein. You are not responsible for enforcing compliance by third parties with this License.

11. If, as a consequence of a court judgment or allegation of patent infringement or for any other reason (not limited to patent issues), conditions are imposed on you (whether by court order, agreement or otherwise) that contradict the con-

ditions of this License, they do not excuse you from the conditions of this License. If you cannot distribute so as to satisfy simultaneously your obligations under this License and any other pertinent obligations, then as a consequence you may not distribute the Library at all. For example, if a patent license would not permit royalty-free redistribution of the Library by all those who receive copies directly or indirectly through you, then the only way you could satisfy both it and this License would be to refrain entirely from distribution of the Library.

If any portion of this section is held invalid or unenforceable under any particular circumstance, the balance of the section is intended to apply, and the section as a whole is intended to apply in other circumstances.

It is not the purpose of this section to induce you to infringe any patents or other property right claims or to contest validity of any such claims; this section has the sole purpose of protecting the integrity of the free software distribution system which is implemented by public license practices. Many people have made generous contributions to the wide range of software distributed through that system in reliance on consistent application of that system; it is up to the author/donor to decide if he or she is willing to distribute software through any other system and a licensee cannot impose that choice.

This section is intended to make thoroughly clear what is believed to be a consequence of the rest of this License.

12. If the distribution and/or use of the Library is restricted in certain countries either by patents or by copyrighted interfaces, the original copyright holder who places the Library under this License may add an explicit geographical distribution limitation excluding those countries, so that distribution is permitted only in or among countries not thus excluded. In such case, this License incorporates the limitation as if written in the body of this License.

13. The Free Software Foundation may publish revised and/or new versions of the Lesser General Public License from time to time. Such new versions will be similar in spirit to the present version, but may differ in detail to address new problems or concerns.

Each version is given a distinguishing version number. If the Library specifies a version number of this License which applies to it and “any later version”, you have the option of following the terms and conditions either of that version or of any later version published by the Free Software Foundation. If the Library does not specify a license version number, you may choose any version ever published by the Free Software Foundation.

14. If you wish to incorporate parts of the Library into other free programs whose distribution conditions are incompatible with these, write to the author to ask for permission. For software which is copyrighted by the Free Software Foundation, write to the Free Software Foundation; we sometimes make exceptions for this. Our decision will be guided by the two goals of preserving the free status of all derivatives of our free software and of promoting the sharing and reuse of software generally.

NO WARRANTY

15. BECAUSE THE LIBRARY IS LICENSED FREE OF CHARGE, THERE IS NO WARRANTY FOR THE LIBRARY, TO THE EXTENT PERMITTED BY APPLICABLE LAW. EXCEPT WHEN OTHERWISE STATED IN WRITING THE COPYRIGHT HOLDERS AND/OR OTHER PARTIES PROVIDE THE LIBRARY “AS IS” WITHOUT WARRANTY OF ANY KIND, EITHER EXPRESSED OR IMPLIED, INCLUDING, BUT NOT LIMITED TO, THE IMPLIED WARRANTIES OF MERCHANTABILITY AND FITNESS FOR A PARTICULAR PURPOSE. THE ENTIRE RISK AS TO THE QUALITY AND PERFORMANCE OF THE LIBRARY IS WITH YOU. SHOULD THE LIBRARY PROVE DEFECTIVE, YOU ASSUME THE COST OF ALL NECESSARY SERVICING, REPAIR OR CORRECTION.

16. IN NO EVENT UNLESS REQUIRED BY APPLICABLE LAW OR AGREED TO IN WRITING WILL ANY COPYRIGHT HOLDER, OR ANY OTHER PARTY WHO MAY MODIFY AND/OR REDISTRIBUTE THE LIBRARY AS PERMITTED ABOVE, BE LIABLE TO YOU FOR DAMAGES, INCLUDING ANY GENERAL, SPECIAL, INCIDENTAL OR CONSEQUENTIAL DAMAGES ARISING OUT OF THE USE OR INABILITY TO USE THE LIBRARY (INCLUDING BUT NOT LIMITED TO LOSS OF DATA OR DATA BEING RENDERED INACCURATE OR LOSSES SUSTAINED BY YOU OR THIRD PARTIES OR A FAILURE OF THE LIBRARY TO OPERATE WITH ANY OTHER SOFTWARE), EVEN IF SUCH HOLDER OR OTHER PARTY HAS BEEN ADVISED OF THE POSSIBILITY OF SUCH DAMAGES.

END OF TERMS AND CONDITIONS

How to Apply These Terms to Your New Libraries

If you develop a new library, and you want it to be of the greatest possible use to the public, we recommend making it free software that everyone can redistribute and change. You can do so by permitting redistribution under these terms (or, alternatively, under the terms of the ordinary General Public License).

To apply these terms, attach the following notices to the library. It is safest to attach them to the start of each source file to most effectively convey the exclusion of warranty; and each file should have at least the “copyright” line and a pointer to where the full notice is found.

<one line to give the library’s name and an idea of what it does.> Copyright (C) <year> <name of author>

This library is free software; you can redistribute it and/or modify it under the terms of the GNU Lesser General Public License as published by the Free Software Foundation; either version 2.1 of the License, or (at your option) any later version.

This library is distributed in the hope that it will be useful, but WITHOUT ANY WARRANTY; without even the implied warranty of MERCHANTABILITY or FITNESS FOR A PARTICULAR PURPOSE. See the GNU Lesser General Public License for more details.

You should have received a copy of the GNU Lesser General Public License along with this library; if not, write to the Free Software Foundation, Inc., 59 Temple Place, Suite 330, Boston, MA 02111-1307 USA

Also add information on how to contact you by electronic and paper mail.

You should also get your employer (if you work as a programmer) or your school, if any, to sign a “copyright disclaimer” for the library, if necessary. Here is a sample; alter the names:

Yoyodyne, Inc., hereby disclaims all copyright interest in the library ‘Frob’ (a library for tweaking knobs) written by James Random Hacker.

signature of Ty Coon, 1 April 1990

Ty Coon, President of Vice

That’s all there is to it!

Mozilla Public License 1.1 (MPL 1.1)

1. Definitions.

1.0.1. "Commercial Use"

means distribution or otherwise making the Covered Code available to a third party.

1.1. "Contributor"

means each entity that creates or contributes to the creation of Modifications.

1.2. "Contributor Version"

means the combination of the Original Code, prior Modifications used by a Contributor, and the Modifications made by that particular Contributor.

1.3. "Covered Code"

means the Original Code or Modifications or the combination of the Original Code and Modifications, in each case including portions thereof.

1.4. "Electronic Distribution Mechanism"

means a mechanism generally accepted in the software development community for the electronic transfer of data.

1.5. "Executable"

means Covered Code in any form other than Source Code.

1.6. "Initial Developer"

means the individual or entity identified as the Initial Developer in the Source Code notice required by Exhibit A.

1.7. "Larger Work"

means a work which combines Covered Code or portions thereof with code not governed by the terms of this License.

1.8. "License"

means this document.

1.8.1. "Licensable"

means having the right to grant, to the maximum extent possible, whether at the time of the initial grant or subsequently acquired, any and all of the rights conveyed herein.

1.9. "Modifications"

means any addition to or deletion from the substance or structure of either the Original Code or any previous Modifications. When Covered Code is released as a series of files, a Modification is:

(a) Any addition to or deletion from the contents of a file containing Original Code or previous Modifications.

(b) Any new file that contains any part of the Original Code or previous Modifications.

1.10. "Original Code"

means Source Code of computer software code which is described in the Source Code notice required by Exhibit A as Original Code, and which, at the time of its release under this License is not already Covered Code governed by this License.

1.10.1. "Patent Claims"

means any patent claim(s), now owned or hereafter acquired, including without limitation, method, process, and apparatus claims, in any patent Licensable by grantor.

1.11. "Source Code"

means the preferred form of the Covered Code for making modifications to it, including all modules it contains, plus any associated interface definition files, scripts used to control compilation and installation of an Executable, or source code differential comparisons against either the Original Code or another well known, available Covered Code of the Contributor's choice. The Source Code can be in a compressed or archival form, provided the appropriate decompression or de-archiving software is widely available for no charge.

1.12. "You" (or "Your")

means an individual or a legal entity exercising rights under, and complying with all of the terms of, this License or a future version of this License issued under Section 6.1. For legal entities, "You" includes any entity which controls, is controlled by, or is under common control with You. For purposes of this definition, "control" means (a) the power, direct or indirect, to cause the direction or management of such entity, whether by contract or otherwise, or (b) ownership of more than fifty percent (50%) of the outstanding shares or beneficial ownership of such entity.

2. Source Code License.**2.1. The Initial Developer Grant.**

The Initial Developer hereby grants You a world-wide, royalty-free, non-exclusive license, subject to third party intellectual property claims:

(a) under intellectual property rights (other than patent or trademark) Licensable by Initial Developer to use, reproduce, modify, display, perform, sublicense and distribute the Original Code (or portions thereof) with or without Modifications, and/or as part of a Larger Work; and

(b) under Patents Claims infringed by the making, using or selling of Original Code, to make, have made, use, practice, sell, and offer for sale, and/or otherwise dispose of the Original Code (or portions thereof).

(c) the licenses granted in this Section 2.1(a) and (b) are effective on the date Initial Developer first distributes Original Code under the terms of this License.

(d) Notwithstanding Section 2.1(b) above, no patent license is granted: 1) for code that You delete from the Original Code; 2) separate from the Original Code; or 3) for infringements caused by: i) the modification of the Original Code or ii) the combination of the Original Code with other software or devices.

2.2. Contributor Grant.

Subject to third party intellectual property claims, each Contributor hereby grants You a world-wide, royalty-free, non-exclusive license

(a) under intellectual property rights (other than patent or trademark) Licensable by Contributor, to use, reproduce, modify, display, perform, sublicense and distribute the Modifications created by such Contributor (or portions thereof) either on an unmodified basis, with other Modifications, as Covered Code and/or as part of a Larger Work; and

(b) under Patent Claims infringed by the making, using, or selling of Modifications made by that Contributor either alone and/or in combination with its Contributor Version (or portions of such combination), to make, use, sell, offer for sale, have made, and/or otherwise dispose of: 1) Modifications made by that Contributor (or portions thereof); and 2) the combination of Modifications made by that Contributor with its Contributor Version (or portions of such combination).

(c) the licenses granted in Sections 2.2(a) and 2.2(b) are effective on the date Contributor first makes Commercial Use of the Covered Code.

(d) Notwithstanding Section 2.2(b) above, no patent license is granted: 1) for any code that Contributor has deleted from the Contributor Version; 2) separate from the Contributor Version; 3) for infringements caused by: i) third party modifications of Contributor Version or ii) the combination of Modifications made by that Contributor with other software (except as part of the Contributor Version) or other devices; or 4) under Patent Claims infringed by Covered Code in the absence of Modifications made by that Contributor.

3. Distribution Obligations.

3.1. Application of License.

The Modifications which You create or to which You contribute are governed by the terms of this License, including without limitation Section 2.2. The Source Code version of Covered Code may be distributed only under the terms of this License or a future version of this License released under Section 6.1, and You must include a copy of this License with every copy of the Source Code You distribute. You may not offer or impose any terms on any Source Code version that alters or restricts the applicable version of this License or the recipients' rights hereunder. However, You may include an additional document offering the additional rights described in Section 3.5.

3.2. Availability of Source Code.

Any Modification which You create or to which You contribute must be made available in Source Code form under the terms of this License either on the same media as an Executable version or via an accepted Electronic Distribution Mechanism to anyone to whom you made an Executable version available; and if made available via Electronic Distribution Mechanism,

must remain available for at least twelve (12) months after the date it initially became available, or at least six (6) months after a subsequent version of that particular Modification has been made available to such recipients. You are responsible for ensuring that the Source Code version remains available even if the Electronic Distribution Mechanism is maintained by a third party.

3.3. Description of Modifications.

You must cause all Covered Code to which You contribute to contain a file documenting the changes You made to create that Covered Code and the date of any change. You must include a prominent statement that the Modification is derived, directly or indirectly, from Original Code provided by the Initial Developer and including the name of the Initial Developer in (a) the Source Code, and (b) in any notice in an Executable version or related documentation in which You describe the origin or ownership of the Covered Code.

3.4. Intellectual Property Matters

(a) Third Party Claims.

If Contributor has knowledge that a license under a third party's intellectual property rights is required to exercise the rights granted by such Contributor under Sections 2.1 or 2.2, Contributor must include a text file with the Source Code distribution titled "LEGAL" which describes the claim and the party making the claim in sufficient detail that a recipient will know whom to contact. If Contributor obtains such knowledge after the Modification is made available as described in Section 3.2, Contributor shall promptly modify the LEGAL file in all copies Contributor makes available thereafter and shall take other steps (such as notifying appropriate mailing lists or newsgroups) reasonably calculated to inform those who received the Covered Code that new knowledge has been obtained.

(b) Contributor APIs.

If Contributor's Modifications include an application programming interface and Contributor has knowledge of patent licenses which are reasonably necessary to implement that API, Contributor must also include this information in the LEGAL file.

(c) Representations.

Contributor represents that, except as disclosed pursuant to Section 3.4(a) above, Contributor believes that Contributor's Modifications are Contributor's original creation(s) and/or Contributor has sufficient rights to grant the rights conveyed by this License.

3.5. Required Notices.

You must duplicate the notice in Exhibit A in each file of the Source Code. If it is not possible to put such notice in a particular

Source Code file due to its structure, then You must include such notice in a location (such as a relevant directory) where a user would be likely to look for such a notice. If You created one or more Modification(s) You may add your name as a Contributor to the notice described in Exhibit A. You must also duplicate this License in any documentation for the Source Code where You describe recipients' rights or ownership rights relating to Covered Code. You may choose to offer, and to charge a fee for, warranty, support, indemnity or liability obligations to one or more recipients of Covered Code. However, You may do so only on Your own behalf, and not on behalf of the Initial Developer or any Contributor You must make it absolutely clear than any such warranty, support, indemnity or liability obligation is offered by You alone, and You hereby agree to indemnify the Initial Developer and every Contributor for any liability incurred by the Initial Developer or such Contributor as a result of warranty, support, indemnity or liability terms You offer.

3.6. Distribution of Executable Versions.

You may distribute Covered Code in Executable form only if the requirements of Section 3.1-3.5 have been met for that Covered Code, and if You include a notice stating that the Source Code version of the Covered Code is available under the terms of this License, including a description of how and where You have fulfilled the obligations of Section 3.2. The notice must be conspicuously included in any notice in an Executable version, related documentation or collateral in which You describe recipients' rights relating to the Covered Code. You may distribute the Executable version of Covered Code or ownership rights under a license of Your choice, which may contain terms different from this License, provided that You are in compliance with the terms of this License and that the license for the Executable version does not attempt to limit or alter the recipient's rights in the Source Code version from the rights set forth in this License. If You distribute the Executable version under a different license You must make it absolutely clear that any terms which differ from this License are offered by You alone, not by the Initial Developer or any Contributor. You hereby agree to indemnify the Initial Developer and every Contributor for any liability incurred by the Initial Developer or such Contributor as a result of any such terms You offer.

3.7. Larger Works.

You may create a Larger Work by combining Covered Code with other code not governed by the terms of this License and distribute the Larger Work as a single product. In such a case, You must make sure the requirements of this License are fulfilled for the Covered Code.

4. Inability to Comply Due to Statute or Regulation.

If it is impossible for You to comply with any of the terms of this License with respect to some or all of the Covered Code due to statute, judicial order, or regulation then You must: (a) comply with the terms of this License to the maximum extent possible; and (b) describe the limitations and the code they affect. Such description must be included in the LEGAL file described in Section 3.4 and must be included with all distributions of the Source Code. Except to the extent prohibited by statute or regulation, such description must be sufficiently detailed for a recipient of ordinary skill to be able to understand it.

5. Application of this License.

This License applies to code to which the Initial Developer has attached the notice in Exhibit A and to related Covered Code.

6. Versions of the License.

6.1. New Versions.

Netscape Communications Corporation ("Netscape") may publish revised and/or new versions of the License from time to time. Each version will be given a distinguishing version number.

6.2. Effect of New Versions.

Once Covered Code has been published under a particular version of the License, You may always continue to use it under the terms of that version. You may also choose to use such Covered Code under the terms of any subsequent version of the License published by Netscape. No one other than Netscape has the right to modify the terms applicable to Covered Code created under this License.

6.3. Derivative Works.

If You create or use a modified version of this License (which you may only do in order to apply it to code which is not already Covered Code governed by this License), You must (a) rename Your license so that the phrases "Mozilla", "MOZILLAPL", "MOZPL", "Netscape", "MPL", "NPL" or any confusingly similar phrase do not appear in your license (except to note that your license differs from this License) and (b) otherwise make it clear that Your version of the license contains terms which differ from the Mozilla Public License and Netscape Public License. (Filling in the name of the Initial Developer, Original Code or Contributor in the notice described in Exhibit A shall not of themselves be deemed to be modifications of this License.)

7. DISCLAIMER OF WARRANTY.

COVERED CODE IS PROVIDED UNDER THIS LICENSE ON AN "AS IS" BASIS, WITHOUT WARRANTY OF ANY KIND, EITHER EXPRESSED OR IMPLIED, INCLUDING, WITHOUT LIMITATION, WARRANTIES THAT THE COVERED CODE IS FREE OF DEFECTS, MERCHANTABLE, FIT FOR A PARTICULAR PURPOSE OR NON-INFRINGEMENT. THE ENTIRE RISK AS TO THE QUALITY AND PERFORMANCE OF THE COVERED CODE IS WITH YOU. SHOULD ANY COVERED CODE

PROVE DEFECTIVE IN ANY RESPECT, YOU (NOT THE INITIAL DEVELOPER OR ANY OTHER CONTRIBUTOR) ASSUME THE COST OF ANY NECESSARY SERVICING, REPAIR OR CORRECTION. THIS DISCLAIMER OF WARRANTY CONSTITUTES AN ESSENTIAL PART OF THIS LICENSE. NO USE OF ANY COVERED CODE IS AUTHORIZED HEREUNDER EXCEPT UNDER THIS DISCLAIMER.

8. TERMINATION.

8.1. This License and the rights granted hereunder will terminate automatically if You fail to comply with terms herein and fail

to cure such breach within 30 days of becoming aware of the breach. All sublicenses to the Covered Code which are properly granted shall survive any termination of this License. Provisions which, by their nature, must remain in effect beyond the termination of this License shall survive.

8.2. If You initiate litigation by asserting a patent infringement claim (excluding declaratory judgment actions) against Initial Developer or a Contributor (the Initial Developer or Contributor against whom You file such action is referred to as "Participant") alleging that:

(a) such Participant's Contributor Version directly or indirectly infringes any patent, then any and all rights granted by such Participant to You under Sections 2.1 and/or 2.2 of this License shall, upon 60 days notice from Participant terminate prospectively, unless if within 60 days after receipt of notice You either: (i) agree in writing to pay Participant a mutually agreeable reasonable royalty for Your past and future use of Modifications made by such Participant, or (ii) withdraw Your litigation claim with respect to the Contributor Version against such Participant. If within 60 days of notice, a reasonable royalty and payment arrangement are not mutually agreed upon in writing by the parties or the litigation claim is not withdrawn, the rights granted by Participant to You under Sections 2.1 and/or 2.2 automatically terminate at the expiration of the 60 day notice period specified above.

(b) any software, hardware, or device, other than such Participant's Contributor Version, directly or indirectly infringes any patent, then any rights granted to You by such Participant under Sections 2.1(b) and 2.2(b) are revoked effective as of the date You first made, used, sold, distributed, or had made, Modifications made by that Participant.

8.3. If You assert a patent infringement claim against Participant alleging that such Participant's Contributor Version directly or indirectly infringes any patent where such claim is resolved (such as by license or settlement) prior to the initiation of patent infringement litigation, then the reasonable value of the licenses granted by such Participant under Sections 2.1 or 2.2 shall be taken into account in determining the amount or value of any payment or license. 8.4. In the event of termination under Sections 8.1 or 8.2 above, all end user license agreements (excluding distributors and resellers) which have been validly granted by You or any distributor hereunder prior to termination shall survive termination.

9. LIMITATION OF LIABILITY.

UNDER NO CIRCUMSTANCES AND UNDER NO LEGAL THEORY, WHETHER TORT (INCLUDING NEGLIGENCE), CONTRACT, OR OTHERWISE, SHALL YOU, THE INITIAL DEVELOPER, ANY OTHER CONTRIBUTOR, OR ANY DISTRIBUTOR OF COVERED CODE, OR ANY SUPPLIER OF ANY OF SUCH PARTIES, BE LIABLE TO ANY PERSON FOR ANY INDIRECT, SPECIAL, INCIDENTAL, OR CONSEQUENTIAL DAMAGES OF ANY CHARACTER INCLUDING, WITHOUT LIMITATION, DAMAGES FOR LOSS OF GOODWILL, WORK STOPPAGE, COMPUTER FAILURE OR MALFUNCTION, OR ANY AND ALL OTHER COMMERCIAL DAMAGES OR LOSSES, EVEN IF SUCH PARTY SHALL HAVE BEEN INFORMED OF THE POSSIBILITY OF SUCH DAMAGES. THIS LIMITATION OF LIABILITY SHALL NOT APPLY TO LIABILITY FOR DEATH OR PERSONAL INJURY RESULTING FROM SUCH PARTY'S NEGLIGENCE TO THE EXTENT APPLICABLE LAW PROHIBITS SUCH LIMITATION. SOME JURISDICTIONS DO NOT ALLOW THE EXCLUSION OR LIMITATION OF INCIDENTAL OR CONSEQUENTIAL DAMAGES, SO THIS EXCLUSION AND LIMITATION MAY NOT APPLY TO YOU.

10. U.S. GOVERNMENT END USERS.

The Covered Code is a "commercial item," as that term is defined in 48 C.F.R. 2.101 (Oct. 1995), consisting of "commercial computer software" and "commercial computer software documentation," as such terms are used in 48 C.F.R. 12.212 (Sept. 1995). Consistent with 48 C.F.R. 12.212 and 48 C.F.R. 227.7202-1 through 227.7202-4 (June 1995), all U.S. Government End Users acquire Covered Code with only those rights set forth herein.

11. MISCELLANEOUS.

This License represents the complete agreement concerning subject matter hereof. If any provision of this License is held to be unenforceable, such provision shall be reformed only to the extent necessary to make it enforceable. This License shall be governed by California law provisions (except to the extent applicable law, if any, provides otherwise), excluding its conflict-of-law provisions. With respect to disputes in which at least one party is a citizen of, or an entity chartered or registered to do business in the United States of America, any litigation relating to this License shall be subject to the jurisdiction of the Federal Courts of the Northern District of California, with venue lying in Santa Clara County, California, with the losing party responsible for costs, including without limitation, court costs and reasonable attorneys' fees and expenses. The application of the United Nations Convention on Contracts for the International Sale of Goods is expressly excluded. Any law or regulation which provides that the language of a contract shall be construed against the drafter shall not apply to this License.

12. RESPONSIBILITY FOR CLAIMS.

As between Initial Developer and the Contributors, each party is responsible for claims and damages arising, directly or indirectly, out of its utilization of rights under this License and You agree to work with Initial Developer and Contributors to distribute such responsibility on an equitable basis. Nothing herein is intended or shall be deemed to constitute any admission of liability.

13. MULTIPLE-LICENSED CODE.

Initial Developer may designate portions of the Covered Code as Multiple-Licensed. Multiple-Licensed means that the Initial Developer permits you to utilize portions of the Covered Code under Your choice of the MPL or the alternative licenses, if any, specified by the Initial Developer in the file described in Exhibit A.

EXHIBIT A -Mozilla Public License.

``The contents of this file are subject to the Mozilla Public License Version 1.1 (the "License"); you may not use this file except in compliance with the License. You may obtain a copy of the License at <http://www.mozilla.org/MPL/>

Software distributed under the License is distributed on an "AS IS" basis, WITHOUT WARRANTY OF ANY KIND, either express or implied. See the License for the specific language governing rights and limitations under the License.

The Original Code is _____.

The Initial Developer of the Original Code is _____.

Portions created by _____ are Copyright (C) _____
_____.All Rights Reserved.

Contributor(s): _____.

Alternatively, the contents of this file may be used under the terms of the ____ license (the [____] License), in which case the provisions of [____] License are applicable instead of those above.If you wish to allow use of your version of this file only under the terms of the [____] License and not to allow others to use your version of this file under the MPL, indicate your decision by deleting the provisions above and replace them with the notice and other provisions required by the [____] License. If you do not delete the provisions above, a recipient may use your version of this file under either the MPL or the [____] License."

[NOTE: The text of this Exhibit A may differ slightly from the text of the notices in the Source Code files of the Original Code. You should use the text of this Exhibit A rather than the text found in the Original Code Source Code for Your Modifications.]

OpenSSL License

Copyright (c) 1998-2008 The OpenSSL Project. All rights reserved.

Redistribution and use in source and binary forms, with or without modification, are permitted provided that the following conditions are met:

1. Redistributions of source code must retain the above copyright notice, this list of conditions and the following disclaimer.
2. Redistributions in binary form must reproduce the above copyright notice, this list of conditions and the following disclaimer in the documentation and/or other materials provided with the distribution.
3. All advertising materials mentioning features or use of this software must display the following acknowledgment: "This product includes software developed by the OpenSSL Project for use in the OpenSSL Toolkit. (<http://www.openssl.org/>)"
4. The names "OpenSSL Toolkit" and "OpenSSL Project" must not be used to endorse or promote products derived from this software without prior written permission. For written permission, please contact openssl-core@openssl.org.
5. Products derived from this software may not be called "OpenSSL" nor may "OpenSSL" appear in their names without prior written permission of the OpenSSL Project.
6. Redistributions of any form whatsoever must retain the following acknowledgment: "This product includes software developed by the OpenSSL Project for use in the OpenSSL Toolkit (<http://www.openssl.org/>)"

THIS SOFTWARE IS PROVIDED BY THE OpenSSL PROJECT "AS IS" AND ANY EXPRESSED OR IMPLIED WARRANTIES, INCLUDING, BUT NOT LIMITED TO, THE IMPLIED WARRANTIES OF MERCHANTABILITY AND FITNESS FOR A PARTICULAR PURPOSE ARE DISCLAIMED. IN NO EVENT SHALL THE OpenSSL PROJECT OR ITS CONTRIBUTORS BE LIABLE FOR ANY DIRECT, INDIRECT, INCIDENTAL, SPECIAL, EXEMPLARY, OR CONSEQUENTIAL DAMAGES (INCLUDING, BUT NOT LIMITED TO, PROCUREMENT OF SUBSTITUTE GOODS OR SERVICES; LOSS OF USE, DATA, OR PROFITS; OR BUSINESS INTERRUPTION) HOWEVER CAUSED AND ON ANY THEORY OF LIABILITY, WHETHER IN CONTRACT, STRICT LIABILITY, OR TORT (INCLUDING NEGLIGENCE OR OTHERWISE) ARISING IN ANY WAY OUT OF THE USE OF THIS SOFTWARE, EVEN IF ADVISED OF THE POSSIBILITY OF SUCH DAMAGE.

This product includes cryptographic software written by Eric Young (eay@cryptsoft.com).

This product includes software written by Tim Hudson (tjh@cryptsoft.com).

Original SSLey License

Copyright (C) 1995-1998 Eric Young (eay@cryptsoft.com) All rights reserved.

This package is an SSL implementation written by Eric Young (eay@cryptsoft.com).

The implementation was written so as to conform with Netscapes SSL.

This library is free for commercial and non-commercial use as long as the following conditions are adhered to. The following conditions apply to all code found in this distribution, be it the RC4, RSA, lhash, DES, etc., code; not just the SSL code. The SSL documentation included with this distribution is covered by the same copyright terms except that the holder is Tim Hudson (tjh@cryptsoft.com).

Copyright remains Eric Young's, and as such any Copyright notices in the code are not to be removed. If this package is used in a product, Eric Young should be given attribution as the author of the parts of the library used. This can be in the form of a textual message at program startup or in documentation (online or textual) provided with the package.

Redistribution and use in source and binary forms, with or without modification, are permitted provided that the following conditions are met:

1. Redistributions of source code must retain the copyright notice, this list of conditions and the following disclaimer.
2. Redistributions in binary form must reproduce the above copyright notice, this list of conditions and the following disclaimer in the documentation and/or other materials provided with the distribution.

3. All advertising materials mentioning features or use of this software must display the following acknowledgement:

“This product includes cryptographic software written by Eric Young (eay@cryptsoft.com)”

The word ‘cryptographic’ can be left out if the routines from the library being used are not cryptographic related :-).

4. If you include any Windows specific code (or a derivative thereof) from the apps directory (application code) you must include an acknowledgement:

“This product includes software written by Tim Hudson (tjh@cryptsoft.com)”

THIS SOFTWARE IS PROVIDED BY ERIC YOUNG “AS IS” AND ANY EXPRESS OR IMPLIED WARRANTIES, INCLUDING, BUT NOT LIMITED TO, THE IMPLIED WARRANTIES OF MERCHANTABILITY AND FITNESS FOR A PARTICULAR PURPOSE ARE DISCLAIMED. IN NO EVENT SHALL THE AUTHOR OR CONTRIBUTORS BE LIABLE FOR ANY DIRECT, INDIRECT, INCIDENTAL, SPECIAL, EXEMPLARY, OR CONSEQUENTIAL DAMAGES (INCLUDING, BUT NOT LIMITED TO, PROCUREMENT OF SUBSTITUTE GOODS OR SERVICES; LOSS OF USE, DATA, OR PROFITS; OR BUSINESS INTERRUPTION) HOWEVER CAUSED AND ON ANY THEORY OF LIABILITY, WHETHER IN CONTRACT, STRICT LIABILITY, OR TORT (INCLUDING NEGLIGENCE OR OTHERWISE) ARISING IN ANY WAY OUT OF THE USE OF THIS SOFTWARE, EVEN IF ADVISED OF THE POSSIBILITY OF SUCH DAMAGE.

The licence and distribution terms for any publically available version or derivative of this code cannot be changed. i.e. this code cannot simply be copied and put under another distribution licence [including the GNU Public Licence.]

MIT license

- libcurl

Copyright (c) 1996 - 2010, Daniel Stenberg, <daniel@haxx.se>.

All rights reserved.

Permission to use, copy, modify, and distribute this software for any purpose with or without fee is hereby granted, provided that the above copyright notice and this permission notice appear in all copies.

THE SOFTWARE IS PROVIDED “AS IS”, WITHOUT WARRANTY OF ANY KIND, EXPRESS OR IMPLIED, INCLUDING BUT NOT LIMITED TO THE WARRANTIES OF MERCHANTABILITY, FITNESS FOR A PARTICULAR PURPOSE AND NONINFRINGEMENT OF THIRD PARTY RIGHTS. IN NO EVENT SHALL THE AUTHORS OR COPYRIGHT HOLDERS BE LIABLE FOR ANY CLAIM, DAMAGES OR OTHER LIABILITY, WHETHER IN AN ACTION OF CONTRACT, TORT OR OTHERWISE, ARISING FROM, OUT OF OR IN CONNECTION WITH THE SOFTWARE OR THE USE OR OTHER DEALINGS IN THE SOFTWARE.

Except as contained in this notice, the name of a copyright holder shall not be used in advertising or otherwise to promote the sale, use or other dealings in this Software without prior written authorization of the copyright holder.

- ncurses

Copyright (c) 1998 Free Software Foundation, Inc.

Permission is hereby granted, free of charge, to any person obtaining a copy of this software and associated documentation files (the “Software”), to deal in the Software without restriction, including without limitation the rights to use, copy, modify, merge, publish, distribute, distribute with modifications, sublicense, and/or sell copies of the Software, and to permit persons to whom the Software is furnished to do so, subject to the following conditions:

The above copyright notice and this permission notice shall be included in all copies or substantial portions of the Software.

THE SOFTWARE IS PROVIDED “AS IS”, WITHOUT WARRANTY OF ANY KIND, EXPRESS OR IMPLIED, INCLUDING BUT NOT LIMITED TO THE WARRANTIES OF MERCHANTABILITY, FITNESS FOR A PARTICULAR PURPOSE AND NONINFRINGEMENT. IN NO EVENT SHALL THE ABOVE COPYRIGHT HOLDERS BE LIABLE FOR ANY CLAIM, DAMAGES OR OTHER LIABILITY, WHETHER IN AN ACTION OF CONTRACT, TORT OR OTHERWISE, ARISING FROM, OUT OF OR IN CONNECTION WITH THE SOFTWARE OR THE USE OR OTHER DEALINGS IN THE SOFTWARE.

Except as contained in this notice, the name(s) of the above copyright holders shall not be used in advertising or otherwise to promote the sale, use or other dealings in this Software without prior written authorization.

Expat license

The source package was downloaded from <URL:http://expat.sourceforge.net>.

The original packager is Adam Di Carlo <aph@debian.org>.

The current maintainer is Ardo van Rangelrooij <ardo@debian.org>.

Copyright (c) 1998, 1999, 2000 Thai Open Source Software Center Ltd and Clark Cooper

Copyright (c) 2001, 2002, 2003, 2004, 2005, 2006 Expat maintainers.

Permission is hereby granted, free of charge, to any person obtaining a copy of this software and associated documentation files (the "Software"), to deal in the Software without restriction, including without limitation the rights to use, copy, modify, merge, publish, distribute, sublicense, and/or sell copies of the Software, and to permit persons to whom the Software is furnished to do so, subject to the following conditions:

The above copyright notice and this permission notice shall be included in all copies or substantial portions of the Software.

THE SOFTWARE IS PROVIDED "AS IS", WITHOUT WARRANTY OF ANY KIND, EXPRESS OR IMPLIED, INCLUDING BUT NOT LIMITED TO THE WARRANTIES OF MERCHANTABILITY, FITNESS FOR A PARTICULAR PURPOSE AND NONINFRINGEMENT. IN NO EVENT SHALL THE AUTHORS OR COPYRIGHT HOLDERS BE LIABLE FOR ANY CLAIM, DAMAGES OR OTHER LIABILITY, WHETHER IN AN ACTION OF CONTRACT, TORT OR OTHERWISE, ARISING FROM, OUT OF OR IN CONNECTION WITH THE SOFTWARE OR THE USE OR OTHER DEALINGS IN THE SOFTWARE.

The FreeType Project LICENSE

Copyright 1996-2002, 2006 by David Turner, Robert Wilhelm, and Werner Lemberg

Introduction

=====

The FreeType Project is distributed in several archive packages; some of them may contain, in addition to the FreeType font engine, various tools and contributions which rely on, or relate to, the FreeType Project.

This license applies to all files found in such packages, and which do not fall under their own explicit license. The license affects thus the FreeType font engine, the test programs, documentation and makefiles, at the very least.

This license was inspired by the BSD, Artistic, and IJG (Independent JPEG Group) licenses, which all encourage inclusion and use of free software in commercial and freeware products alike. As a consequence, its main points are that:

- We don't promise that this software works. However, we will be interested in any kind of bug reports. ('as is' distribution)
- You can use this software for whatever you want, in parts or full form, without having to pay us. ('royalty-free' usage)
- You may not pretend that you wrote this software. If you use it, or only parts of it, in a program, you must acknowledge somewhere in your documentation that you have used the FreeType code. ('credits')

We specifically permit and encourage the inclusion of this software, with or without modifications, in commercial products. We disclaim all warranties covering The FreeType Project and assume no liability related to The FreeType Project.

Finally, many people asked us for a preferred form for a credit/disclaimer to use in compliance with this license. We

thus encourage you to use the following text:

Portions of this software are copyright <year> The FreeType Project (www.freetype.org). All rights reserved.

Please replace <year> with the value from the FreeType version you actually use.

Legal Terms

0. Definitions

Throughout this license, the terms 'package', 'FreeType Project' and 'FreeType archive' refer to the set of files originally distributed by the authors (David Turner, Robert Wilhelm, and Werner Lemberg) as the 'FreeType Project', be they named as alpha, beta or final release.

'You' refers to the licensee, or person using the project, where 'using' is a generic term including compiling the project's source code as well as linking it to form a 'program' or 'executable'. This program is referred to as 'a program using the FreeType engine'.

This license applies to all files distributed in the original FreeType Project, including all source code, binaries and documentation, unless otherwise stated in the file in its original, unmodified form as distributed in the original archive. If you are unsure whether or not a particular file is covered by this license, you must contact us to verify this.

The FreeType Project is copyright (C) 1996-2000 by David Turner, Robert Wilhelm, and Werner Lemberg. All rights reserved except as specified below.

1. No Warranty

THE FREETYPE PROJECT IS PROVIDED 'AS IS' WITHOUT WARRANTY OF ANY KIND, EITHER EXPRESS OR IMPLIED, INCLUDING, BUT NOT LIMITED TO, WARRANTIES OF MERCHANTABILITY AND FITNESS FOR A PARTICULAR PURPOSE. IN NO EVENT WILL ANY OF THE AUTHORS OR COPYRIGHT HOLDERS BE LIABLE FOR ANY DAMAGES CAUSED BY THE USE OR THE INABILITY TO USE, OF THE FREETYPE PROJECT.

2. Redistribution

This license grants a worldwide, royalty-free, perpetual and irrevocable right and license to use, execute, perform, compile, display, copy, create derivative works of, distribute and sublicense the FreeType Project (in both source and object code forms) and derivative works thereof for any purpose; and to authorize others to exercise some or all of the rights granted herein, subject to the following conditions:

- Redistribution of source code must retain this license file ('FTL.TXT') unaltered; any additions, deletions or changes to the original files must be clearly indicated in accompanying documentation. The copyright notices of the unaltered, original files must be preserved in all copies of source files.
- Redistribution in binary form must provide a disclaimer that states that the software is based in part of the work of the FreeType Team, in the distribution documentation. We also encourage you to put an URL to the FreeType web page in your documentation, though this isn't mandatory.

These conditions apply to any software derived from or based on the FreeType Project, not just the unmodified files. If you use our work, you must acknowledge us. However, no fee need be paid to us.

3. Advertising

Neither the FreeType authors and contributors nor you shall use the name of the other for commercial, advertising, or promotional purposes without specific prior written permission. We suggest, but do not require, that you use one or more of the following phrases to refer to this software in your documentation or advertising materials: 'FreeType Project', 'FreeType Engine', 'FreeType library', or 'FreeType Distribution'.

As you have not signed this license, you are not required to accept it. However, as the FreeType Project is copyrighted material, only this license, or another one contracted with the authors, grants you the right to use, distribute, and modify it. Therefore, by using, distributing, or modifying the FreeType Project, you indicate that you understand and accept all the terms of this license.

4. Contacts

There are two mailing lists related to FreeType:

freetype@nongnu.org

Discusses general use and applications of FreeType, as well as future and wanted additions to the library and distribution. If you are looking for support, start in this list if you haven't found anything to help you in the documentation.

freetype-devel@nongnu.org

Discusses bugs, as well as engine internals, design issues, specific licenses, porting, etc.
Our home page can be found at <http://www.freetype.org>

JPEG license

This software is copyright (C) 1991-1998, Thomas G. Lane.
All Rights Reserved except as specified below.

Permission is hereby granted to use, copy, modify, and distribute this software (or portions thereof) for any purpose, without fee, subject to these conditions:

- (1) If any part of the source code for this software is distributed, then this README file must be included, with this copyright and no-warranty notice unaltered; and any additions, deletions, or changes to the original files must be clearly indicated in accompanying documentation.
- (2) If only executable code is distributed, then the accompanying documentation must state that "this software is based in part on the work of the Independent JPEG Group".
- (3) Permission for use of this software is granted only if the user accepts full responsibility for any undesirable consequences; the authors accept NO LIABILITY for damages of any kind.

zlib/libpng License

This product may contain open source software licensed under zlib/libpng License.

- **Libmng : Copyright © 2000-2008 Gerard Juyn (gerard@libmng.com)**
- **Libpng : Copyright (c) 1998-2008 Glenn Randers-Pehrson**
(Version 0.96 Copyright (c) 1996, 1997 Andreas Dilger)
(Version 0.88 Copyright (c) 1995, 1996 Guy Eric Schalnat, Group 42, Inc.)
- **Md5 checksum : Copyright (C) 1999, 2000, 2002 Aladdin Enterprises.**
- **Zlib : Copyright (C) 1995-2010 Jean-loup Gailly and Mark Adler**

This software is provided 'as-is', without any express or implied warranty. In no event will the authors be held liable for any damages arising from the use of this software.

Permission is granted to anyone to use this software for any purpose, including commercial applications, and to alter it and redistribute it freely, subject to the following restrictions:

1. The origin of this software must not be misrepresented; you must not claim that you wrote the original software. If you use this software in a product, an acknowledgment in the product documentation would be appreciated but is not required.
2. Altered source versions must be plainly marked as such, and must not be misrepresented as being the original software.
3. This notice may not be removed or altered from any source distribution.

Jean-loup Gailly
Mark Adler

X.net license

Copyright (c) 1995-2001 International Business Machines Corporation and others
All rights reserved.

Permission is hereby granted, free of charge, to any person obtaining a copy of this software and associated documen

tation files (the “Software”), to deal in the Software without restriction, including without limitation the rights to use, copy, modify, merge, publish, distribute, and/or sell copies of the Software, and to permit persons to whom the Software is furnished to do so, provided that the above copyright notice(s) and this permission notice appear in all copies of the Software and that both the above copyright notice(s) and this permission notice appear in supporting documentation.

THE SOFTWARE IS PROVIDED “AS IS”, WITHOUT WARRANTY OF ANY KIND, EXPRESS OR IMPLIED, INCLUDING BUT NOT LIMITED TO THE WARRANTIES OF MERCHANTABILITY, FITNESS FOR A PARTICULAR PURPOSE AND NONINFRINGEMENT OF THIRD PARTY RIGHTS. IN NO EVENT SHALL THE COPYRIGHT HOLDER OR HOLDERS INCLUDED IN THIS NOTICE BE LIABLE FOR ANY CLAIM, OR ANY SPECIAL INDIRECT OR CONSEQUENTIAL DAMAGES, OR ANY DAMAGES WHATSOEVER RESULTING FROM LOSS OF USE, DATA OR PROFITS, WHETHER IN AN ACTION OF CONTRACT, NEGLIGENCE OR OTHER TORTIOUS ACTION, ARISING OUT OF OR IN CONNECTION WITH THE USE OR PERFORMANCE OF THIS SOFTWARE.

Except as contained in this notice, the name of a copyright holder shall not be used in advertising or otherwise to promote the sale, use or other dealings in this Software without prior written authorization of the copyright holder.

BSD license

- strace

Copyright (c) 1991, 1992 Paul Kranenburg <pk@cs.few.eur.nl>
 Copyright (c) 1993 Branko Lankester <branko@hacktic.nl>
 Copyright (c) 1993 Ulrich Pegelow <pegelow@moorea.uni-muenster.de>
 Copyright (c) 1995, 1996 Michael Elizabeth Chastain <mec@duracef.shout.net>
 Copyright (c) 1993, 1994, 1995, 1996 Rick Sladkey <jrs@world.std.com>
 Copyright (C) 1998-2003 Wichert Akkerman <wakkerma@deephackmode.org>
 Copyright (c) 2002-2008 Roland McGrath <roland@redhat.com>
 Copyright (c) 2003-2008 Dmitry V. Levin <ldv@altlinux.org>
 Copyright (c) 2007-2008 Jan Kratochvil <jan.kratochvil@redhat.com>
 All rights reserved.

Redistribution and use in source and binary forms, with or without modification, are permitted provided that the following conditions are met:

1. Redistributions of source code must retain the above copyright notice, this list of conditions and the following disclaimer.
2. Redistributions in binary form must reproduce the above copyright notice, this list of conditions and the following disclaimer in the documentation and/or other materials provided with the distribution.
3. Neither the names of PolarSSL or XySSL nor the names of its contributors may be used to endorse or promote products derived from this software without specific prior written permission.

THIS SOFTWARE IS PROVIDED BY THE COPYRIGHT HOLDERS AND CONTRIBUTORS “AS IS” AND ANY EXPRESS OR IMPLIED WARRANTIES, INCLUDING, BUT NOT LIMITED TO, THE IMPLIED WARRANTIES OF MERCHANTABILITY AND FITNESS FOR A PARTICULAR PURPOSE ARE DISCLAIMED. IN NO EVENT SHALL THE COPYRIGHT OWNER OR CONTRIBUTORS BE LIABLE FOR ANY DIRECT, INDIRECT, INCIDENTAL, SPECIAL, EXEMPLARY, OR CONSEQUENTIAL DAMAGES (INCLUDING, BUT NOT LIMITED TO, PROCUREMENT OF SUBSTITUTE GOODS OR SERVICES; LOSS OF USE, DATA, OR PROFITS; OR BUSINESS INTERRUPTION) HOWEVER CAUSED AND ON ANY THEORY OF LIABILITY, WHETHER IN CONTRACT, STRICT LIABILITY, OR TORT (INCLUDING NEGLIGENCE OR OTHERWISE) ARISING IN ANY WAY OUT OF THE USE OF THIS SOFTWARE, EVEN IF ADVISED OF THE POSSIBILITY OF SUCH DAMAGE.

- xyssl

Copyright (C) 2006-2008 Christophe Devine
 Copyright (C) 2009 Paul Bakker <polarssl_maintainer at polarssl dot org>
 All rights reserved.

Redistribution and use in source and binary forms, with or without modification, are permitted provided that the following conditions are met:

1. Redistributions of source code must retain the above copyright notice, this list of conditions and the following dis-

claimer.

2. Redistributions in binary form must reproduce the above copyright notice, this list of conditions and the following disclaimer in the documentation and/or other materials provided with the distribution.
3. Neither the names of PolarSSL or XySSL nor the names of its contributors may be used to endorse or promote products derived from this software without specific prior written permission.

THIS SOFTWARE IS PROVIDED BY THE COPYRIGHT HOLDERS AND CONTRIBUTORS "AS IS" AND ANY EXPRESS OR IMPLIED WARRANTIES, INCLUDING, BUT NOT LIMITED TO, THE IMPLIED WARRANTIES OF MERCHANTABILITY AND FITNESS FOR A PARTICULAR PURPOSE ARE DISCLAIMED. IN NO EVENT SHALL THE COPYRIGHT OWNER OR CONTRIBUTORS BE LIABLE FOR ANY DIRECT, INDIRECT, INCIDENTAL, SPECIAL, EXEMPLARY, OR CONSEQUENTIAL DAMAGES (INCLUDING, BUT NOT LIMITED TO, PROCUREMENT OF SUBSTITUTE GOODS OR SERVICES; LOSS OF USE, DATA, OR PROFITS; OR BUSINESS INTERRUPTION) HOWEVER CAUSED AND ON ANY THEORY OF LIABILITY, WHETHER IN CONTRACT, STRICT LIABILITY, OR TORT (INCLUDING NEGLIGENCE OR OTHERWISE) ARISING IN ANY WAY OUT OF THE USE OF THIS SOFTWARE, EVEN IF ADVISED OF THE POSSIBILITY OF SUCH DAMAGE.

RSA Data Security license

Copyright (C) 1991-2, RSA Data Security, Inc. Created 1991. All rights reserved.

License to copy and use this software is granted provided that it is identified as the "RSA Data Security, Inc. MD5 Message-Digest Algorithm" in all material mentioning or referencing this software or this function.

License is also granted to make and use derivative works provided that such works are identified as "derived from the RSA Data Security, Inc. MD5 Message-Digest Algorithm" in all material mentioning or referencing the derived work.

RSA Data Security, Inc. makes no representations concerning either the merchantability of this software or the suitability of this software for any particular purpose. It is provided "as is" without express or implied warranty of any kind. These notices must be retained in any copies of any part of this documentation and/or software.



The model and serial numbers of the TV is located on the back of the TV
Record it below should you ever need service.

MODEL _____

SERIAL _____

■■■ Regulatory Information cont.

:: FCC Compliance Statement

This equipment has been tested and found to comply within the limits of a Class B digital device pursuant to Part 15 of the FCC Rules. These limits are designed to provide reasonable protection against harmful interference in a residential installation.

This equipment generates, uses, and can radiate radio frequency energy and if not installed and used in accordance with the instructions, may cause harmful interference to radio communications. However, there is no guarantee that interference will not occur in a particular installation.

If this equipment does cause harmful interference to radio or television reception (which can be determined by turning the equipment on and off), the user is encouraged to try to correct the interference by using one or more of the following measures:

- Reorient or relocate the receiving antenna.
- Increase the separation between the equipment and the receiver.
- Connect the equipment into an outlet on a circuit different from that to which the receiver is connected.
- Consult the dealer or an experienced radio/TV technician for help.

Caution: Changes or modifications not expressly approved by the party responsible for compliance could void the user's (or your) authority to operate the equipment. Only peripherals (digital input/output devices, terminals, printers, etc.) certified to comply with the Class B limits may be attached to this monitor. Operation with non-certified peripherals is likely to result in interference to radio and TV reception. Only shielded signal cables may be used with this System.

NOTICE

The regulations are applied only to the products with the ID LABEL indicating specific requirements.

:: Canadian DOC Notice

This Class B digital apparatus meets all requirements of the Canadian Interference-Causing Equipment Regulations. Cet appareil numérique de la classe B

respecte toutes les exigences du Règlement sur le matériel brouilleur du Canada.

NOTICE

The regulations are applied only to the products with the ID LABEL indicating specific requirements.

:: CE Conformity Notice (for Europe)

Products with the "CE" Marking comply with the EMC Directive(89/336/EEC) and LOW VOLTAGE Directive (73/23/EEC) issued by the Commission of the European Community.

Compliance with these directives implies conformity to the following European Norms :

- EN 55022 ; Radio Frequency Interference
- EN 55024 ; Electromagnetic Immunity
- EN 61000-3-2 ; Power Line Harmonics
- EN 61000-3-3 ; Voltage Fluctuations
- EN 60950-1 ; Product Safety

NOTICE

The regulations are applied only to the products with the ID LABEL indicating specific requirements.

:: Low Radiation Compliance (MPR II)

This monitor meets one of the strictest guidelines available today for low radiation emissions, offering the user extra shielding and an antistatic screen coating. These guidelines, set forth by a government agency in Sweden, limit the amount of emission allowed in the Extremely Low Frequency (ELF) and Very Low Frequency (VLF) electromagnetic range.

:: TCO'99 (TCO'99 applied model only)



Congratulations!

You have just purchased a TCO'99 approved and labelled product! Your choice has provided you with a product developed for professional use. Your purchase has also contributed to reducing the burden on the environment and also to the further development of environmentally adapted electronics products.

■■■ Regulatory Information cont.

Why do we have environmentally labelled computers?

In many countries, environmental labelling has become an established method for encouraging the adaptation of goods and services to the environment. With the growing manufacture and usage of electronic equipment throughout the world, there is a recognized concern for the materials and substances used by electronic products with regards to their eventual recycling and disposal. By proper selection of these materials and substances, the impact on the environment can be minimized.

There are also other characteristics of a computer, such as energy consumption levels, that are important from the viewpoints of both the work (internal) and natural (external) environments. Electronic equipment in offices is often left running continuously, resulting in unnecessary consumption of large amounts of energy and additional power generation. From the standpoint of carbon dioxide emissions alone, it is vital to save energy.

What does labelling involve?

The product meets the requirements for the TCO'99 scheme which provides for international and environmental labelling of personal computers and/or displays.

The labelling scheme was developed as a joint effort by the TCO (The Swedish Confederation of Professional Employees), Svenska Naturskyddsforeningen (The Swedish Society for Nature Conservation) and Statens Energimyndighet (The Swedish National Energy Administration).

Approval requirements cover a wide range of issues: ecology, ergonomics, emission of electrical and magnetical fields, energy consumption and electrical safety.

Ecological criteria impose restrictions on the presence and use of heavy metals, brominated and chlorinated flame retardants, and other substances. The product must be prepared for recycling and the manufacturing site(s) shall be certified according to ISO14001 or EMAS registered.

Energy requirements include a demand that the system unit and/or display, after a certain period of inactivity, shall reduce its power consumption to a lower level in one or more stages. The length of time to reactivate the system unit shall be reasonable for the user.

Labelled products must meet strict environmental demands, for example, in respect of the reduction of electrical and magnetical fields as well as work load and

visual ergonomics.

Below you will find a brief summary of the ecological requirements met by this product. The complete ecological criteria document can be found at TCO Development's website <http://www.tcodevelopment.com> or may be ordered from:

TCO Development

SE-114 94 STOCKHOLM, Sweden

Fax: +46 8 782 92 07

Email : development@tco.se

Information regarding TCO'99 approved and labelled products may also be obtained at <http://www.tcodevelopment.com>

Ecological requirements

Flame retardants

Flame retardants may be present in printed wiring board laminates, cables, and housings. Their purpose is to prevent, or at least to delay the spread of fire. Up to 30% by weight of the plastic in a computer casing can consist of flame retardant substances. Many flame retardants contain bromine or chlorine, and these flame retardants are chemically related to PCBs (polychlorinated biphenyls). Both the flame retardants containing bromine or chlorine and the PCBs are suspected of giving rise to health effects, including reproductive damage in fish-eating birds and mammals, due to the bio-accumulative* processes when not disposed of in accordance with strict standards for disposal.

TCO'99 requires that plastic components weighing more than 25 grams shall not contain flame retardants with organically bound bromine or chlorine. Flame retardants are allowed in the printed wiring board laminates due to the lack of commercially available alternatives.

Cadmium**

Cadmium is present in rechargeable batteries and in the colour-generating layers of certain computer displays. TCO'99 requires that batteries, the colour-generating layers of display screens, and the electrical or electronics components shall not contain any cadmium.

Mercury**

Mercury is sometimes found in batteries, relays and switches. TCO'99 requires that batteries shall not contain any mercury. It also demands that mercury is not present in any of the electrical or electronics components associated with the labelled unit. There is however one

■■■ Regulatory Information cont.

exception. Mercury is, for the time being, permitted in the back light system of flat panel monitors as there today is no commercially available alternative. TCO aims on removing this exception when a mercury free alternative is available.

Lead**

Lead can be found in picture tubes, display screens, solders and capacitors. TCO'99 permits the use of lead due to the lack of commercially available alternatives, but in future requirements TCO Development aims at restricting the use of lead.

* Bio-accumulative is defined as substances which accumulate in living organisms.

**Lead, Cadmium and Mercury are heavy metals which are bio-accumulative.

:: **TCO'03** (TCO'03 applied model only)



Congratulations!

The display you have just purchased carries the TCO'03 Displays label.

This means that your display is designed, manufactured and tested according to some of the strictest quality and environmental requirements in the world. This makes for a high performance product, designed with the user in focus that also minimizes the impact on our natural environment. Some of the features of the TCO'03 Display requirements:

Ergonomics

- Good visual ergonomics and image quality in order to improve the working environment for the user and to reduce sight and strain problems. Important parameters are luminance, contrast, resolution, reflectance, colour rendition and image stability.

Energy

- Energy-saving mode after a certain time – beneficial both for the user and the environment
- Electrical safety

Emissions

- Electromagnetic fields

- Noise emissions

Ecology

- The product must be prepared for recycling and the manufacturer must have a certified environmental management system such as EMAS or ISO 14 001
- Restrictions on
 - chlorinated and brominated flame retardants and polymers
 - heavy metals such as cadmium, mercury and lead.

The requirements included in this label have been developed by TCO Development in co-operation with scientists, experts, users as well as manufacturers all over the world. Since the end of the 1980s TCO has been involved in influencing the development of IT equipment in a more user-friendly direction. Our labelling system started with displays in 1992 and is now requested by users and IT-manufacturers all over the world.

For more information, please visit
www.tcodevelopment.com

English

Information for Environmental Preservation

LGE. announced the 'LG Declaration for a Cleaner Environment' in 1994, and this ideal has served as a guiding managerial principle ever since. The Declaration is a foundation that has allowed us to undertake environmentally friendly activities in careful consideration of economic, environmental, and social aspects.

We promote activities for environmental preservation, and we specifically develop our products to embrace the concept of environment-friendly.

We minimize the hazardous materials contained in our products. For example, there is no cadmium to be found in our monitors.

Information for recycling

This monitor may contain parts which could be hazardous to the environment. It is important that this monitor be recycled after use.

LGE. handles all waste monitors through an environmentally acceptable recycling method. There are several take-back and recycling systems currently in

■■■ Regulatory Information cont.

operation worldwide. Many parts will be reused and recycled, while harmful substances and heavy metals are treated by an environmentally friendly method.

If you want to find out more information about our recycling program, please contact your local LG vendor or a corporate representative of LG.

We set our vision and policies on a cleaner world by selecting the issue of the global environment as a task for corporate improvement. Please visit our website for more information about our 'green' policies.

<http://www.lge.com/about/environment/html/Recycling.jsp>

■ ■ ■ Deutsch

Informationen zur Erhaltung der Umwelt

Im Jahr 1994 verkündete LGE die 'LG Declaration for a Cleaner Environment' (LG Erklärung für eine sauberere Umwelt). Seitdem dient dieses Ideal als führendes Prinzip des Unternehmens. Diese Erklärung war die Basis für die Durchführung von

umweltfreundlichen Aktivitäten, wobei wirtschaftliche, umweltbezogene und soziale Aspekte in die Überlegungen mit einbezogen wurden.

Wir fördern Aktivitäten zum Schutz der Umwelt und die Entwicklung unserer Produkte ist darauf ausgerichtet, unserem Konzept bezüglich Umweltfreundlichkeit gerecht zu werden.

Wir sind darauf bedacht, den Anteil der in unseren Produkten enthaltenen schädlichen Materialien zu minimieren. So ist in unseren Monitoren beispielsweise kein Kadmium zu finden.

Informationen zum Thema Recycling

Dieser Monitor enthält Teile, die umweltschädlich sein können. Es ist unbedingt erforderlich, dass der Monitor recycelt wird, nachdem er außer Dienst gestellt wurde.

Bei LGE werden alle ausrangierten Monitore in einem unter umweltbezogenen Aspekten geeigneten Verfahren recycelt. Augenblicklich sind weltweit mehrere Rücknahme- und Recyclingsysteme im Einsatz. Viele Teile werden wieder verwendet und recycelt. Schädliche Substanzen und Schwermetalle werden durch umweltverträgliche Verfahren behandelt.

Falls Sie mehr über unser Recyclingprogramm erfahren möchten, wenden Sie sich bitte an Ihren lokalen LG-Händler oder einen Unternehmensvertreter von LG.

Wir richten unsere Firmenpolitik auf eine sauberere Umwelt hin aus, indem wir umweltspezifische Aspekte als wichtigen Punkt in die Weiterentwicklung unseres Unternehmens einfließen lassen. Zusätzliche Informationen über unsere 'grüne' Firmenpolitik erhalten Sie auf unserer Website.

<http://www.lge.com/about/environment/html/Recycling.jsp>

■ ■ ■ Français

Information sur la protection de l'environnement

LGE a publié sa 'Déclaration en faveur d'un environnement plus propre' en 1994 et celle-ci est restée, depuis lors, un principe directeur de notre entreprise. Cette déclaration a servi de base à notre réflexion et nous a permis de prendre en compte à la fois les aspects économiques et sociaux de nos activités, tout en respectant l'environnement.

Nous encourageons les activités en faveur de la préservation de l'environnement et c'est dans cet esprit que nous développons nos produits : nous réduisons au minimum les matières dangereuses qui entrent dans leur composition et l'on ne trouve pas de cadmium, par exemple, dans nos moniteurs.

Information sur le recyclage

Ce moniteur peut contenir des composants qui présentent un risque pour l'environnement. Il est donc important que celui-ci soit recyclé après usage.

LGE traite les moniteurs en fin de cycle conformément à une méthode de recyclage respectueuse de l'environnement. Nous reprenons nos produits et les recyclons dans plusieurs sites répartis dans le monde entier. De nombreux composants sont réutilisés et recyclés, et les matières dangereuses, ainsi que les métaux lourds, sont traités selon un procédé écologique.

Si vous souhaitez plus de renseignements sur notre programme de recyclage, veuillez contacter votre revendeur LG ou un l'un de nos représentants.

Nous voulons agir pour un monde plus propre et croyons au rôle de notre entreprise dans l'amélioration de l'environnement. Pour plus de renseignements sur notre politique "verte", rendez visite à notre site :

<http://www.lge.com/about/environment/html/Recycling.jsp>

Regulatory Information cont.

Italiano

Informazioni per la tutela dell'ambiente

La LGE. ha annunciato nel 1994 la cosiddetta 'LG Declaration for a Cleaner Environment' (Dichiarazione di LG a favore di un ambiente più pulito), un ideale che da allora funge da principio ispiratore della gestione aziendale. La dichiarazione rappresenta il fondamento che consente di intraprendere attività a favore dell'ambiente tenendo conto degli aspetti economici, ambientali e sociali. Noi della LG, promuoviamo attività a favore della tutela dell'ambiente sviluppando appositamente i nostri prodotti per cogliere il concetto del rispetto dell'ambiente riducendo i materiali dannosi presenti nei nostri prodotti. Ad esempio nei nostri monitor non è presente il cadmio.

Informazioni per il riciclaggio

Il monitor può presentare componenti che potrebbero risultare eventualmente dannosi per l'ambiente. È importante che il monitor sia riciclato al termine del suo utilizzo.

La LGE. gestisce tutti i monitor di rifiuto con un metodo di riciclaggio soddisfacente dal punto di vista ambientale. In tutto il mondo sono attualmente in funzione numerosi sistemi di riciclaggio e recupero. I diversi componenti sono riutilizzati e riciclati, mentre le sostanze dannose e i metalli pesanti vengono trattati con un metodo rispettoso dell'ambiente.

Se si desiderano maggiori informazioni in merito al programma di riciclaggio, è consigliabile rivolgersi al proprio rivenditore LG o ad un rappresentante aziendale della LG.

Noi della LG impostiamo la nostra visione e le nostre politiche a favore di un mondo più pulito ponendo la questione dell'ambiente dal punto di vista globale come una mansione rivolta al miglioramento della nostra azienda. Vi invitiamo a visitare il nostro sito internet per ulteriori informazioni sulla nostra politica "verde".
<http://www.lge.com/about/environment/html/Recycling.jsp>

Espanol

Información para la conservación medioambiental

LGE. presentó la 'Declaración para un entorno más limpio de LG' en 1994 y este ideal ha servido para guiar nuestros principios empresariales desde entonces. La Declaración es la base que nos ha permitido llevar a cabo tareas que

respetan el medio ambiente siempre teniendo en cuenta aspectos sociales, económicos y medioambientales.

Promocionamos actividades orientadas a la conservación del medio ambiente y desarrollamos nuestros productos específicamente para que se ajusten a la filosofía que protege el entorno.

Reducimos al máximo el uso de materiales de riesgo en nuestros productos. Un ejemplo de ello es la ausencia total de cadmio en nuestros monitores.

Información para el reciclaje

Este monitor puede contener piezas que entrañen riesgos medioambientales. Es importante reciclar este monitor después de su utilización.

LGE. trata todos los monitores usados siguiendo un método de reciclaje que no daña al entorno. Contamos con diversos sistemas de recuperación y reciclaje que funcionan a nivel mundial en la actualidad. Es posible reciclar y reutilizar muchas de las piezas, mientras que las sustancias dañinas y los metales pesados se tratan siguiendo un método que no perjudique al medio ambiente. Si desea obtener más información acerca del programa de reciclaje, póngase en contacto con su proveedor local de LG o con un representante empresarial de nuestra marca.

Basamos nuestra visión y nuestras políticas en un mundo más limpio y para ellos optamos por un entorno global como tarea principal de nuestra evolución como empresa. Visite nuestra página Web para obtener más información sobre nuestras políticas ecológicas.

<http://www.lge.com/about/environment/html/Recycling.jsp>

Português

Informações relacionadas à preservação ambiental

A LGE. anunciou a 'LG Declaration for a Cleaner Environment' (Declaração da LG para um ambiente mais limpo) em 1994 e esse ideal tem servido desde então como um princípio administrativo de orientação. A Declaração é a base que nos tem permitido realizar atividades favoráveis ao ambiente com consideração atenta aos aspectos econômicos, ambientais e sociais.

Promovemos atividades de preservação ambiental e desenvolvemos nossos produtos para englobar

■■■ Regulatory Information cont.

especificamente o conceito de favorável ao ambiente.

Reduzimos os materiais perigosos contidos em nossos produtos. Por exemplo, não há cádmio em nossos monitores.

Informações relacionadas à reciclagem

Este monitor pode conter peças que podem representar riscos ao ambiente. É importante que ele seja reciclado após o uso.

A LGE. cuida de todos os monitores descartados através de um método de reciclagem agradável ao ambiente. Há vários sistemas de devolução e reciclagem atualmente em operação no mundo. Muitas peças serão reutilizadas e recicladas e as substâncias nocivas e os metais pesados passarão por tratamento através de um método favorável ao ambiente.

Para obter mais informações sobre nosso programa de reciclagem, entre em contato com seu fornecedor LG local ou com um representante corporativo da LG.

Definimos nossa visão e nossas políticas relacionadas a um mundo mais limpo selecionando a questão do ambiente global como uma tarefa de aprimoramento corporativo. Visite nosso site para obter mais informações sobre nossas políticas de meio ambiente.

<http://www.lge.com/about/environment/html/Recycling.jsp>

■ ■ ■ Nederlands

Informatie met betrekking tot het behoud van het milieu

LGE. publiceerde in 1994 de 'LG Declaration for a Cleaner Environment' (de LG-verklaring met betrekking tot een schoner milieu). Deze verklaring en het ideaal van een schoner milieu fungeren sindsdien als een bestuurlijke leidraad voor onze onderneming. Op basis van deze verklaring ontplooiën wij milieuvriendelijke activiteiten, waarbij er zowel met sociale en economische aspecten, als met milieuaspecten zorgvuldig rekening wordt gehouden.

Wij ondersteunen activiteiten die zijn gericht op het behoud van het milieu en wij houden bij het ontwikkelen onze producten specifiek rekening met de milieuvriendelijkheid van onze producten.

Wij minimaliseren het gebruik van schadelijke stoffen in onze producten. Er wordt bijvoorbeeld geen cadmium verwerkt in onze monitoren.

Informatie met betrekking tot recycling

Deze monitor bevat materialen die schadelijk zouden kunnen zijn voor het milieu. Het is belangrijk dat deze monitor aan het einde van zijn levensduur wordt gerecycled.

LGE. verwerkt alle afvalmonitoren via een milieuvriendelijke recyclingmethode. Hiervoor worden er momenteel wereldwijd verscheidene inname- en recyclingsystemen gehanteerd. Een groot aantal onderdelen wordt opnieuw gebruikt en gerecycled, waarbij schadelijke stoffen en zware metalen volgens een milieuvriendelijke methode worden verwerkt.

Voor meer informatie over ons recyclingprogramma kunt u contact opnemen met uw plaatselijke LG-vertegenwoordiger of een LG-vestiging.

Onze visie en ons beleid met betrekking tot een schonere wereld vloeien voort uit het feit dat wij het milieu hebben aangemerkt als een onderwerp dat speciale aandacht verdient binnen onze onderneming. Bezoek onze website voor meer informatie over ons 'groene' beleid.

<http://www.lge.com/about/environment/html/Recycling.jsp>

■ ■ ■ Russian

Информация по охране окружающей среды

В 1994 году корпорация LGE опубликовала 'Декларацию LG по охране окружающей среды', которая с тех пор служит основным принципом управления. На основе этой декларации мы смогли предпринять действия, обеспечивающие безопасность окружающей среды, уделяя при этом должное внимание экономическим, экологическим и социальным аспектам.

Мы стимулируем деятельность по охране окружающей среды, уделяя особое внимание разработке нашей продукции в соответствии с концепцией экологической безопасности.

Мы сводим к минимуму содержание опасных веществ в нашей продукции. Например, в наших мониторах вы не найдете кадмия.

Информация по утилизации отходов

Этот монитор может содержать компоненты, которые могут нанести ущерб окружающей среде.

■■■ Regulatory Information cont.

Необходимо утилизировать монитор после использования.

Корпорация LGE перерабатывает все бракованные мониторы с помощью экологически приемлемого метода утилизации отходов. По всему миру действуют системы утилизации отходов и возврата использованной продукции. Многие компоненты будут вторично использованы и утилизированы, в то время как вредные вещества и тяжелые металлы будут обработаны с помощью экологически приемлемого метода.

За более подробной информацией по нашей программе утилизации отходов обращайтесь к местному поставщику или представителю корпорации LG.

Мы ориентируемся на обеспечение экологической безопасности, ставя себе целью глобальную защиту окружающей среды. Дополнительную информацию о нашей политике по охране окружающей среды вы можете найти на нашем сайте:
<http://www.lge.com/about/environment/html/Recycling.jsp>

한국어

환경 보존 정보

LG 전자는 1994년 'LG 환경 선언문'을 발표한 후 현재까지 이를 기업 경영의 이념으로 삼아왔습니다. 이 선언문을 바탕으로 LG 전자는 모든 경영 활동에서 경제성뿐만 아니라 환경성 및 사회성을 주요 의사 결정의 기준으로 삼음으로써 지속적으로 환경 친화적인 경영을 전개하고 있습니다.

본사는 보다 활발한 환경 보존 활동과 더불어 환경 친화적 제품 개발에 주력해 왔습니다.

또한 제품에 포함되는 환경 위해 요소를 최소화하는 데에도 노력을 기울이지 않고 있습니다. LG 전자 모니터의 경우 카드뮴을 전혀 사용하지 않는 것에서도 이러한 노력을 알 수 있습니다.

재활용 정보

본 모니터에는 환경에 위해를 주는 부품이 포함되어 있을 수도 있습니다. 따라서 사용이 끝난 모니터는 재활용하는 것이 좋습니다.

폐모니터는 모두 환경 친화적 방식으로 처리됩니다. 현재 세계적으로 운영되고 있는 회수 및 재활용 시스템에는

여러 가지가 있습니다. 대부분의 부품의 경우 재사용 또는 재활용되지만 환경 위해 물질과 중금속은 환경 친화적 방법으로 처리됩니다.

본사의 재활용 프로그램에 대한 자세한 정보는 각 지역의 LG 공급업체나 LG 기업 대표부에 문의하시기 바랍니다.

LG 전자는 기업 개선 정책의 하나로 지구 환경 문제를 채택함으로써 보다 나은 환경을 만들어 나가기 위한 비전과 정책을 수립했습니다. 본사의 친환경 정책에 대한 자세한 정보를 보시려면 아래의 웹 사이트를 방문하십시오.

http://www.lge.co.kr/cckr/about/environ/purity_02.jsp

∴EPA (EPA applied model only)

ENERGY STAR is a set of power-saving guidelines issued by the U.S. Environmental Protection Agency(EPA).



As an ENERGY STAR Partner LGE U. S. A.,Inc. has determined that this product meets the ENERGY STAR guidelines for energy efficiency.

∴NOM MARK (Mexico only)



■■■ Regulatory Information cont.

:: WEEE (for Europe)



English

Disposal of your old appliance

1. When this crossed-out wheeled bin symbol is attached to a product it means the product is covered by the European Directive 2002/96/EC.
2. All electrical and electronic products should be disposed of separately from the municipal waste stream via designated collection facilities appointed by the government or the local authorities.
3. The correct disposal of your old appliance will help prevent potential negative consequences for the environment and human health.
4. For more detailed information about disposal of your old appliance, please contact your city office, waste disposal service or the shop where you purchased the product.

French

Élimination de votre ancien appareil

1. Ce symbole, représentant une poubelle sur roulettes barrée d'une croix, signifie que le produit est couvert par la directive européenne 2002/96/EC.
2. Les éléments électriques et électroniques doivent être jetés séparément, dans les vide-ordures prévus à cet effet par votre municipalité.
3. Une élimination conforme aux instructions aidera à réduire les conséquences négatives et risques éventuels pour l'environnement et la santé humaine.
4. Pour plus d'information concernant l'élimination de votre ancien appareil, veuillez contacter votre mairie, le service des ordures ménagères ou encore la magasin où vous avez acheté ce produit.

Italian

Smaltimento delle apparecchiature obsolete

1. Quando su un prodotto è riportato il simbolo di

un bidone della spazzatura barrato da una croce significa che il prodotto è coperto dalla direttiva europea 2002/96/EC.

2. Tutti i prodotti elettrici ed elettronici dovrebbero essere smaltiti separatamente rispetto alla raccolta differenziata municipale, mediante impianti di raccolta specifici designati dal governo o dalle autorità locali.
3. Il corretto smaltimento delle apparecchiature obsolete contribuisce a prevenire possibili conseguenze negative sulla salute umana e sull'ambiente.
4. Per informazioni più dettagliate sullo smaltimento delle apparecchiature obsolete, contattare il comune, il servizio di smaltimento rifiuti o il negozio in cui è stato acquistato il prodotto.

Swedish

Kassering av din gamla apparat

1. När den här symbolen med en överkryssad soptunna på hjul sitter på en produkt innebär det att den regleras av European Directive 2002/96/EC.
2. Alla elektriska och elektroniska produkter bör kasseras via andra vägar än de som finns för hushållsavfall, helst via för ändamålet avsedda uppsamlingsanläggningar som myndigheterna utser.
3. Om du kasserar din gamla apparat på rätt sätt så bidrar du till att förhindra negativa konsekvenser för miljön och människors hälsa.
4. Mer detaljerad information om kassering av din gamla apparat kan fås av kommunen, renhållningsverket eller den butik där du köpte produkten.

Dutch

Uw oude toestel wegdoen

1. Als het symbool met de doorgekruiste verrijdbare afvalbak op een product staat, betekent dit dat het product valt onder de Europese Richtlijn 2002/96/EC.
2. Elektrische en elektronische producten mogen niet worden meegegeven met het huishoudelijk afval, maar moeten worden ingeleverd bij speciale inzamelingspunten die door de lokale of landelijke overheid zijn aangewezen.
3. De correcte verwijdering van uw oude toestel helpt negatieve gevolgen voor het milieu en de menselijke gezondheid voorkomen.

Regulatory Information cont.

4. Wilt u meer informatie over de verwijdering van uw oude toestel? Neem dan contact op met uw gemeente, de afvalophaaldienst of de winkel waar u het product hebt gekocht.

Finnish

Vanhonjen laitteiden hävittäminen

1. Tämä merkki tuotteessa tarkoittaa, että tuote kuuluu sähkö- ja elektroniikkalaiteromusta annetun EU-direktiivin 2002/96/EY soveltamisalaan.
2. Kaikki elektroniset laitteet ovat ongelmajätettä, joten ne on toimitettava paikalliseen keräyspisteeseen.
3. Vanhan laitteen asianmukainen hävittäminen ehkäisee mahdollisia ympäristöön ja terveyteen kohdistuvia haittavaikutuksia.
4. Lisätietoa vanhan laitteen hävittämisestä saat ottamalla yhteyden paikallisiin viranomaisiin, kierrätyskeskukseen tai myymälään, josta ostit laitteen.

German

Entsorgung von Altgeräten

1. Wenn dieses Symbol eines durchgestrichenen Abfalleimers auf einem Produkt angebracht ist, unterliegt dieses Produkt der europäischen Richtlinie 2002/96/EC.
2. Alle Elektro- und Elektronik-Altgeräte müssen getrennt vom Hausmüll über dafür staatlich vorgesehenen Stellen entsorgt werden.
3. Mit der ordnungsgemäßen Entsorgung des alten Geräts vermeiden Sie Umweltschäden und eine Gefährdung der persönlichen Gesundheit.
4. Weitere Informationen zur Entsorgung des alten Geräts erhalten Sie bei der Stadtverwaltung, beim Entsorgungsamt oder in dem Geschäft, wo Sie das Produkt erworben haben.

Danish

Sådan smider du dit gamle apparat ud

1. Når der er et tegn med et kryds over en skraldespand, betyder det, at produktet er omfattet af EU-direktiv 2002/96/EC.
2. Alle elektriske og elektroniske produkter skal smides ud et andet sted end gennem den kommunale affaldsordning ved hjælp af specielle indsamlingsfaciliteter, der er organiseret af staten

eller de lokale myndigheder.

3. Korrekt bortskaffelse af dit gamle apparat er med til at forhindre mulige skadevirkninger på miljøet og menneskelig sundhed.
4. Mere detaljerede oplysninger om bortskaffelse af dit gamle apparat kan fås ved at kontakte dit lokale kommunekontor, renovationselskab eller den butik, hvor du købte produktet.

Greek

Απόρριψη της παλιάς σας συσκευής

1. Όταν ένα προϊόν διαθέτει το σύμβολο ενός διαγραμμένου κάλαθου απορριμμάτων, τότε το προϊόν καλύπτεται από την Ευρωπαϊκή Οδηγία 2002/96/ΕΟΚ.
2. Η απόρριψη όλων των ηλεκτρικών και ηλεκτρονικών προϊόντων πρέπει να γίνεται χωριστά από τα γενικά οικιακά απορρίμματα μέσω καθορισμένων εγκαταστάσεων συλλογής απορριμμάτων, οι οποίες έχουν δημιουργηθεί είτε από την κυβέρνηση ή από τις τοπικές αρχές.
3. Η σωστή απόρριψη της παλιάς σας συσκευής θα βοηθήσει στην αποτροπή πιθανών αρνητικών συνπειών ως προς το περιβάλλον και την υγεία του ανθρώπου.
4. Για πιο λεπτομερείς πληροφορίες σχετικά με την απόρριψη της παλιάς σας συσκευής, επικοινωνήστε με το αρμόδιο τοπικό γραφείο, υπηρεσία διάθεσης οικιακών απορριμμάτων ή το μαγαζί από το οποίο αγοράσατε το προϊόν.

Spanish

Cómo deshacerse de aparatos eléctricos y electrónicos viejos

1. Si en un producto aparece el símbolo de un contenedor de basura tachado, significa que éste se acoge a la Directiva 2002/96/CE.
2. Todos los aparatos eléctricos o electrónicos se deben desechar de forma distinta del servicio municipal de recogida de basura, a través de puntos de recogida designados por el gobierno o las autoridades locales.
3. La correcta recogida y tratamiento de los dispositivos inservibles contribuye a evitar riesgos potenciales para el medio ambiente y la salud pública.
4. Para obtener más información sobre cómo deshacerse de sus aparatos eléctricos y electrónicos viejos, póngase en contacto con su ayuntamiento, el servicio de recogida de basuras o el establecimiento donde adquirió el producto.

Regulatory Information cont.

Portuguese

Eliminação do seu antigo aparelho

1. Quando este símbolo de latão cruzado estiver afixado a um produto, significa que o produto é abrangido pela Directiva Europeia 2002/96/EC.
2. Todos os produtos eléctricos e electrónicos devem ser eliminados separadamente do lixo doméstico através de pontos de recolha designados, facilitados pelo governo ou autoridades locais.
3. A eliminação correcta do seu aparelho antigo ajuda a evitar potenciais consequências negativas para o ambiente e para a saúde humana.
4. Para obter informações mais detalhadas acerca da eliminação do seu aparelho antigo, contacte as autoridades locais, um serviço de eliminação de resíduos ou a loja onde comprou o produto.

Slovak

Likvidácia váš ho starého prístroja

1. Keď sa na produkte nachádza tento symbol prečiarknutej smetnej nádoby s kolieskami, znamená to, že daný produkt vyhovuje európskej Smernici č. 2002/96/EC.
2. Všetky elektrické a elektronické produkty by mali byť zlikvidované oddelene od komunálneho odpadu prostredníctvom na to určených zberných zariadení, ktoré boli ustanovené vládou alebo orgánmi miestnej správy.
3. Správnu likvidáciu starých zariadení pomôžete predchádzať potenciálnym negatívnym následkom pre prostredie a ľudské zdravie.
4. Podrobnejšie informácie o likvidácii starých zariadení nájdete na miestnom úrade, v službe na likvidáciu odpadu alebo u predajcu, kde ste tento produkt zakúpili.

Czech

Likvidace starých spotřebičů

1. Pokud je u výrobku uveden symbol pojízdného kontejneru v přeškrtnutém poli, znamená to, že na výrobek se vztahuje směrnice Evropské unie číslo 2002/96/EC.
2. Všechny elektrické a elektronické výrobky by měly být likvidovány odděleně od běžného komunálního odpadu prostřednictvím sběrných zařízení zřízených za tímto účelem vládou nebo místní samosprávou.
3. Správný způsob likvidace starého elektrického spotřebiče pomáhá zamezit možným negativním dopadům na životní prostředí a zdraví.
4. Bližší informace o likvidaci starého spotřebiče získáte u místní samosprávy, ve sběrném zařízení nebo v obchodě, ve kterém jste výrobek zakoupili.

Croatian

Uklanjanje starog aparata

1. Ako se na proizvodu nalazi simbol prekrizhene kante za smeće, to znači da je proizvod pokriven europskom direk-

tivom 2002/96/EC.

2. Električni i elektronski proizvodi ne smiju se odlagati zajedno s komunalnim otpadom, već u posebna odlagališta koja je odredila vlada ili lokalne vlasti.
3. Pravilno odlaganje starog proizvoda sprečiti će potencijalne negativne posljedice po okoliš i zdravlje ljudi.
4. Podrobnije informacije o odlaganju starog proizvoda potražite u gradskom uredu, službi za odlaganje otpada ili u trgovini u kojoj ste kupili proizvod.

Hungarian

Régi eszközök ártalmatlanítása

1. A termékhez csatolt áthúzott, keresek szeméttároló jel jelöli, hogy a termék a 2002/96/EC EU-direktíva hatálya alá esik.
2. Minden elektromos és elektronikai terméket a lakossági hulladéktól elkülönítve kell begyűjteni, a kormány vagy az önkormányzatok által kijelölt begyűjtő eszközök használatával.
3. Régi eszközeinek megfelelő ártalmatlanítása segíthet megelőzni az esetleges egészségre vagy környezetre ártalmas hatásokat.
4. Ha több információra van szüksége régi eszközeinek ártalmatlanításával kapcsolatban, tanulmányozza a vonatkozó környezetvédelmi szabályokat, vagy lépjen kapcsolatba az üzlettel, ahol a terméket vásárolta.

Polish

Utylizacja starych urządzeń

1. Kiedy do produktu dołączony jest niniejszy przekreślony symbol kołowego pojemnika na śmieci, oznacza to, że produkt jest objęty dyrektywą 2002/96/EC.
2. Wszystkie elektryczne i elektroniczne produkty powinny być utylizowane niezależnie od odpadów miejskich, z wykorzystaniem przeznaczonych do tego miejsc składowania wskazanych przez rząd lub miejscowe władze.
3. Właściwy sposób utylizacji starego urządzenia pomoże zapobiec potencjalnie negatywnemu wpływowi na zdrowie i środowisko.
4. Aby uzyskać więcej informacji o sposobach utylizacji starych urządzeń, należy skontaktować się z władzami lokalnymi, przedsiębiorstwem zajmującym się utylizacją odpadów lub sklepem, w którym produkt został kupiony.

■■■ Regulatory Information cont.

■ ■ ■ Estonian

Kasutuskõlbmatu seadme käitlemise kord

1. Kui seade on märgistatud selle elektri- ja elektroonikaseadmete lahuskogumist märgistava tähisega (ratastega prügikonteineri kujutis, millele on rist peale tõmmatud), tuleb toodet käidelda vastavalt Eurodirektiivile 2002/96/EÜ.
2. Elektri- ja elektroonikaseadmeid ei tohi visata tavalise prügi hulka. Nad kuuluvad lahuskogumisele selleks määratud kogumispunktides.
3. Kasutuskõlbmatu tervikseadme käitlemine tavaprügist lahus on korraldatud selleks, et vältida negatiivseid tagajärgi, mida põhjustaksid seadme osade purunemisel vabaneda võivad ohtlikud jäätmed loodusele või inimorganismile.
4. Täpsemat informatsiooni selle kohta, kuhu ja millal saab ära anda oma kasutamiskõlbmatu elektri- ja elektroonikaseadme, küsige kohalikult omavalitsuselt, prügifirmalt või kaupluselt, kust seadme ostsite.

■ ■ ■ Latvian

Vecās elektroierīces nodošana

1. Ja uz produkta ir simbols ar pārsvītrotu atkritumu tvertni, tas nozīmē, ka produkts ir iekļauts Eiropas direktīvā 2002/96/EC.
2. Visi elektriskie un elektroniskie produkti ir jāutilizē, nododot pašvaldības īpaši noteiktās pieņemšanas vietās. Tos nedrīkst izmest parastās municipalitātes atkritumu urnās.
3. Ievērojot prasības veco elektroierīču utilizēšanā, jūs pasargāsiet apkārtējo vidi un cilvēku veselību no iespējami nelabvēlīgajām sekām, kādas varētu rasties, ierīcēm sadaloties nepiemērotā vietā.
4. Lai gūtu plašāku informāciju par veco ierīču utilizēšanas iespējām, sazinieties ar pilsētas pašvaldību, atkritumu savākšanas saimniecību vai veikalu, kurā ierīci iegādājāties.

■ ■ ■ Lithuanian

Senos įrangos atliekų tvarkymas

1. Užbrauktas konteinerio simbolis prītvirtintas ant prekės reiškia, kad įrangą saugo Europos direktyva 2002/96/EC.
2. Visos elektros ir elektroninės įrangos atliekos turi būti renkamos atskirai ir neišmetamos į atliekų konteinerį kartu su kitomis komunalinėmis atliekomis, taikant specialią atliekų surinkimo sistemą, patvirtintą vyriausybės ar vietos valdžios.
3. Teisingas senos įrangos atliekų tvarkymas, padės išvengti neigiamų pasekmių aplinkai ir žmonių sveikatai.
4. Dėl išsamesnės informacijos apie senos įrangos tvarkymą, prašome kreiptis į miesto valdžią, atliekų perdirbimo tarnybą arba parduotuvę, kurioje pirkote įrangą.