

APPENDIX H
: USER'S MANUAL



LCD TV OWNER'S MANUAL

LCD TV MODELS

42LBX

47LBX

52LBX

Please read this manual carefully before operating your set.

Retain it for future reference.

Record model number and serial number of the set.

See the label attached on the back cover and quote this information to your dealer when you require service.

ENERGY STAR is a set of power-saving guidelines issued by the U.S. Environmental Protection Agency(EPA).



As an ENERGY STAR Partner LGE U. S. A.,Inc. has determined that this product meets the ENERGY STAR guidelines for energy efficiency.

WARNING / CAUTION



WARNING / CAUTION

**RISK OF ELECTRIC SHOCK
DO NOT OPEN**



**TO REDUCE THE RISK OF ELECTRIC SHOCK
DO NOT REMOVE COVER (OR BACK). NO
USER SERVICEABLE PARTS INSIDE. REFER TO
QUALIFIED SERVICE PERSONNEL.**



The lightning flash with arrowhead symbol, within an equilateral triangle, is intended to alert the user to the presence of uninsulated “dangerous voltage” within the product’s enclosure that may be of sufficient magnitude to constitute a risk of electric shock to persons.



The exclamation point within an equilateral triangle is intended to alert the user to the presence of important operating and maintenance (servicing) instructions in the literature accompanying the appliance.

WARNING/CAUTION

TO REDUCE THE RISK OF FIRE AND ELECTRIC SHOCK, DO NOT EXPOSE THIS PRODUCT TO RAIN OR MOISTURE.

NOTE TO CABLE/TV INSTALLER

This reminder is provided to call the CATV system installer’s attention to Article 820-40 of the National Electric Code (U.S.A.). The code provides guidelines for proper grounding and, in particular, specifies that the cable ground shall be connected to the grounding system of the building, as close to the point of the cable entry as practical.

WARNING / CAUTION

To prevent fire or shock hazards, do not expose this product to rain or moisture.

FCC NOTICE

Class B digital device

This equipment has been tested and found to comply with the limits for a Class B digital device, pursuant to Part 15 of the FCC Rules. These limits are designed to provide reasonable protection against harmful interference in a residential installation. This equipment generates, uses and can radiate radio frequency energy and, if not installed and used in accordance with the instructions, may cause harmful interference to radio communications. However, there is no guarantee that interference will not occur in a particular installation. If this equipment does cause harmful interference to radio or television reception, which can be determined by turning the equipment off and on, the user is encouraged to try to correct the interference by one or more of the following measures:

- Reorient or relocate the receiving antenna.
- Increase the separation between the equipment and receiver.
- Connect the equipment to an outlet on a circuit different from that to which the receiver is connected.
- Consult the dealer or an experienced radio/TV technician for help.

Any changes or modifications not expressly approved by the party responsible for compliance could void the user’s authority to operate the equipment.

CAUTION

Do not attempt to modify this product in any way without written authorization from LG Electronics. Unauthorized modification could void the user’s authority to operate this product

SAFETY INSTRUCTIONS

IMPORTANT SAFETY INSTRUCTIONS

Important safety instructions shall be provided with each apparatus. This information shall be given in a separate booklet or sheet, or be located before any operating instructions in an instruction for installation for use and supplied with the apparatus.

This information shall be given in a language acceptable to the country where the apparatus is intended to be used. The important safety instructions shall be entitled "Important Safety Instructions". The following safety instructions shall be included where applicable, and, when used, shall be verbatim as follows. Additional safety information may be included by adding statements after the end of the following safety instruction list. At the manufacturer's option, a picture or drawing that illustrates the intent of a specific safety instruction may be placed immediately adjacent to that safety instruction:

Read these instructions.

Keep these instructions.

Heed all warnings.

Follow all instructions.



- 1** Do not use this apparatus near water.



- 2** Clean only with dry cloth.



- 3** Do not block any ventilation openings. Install in accordance with the manufacturer's instructions.

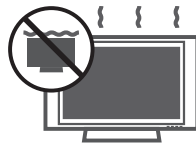

- 4** Do not install near any heat sources such as radiators, heat registers, stoves, or other apparatus (including amplifiers) that produce heat.



- 5** Do not defeat the safety purpose of the polarized or grounding-type plug. A polarized plug has two blades with one wider than the other. A grounding type plug has two blades and a third grounding prong. The wide blade or the third prong are provided for your safety. If the provided plug does not fit into your outlet, consult an electrician for replacement of the obsolete outlet.



- 6** Protect the power cord from being walked on or pinched particularly at plugs, convenience receptacles, and the point where they exit from the apparatus.



- 7** Only use attachments/accessories specified by the manufacturer.



- 8** Unplug this apparatus when unused for long periods of time.

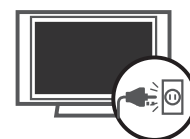

- 9 Use only with the cart, stand, tripod, bracket, or table specified by the manufacturer, or sold with the apparatus. When a cart is used, use caution when moving the cart/apparatus combination to avoid injury from tip-over.



- 10 Never touch this apparatus or antenna during a thunder or lightning storm.

- 11 Do not allow a impact shock or any objects to fall into the product, and do not drop onto the screen with something.

- 12 Refer all servicing to qualified service personnel. Servicing is required when the apparatus has been damaged in any way, such as power-supply cord or plug is damaged, liquid has been spilled or objects have fallen into the apparatus, the apparatus has exposed to rain or moisture, does not operate normally, or has been dropped.

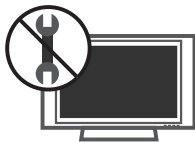

- 13 CAUTION concerning the Power Cord : Most appliances recommend they be placed upon a dedicated circuit; that is, a single outlet circuit which powers only that appliance and has no additional outlets or branch circuits. Check the specification page of this owner's manual to be certain.

Do not overload wall outlets. Overloaded wall outlets, loose or damaged wall outlets, extension cords, frayed power cords, or damaged or cracked wire insulation are dangerous. Any of these conditions could result in electric shock or fire. Periodically examine the cord of your appliance, and if its appearance indicates damage or deterioration, unplug it, discontinue use

of the appliance, and have the cord replaced with an exact replacement part by an authorized servicer. Protect the power cord from physical or mechanical abuse, such as being twisted, kinked, pinched, closed in a door, or walked upon. Pay particular attention to plugs, wall outlets, and the point where the cord exits the appliance.



- 14 Outdoor use marking :
WARNING - To reduce the risk of fire or electric shock, do not expose this appliance to rain or moisture.



- 15 Wet Location Marking : Apparatus shall not be exposed to dripping or splashing and no objects filled with liquids, such as vases, shall be placed on or over apparatus.



16 GROUNDING

Ensure that you connect the earth ground wire to prevent possible electric shock. If grounding methods are not possible, have a qualified electrician install a separate circuit breaker.

Do not try to ground the unit by connecting it to telephone wires, lightening rods, or gas pipes.

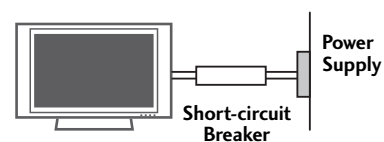

- 17 DISCONNECTING DEVICE FROM MAINS
Mains plug is the disconnecting device. The plug must remain readily operable.

CONTENTS

WARNING / CAUTION	1
SAFETY INSTRUCTIONS	2
FEATURE OF THIS TV	6

PREPARATION

Accessories	7
Front Panel Information	8
Back Panel Information	9
Attaching the TV to a Wall	10
Back Cover for Wire Arrangement	11
Desktop Pedestal Installation	12
VESA Wall Mounting	12
Antenna or Cable Connection	13

EXTERNAL EQUIPMENT SETUP

HD Receiver Setup	14
DVD Setup	17
VCR Setup	19
PC Setup	21
Other A/V Source Setup	26
USB In Setup	26
Audio Out Setup	27

WATCHING TV / CHANNEL CONTROL

Remote Control Key Functions	28
Turning On TV	30
Channel Selection	30
Volume Adjustment	30
On-Screen Menus Selection	31
Channel Setup	
- Auto Scan (Auto Tuning)	32
- Add / Delete Channel (Manual Tuning)	33
- Channel Editing	34
Input List	35
Simplink	36
Input Label	38

MEDIAHOST

Entry Modes	39
Photo List	40
Music List	44

PICTURE CONTROL

Picture Size (Aspect Ratio) Control	46
Preset Picture Settings	
- Picture Mode - Preset	47
- Color Tone - Preset	48
Manual Picture Adjustment	
- Picture Mode - User Mode	49
- Color Tone - User Mode	50
XD - Picture Improvement Technology	51
Advanced - Cinema 3:2 Pulldown Mode	52
Advanced - Black (Darkness) Level	53
Advanced - TruM	54
TruM Demo	55
Picture Reset	56

SOUND & LANGUAGE CONTROL

Auto Volume Leveller (Auto Volume)	57
Preset Sound Setting (Sound Mode)	58
Sound Setting Adjustment - User Mode	59
Balance	60
Stereo/SAP Broadcasts Setup	61
TV Speakers On/Off Setup	62
Audio Language	63
On-Screen Menus Language Selection	64
Caption Mode	65
- Analog Broadcasting System Captions	66
- Digital Broadcasting System Captions	67
- Caption Option	68

TIME SETTING

Clock Setting	
- Auto Clock Setup	69
- Manual Clock Setup	70
Auto On/Off Timer Setting	71
Sleep Timer Setting	72
Auto Shut-off Setting	73

PARENTAL CONTROL / RATINGS

Set Password & Lock System	74
Channel Blocking	76
Movie & TV Rating	77
External Input Blocking	80
Key Lock	80

APPENDIX

Troubleshooting	81
Maintenance	83
Product Specifications	84
Programming the Remote Control	85
IR Codes	89
External Control Through RS-232C	91

FEATURES OF THIS TV



SRS is a trademark of SRS Labs, Inc. TruSurround XT technology is incorporated under license from SRS Labs, Inc.



LG TV with this logo displays Full HD (high-definition) 1080p native resolution by receiving and processing a Full HD 1080p signal.



LG TV with this logo can play MP3 music from a MP3 player, such as iPod, and JPEG images from a digital camera through the USB device.



With HDMI CEC support of LG's audio/video device connected to the HDMI (high-definition multimedia interface), LG TV with this logo works easily with one remote control.



It has three HDMI ports that connect audio and video devices with one cable and produces the highest quality digital images and sound.



?



Manufactured under license from Dolby Laboratories. "Dolby" and the double-D symbol are trademarks of Dolby Laboratories.



High-definition television. High-resolution digital television broadcast and playback system composed of roughly a million or more pixels, 16:9 aspect-ratio screens, and AC3 digital audio. A subset of digital television, HDTV formats include 1080i and 720p resolutions.



LG's own special digital image generator, consisting of a full digital image processor, six different main picture quality factors.



?



?

- If the TV feels cold to the touch, there may be a small "flicker" when it is turned on. This is normal, there is nothing wrong with TV.
- Some minute dot defects may be visible on the screen, appearing as tiny red, green, or blue spots. However, they have no adverse effect on the monitor's performance.
- Avoid touching the LCD screen or holding your finger(s) against it for long periods of time. Doing so may produce some temporary distortion effects on the screen.

On Disposal

- a. The fluorescent lamp used in this product contains a small amount of mercury.
- b. Do not dispose of this product with general household waste.
- c. Disposal of this product must be carried out in accordance to the regulations of your local authority.

PREPARATION

ACCESSORIES

Ensure that the following accessories are included with your plasma display. If an accessory is missing, please contact the dealer where you purchased the product.

User must use shielded signal interface cables (D-sub 15 pin cable) with ferrite cores to maintain standard compliance for the product.

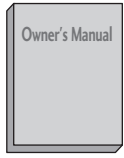

Owner's Manual



CD Manual



Remote Control

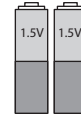

Batteries

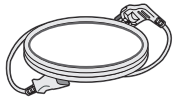

Power Cord

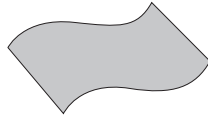

Polishing Cloth

- Slightly wipe stained spot on the exterior only with the polishing cloth for the product exterior if there is stain or fingerprint on surface of the exterior.
- Do not wipe roughly when removing stain. Please be cautious of that excessive power may cause scratch or discoloration.



75ohm Round Cable

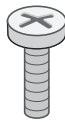

2- TV Bracket Bolts

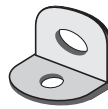

2- TV Brackets,
2- Wall Brackets

Option Extras

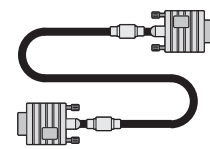

D-sub 15 pin Cable



Cable Management



Twist Holder
Arrange the wires with the
twist holder.

PREPARATION

FRONT PANEL INFORMATION

- Here shown may be somewhat different from your TV.
- **NOTE:** If your product has a protection tape attached, remove the tape. And then wipe the product with a cloth (If a polishing cloth is included with your product, use it).

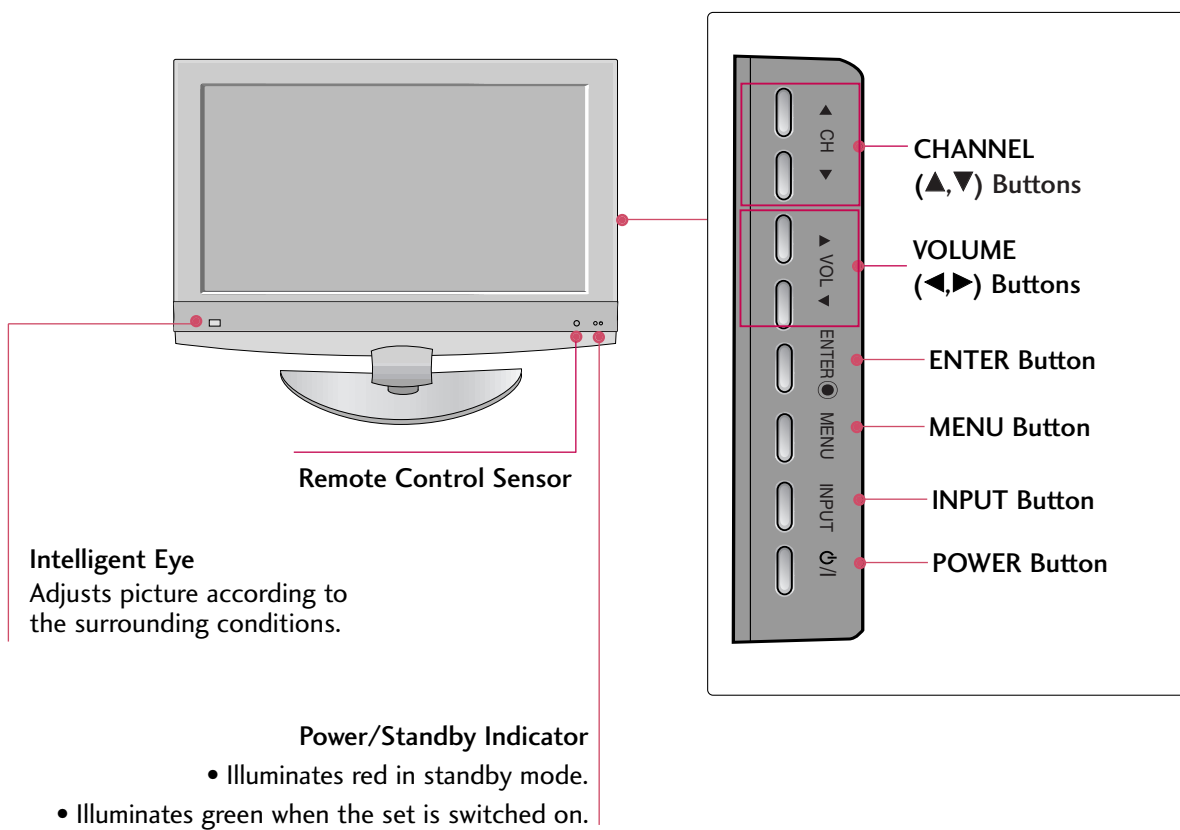

BACK PANEL INFORMATION

- Here shown may be somewhat different from your TV.

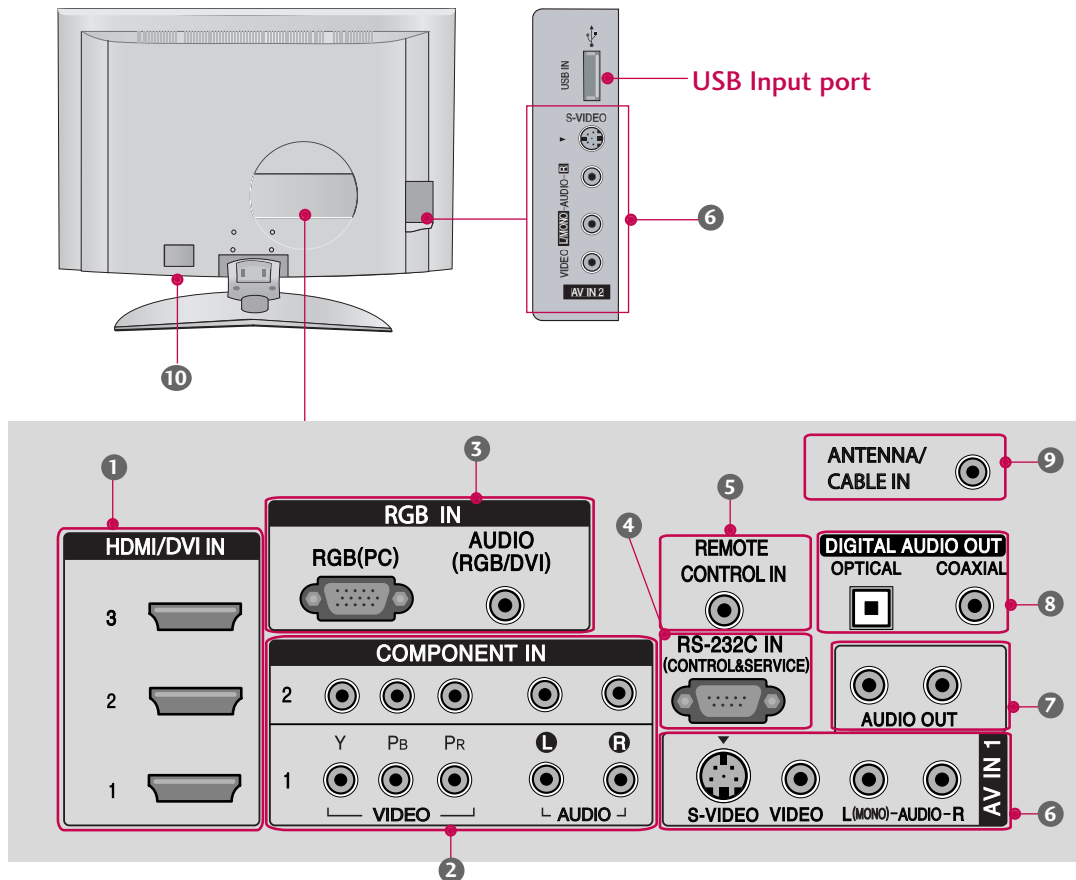

- HDMI/DVI IN**
Connect a HDMI signal to 1, 2 or 3.
Or DVI (VIDEO) signal to the 1, 2 or 3 port with a DVI to HDMI cable.
- COMPONENT IN**
Connect a component video/audio device to these jacks.
- RGB(PC)
AUDIO (RGB/DVI)**
Connect the monitor output from a PC to the appropriate input port.
- RS-232C IN (CONTROL & SERVICE) PORT**
Connect to the RS-232C port on a PC.
- REMOTE CONTROL PORT**
Connect your wired remote control.
- AV (Audio/Video) IN 1**
Connect audio/video output from an external device to these jacks.
S-VIDEO
Connect S-Video out from an S-VIDEO device.
- AUDIO OUT**
Connect analog audio to various types of equipment.
- DIGITAL AUDIO OUT**
Connect digital audio to various types of equipment.
Note: In standby mode, these ports do not work.
- ANTENNA/CABLE IN**
Connect over-the air signals to this jack.
Connect cable signals to this jack.
- Power Cord Socket**
For operation with AC power.
Caution: Never attempt to operate the TV on DC power.

PREPARATION

ATTACHING THE TV TO A WALL

- Here shown may be somewhat different from your TV.

We recommend that you set up the TV close to a wall so it cannot fall over if pushed backwards. Additionally, we recommend that the TV be attached to a wall so it cannot be pulled in a forward direction, potentially causing injury or damaging the product.

Caution: Please make sure that children don't climb on or hang from the TV.

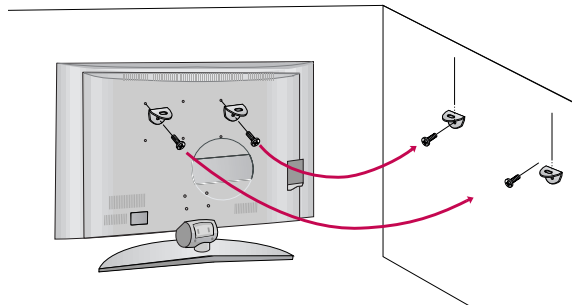

- Insert the eye-bolts (or TV brackets and bolts) to tighten the product to the wall as shown in the picture.
*Insert the eye-bolts and tighten them securely in the upper holes.
Secure the wall brackets with the bolts (not provided as parts of the product, must purchase separately) to the wall. Match the height of the bracket that is mounted on the wall to the holes in the product.
Ensure the eye-bolts or brackets are tightened securely.

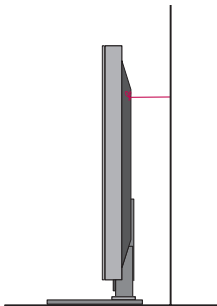

- Use a sturdy rope (not provided as parts of the product, must purchase separately) to tie the product. It is safer to tie the rope so it becomes horizontal between the wall and the product.

BACK COVER FOR WIRE ARRANGEMENT

■ Here shown may be somewhat different from your TV.

- 1 Connect the cables as necessary.

To connect an additional equipment, see the **External equipment Connections** section.

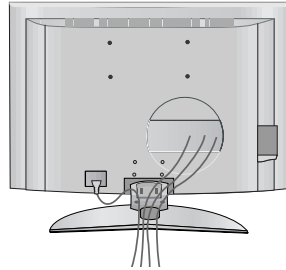

- 2 Install the **CABLE MANAGEMENT** as shown. (Insert it as pushing the loops on the both sides of the cable management.)

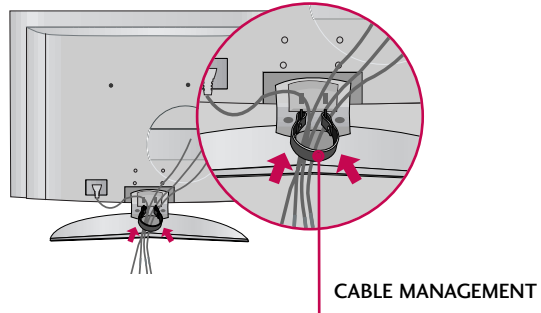

- 3 Bundle the cables using the supplied twist holder.

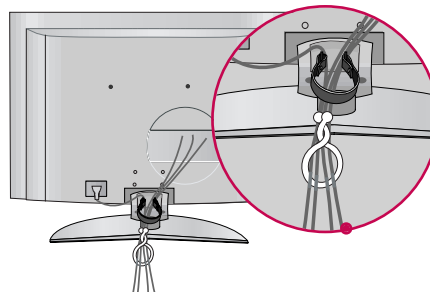

How to remove the cable management

Hold the **CABLE MANAGEMENT** with both hands and pull it out.

(Pull it out as holding the loops on the both sides of the cable management.)

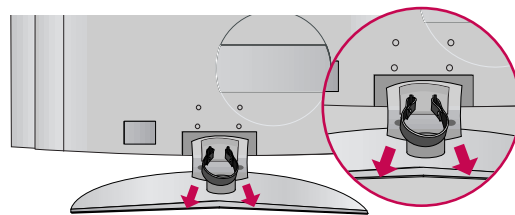

! NOTE

- ▶ Do not hold the **CABLE MANAGEMENT** when moving the product.
- If the product is dropped, you may be injured or the product may be broken.

PREPARATION

DESKTOP PEDESTAL INSTALLATION

For proper ventilation, allow a clearance of 4 inches on all four sides from the wall.

PREPARATION

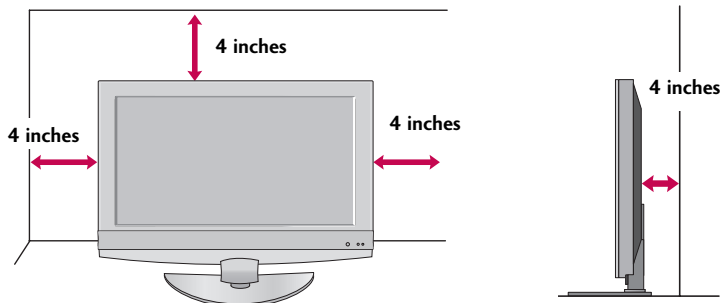

VESA WALL MOUNTING

This product accepts a VESA-compliant mounting interface pad. (optional)
There 4 threaded holes are available for attaching the bracket.

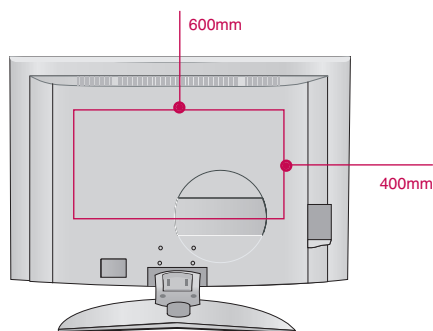

! NOTE

- Screw length needed depends on the wall mount used. For further information, refer to the VESA Wall Mounting Instruction Guide.

ANTENNA OR CABLE CONNECTION

1. Antenna (analog or digital)

Wall Antenna Socket or Outdoor Antenna without a Cable Box Connections. For optimum picture quality, adjust antenna direction if needed.

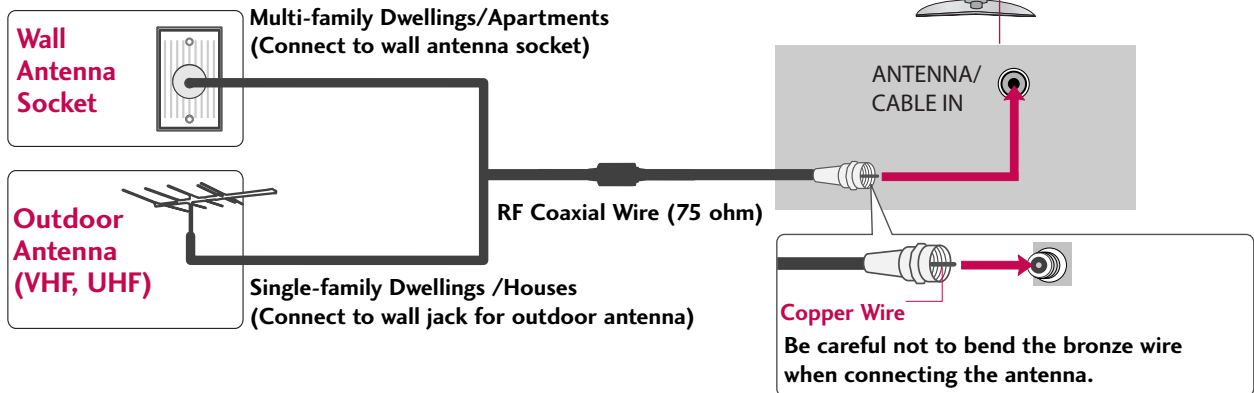

2. Cable

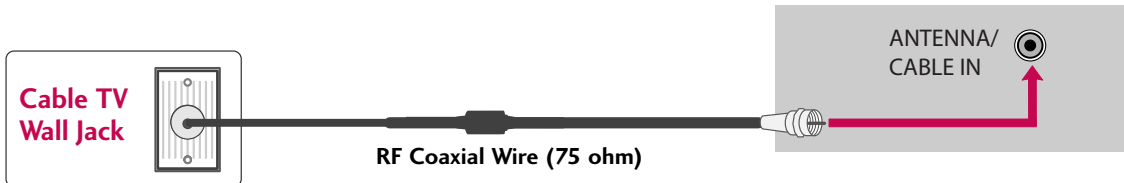

3. Using both cable and antenna

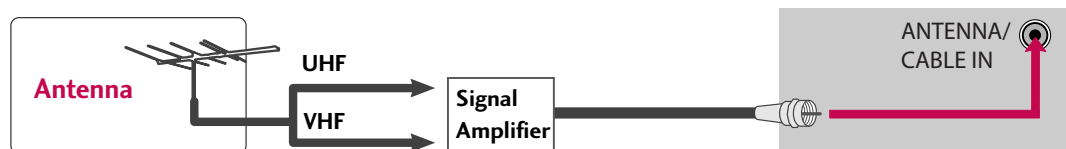
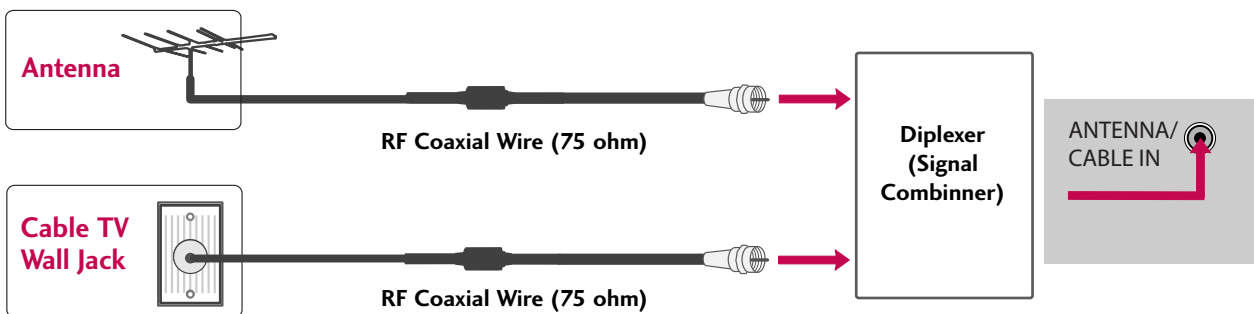

- To improve the picture quality in a poor signal area, please purchase a signal amplifier and install properly.
- If the antenna needs to be split for two TV's, install a 2-Way Signal Splitter.
- If the antenna is not installed properly, contact your dealer for assistance.

NOTE ▶ The TV will let you know when the analog, cable, and digital channel scans are complete.

EXTERNAL EQUIPMENT SETUP

HD RECEIVER SETUP

This TV can receive Digital Over-the-air/Cable signals without an external digital set-top box. However, if you do receive digital signals from a digital set-top box or other digital external device, refer to the figure as shown below.

This TV supports HDCP (High-bandwidth Digital Contents Protection) protocol for Digital Contents.

When connecting Component cable

1. How to connect

- 1 Connect the video outputs (Y, PB, PR) of the digital set top box to the **COMPONENT IN VIDEO 1** jacks on the set. Match the jack colors (Y = green, PB = blue, and PR = red).
- 2 Connect the audio output of the digital set-top box to the **COMPONENT IN AUDIO 1** jacks on the set.

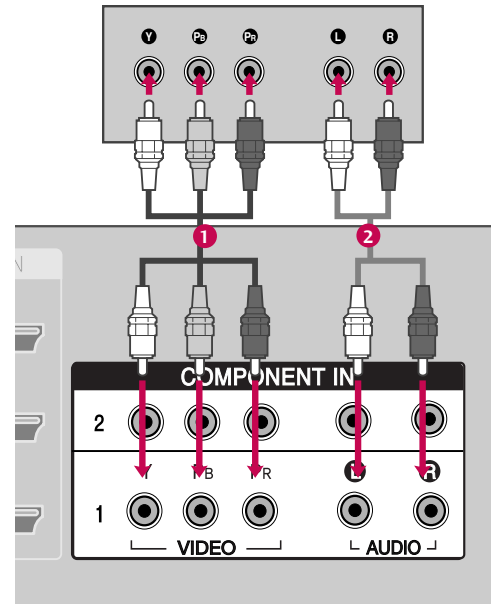

2. How to use

- Turn on the digital set-top box.
(Refer to the owner's manual for the digital set-top box.)
- Select **Component 1** input source with using the **INPUT** button on the remote control.
- If connected to **COMPONENT IN 2** input, select **Component 2** input source.

Signal	Component 1/2	HDMI/DVI1, 2 or 3
480i	Yes	No
480p	Yes	Yes
720p	Yes	Yes
1080i	Yes	Yes
1080p	Yes	Yes

Supported Display Specifications (Y, C_B/P_B, C_R/P_R)

Resolution	Horizontal Frequency(KHz)	Vertical Frequency(Hz)
720x480	15.73	60.00
	15.73	59.94
	31.47	59.94
	31.47	60.00
1280x720	45.00	60.00
	44.96	59.94
1920x1080	33.75	60.00
	33.72	59.94
	67.50	60.00
	67.432	59.939
	27.00	24.00
	26.97	23.94
	33.75	30.00
	33.71	29.97

When connecting HDMI cable

1. How to connect

- 1 Connect the digital set-top box to **HDMI/DVI IN1, 2 or 3** jack on the set.
- 2 No separated audio connection is necessary.

2. How to use

- Turn on the digital set-top box.
(Refer to the owner's manual for the digital set-top box.)
- Select **HDMI1, HDMI2 or HDMI3** input source with using the **INPUT** button on the remote control.
- If the digital set-top box player does not support Auto HDMI, you need to set the output resolution appropriately.

Supported Display Specifications (HDMI-DTV)

Resolution	Horizontal Frequency(KHz)	Vertical Frequency(Hz)
720x480	31.47	60.00
	31.47	59.94
1280x720	45.00	60.00
	44.96	59.94
1920x1080	33.75	60.00
	33.72	59.94
	67.50	60.00
	67.432	59.939
	27.00	24.00
	26.97	23.94
	33.75	30.00
33.71	29.97	

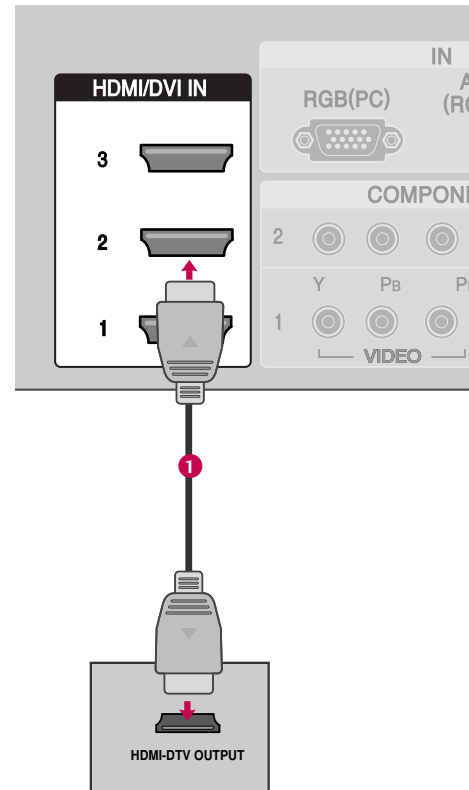

EXTERNAL EQUIPMENT SETUP

When connecting HDMI to DVI cable

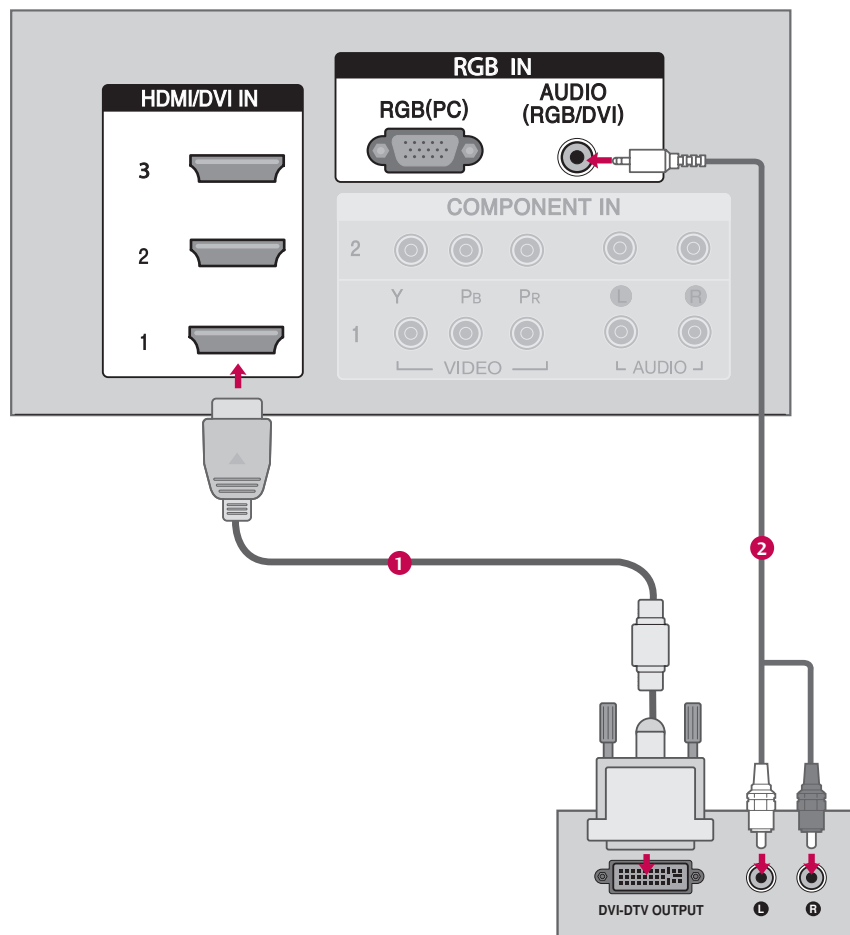

1. How to connect

- 1 Connect the DVI output of the digital set-top box to the **HDMI/DVI IN1, 2 or 3** jack on the set.
- 2 Connect the audio output of the digital set-top box to the **AUDIO(RGB/DVI)** jack on the set.

2. How to use

- Turn on the digital set-top box. (Refer to the owner's manual for the digital set-top box.)
- Select **HDMI1, HDMI2** or **HDMI3** input source with using the **INPUT** button on the remote control.

DVD SETUP

When connecting Component cable

1. How to connect

- 1 Connect the video outputs (Y, PB, PR) of the DVD to the **COMPONENT IN VIDEO1** jacks on the set. Match the jack colors (Y = green, PB = blue, and PR = red).
- 2 Connect the audio outputs of the DVD to the **COMPONENT IN AUDIO1** jacks on the set.

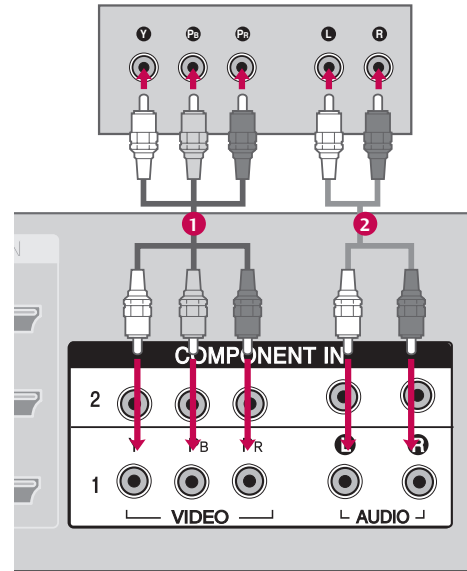

2. How to use

- Turn on the DVD player, insert a DVD.
- Select **Component 1** input source with using the **INPUT** button on the remote control.
- If connected to **COMPONENT IN 2** input, select **Component 2** input source.
- Refer to the DVD player's manual for operating instructions.

Component Input ports

To get better picture quality, connect a DVD player to the component input ports as shown below.

Component ports on the TV	Y	P _B	P _R
Video output ports on DVD player	Y	P _B	P _R
	Y	P _b	P _r
	Y	B-Y	R-Y
	Y	C _b	C _r

EXTERNAL EQUIPMENT SETUP

When connecting with an S-Video cable

1. How to connect

- 1 Connect the S-VIDEO output of the DVD to the S-VIDEO input on the set.
- 2 Connect the audio outputs of the DVD to the AUDIO input jacks on the set.

2. How to use

- Turn on the DVD player, insert a DVD.
- Select **AV1** input source with using the **INPUT** button on the remote control.
- If connected to **AV IN 2**, select **AV2** input source.
- Refer to the DVD player's manual for operating instructions.

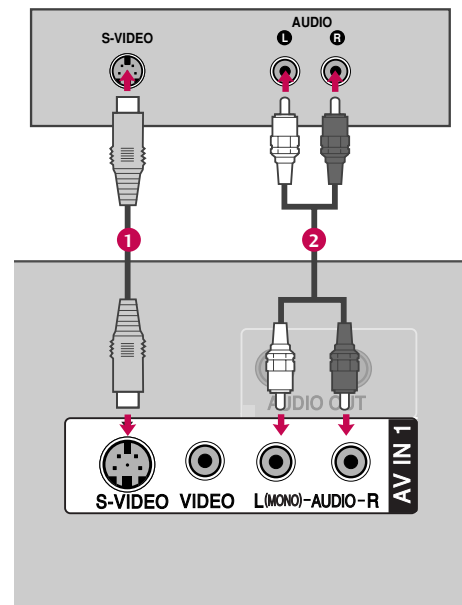

When connecting HDMI cable

1. How to connect

- 1 Connect the HDMI output of the DVD to the HDMI/DVI IN1, 2 or 3 jack on the set.
- 2 No separated audio connection is necessary.

2. How to use

- Select **HDMI1**, **HDMI2** or **HDMI3** input source with using the **INPUT** button on the remote control.
- Refer to the DVD player's manual for operating instructions.
- If the DVD does not support Auto HDMI, you need to set the output resolution appropriately.

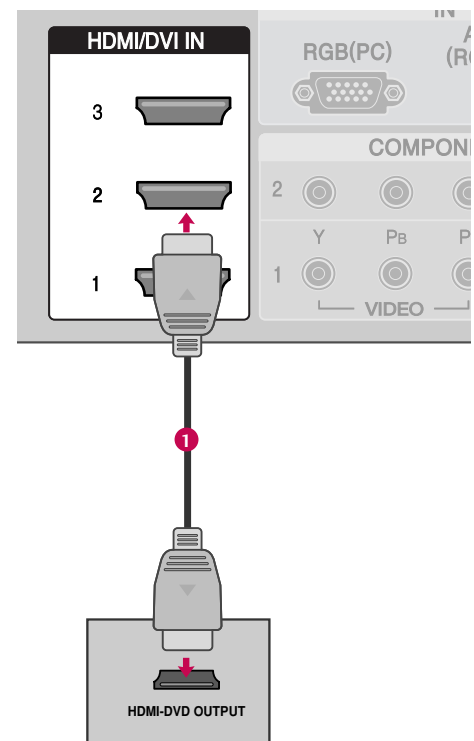

VCR SETUP

- To avoid picture noise (interference), leave an adequate distance between the VCR and TV
- If the 4:3 picture format is used; the fixed images on the sides of the screen may remain visible on the screen.

When connecting with an antenna

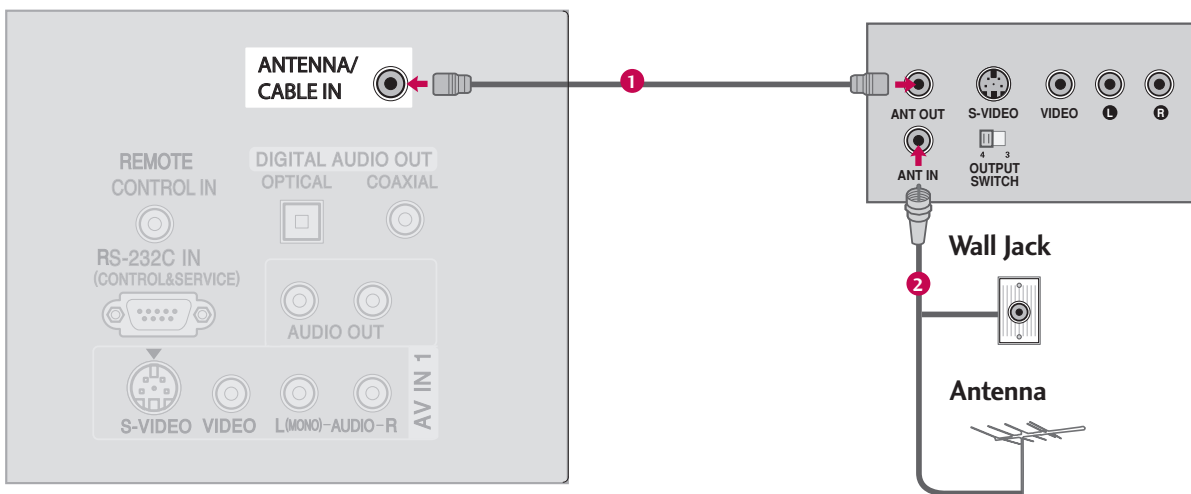

1. How to connect

- 1 Connect the RF antenna out socket of the VCR to the **Antenna** socket on the set.
- 2 Connect the antenna cable to the RF antenna in socket of the VCR.

2. How to use

- Set VCR output switch to 3 or 4 and then tune TV to the same channel number.
- Insert a video tape into the VCR and press PLAY on the VCR. (Refer to the VCR owner's manual.)

EXTERNAL EQUIPMENT SETUP

When connecting with a RCA cable

1. How to connect

- 1 Connect the **AUDIO/VIDEO** jacks between TV and VCR. Match the jack colors (Video = yellow, Audio Left = white, and Audio Right = red)

2. How to use

- Insert a video tape into the VCR and press **PLAY** on the VCR. (Refer to the VCR owner's manual.)
- Select **AV1** input source with using the **INPUT** button on the remote control.
- If connected to **AV IN 2**, select **AV2** input source.

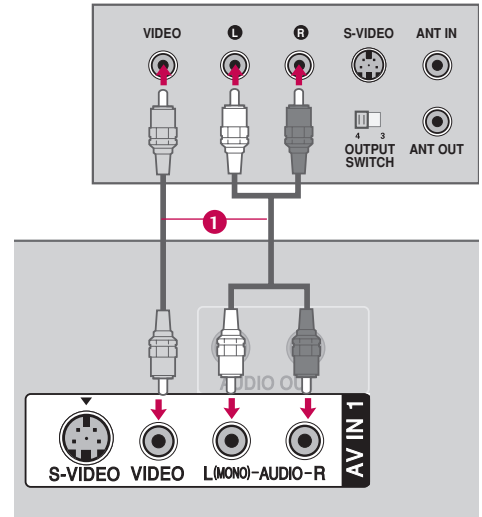

NOTE

- ▶ If you have a mono VCR, connect the audio cable from the VCR to the **AUDIO L/MONO** jack of the set.

When connecting with an S-Video cable

1. How to connect

- 1 Connect the **S-VIDEO** output of the VCR to the **S-VIDEO** input on the set. The picture quality is improved; compared to normal composite (RCA cable) input.
- 2 Connect the audio outputs of the VCR to the **AUDIO** input jacks on the set.

2. How to use

- Insert a video tape into the VCR and press **PLAY** on the VCR. (Refer to the VCR owner's manual.)
- Select **AV1** input source with using the **INPUT** button on the remote control.
- If connected to **AV IN 2**, select **AV2** input source.

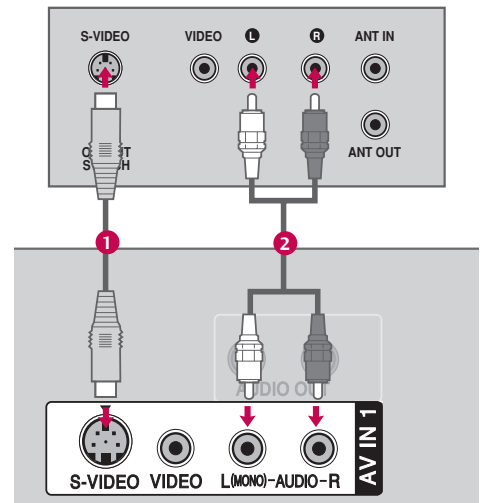

CAUTION

- ▶ In the event that you connect both Video and the S-Video cables, only the S-Video will work.

PC SETUP

This TV provides Plug and Play capability, meaning that the PC adjusts automatically to the TV's settings.

When connecting D-sub 15 pin cable

1. How to connect

- 1 Connect the RGB output of the PC to the **RGB (PC)** jack on the set.
- 2 Connect the PC audio output to the **AUDIO (RGB/DVI)** jack on the set.

2. How to use

- Turn on the PC and the set.
- Select **RGB-PC** input source with using the **INPUT** button on the remote control.

! NOTE

- ▶ Check the image on your TV. There may be noise associated with the resolution, vertical pattern, contrast or brightness in PC mode. If noise is present, change the PC output to another resolution, change the refresh rate to another rate or adjust the brightness and contrast on the VIDEO menu until the picture is clear. If the refresh rate of the PC graphic card can not be changed, change the PC graphic card or consult the manufacturer of the PC graphic card.

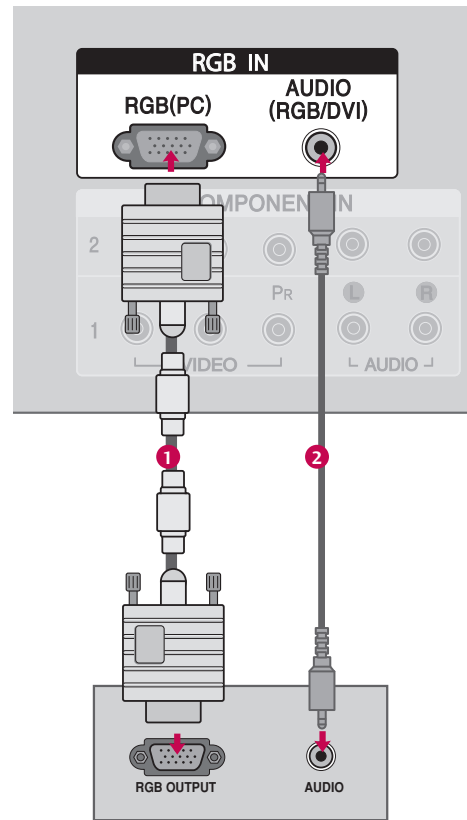

EXTERNAL EQUIPMENT SETUP

When connecting HDMI to DVI cable

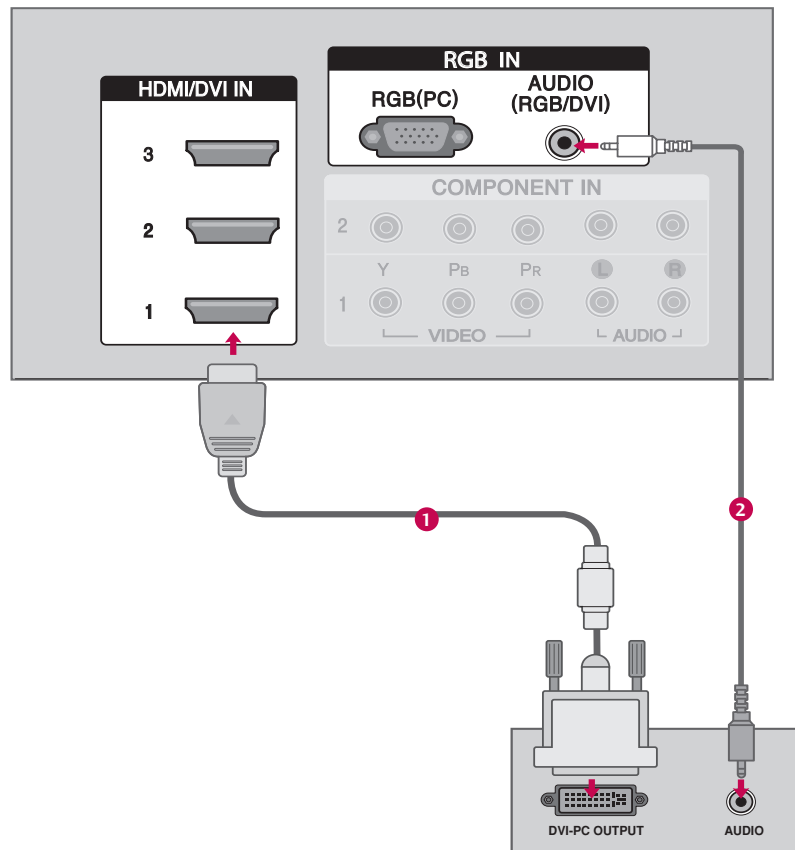

1. How to connect

- 1 Connect the DVI output of the PC to the **HDMI/DVI IN1**, **2** or **3** jack on the set.
(Use the HDMI to DVI cable)
- 2 Connect the PC audio output to the **AUDIO(RGB/DVI)** jack on the set.

2. How to use

- Turn on the PC and the set
- Select **HDMI1**, **HDMI2** or **HDMI3** input source with using the **INPUT** button on the remote control.

! NOTE

- ▶ If the PC has a DVI output and no HDMI output, a separated audio connection is necessary.
- ▶ If the PC does not support Auto DVI, you need to set the output resolution appropriately. To get the best picture quality, adjust the output resolution of PC graphics card's output resolution to 1920x1080, 60Hz.

! NOTES

- ▶ Depending on the graphics card, DOS mode may not work if a HDMI to DVI Cable is in use.
- ▶ Check the image on your TV. There may be noise associated with the resolution, vertical pattern, contrast or brightness in PC mode. If noise is present, change the PC output to another resolution, change the refresh rate to another rate or adjust the brightness and contrast on the PICTURE menu until the picture is clear. If the refresh rate of the PC graphic card can not be changed, change the PC graphic card or consult the manufacturer of the PC graphic card.
- ▶ Avoid keeping a fixed image on the screen for a long period of time. The fixed image may become permanently imprinted on the screen.
- ▶ The synchronization input form for Horizontal and Vertical frequencies is separate.

Supported Display Specifications (RGB/HDMI-PC)

Resolution	Horizontal Frequency(KHz)	Vertical Frequency(Hz)
640x350	31.468	70.09
720x400	31.469	70.08
640x480	31.469	59.94
	37.861	72.80
	37.500	75.00
800x600	35.156	56.25
	37.879	60.31
	48.077	72.18
	46.875	75.00
1024x768	48.363	60.00
	56.476	70.06
	60.023	75.02
1280x768	47.776	59.870
1280x768	60.289	74.893
1360x768	47.712	60.015
1280x1024	63.981	60.020
	79.976	75.025
1600x1200	75.00	60.00
1920x1080	67.50	60.00

* RGB-PC mode only: 1280x768(H-60.289, V-74.893)

EXTERNAL EQUIPMENT SETUP

Screen Setup for PC mode

Overview

When the RGB input, of the set is connected to a PC Output, Select RGB-PC with using the **INPUT** button on the remote control.

When you change the resolution, select the proper resolution in present input to see the best picture appearance.

1 Press the **MENU** button and then use ▲ or ▼ button to select the **PICTURE** menu.

2 Press the ► button and then use ▲ or ▼ button to select **Screen**.

3 Press the ► button to enter the screen adjustment menu.

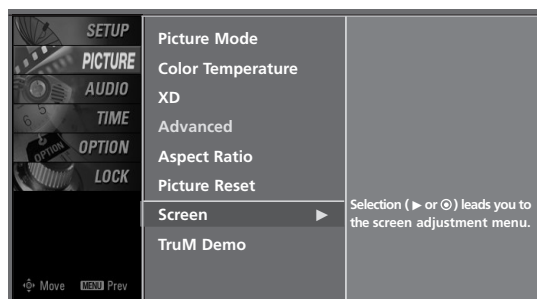
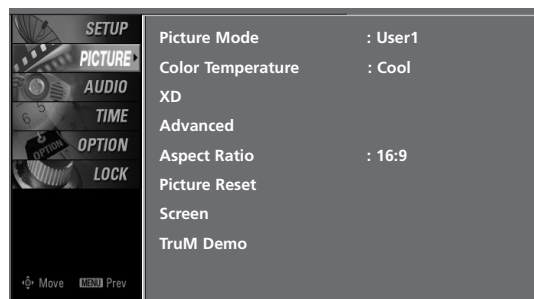

Adjustment for screen Resolution, Position, Size, Phase, Reset

- 1 Use ▲ or ▼ button to select **Resolution**, **Position**, **Size**, or **Phase**.

- 2 Press the **ENTER** button and then use ▲ / ▼ or ◀ / ▶ button to make appropriate adjustments.
 - The **Phase** adjustment range is -16 ~ +16.
 - The **Size** adjustment range is -30 ~ +30.

- 3 Press the **ENTER** button.

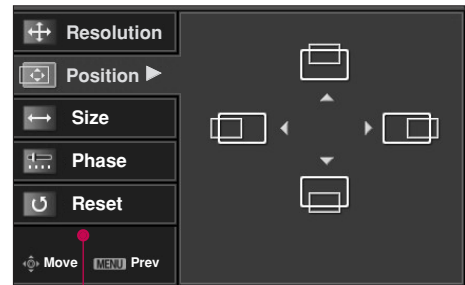

1 2 3

Resolution XGA (1024, 1280, 1360) isn't distinguished because of having the same H/V Sync Time. This function is you to select the Default Sync Time.

Position This function is to adjust picture to left/right and up/down as you prefer.

Size This function is to minimize any vertical bars or stripes visible on the screen background. And the horizontal screen size will also change.

Phase This function allows you to remove any horizontal noise and clear or sharpen the image of characters.

Initializing (Reset to original factory values)

To initialize the adjusted values.

- 1 Use ▲ or ▼ button to select **Reset**.

- 2 Press the **ENTER** button and then use ◀ or ▶ button to select **Yes**.

- 3 Press the **ENTER** button.

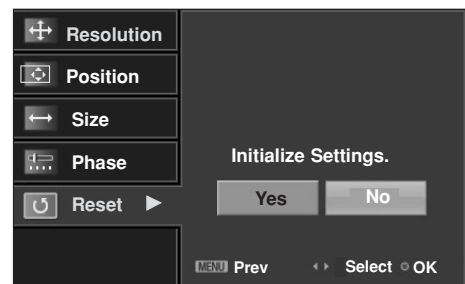

1 2 3

EXTERNAL EQUIPMENT SETUP

OTHER A/V SOURCE SETUP

1. How to connect

- 1 Connect the **AUDIO/VIDEO** jacks between TV and external equipment. Match the jack colors. (Video = yellow, Audio Left = white, and Audio Right = red)

2. How to use

- Select **AV2** input source with using the **INPUT** button on the remote control.
- If connected to **AV IN 1** input, select **AV1** input source.
- Operate the corresponding external equipment.

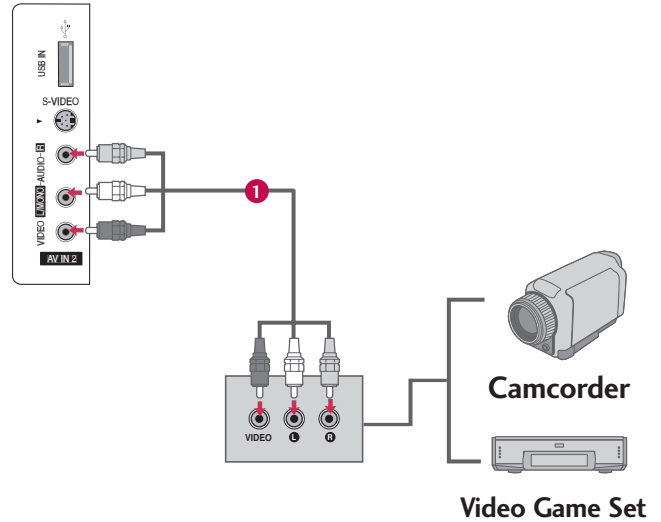

USB IN SETUP

The TV has a special signal output capability which allows you to hook up the second TV or monitor.

1. How to connect

- 1 Connect the USB device to the **USB IN** jacks on the side of TV.

2. How to use

- After connecting the **USB IN** jacks, you use the **MEDIAHOST** function. (▶ p.39)

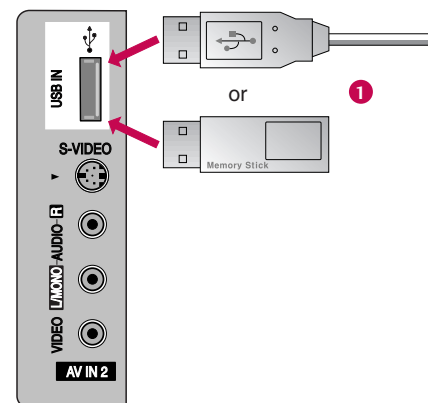

AUDIO OUT SETUP

Send the TV's audio to external audio equipment via the Audio Output port.

1. How to connect

Analog

- 1 Connect audio outputs to the TV's **AUDIO OUT** jacks.
- 2 Set the "TV Speaker option - Off" in the AUDIO menu. (▶ p.62). See the external audio equipment instruction manual for operation.

Digital

- 1 Connect one end of the optical or coaxial cable to the TV's **OPTICAL** or **COAXIAL** port of **DIGITAL AUDIO OUT**.
- 2 Connect the other end of the optical or coaxial cable to the digital audio input on the audio equipment.
- 3 Set the "TV Speaker option - Off" in the AUDIO menu. (▶ p.62). See the external audio equipment instruction manual for operation.

NOTE

- ▶ When connecting with external audio equipment, such as amplifiers or speakers, please turn the TV speakers off. (▶ p.62)

CAUTION

- ▶ Do not look into the optical output port. Looking at the laser beam may damage your vision.
- ▶ Block the SPDIF out(optical/coaxial) about the contents with ACP(Audio Copy Protection) function.

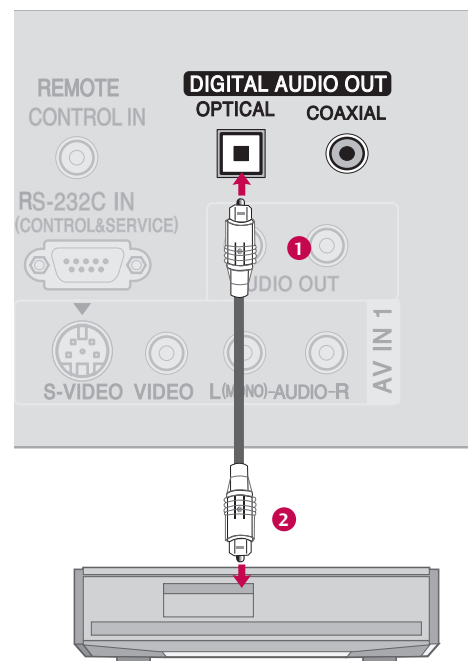
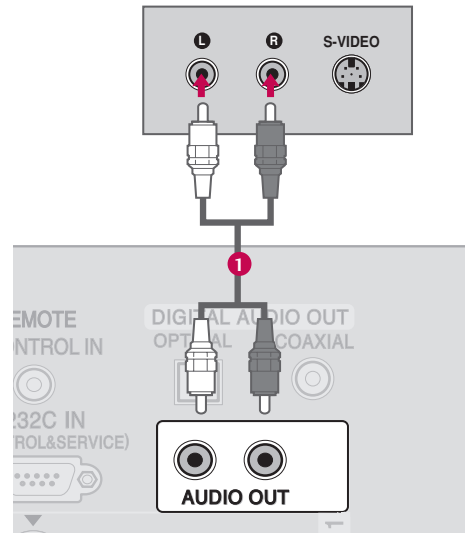

WATCHING TV / CHANNEL CONTROL

REMOTE CONTROL FUNCTIONS

When using the remote control, aim it at the remote control sensor on the TV.

MEDIAhost mode control buttons ■ Controls the *MEDIAhost* mode.

VCR/DVD buttons ■ Control video cassette recorders or DVD players.

MENU Displays the main menu.

■ Adjust brightness on screen.

BRIGHT +/- ■ It turns to the default settings brightness by changing mode source.

THUMBSTICK (Up/Down/Left Right/ENTER) ■ Navigate the on-screen menus and adjust the system settings to your preference.

EXIT Clear all on-screen displays and return to TV viewing from any menu.

TIMER Select the amount of time before your TV turns off automatically. ▶ p.72

RATIO Change the aspect ratio. ▶ p.46

SIMPLINK See a list of AV devices connected to TV. When you toggle this button, the SimpLink menu appears at the screen.

VOLUME UP /DOWN Increase/decrease the sound level.

MUTE Switch the sound on or off. ▶ p.30

FAV Scroll through the programmed Favorite channels. ▶ p.34

CHANNEL UP/DOWN Select available channels.

NUMBER button

BACK Tune to the last channel viewed.

— (DASH) Used to enter a program number for multiple program channels such as 2-1, 2-2, etc.

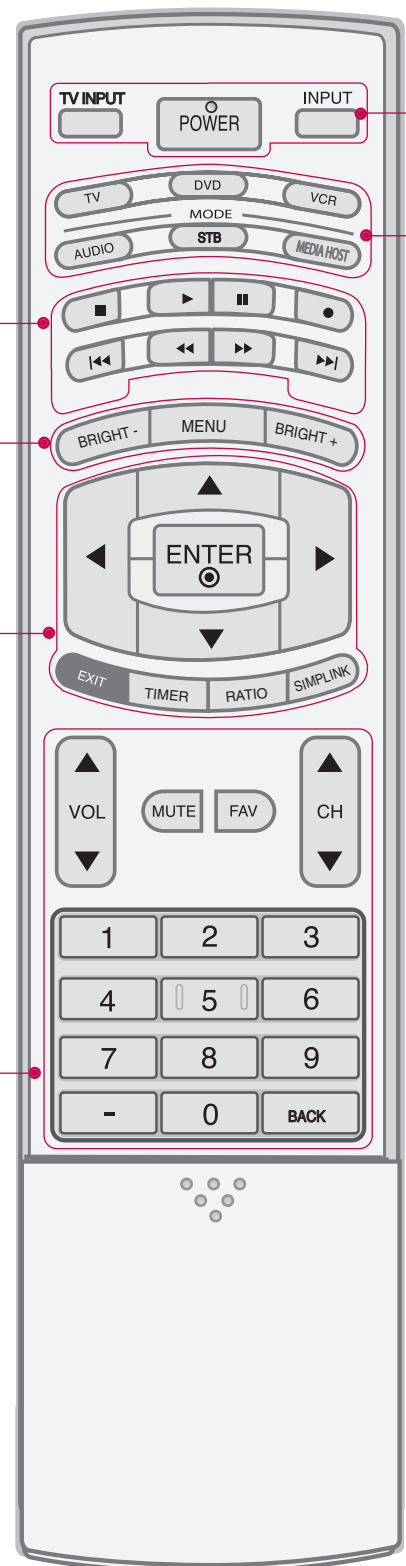

POWER Turns your TV or any other programmed equipment on or off, depending on the mode.

TV INPUT In AV 1-2, Component 1-2, RGB-PC, HDMI1, HDMI2 and HDMI3 input sources, screen returns to the last TV channel.

INPUT External input modes rotate in regular sequence: Antenna, Cable, AV1-2, Component 1-2, RGB-PC, HDMI1, HDMI2, HDMI3 (Antenna, Cable, AV 1-2, Component 1-2, RGB-PC, HDMI1, HDMI2, HDMI3 input sources are linked automatically, only if these are connected).

MODE Select the remote operating mode: TV, DVD, VCR, AUDIO, CABLE or STB.
* If the mode of another product is selected, a button on the remote control which is not used for the selected product can control the TV.

MEDIAHOST Enter to the *MEDIAHOST* mode.

Inside the Sliding Cover

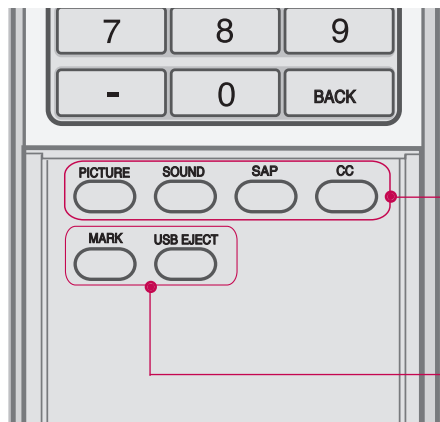

PICTURE Adjust the factory preset picture depend on the viewing environment. ▶ p. 47

SOUND Select the appropriate type of sound for type of program. ▶ p. 58

SAP Select MTS sound: Mono, Stereo, and SAP analog mode. Change the audio language DTV mode. ▶ p. 61

CC Select the Caption On/Off. ▶ p.65

MARK Enter the selected functions. ▶ p.41

USB EJECT Remove the USB device. ▶ p.39

Installing Batteries

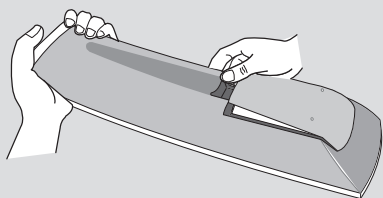

- Open the battery compartment cover on the back side and install the batteries matching correct polarity (+with +,-with -).
- Install two 1.5V AA batteries. Don't mix old or used batteries with new ones.
- Close cover.

Remote control effective range

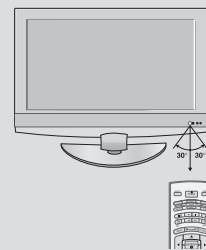

- Use a remote control up to 7 meters distance and 30 degree (left/right) within the receiving unit scope.
- Dispose of used batteries in a recycle bin to preserve environment.

WATCHING TV /CHANNEL CONTROL

TURNING ON TV

- 1** First, connect power cord correctly. At this moment, the TV switches to standby mode.
 - In standby mode, press the **⏻/I** (or ON/OFF), **INPUT**, **CH (▲ or ▼)** button on the TV or press the **POWER**, **INPUT**, **TV INPUT**, **CH(▲ or ▼)**, **Number (0~9)** button on the remote control.
- 2** Select the viewing source by using the **INPUT** button on the remote control.
 - This TV is programmed to remember which mode it was last set to, even if you turn the TV off.
- 3** When finished using the TV, press the **POWER** button on the remote control. The TV reverts to standby mode.



NOTE

- ▶ If you intend to be away on vacation, disconnect the power plug from the wall power outlet.

CHANNEL SELECTION

- 1** Press the **CH (▲ or ▼)** or **NUMBER** buttons to select a channel number.



VOLUME ADJUSTMENT

Adjust the volume to suit your personal preference.

- 1** Press the **VOL (▲ or ▼)** button to adjust the volume.
- 2** If you want to switch the sound off, press the **MUTE** button.
- 3** You can cancel the Mute function by pressing the **MUTE** or **VOL (▲ or ▼)** button.



ON-SCREEN MENUS SELECTION

Your TV's OSD (On Screen Display) may differ slightly from what is shown in this manual.

- 1 Press the **MENU** button and then use **▲** or **▼** button to select each menu.
- 2 Press the **▶** button and then use **▲ ▼ ◀ ▶** button to display the available menus.

SETUP

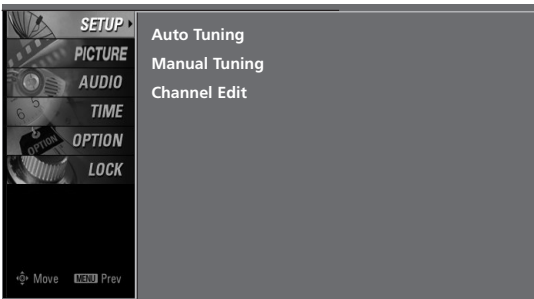

PICTURE

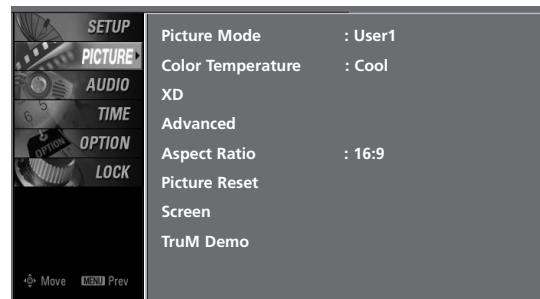

LOCK

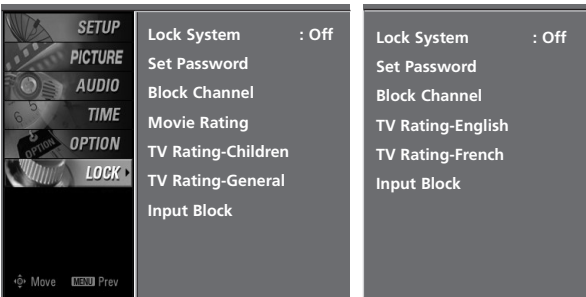

AUDIO

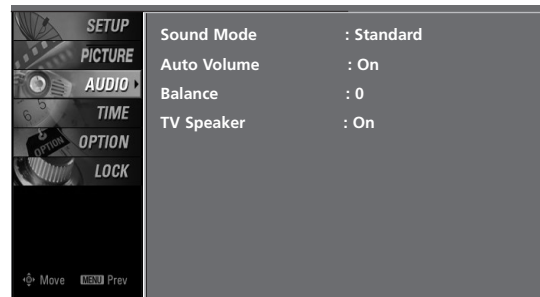

OPTION

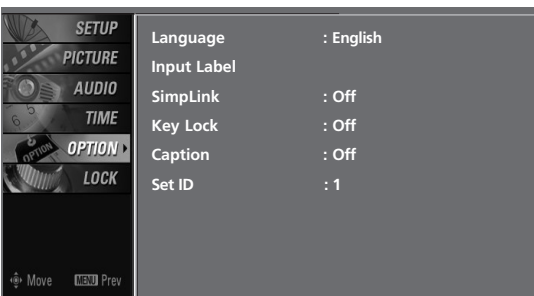

TIME

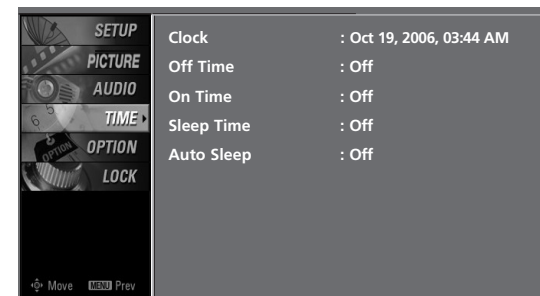

WATCHING TV /CHANNEL CONTROL

CHANNEL SETUP

Auto Scan (Auto Tuning)

Automatically finds all channels available through antenna or cable inputs, and stores them in memory on the channel list.

Run Auto Tuning again after any Antenna/Cable connection changes.

A password is required to gain access to Auto Tuning menu if the Lock System is turned on.

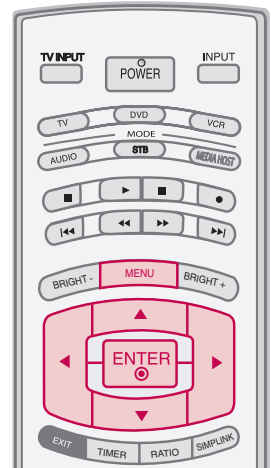

1 Press the **MENU** button and then use **▲** or **▼** button to select the **SETUP** menu.

2 Press the **▶** button and then use **▲** or **▼** button to select **Auto Tuning**.

3 Press the **ENTER** button to begin the channel search. Allow **Auto Tuning** to complete the channel search cycle for **ANTENNA** and **CABLE**.

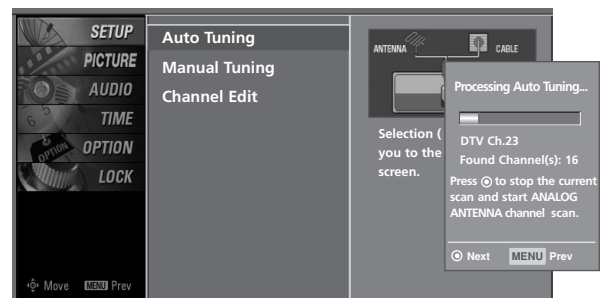
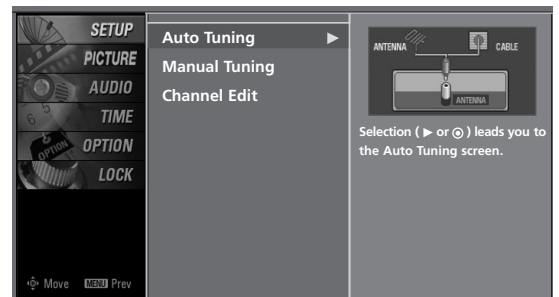
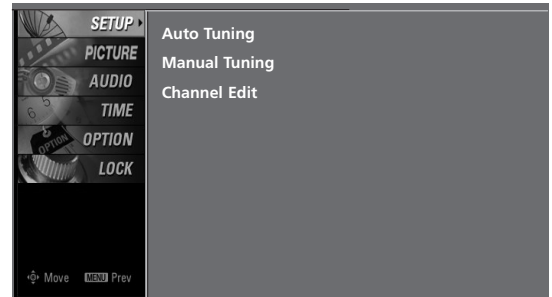

NOTE



Analog TV antenna
Digital DTV antenna
Analog CATV cable
Digital CADTV cable

Add/Delete Channel (Manual Tuning)

A password is required to gain access to Manual Tuning menu if the Lock System is turned on.

If selecting DTV or CADTV input signal, you can view the on-screen signal strength monitor to see the quality of the signal being received.

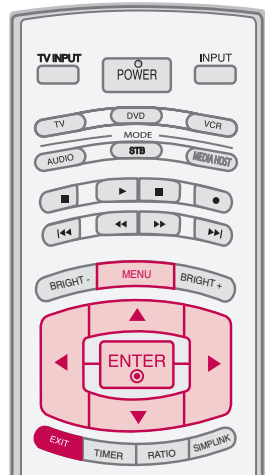

1 Press the **MENU** button and then use ▲ or ▼ button to select the **SETUP** menu.

2 Press the ► button and then use ▲ or ▼ button to select **Manual Tuning**.

3 Press the ► button and then use ▲ or ▼ button to select DTV, TV, CADTV, and CATV.

4 Press the ► button and then use ▲ or ▼ button to select channel number you want to add or delete.

5 Press the **ENTER** button to add or delete for the channel number.

6 Press **EXIT** button to return to TV viewing or press **MENU** button to return to the previous menu.

! NOTE

- ▶ This digital channel number is a physical channel number, which is different from the normal channel number shown in Channel Edit.

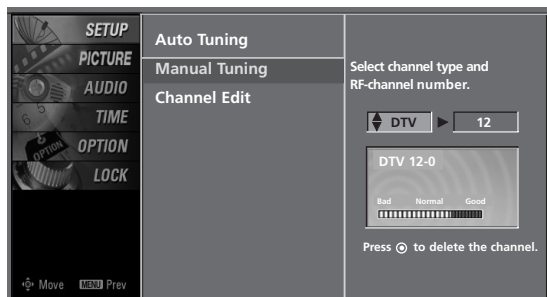
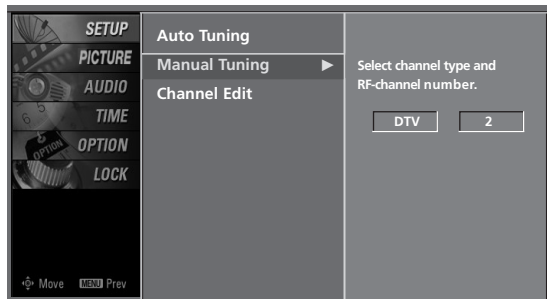
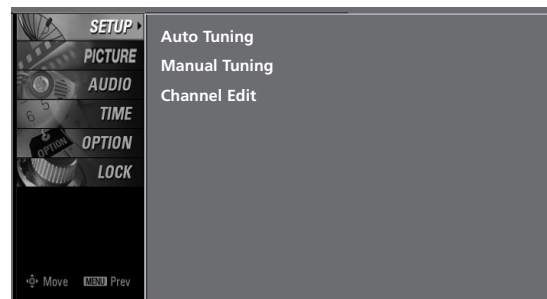

4 5

WATCHING TV / CHANNEL CONTROL

Channel Editing

From the default channel list created from the Auto Tuning channel search, you can create two different types of channel lists in memory: “custom list” and “favorite channel list”.

A custom list can be created by toggling each channel on or off with ENTER button. The channels in the Custom List are displayed in black and the channels deleted from the Custom List are displayed in gray. Once a channel is highlighted you can add or delete the channel by referring to the small window at the top-left corner of the screen.

You can create your own Favorite List. Use the **FAV** button on the remote control when a channel is highlighted and then add or delete the channel to/from your Favorite List.

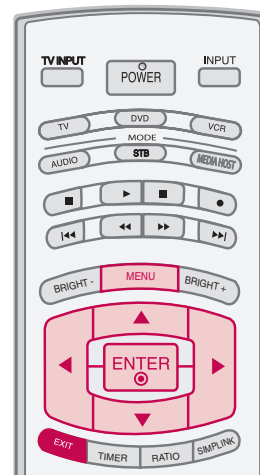

1 Press the **MENU** button and then use **▲** or **▼** button to select the **SETUP** menu.

2 Press the **▶** button and then use **▲** or **▼** button to select **Channel Edit**.

3 Press the **▶** button. You will now see a screen filled with channel numbers and a preview picture.

4 Use **▲ ▼ ◀ ▶** button to select a channel and then use the **ENTER** button to add or delete it. Press **FAV** button to add the channel to the Favorite List. The surfing icon will appear in front of that channel number.

5 Press **EXIT** button to return to TV viewing or press **MENU** button to return to the previous menu.

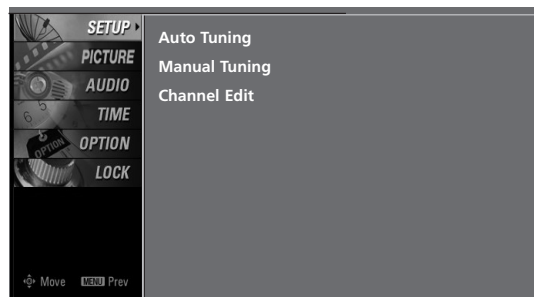

1

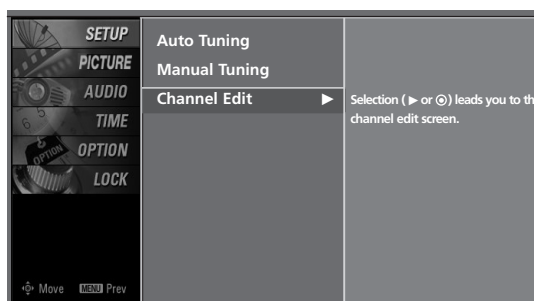

2



3 4

INPUT LIST

Press the **INPUT** button to display external device that is connected to the unit, on screen.

Press the **ENTER** button to change the input to the active external device. Use the **▲** or **▼** button to select the input source.

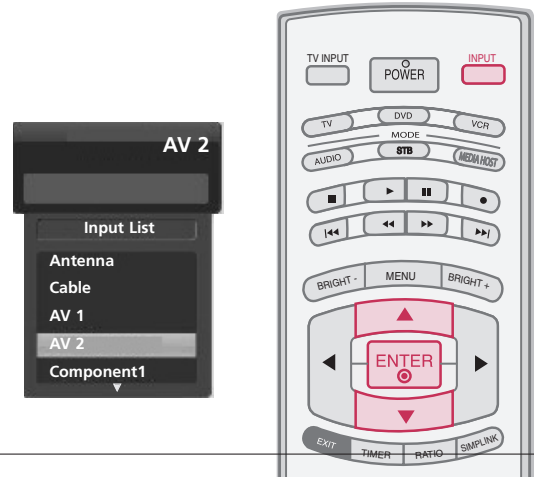

- 1** If all external input sources are connected:

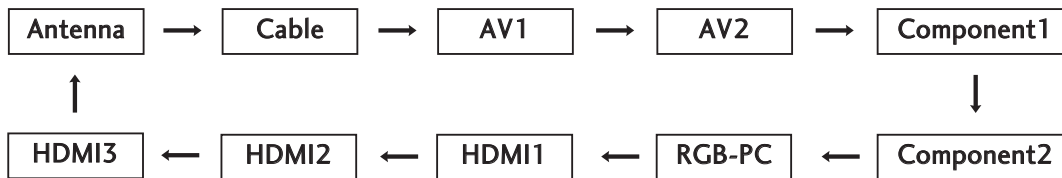

- 2** If no external input sources are not connected:



- 3** If there is any external input source connected:
(ex: When connected only to AV 2)

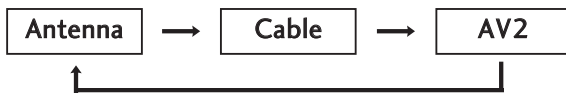

Antenna : Select it when watching the DTV/TV.

Cable: Select it when watching the CADTV/CATV.

AV 1, AV 2 : Select it when watching the VCR or external equipment.

Component 1-2 : Select it when using the DVD or the Digital set-top box depend on connector.

RGB-PC : Select it when using PC depend on connector.

HDMI, HDMI2, HDMI3 : Select it when using DVD, PC or Digital set-top box depend on connector.

WATCHING TV /CHANNEL CONTROL



This operates only for the devices with the logo. Please check the logo.

This allows you to control and play other AV devices connected to the display through HDMI cable without additional cables and settings.

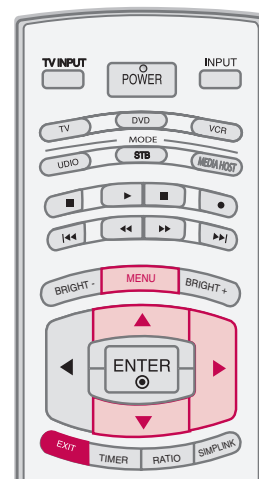

Simplink Preparations

- 1 Connect the HDMI/DVI IN 1, 2 or 3 terminal of the TV to the rear terminal (HDMI output) of the Simplink device with the HDMI cable.
After connecting the HDMI jack for the home theater with simplink function in the above method, connect the DIGITAL AUDIO OUT OPTICAL on the back of the TV to the DIGITAL AUDIO OUT terminal on the back of the simplink device with the Optical cable.

- 2 Press the **MENU** button and then use **▲** or **▼** button to select the **OPTION** menu.

- 3 Press the **▶** button and then use **▲** or **▼** button to select **Simplink**.

- 4 Press the **▶** button and then use **▲** or **▼** button to select **On**.

- 5 Press **EXIT** button to return to TV viewing or press **MENU** button to return to the previous menu.

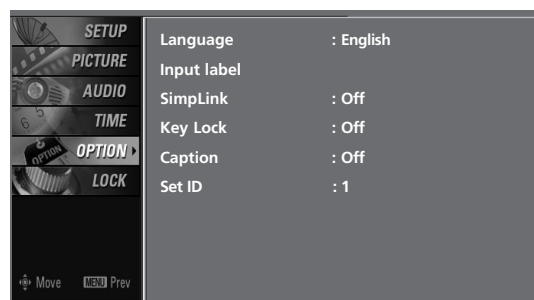

2

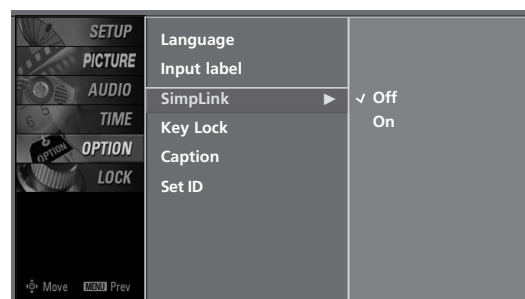

3 4 5

! NOTE

- ▶ When operating the external device with Simplink, press the TV button among the MODE button on the remote control.
- ▶ When you switch the Input source with the INPUT button on the remote control, you can stop the operation of device worked by Simplink.
- ▶ When you select or operate the media device with home theater function, the speaker automatically switches to home theater speaker (HT speaker).
- ▶ When you execute 'Photo List, Music List' function during DVD playback included in home theater supported the Simplink stops and the applicable function is executed after switching the input to TV.

SimpLink Functions







Direct Play

After connecting AV devices to TV, you can directly control the devices and play media without additional settings.

Select AV device

Enables you to select one of AV devices connected to TV and play it.

Disc playback

Control connected AV devices by pressing the , , , , , , , **ENTER** buttons and buttons for play, pause, stop, fast reverse, fast forward, chapter skip.

Power off all devices



When you power off TV, all connected devices are turned off.

Switch audio-out

Offers an easy way to switch audio-out.

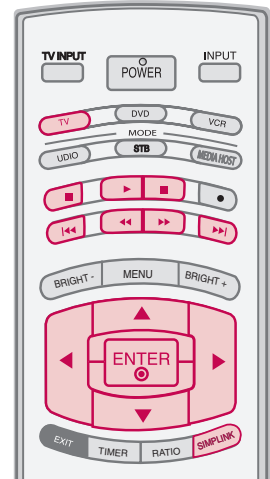
(A device, which is connected to TV through HDMI cable but does not support Simplink, does not provide this function)



- 1 After selecting the **TV** button of the MODE on the remote control, press the **SIMPLINK** button.
- 2 Use  button to select the desired device and then press the **ENTER** button.
- 3 Control connected AV devices by pressing the  buttons.

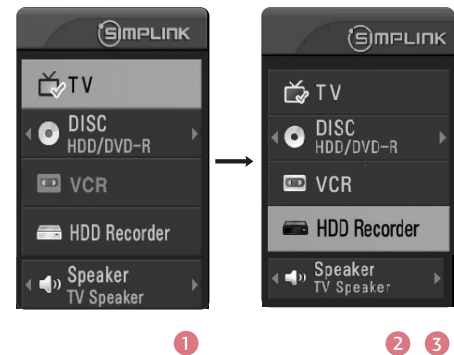

SimpLink Menu

- 1 **TV viewing** : Switch to the previous TV channel regardless of the current mode.
- 2 **DISC playback** : Select and play discs. When multiple discs are available, the titles of the discs are conveniently displayed at the bottom of the screen.
- 3 **VCR playback** : Play and control the connected VCR.
- 4 **HDD Recordings playback** : Play and control recordings stored in HDD.
- 5 **Audio Out to HT speaker/Audio Out to TV** : Select HT speaker or TV speaker for Audio Out.



WATCHING TV /CHANNEL CONTROL

INPUT LABEL

Sets a label to each input source which is not in use when you press **INPUT** button.

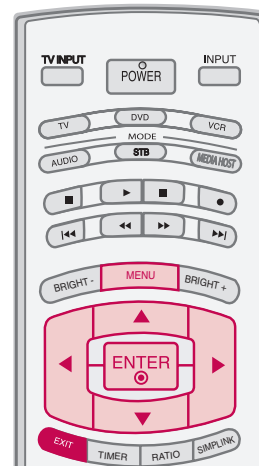

1 Press the **MENU** button and then use ▲ or ▼ button to select the **OPTION** menu.

2 Press the ► button and then use ▲ or ▼ button to select **Input Label**.

3 Press the ► button and then use ▲ or ▼ button to select the source: AV1, AV2, Component1, Component2, RGB-PC, HDMI1, HDMI2 or HDMI3.

4 Press the ◀ or ▶ button to select the label.

5 Press **EXIT** button to return to TV viewing or press **MENU** button to return to the previous menu.

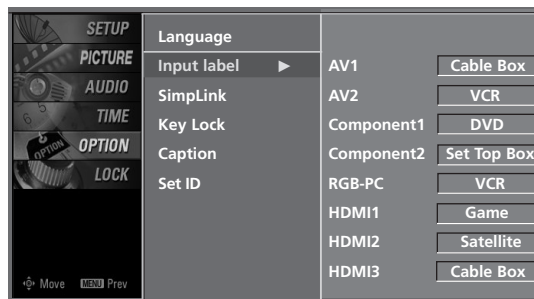
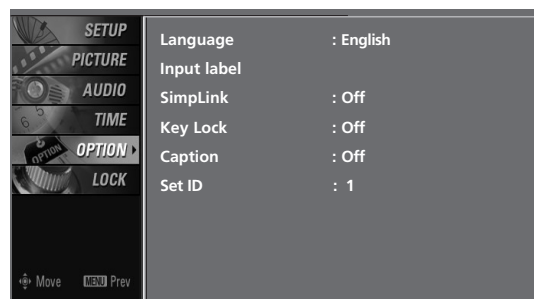

ENTRY MODES

When you connect a USB device or press the  button, this screen is displayed, automatically.

In USB device, you can not add a new folder or delete the existing folder.

- 1 Press the ▲ or ▼ button to select the desired item.
- 2 Press the **ENTER** button to move to **Photo List** or **Music List** of USB device.
- 3 Press the **USB EJECT** button of remote control before removing the USB device.

[Media Host Menu]

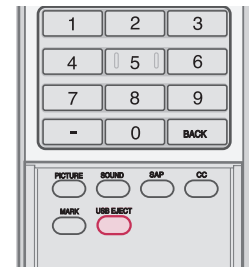

! NOTE

- ▶ Press the **USB EJECT** button of remote control before removing the USB device.
- ▶ Only a USB storage device is recognizable.
- ▶ If the USB storage device is connected through a USB hub, the device is not recognizable.
- ▶ A USB storage device using an automatic recognition program may not be recognized.
- ▶ A USB storage device which uses its own driver may not be recognized.
- ▶ In case of a card reader, up to four memory cards are concurrently recognizable.
- ▶ The recognition speed of a USB storage device may depend on each device.
- ▶ Please do not turn off the TV or unplug the USB device when the connected USB storage device is working. When such device is suddenly separated or unplugged, the stored files or the USB storage device may be damaged. To unplug the USB storage device, please press the **USB EJECT** button on the remote control, and then unplug it safely.
- ▶ Please do not connect the USB storage device which was artificially maneuvered on the PC. The device may cause the product to malfunction or fail to be played. Never forget to use only a USB storage device which has normal music files or image files.
- ▶ Please use only a USB storage device which was formatted as a FAT or a NTFS file system provided with the Windows operating system. In case of a storage device formatted as a different utility program which is not supported by Windows, it may not be recognized.
- ▶ In case of a hard disk drive (HDD) formatted as NTFS, writing and deletion are not allowable.
- ▶ Please connect power to a USB storage device which requires an external power supply. If not, the device may not be recognized.
- ▶ Please connect a USB storage device with cable is offered by USB maker. If connected with cable is not offered by USB maker or an excessively long cable, the device may not be recognized.
- ▶ Some USB storage devices may not be supported or operated smoothly.
- ▶ If the name of a folder or file is too long, it will not be displayed or recognized.

PHOTO LIST

It's available to playback the photo file(*.jpg) in the USB device.

The On Screen Display may be different from your set. Images are an example to assist with the TV operation.

Screen Components

- 1 Usable USB memory

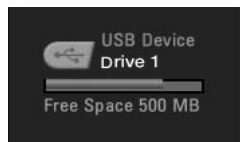

- 2 Current page/Total pages
- 3 Total number of marked thumbnail photos
- 4 Corresponding buttons on the remote control

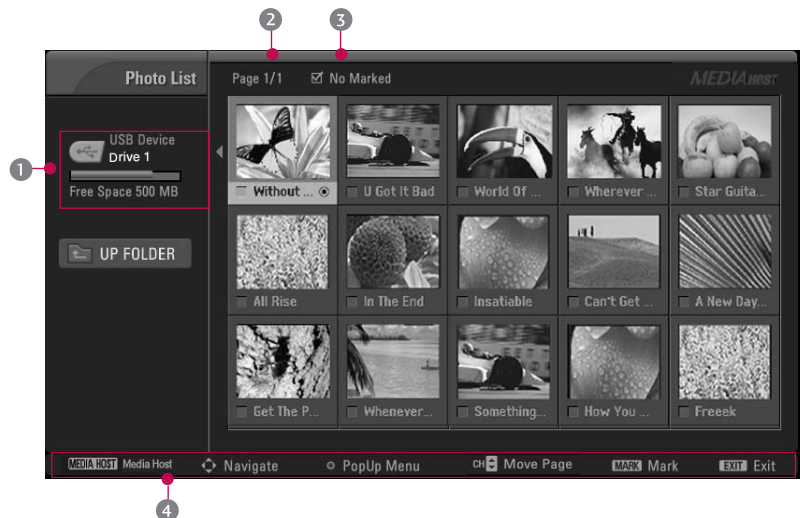

Photo Selection and PopUp Menu

As shown, up to 15 thumbnail photos are listed per page.

- 1 Use the **CH ▲** or **▼** button to navigate in the thumbnail photo page.
- 2 Use the **MARK** button to mark or unmark a photo. When one or more photos are marked, you can view individual photos or a slide show of the marked photos. If no photos are marked, you can view all photos individually or all photos in the folder in a slide show.
- 3 Use **▲ ▼ ◀ ▶** button to navigate the appropriate thumbnail photos, then press the **ENTER** button to show the PopUp menu.

- ▶ **View** : Display the selected item.
- ▶ **Mark All** : Mark all photos on the screen.
- ▶ **Delete** : Delete the selected photo item.
- ▶ **Cancel** : Close the pop-up menu.

- 4 Repeatedly, press **EXIT** button to return to TV viewing or press the **MEDIA HOST** button to return to the Media Host menu.



1 2

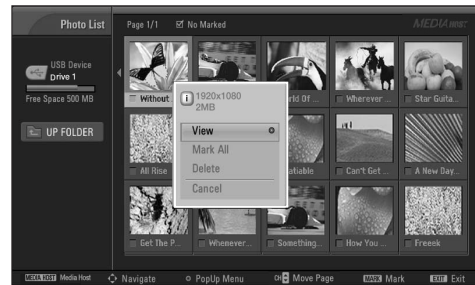

3

Set up the menu in Full-Sized Screen

You can change the settings to display photos stored on a USB device, on a full-sized screen.

Detailed operations are available on full-sized photo view screen.

- 1 Use the **CH ▲** or **▼** button to navigate the thumbnail photo page.
- 2 Use **▲ ▼ ◀ ▶** button to navigate the appropriate thumbnail photos, then press the **ENTER** button to show the PopUp menu.
- 3 Use **▲ ▼** button to Move to the **View** menu, then press the **ENTER** button.
- 4 The selected photo is displayed in full size.



- 1
- 2
- 3

- ▶ **Slide Show** : When no picture is selected, all photos in the current folder are displayed during slide show. When selected, the selected photos are displayed during slide show. To start slide show, press **ENTER** button on **Slideshow** .
 - Set the time interval of the slide show in **Option**.
 - A slide show continues for a maximum of 4 hours. After 4 hours, the slide show will end and go to TV mode or external input mode.
- ▶ **BGM** : Listen to music while viewing photos in full size. To start BGM, press **ENTER** button on **BGM** .
 - Set the BGM device and album in **Option** .
- ▶ **⌛ (Rotate)** : Rotate photos.
 - Rotates the photo 90°, 180°, 270°, 360° clockwise upon **ENTER** button on **⌛ (Rotate)**.
- ▶ **Delete** : Delete photos. Use **◀** or **▶** button to select **Delete** and press **ENTER** button.



The aspect ratio of a photo may change the size of the photo displayed on the screen in full size.

- 4

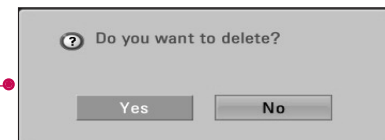

- ▶ **Option** : Set values for **Slide Speed** and **Music folder**. Use ◀ or ▶ button to select **Option** and press **ENTER** button.
 - Use ◀ or ▶ button and **ENTER** button to set values. Then go to **Enter** and press **ENTER** to save the settings.
 - You cannot change **Music Folder** while BGM is playing.
- ▶ **Hide** : Hide the menu on the full-sized screen. Use ◀ or ▶ button to select **Hide** and press **ENTER** button.
 - To see the menu again on the full-sized screen, press **ENTER** button to display.

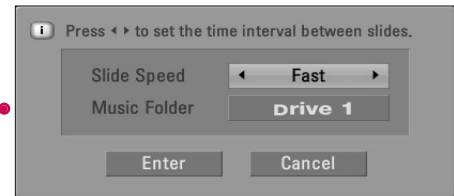

5 Use ▲ ▼◀▶ button to select the previous or next photo.

Use ▲ ▼◀▶ button to select and control the menu on the full-sized screen.

6 Use **EXIT** button to go back to the photo list from the full-sized screen.

7 Repeatedly, press **EXIT** button to return to TV viewing or press **MEDIA HOST** button to return to the Media Host menu.

! NOTE

- ▶ If it is Progressive JPEG format, some photos may be not decoded.

MUSIC LIST

Purchased music files(*.MP3) may contain copyright restrictions. Playback of these files may not be supported by this model. Music file on your USB device can be played by this unit.

The On Screen Display may be different from your set. Images are an example to assist with the TV operation.

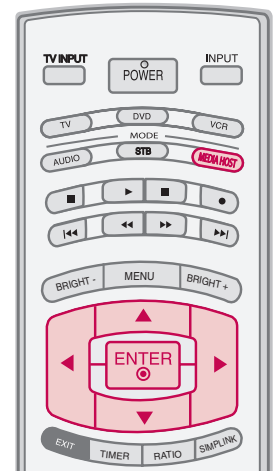

Screen Components

① Usable USB memory



② Current page/Total pages

③ Total number of marked musics

④ Current playing time/Total playing time

⑤ Corresponding buttons on the remote control

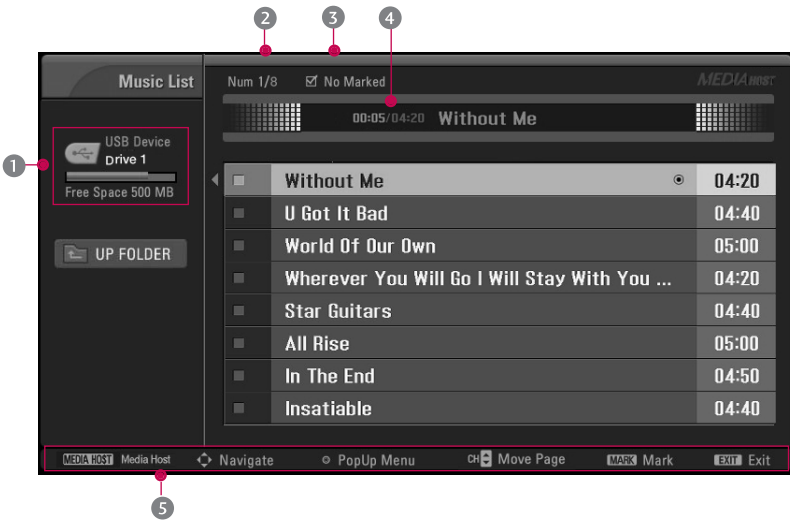

Music Selection and PopUp Menu

As shown , up to 8 music titles are listed per page.

- 1 Use the **CH ▲** or **▼** button to navigate in the music titles page.
- 2 Use **MARK** button to mark or unmark a music. When one or more music files are marked, the marked musics will be played in sequence. For example, if you want to listen to only one music repeatedly, just mark the music only and play it. If no music is marked, all the music in the folder will be played in sequence.
- 3 Use **▲ ▼** button to navigate the appropriate musics, then press the **ENTER** button to show up the pop-up menu.

- ▶ **Play (During stop)** : Play the selected musics.
Once a music finishes playing, the next selected one will be played. When there are no selected musics to play, the next one in the current folder will be played. If you go to a different folder and press the **ENTER** button, the current music in play-back will stop.
- ▶ **Stop Play (During playback)** : Stop the playing musics.
- ▶ **Play With Photo** : Start playing the selected musics and then move to the Photo List.
- ▶ **Mark All** : Mark all musics in the folder.
- ▶ **Delete** : Delete the selected musics.
- ▶ **Cancel** : Close the pop-up menu.

- 4 Repeatedly, press **EXIT** button to return to TV viewing or press **MEDIA HOST** button to return to the Media Host menu.
 - If you don't press any button for a while during the playing, the play information box (as shown in the below) will float as a screen saver.
 - The 'Screen Saver'?
Screen saver is to prevent screen pixel damage due to an fixed image remaining on the screen for an extended period of time.

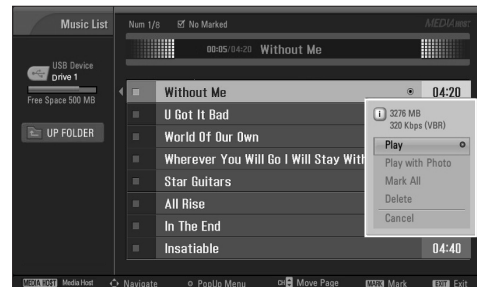
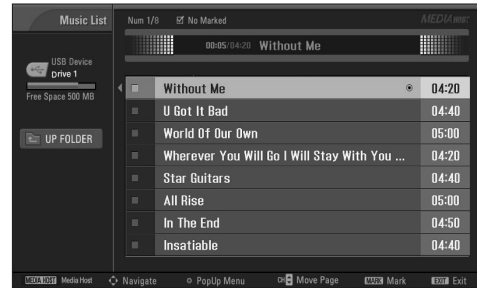

- 1
- 2
- 3

NOTE

- ▶ When music is playing, **U** is displayed in front of the music title.
- ▶ A damaged or corrupted music does not play but displays 00:00 in playtime.
- ▶ A music downloaded from a paid service with copyright protection does not start but displays inappropriate information in playtime.
- ▶ If you press **ENTER** , **EXIT** buttons, screen saver is stopped.
- ▶ The , , , , buttons on the remote control are also available in this mode.

PICTURE CONTROL

PICTURE SIZE (ASPECT RATIO) CONTROL

This feature lets you choose the way an analog picture with a 4:3 aspect ratio is displayed on your TV. When you receive an analog picture with a 4:3 aspect ratio on your 16:9 TV, you need to specify how the picture is to be displayed.

- RGB-PC input source use 4:3 or 16:9 aspect ratio.

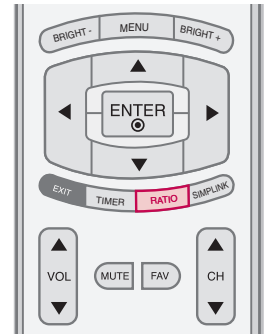

- 1 Press the **RATIO** button repeatedly to select the desired picture format. You can also adjust **Aspect Ratio** in the **PICTURE** menu.

Set by program

Selects the proper picture proportion to match the source's image.

(4:3 → 4:3)



(16:9 → 16:9)



4:3

Choose 4:3 when you want to view a picture with an original 4:3 aspect ratio.

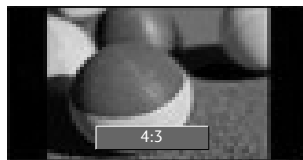

16:9

Adjust the picture horizontally, in a linear proportion to fill the entire screen.

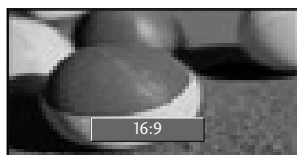

Zoom 1

Choose Zoom 1 when you want to view the picture without any alteration. However, the top and bottom portions of the picture will be cropped.

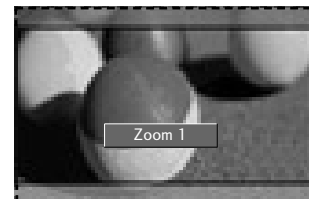

Zoom 2

Choose Zoom 2 when you want the picture to be altered, both vertically extended and cropped. The picture taking a halfway trade off between alteration and screen coverage.

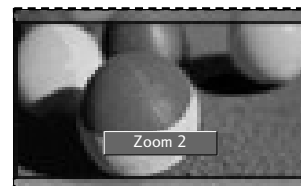

PRESET PICTURE SETTINGS

Picture Mode -Preset

Picture Mode adjusts the TV for the best picture appearance. Select the preset value in the Picture Mode menu based on the program category.

Intelligent Eye, Dynamic, Standard, Mild Settings are preset for optimum picture quality at the factory and are not adjustable.

In the User 1, and User 2 modes only, user can directly adjust the contrast, brightness, color, sharpness, tint.

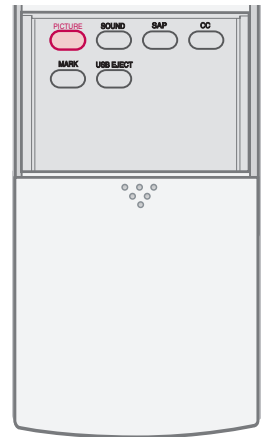

- 1 Press the **PICTURE** button repeatedly to select the picture appearance setup option as shown below :
Intelligent Eye, Dynamic, Standard, Mild, User1, and User2 (your own settings).

- 2 Press the **EXIT** button to save and return to TV viewing.

■ You can also use the **PICTURE** menu to adjust Picture Mode.

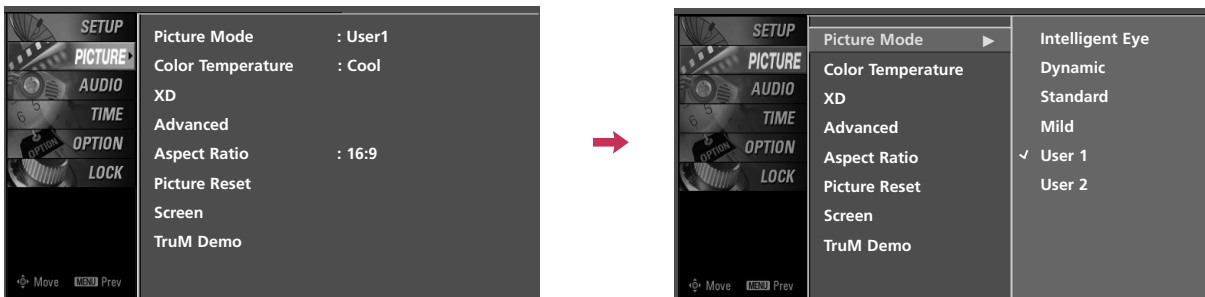

PICTURE CONTROL

Color Tone -Preset

Choose one of three automatic color adjustments. Set to warm to enhance hotter colors such as red, or set to cool to see less intense colors with more blue.

When selecting Picture Mode options (Dynamic, Standard and Mild), Color Temperature is automatically change.

When selecting Picture Mode options (User 1 and User 2), you can choose the Color Temperature.

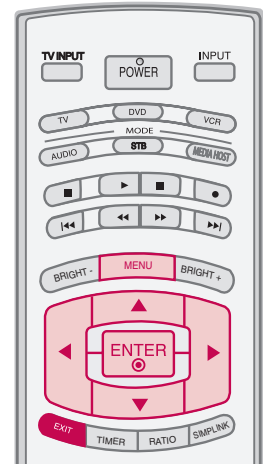

1 Press the **MENU** button and then use ▲ or ▼ button to select the **PICTURE** menu.

2 Press the ► button and then use ▲ or ▼ button to select **Color Temperature**.

3 Press the ► button and then use ▲ or ▼ button to select either **Cool, Medium, Warm** or **User**.

4 Press **EXIT** button to return to TV viewing or press **MENU** button to return to the previous menu.

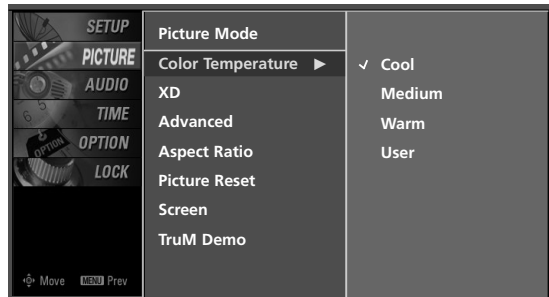
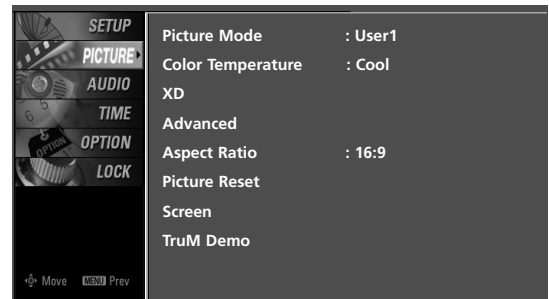

3

MANUAL PICTURE ADJUSTMENT

Picture Mode -User Mode

Adjust the picture appearance to suit your preference and viewing situations.

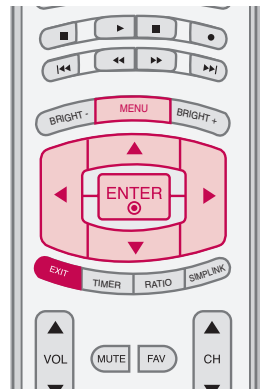

1 Press the **MENU** button and then use ▲ or ▼ button to select the **PICTURE** menu.

2 Press the ► button and then use ▲ or ▼ button to select **Picture Mode**.

3 Press the ► button and then use ▲ or ▼ button to select **User 1** or **User 2**.

4 Press the ► button and then use ▲ or ▼ button to select the desired picture option (**Contrast, Brightness, Color, Sharpness, Tint or Back Light**).

- **[Back Light]** To control the brightness of screen, adjust the brightness of LCD panel.

5 Press the ► button and then use ◀ or ▶ button to make appropriate adjustments.

6 Press **EXIT** button to return to TV viewing or press **MENU** button to return to the previous menu.

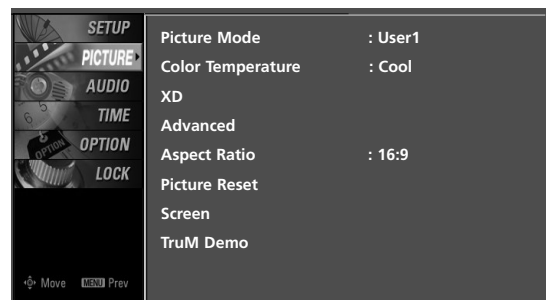

1

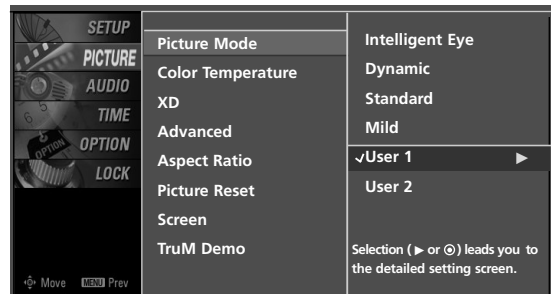

2 3

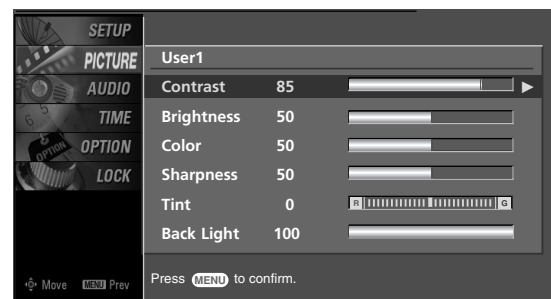

4

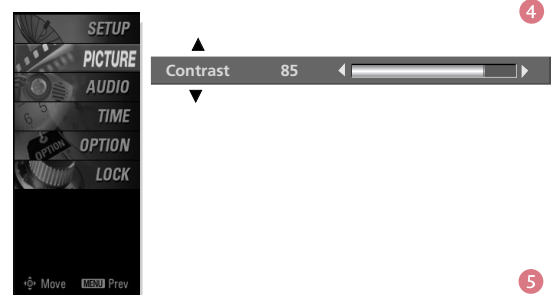

5

PICTURE CONTROL

Color Tone -User Mode

You can also adjust the detailed settings (Red, Green, Blue) by selecting the **User** menu.

This feature operates only if the picture mode is set to **User 1** or **User 2**.

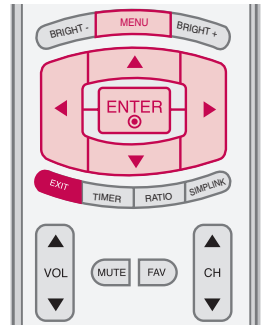

1 Press the **MENU** button and then use **▲** or **▼** button to select the **PICTURE** menu.

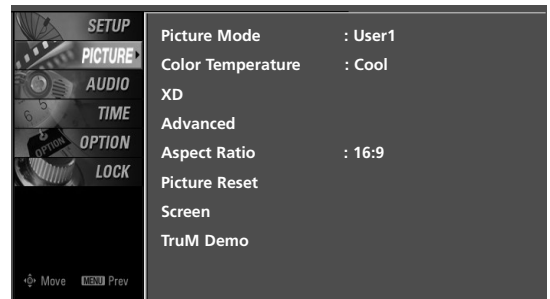

2 Press the **▶** button and then use **▲** or **▼** button to select **Color Temperature**.

3 Press the **▶** button and then use **▲** or **▼** button to select **User**.

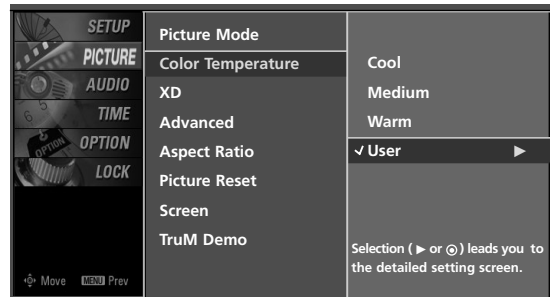

4 Press the **▶** button and then use **▲** or **▼** button to select **Red, Green, or Blue**.

5 Press the **▶** button and then use **◀** or **▶** button to make appropriate adjustments.

- The adjustment range of **Red, Green, or Blue** is -20~ +20.

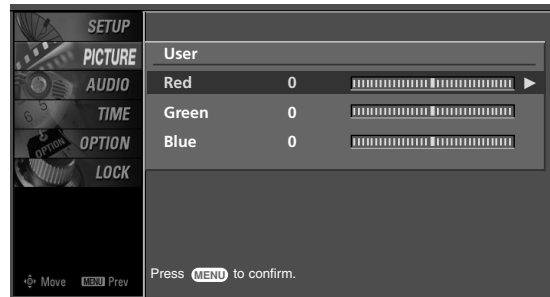

6 Press **EXIT** button to return to TV viewing or press **MENU** button to return to the previous menu.



XD - PICTURE IMPROVEMENT TECHNOLOGY

XD is LG Electronics unique picture improving technology to display a real HD source through an digital signal processing algorithm.

When selecting Picture Mode options (Dynamic, Standard and Mild), XD is automatically change to Auto.

When selecting Picture Mode options (User 1 and User 2), you can choose the Auto / Manual and when selecting Manual, you can adjust the XD Contrast, XD color and XD Noise.

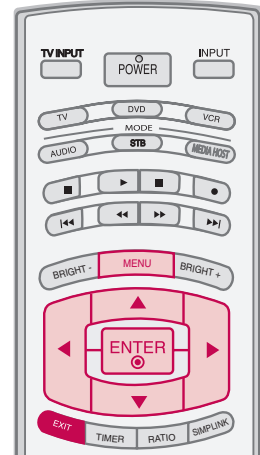

1 Press the **MENU** button and then use **▲** or **▼** button to select the **PICTURE** menu.

2 Press the **▶** button and then use **▲** or **▼** button to select **XD**.

3 Press the **▶** button and then use **◀** or **▶** button to select **Auto** or **Manual**.

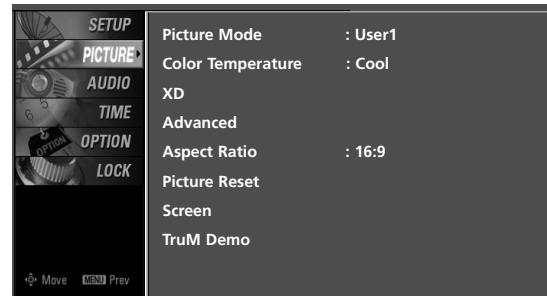

PICTURE CONTROL

* Selecting the Manual

1. Press the **▼** button and then use **▲** or **▼** button to select **XD Contrast**, **XD Color** or **XD Noise**.

- **XD Contrast** : Optimizing the contrast automatically according to the brightness of the reflection.
- **XD Color** : Adjusting the colors of the reflection automatically to reproduce as closely as possible to the natural colors.
- **XD Noise** : Removing the noise up to the point where it does not damage the original picture.

2. Use the **◀** or **▶** button to select **On** or **Off**.

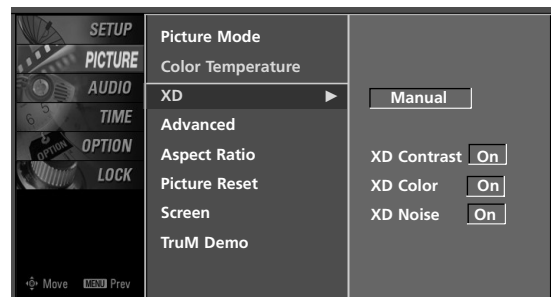

4 Press **EXIT** button to return to TV viewing or press **MENU** button to return to the previous menu.

PICTURE CONTROL

ADVANCED -CINEMA 3:2 PULLDOWN MODE

Set up the TV for the best picture appearance for viewing movies.

This feature is disable only in RGB-PC, HDMI1, HDMI2, HDMI3 or Component1,2(except 480i) mode.

When you operate Cinema (3:2 Pull-Down Mode or Cinema Correction Mode), the TV will adjust 24 fps video from movies to 30 fps video for display (This function is only available in TV(Analog, DTV), AV1, AV2, Component 480i mode.)

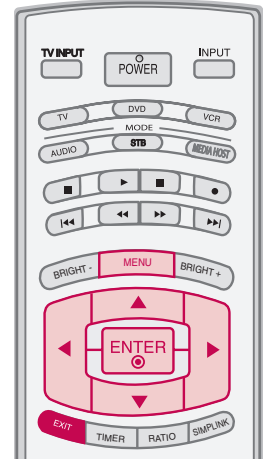

1 Press the **MENU** button and then use ▲ or ▼ button to select the **PICTURE** menu.

2 Press the ► button and then use ▲ or ▼ button to select **Advanced**.

3 Press the ► button and then use ▲ or ▼ button to select **Cinema 3:2 Mode**.

4 Press the ► button and then use ◀ or ▶ button to select **On** or **Off**.

5 Press **EXIT** button to return to TV viewing or press **MENU** button to return to the previous menu.

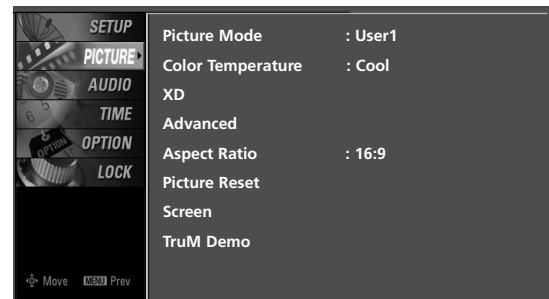

1

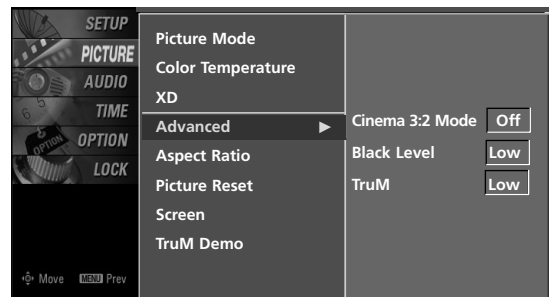

2 3 4

ADVANCED - BLACK (DARKNESS) LEVEL

Adjusting the contrast and the brightness of the screen using the black level of the screen.

This feature operates only in HDMI1, HDMI2, HDMI3 or AV1, AV2 mode.

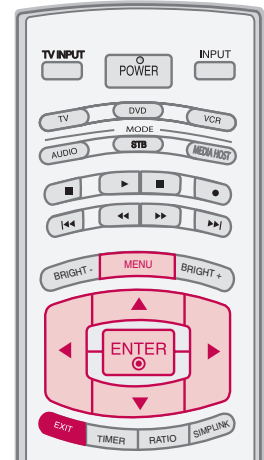

1 Press the **MENU** button and then use ▲ or ▼ button to select the **PICTURE** menu.

2 Press the ► button and then use ▲ or ▼ button to select **Advanced**.

3 Press the ► button and then use ▲ or ▼ button to select **Black level**.

4 Press the ► button and then use ◀ or ▶ button to select **Low**, or **High**.

- **Low**
The reflection of the screen gets darker.
- **High**
The reflection of the screen gets brighter.

5 Press **EXIT** button to return to TV viewing or press **MENU** button to return to the previous menu.

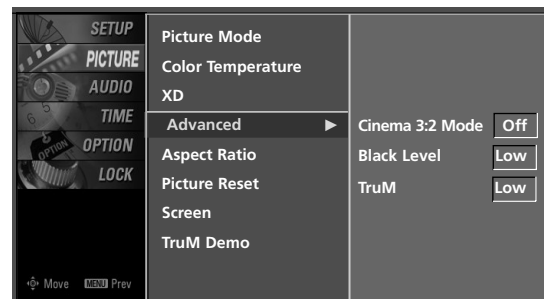
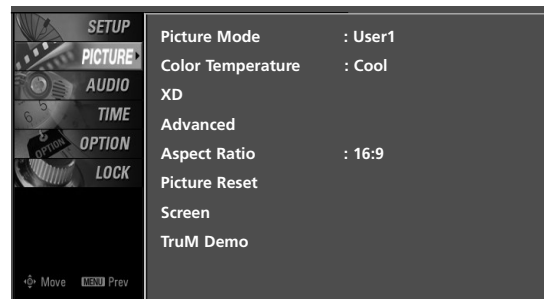

PICTURE CONTROL

ADVANCED - TruM

Set up the TV for best picture with film judder cancellation that provides stunningly steady movements.

This feature is disable in RGB-PC, HDMI-PC mode.

And when HDMI is set to the PC in Input Label, TruM is also disable.

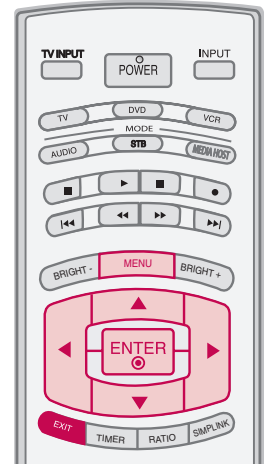

1 Press the **MENU** button and then use ▲ or ▼ button to select the **PICTURE** menu.

2 Press the ► button and then use ▲ or ▼ button to select **Advanced**.

3 Press the ► button and then use ▲ or ▼ button to select **TruM**.

4 Press the ► button and then use ◀ or ▶ button to select **Off, Low, or High**.

■ **Low**

Set amount of film judder to low.

■ **High**

Set amount of film judder to high.

* If you have some problem in viewing picture, set **TruM** to **Low** or **Off**.

5 Press **EXIT** button to return to TV viewing or press **MENU** button to return to the previous menu.

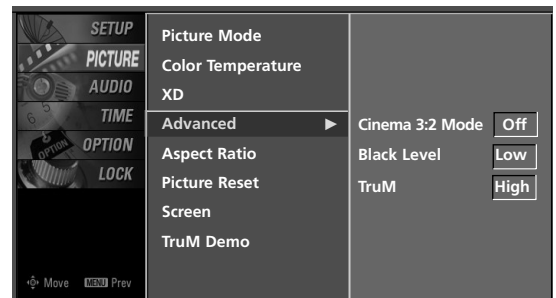
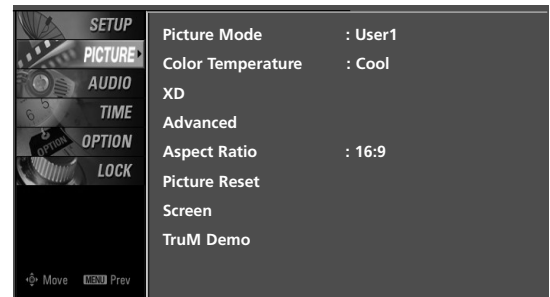

2 3 4

TruM DEMO

Use it to see the difference between TruM Demo on and TruM Demo off.

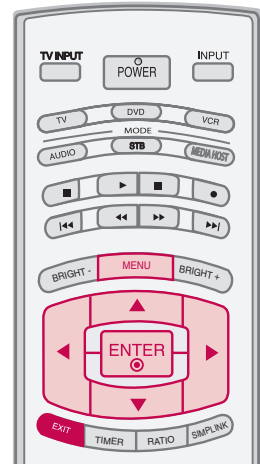

1 Press the **MENU** button and then use ▲ or ▼ button to select the **PICTURE** menu.

2 Press the ► button and then use ▲ or ▼ button to select **TruM Demo**.

3 Press the ► button to begin **TruM Demo**.

4 To stop **TruM Demo**, press the **EXIT** button.

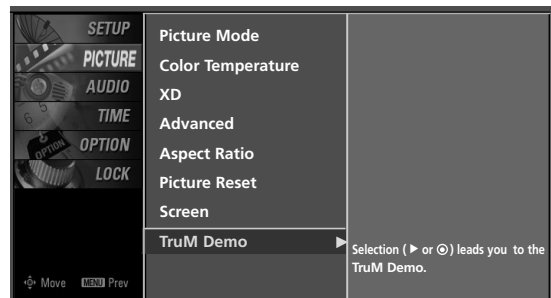
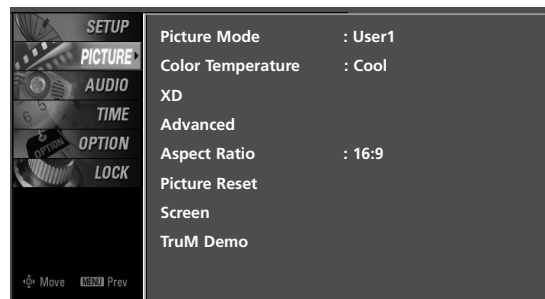

3 4

• TruM Demo



PICTURE CONTROL

PICTURE RESET

Use to quickly reset all the Picture menu options to their original factory preset values.

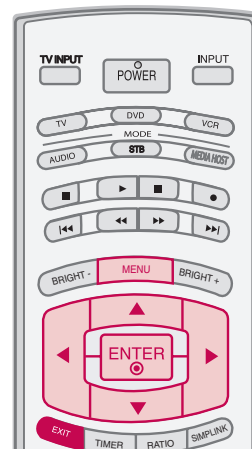

1 Press the **MENU** button and then use ▲ or ▼ button to select the **PICTURE** menu.

2 Press the ► button and then use ▲ or ▼ button to select **Picture Reset**.

3 Press the ► button to reset the Picture menu options to original values.

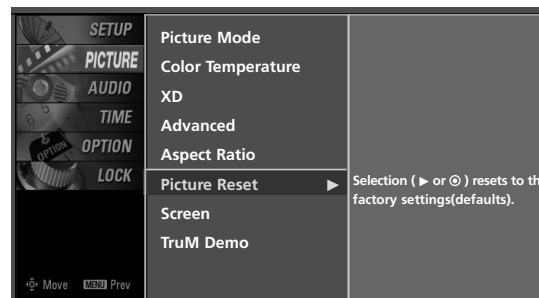
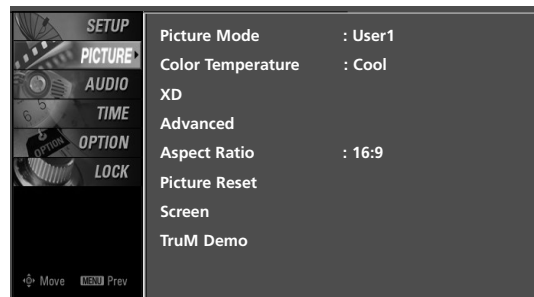

3

SOUND & LANGUAGE CONTROL

AUTO VOLUME LEVELER (AUTO VOLUME)

Scans for changes in sound levels during commercials, then adjusts the sound to match the specified audio level. Auto Volume makes sure that the volume level remains consistent whether you are watching a commercial or a regular TV program.

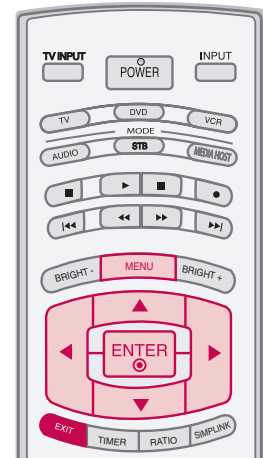

1 Press the **MENU** button and then use ▲ or ▼ button to select the **AUDIO** menu.

2 Press the ► button and then use ▲ or ▼ button to select **Auto Volume**.

3 Press the ► button and then use ▲ or ▼ button to select **On** or **Off**.

4 Press **EXIT** button to return to TV viewing or press **MENU** button to return to the previous menu.

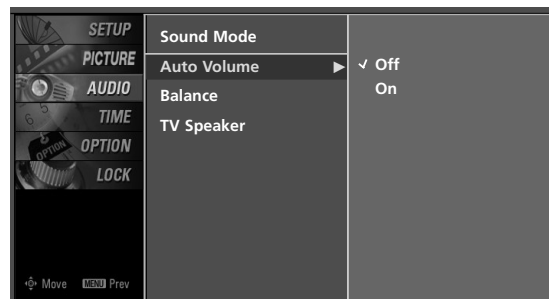
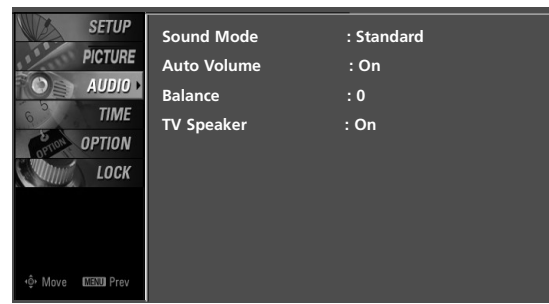

SOUND & LANGUAGE CONTROL

PRESET SOUND SETTINGS (SOUND MODE)

Sound Mode lets you enjoy the best sound without any special adjustment because the TV sets the appropriate sound options based on the program content.

Standard, Music, Movie, Sports and User are preset for good sound quality at the factory and are not adjustable.



- 1 Press the **SOUND** button repeatedly to select the appropriate sound setup as shown below:
Standard, Music, Movie, Sports and **User** (your own settings).

- 2 Press **EXIT** button to return to TV viewing .

■ You can also adjust Sound Mode in the **AUDIO** menu.



SOUND SETTING ADJUSTMENT - USER MODE

Adjust the sound to suit your taste and room situations.

1 Press the **MENU** button and then use ▲ or ▼ button to select the **AUDIO** menu.

2 Press the ► button and then use ▲ or ▼ button to select **Sound Mode**.

3 Press the ► button and then use ▲ or ▼ button to select **User**.

4 Press the ► button and then use ▲ or ▼ button to select the desired sound option (**Treble**, **Bass**, or **Front Surround**).

5 Press the ► button and then use ◀ or ▶ button to make appropriate adjustments.

Selecting the Front surround

Press the ► button and then use ◀ or ▶ button to select **Off**, **3D EchoSound System** or **SRS (Sound Retrieval System) TruSurround XT**.

6 Press **EXIT** button to return to TV viewing or press **MENU** button to return to the previous menu.

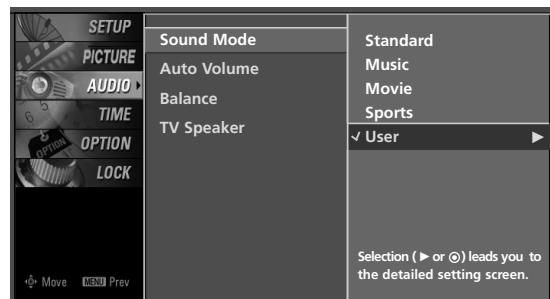
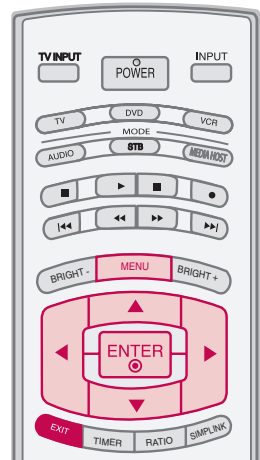

1 2 3



4

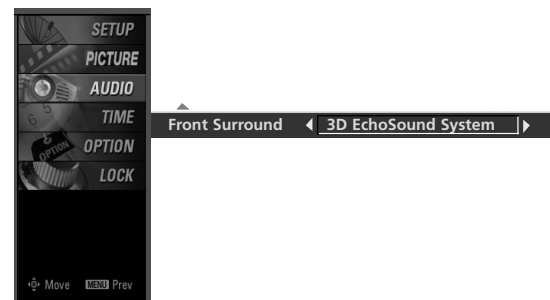

SRS TruSurround XT

Takes advantage of any multi-channel format without needing to add extra speakers or equipment. Dialog clarity, bass enrichment, and the addition of stereo audio enhancement produces an immersive sound experience from standard stereo material.

3D EchoSound System

Creates a stunning simulated stereo effect from any mono sound and a realistic three-dimensional sound with a very wide and deep sound stage.

SOUND & LANGUAGE CONTROL

BALANCE

Adjust the left/right sound of speaker to suit your taste and room situations.

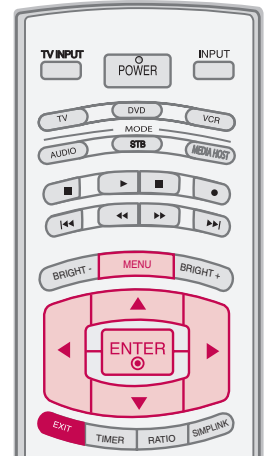

1 Press the **MENU** button and then use ▲ or ▼ button to select the **AUDIO** menu.

2 Press the ► button and then use ▲ or ▼ button to select **Balance**.

3 Press the ► button and then use ◀ or ▶ button to make appropriate adjustments.

4 Press **EXIT** button to return to TV viewing or press **MENU** button to return to the previous menu.

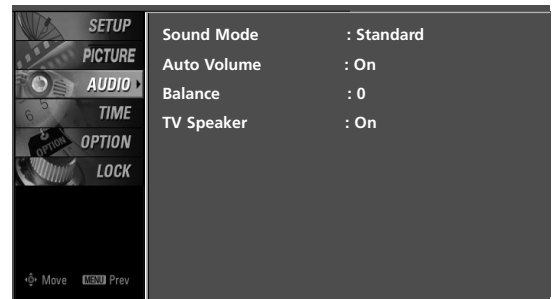

1

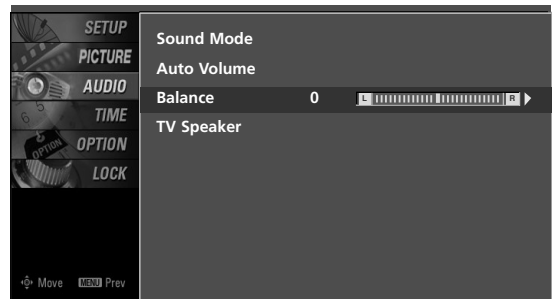

2

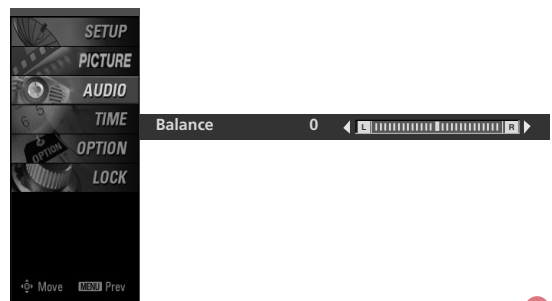

3

STEREO/SAP BROADCAST SETUP

This TV can receive MTS stereo programs and any SAP (Secondary Audio Program) that accompanies the stereo program if the station transmits an additional sound signal as well as the original one and when you select Stereo or SAP on the remote control.

Mono sound is automatically received if the broadcast is only in Mono; even though Stereo or SAP has been selected.

Select Mono if you want to listen to the mono sound in remote areas during stereo/SAP broadcasting.

Stereo or SAP can be received in Analog channel.



-
- 1 Use the **SAP** button to select your desired MTS mode in analog signal. Each time you press the **SAP** button, Mono, Stereo, or SAP appear in turn.
 - If other languages available on the digital signal, select them with the **SAP** button.

-
- 2 Press **EXIT** button to save and return to TV viewing.
-

SOUND & LANGUAGE CONTROL

TV SPEAKERS ON/OFF SETUP

Turn the TV speakers off if using external audio equipment. Feature turns the TV Speakers option On or Off.

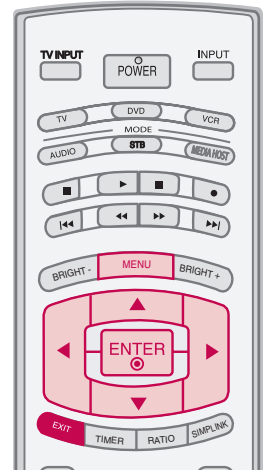

1 Press the **MENU** button and then use ▲ or ▼ button to select the **AUDIO** menu.

2 Press the ► button and then use ▲ or ▼ button to select **TV Speaker**.

3 Press the ► button and then use ▲ or ▼ button to select **On** or **Off**.

4 Press **EXIT** button to return to TV viewing or press **MENU** button to return to the previous menu.

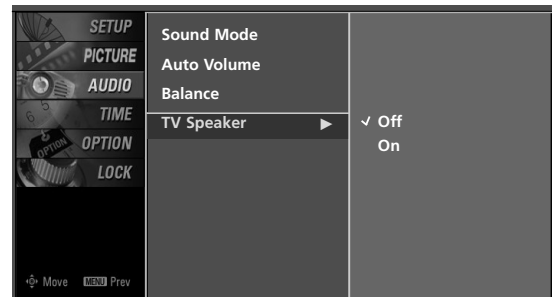
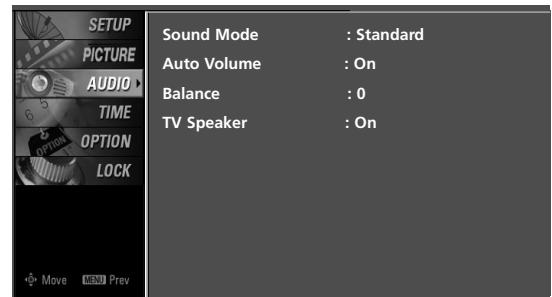

3

AUDIO LANGUAGE

Other languages may be available if a digital signal is provided by the broadcasting station.

This feature operate only in DTV/CADTV mode.

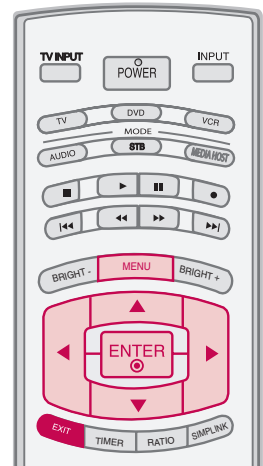

1 Press the **MENU** button and then use ▲ or ▼ button to select the **OPTION** menu.

2 Press the ► button and then use ▲ or ▼ button to select **Language**.

3 Press the ► button and then use ▲ or ▼ button to select **Audio**.

4 Press the ► button and then use ◀ or ▶ button to select : English, Spanish, or French.

5 Press **EXIT** button to return to TV viewing or press **MENU** button to return to the previous menu.

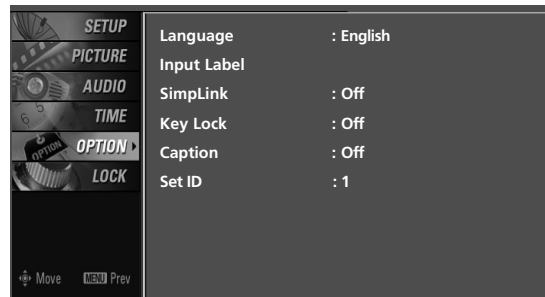

1

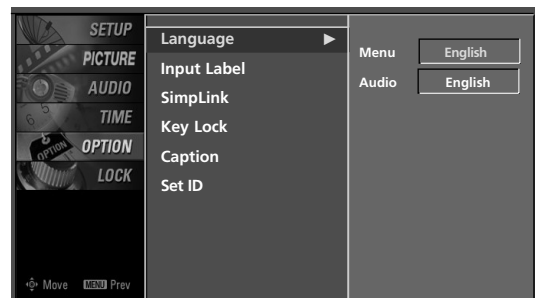

2 3

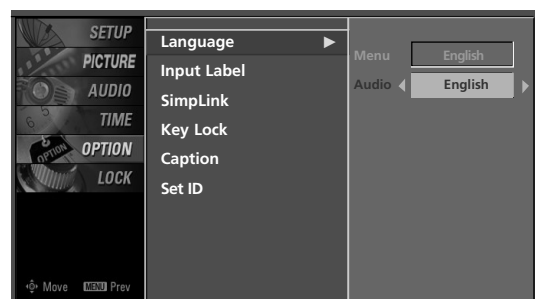

4

SOUND & LANGUAGE CONTROL

ON-SCREEN MENUS LANGUAGE SELECTION

The menus can be shown on the screen in the selected language. First select your language. First select your language.

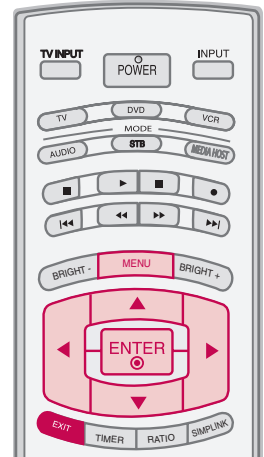

1 Press the **MENU** button and then use ▲ or ▼ button to select the **OPTION** menu.

2 Press the ► button and then use ▲ or ▼ button to select **Language**.

3 Press the ► button and then use ▲ or ▼ button to select **Menu**.

4 Press the ► button and then use ◀ or ▶ button to select your desired language.
From this point on, the on-screen menus will be shown in the selected language.

5 Press **EXIT** button to return to TV viewing or press **MENU** button to return to the previous menu.

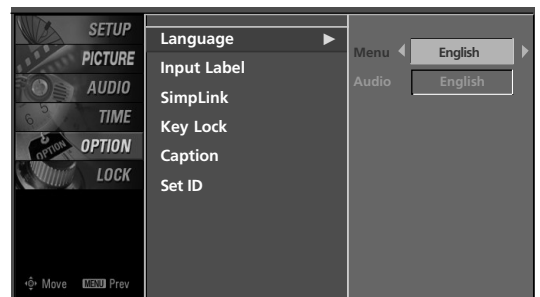
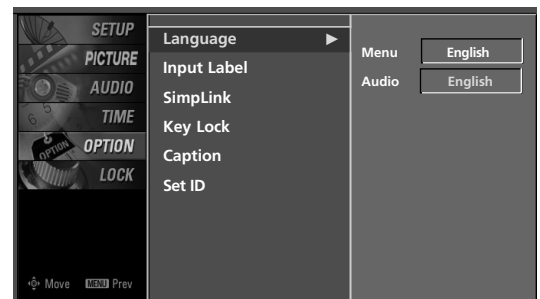
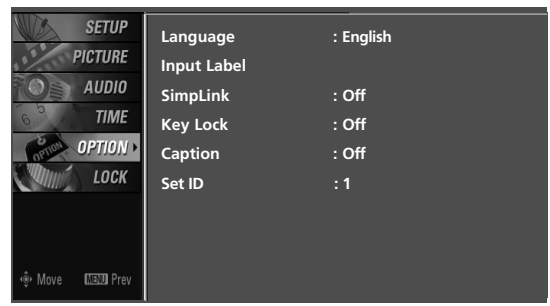

CAPTION MODE

Caption must be provided to help people with hearing loss watch TV.

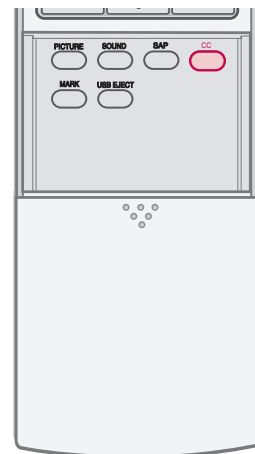

- 1 Use the **CC** button to select Caption **On** or **Off**.
 - When selecting **Off**, Sub-menus for Analog, DTV, and Digital Option become disabled.

- 2 Press **EXIT** to save and return to TV viewing.

- You can also adjust **Caption** in the **OPTION** menu.



SOUND & LANGUAGE CONTROL

Analog Broadcasting System Captions

Select a caption mode for displaying captioning information if provided on a program. Analog caption displays information at any position on the screen and is usually the program's dialog.

Caption/Text, if provided by the broadcaster, would be available for both digital and analog channels on the Antenna/Cable.

This TV is programmed to memorize the caption/text mode which was last set when you turn the power off.

This function is only available when **Caption Mode** is set **On**.

1 Press the **MENU** button and then use **▲** or **▼** button to select the **OPTION** menu.

2 Press the **▶** button and then use **▲** or **▼** button to select **Caption**.

3 Press the **▶** button and then use **▲** or **▼** button to select **Analog**.

4 Use **◀** or **▶** button to select **CC1**, **CC2**, **CC3**, **CC4**, **Text1**, **Text2**, **Text3** or **Text4**

■ CAPTION

The term for the words that scroll across the bottom of the TV screen; usually the audio portion of the program provided for the hearing impaired.

■ TEXT

The term for the words that appear in a large black frame and almost cover the entire screen; usually messages provided by the broadcaster.

5 Press **EXIT** button to return to TV viewing or press **MENU** button to return to the previous menu.



1

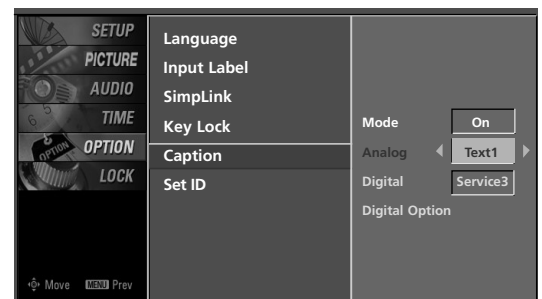

2 3 4

Digital Broadcasting System Captions

Choose the language you want the DTV/CADTV Captions to appear in.

Other Languages can be chosen for digital sources only if they are included on the program.

This function is only available when **Caption Mode** is set **On**.

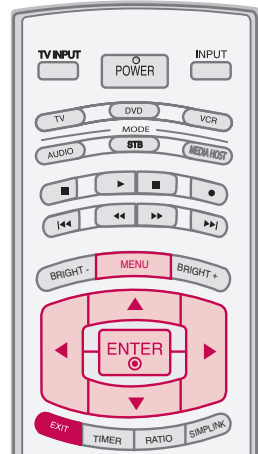

1 Press the **MENU** button and then use ▲ or ▼ button to select the **OPTION** menu.

2 Press the ► button and then use ▲ or ▼ button to select **Caption**.

3 Press the ► button and then use ▲ or ▼ button to select **Digital**.

4 Use ◀ or ▶ button to select **Service1 ~ Service6**.

5 Press **EXIT** button to return to TV viewing or press **MENU** button to return to the previous menu.

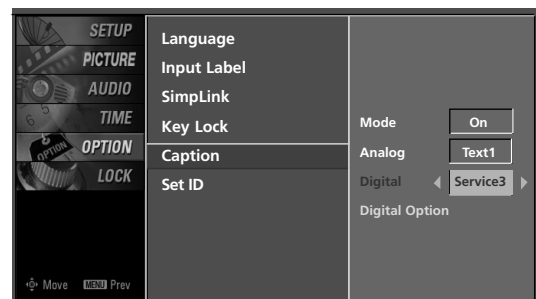

3 4

SOUND & LANGUAGE CONTROL

Caption Option

Customize the DTV/CADTV captions that appear on your screen.

This function is only available when **Caption Mode** is set **On**.

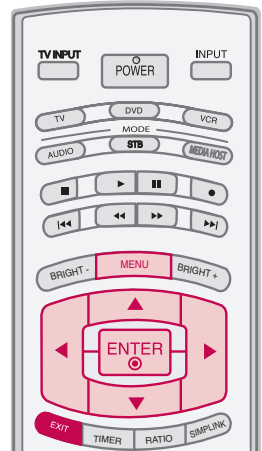

1 Press the **MENU** button and then use ▲ or ▼ button to select the **OPTION** menu.

2 Press the ► button and then use ▲ or ▼ button to select **Caption**.

3 Press the ► button and then use ▲ or ▼ button to select **Digital Option**.

4 Press the ► button and then use ◀ or ▶ button to select **Custom**.

5 Use ▲ or ▼ button to customize the Style, Font, etc., to your preference.

A preview icon is provided at the bottom of the screen, use it to see the caption language.

- **Size:** Set the size the words will appear in.
- **Font:** Select a typeface for the words.
- **Text Color:** Choose a color for the text.
- **Text Opacity:** Specify the opacity for the text color.
- **Bg (Background)Color:** Select a background color.
- **Bg (Background)Opacity:** Select the opacity for the background color.
- **Edge Type:** Select an edge type.
- **Edge Color:** Select a color for the edges.

6 Press **EXIT** button to return to TV viewing or press **MENU** button to return to the previous menu.

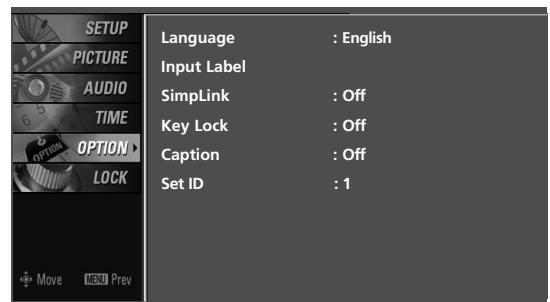

1

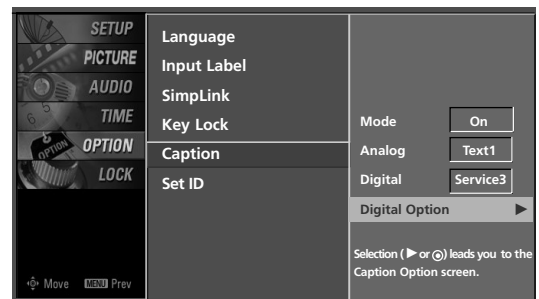

2 3

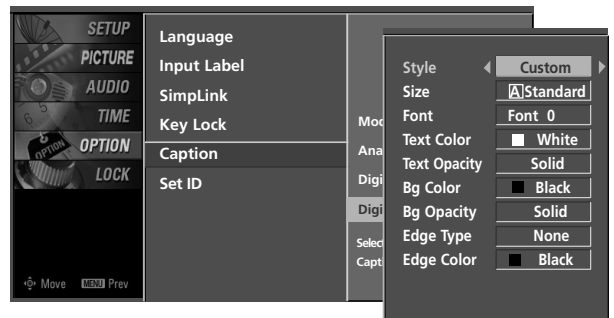

4 5

TIME SETTING

CLOCK SETTING

Auto Clock Setup

The time is set automatically from a digital channel signal. The digital channel signal includes information for the current time provided by the broadcasting station. Set the clock manually if the current time is set incorrectly by the auto clock function.

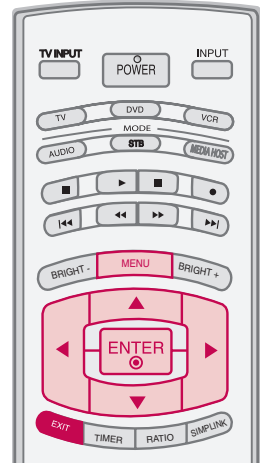

1 Press the **MENU** button and then use ▲ or ▼ button to select the **TIME** menu.

2 Press the ► button and then use ▲ or ▼ button to select **Clock**

3 Press the ► button and then use ▲ or ▼ button to select **Auto**.

4 Press the ► button and then use ▲ or ▼ button to select your viewing area time zone :
U.S.A: **Eastern, Central, Mountain, Pacific, Alaska or Hawaii.**
Canada: **Eastern, Central, Mountain, Pacific, New F.land or Atlantic.**

5 Press the ► button and then use ▲ or ▼ button to select **Auto, Off, On**, depending on whether or not your viewing area observes Daylight Saving time.

6 Press **EXIT** button to return to TV viewing or press **MENU** button to return to the previous menu.



1

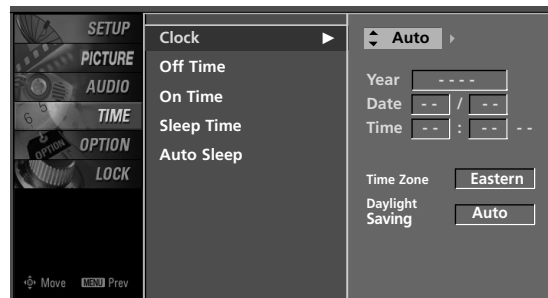

2 3 4 5

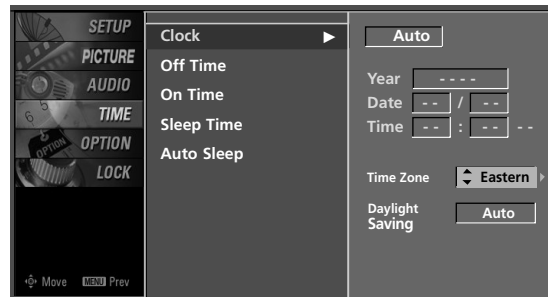

2 3 4 5

TIME SETTING

Manual Clock Setup

If the current time setting is wrong, reset the clock manually.

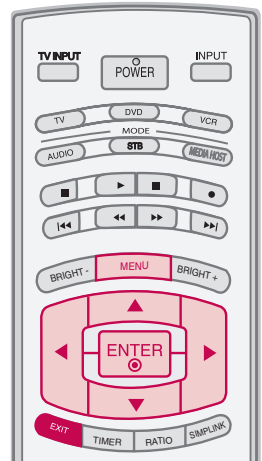

1 Press the **MENU** button and then use ▲ or ▼ button to select the **TIME** menu.

2 Press the ► button and then use ▲ or ▼ button to select **Clock**.

3 Press the ► button and then use ▲ or ▼ button to select **Manual**.

4 Press the ► button and then use ◀ or ▶ button to select either the year, date, or time option. Once selected, use the ▲ or ▼ button to set the year, date, and time options.

5 Press **EXIT** button to return to TV viewing or press **MENU** button to return to the previous menu.

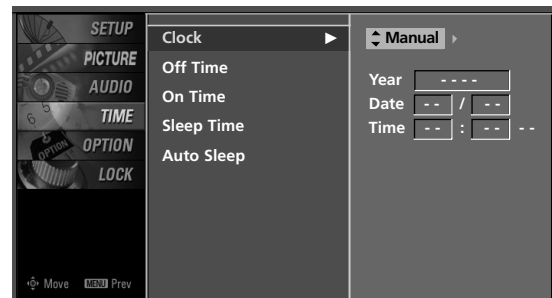

2 3

AUTO ON/OFF TIME SETTING

The timer function operates only if the current time has been set.

The Off-Time function overrides the On-Time function if they are both set to the same time.

The TV must be in standby mode for the On-Time to work. If you do not press any button within 2 hours after the TV turns on with the On Time function, the TV will automatically revert to standby mode.

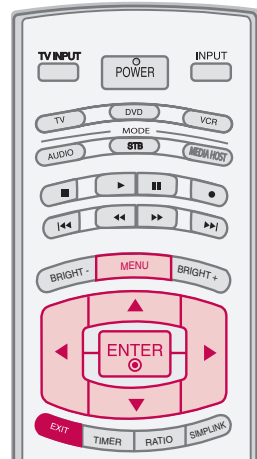

1 Press the **MENU** button and then use **▲** or **▼** button to select the **TIME** menu.

2 Press the **▶** button and then use **▲** or **▼** button to select **Off Time** or **On Time**.

3 Press the **▶** button and then use **▲** or **▼** button to select **On**.
 ■ To cancel **On/Off Time** function, select **Off**.

4 Press the **▶** button and then use **▲** or **▼** button to set the hour.

5 Press the **▶** button and then use **▲** or **▼** button to set the minutes.

6 **Only On Time**
 Press the **▶** button and then use **▲** or **▼** button to select the channel at turn-on.

Press the **▶** button and then use **▲** or **▼** button to set the sound level at turn-on.

7 Press **EXIT** button to return to TV viewing or press **MENU** button to return to the previous menu.



1

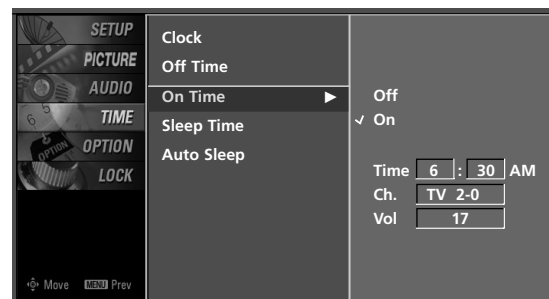

2 3 4 5 6

TIME SETTING

SLEEP TIME SETTING

The Sleep Time turns the TV off at the preset time.
Note that this setting is cleared when the TV is turned off.
You can also set up the Sleep Time in the TIME menu.

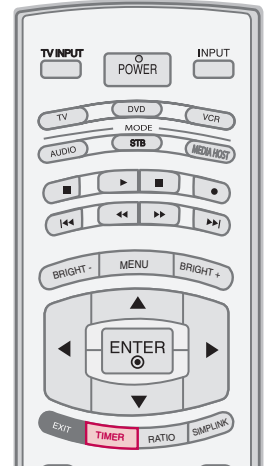

- 1 Press the **TIMER** button repeatedly to select the number of minutes. First the **Off** option appears on the screen, followed by the following Sleep Time options : 10, 20, 30, 60, 90, 120, 180, and 240 minutes.
- 2 When the number of minutes you want is displayed on the screen, press the **ENTER** button. The timer begins to count down from the number of minutes selected.
- 3 To check the remaining minutes before the TV turns off, press the **TIMER** button once.
- 4 To cancel the Sleep Time, press the **TIMER** button repeatedly to select **Off**.

■ You can also set up the Sleep Time in the TIME menu.

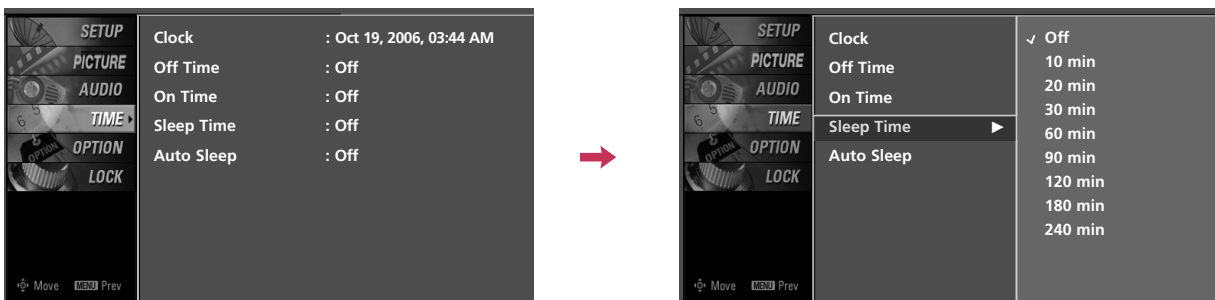

AUTO SHUT-OFF SETTING

TV will be automatically turned off, in case of no signal in TV & input source or no remote control input for 10 minutes.

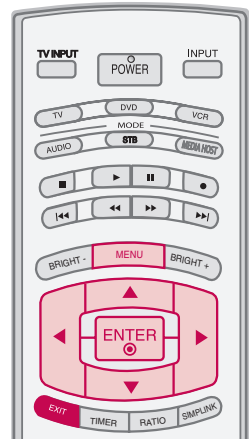

1 Press the **MENU** button and then use ▲ or ▼ button to select the **TIME** menu.

2 Press the ► button and then use ▲ or ▼ button to select **Auto Sleep**.

3 Press the ► button and then use ▲ or ▼ button to select **On** or **Off**.

4 Press **EXIT** button to return to TV viewing or press **MENU** button to return to the previous menu.



1

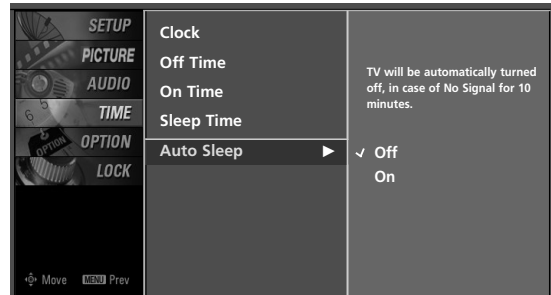

2 3

PARENTAL CONTROL / RATINGS

Parental Control can be used to block specific channels, ratings and other viewing sources.

The Parental Control Function (V-Chip) is used to block program viewing based on the ratings sent by the broadcasting station. The default setting is to allow all programs to be viewed. Viewing can be blocked by choosing the type of the program and the categories. It is also possible to block all program viewing for a time period. To use this function, the following must be done :

1. Set ratings and categories to be blocked.
2. Specify a password
3. Enable the lock

V-Chip rating and categories

Rating guidelines are provided by broadcasting stations. Most television programs and television movies can be blocked by TV Rating and/or Individual Categories. Movies that have been shown at the theaters or direct-to-video movies use the Movie Rating System (MPAA) only.

Ratings for Television programs including made-for-TV movies:

- TV-G (General audience)
- TV-MA (Mature audience only)
- TV-PG (Parental guidance suggested)
- TV-Y (All children)
- TV-14 (Parents strongly cautioned)
- TV-Y7 (Children 7 years older)

SET PASSWORD & LOCK SYSTEM

Setting up your Password

Set up blocking schemes to block specific channels, ratings, and external viewing sources.

A password is required to gain access to this menu.

- 1 Press the **MENU** button and then use the **▲** or **▼** button to select the **LOCK** menu. Then, press the **▶** button.

- Enter the password as requested.
- The TV is set up with the initial password "0-0-0-0".

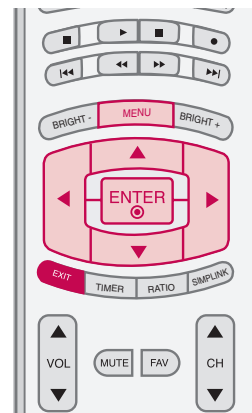
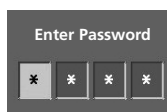

Set Password

Change the password by inputting a new password twice.

- 1 After inputting the password, use the ▲ or ▼ button to choose **Set password**.

- 2 Press the ► button and then choose any 4 digits for your new password and enter the them on the **new**.

As soon as the 4 digits are entered, reenter the same 4 digits on the **Confirm**.
Then your changed password has been memorized.

- 3 Press **EXIT** button to return to TV viewing or press **MENU** button to return to the previous menu.

For USA

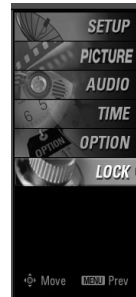

Lock System : Off
Set Password
Block Channel
Movie Rating
TV Rating-Children
TV Rating-General
Input Block

For Canada

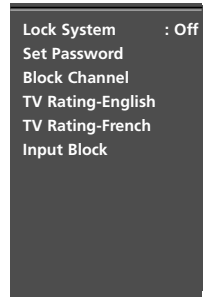

Lock System : Off
Set Password
Block Channel
TV Rating-English
TV Rating-French
Input Block

1

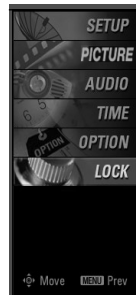

Lock System
Set Password ►
Block Channel
Movie Rating
TV Rating-Children
TV Rating-General
Input Block

New * * * *
Confirm * * * *

2

Lock System

Enables or disables the blocking scheme you set up previously.

- 1 After inputting the password, use the ▲ or ▼ button to choose **Lock System**.

- 2 Press the ► button and then use the ▲ or ▼ to select **On** or **Off**.

- When you select, the Lock System is enable.

- 3 Press **EXIT** button to return to TV viewing or press **MENU** button to return to the previous menu.

For USA

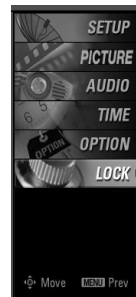

Lock System : Off
Set Password
Block Channel
Movie Rating
TV Rating-Children
TV Rating-General
Input Block

For Canada

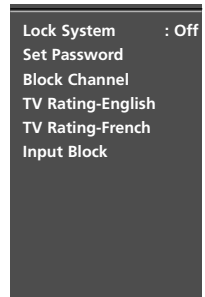

Lock System : Off
Set Password
Block Channel
TV Rating-English
TV Rating-French
Input Block

1

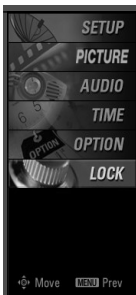

Lock System ►
Set Password
Block Channel
Movie Rating
TV Rating-Children
TV Rating-General
Input Block

✓ Off
On

2

PARENTAL CONTROL /RATINGS

CHANNEL BLOCKING

Blocks any channels that you do not want to watch or that you do not want your children to watch.

- 1 After inputting the password, use the ▲ or ▼ button to choose **Block Channel**.
- 2 Press the ► button. You will now see a screen filled with channel numbers and a preview picture.
- 3 Use ▲ ▼ ◀ ▶ button to select a channel and then use the **ENTER** button to block or unblock it.
- 4 Press **EXIT** button to return to TV viewing or press **MENU** button to return to the previous menu.

For USA

For Canada

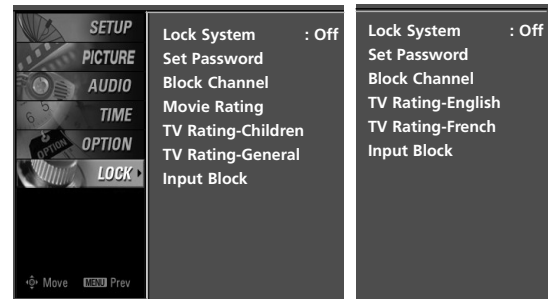

1

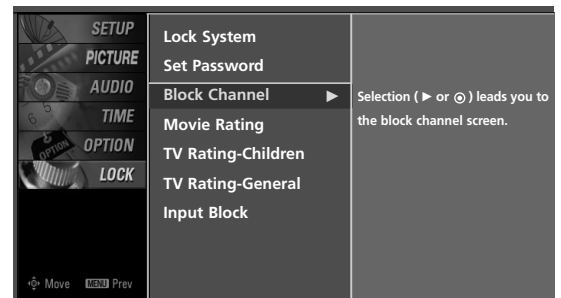

2

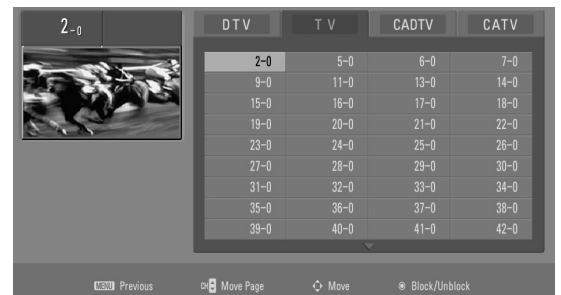

3

MOVIE & TV RATING

Movie Rating (MPAA) -for USA only

Blocks movies according to the movie ratings limits specified, so children cannot view certain movies. You can set the ratings limit by blocking out all the movies with the ratings above a specified level. Keep in mind that the movie ratings limit only applies to movies shown on TV, not TV programs, such as soap operas.

1 After inputting the password, use the ▲ or ▼ button to choose **Movie Rating**.

2 Press the ► button and then use the ▲ or ▼ to select **G, PG, PG-13, R, NC-17** or **X**.

- G (General audiences)
- PG (Parental guidance suggested)
- PG-13 (Parents strongly cautioned)
- R (Restricted)
- NC-17 (No one 17 and under admitted)
- X (Adult only)
- Blocking Off (Permits all programs)

► If you set PG-13 : G and PG movies will be available, PG-13, R, NC-17 and X will be blocked.

3 Press **EXIT** button to return to TV viewing or press **MENU** button to return to the previous menu.

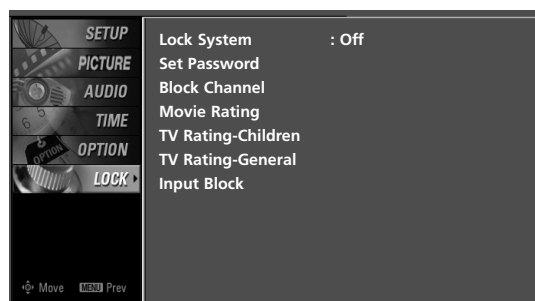

1

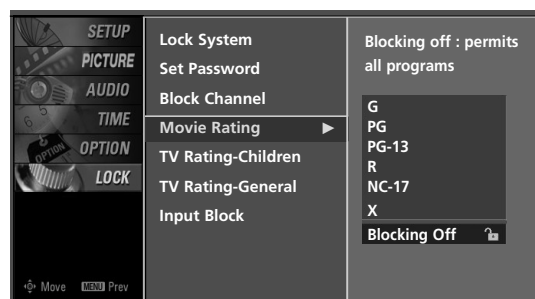

2

PARENTAL CONTROL /RATINGS

TV Rating Children - for USA only

Prevents children from watching certain children's TV programs, according to the ratings limit set. The children rating does not apply to other TV programs. Unless you block certain TV programs intended for mature audiences in the TV Rating - sub menu, your children can view those programs.

- 1 After inputting the password, use the ▲ or ▼ button to choose **TV Rating-Children**.
- 2 Press the ► button and then use the ▲ or ▼ to select **Age**, or **Fantasy Violence**.
Press the ► button and then use the ▲ or ▼ button to select block options.
 - Age(applies to TV-Y, TV-Y7)
 - Fantasy Violence(applies to TV-Y7)
- 3 Press **EXIT** button to return to TV viewing or press **MENU** button to return to the previous menu.

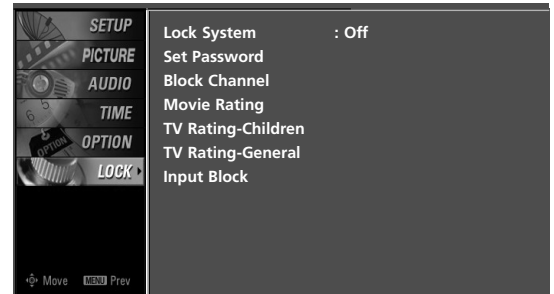

1

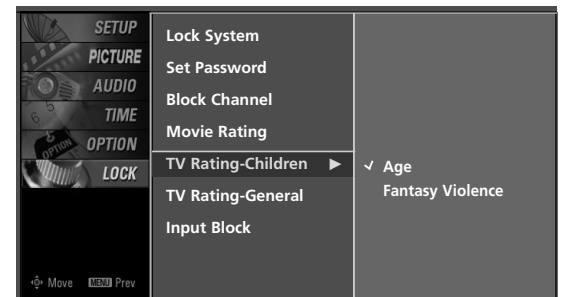

2

TV Rating General - for USA only

Based on the ratings, blocks certain TV programs that you and your family do not want to view.

- 1 After inputting the password, use the ▲ or ▼ button to choose **TV Rating-General**.
- 2 Press the ► button and then use the ▲ or ▼ button to select **Age**, **Dialogue**, **Language**, **Sex** or **Violence**.
Press the ► button and then use the ▲ or ▼ button to select block options.
 - Age(applies to TV-G,TV-PG,TV-14,TV-MA)
 - Dialogue-sexual dialogue(applies to TV-PG,TV-14)
 - Language-adult language(applies to TV-PG,TV-14,TV-MA)
 - Sex-sexual situations(applies to TV-PG,TV-14,TV-MA)
 - Violence(applies to TV-PG,TV-14,TV-MA)
- 3 Press **EXIT** button to return to TV viewing or press **MENU** button to return to the previous menu.

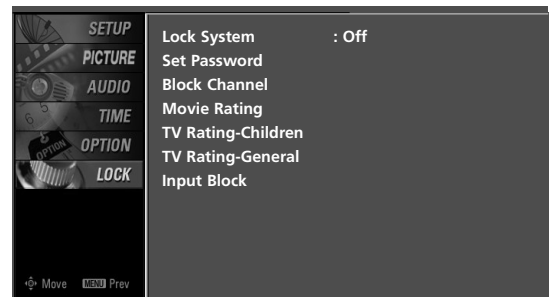

1

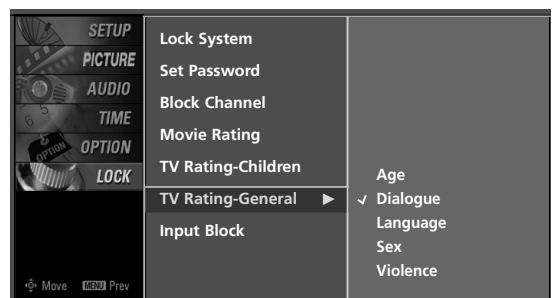

2

TV Rating english - for CANADA only

Selecting canadian english language rating system.

- 1 After inputting the password, use the ▲ or ▼ button to choose **TV Rating-English**.
- 2 Press the ► button and then use the ▲ or ▼ button to select **E, C, C8+, G, PG, 14+, 18+, or Blocking Off**.
 - E(Exempt)
 - C(Children)
 - C8+(Children eight years and older)
 - G(General programming, suitable for all audiences)
 - PG(Parental Guidance)
 - 14+(Viewers 14 years and older)
 - 18+(Adult programming)
 - Blocking Off(Permits all programs)
- 3 Press **EXIT** button to return to TV viewing or press **MENU** button to return to the previous menu.

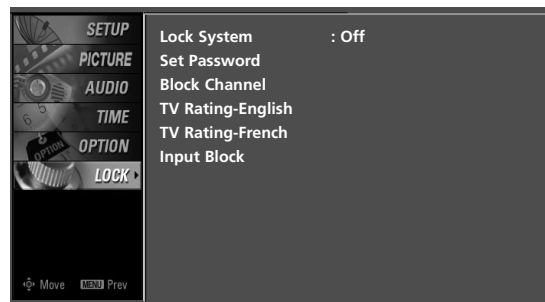

1

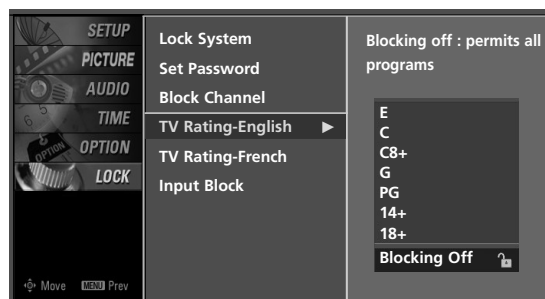

2

TV Rating french - for CANADA only

Selecting canadian french language rating system.

- 1 After inputting the password, use the ▲ or ▼ button to choose **TV Rating-French**.
- 2 Press the ► button and then use the ▲ or ▼ button to select **E, G, 8 ans+, 13 ans+, 16 ans+, 18 ans+, or Blocking Off**.
 - E(Exempt)
 - G(General)
 - 8 ans+(General-Not convenient for little children)
 - 13 ans+(Not convenient for children of 13 years and younger)
 - 16 ans+(Not convenient for children of 16 years and younger)
 - 18 ans+(This programs is only for adults)
 - Blocking Off(Permits all programs)
- 3 Press **EXIT** button to return to TV viewing or press **MENU** button to return to the previous menu.

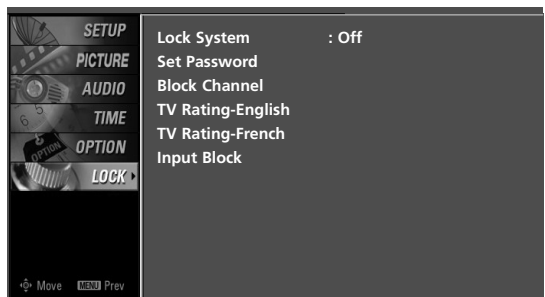

1

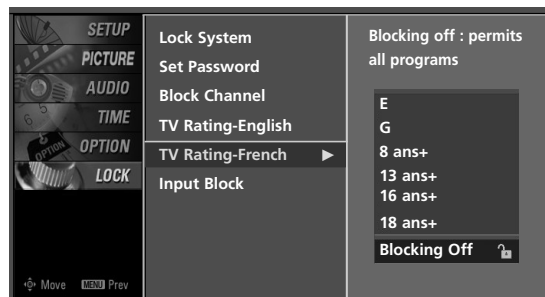

2

PARENTAL CONTROL /RATINGS

EXTERNAL INPUT BLOCKING

Enables you to select a source to block from the external source devices you have hooked up.

- 1 After inputting the password, use the ▲ or ▼ button to choose **Input Block**
- 2 Press the ► button and then use the ▲ or ▼ to select a source.
- 3 Press the ► button and then use the ◀ or ▶ to select **On** or **Off** on the each source.
- 4 Press **EXIT** button to return to TV viewing or press **MENU** button to return to the previous menu.

For USA

For Canada

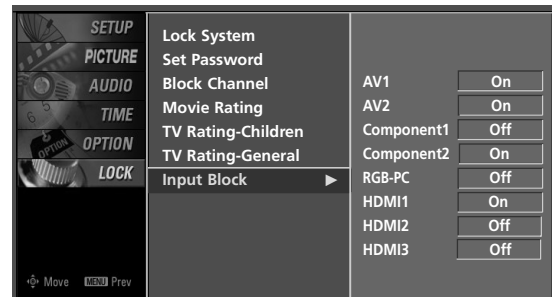
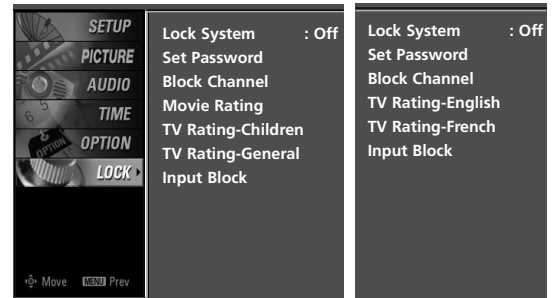

KEY LOCK

The TV can be set up so that it can only be used with the remote control.

This feature can be used to prevent unauthorized viewing by locking out the front panel controls.

This TV is programmed to remember which option it was last set to even if you turn the TV off.

- 1 Press the **MENU** button and then use ▲ or ▼ button to select the **OPTION** menu.
- 2 Press the ► button and then use ▲ or ▼ button to select **Key Lock**
- 3 Press the ► button and then use ▲ or ▼ button to select **On** or **Off**.
- 4 Press **EXIT** button to return to TV viewing or press **MENU** button to return to the previous menu.

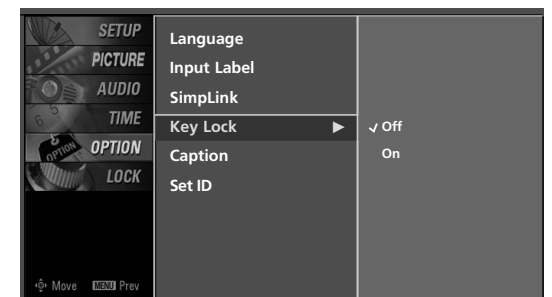
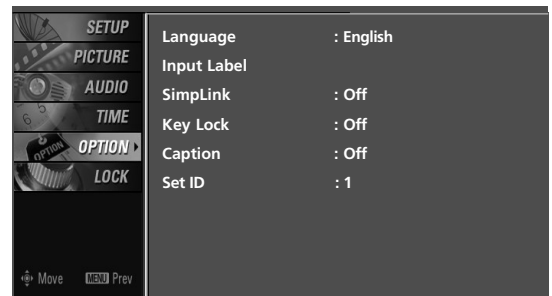

APPENDIX

TROUBLESHOOTING

The operation does not work normally.	
The remote control doesn't work	<ul style="list-style-type: none">■ Check to see if there is any object between the product and the remote control causing obstruction. Ensure you are pointing the remote control directly at the TV.■ Ensure that the batteries are installed with correct polarity (+ to +, - to -).■ Ensure that the correct remote operating mode is set: TV, VCR etc.■ Install new batteries.
Power is suddenly turned off	<ul style="list-style-type: none">■ Is the sleep timer set?■ Check the power control settings. Power interrupted.■ No broadcast on station tuned with Auto off activated.

The video function does not work.	
No picture & No sound	<ul style="list-style-type: none">■ Check whether the product is turned on.■ Try another channel. The problem may be with the broadcast.■ Is the power cord inserted into wall power outlet?■ Check your antenna direction and/or location.■ Test the wall power outlet, plug another product's power cord into the outlet where the product's power cord was plugged in.
Picture appears slowly after switching on	<ul style="list-style-type: none">■ This is normal, the image is muted during the product startups process. Please contact your service center, if the picture has not appeared after five minutes.
No or poor color or poor picture	<ul style="list-style-type: none">■ Adjust Color in menu option.■ Keep a sufficient distance between the product and the VCR.■ Try another channel. The problem may be with the broadcast.■ Are the video cables installed properly?■ Activate any function to restore the brightness of the picture.
Horizontal/vertical bars or picture shaking	<ul style="list-style-type: none">■ Check for local interference such as an electrical appliance or power tool.
Poor reception on some channels	<ul style="list-style-type: none">■ Station or cable product experiencing problems, tune to another station.■ Station signal is weak, reorient antenna to receive weaker station.■ Check for sources of possible interference.
Lines or streaks in pictures	<ul style="list-style-type: none">■ Check antenna (Change the direction of the antenna).

APPENDIX

The audio function does not work.

Picture OK & No sound	<ul style="list-style-type: none">■ Press the VOL or VOLUME button.■ Sound muted? Press MUTE button.■ Try another channel. The problem may be with the broadcast.■ Are the audio cables installed properly?
No output from one of the speakers	<ul style="list-style-type: none">■ Adjust Balance in menu option.
Unusual sound from inside the product	<ul style="list-style-type: none">■ A change in ambient humidity or temperature may result in an unusual noise when the product is turned on or off and does not indicate a fault with the product.

There is a problem in PC mode. (Only PC mode applied)

The signal is out of range (Invalid format)	<ul style="list-style-type: none">■ Adjust resolution, horizontal frequency, or vertical frequency.■ Check the input source.
Vertical bar or stripe on background & Horizontal Noise & Incorrect position	<ul style="list-style-type: none">■ Work the Auto configure or adjust clock, phase, or H/V position. (Option)
Screen color is unstable or single color	<ul style="list-style-type: none">■ Check the signal cable.■ Reinstall the PC video card.

MAINTENANCE

Early malfunctions can be prevented. Careful and regular cleaning can extend the amount of time you can enjoy your new TV.

Caution: Be sure to turn the power off and unplug the power cord before you begin any cleaning.

Cleaning the Screen

- 1 Here's a great way to keep the dust off your screen for a while. Wet a soft cloth in a mixture of lukewarm water and a little fabric softener or dish washing detergent. Wring the cloth until it's almost dry, and then use it to wipe the screen.
- 2 Make sure the excess water is off the screen, and then let it air-dry before you turn on your TV.

Cleaning the Cabinet

- To remove dirt or dust, wipe the cabinet with a soft, dry, lint-free cloth.
- Please be sure not to use a wet cloth.

Extended Absence

CAUTION

- ▶ If you expect to leave your TV dormant for a long time (such as a vacation), it's a good idea to unplug the power cord to protect against possible damage from lightning or power surges.

APPENDIX

PRODUCT SPECIFICATIONS

■ The specifications shown above may be changed without prior notice for quality improvement.

MODELS		42LBX (42LB9DF-UA)	47LBX (47LB9DF-UA)	52LBX (52LB9DF-UA)
Dimensions (Width x Height x Depth)	Including stand	40.6 x 30.7 x 13.8 inches 1030.0 x 781.0 x 350.0 mm	40.7 x 29.5 x 11.3 inches 1033.1 x 750.0 x 287.6 mm	45.1 x 32.5 x 13.0 inches 1144.5 x 825.6 x 331.0 mm
	Excluding stand	40.6 x 27.3 x 3.5 inches 1030.0 x 693.0 x 88.5 mm	40.7 x 27.0 x 3.5 inches 1033.1 x 686.5 x 88.5 mm	45.1 x 29.7 x 4.1 inches 1144.5 x 754.9 x 103.0 mm
Weight	including stand	56.9 pounds / 25.8kg	60.6 pounds / 27.5 kg	82.7 pounds / 37.5kg
	excluding stand	48.3 pounds / 21.9kg	50.7 pounds / 23.0 kg	69.2 pounds / 31.4kg
Power requirement		AC100-240V ~ 50/60Hz		
Television System		NTSC-M, ATSC, 64 & 256 QAM		
Program Coverage		VHF 2-13, UHF 14-69, CATV 1-135, DTV 2-69, CADTV 1-135		
External Antenna Impedance		75 ohm		
Environment condition	Operating Temperature	32 ~ 104°F (0 ~ 40°C)		
	Operating Humidity	Less than 80%		
	Storage Temperature	-4 ~ 140°F (-20 ~ 60°C)		
	Storage Humidity	Less than 85%		

PROGRAMMING THE REMOTE CONTROL

The provided universal remote control can be programmed to operate most remote-controllable devices. Note that the remote may not control all models of other brands.

Programming a code into a remote mode

- 1** To find out whether your remote control can operate each device without programming, turn on the device (such as a VCR) and press the corresponding mode button on the remote. After that, press the **POWER** button. If the device is turned off and it responds properly the remote control need not be programmed. If not, the remote should be programmed to operate the device. The programming procedures are explained below.
- 2** Press the **MENU** and **MUTE** button continuously at the same time for two seconds; the currently selected device button is illuminated. If you don't press any button for 20 seconds, the light on the mode button will be turned off. In that case, you have to repeat from step 2.
- 3** Enter the appropriate code from the code table on the following pages. When pressing the button, the light blinks at a time. If the device turned off, the programming is successful.
- 4** Press the **MENU** button to store the code. After blinking twice, this code is stored.
- 5** Test the remote control functions to see if the device responds properly. If not, steps 2-5.

APPENDIX

Remote control code

VCRs

Brand	Codes	Brand	Codes	Brand	Codes
AIWA	034	MAGNAVOX	031 033 034 041	SAMSUNG	032 040 102 104
AKAI	016 043 046 124 125 146		067 068 012 031 033 067		105 107 109 112 113 115 120 122 125
AMPRO	072	MARANTZ	069		
ANAM	031 033 103	MARTA	101	SANSUI	022 043 048 135
AUDIO DYNAMICS	012 023 039 043	MATSUI	027 030	SANYO	003 007 010 014 102 134
BROKSONIC	035 037 129	MEI	031 033	SCOTT	017 037 112 129 131
CANON	028 031 033	MEMOREX	003 010 014 031 033 034 053 072 101 102 134 139	SEARS	003 008 009 010 013 014 017 020 031 042 073 081 101
CAPEHART	108			SHARP	031 054 149
CRAIG	003 040 135	MGA	045 046 059	SHINTOM	024
CURTIS MATHES	031 033 041	MINOLTA	013 020	SONY	003 009 031 052 056 057 058 076 077 078 149
DAEWOO	005 007 010 064 065 108 110 111 112 116 117 119	MITSUBISHI	013 020 045 046 049 051 059 061 151	SOUNDESIGN	034
DAYTRON	108	MTC	034 040	STS	013
DBX	012 023 039 043	MULTITECH	024 034	SYLVANIA	031 033 034 059 067
DYNATECH	034 053	NEC	012 023 039 043 048	SYMPHONIC	034
ELECTROHOME	059			TANDY	010 034
EMERSON	006 017 025 027 029 031 034 035 036 037 046 101 129 131 138 153	NORDMENDE	043	TATUNG	039 043
FISHER	003 008 009 010	OPTONICA	053 054	TEAC	034 039 043
FUNAI	034	PANASONIC	066 070 074 083 133 140 145	TECHNICS	031 033 070
GE	031 033 063 072 107 109 144 147	PENTAX	013 020 031 033 063	TEKNIKA	019 031 033 034 101
GO VIDEO	132 136	PHILCO	031 034 067	THOMAS	034
HARMAN KARDON	012 045	PHILIPS	031 033 034 054 067 071 101	TMK	006
HITACHI	004 018 026 034 043 063 137 150	PILOT	101	TOSHIBA	008 013 042 047 059 082 112 131
INSTANTREPLAY	031 033	PIONEER	013 021 048	TOTEVISION	040 101
JCL	031 033	PORTLAND	108	UNITECH	040
JCPENNY	012 013 015 033 040 066 101	PULSAR	072	VECTOR RESEARCH	012
JENSEN	043	QUARTZ	011 014	VICTOR	048
JVC	012 031 033 043 048 050 055 060 130 150 152	QUASAR	033 066 075 145	VIDEO CONCEPTS	012 034 046
KENWOOD	014 034 039 043 047 048	RCA	013 020 033 034 040 041 062 063 107 109 140 144 145 147	VIDEOSONIC	040
LG (GOLDSTAR)	001 012 013 020 101 106 114 123	REALISTIC	003 008 010 014 031 033 034 040 053 054 101	WARDS	003 013 017 024 031 033 034 040 053 054 131
LLOYD	034	RICO	058	YAMAHA	012 034 039 043
LXI	003 009 013 014 017 034 101 106	RUNCO	148	ZENITH	034 048 056 058 072 080 101
MAGIN	040	SALORA	014		

Cable Box

Brand	Codes	Brand	Codes	Brand	Codes
ABC	003 004 039 042 046 052 053		074	REMBRANT	025
AJIN	112	LG (GOLDSTAR)	001 106 101 005	SAMSUNG	102 107 030 068
ANTRONIK	014	M-NET	037	SCIENTIFIC ATLANTA	003 011 041 042
ARCHER	005 007 014 024	MACOM	033		043 045 046
CABLE STAR	026	MAGNAVOX	010 012 064 079	SHERITECH	022
CENTURION	092	MEMOREX	100	SIGNAL	030
CENTURY	007	MOVIE TIME	028 032	SIGNATURE	052
CITIZEN	007	NSC	015 028 038 071	SL MARX	030
COLOUR VOICE	065 090		073	SPRUCER	047 078
COMBANO	080 081	OAK	016 031 037 053	STARCOM	002 004 008 009
COMTRONICS	019 030	PANASONIC	044 047	STARGATE	008 030
DIAMOND	023	PARAGON	100	TADIRAN	030
EAGLE	020 030 040			TAEKWANG	110
EASTERN	057 062 066	PHILIPS	006 012 013 020	TAIHAN	105
ELECTRICORD	032		065 085 090	TANDY	017
GE	072	PIONEER	034 051 052 063	TEXSCAN	029
GEMINI	008 022 025 054		076	TOCOM	039 040 056
GI	052 074	POST NEWS WEEK	016	TOSHIBA	100
GOLDEN CHANNEL	030	PRUCER	059	UNIKA	007 014 024
HAMLIN	049 050 055	PTS	011 048 071 072	UNITED CABLE	004 053
HITACHI	052 055		073 074	UNIVERSAL	005 007 014 024
HOSPITALITY	070 077	PULSAR	100		026 027 032 035
JERROLD	002 003 004 008 009 010 052 069	RCA	047	VIEWSTAR	012 015 018 086
		REGAL	049 050		087 088 089
		REGENCY	057	ZENITH	100 114 060 093

HDSTB

Brand	Codes	Brand	Codes	Brand	Codes
ALPHASTAR DSR	123	HOUSTON TRACKER	033 037 039 051	PROSAT	072
AMPLICA	050		057 104	RCA	066 106
BIRDVIEW	051 126 129	HUGHES	068	REALISTIC	043 074
CHANNEL MASTER	013 014 015 018 036 055	JANIEL	060 147	SAMSUNG	123
CHAPARRAL	008 009 012 077	JERROLD	061	SATELLITE SERVICE CO	028 035 047 057
CITOH	054	KATHREIN	108		085
CURTIS MATHES	050 145	LEGEND	057	SCIENTIFIC ATLANTA	032 138
DRAKE	005 006 007 010 011 052 112 116 141	LG	001	SONY	103
		LUTRON	132	STARCAST	041
DX ANTENNA	024 046 056 076	LUXOR	062 144	SUPER GUIDE	020 124 125
ECHOSTAR	038 040 057 058 093 094 095 096 097 098 099 100 122	MACOM	010 059 063 064 065	TEECOM	023 026 075 087 088 090 107 130 137
ELECTRO HOME	089	MEMOREX	057		
EUROPLUS	114	NEXTWAVE	028 124 125	TOSHIBA	002 127
FUJITSU	017 021 022 027 133 134	NORSAT	069 070	UNIDEN	016 025 042 043 044 045 048 049 078 079 080 086 101 135 136
GENERAL INSTRUMENT	003 004 016 029 031 059 101	PACE SKY SATELLITE	143		
		PANASONIC	060 142	VIEWSTAR	115
HITACHI	139 140	PANSAT	121	WINEGARD	128 146
		PERSONAL CABLE	117		
		PHILIPS	071	ZENITH	081 082 083 084 091 120
		PICO	105		
		PRESIDENT	019 102		
		PRIMESTAR	030 110 111		

APPENDIX

Audio

Brand	Codes	Brand	Codes	Brand	Codes
AIWA	014 028 070 096 125 129 139 229 230		157 158 159 160 189 207 222 224 225 226 227 243 247	RCX	092
AKAI	163			REALISTIC	103 106
ANAM	003 014 017 023 059 106 189 216 217 235 236	LOTTE	014 016 036 098 100 172 173 174 175 176 177 178 179 180 181 183 201 202 208 213 214 219 223 232 238 240	SAMSUNG	124 145 146 182 193 194 195 203 204 244 245 246
BURMECTER	252			SANSUI	011 135 138 144
CARVER	086			SANYO	019 083 234
CLARION	199			SCOTT	106 186
DAEWOO	027 053 060 084 102 148 198 221	LXI	103	SHARP	031 032 051 052 072 082 117 119 156 184 199 200 206 209
DENON	015 075 130 143	MAGNAVOX	111	SHERWOOD	005 006 158
FANTASIA	071	MARANTZ	002 018 020 025 034 041 081 090 097 112	SONY	044 045 109 114 118 126 248 249
FINEARTS	022			TAEKWANG	012 020 073 074 076 077 105 161 162 163 164 165 166 167 168 169 205 231 233 242
FISHER	089 099	MCINTOSH	049		
LG(GOLDSTAR)	001 021 024 029 087 107 108 110 190 191 192 210 211 212 239	MCS	104		
		MEMOREX	107		
		NAD	046		
HAITAI	034 035 188 222	ONKYO	013 040 041 047 048 056 057 132 133 140	TEAC	010 085 106 136 185 187 237
HARMAN/KARDON	068			TECHNICS	101 113 128 134 147 218
JVC	004 013 141	OPTIMUS	158	TOSHIBA	137
KEC	185 186 187	PANASONIC	007 033 064 113 142 220 241 251	THE	061
KOHEL	030	PENNEY	104	VICTOR	088 131
NAD	045 046	PHILIPS	026 112 143	WARDS	089
KENWOOD	038 050 067 089 170 171 197 206 215 222	PIONEER	039 042 043 063 065 091 093 094 115 123 127 250	YAMAHA	054 055 066 092 199
INKEL	037 058 062 069 078 079 095 121 122 149 150 151 152 153 154 155	QUASAR	113		
		RCA	080		

DVD

Brand	Codes	Brand	Codes	Brand	Codes
APEX DIGITAL	022	MITSUBISHI	002	RCA	005 006
DENON	020 014	NAD	023	SAMSUNG	011 015
GE	005 006	ONKYO	008 017	SONY	007
HARMAN KARDON	027	PANASONIC	003 009	THOMPSON	005 006
JVC	012	PHILIPS	013	TOSHIBA	019 008
LG	001 010 016 025	PIONEER	004 026	YAMAHA	009 018
MAGNAVOX	013	PROCEED	021	ZENITH	010 016 025
MARANTZ	024	PROSCAN	005 006		

IR CODES

1. How to Connect

- Connect your wired remote control to the Remote Control port on the TV.

2. Remote Control IR Codes

■ Output waveform

Single pulse, modulated with 37.917KHz signal at 455KHz

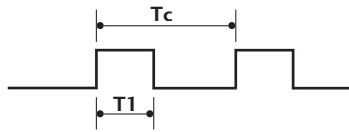

Carrier frequency
 $FCAR = 1/TC = fOSC/12$
 Duty ratio = $T1/TC = 1/3$

■ Configuration of frame

1st frame

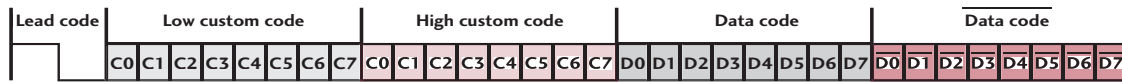

Repeat frame

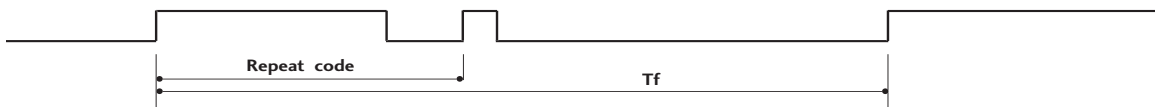

■ Lead code

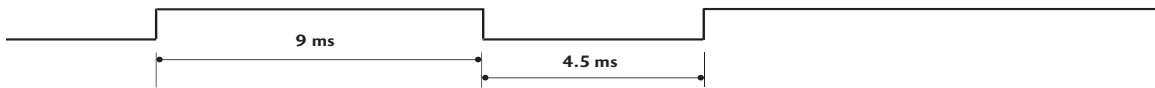

■ Repeat code

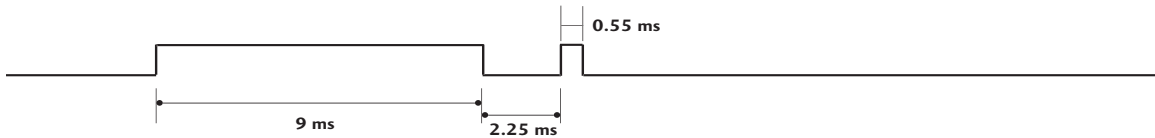

■ Bit description

Bit "0"

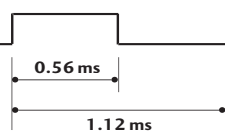

Bit "1"

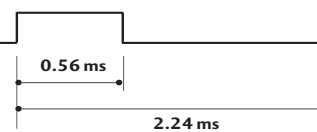

■ Frame interval: Tf

The waveform is transmitted as long as a key is depressed.

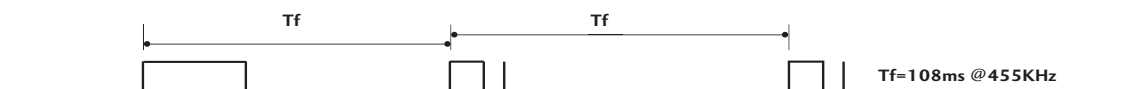

APPENDIX

Code (Hexa)	Function	Note	Code (Hexa)	Function	Note
0F	TV INPUT	Remote Control Button	BF	COMPONENT1	Discrete IR Code (Component1 Input Selection)
0B	INPUT	Remote Control Button			
08	POWER	Remote Control Button (Power On/Off)	D4	COMPONENT2	Discrete IR Code (Component2 Input Selection)
79	RATIO	Remote Control Button			
0E	TIMER	Remote Control Button	D5	RGB-PC	Discrete IR Code (RGB-PC Input Selection)
10-19	Number Key 0-9	Remote Control Button			
4C	- (Dash)	Remote Control Button	CE	HDMI1	Discrete IR Code (HDMI1 Input Selection)
1A	BACK	Remote Control Button			
09	MUTE	Remote Control Button	CC	HDMI2	Discrete IR Code (HDMI2 Input Selection)
02	VOL ▲	Remote Control Button			
03	VOL ▼	Remote Control Button	76	Ratio 4:3	Discrete IR Code (Only 4:3 Mode)
00	CH ▲	Remote Control Button			
01	CH ▼	Remote Control Button	77	Ratio 16:9	Discrete IR Code (Only 16:9 Mode)
1E	FAV	Remote Control Button			
39	CC	Remote Control Button	AF	Ratio Zoom	Discrete IR Code (Only Zoom1 Mode)
40	▲	Remote Control Button			
41	▼	Remote Control Button	C4	POWER ON	Discrete IR Code (Only Power On)
07	◀	Remote Control Button			
06	▶	Remote Control Button	C5	POWER OFF	Discrete IR Code (Only Power Off)
44	ENTER	Remote Control Button			
34	BRIGHT-	Remote Control Button	7C	MEDIA HOST	R/C Button
43	MENU	Remote Control Button	7D	MARK	R/C Button
33	BRIGHT+	Remote Control Button	CA	USB EJECT	R/C Button
52	SOUND	Remote Control Button			
4D	PICTURE	Remote Control Button			
5B	EXIT	Remote Control Button			
7E	SIMPLINK	Remote Control Button			
0A	SAP	Remote Control Button			
D6	TV	Discrete IR Code (TV Input Selection)			
5A	AV1	Discrete IR Code (AV1 Input Selection)			
D0	AV2	Discrete IR Code (AV2 Input Selection)			

EXTERNAL CONTROL THROUGH RS-232C

Connect the RS-232C (serial port) input jack to an external control device (such as a computer or an A/V control system) to control the product's functions externally.

Connect the serial port of the control device to the RS-232C jack on the product back panel.

Note: RS-232C connection cables are not supplied with the product.

RS-232C Setup

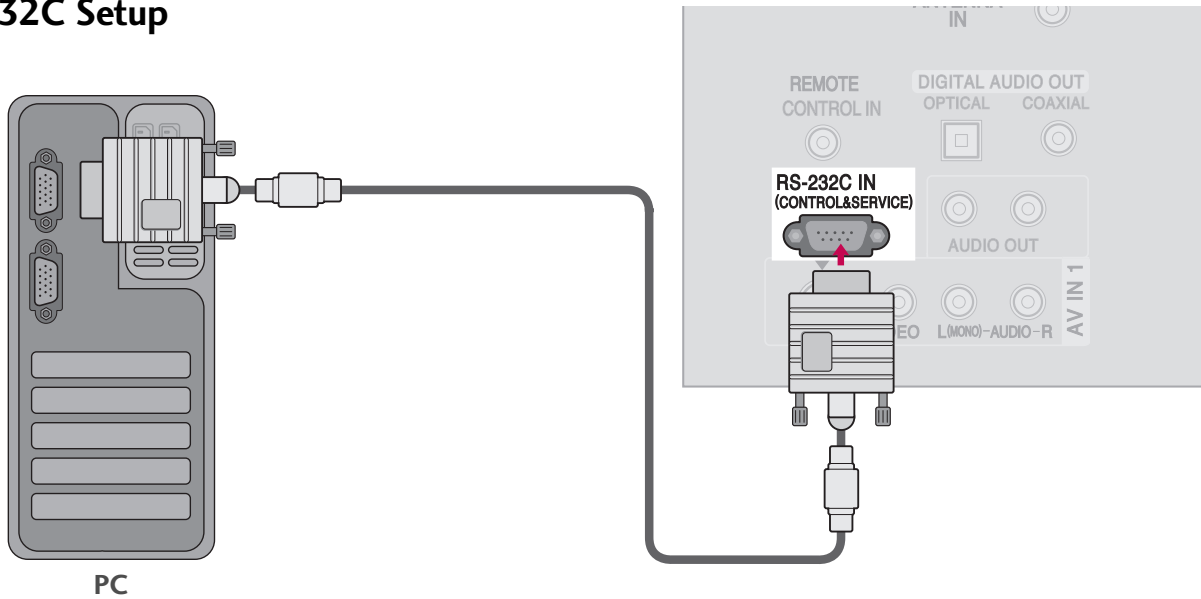

Type of Connector; D-Sub 9-Pin Male

No.	Pin Name
1	No connection
2	RXD (Receive data)
3	TXD (Transmit data)
4	DTR (DTE side ready)
5	GND
6	DSR (DCE side ready)
7	RTS (Ready to send)
8	CTS (Clear to send)
9	No Connection

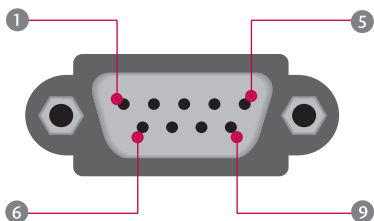

APPENDIX

RS-232C Configurations

7-Wire Configurations (Standard RS-232C cable)

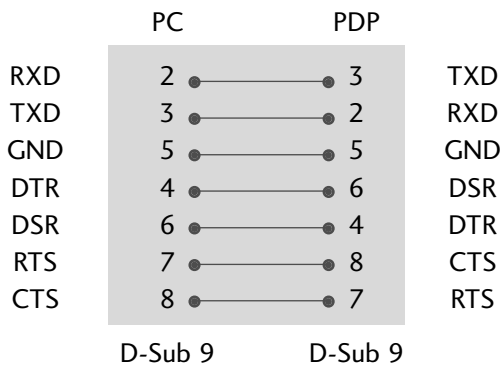

3-Wire Configurations (Not standard)

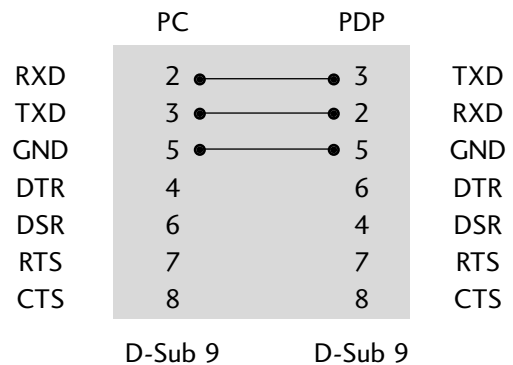

Set ID

Use this function to specify a TV ID number.
Refer to 'Real Data Mapping 1'. ▶ p.95

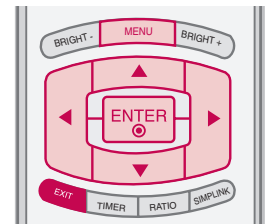

1 Press the **MENU** button and then use ▲ or ▼ button to select the **OPTION** menu.

2 Press the ► button and then use ▲ or ▼ button to select **SET ID**.

3 Press the ► button and then use ▲ or ▼ button to adjust **SET ID** to choose the desired TV ID number. The adjustment range of SET ID is 1~99.

4 Press **EXIT** button to return to TV viewing or press **MENU** button to return to the previous menu.



1

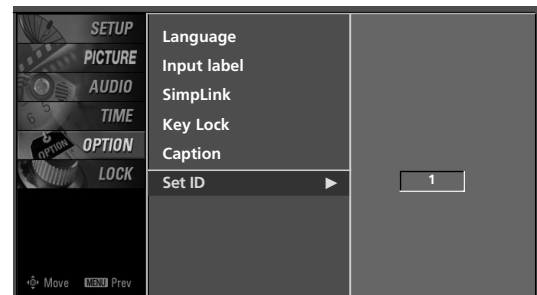

2 3

Communication Parameters

- Baud rate : 9600 bps (UART)
- Data length : 8 bits
- Parity : None
- Stop bit : 1 bit
- Communication code : ASCII code
- Use a crossed (reverse) cable.

! NOTE

This product has command echo back in the RS-232C Command.

Command Reference List

	COMMAND1	COMMAND2	DATA (Hexadecimal)		COMMAND1	COMMAND2	DATA (Hexadecimal)
01. Power	k	a	0 ~ 1	12. OSD Select	k	l	0 ~ 1
02. Input Select	k	b	0 ~ 9	13. Remote Control/ Key Lock	k	m	0 ~ 1
03. Aspect Ratio	k	c	*	14. Treble	k	r	0 ~ 64
04. Screen Mute	k	d	0 ~ 1	15. Bass	k	s	0 ~ 64
05. Volume Mute	k	e	0 ~ 1	16. Balance	k	t	0 ~ 64
06. Volume Control	k	f	0 ~ 64	17. Color Temperature	k	u	0 ~ 3
07. Contrast	k	g	0 ~ 64	18. Red adjustment	k	v	0 ~ C8
08. Brightness	k	h	0 ~ 64	19. Green adjustment	k	w	0 ~ C8
09. Color	k	i	0 ~ 64	20. Blue adjustment	k	\$	0 ~ C8
10. Tint	k	j	0 ~ 64				
11. Sharpness	k	k	0 ~ 64				

	COMMAND1	COMMAND2	DATA0 (Hexadecimal)	DATA1 (Hexadecimal)	DATA2 (Hexadecimal)	DATA3 (Hexadecimal)	DATA4 (Hexadecimal)	DATA5 (Hexadecimal)
21. Tune Command	m	a	physical program high	major program low	major low	minor high	minor low	attribute
22. Channel Add/Del	m	b	0~1					
23. Key	m	c	key code					
24. Input Select	x	b	*					
25. Back Light	m	g	0~64					

Transmission / Receiving Protocol

Transmission

[Command1][Command2][][Set ID][][Data][Cr]

[Command 1] : First command to control the set.(j, k, m or x)

[Command 2] : Second command to control the set.

[Set ID] : You can adjust the set ID to choose desired TV ID number in Setup menu. Adjustment range is 1 ~ 99. When selecting Set ID '0', every connected the TV is controlled. Set ID is indicated as decimal (1 ~ 99) on menu and as Hexa decimal (0x0 ~ 0x63) on transmission/receiving protocol.

[DATA] : To transmit command data.

Transmit 'FF' data to read status of command.

[Cr] : Carriage Return

ASCII code '0x0D'

[] : ASCII code 'space (0x20)'

*In this model, TV will not send the status during the standby mode.

OK Acknowledgement

[Command2][][Set ID][][OK][Data][x]

The TV transmits ACK (acknowledgement) based on this format when receiving normal data. At this time, if the data is data read mode, it indicates present status data. If the data is data write mode, it returns the data of the PC computer.

*in this model, TV will not send the status during the standby mode.

*data format

[command 2] : use as command.

[Set ID] : use the small character, if set ID is 10, it will send the '0','a'

[Data] : use the small character, if data is 0xab, it will send the 'a','b'

[OK] : use the large character

*in this model, TV will send the echo, CR, LF with ack message.

When it send the power on ack message, it will be like below.

Ex) ka 01 01 (CR)(LF)a 01 OK01x(CR)(LF)

Error Acknowledgement

[Command2][][Set ID][][NG][Data][x]

The TV transmits ACK (acknowledgement) based on this format when receiving abnormal data from non-viable functions or communication errors.

Data1: Illegal Code

Data2: Not supported function

Data3: Wait more time

*in this model, TV will not send the status during the standby mode.

*data format

[command 2] : use as command.

[Set ID] : use the small character, if set ID is 10, it will send the '0','a'

[Data] : use the small character, if data is 0xab, it will send the 'a','b'

[NG] : use the large character

*in this model, TV will send the echo, CR, LF with ack message.

When it send the power on ack message, it will be like below.

Ex) ka 01 01 (CR)(LF)a 01 NG01x(CR)(LF)

01. Power (Command2:a)

To control Power On/Off of the TV.

Transmission [k][a][] [Set ID][] [Data][Cr]

Data 0 : Power Off Data 1 : Power On

Acknowledgement [a][] [Set ID][] [OK/NG][Data][x]

* In a like manner, if other functions transmit 'FF' data based on this format, Acknowledgement data feedback presents status about each function.

* Note: In this model, TV will send the Acknowledge after power on processing completion.

There might be a time delay between command and acknowledge.

02. Input Select (Command2:b) (Main Picture Input)

To select input source for the TV.

Transmission [k][b][] [Set ID][] [Data][Cr]

Data 0: DTV Data 1: Analog

Data 2: AV1 Data 3: AV2

Data 4: Component 1 Data 5: Component 2

Data 6: RGB-PC Data 7: HDMI1

Data 8: HDMI2 Data 9: HDMI3

Acknowledgement [b][] [Set ID][] [OK/NG][Data][x]

03. Aspect Ratio (Command2:c) (Main picture format)

To adjust the screen format.

You can also adjust the screen format using the RATIO button on remote control or in the Picture menu.

Transmission [k][c][] [Set ID][] [Data][Cr]

Data 1: 4:3 4: Zoom 1

2: 16:9 5: Zoom 2

6: Set by program

⋮

Reserved

Acknowledgement [c][] [Set ID][] [OK/NG][Data][x]

04. Screen Mute (Command2:d)

To select screen mute on/off.

Transmission [k][d][] [Set ID][] [Data][Cr]

Data 0 : Screen mute off (Picture on)

Data 1 : Screen mute on (Picture off)

Acknowledgement [d][] [Set ID][] [OK/NG][Data][x]

05. Volume Mute (Command2:e)

To control volume mute on/off.

You can also adjust mute using the MUTE button on remote control.

Transmission [k][e][] [Set ID][] [Data][Cr]

Data 0 : Volume mute on (Volume off)

Data 1 : Volume mute off (Volume on)

Acknowledgement [e][] [Set ID][] [OK/NG][Data][x]

06. Volume Control (Command2:f)

To adjust volume.

You can also adjust volume with the volume buttons on remote control.

Transmission [k][f][] [Set ID][] [Data][Cr]

Data Min : 0 ~ Max : 64

Refer to 'Real data mapping 1' as shown below.

Acknowledgement [f][] [Set ID][] [OK/NG][Data][x]

07. Contrast (Command2:g)

To adjust screen contrast.

You can also adjust contrast in the Picture menu.

Transmission [k][g][] [Set ID][] [Data][Cr]

Data Min : 0 ~ Max : 64

*Refer to 'Real data mapping 1' as shown below.

Acknowledgement [g][] [Set ID][] [OK/NG][Data][x]

08. Brightness (Command2:h)

To adjust screen brightness.

You can also adjust brightness in the Picture menu.

Transmission [k][h][] [Set ID][] [Data][Cr]

Data Min : 0 ~ Max : 64 (*transmit by Hexadecimal code)

*Refer to 'Real data mapping 1' as shown below.

Acknowledgement [h][] [Set ID][] [OK/NG][Data][x]

*Real data mapping 1

0 : Step 0

⋮

A : Step 10 (SET ID 10)

⋮

F : Step 15 (SET ID 15)

10 : Step 16 (SET ID 16)

⋮

63 : Step 99 (SET ID 99)

64 : Step 100

09. Color (Command2:i)

To adjust the screen color.

You can also adjust color in the Picture menu.

Transmission [k][i][][Set ID][][Data][Cr]

Data Min : 0 ~ Max : 64

*Refer to 'Real data mapping 1'. See page 95.

Acknowledgement [i][][Set ID][][OK/NG][Data][x]

10. Tint (Command2:j)

To adjust the screen tint.

You can also adjust tint in the Picture menu.

Transmission [k][j][][Set ID][][Data][Cr]

Data Red : 0 ~ Green : 64

*Refer to 'Real data mapping 1'. See page 95.

Acknowledgement [j][][Set ID][][OK/NG][Data][x]

11. Sharpness (Command2:k)

To adjust the screen sharpness.

You can also adjust sharpness in the Picture menu.

Transmission [k][k][][Set ID][][Data][Cr]

Data Min: 0 ~ Max: 64

*Refer to 'Real data mapping 1'. See page 95.

Acknowledgement [k][][Set ID][][OK/NG][Data][x]

12. OSD Select (Command2:l)

To select OSD (On Screen Display) on/off.

Transmission [k][l][][Set ID][][Data][Cr]

Data 0: OSD off Data 1: OSD on

Acknowledgement [l][][Set ID][][OK/NG][Data][x]

13. Remote Control Lock Mode (Command2:m)

To lock the remote control and the front panel controls on the set.

Transmission [k][m][][Set ID][][Data][Cr]

Data 0: Lock off Data 1: Lock on

Acknowledgement [m][][Set ID][][OK/NG][Data][x]

If you're not using the remote control and front panel controls on the TV, use this mode. When main power is on/off, remote control lock is released.

14. Treble (Command2:r)

To adjust treble.

You can also adjust treble in the Audio menu.

Transmission [k][r][][Set ID][][Data][Cr]

Data Min: 0 ~ Max: 64(*transmit by Hexadecimal code)

*Refer to 'Real data mapping 1'. See page 95.

Acknowledgement [r][][Set ID][][OK/NG][Data][x]

15. Bass (Command2:s)

To adjust bass.

You can also adjust bass in the Audio menu.

Transmission [k][s][][Set ID][][Data][Cr]

Data Min: 0 ~ Max: 64(*transmit by Hexadecimal code)

*Refer to 'Real data mapping 1'. See page 95.

Acknowledgement [s][][Set ID][][OK/NG][Data][x]

16. Balance (Command2:t)

To adjust balance.

You can also adjust balance in the Audio menu.

Transmission [k][t][][Set ID][][Data][Cr]

Data Min: 0 ~ Max: 64(*transmit by Hexadecimal code)

*Refer to 'Real data mapping 1'. See page 95.

Acknowledgement [t][][Set ID][][OK/NG][Data][x]

17. Color Temperature (Command2:u)

To adjust color temperature.

You can also adjust color temperature in the Picture menu.

Transmission [k][u][][Set ID][][Data][Cr]

Data 0: Medium 1: Cool 2: Warm 3: User

Acknowledgement [u][][Set ID][][OK/NG][Data][x]

18. Red adjustment(Command:v)

To adjust red in color temperature

Transmission [k][v][][Set ID][][Data][Cr]

Data Min:0 ~ Max:C8

*Refer to "Real data mapping 2". See page 97.

Acknowledgement [v][][Set ID][][OK/NG][Data][x]

19. Green adjustment(Command:w)

To adjust green in color temperature.

Transmission [k][w][][Set ID][][Data][Cr]

Max:C8

*Refer to "Real data mapping 2". See page 97.

Acknowledgement [w][][Set ID][][OK/NG][Data][x]

20. Blue adjustment(Command:\$)

To adjust blue in color temperature.

```
Transmission [k][$][ ][Set ID][ ][Data][Cr]
```

Data Min:0 ~ Max:C8

*Refer to 'Real data mapping 2' as shown below.

```
Acknowledgement [$][ ][Set ID][ ][OK/NG][Data][x]
```

*Real data mapping 2

0 : -20

5 : -19

A : -18

⋮

5F: -1

64: 0

69: +1

⋮

C3 : +19

C8 : +20

21. Tune Command (Command: m a)

To tune channel to following physical/major/minor number.

```
Transmission [m][a][ ][Set ID][ ][Data0][ ][Data1][ ][Data2][ ][Data3][ ][Data4][ ][Data5][Cr]
```

Data 0: Physical Channel Number(Transmit by Hexadecimal code)

NTSC air:02~45

NTSC cable: 01, 0E~7D

ATSC air:01~45

ATSC cable:01~87

Data1,Data2: Major Channel Number (two part) /

Channel Number (One part)

Data1: High byte

Data2: Low byte

Two part channel number:

Major number-Minor number

One part channel number:

If the channel band is ATSC digital cable, it can be used. In case of using one part channel number, minor channel does not need.

Data3, Data 4: Minor Channel Number

Data3: High byte , Data4: Low byte

Data5:

7	Main/Sub Picture	6	Two/One Part Channel	5	Using Physical Channel	4	Reserved	3	2	1	0	Step
0	Main	0	Two	0	Use	x		0	0	0	0	NTSC Air
1	Sub	1	One	1	No Use	x		0	0	0	1	NTSC Cable
						x		0	0	1	0	ATSC Air
						x		0	0	1	1	ATSC Cable_std
						x		0	1	0	0	ATSC Cable_hrc
						x		0	1	0	1	ATSC Cable_irc
						x		0	1	1	0	ATSC cable_auto
						x		0	1	1	1	Reserved
						x		x	x	x	x	...
						x		1	1	1	1	Reserved

All data are transmitted by Hexadecimal code

* Two/One part Channel: 6th bit

This bit is used in a cable-ready system.

* Using physical channel: 5th bit

If the channel band is NTSC air or NTSC cable, channel tuning can be done by only physical channel. In this case, using physical channel bit must be low(0).

But if the channel band is ATSC air or ATSC cable, there are two cases that physical channel enable or disable.

If the physical channel sending is meaningful, you should set this bit low(0). If the physical channel sending is meaningless, you should set this bit high(1).

Example)

1. Analog channel: NTSC cable, channel number(35), main picture Command: ma 00 23 xx xx xx 01
attribute(0x01): main picture, two part(it's not mandatory), using physical channel, NTSC cable 'xx' data: don't care major and minor channel number in case analog channel tuning.
2. Digital channel: ATSC air, channel number(don't know physical channel, major(30), minor(3)), sub picture Command: ma 00 xx 00 1E 00 03 A2
attribute(0xA2): sub picture, two part, not using physical channel, ATSC air 'xx' data: don't care analog channel number in case digital channel tuning.
3. Digital channel: ATSC air, channel number(physical(20),major(20), minor(3)), sub picture Command: ma 00 14 00 14 00 03 82

attribute(0x82): sub picture, two part, using physical channel, ATSC air.

Acknowledgement [a][][Set ID][][OK][Data0][Data1][Data2][Data3][Data4][x][a][][Set ID][][NG][Data0][x]

22. Channel Add/Del (Command: m b)

To add and delete the channels

Transmission [m][b][][Set ID][][Data][Cr]

Data 0: Channel Delete Data 1: Channel Add

Acknowledgement [b][][Set ID][][OK/NG][Data][x]

23. Key (Command: m c)

To send IR remote key code.

Transmission [m][c][][Set ID][][Data][Cr]s

Data Key code: Refer to page 90.

Acknowledgement [c][][Set ID][][OK/NG][Data][x]

24. Input select(Command: x b) (Main Picture Input)

To select input source for TV.

Transmission [x][b][][Set ID][][Data][Cr]

Data 00 : DTV (Antenna) Data 01 : DTV (Cable)
Data 10 : Analog (Antenna) Data 11 : Analog (Cable)
Data 20 : AV1 Data 21 : AV2
Data 40 : Component 1 Data 41 : Component 2
Data 60 : RGB-PC Data 90 : HDMI1
Data 91 : HDMI2 Data 92 : HDMI3

Acknowledgement [b][][Set ID][][OK/NG][Data][x]

25. Back light(Command: m g)

To adjust screen back light.

Transmission [m][g][][Set ID][][Data][Cr]

Data Min:0 ~ Max:64

Acknowledgement [g][][Set ID][][OK/NG][Data][x]