

APPENDIX H  
: USER'S MANUAL



# LCD TV

## OWNER'S MANUAL

MODELS: 26LX1D | 32LX1D  
26LX2D | 32LX2D  
32LP1D | 37LP1D | 42LP1D



Internet Home Page : <http://www.lge.com>  
<http://www.lg.ca>

Please read this manual carefully before operating your set.  
Retain it for future reference.  
Record model number and serial number of the set.  
See the label attached on the back cover and quote  
this information to your dealer  
when you require service.



P/NO : 3828TUL309D (0503-REV00)  
Printed in Korea

# Warning

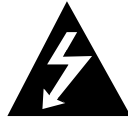

**CAUTION**  
RISK OF ELECTRIC SHOCK  
DO NOT OPEN



## WARNING:

TO REDUCE THE RISK OF ELECTRIC SHOCK DO NOT REMOVE COVER (OR BACK). NO USER SERVICEABLE PARTS INSIDE. REFER TO QUALIFIED SERVICE PERSONNEL.



The lightning flash with arrowhead symbol, within an equilateral triangle, is intended to alert the user to the presence of uninsulated "dangerous voltage" within the product's enclosure that may be of sufficient magnitude to constitute a risk of electric shock to persons.



The exclamation point within an equilateral triangle is intended to alert the user to the presence of important operating and maintenance (servicing) instructions in the literature accompanying the appliance.

## NOTE TO CABLE/TV INSTALLER:

This reminder is provided to call the CATV system installer's attention to Article 820-40 of the National Electric Code (U.S.A.). The code provides guidelines for proper grounding and, in particular, specifies that the cable ground shall be connected to the grounding system of the building, as close to the point of the cable entry as practical.

## REGULATORY INFORMATION

This equipment has been tested and found to comply with the limits for a Class B digital device, pursuant to Part 15 of the FCC Rules. These limits are designed to provide reasonable protection against harmful interference in a residential installation. This equipment generates, uses and can radiate radio frequency energy and, if not installed and used in accordance with the instructions, may cause harmful interference to radio communications. However, there is no guarantee that interference will not occur in a particular installation. If this equipment does cause harmful interference to radio or television reception, which can be determined by turning the equipment off and on, the user is encouraged to try to correct the interference by one or more of the following measures:

- Reorient or relocate the receiving antenna.
- Increase the separation between the equipment and receiver.
- Connect the equipment into an outlet on a circuit different from that to which the receiver is connected.
- Consult the dealer or an experienced radio/TV technician for help.

Any changes or modifications not expressly approved by the party responsible for compliance could void the user's authority to operate the equipment.

## CAUTION:

Do not attempt to modify this product in any way without written authorization from LG Electronics Corporation. Unauthorized modification could void the user's authority to operate this product.

## U.S.A. only -----

### COMPLIANCE:

The responsible party for this product's compliance is:  
LG Electronics U.S.A., Inc.  
1000 Sylvan Avenue, Englewood Cliffs, NJ 07632  
Phone: 1-201-816-2000  
<http://www.lgusa.com>

-----

## Controls (Model Name: 32/37/42LP1D)

- This is a simplified representation of front panel.
- Here shown may be somewhat different from your TV.

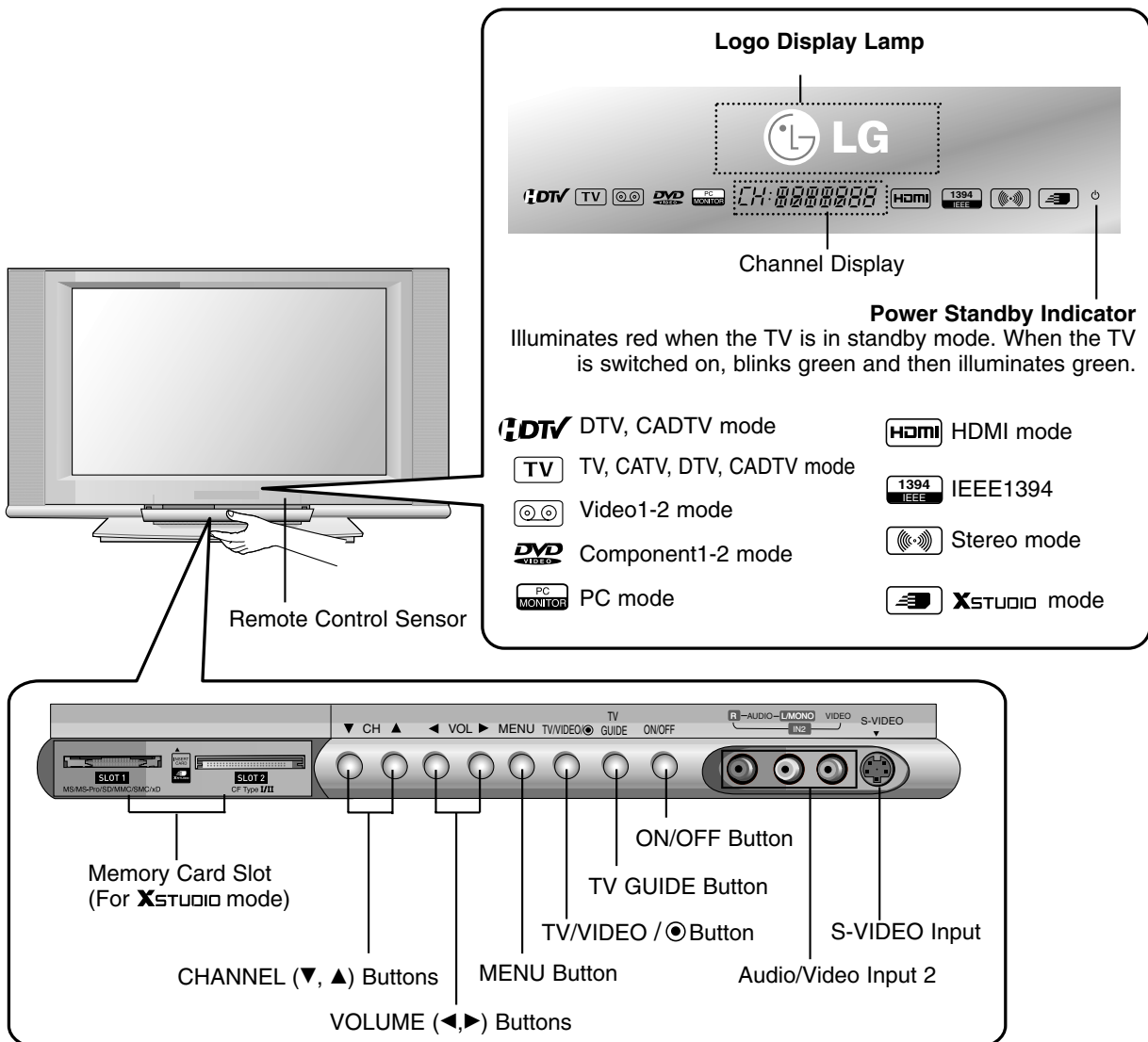

# Connection Options (Model Name: 32/37/42LP1D)

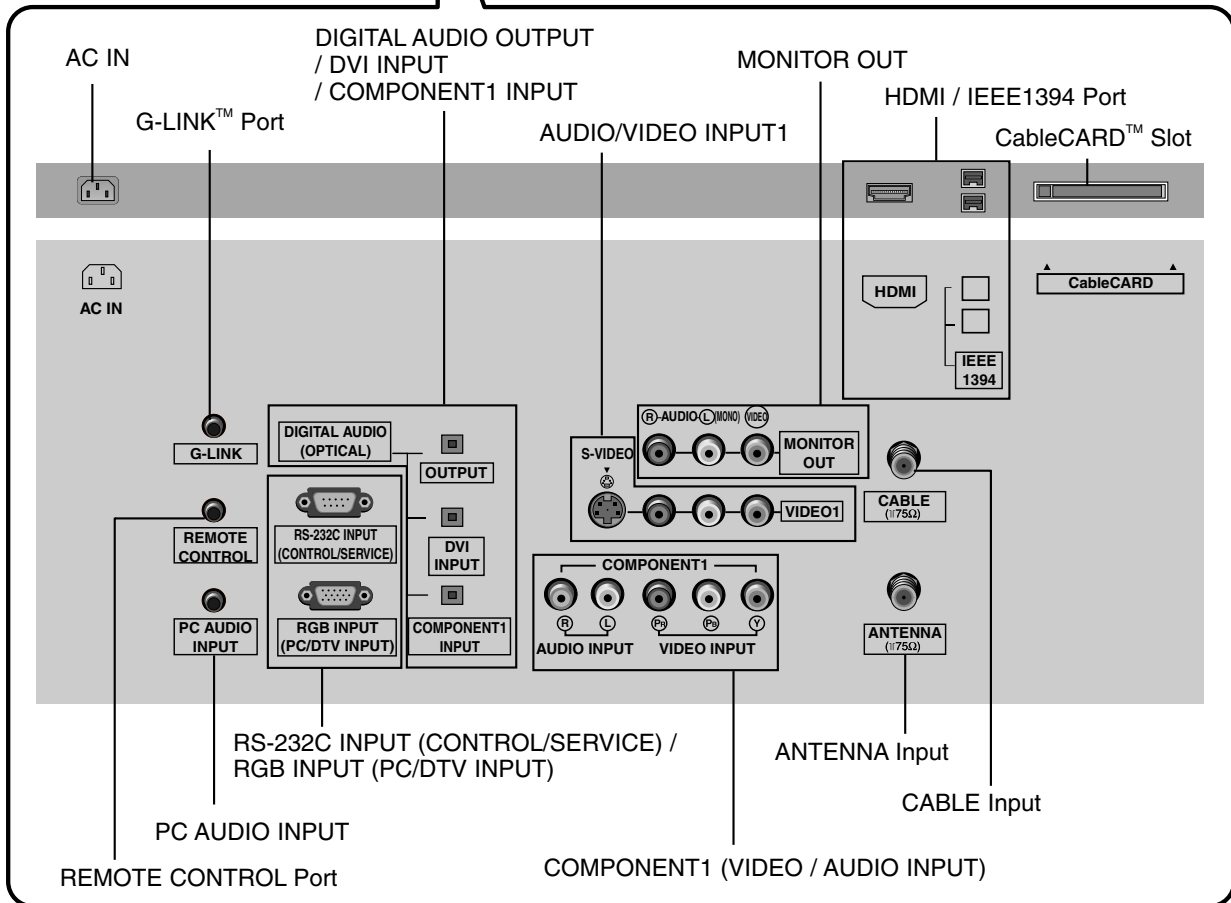
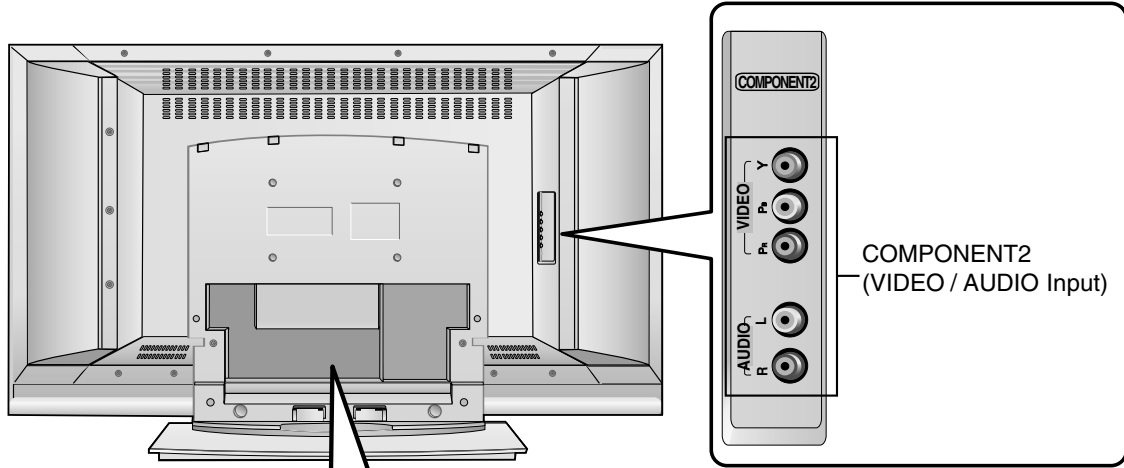

\* The HDMI port can receive video via High-Definition Multimedia Interface (HDMI) or the Digital Visual Interface (DVI). Note: An adapter or special cable is required to plug DVI into an HDMI port (available at home theater or computer stores).

# External Equipment Connections

## Antenna or Cable Connection

### Analog and Digital TV signals provided on antenna

- Antenna or Cable Service without a Cable Box Connection.
- For optimum picture quality, adjust antenna direction if needed.

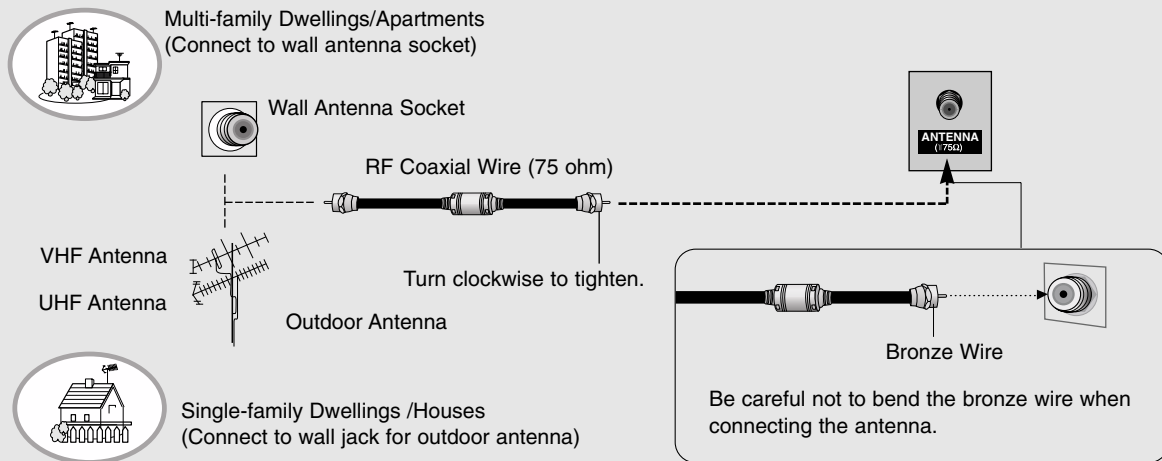

### Analog and Digital TV signals provided on cable

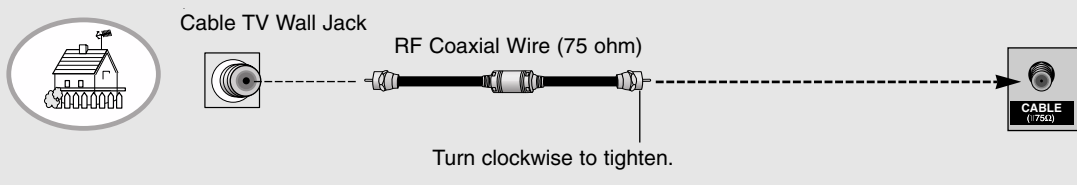

### Analog and Digital TV signals provided on cable and antenna

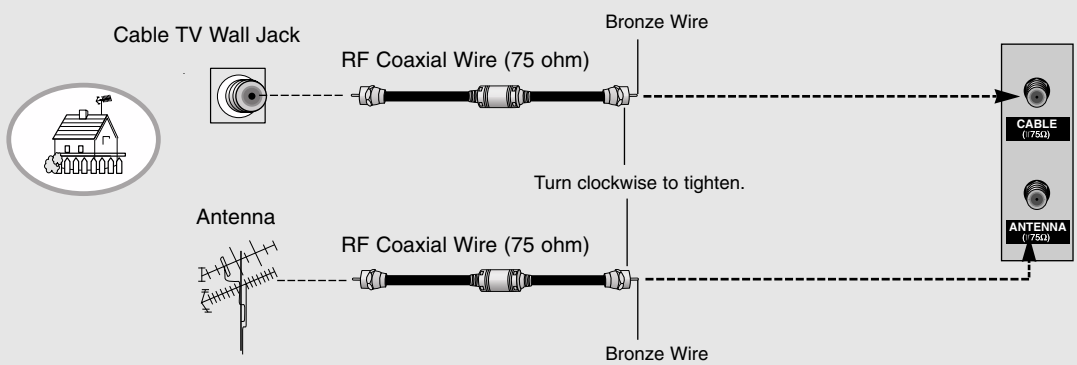

ANTENNA (175ohm)

VHF UHF

signal amplifier

CABLE (175ohm)

- In a poor signal area to improve picture quality, purchase and install a signal amplifier.
- If the antenna needs to be split for two TV's, install a "2-Way Signal Splitter" in the connections.
- If the antenna is not installed properly, contact your dealer for assistance.

**NOTE: All cables shown are not included with the TV.**

## VCR Setup

- To avoid picture noise (interference), leave an adequate distance between the VCR and TV.
- Typically a frozen still picture from a VCR. If the 4:3 picture format is used; the fixed images on the sides of the screen may remain visible on the screen.

### When connecting with an antenna

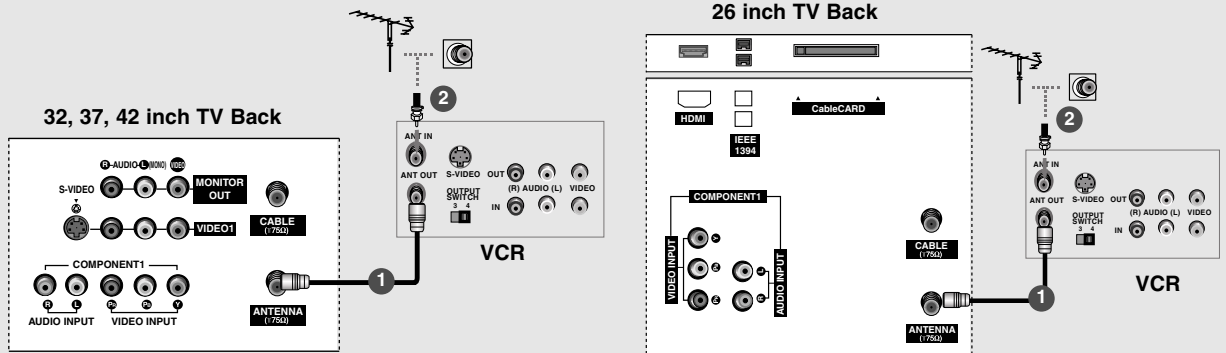

- 1 Connect the RF antenna out socket of the VCR to the **Antenna** socket on the set.
- 2 Connect the antenna cable to the RF antenna in socket of the VCR.
- 3 Set VCR output switch to 3 or 4 and then tune TV to the same channel number.
- 4 Insert a video tape into the VCR and press PLAY on the VCR. (Refer to the VCR owner's manual.)

### When connecting with a RCA cable

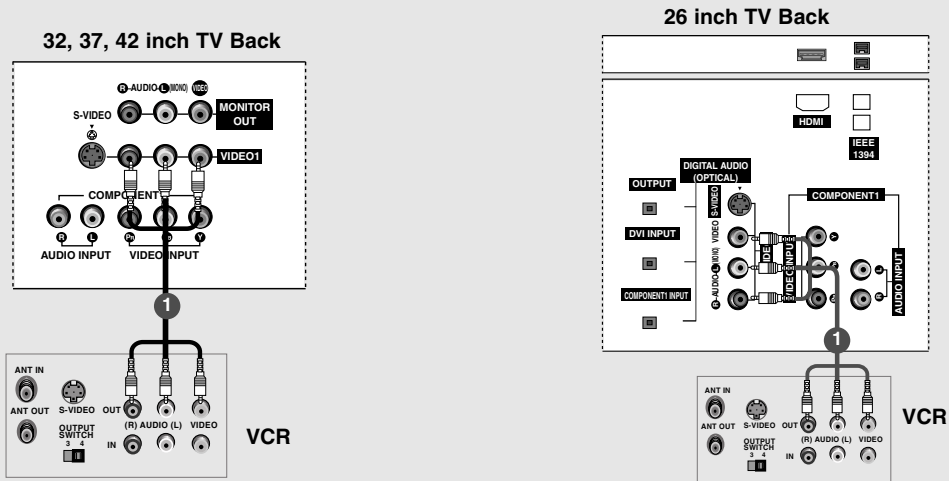

- 1 Connect the **AUDIO/VIDEO** jacks between TV and VCR. Match the jack colors (Video = yellow, Audio Left = white, and Audio Right = red)
- 2 Insert a video tape into the VCR and press PLAY on the VCR. (Refer to the VCR owner's manual.)
- 3 Select **Video1** input source using the **TV/VIDEO** button on the remote control.
  - If connected to IN2 (or VIDEO2), select **Video2** input source.



- If you have a mono VCR, connect the audio cable from the VCR to the **AUDIO L/MONO** jack of the set.

**NOTE: All cables shown are not included with the TV**

## DVD Setup

### When connecting with a S-Video cable

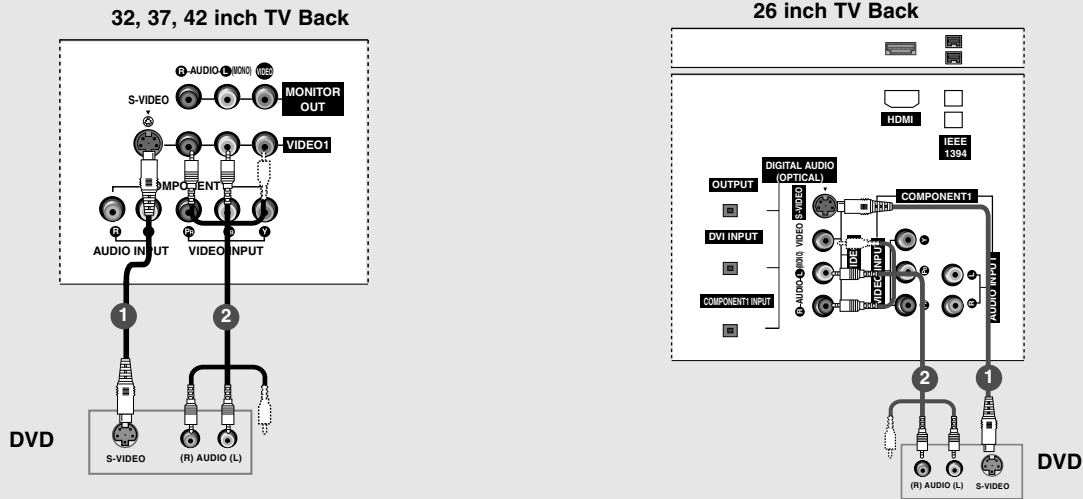

- 1 Connect the S-VIDEO output of the DVD to the **S-VIDEO** input on the set.
- 2 Connect the audio outputs of the DVD to the **AUDIO** input jacks on the set.
- 3 Turn on the DVD player, insert a DVD.
- 4 Select **Video1** input source with using the **TV/VIDEO** button on the remote control.  
- If connected to **IN2** (or **VIDEO2**), select **Video 2** input source.
- 5 Refer to the DVD player's manual for operating instructions.

### When connecting with a HDMI cable

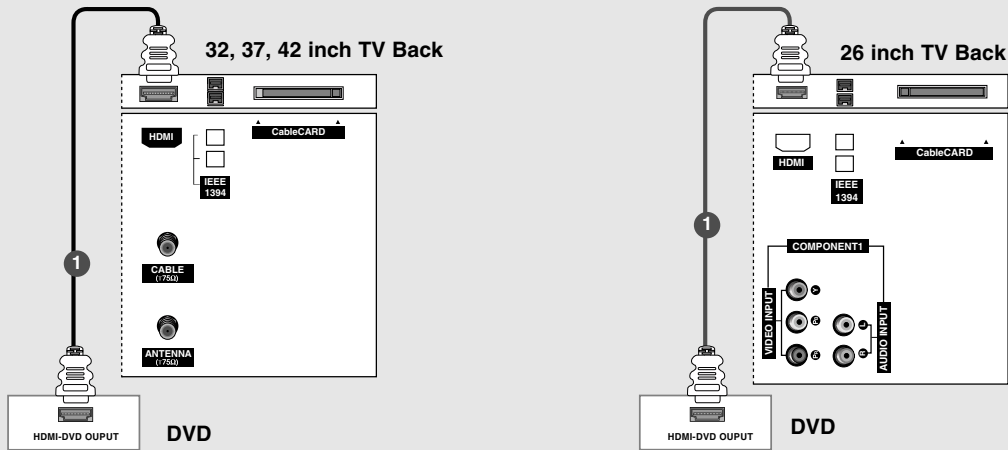

- 1 Connect the HDMI output of the DVD to the **HDMI** jack on the set.
- 2 Select **HDMI** input source with using the **TV/VIDEO** button on the remote control.
- 3 Refer to the DVD player's manual for operating instructions.

TV can receive the video and audio signal simultaneously with using a HDMI cable.

- If the DVD supports Auto HDMI function, the DVD output resolution will be automatically set to 1280x720p.
- If the DVD does not support Auto HDMI, you need to set the output resolution appropriately. To get the best picture quality, adjust the output resolution of the DVD to 1280x720p.



**When connecting with a component cable**

**32, 37, 42 inch TV Back**

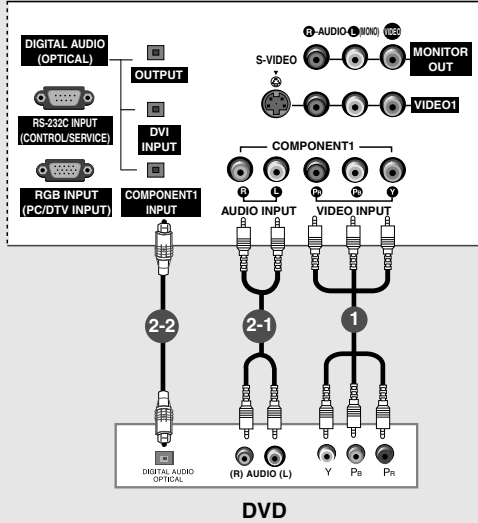

**26 inch TV Back**

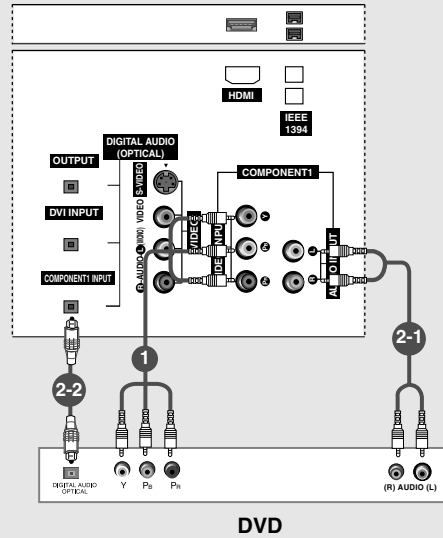

Select **2-1** or **2-2**, depending on your DVD connector.

- 1 Connect the video outputs (Y, P<sub>B</sub>, P<sub>R</sub>) of the DVD to the **COMPONENT1 VIDEO INPUT** jacks on the set.
- 2-1 Connect the audio outputs of the DVD to the **COMPONENT1 AUDIO INPUT** jacks on the set.
- 2-2 Connect the optical audio output of the DVD to the **DIGITAL AUDIO COMPONENT1 INPUT** jack on the set.
- 3 Turn on the DVD player, insert a DVD.
- 4 Select **Component 1** input source with using the **TV/VIDEO** button on the remote control.  
- If connected to COMPONENT2 input, select **Component 2** input source.
- 5 Refer to the DVD player's manual for operating instructions.



**Component Input ports**

To get better picture quality, connect a DVD player to the component input ports as shown below.

Component ports on the TV	Y	P <sub>B</sub>	P <sub>R</sub>
Video output ports on DVD player	Y	P <sub>b</sub>	P <sub>r</sub>
	Y	B-Y	R-Y
	Y	Cb	Cr
	Y	P <sub>B</sub>	P <sub>R</sub>

- Digital Audio will not work for Component 2 input source.
- Digital Audio operation has priority if Digital Audio and AUDIO L/R are connected at the same time.

## HDSTB Setup

- This TV can receive Digital Over-the-air/Cable signals without an external digital set-top box. However, if you do receive Digital signals from a digital set-top box or other digital external device, refer to the figure as shown below.

### When connecting with a D-sub 15 pin cable

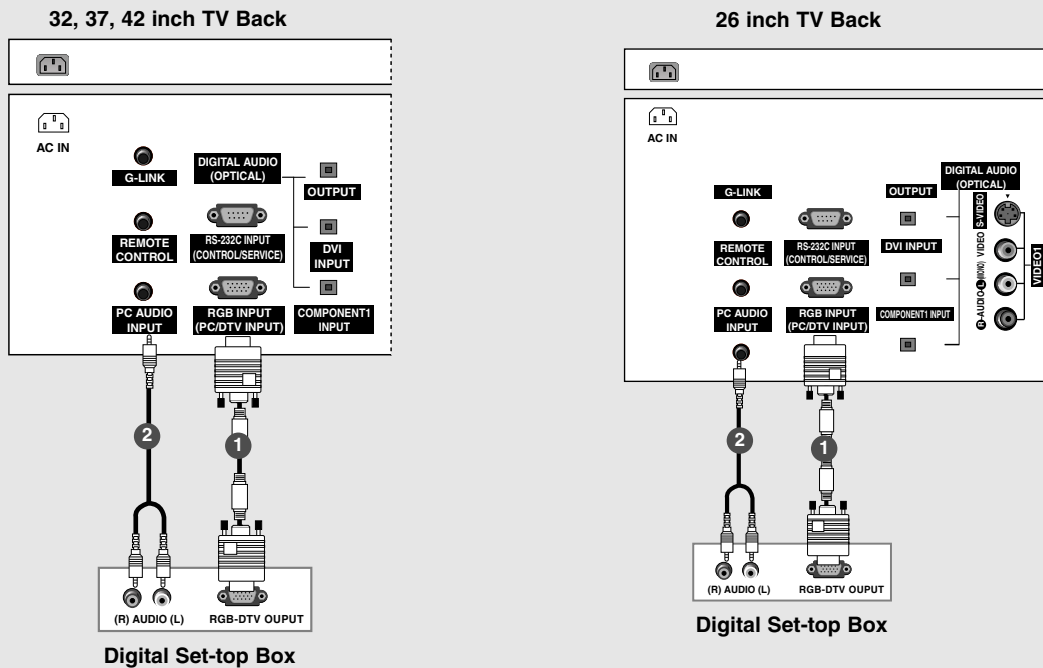

- 1 Connect the RGB output of the digital set-top box to the **RGB INPUT (PC/DTV INPUT)** jack on the set.
- 2 Connect the audio outputs of the set-top box to the **PC AUDIO INPUT** jack on the set.
- 3 Turn on the digital set-top box. (Refer to the owner's manual for the digital set-top box.)
- 4 Select **RGB-DTV** input source with using the **TV/VIDEO** button on the remote control.

When connecting with a HDMI cable

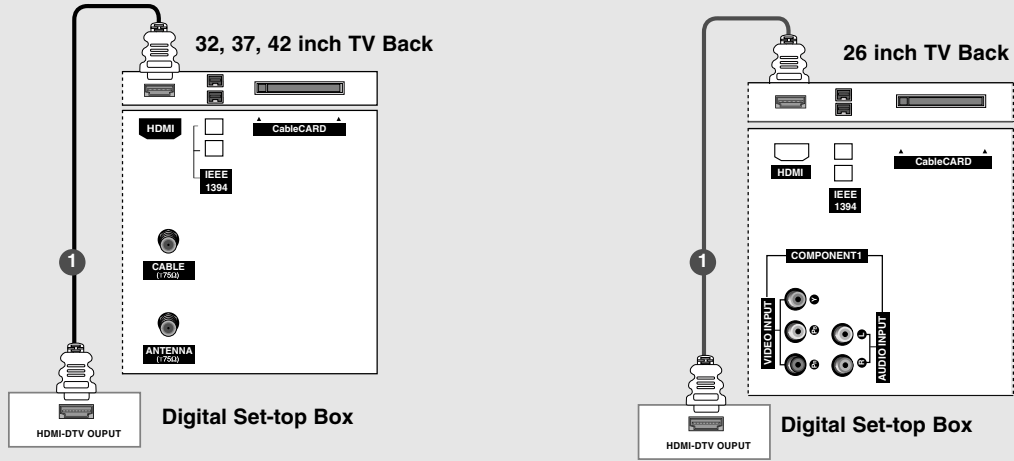

- 1 Connect the HDMI output of the digital set-top box to the **HDMI** jack on the set.
- 2 Select **HDMI/DVI** input source with using the **TV/VIDEO** button on the remote control.
- 3 Turn on the digital set-top box. (Refer to the owner's manual for the digital set-top box.)



- TV can receive the video and audio signal simultaneously with using a HDMI cable.
- If the digital set-top box supports Auto HDMI function, output resolution of the digital set-top box will be automatically set to 1280x720p.
- If the digital set-top box does not support Auto HDMI, you need to set the output resolution appropriately. To get the best picture quality, adjust the output resolution of the digital set-top box to 1280x720p.

## When connecting with a HDMI to DVI cable

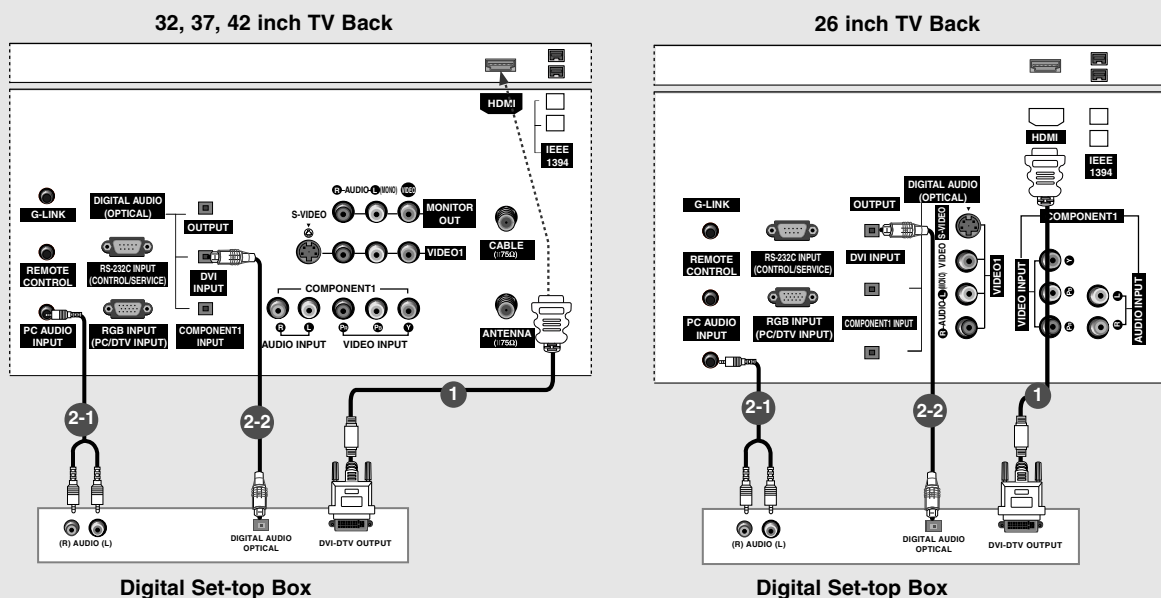

Select **2-1** or **2-2**, depending on your digital set-top box connector.

- 1** Connect the DVI output of the digital set-top box to the **HDMI** jack on the set.
- 2-1** Connect the audio output of the digital set-top box to the **PC AUDIO INPUT** jack on the set.
- 2-2** Connect the optical audio output of the digital set-top box to the **DIGITAL AUDIO DVI INPUT** jack on the set.
- 4** Turn on the digital set-top box. (Refer to the owner's manual for the digital set-top box.)
- 5** Select **HDMI/DVI** input source with using the **TV/VIDEO** button on the remote control.



- If the digital set-top box has a DVI output and no HDMI output, a separated audio connection is necessary.
- If the digital set-top box supports Auto DVI function, the output resolution of the digital set-top box will be automatically set to 1280x720p.
- If the digital set-top box does not support Auto DVI, you need to set the output resolution appropriately. To get the best picture quality, adjust the output resolution of the digital set-top box to 1280x720p.

## External AV Source Setup

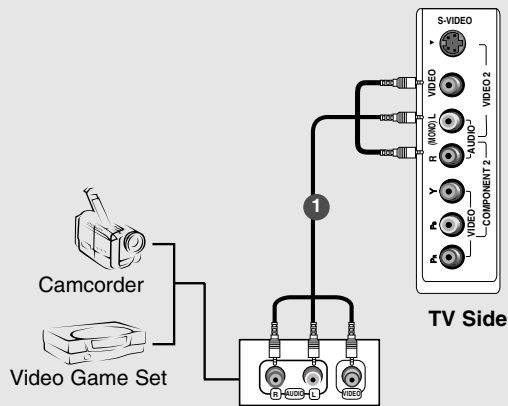

- 1 Connect the **AUDIO/VIDEO** jacks between TV and external equipment. Match the jack colors (Video = yellow, Audio Left = white, and Audio Right = red).
- 2 Select **Video2** input source with using the **TV/VIDEO** button on the remote control.  
- If connected to VIDEO1 input, select **Video1** input source.
- 3 Operate the corresponding external equipment. Refer to external equipment operating guide. For connection instructions to operate the TV Guide On Screen system, see page 42~43.

## Digital Audio Output

- Send the TV's audio to external audio equipment (stereo system) via the Digital Audio Output Optical port.

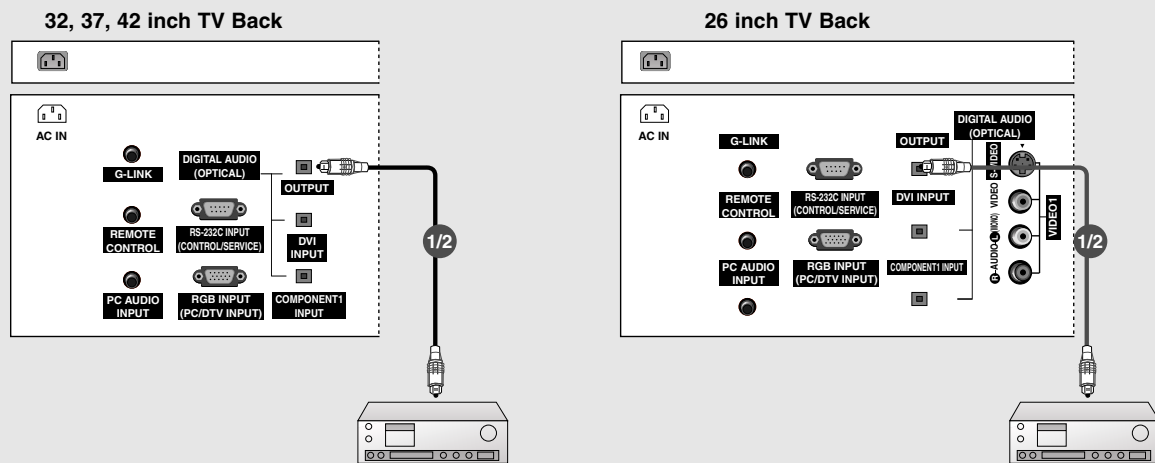

- 1 Connect one end of an optical cable to the TV Digital Audio Optical Output port.
- 2 Connect the other end of the optical cable to the digital audio optical input on the audio equipment.
- 3 See the external audio equipment instruction manual for operation. When connecting with external audio equipments, such as amplifiers or speakers, please turn the TV speakers off.(Refer to p.80)



### CAUTION

Do not look into the optical output port. Looking at the laser beam may damage your vision.

## Monitor Out Setup (32LX1D/2D, 32/37/42LP1D only)

- The TV has a special signal output capability which allows you to hook up a second TV or monitor.

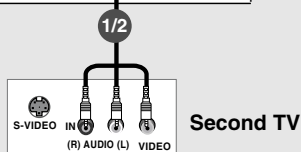
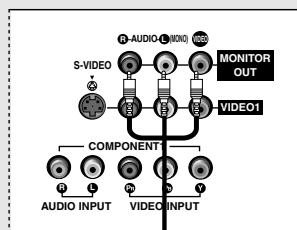

- 1 Connect the second TV or monitor to the TV's **MONITOR OUTPUT** jacks.
- 2 See the Operating Manual of the second TV or monitor for further details regarding that device's input settings.



- Component 1/2 input sources can be used for Monitor out.
- When connecting with external audio equipments, such as amplifiers or speakers, please turn the TV speakers off. (Refer to p.80)

## CableCARD™ Setup

32, 37, 42 inch TV Back

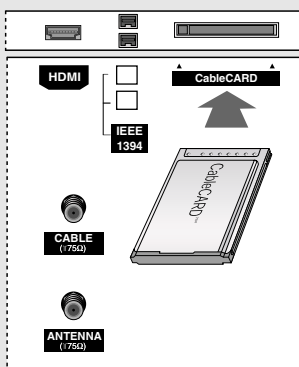

26 inch TV Back

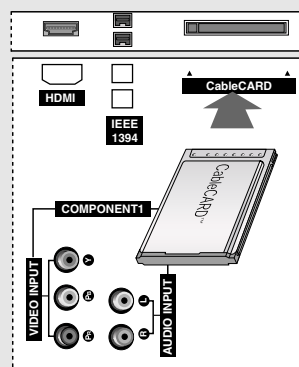

- To view the premium stations

Insert the CableCARD™ received from Cable Service provider to **CableCARD** slot of TV as shown. If the pairing information about this TV and the CableCARD is automatically displayed on the screen, contact with Cable service provider by phone.



**Caution:**

When removing the CableCARD™, do not drop it as this may cause damage to the card.



- Different card types can be used with this unit (Motorola, Scientific Atlanta, SCM, etc.).

## PC Setup

- This TV provides Plug and Play capability, meaning that the PC adjusts automatically to the TV's settings. The TV sends configuration information (EDID) to the PC using the Video Electronics Standard Association (VESA) Display Data Channel (DDC) protocol.

### When connecting with a D-sub 15 pin cable

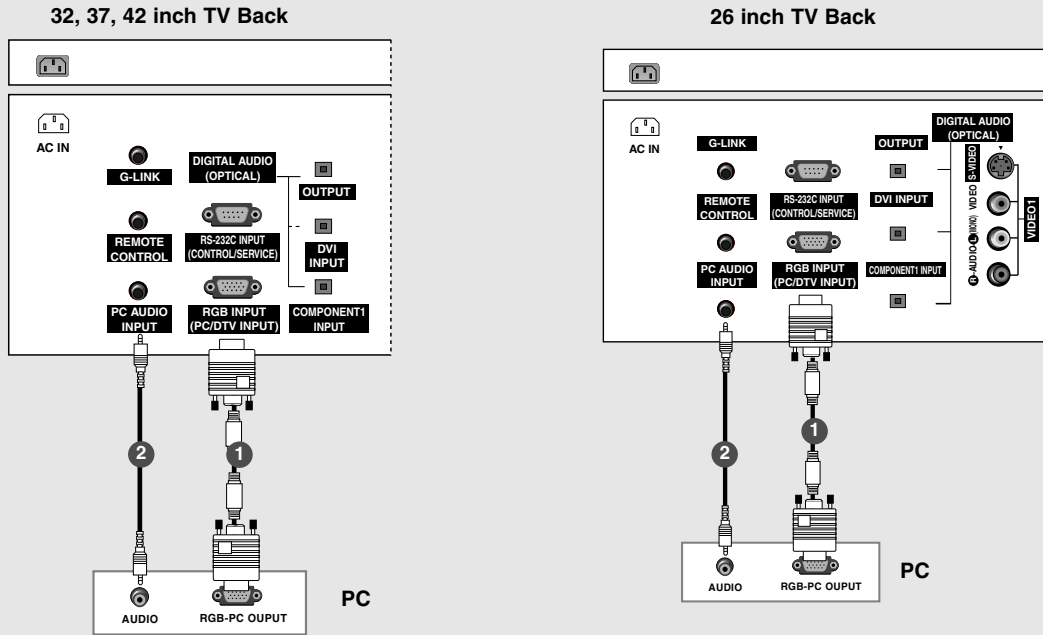

- 1 Connect the RGB output of the PC to the **RGB INPUT (PC/DTV INPUT)** jack on the set.
- 2 Connect the PC audio output to the **PC AUDIO INPUT** jack on the set.
- 3 Turn on the PC and the set.
- 4 Select **RGB-PC** input source with using the **TV/VIDEO** button on the remote control.

### When connecting with a HDMI to DVI cable

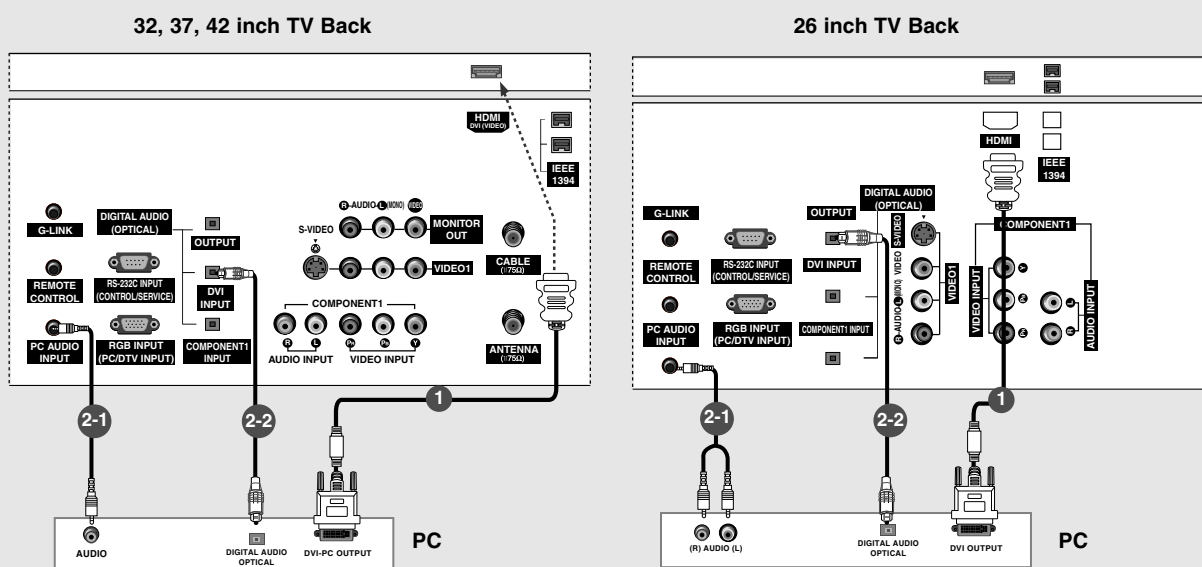

Select **2-1** or **2-2**, depending on your PC connector.

- 1** Connect the DVI output of the PC to the **HDMI** jack on the set.
- 2-1** Connect the PC audio output to the **PC AUDIO INPUT** jack on the set.
- 2-2** Connect the PC optical audio output to the **DIGITAL AUDIO DVI INPUT** jack on the set.
- 3** Turn on the PC and the set.
- 4** Select **HDMI/DVI** input source with using the **TV/VIDEO** button on the remote control.



- If the PC has a DVI output and no HDMI output, a separated audio connection is necessary.
- If the PC supports Auto DVI function, the output resolution of the PC will be automatically set to 1280x720p.
- If the PC does not support Auto DVI, you need to set the output resolution appropriately. To get the best picture quality, adjust the output resolution of PC graphics card's output resolution to 1024x768, 60Hz.





1. To get the best picture quality, adjust the PC graphics card to 1024x768, 60Hz.
2. If the graphic card on the PC does not output analog and digital RGB simultaneously, connect only one of either PC INPUT or DVI INPUT to display the PC on the TV.  
If the graphic card on the PC does output analog and digital RGB simultaneously, set the TV to either RGB or DVI; (the other mode is set to Plug and Play automatically by the TV.)
3. If using a sound card, adjust the PC sound as required.
4. Depending on the graphics card, DOS mode may not work if a HDMI to DVI Cable is in use.
5. When Source Devices connected with HDMI1/DVI Input, output PC Resolution (VGA, SVGA, XGA), Position and Size may not fit to Screen. Press the ADJUST button to adjust the screen Position of TV SET and contact an PC graphics card service center.
6. When Source Devices connected with HDMI1/DVI Input, output TV SET Resolution (480p, 720p, 1080i) and TV SET Display fit EIA/CEA-861-B Specification to Screen. If not, refer to the Manual of HDMI1/DVI Source Devices or contact your service center.
7. In case HDMI/DVI Source Devices is not connected Cable or poor cable connection, "NO SIGNAL" OSD display in HDMI1/DVI Input. In case that Video Resolution is not supported TV SET output in HDMI1/DVI Source Devices, "INVALID FORMAT" OSDdisplay. Refer to the Manual of HDMI1/DVI Source Devices or contact your service center.
8. Check the image on your TV. There may be noise associated with the resolution, vertical pattern, contrast or brightness in PC, HDMI/DVI mode. If noise is present, change the PC or HDMI/DVI mode to another resolution, change the refresh rate to another rate or adjust the brightness and contrast on the menu until the picture is clear. If the refresh rate of the PC graphic card can not be changed, change the PC graphic card or consult the manufacturer of the PC graphic card.
9. Avoid keeping a fixed image on the TV's screen for a long period of time. The fixed image may become permanently imprinted on the screen.
10. The synchronization input form for Horizontal and Vertical frequencies is separate.

**Supported Display Resolution  
(RGB-PC, HDMI/DVI Mode)**

Resolution	Horizontal Frequency (kHz)	Vertical Frequency (Hz)
640x350	31.468	70.09
	37.861	85.08
720x400	31.469	70.08
	37.927	85.03
640x480	31.469	59.94
	37.861	72.80
	37.500	75.00
800x600	35.156	56.25
	37.879	60.31
	48.077	72.18
	46.875	75.00
1024x768	48.363	60.00
	56.476	70.06
	60.023	75.02

**Supported Display Resolution  
(RGB-DTV, HDMI/DVI Mode)**

Resolution	Horizontal Frequency (kHz)	Vertical Frequency (Hz)
1280x720p	45	60
1920x1080i	67.5	60
720x480p	31.5	60

# External Control Device Setup

- Connect the RS-232C input jack to an external control device (such as a computer or an A/V control system) and control the Monitor's functions externally.
- Connect the serial port of the control device to the RS-232C jack on the TV back panel.
- RS-232C connection cables are not supplied with the TV.

## RS-232C Setup

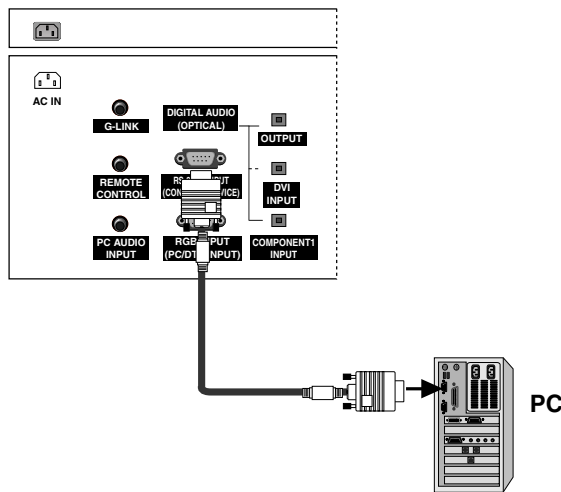

### Type of Connector; D-Sub 9-Pin Male

No.	Pin Name
1	No connection
2	RXD (Receive data)
3	TXD (Transmit data)
4	DTR (DTE side ready)
5	GND
6	DSR (DCE side ready)
7	RTS (Ready to send)
8	CTS (Clear to send)
9	No Connection

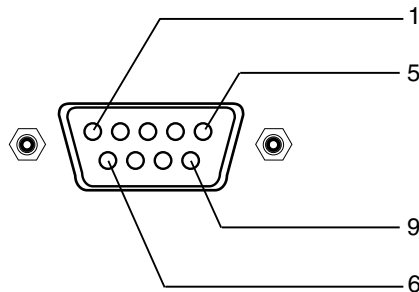

### RS-232C Configurations

#### 7-Wire Configurations (Serial female-female NULL modem cable)

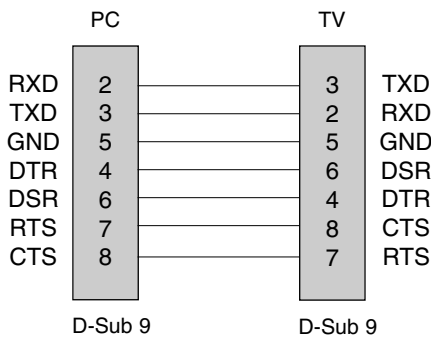

#### 3-Wire Configurations (Not standard)

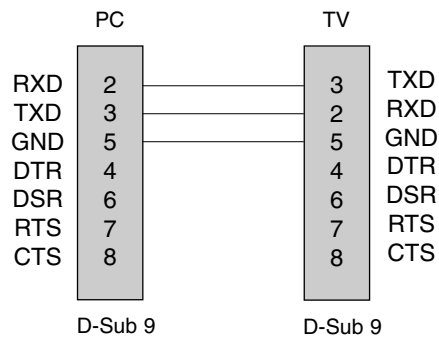

# Maintenance

- Early malfunctions can be prevented. Careful and regular cleaning can extend the amount of time you will have your new TV. Be sure to turn the power off and unplug the power cord before you begin any cleaning.

## Cleaning the Screen

1. Here's a great way to keep the dust off your screen for a while. Wet a soft cloth in a mixture of lukewarm water and a little fabric softener or dish washing detergent. Wring the cloth until it's almost dry, and then use it to wipe the screen.
2. Make sure the excess water is off the screen, and then let it air-dry before you turn on your TV.

## Cleaning the Cabinet

To remove dirt or dust, wipe the cabinet with a soft, dry, lint-free cloth. Please be sure not to use a wet cloth.

## Extended Absence



If you expect to leave your TV dormant for a long time (such as a vacation), it's a good idea to unplug the power cord to protect against possible damage from lightning or power surges.

# Product Specifications

MODEL	26LX1D	26LX2D	32LX1D	32LX2D
Width (inches / mm)	31 / 787.7	31 / 787.7	36.3 / 922	36.3 / 922
Height (inches / mm)	20 / 510	19.2 / 487	23.6 / 599.7	24.1 / 613.4
Depth (inches / mm)	7.6 / 193.4	10 / 253	8.6 / 218.5	11.3 / 287.5
Weight (pounds / kg)	41.2 / 18.7	40 / 18.1	54 / 24.5	56.2 / 25.2
Power requirement	AC 100-240V~ 50/60Hz 1.5A		AC 100-240V~ 50/60Hz 2.0A	
Television System	NTSC-M, ATSC			
Program Coverage	VHF 2 ~ 13, UHF 14 ~ 69, CATV 1 ~ 135, CADTV 1 ~ 135, DTV 2 ~ 69			
External Antenna Impedance	75 Ω			

MODEL	32LP1D	37LP1D	42LP1D
Width (inches / mm)	40 / 1016	45.6 / 1158	50.8 / 1290
Height (inches / mm)	24.7 / 627.5	28.3 / 719	31.7 / 804
Depth (inches / mm)	8.03 / 204	8.4 / 213.1	9.7 / 247.5
Weight (pounds / kg)	70.5 / 32	91.5 / 41.5	101.4 / 46
Power requirement	AC 100-240V~ 50/60Hz 2.0A	AC 100-240V~ 50/60Hz 2.4A	AC 100-240V~ 50/60Hz 3.5A
Television System	NTSC-M, ATSC		
Program Coverage	VHF 2 ~ 13, UHF 14 ~ 69, CATV 1 ~ 135, CADTV 1 ~ 135, DTV 2 ~ 69		
External Antenna Impedance	75 Ω		

- The specifications shown above may be changed without prior notice for quality improvement.

