

APPENDIX H  
: USER'S MANUAL



## LCD TV

MODELS: 32LC2D  
37LC2D  
42LC2D

## PLASMA TV

MODELS: 42PC3D 42PC3D-UD  
42PC3DV 42PC3DV-UD  
50PC3D 50PC3D-UD

## OWNER'S MANUAL



Internet Home Page : <http://www.lge.com>  
<http://www.lg.ca>

Please read this manual carefully before operating your set.  
Retain it for future reference.  
Record model number and serial number of the set.  
See the label attached on the back cover and quote  
this information to your dealer  
when you require service.

P/NO : 3828TUL527A (0511-REV00)  
Printed in Korea

# Warning

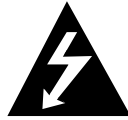

**CAUTION**  
RISK OF ELECTRIC SHOCK  
DO NOT OPEN



## WARNING:

TO REDUCE THE RISK OF ELECTRIC SHOCK DO NOT REMOVE COVER (OR BACK). NO USER SERVICEABLE PARTS INSIDE. REFER TO QUALIFIED SERVICE PERSONNEL.



The lightning flash with arrowhead symbol, within an equilateral triangle, is intended to alert the user to the presence of uninsulated "dangerous voltage" within the product's enclosure that may be of sufficient magnitude to constitute a risk of electric shock to persons.



The exclamation point within an equilateral triangle is intended to alert the user to the presence of important operating and maintenance (servicing) instructions in the literature accompanying the appliance.

## NOTE TO CABLE/TV INSTALLER:

This reminder is provided to call the CATV system installer's attention to Article 820-40 of the National Electric Code (U.S.A.). The code provides guidelines for proper grounding and, in particular, specifies that the cable ground shall be connected to the grounding system of the building, as close to the point of the cable entry as practical.

## REGULATORY INFORMATION

This equipment has been tested and found to comply with the limits for a Class B digital device, pursuant to Part 15 of the FCC Rules. These limits are designed to provide reasonable protection against harmful interference in a residential installation. This equipment generates, uses and can radiate radio frequency energy and, if not installed and used in accordance with the instructions, may cause harmful interference to radio communications. However, there is no guarantee that interference will not occur in a particular installation. If this equipment does cause harmful interference to radio or television reception, which can be determined by turning the equipment off and on, the user is encouraged to try to correct the interference by one or more of the following measures:

- Reorient or relocate the receiving antenna.
- Increase the separation between the equipment and receiver.
- Connect the equipment into an outlet on a circuit different from that to which the receiver is connected.
- Consult the dealer or an experienced radio/TV technician for help.

Any changes or modifications not expressly approved by the party responsible for compliance could void the user's authority to operate the equipment.

## CAUTION:

Do not attempt to modify this product in any way without written authorization from LG Electronics Corporation. Unauthorized modification could void the user's authority to operate this product.

## U.S.A. only -----

### COMPLIANCE:

The responsible party for this product's compliance is:  
LG Electronics U.S.A., Inc.  
1000 Sylvan Avenue, Englewood Cliffs, NJ 07632  
Phone: 1-201-816-2000  
<http://www.lgusa.com>

# Safety Instructions

## WARNING :

To Reduce The Risk Of Fire Or Electric Shock, Do Not Expose This Apparatus To Rain Or Moisture.

Apparatus shall not be exposed to dripping or splashing and no objects filled with liquids, such as vases, shall be placed on the apparatus.

## IMPORTANT SAFETY INSTRUCTIONS

1. Read these instructions.

2. Keep these instructions.

3. Heed all warnings.

4. Follow all instructions.



5. Do not use this apparatus near water.



6. Clean only with a dry cloth.

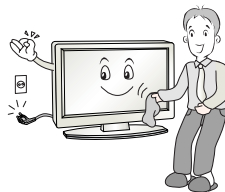

7. Do not block any of the ventilation openings. Install in accordance with the manufacturer's instructions.



8. Do not install near any heat sources such as radiators, heat registers, stoves, or other apparatus (including amplifiers) that produce heat.



9. Do not defeat the safety purpose of the polarized or grounding type plug. A polarized plug has two blades with one wider than the other. A grounding type plug has two blades and a third grounding prong. The wide blade or the third prong is provided for your safety. When the provided plug does not fit into your outlet, consult an electrician for replacement of the obsolete outlet.

10. Protect the power cord from being walked on or pinched particularly at plugs, convenience receptacles, and the point where they exit from the apparatus.

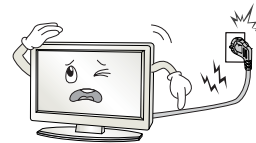

11. Only use the attachments / accessories specified by the manufacturer.

12. Use only with a cart, stand, tripod, bracket, or table specified by the manufacturer, or sold with the apparatus. When a cart is used, use caution when moving the cart / apparatus combination to avoid injury from tip-over.



14. Refer all servicing to qualified service personnel. Servicing is required when the apparatus has been damaged in any way, such as power supply cord or plug is damaged, liquid has been spilled or objects have fallen into the apparatus, the apparatus has been exposed to rain or moisture, does not operate normally, or has been dropped.



13. Unplug this apparatus during lightning storms or when unused for long periods of time.



**Note**

- If the TV feels cold to the touch, there may be a small “flicker” when when it is turned on. This is normal, there is nothing wrong with TV.
- Some minute dot defects may be visible on the screen, appearing as tiny red, green, or blue spots. However, they have no adverse effect on the monitor's performance.
- Avoid touching the LCD screen or holding your finger(s) against it for long periods of time. Doing so may produce some temporary distortion effects on the screen.

**CAUTION concerning the Power Cord**

Most appliances recommend they be placed upon a dedicated circuit; that is, a single outlet circuit which powers only that appliance and has no additional outlets or branch circuits. Check the specification page of this owner's manual to be certain.

Do not overload wall outlets. Overloaded wall outlets, loose or damaged wall outlets, extension cords, frayed power cords, or damaged or cracked wire insulation are dangerous. Any of these conditions could result in electric shock or fire. Periodically examine the cord of your appliance, and if its appearance indicates damage or deterioration, unplug it, discontinue use of the appliance, and have the cord replaced with an exact replacement part by an authorized servicer.

Protect the power cord from physical or mechanical abuse, such as being twisted, kinked, pinched, closed in a door, or walked upon. Pay particular attention to plugs, wall outlets, and the point where the cord exits the appliance.

**On Disposal**

- a. The fluorescent lamp used in this product contains a small amount of mercury.
  - b. Do not dispose of this product with general household waste.  
Disposal of this product must be carried out in accordance to the regulations of your local authority.
-

## Controls (Model Name: 32/37/42LC2D)

- This is a simplified representation of front panel.
- Here shown may be somewhat different from your TV.

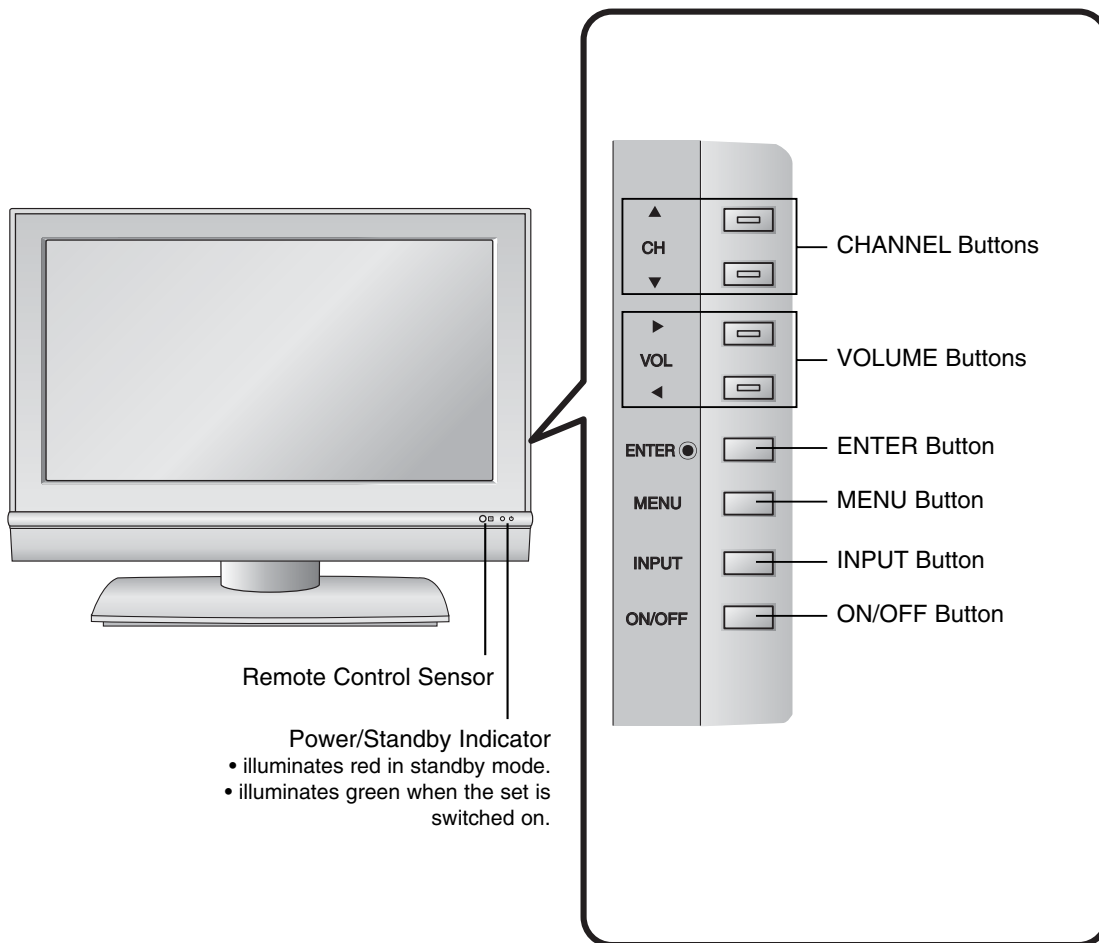

# Connection Options (Model Name: 32/37/42LC2D)

- Here shown may be somewhat different from your TV.

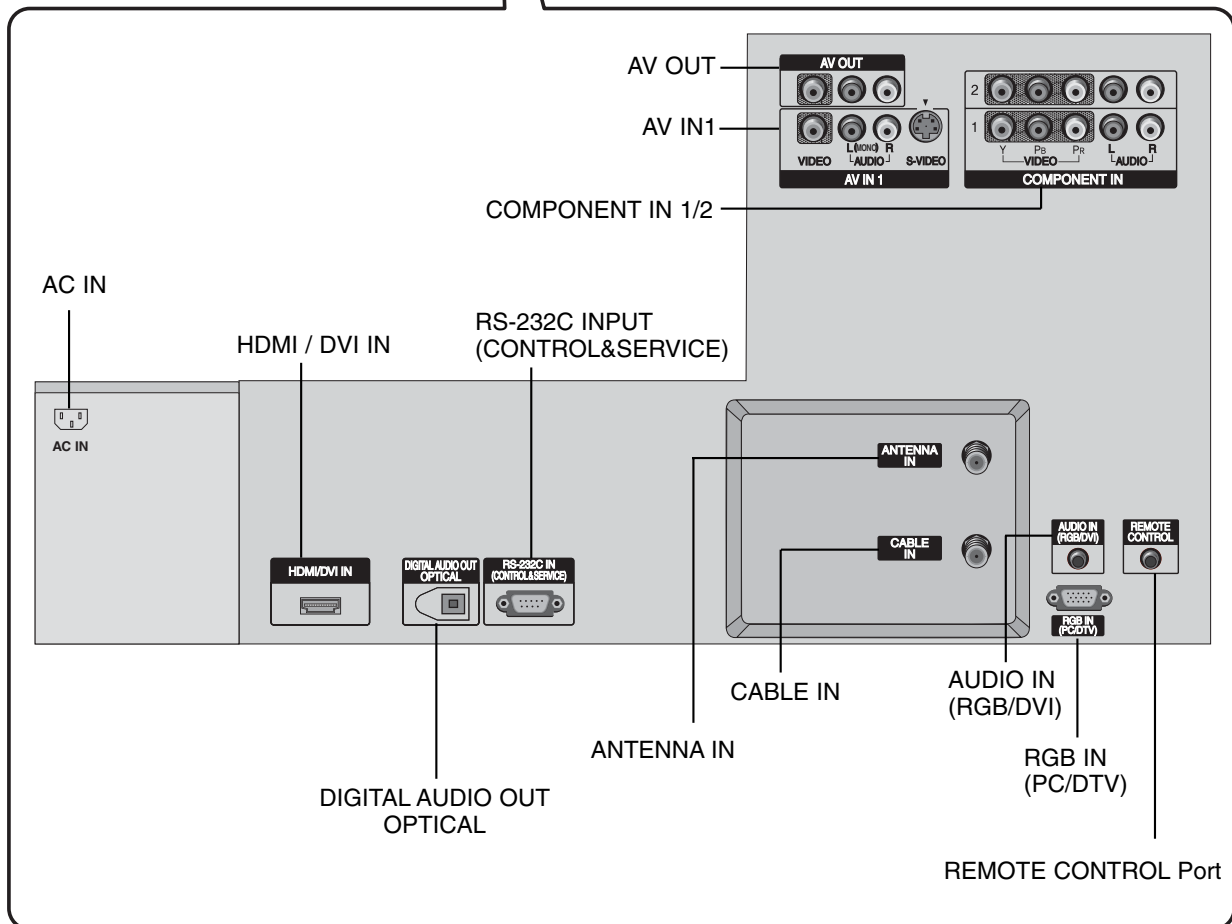
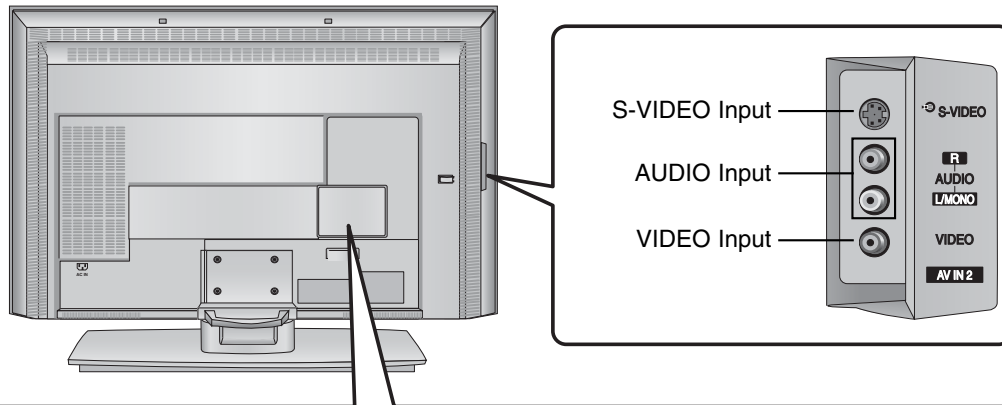

# Installation

- The TV can be installed in various ways such as on a wall, or on a desktop etc.
- The TV is designed to be mounted horizontally.

## GROUNDING

Ensure that you connect the earth ground wire to prevent possible electric shock. If grounding methods are not possible, have a qualified electrician install a separate circuit breaker. Do not try to ground the unit by connecting it to telephone wires, lightening rods, or gas pipes.

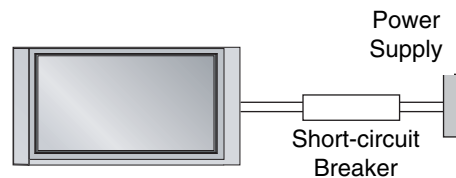

## Desktop Pedestal Installation

For proper ventilation, allow a clearance of 4" on each side and from the wall.

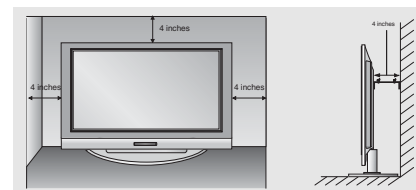
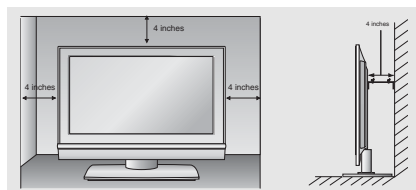
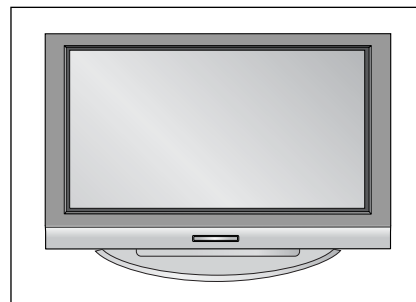
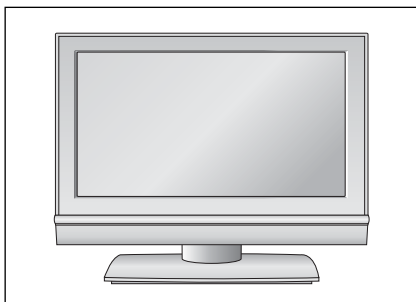



### How to join the product assembly to the wall to protect the set tumbling

- Set it up close to the wall so the product doesn't fall over when it is pushed backwards.
- The instructions shown below is a safer way to set up the product, which is to fix it on the wall so the product doesn't fall over when it is pulled in the forward direction. It will prevent the product from falling forward and hurting people. It will also prevent the product from damage caused by fall. Please make sure that children don't climb on or hang from the product.

#### 42PC3D/42PC3DV/50PC3D

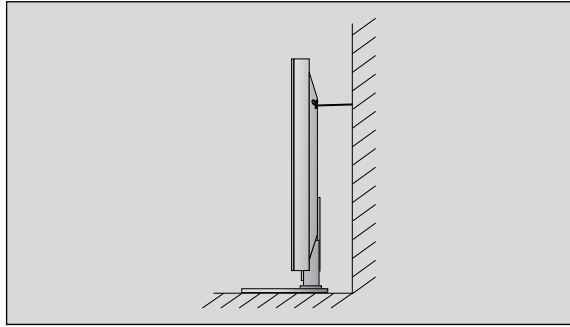
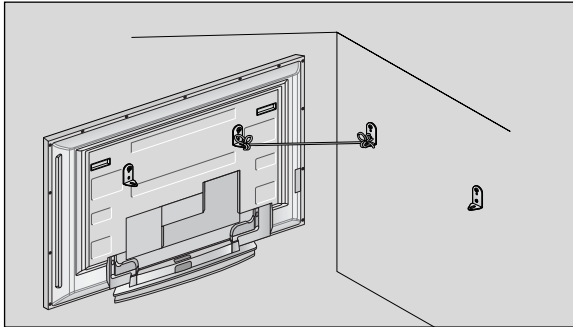

- 1** If the set will be mounted on a desk top, insert the 2 eye-bolts and tighten them securely in the upper holes as shown.
- 2** Install the wall brackets on the wall with 2 bolts\*, (not supplied with the product), as shown.
- 3** Match the height of the eye-bolts and the wall brackets.
- 4** Check to be sure the eye-bolts and the brackets are tightened securely.
- 5** Secure the TV assembly to the wall with strong strings or wire cables, (not supplied with the product), as shown.

#### 32/37/42LC2D

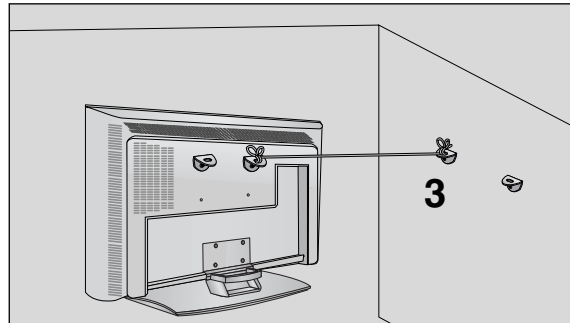
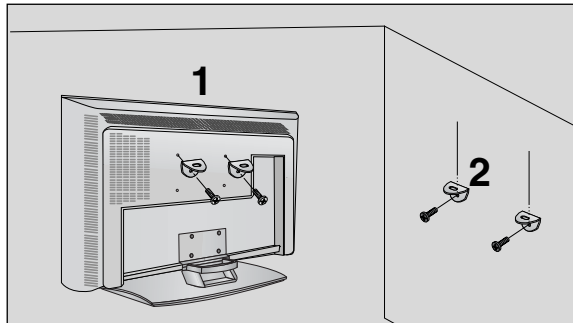

- 1** Use the bracket and the bolt to fix the product to the wall as shown in the picture.
- 2** Secure the bracket with the bolt (not provided as parts of the product, must purchase separately) on the wall.
- 3** Use a sturdy rope (not provided as parts of the product, must purchase separately) to tie the product. It is safer to tie the rope so it becomes horizontal between the wall and the product.

#### Notes

- When moving the product to another place undo the ropes first.
- Use a product holder or a cabinet that is big and strong enough for the size and weight of the product.
- To use the product safely make sure that the height of the bracket that is mounted on the wall is same as that of the product.

## Monitor Out Setup

- The TV has a special signal output capability which allows you to hook up a second TV or monitor.

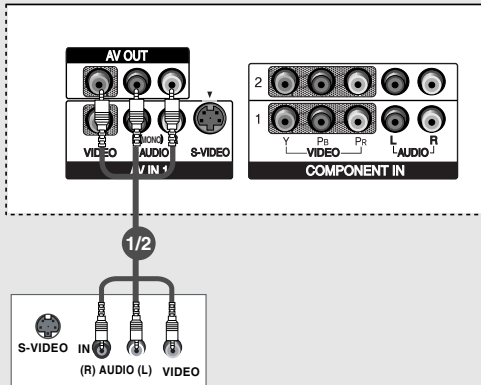

- 1 Connect the second TV or monitor to the TV's **AV OUTPUT** jacks.
- 2 See the Operating Manual of the second TV or monitor for further details regarding that device's input settings.



- Component 1-2, RGB-PC/RGB-DTV, HDMI/DVI, DTV input sources cannot be used for Monitor out.
- When connecting with external audio equipments, such as amplifiers or speakers, please turn the TV speakers off. (Refer to p.43)
- We recommend to use the video and audio output jacks for VCR recording.

## Digital Audio Output

- Send the TV's audio to external audio equipment (stereo system) via the Digital Audio Output Optical port.

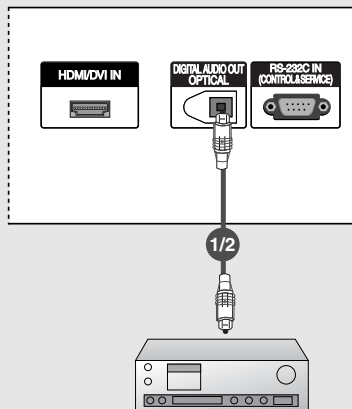

- 1 Connect one end of an optical cable to the TV Digital Audio Optical Output port.
- 2 Connect the other end of the optical cable to the digital audio optical input on the audio equipment.
- 3 See the external audio equipment instruction manual for operation.  
When connecting with external audio equipments, such as amplifiers or speakers, please turn the TV speakers off.



### CAUTION

Do not look into the optical output port. Looking at the laser beam may damage your vision.

## PC Setup

- This TV provides Plug and Play capability, meaning that the PC adjusts automatically to the TV's settings.

### When connecting with a D-sub 15 pin cable

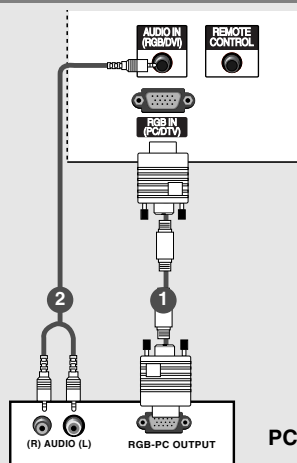

- 1 Connect the RGB output of the PC to the **RGB IN (PC/DTV)** (32/37/42LC2D Model) / **RGB (PC/DTV)** (42PC3D/3DV/50PC3D Model) jack on the set.
- 2 Connect the PC audio outputs to the **AUDIO IN (RGB/DVI)** (32/37/42LC2D Model) / **AUDIO (RGB/DVI)** (42PC3D/3DV/50PC3D Model) jack on the set.
- 3 Turn on the PC and the set.
- 4 Select **RGB-PC** input source with using the **TV/VIDEO** button on the remote control.

### When connecting with a HDMI to DVI cable

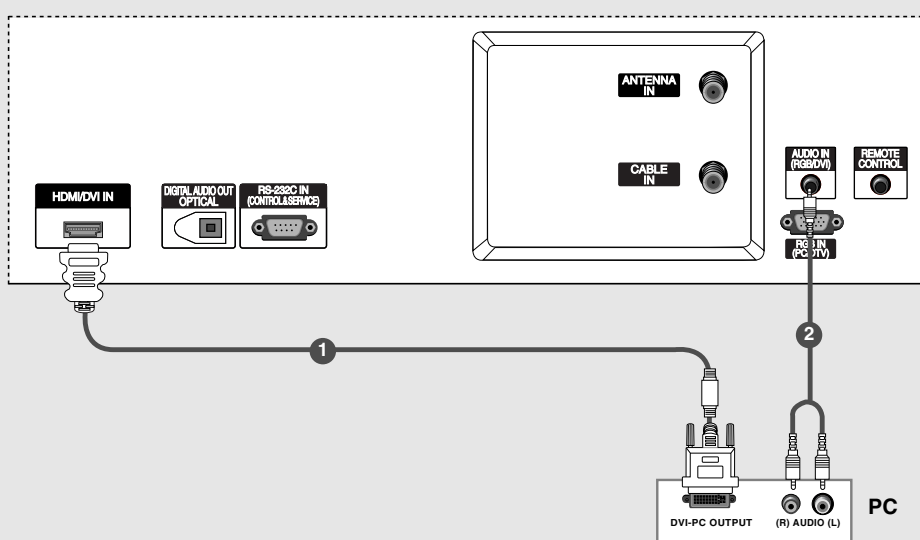

- 1 Connect the DVI output of the PC to the **HDMI/DVI IN** jack on the set.
- 2 Connect the audio outputs of the PC to the **AUDIO IN (RGB/DVI)** (32/37/42LC2D Model) / **AUDIO (RGB/DVI)** (42PC3D/3DV/50PC3D Model) jack on the set.
- 3 Turn on the PC and the set.
- 4 Select **HDMI/DVI** input source with using the **TV/VIDEO** button on the remote control.



- If the PC has a DVI output and no HDMI output, a separated audio connection is necessary.
- If the PC does not support Auto DVI, you need to set the output resolution appropriately. To get the best picture quality, adjust the output resolution of PC graphics card's output resolution to 1024x768, 60Hz.



1. To get the best picture quality, adjust the PC graphics card to 1024x768, 60Hz.
2. Depending on the graphics card, DOS mode may not work if a HDMI to DVI Cable is in use.
3. When Source Devices connected with HDMI1/DVI Input, output PC Resolution (VGA, SVGA, XGA), Position and Size may not fit to Screen. Press the ADJUST button to adjust the screen Position of TV SET and contact an PC graphics card service center.
4. When Source Devices connected with HDMI/DVI Input, output TV SET Resolution (480p, 720p, 1080i) and TV SET Display fit EIA/CEA-861-B Specification to Screen. If not, refer to the Manual of HDMI/DVI Source Devices or contact your service center.
5. In case HDMI/DVI Source Devices is not connected Cable or poor cable connection, "NO SIGNAL" OSD display in HDMI1/DVI Input. In case that Video Resolution is not supported TV SET output in HDMI/DVI Source Devices, "INVALID FORMAT" OSD display. Refer to the Manual of HDMI1/DVI Source Devices or contact your service center.
6. Check the image on your TV. There may be noise associated with the resolution, vertical pattern, contrast or brightness in PC, HDMI/DVI mode. If noise is present, change the PC or HDMI/DVI mode to another resolution, change the refresh rate to another rate or adjust the brightness and contrast on the menu until the picture is clear. If the refresh rate of the PC graphic card can not be changed, change the PC graphic card or consult the manufacturer of the PC graphic card.
7. Avoid keeping a fixed image on the TV's screen for a long period of time. The fixed image may become permanently imprinted on the screen.
8. The synchronization input form for Horizontal and Vertical frequencies is separate.

**Supported Display Resolution  
(RGB-PC, HDMI/DVI Mode)**

Resolution	Horizontal Frequency (kHz)	Vertical Frequency (Hz)	Resolution	Horizontal Frequency (kHz)	Vertical Frequency (Hz)
* 640x350	31.468	70.09	800x600	35.156	56.25
* 720x400	31.469	70.08		37.879	60.31
640x480	31.469	59.94		48.077	72.18
	37.861	72.80		46.875	75.00
	37.500	75.00	1024x768	48.363	60.00
* RGB-PC only				56.476	70.06
				60.023	75.02

## Screen Setup for PC mode

- When RGB connect to PC input and select the RGB-PC, this function is used.
- When HDMI/DVI connect to PC input and select HDMI/DVI input, this function is used.
- In RGB-DTV mode, SIZE and PHASE is not available.
- After connecting RGB-PC or HDMI/DVI to PC input and checking the screen quality.

### \* Adjustment for screen Position, Size, and Phase

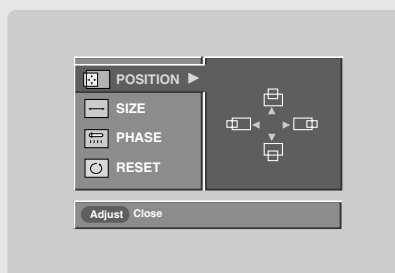

#### Mini Glossary

**Position** This function is to adjust picture to left/right and up/down as you prefer.

**Size** This function is to minimize any vertical bars or stripes visible on the screen background. And the horizontal screen size will also change.

**Phase** This function allows you to remove any horizontal noise and clear or sharpen the image of characters.

- 1 Press the **ADJUST** button and then use **▲ / ▼** button to select **POSITION**, **SIZE**, or **PHASE**.
- 2 Press **ENTER** button and then use **▲ / ▼ / ◀ / ▶** buttons to make appropriate adjustments.
  - The **PHASE** adjustment range is -16 ~ +16.  
(In HDMI/DVI-PC mode, **PHASE** is not available.)
  - The **SIZE** adjustment range is -50 ~ +50.
- 3 Press **ENTER** button.

### \* Initializing (Reset to original factory values)

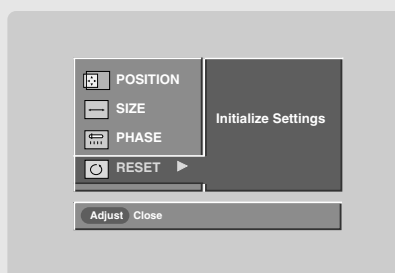

- To initialize the adjusted values

- 1 Press the **ADJUST** button and then use **▲ / ▼** button to select the **RESET** option.
- 2 Press **ENTER** button and then use **◀ / ▶** button to select **Yes**.
- 3 Press **ENTER** button.

# External Control Device Setup

- Connect the RS-232C input jack to an external control device (such as a computer or an A/V control system) and control the Monitor's functions externally.
- Connect the serial port of the control device to the RS-232C jack on the TV back panel.
- RS-232C connection cables are not supplied with the TV.

## RS-232C Setup

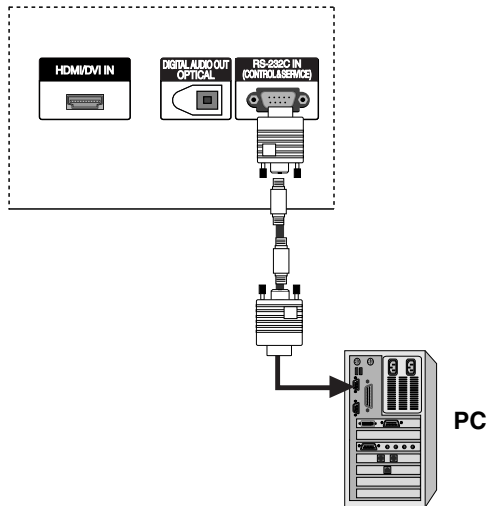

### Type of Connector; D-Sub 9-Pin Male

No.	Pin Name
1	No connection
2	RXD (Receive data)
3	TXD (Transmit data)
4	DTR (DTE side ready)
5	GND
6	DSR (DCE side ready)
7	RTS (Ready to send)
8	CTS (Clear to send)
9	No Connection

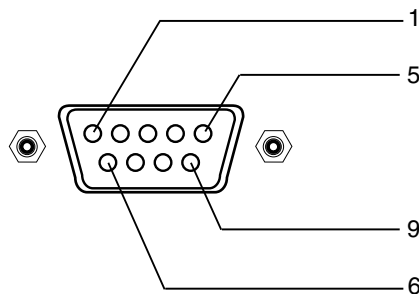

### RS-232C Configurations

#### 7-Wire Configurations (Serial female-female NULL modem cable)

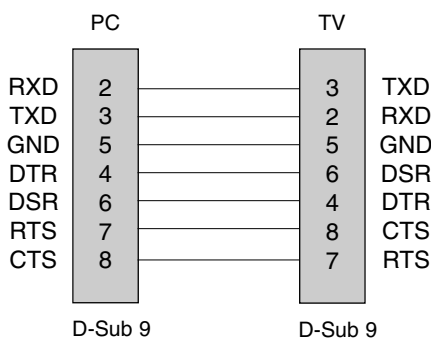

#### 3-Wire Configurations (Not standard)

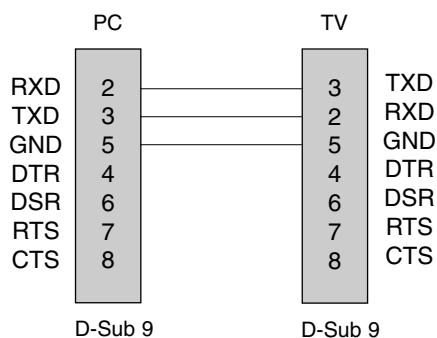

## Set ID

- Use this function to specify a TV ID number.
- Refer to 'Real Data Mapping'. See page 56.

1. Press the **MENU** button and then use **▲ / ▼** button to select the **SETUP** menu.
2. Press the **▶** button and then use **▲ / ▼** button to select **Set ID**.
3. Press the **▶** button and then use **▲ / ▼** button to adjust **Set ID** to choose the desired TV ID number. The adjustment range of **Set ID** is 1 ~ 99.
4. Press **EXIT** button to return to TV viewing or press **MENU** button to return to the previous menu.

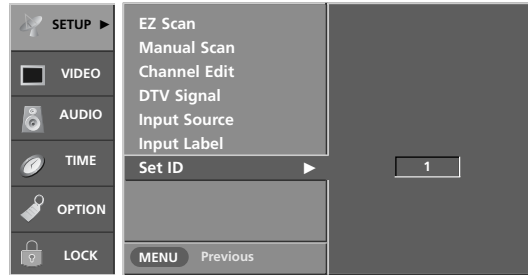

## Communication Parameters

- Baud rate : 9600 bps (UART)
- Data length : 8 bits
- Parity : None
- Stop bit : 1 bit
- Communication code : ASCII code

\* Use a crossed (reverse) cable.

## Command Reference List

	COMMAND 1	COMMAND 2	DATA (Hexadecimal)
01. Power	k	a	0 ~ 1
02. Input Select	k	b	0 ~ 8
03. Aspect Ratio	k	c	* (Refer to p.56)
04. Screen Mute	k	d	0 ~ 1
05. Volume Mute	k	e	0 ~ 1
06. Volume Control	k	f	0 ~ 64
07. Contrast	k	g	0 ~ 64
08. Brightness	k	h	0 ~ 64
09. Color	k	i	0 ~ 64
10. Tint	k	j	0 ~ 64
11. Sharpness	k	k	0 ~ 64
12. OSD Select	k	l	0 ~ 1
13. Remote Control Lock Mode	k	m	0 ~ 1
14. Treble	k	r	0 ~ 64
15. Bass	k	s	0 ~ 64
16. Balance	k	t	0 ~ 64
17. Color Temperature	k	u	0 ~ 2
18. ISM Method	j	p	* (Refer to p.58)
19. Low Power	j	q	0 ~ 1
20. Orbiter Time Setting	j	r	1 ~ FE
21. Orbiter Pixel Setting	j	s	1 ~3

\* Command **18~21**: 42PC3D/3DV, 50PC3D models only

	COM- MAND 1	COM- MAND 2	DATA 0 (Hexadecimal)	DATA 1 (Hexadecimal)	DATA 2 (Hexadecimal)	DATA 3 (Hexadecimal)	DATA 4 (Hexadecimal)	DATA 5 (Hexadecimal)
22. Channel Tuning	m	a	physical/program high	major/program low	major low	minor high	minor low	attribute
23. Channel Add/Del	m	b	00 ~ 01					
24. Key	m	c	key code					
25. Input Select	x	b	* (Refer to p.59)					

## Transmission / Receiving Protocol

### Transmission

[Command1][Command2][ ][Set ID][ ][Data][Cr]

- \* [Command 1]: First command to control the set.(j,k,m or x)
- \* [Command 2]: Second command to control the set.
- \* [Set ID]: You can adjust the set ID to choose desired monitor ID number in Setup menu. Adjustment range is 1 ~ 99. When selecting Set ID '0', every connected the TV is controlled. Set ID is indicated as decimal (1~99) on menu and as Hexa decimal (0x0~0x63) on transmission/receiving protocol.
- \* [DATA]: To transmit command data.  
Transmit 'FF' data to read status of command.
- \* [Cr]: Carriage Return  
ASCII code '0x0D'
- \* [ ]: ASCII code 'space (0x20)'

### OK Acknowledgement

[Command2][ ][Set ID][ ][OK][Data][x]

- \* The Monitor transmits ACK (acknowledgement) based on this format when receiving normal data. At this time, if the data is data read mode, it indicates present status data. If the data is data write mode, it returns the data of the PC computer.

### Error Acknowledgement

[Command2][ ][Set ID][ ][NG][Data][x]

- \* The Monitor transmits ACK (acknowledgement) based on this format when receiving abnormal data from non-viable functions or communication errors.

- Data 1: Illegal Code  
2: Not supported function  
3: Wait more time

# Maintenance

- Early malfunctions can be prevented. Careful and regular cleaning can extend the amount of time you will have your new TV. Be sure to turn the power off and unplug the power cord before you begin any cleaning.

## Cleaning the Screen

1. Here's a great way to keep the dust off your screen for a while. Wet a soft cloth in a mixture of lukewarm water and a little fabric softener or dish washing detergent. Wring the cloth until it's almost dry, and then use it to wipe the screen.
2. Make sure the excess water is off the screen, and then let it air-dry before you turn on your TV.

## Cleaning the Cabinet

To remove dirt or dust, wipe the cabinet with a soft, dry, lint-free cloth. Please be sure not to use a wet cloth.

## Extended Absence



If you expect to leave your TV dormant for a long time (such as a vacation), it's a good idea to unplug the power cord to protect against possible damage from lightning or power surges.

# Product Specifications

MODEL	32LC2D	37LC2D	42LC2D
Power requirement	AC100-240V ~ 50/60Hz 1.5A	AC100-240V ~ 50/60Hz 2.0A	AC100-240V ~ 50/60Hz 2.5A
Television System	NTSC-M, ATSC, 64 & 256 QAM		
Program Coverage	VHF 2 ~ 13, UHF 14 ~ 69, CATV 1 ~ 135, CADTV 1 ~ 135, DTV 2 ~ 69		
External Antenna Impedance	75 Ω		
Operating Temperature Range	32 ~ 104°F (0 ~ 40°C)		
Operating Humidity Range	Less than 80%		

MODEL	42PC3D/3DV-UD	50PC3D-UD
Power requirement	AC100-240V ~ 50/60Hz 2.0A	
Television System	NTSC-M, ATSC, 64 & 256 QAM	
Program Coverage	VHF 2 ~ 13, UHF 14 ~ 69, CATV 1 ~ 135, CADTV 1 ~ 135, DTV 2 ~ 69	
External Antenna Impedance	75 Ω	
Operating Temperature Range	32 ~ 104°F (0 ~ 40°C)	
Operating Humidity Range	Less than 80%	
Resolution	852 x 480 (Dot)	1366 x 768 (Dot)

- The specifications shown above may be changed without prior notice for quality improvement.



