



LCD TV OWNER'S MANUAL

37LG50
42LG50
42LG50DC
47LG50
52LG50

Please read this manual carefully before operating your set.
Retain it for future reference.
Record model number and serial number of the set.
See the label attached on the back cover and quote this information to your dealer when you require service.

ENERGY STAR is a set of power-saving guidelines issued by the U.S. Environmental Protection Agency (EPA).



As an ENERGY STAR Partner LG Electronics USA, Inc. has determined that this product meets the ENERGY STAR guidelines for energy efficiency.

P/NO : SAC30708033 (0809-REV02)

WARNING / CAUTION



WARNING / CAUTION
RISK OF ELECTRIC SHOCK
DO NOT OPEN



**TO REDUCE THE RISK OF ELECTRIC SHOCK
DO NOT REMOVE COVER (OR BACK). NO
USER SERVICEABLE PARTS INSIDE. REFER TO
QUALIFIED SERVICE PERSONNEL.**



The lightning flash with arrowhead symbol, within an equilateral triangle, is intended to alert the user to the presence of uninsulated “dangerous voltage” within the product’s enclosure that may be of sufficient magnitude to constitute a risk of electric shock to persons.



The exclamation point within an equilateral triangle is intended to alert the user to the presence of important operating and maintenance (servicing) instructions in the literature accompanying the appliance.

WARNING/CAUTION

TO REDUCE THE RISK OF FIRE AND ELECTRIC SHOCK, DO NOT EXPOSE THIS PRODUCT TO RAIN OR MOISTURE.

NOTE TO CABLE/TV INSTALLER

This reminder is provided to call the CATV system installer’s attention to Article 820-40 of the National Electric Code (U.S.A.). The code provides guidelines for proper grounding and, in particular, specifies that the cable ground shall be connected to the grounding system of the building, as close to the point of the cable entry as practical.

WARNING / CAUTION

To prevent fire or shock hazards, do not expose this product to rain or moisture.

FCC NOTICE

Class B digital device

This equipment has been tested and found to comply with the limits for a Class B digital device, pursuant to Part 15 of the FCC Rules. These limits are designed to provide reasonable protection against harmful interference in a residential installation. This equipment generates, uses and can radiate radio frequency energy and, if not installed and used in accordance with the instructions, may cause harmful interference to radio communications. However, there is no guarantee that interference will not occur in a particular installation. If this equipment does cause harmful interference to radio or television reception, which can be determined by turning the equipment off and on, the user is encouraged to try to correct the interference by one or more of the following measures:

- Reorient or relocate the receiving antenna.
- Increase the separation between the equipment and receiver.
- Connect the equipment to an outlet on a circuit different from that to which the receiver is connected.
- Consult the dealer or an experienced radio/TV technician for help.

Any changes or modifications not expressly approved by the party responsible for compliance could void the user’s authority to operate the equipment.

CAUTION

Do not attempt to modify this product in any way without written authorization from LG Electronics. Unauthorized modification could void the user’s authority to operate this product

SAFETY INSTRUCTIONS

IMPORTANT SAFETY INSTRUCTIONS

Read these instructions.
Keep these instructions.
Heed all warnings.
Follow all instructions.



1 Do not use this apparatus near water.

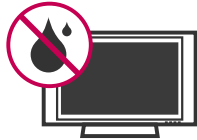

2 Clean only with dry cloth.



3 Do not block any ventilation openings. Install in accordance with the manufacturer's instructions.



4 Do not install near any heat sources such as radiators, heat registers, stoves, or other apparatus (including amplifiers) that produce heat.



5 Do not defeat the safety purpose of the polarized or grounding-type plug. A polarized plug has two blades with one wider than the other. A grounding type plug has two blades and a third grounding prong. The wide blade or the third prong are provided for your safety. If the provided plug does not fit into your outlet, consult an electrician for replacement of the obsolete outlet.



6 Protect the power cord from being walked on or pinched particularly at plugs, convenience receptacles, and the point where they exit from the apparatus.



7 Only use attachments/accessories specified by the manufacturer.



8 Use only with the cart, stand, tripod, bracket, or table specified by the manufacturer, or sold with the apparatus. When a cart is used, use caution when moving the cart/apparatus combination to avoid injury from tip-over.



9 Unplug this apparatus during lightning storms or when unused for long periods of time.

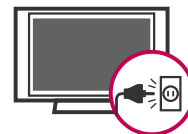

10 Refer all servicing to qualified service personnel. Servicing is required when the apparatus has been damaged in any way, such as power-supply cord or plug is damaged, liquid has been spilled or objects have fallen into the apparatus, the apparatus has been exposed to rain or moisture, does not operate normally, or has been dropped.

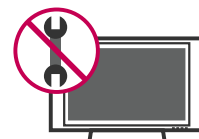

SAFETY INSTRUCTIONS

11 Never touch this apparatus or antenna during a thunder or lightning storm.

12 When mounting a TV on the wall, make sure not to install the TV by the hanging power and signal cables on the back of the TV.

13 Do not allow an impact shock or any objects to fall into the product, and do not drop onto the screen with something.

14 **CAUTION** concerning the Power Cord:
It is recommend that appliances be placed upon a dedicated circuit; that is, a single outlet circuit which powers only that appliance and has no additional outlets or branch circuits. Check the specification page of this owner's manual to be certain.

Do not connect too many appliances to the same AC power outlet as this could result in fire or electric shock.

Do not overload wall outlets. Overloaded wall outlets, loose or damaged wall outlets, extension cords, frayed power cords, or damaged or cracked wire insulation are dangerous. Any of these conditions could result in electric shock or fire. Periodically examine the cord of your appliance, and if its appearance indicates damage or deterioration, unplug it, discontinue use of the appliance, and have the cord replaced with an exact replacement part by an authorized servicer. Protect the power cord from physical or mechanical abuse, such as being twisted, kinked, pinched, closed in a door, or walked upon. Pay particular attention to plugs, wall outlets, and the point where the cord exits the appliance.

Do not make the TV with the power cord plugged in. Do not use a damaged or loose power cord. Be sure do grasp the plug when unplugging the power cord. Do not pull on the power cord to unplug the TV.



15 **WARNING** - To reduce the risk of fire or electrical shock, do not expose this product to rain, moisture or other liquids. Do not touch the TV with wet hands. Do not install this product near flammable objects such as gasoline or candles or expose the TV to direct air conditioning.



16 Do not expose to dripping or splashing and do not place objects filled with liquids, such as vases, cups, etc. on or over the apparatus (e.g. on shelves above the unit).



17 **GROUNDING**
Ensure that you connect the earth ground wire to prevent possible electric shock (i.e. a TV with a three-prong grounded AC plug must be connected to a three-prong grounded AC outlet). If grounding methods are not possible, have a qualified electrician install a separate circuit breaker.

Do not try to ground the unit by connecting it to telephone wires, lightning rods, or gas pipes.

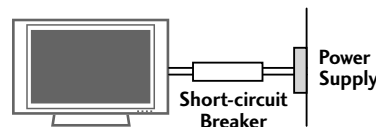

18 **DISCONNECTING DEVICE FROM MAINS**
Mains plug is the disconnecting device. The plug must remain readily operable.

19 Keep the product away from direct sunlight.

20 ANTENNAS

Outdoor antenna grounding

If an outdoor antenna is installed, follow the precautions below. An outdoor antenna system should not be located in the vicinity of overhead power lines or other electric light or power circuits, or where it can come in contact with such power lines or circuits as death or serious injury can occur.

Be sure the antenna system is grounded so as to provide some protection against voltage surges and built-up static charges.

Section 810 of the National Electrical Code (NEC) in the U.S.A. provides information with respect to proper grounding of the mast and supporting structure, grounding of the lead-in wire to an antenna discharge unit, size of grounding conductors, location of antenna discharge unit, connection to grounding electrodes and requirements for the grounding electrode.

Antenna grounding according to the National Electrical Code, ANSI/NFPA 70

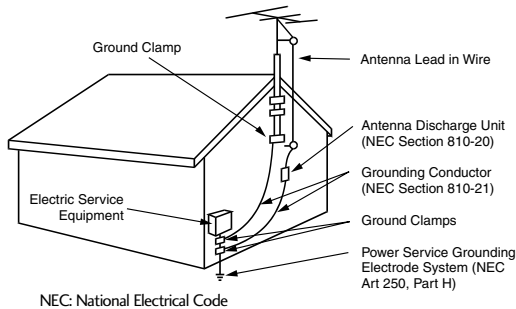

21 Cleaning

When cleaning, unplug the power cord and scrub gently with a soft cloth to prevent scratching. Do not spray water or other liquids directly on the TV as electric shock may occur. Do not clean with chemicals such as alcohol, thinners or benzene.

22 Moving

Make sure the product is turned off, unplugged and all cables have been removed. It may take 2 or more people to carry larger TVs. Do not press against or put stress on the front panel of the TV.

23 Ventilation

Install your TV where there is proper ventilation. Do not install in a confined space such as a bookcase. Do not cover the product with cloth or other materials (e.g.) plastic while plugged in. Do not install in excessively dusty places.

24 If you smell smoke or other odors coming from the TV or hear strange sounds, unplug the power cord contact an authorized service center.

25 Do not press strongly upon the panel with hand or sharp object such as nail, pencil or pen, or make a scratch on it.

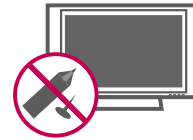

CONTENTS

| | |
|----------------------------------|---|
| WARNING / CAUTION | 2 |
| SAFETY INSTRUCTIONS | 3 |
| FEATURE OF THIS TV | 8 |

PREPARATION

| | |
|-------------------------------------------------------------------------------------|----|
| Accessories | 9 |
| Front Panel Information | 10 |
| Back Panel Information | 11 |
| Stand Instruction | 12 |
| VESA Wall Mounting | 13 |
| Cable Management | 14 |
| Desktop Pedestal Installation | 15 |
| Swivel Stand | 15 |
| Attaching the TV to a Desk | 15 |
| Securing the TV to the wall to prevent falling when the TV is used on a stand | 16 |
| Antenna or Cable Connection | 17 |

EXTERNAL EQUIPMENT SETUP

| | |
|------------------------------|----|
| HD Receiver Setup | 18 |
| DVD Setup | 21 |
| VCR Setup | 23 |
| Other A/V Source Setup | 25 |
| PC Setup | 26 |
| USB Connection | 32 |
| Audio Out Connection | 33 |

WATCHING TV / CHANNEL CONTROL

| | |
|---------------------------------|----|
| Remote Control Functions | 34 |
| Turning On the TV | 36 |
| Channel Selection | 36 |
| Volume Adjustment | 36 |
| Quick Menu | 37 |
| Initial Setting | 38 |
| On-Screen Menus Selection | 39 |

| | |
|----------------------------------------------|----|
| Channel Setup | |
| - Auto Scan (Auto Tuning) | 40 |
| - Add / Delete Channel (Manual Tuning) | 41 |
| - Channel Editing | 42 |
| Input List | 43 |
| Input Label | 44 |
| AV Mode | 45 |
| SIMPLINK | 46 |

USB

| | |
|-------------------|----|
| Entry Modes | 48 |
| Photo List | 49 |
| Music List | 53 |

PICTURE CONTROL

| | |
|-------------------------------------------------|----|
| Picture Size (Aspect Ratio) Control | 56 |
| Preset Picture Settings | |
| - Picture Mode - Preset | 58 |
| - Color Tone - Preset | 59 |
| Manual Picture Adjustment | |
| - Picture Mode - User Mode | 60 |
| - Picture Mode - Expert Control | 61 |
| Picture Improvement Technology | 62 |
| Advanced Control - Black (Darkness) Level | 63 |
| Advanced Control - Eye Care | 64 |
| Advanced Control - Real Cinema | 65 |
| Picture Reset | 66 |
| Power Indicator | 67 |

SOUND & LANGUAGE CONTROL

| | |
|----------------------------------------------|----|
| Auto Volume Leveler (Auto Volume) | 68 |
| Preset Sound Settings (Sound Mode) | 69 |
| Sound Setting Adjustment - User Mode | 70 |
| Clear Voice | 71 |
| Balance | 72 |
| TV Speakers On/Off Setup | 73 |
| Audio Reset | 74 |
| Stereo/SAP Broadcast Setup | 75 |
| Audio Language | 76 |
| On-Screen Menus Language Selection | 77 |
| Caption Mode | |
| - Analog Broadcasting System Captions | 78 |
| - Digital Broadcasting System Captions | 79 |
| - Caption Option | 80 |

TIME SETTING

| | |
|--------------------------------|----|
| Clock Setting | |
| - Auto Clock Setup | 81 |
| - Manual Clock Setup | 82 |
| Auto On/Off Time Setting | 83 |
| Sleep Timer Setting | 84 |
| Auto Shut-off Setting | 85 |

PARENTAL CONTROL / RATINGS

| | |
|----------------------------------|----|
| Set Password & Lock System | 86 |
| Channel Blocking | 89 |
| Movie & TV Rating | 90 |
| Downloadable Rating | 95 |
| External Input Blocking | 96 |
| Key lock | 97 |

APPENDIX

| | |
|----------------------------------------|-----|
| Troubleshooting | 98 |
| Maintenance | 100 |
| Product Specifications | 101 |
| Programming the Remote Control | 102 |
| IR Codes | 105 |
| External Control Through RS-232C | 107 |

FEATURE OF THIS TV



SRS is a trademark of SRS Labs, Inc.
TruSurround XT technology is incorporated under license from SRS Labs, Inc.



Manufactured under license from Dolby Laboratories.
“Dolby” and the double-D symbol are trademarks of Dolby Laboratories.



CALIBRATE LIKE A PRO: Sophisticated and detailed calibrations can be made through the ISFccc mode. Detailed calibration requires a licensed technician. Please contact your local dealer to inquire about an ISF certified technician.

FOR LCD TV

- If the TV feels cold to the touch, there may be a small “flicker” when it is turned on. This is normal, there is nothing wrong with TV.
- Some minute dot defects may be visible on the screen, appearing as tiny red, green, or blue spots. However, they have no adverse effect on the monitor’s performance.
- Avoid touching the LCD screen or holding your finger(s) against it for long periods of time. Doing so may produce some temporary distortion effects on the screen.

On Disposal (Only Hg lamp used LCD TV)

The fluorescent lamp used in this product contains a small amount of mercury. Do not dispose of this product with general household waste. Disposal of this product must be carried out in accordance to the regulations of your local authority.

PREPARATION

ACCESSORIES

Ensure that the following accessories are included with your TV. If an accessory is missing, please contact the dealer where you purchased the TV.

The accessories included may differ from the images below.

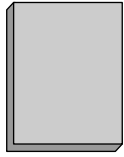

Owner's Manual



CD Manual

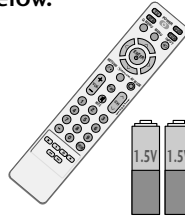

Remote Control,
Batteries



Power Cord

(Only 37/42LG50, 42LG50DC)



Bolts for stand assembly
(Refer to P.12)

(Only 37/42LG50, 42LG50DC)



Screw for stand fixing
(Refer to P.15)

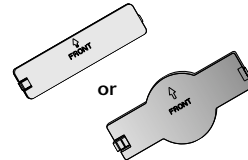

Protection Cover

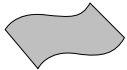

Polishing Cloth

(This feature is not available for all models.)

- * Wipe spots on the exterior only with the polishing cloth.
- * Do not wipe roughly when removing stain. Excessive pressure may cause scratch or discoloration.

Option Extras

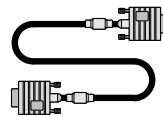

D-sub 15 pin Cable

When using the VGA (D-sub 15 pin cable) PC connection, the user must use shielded signal interface cables with ferrite cores to maintain standards compliance.

PREPARATION

FRONT PANEL INFORMATION

PREPARATION

- Image shown may differ from your TV.
- **NOTE:** If your TV has a protection tape attached, remove the tape. And then wipe the TV with a cloth (If a polishing cloth is included with your TV, use it).

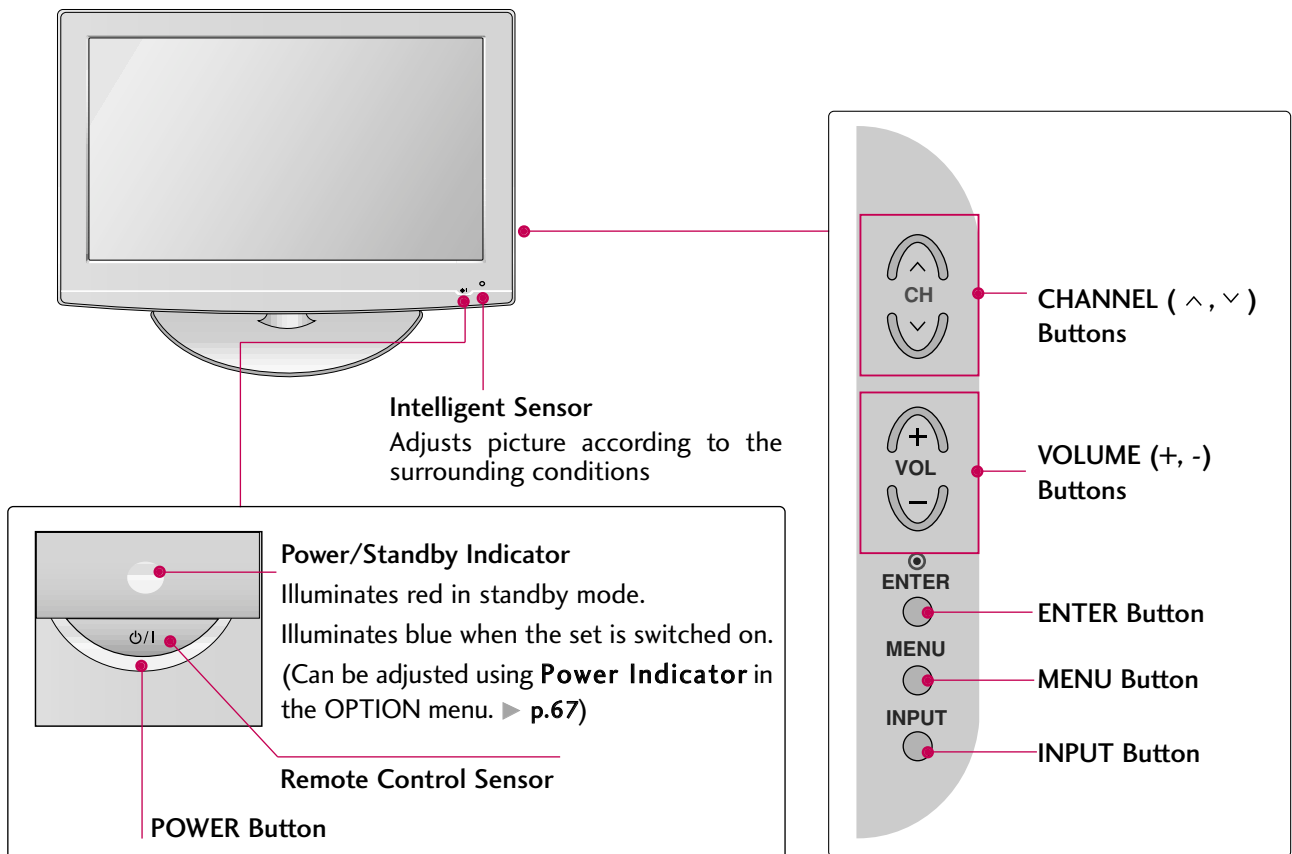

BACK PANEL INFORMATION

■ Image shown may differ from your TV.

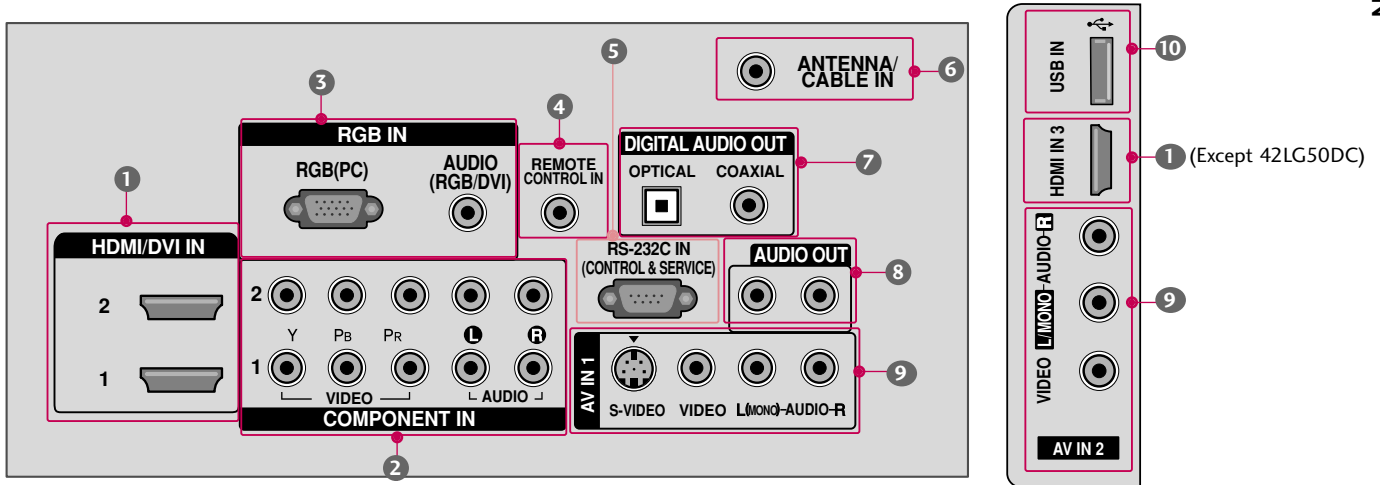
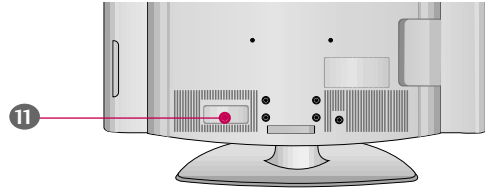

1 HDMI/DVI IN, HDMI IN

Digital Connection.
Supports HD video and Digital audio. Doesn't support 480i.
Accepts DVI video using an adapter or HDMI to DVI cable (not included).

2 COMPONENT IN

Analog Connection.
Supports HD.
Uses a red, green, and blue cable for video & red and white for audio.

3 RGB (PC)

Analog PC Connection. Uses a D-sub 15 pin cable (VGA cable).
AUDIO (RGB/DVI)
1/8" headphone jack for analog PC audio input.

4 REMOTE CONTROL IN PORT

For a wired remote control.

5 RS-232C IN (CONTROL & SERVICE) PORT

Used by third party devices.

6 ANTENNA/CABLE IN

Connect over-the air signals to this jack.
Connect cable signals to this jack.

7 DIGITAL AUDIO OUT

Digital audio output for use with amps and home theater systems.
Includes an optical and coaxial connection.
Note: In standby mode, these ports do not work.

8 AUDIO OUT

Analog audio output for use with amps and home theater systems.

9 AV (Audio/Video) IN

Analog composite connection. Supports standard definition video only (480i).
S-VIDEO
Better quality than standard composition. Supports standard definition video only (480i).

10 USB INPUT

Used for viewing photos and listening to MP3s.

11 Power Cord Socket

For operation with AC power.
Caution: Never attempt to operate the TV on DC power.

PREPARATION

STAND INSTRUCTION

■ Image shown may differ from your TV.

INSTALLATION (Only 37/42LG50, 42LG50DC)

- 1 Carefully place the TV screen side down on a cushioned surface to protect the screen from damage.

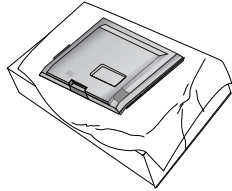

- 2 Assemble the parts of the **STAND BODY** with **COVER BASE** of the TV.

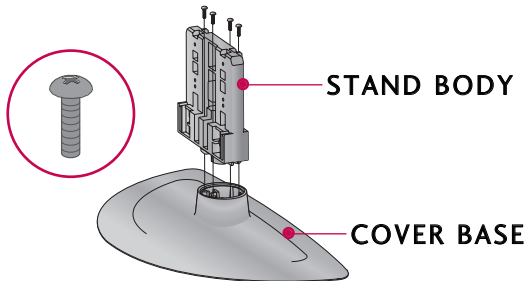

- 3 Assemble the TV as shown.

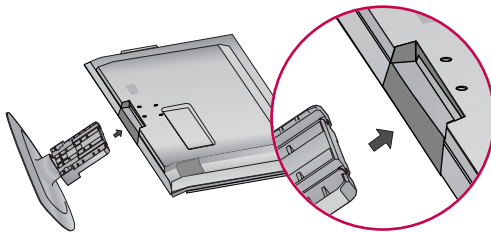

- 4 Fix the 4 bolts securely using the holes in the back of the TV.

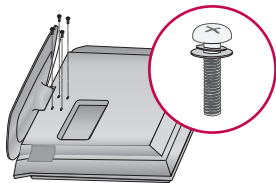

! NOTE

- ▶ When assembling the desk type stand, make sure the bolt is fully tightened (If not tightened fully, the TV can tilt forward after the product installation). Do not over tighten.

DETACHMENT

- 1 Carefully place the TV screen side down on a cushioned surface to protect the screen from damage.

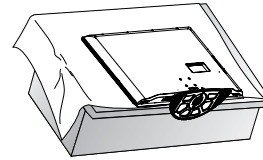

- 2 Loosen the bolts from TV.

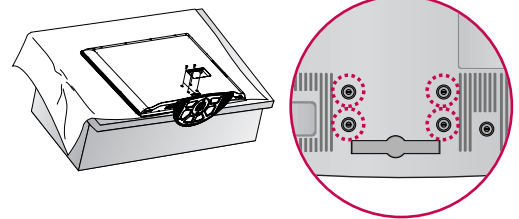

- 3 Detach the stand from TV.

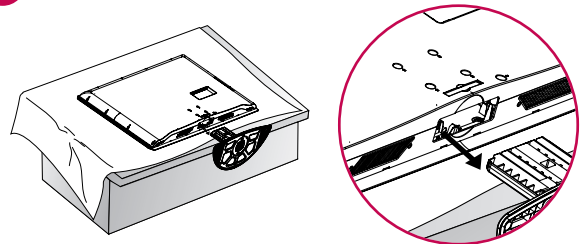

PROTECTION COVER

After removing the stand, install the included **protection cover** over the hole for the stand.

Press the **PROTECTION COVER** into the TV until you hear it click.

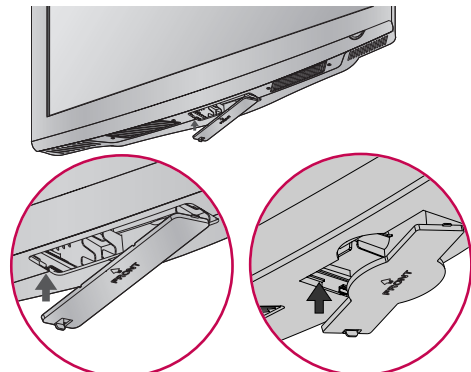

VESA WALL MOUNTING

Install your wall mount on a solid wall perpendicular to the floor. When attaching to other building materials, please contact your nearest dealer.

If installed on a ceiling or slanted wall, it may fall and result in severe personal injury.

We recommend that you use an LG brand wall mount when mounting the TV to a wall.

LG recommends that wall mounting be performed by a qualified professional installer.

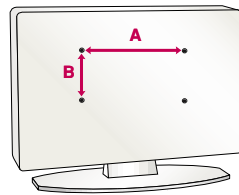

| Product | Model | VESA (A * B) | Standard Screw | Quantity |
|---------|--------------------------------------|--------------|----------------|----------|
| LCD TV | 37LG50 42LG50, 42LG50DC 47LG50 | 200 * 200 | M6 | 4 |
| | 52LG50 | 800 * 400 | M6 | 4 |

! NOTE

- ▶ Screw length needed depends on the wall mount used. For further information, refer to the instructions included with the mount.
- ▶ Standard dimensions for wall mount kits are shown in the table.
- ▶ When purchasing our wall mount kit, a detailed installation manual and all parts necessary for assembly are provided.
- ▶ Do not use screws longer than the standard dimension, as they may cause damage to the inside of the TV.
- ▶ For wall mounts that do not comply with the VESA standard screw specifications, the length of the screws may differ depending on their specifications.
- ▶ Do not use screws that do not comply with the VESA standard screw specifications. Do not use fasten the screws too strongly, this may damage the TV or cause the TV to a fall, leading to personal injury. LG is not liable for these kinds of accidents.
- ▶ LG is not liable for TV damage or personal injury when a non-VESA or non specified wall mount is used or the consumer fails to follow the TV installation instructions.

! CAUTION

- ▶ Do not install your wall mount kit while your TV is turned on. It may result in personal injury due to electric shock.

PREPARATION

CABLE MANAGEMENT

■ Image shown may differ from your TV.

PREPARATION

- 1 Connect the cables as necessary.
To connect additional equipment, see the **EXTERNAL EQUIPMENT SETUP** section.

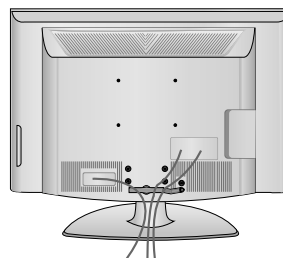

- 2 Install the **CABLE MANAGEMENT CLIP** as shown.

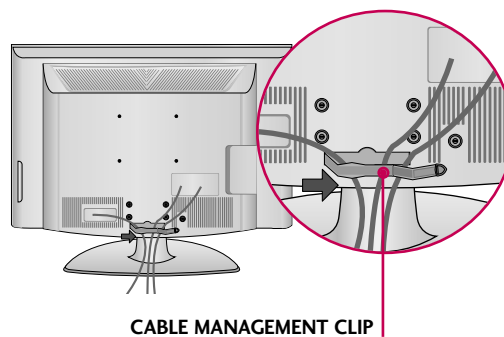

- 3 Put the cables inside the **CABLE MANAGEMENT CLIP** and snap it closed.

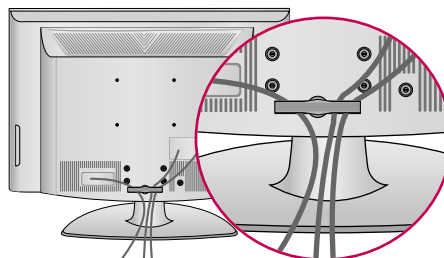

DESKTOP PEDESTAL INSTALLATION

▪ Image shown may differ from your TV.

For proper ventilation, allow a clearance of 4 inches on all four sides from the wall.

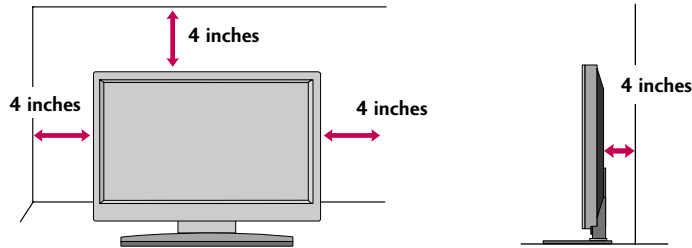

⚠ CAUTION

- ▶ Ensure adequate ventilation by following the clearance recommendations.
- ▶ Do not mount near or above any type of heat source.

SWIVEL STAND

After installing the TV, you can adjust the TV set manually to the left or right direction by 20 degrees to suit your viewing position.

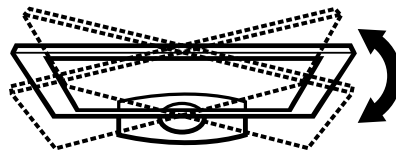

ATTACHING THE TV TO A DESK (Only 37/42LG50, 42LG50DC)

The TV must be attached to a desk so it cannot be pulled in a forward/backward direction, potentially causing injury or damaging the product.

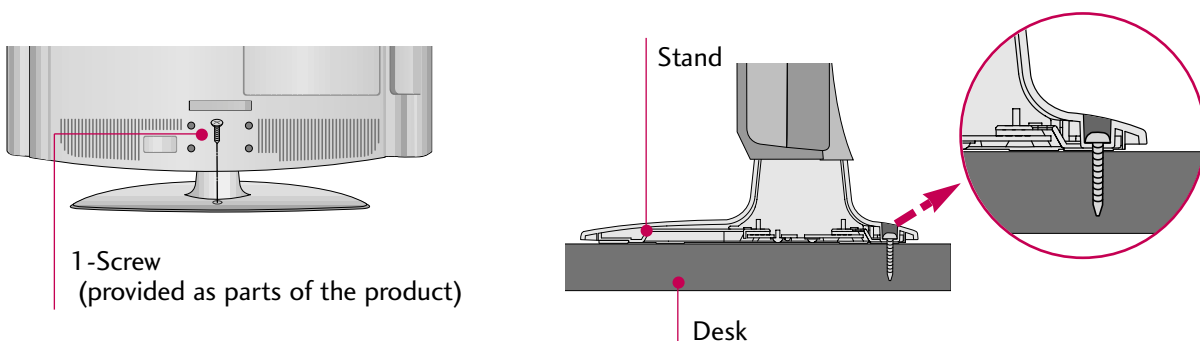

⚠ WARNING

- ▶ To prevent TV from falling over, the TV should be securely attached to the floor/wall per installation instructions. Tipping, shaking, or rocking the machine may cause injury.

PREPARATION

PREPARATION

SECURING THE TV TO THE WALL TO PREVENT FALLING WHEN THE TV IS USED ON A STAND

- You should purchase necessary components to prevent TV from falling off of the stand.
- Image shown may differ from your TV.

We recommend that you set up the TV close to a wall so it cannot fall over if pushed backwards. Additionally, we recommend that the TV be attached to a wall so it cannot be pulled in a forward direction, potentially causing injury or damaging the product.

Caution: Please make sure that children don't climb on or hang from the TV.

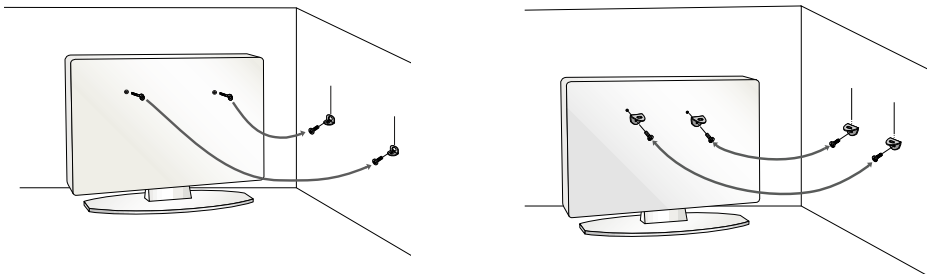

- Insert the eye-bolts (or TV brackets and bolts) to tighten the product to the wall as shown in the picture.

* If your product has the bolts in the eye-bolts position before inserting the eye-bolts, loosen the bolts.

* Insert the eye-bolts or TV brackets/bolts and tighten them securely in the upper holes.

Secure the wall brackets with the bolts (sold separately) to the wall. Match the height of the bracket that is mounted on the wall to the holes in the product.

Ensure the eye-bolts or brackets are tightened securely.

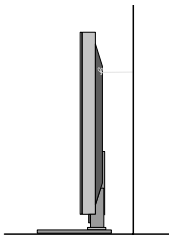

- Use a sturdy rope (sold separately) to tie the product. It is safer to tie the rope so it becomes horizontal between the wall and the product.

! NOTE

- ▶ Use a platform or cabinet strong enough and large enough to support the size and weight of the TV.
- ▶ To use the TV safely make sure that the height of the bracket on the wall and the one on the TV are the same.

- To prevent damage do not connect to the power outlet until all connections are made between the devices.

ANTENNA OR CABLE CONNECTION

1. Antenna (Analog or Digital)

Wall Antenna Socket or Outdoor Antenna without a Cable Box Connection.

For optimum picture quality, adjust the antenna direction if needed.

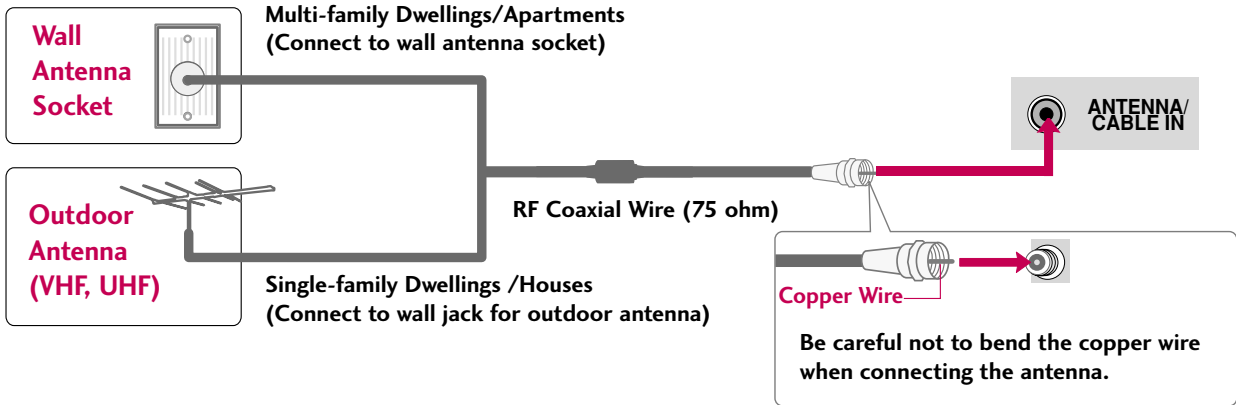

2. Cable

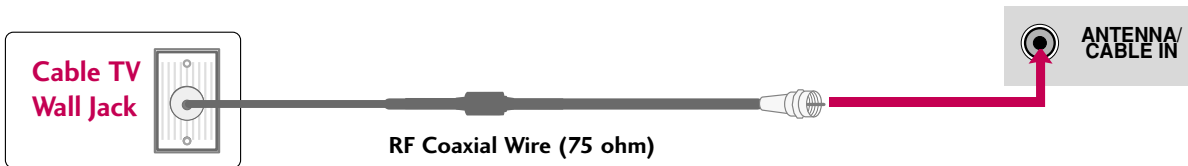

- To improve the picture quality in a poor signal area, please purchase a signal amplifier and install properly.
- If the antenna needs to be split for two TV's, install a 2-Way Signal Splitter.
- If the antenna is not installed properly, contact your dealer for assistance.

EXTERNAL EQUIPMENT SETUP

- To prevent the equipment damage, never plug in any power cords until you have finished connecting all equipment.
- Image shown may differ from your TV.

HD RECEIVER SETUP

This TV can receive digital over-the-air/digital cable signals without an external digital set-top box. However, if you do receive digital signals from a digital set-top box or other digital external device.

Component Connection

1. How to connect

- 1 Connect the video outputs (Y, PB, PR) of the digital set-top box to the **COMPONENT IN VIDEO 1** jacks on the TV. Match the jack colors (Y = green, PB = blue, and PR = red).
- 2 Connect the audio output of the digital set-top box to the **COMPONENT IN AUDIO 1** jacks on the TV.

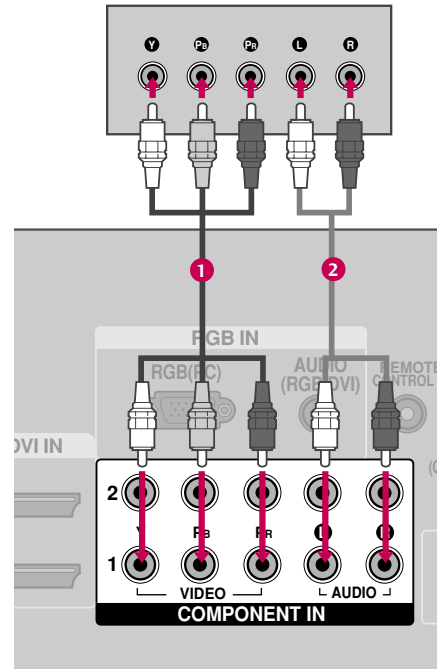

2. How to use

- Turn on the digital set-top box.
(Refer to the owner's manual for the digital set-top box operation)
- Select the **Component 1** input source on the TV using the **INPUT** button on the remote control.
- If connected to **COMPONENT IN2** input, select the **Component 2** input source on the TV.

Supported Resolutions

| Signal | Component | HDMI |
|--------|-----------|------|
| 480i | Yes | No |
| 480p | Yes | Yes |
| 720p | Yes | Yes |
| 1080i | Yes | Yes |
| 1080p | Yes | Yes |

Y, Cb/Pb, Cr/Pr

| Resolution | Horizontal Frequency(KHz) | Vertical Frequency(Hz) |
|------------|---------------------------|------------------------|
| 720x480i | 15.73 | 59.94 |
| | 15.73 | 60.00 |
| 720x480p | 31.47 | 59.94 |
| | 31.50 | 60.00 |
| 1280x720p | 44.96 | 59.94 |
| | 45.00 | 60.00 |
| 1920x1080i | 33.72 | 59.94 |
| | 33.75 | 60.00 |
| 1920x1080p | 26.97 | 23.976 |
| | 27.00 | 24.00 |
| | 33.71 | 29.97 |
| | 33.75 | 30.00 |
| | 67.432 | 59.94 |
| | 67.50 | 60.00 |

HDMI Connection

1. How to connect

- 1 Connect the digital set-top box to **HDMI/DVI IN1**, **2**, or **3*** jack on the TV.
- 2 No separate audio connection is necessary. HDMI supports both audio and video.

2. How to use

- Turn on the digital set-top box.
(Refer to the owner's manual for the digital set-top box.)
- Select the **HDMI1**, **HDMI2**, or **HDMI3*** input source on the TV using the **INPUT** button on the remote control.

* HDMI 3: Except 42LG50DC

HDMI-DTV

| Resolution | Horizontal Frequency(KHz) | Vertical Frequency(Hz) |
|------------|---------------------------|------------------------|
| 720x480p | 31.47 | 59.94 |
| | 31.50 | 60.00 |
| 1280x720p | 44.96 | 59.94 |
| | 45.00 | 60.00 |
| 1920x1080i | 33.72 | 59.94 |
| | 33.75 | 60.00 |
| 1920x1080p | 26.97 | 23.976 |
| | 27.00 | 24.00 |
| | 33.71 | 29.97 |
| | 33.75 | 30.00 |
| | 67.432 | 59.939 |
| | 67.50 | 60.00 |

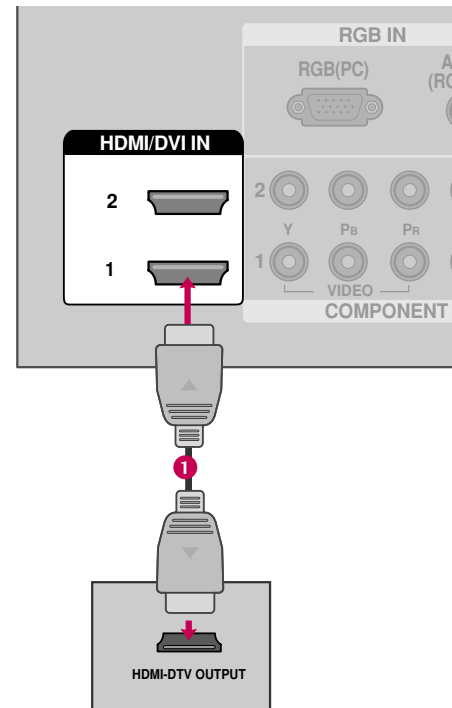

EXTERNAL EQUIPMENT SETUP

DVI to HDMI Connection

1. How to connect

- 1 Connect the DVI output of the digital set-top box to the **HDMI/DVI IN 1, 2, or 3*** jack on the TV.
- 2 Connect the PC audio output to the **AUDIO (RGB/DVI)** jack on the TV.

2. How to use

- Turn on the digital set-top box. (Refer to the owner's manual for the digital set-top box.)
- Select the **HDMI1, HDMI2, or HDMI3*** input source on the TV using the **INPUT** button on the remote control.

* *HDMI 3: Except 42LG50DC*

! NOTE

- ▶ A DVI to HDMI cable or adapter is required for this connection. DVI doesn't support audio, so a separate audio connection is necessary.

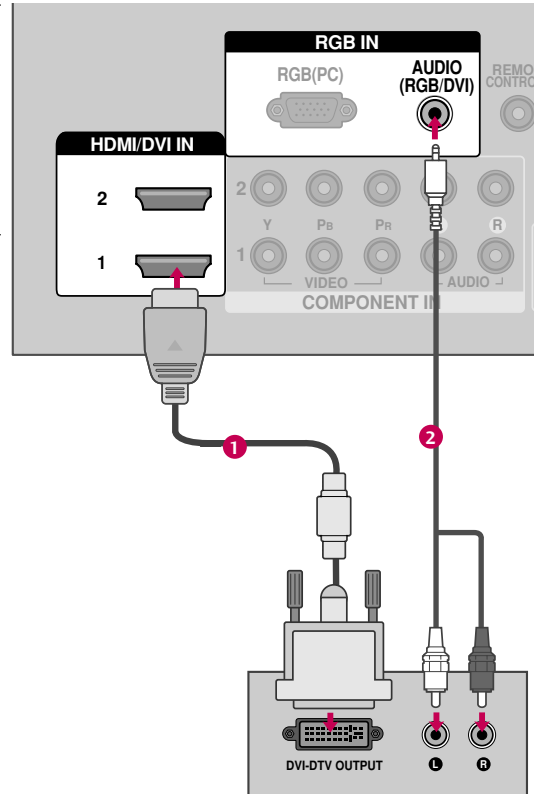

DVD SETUP

Component Connection

1. How to connect

- 1 Connect the video outputs (Y, PB, PR) of the DVD to the **COMPONENT IN VIDEO1** jacks on the TV. Match the jack colors (Y = green, PB = blue, and PR = red).
- 2 Connect the audio outputs of the DVD to the **COMPONENT IN AUDIO1** jacks on the TV.

2. How to use

- Turn on the DVD player, insert a DVD.
- Select the **Component 1** input source on the TV using the **INPUT** button on the remote control.
- If connected to **COMPONENT IN 2** input, select the **Component 2** input source on the TV.
- Refer to the DVD player's manual for operating instructions.

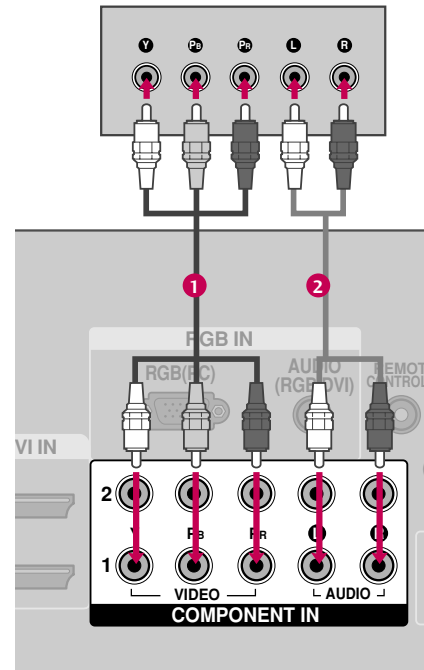

Component Input ports

To get better picture quality, connect a DVD player to the component input ports as shown below.

| Component ports on the TV | Y | P _B | P _R |
|-------------------------------------|---|----------------|----------------|
| Video output ports on DVD player | Y | P _B | P _R |
| | Y | B-Y | R-Y |
| | Y | C _b | C _r |
| | Y | P _b | P _r |

EXTERNAL EQUIPMENT SETUP

S-Video Connection

1. How to connect

- 1 Connect the S-VIDEO output of the DVD to the S-VIDEO input on the TV.
- 2 Connect the audio outputs of the DVD to the AUDIO input jacks on the TV.

2. How to use

- Turn on the DVD player, insert a DVD.
- Select the **AV1** input source on the TV using the **INPUT** button on the remote control.
- Refer to the DVD player's manual for operating instructions.

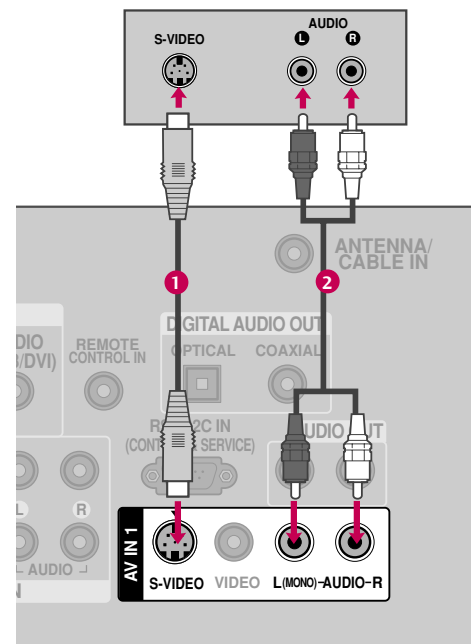

HDMI Connection

1. How to connect

- 1 Connect the HDMI output of the DVD to the HDMI/DVI IN1, 2, or 3* jack on the TV.
- 2 No separate audio connection is necessary. HDMI supports both audio and video.

2. How to use

- Select the **HDMI1**, **HDMI2**, or **HDMI3*** input source on the TV using the **INPUT** button on the remote control.
- Refer to the DVD player's manual for operating instructions.

* HDMI 3: Except 42LG50DC

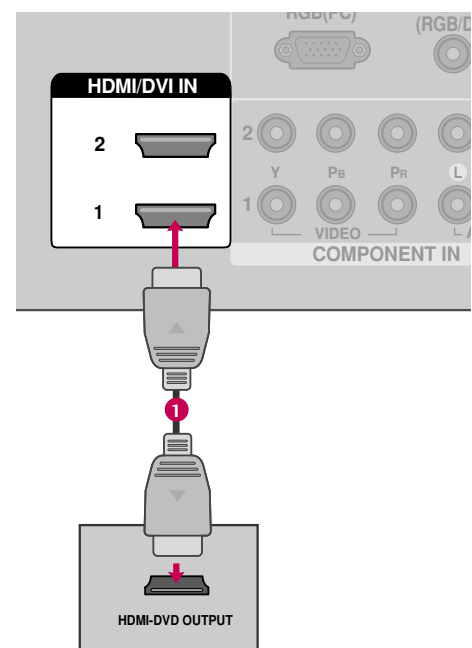

VCR SETUP

- To avoid picture noise (interference), leave an adequate distance between the VCR and TV.
- If the 4:3 picture format is used; the fixed images on the sides of the screen may remain visible on the screen. This phenomenon is common to all TVs and is not covered by warranty.

Antenna Connection

1. How to connect

- 1 Connect the RF antenna out socket of the VCR to the **ANTENNA/CABLE IN** socket on the TV.
- 2 Connect the antenna cable to the RF antenna in socket of the VCR.

2. How to use

- Set VCR output switch to 3 or 4 and then tune TV to the same channel number.
- Insert a video tape into the VCR and press **PLAY** on the VCR. (Refer to the VCR owner's manual.)

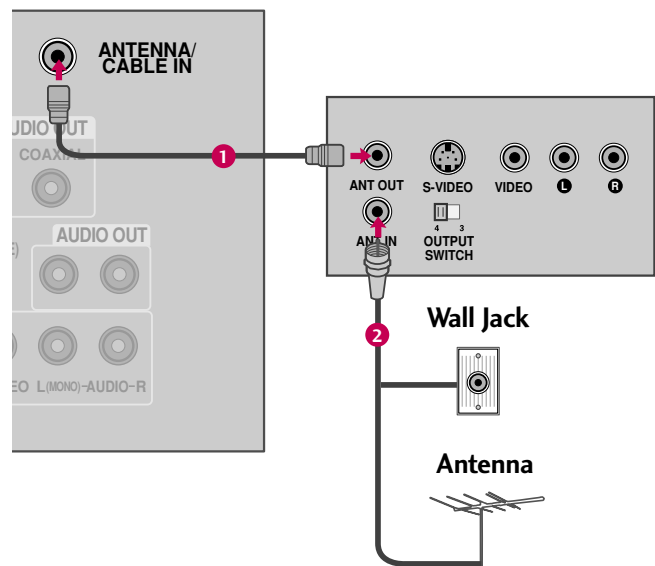

EXTERNAL EQUIPMENT SETUP

Composite (RCA) Connection

1. How to connect

- 1 Connect the **AUDIO/VIDEO** jacks between TV and VCR. Match the jack colors (Video = yellow, Audio Left = white, and Audio Right = red)

2. How to use

- Insert a video tape into the VCR and press PLAY on the VCR. (Refer to the VCR owner's manual.)
- Select the **AV1** input source on the TV using the **INPUT** button on the remote control.
- If connected to **AV IN2**, select **AV2** input source on the TV.

NOTE

- ▶ If you have a mono VCR, connect the audio cable from the VCR to the **AUDIO L/MONO** jack of the TV.

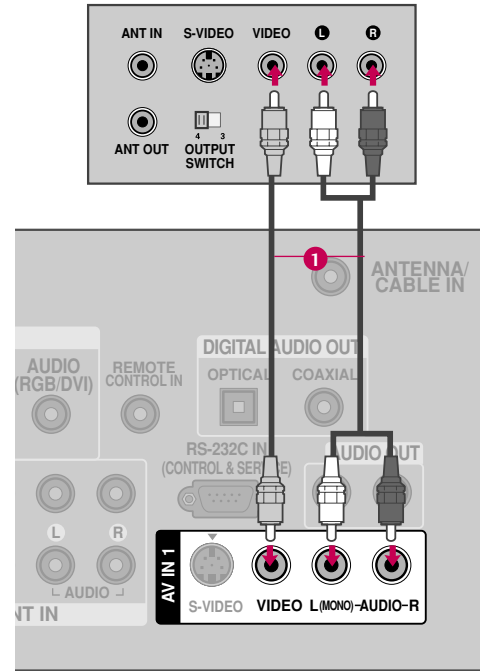

S-Video Connection

1. How to connect

- 1 Connect the S-VIDEO output of the VCR to the **S-VIDEO** input on the TV.
- 2 Connect the audio outputs of the VCR to the **AUDIO** input jacks on the TV.

2. How to use

- Insert a video tape into the VCR and press PLAY on the VCR. (Refer to the VCR owner's manual.)
- Select the **AV1** input source on the TV using the **INPUT** button on the remote control.

CAUTION

- ▶ Do not connect to both Video and S-Video at the same time. In the event that you connect both Video and the S-Video cables, only the S-Video will work.

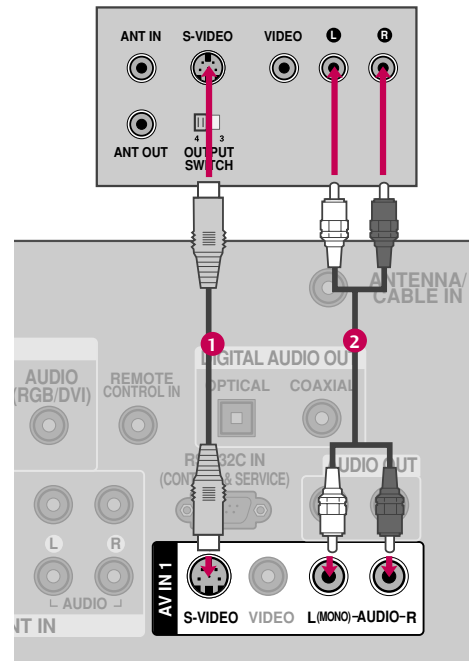

NOTE

- ▶ S-Video provides better quality than composite. Use it when available.

OTHER A/V SOURCE SETUP

1. How to connect

- 1 Connect the **AUDIO/VIDEO** jacks between TV and external equipment. Match the jack colors. (Video = yellow, Audio Left = white, and Audio Right = red)

2. How to use

- Select the **AV2** input source on the TV using the **INPUT** button on the remote control.
- If connected to **AV IN1** input, select the **AV1** input source on the TV.
- Operate the corresponding external equipment.

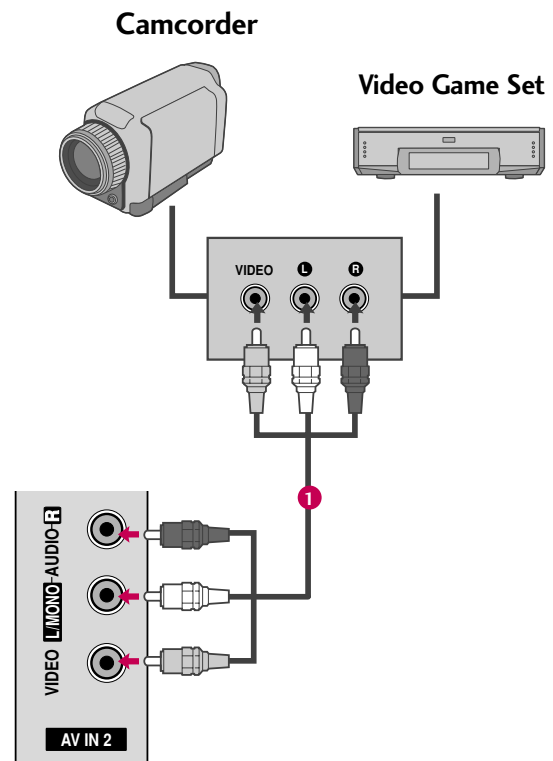

EXTERNAL EQUIPMENT SETUP

PC SETUP

This TV provides Plug and Play capability, meaning that the PC adjusts automatically to the TV's settings.

VGA (D-Sub 15 pin) Connection

1. How to connect

- 1 Connect the VGA output of the PC to the **RGB (PC)** jack on the TV.
- 2 Connect the PC audio output to the **AUDIO (RGB/DVI)** jack on the TV.

2. How to use

- Turn on the PC and the TV.
- Select the **RGB-PC** input source on the TV using the **INPUT** button on the remote control.

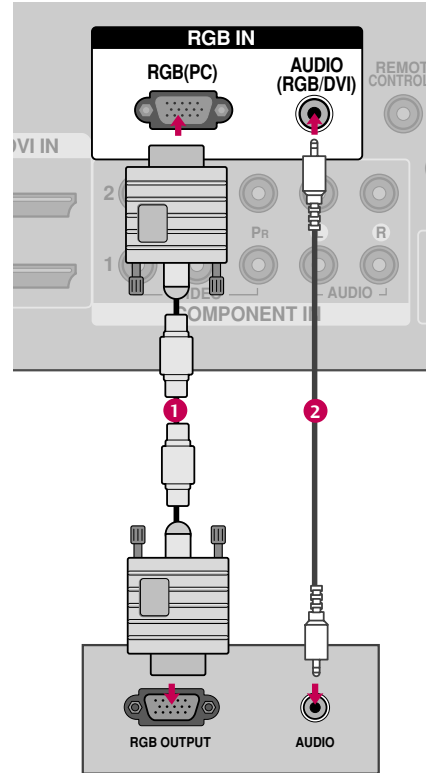

DVI to HDMI Connection

1. How to connect

- 1 Connect the DVI output of the PC to the **HDMI/DVI IN 1, 2, or 3*** jack on the TV.
- 2 Connect the PC audio output to the **AUDIO (RGB/DVI)** jack on the TV.

2. How to use

- Turn on the PC and the TV.
- Select the **HDMI1, HDMI2, or HDMI3*** input source on the TV using the **INPUT** button on the remote control.

* HDMI 3: Except 42LG50DC

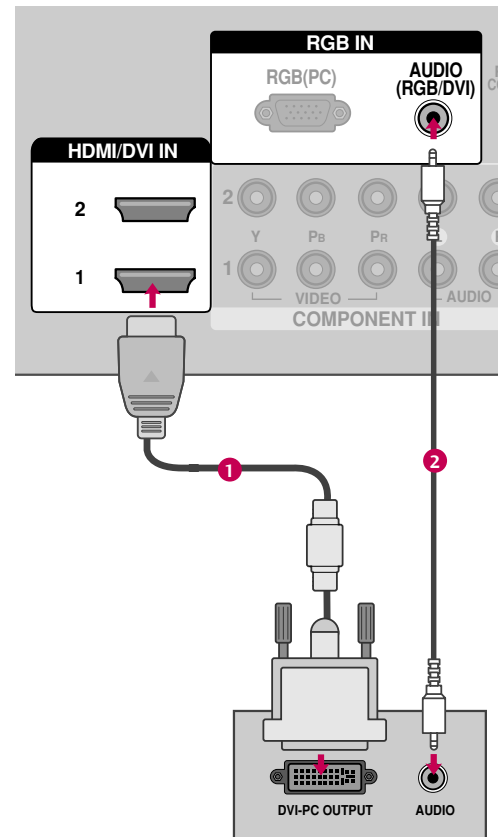

! NOTES

- ▶ To get the the best picture quality, adjust the PC graphics card to 1920x1080.
- ▶ Depending on the graphics card, DOS mode may not work if a HDMI to DVI Cable is in use.
- ▶ In PC mode, there may be noise associated with the resolution, vertical pattern, contrast or brightness. If noise is present, change the PC output to another resolution, change the refresh rate to another rate or adjust the brightness and contrast on the PICTURE menu until the picture is clear.
- ▶ Avoid keeping a fixed image on the screen for a long period of time. The fixed image could become permanently imprinted on the screen.
- ▶ The synchronization input form for Horizontal and Vertical frequencies is separate.
- ▶ Depending on the graphics card, some resolution settings may not allow the image to be positioned on the screen properly.
- ▶ If there are overscan in HDMI-PC 1920x1080, change aspect ratio to **Just scan**.

Supported Display Specifications (RGB-PC, HDMI-PC)

| Resolution | Horizontal Frequency(KHz) | Vertical Frequency(Hz) |
|----------------------|---------------------------|------------------------|
| 640x350 | 31.468 | 70.09 |
| 720x400 | 31.469 | 70.08 |
| 640x480 | 31.469 | 59.94 |
| 800x600 | 35.156 37.879 | 56.25 60.31 |
| 1024x768 | 48.363 56.476 | 60.00 70.06 |
| 1280x768 | 47.776 | 59.87 |
| 1280x1024 | 63.981 | 60.02 |
| 1360x768 | 47.712 | 60.015 |
| 1600x1200 | 75.00 | 60.00 |
| 1920x1080 RGB-PC | 62.95 | 55.96 |
| 1920x1080 HDMI-PC | 67.5 | 60.00 |

EXTERNAL EQUIPMENT SETUP





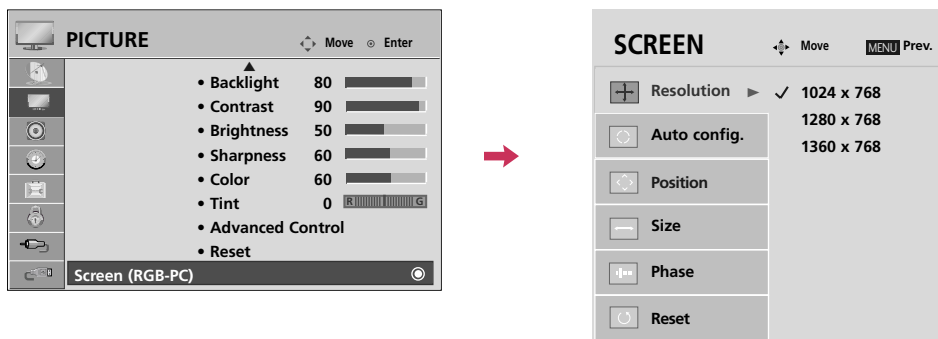

Screen Setup for PC mode

Selecting Resolution

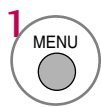
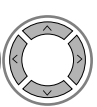
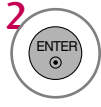
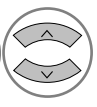
You can choose the resolution in RGB-PC mode.

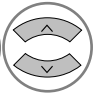
The **Position**, **Phase**, and **Size** can also be adjusted.

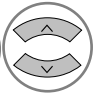







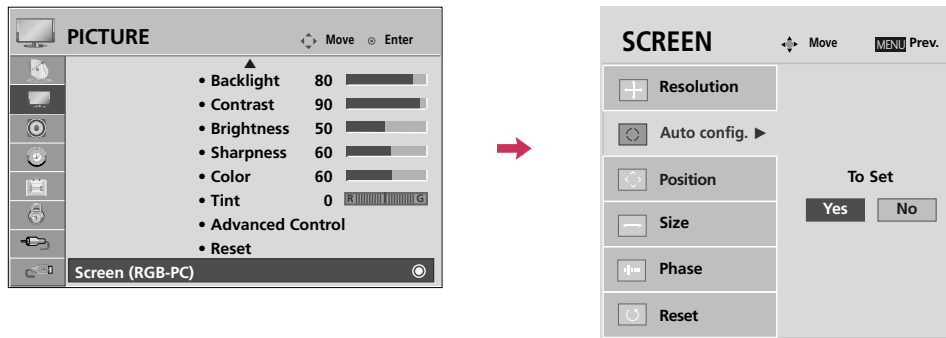

-   Select **PICTURE**.
-   Select **Screen (RGB-PC)**.
-   Select **Resolution**.
-   Select the desired resolution.
- 

Auto Configure

Automatically adjusts picture position and minimizes image instability. After adjustment, if the image is still not correct, try using the manual settings or a different resolution or refresh rate on the PC.



- 1   Select **PICTURE**.
- 2   Select **Screen (RGB-PC)**.
- 3   Select **Auto config.**
- 4   Select **Yes**.
- 5  Start Auto Configuration.

- If the position of the image is still not correct, try Auto adjustment again.
- If picture needs to be adjusted again after Auto adjustment in RGB-PC, you can adjust the **Position**, **Size** or **Phase**.







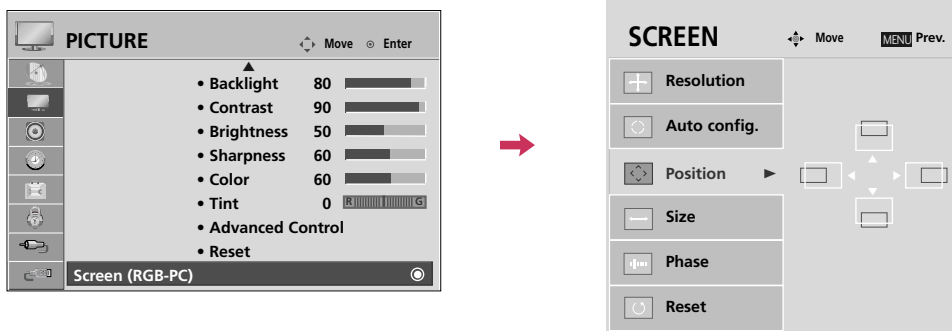

EXTERNAL EQUIPMENT SETUP

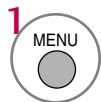
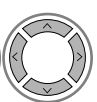
Adjustment for screen Position, Size, and Phase

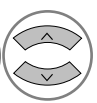
If the picture is not clear after auto adjustment and especially if characters are still trembling, adjust the picture phase manually.

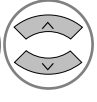
This feature operates only in RGB-PC mode.

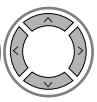









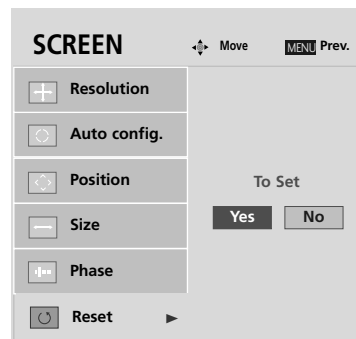
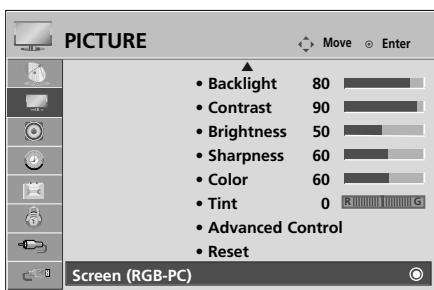

-   Select **PICTURE**.
-   Select **Screen (RGB-PC)**.
-   Select **Position, Size, or Phase**.
-   Make appropriate adjustments.
- 

- **Position:** This function is to adjust picture to left/right and up/down as you prefer.
- **Size:** This function is to minimize any vertical bars or stripes visible on the screen background. And the horizontal screen size will also change.
- **Phase:** This function allows you to remove any horizontal noise and clear or sharpen the image of characters.

Screen Reset (Reset to original factory values)

Returns **Position**, **Size**, and **Phase** to the default factory settings.
This feature operates only in RGB-PC mode.



- 1   Select **PICTURE**.
- 2   Select **Screen (RGB-PC)**.
- 3   Select **Reset**.
- 4   Select **Yes**.
- 5 

EXTERNAL EQUIPMENT SETUP

USB CONNECTION

1. How to connect

- 1 Connect the USB device to the **USB IN** jack on the side of TV.

2. How to use

- After connecting the **USB IN** jack, you use the USB function.
(▶ p.48)

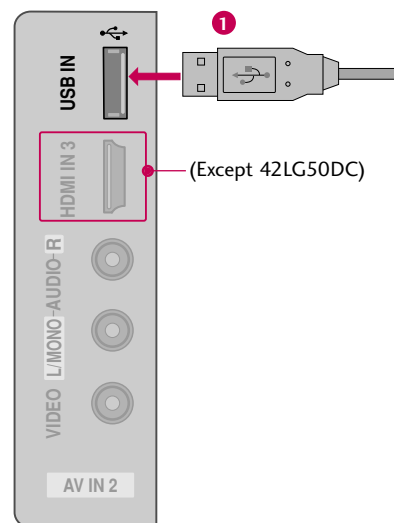

AUDIO OUT CONNECTION

Send the TV's audio to external audio equipment via the Audio Output port.

Analog

1. How to connect

- 1 Connect audio outputs to the TV's **AUDIO OUT** jacks.
- 2 Set the "TV Speaker option - Off" in the AUDIO menu. (▶ p.73). See the external audio equipment instruction manual for operation.

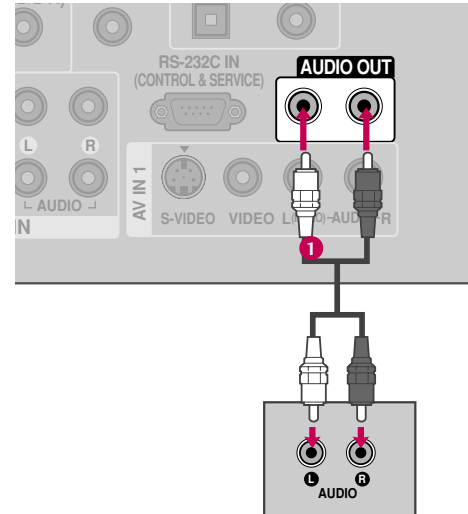

Digital

1. How to connect

- 1 Connect one end of the optical or coaxial cable to the TV's **OPTICAL** or **COAXIAL** port of **DIGITAL AUDIO OUT**.
- 2 Connect the other end of the optical or coaxial cable to the digital audio input on the audio equipment.
- 3 Set the "TV Speaker option - Off" in the AUDIO menu. (▶ p.73). See the external audio equipment instruction manual for operation.

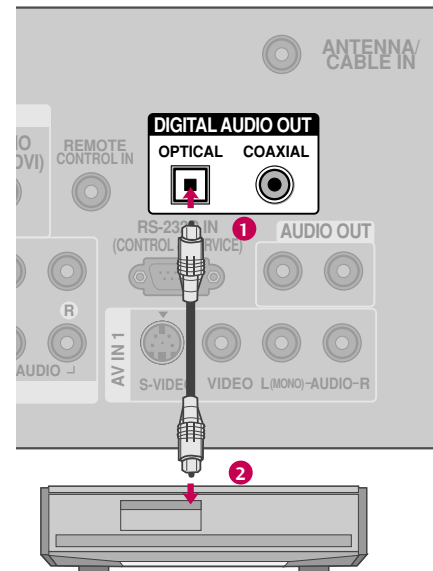

NOTE

- ▶ When connecting with external audio equipments, such as amplifiers or speakers, you can turn the TV speakers off in the menu. (▶ p.73)

CAUTION

- ▶ Do not look into the optical output port. Looking at the laser beam may damage your vision.
- ▶ Block the SPDIF out (optical/coaxial) about the contents with ACP(Audio Copy Protection) function.

WATCHING TV / CHANNEL CONTROL

REMOTE CONTROL FUNCTIONS

When using the remote control, aim it at the remote control sensor on the TV.

TV/STB/DVD/VCR Select the remote operating mode: TV, STB, DVD, or VCR.

POWER Turns your TV or any other programmed equipment on or off, depending on the mode.

Q.MENU Select the desired quick menu source. ▶ p.37

MENU Displays the main menu.
Clear all on-screen displays and return to TV viewing from any menu.

INPUT External input modes rotate in regular sequence.

VOLUME UP / DOWN Increase/decrease the sound level.

FAV Scroll through the programmed Favorite channels. ▶ p.37

MUTE Switch the sound on or off. ▶ p.36

CHANNEL UP/DOWN Select available channels.

PAGE UP/DOWN Move from one full set of screen information to the next one.

NUMBER button

— (DASH) Used to enter a program number for multiple program channels such as 2-1, 2-2, etc.

FLASHBK Tune to the last channel viewed.

VCR/DVD, USB, SIMPLINK Control buttons

- Control video cassette recorders or DVD players.
- Control USB menu (Photo List and Music List.)
- Control the SIMPLINK compatible devices.

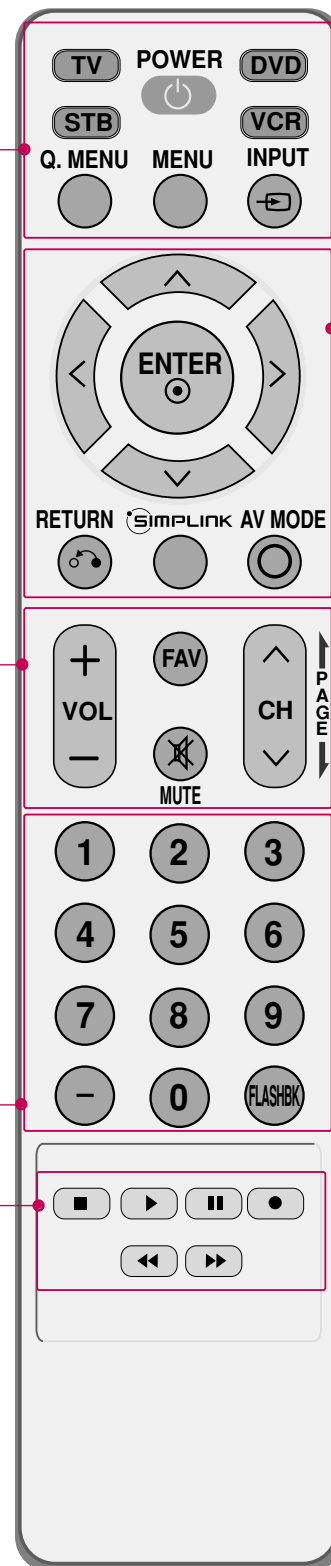

THUMBSTICK (Up/Down/Left Right/ENTER) Navigate the on-screen menus and adjust the system settings to your preference.

RETURN Allows the user to move return one step in an interactive application or other user interaction function.

SIMPLINK See a list of AV devices connected to TV.
When you toggle this button, the SIMPLINK menu appears at the screen. ► p.46-47

AV MODE It helps you select and set images and sounds. ► p.45

Installing Batteries

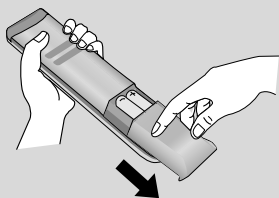

- Open the battery compartment cover on the back side and install the batteries matching correct polarity (+with +,-with -).
- Install two 1.5V AAA batteries. Don't mix old or used batteries with new ones.
- Close cover.

WATCHING TV / CHANNEL CONTROL

TURNING ON THE TV

- 1** First, connect power cord correctly.
At this moment, the TV switches to standby mode.
 - In standby mode to turn TV on, press the $\phi/|$, **INPUT**, **CH (^ v)** button on the TV or press the **POWER**, **INPUT**, **CH (^ or v)**, **Number (0~9)** button on the remote control.
 - 2** Select the viewing source by using the **INPUT** button on the remote control.
 - This TV is programmed to remember which power state it was last set to, even if the power cord is out.
 - 3** When finished using the TV, press the **POWER** button on the remote control. The TV reverts to standby mode.
-

! NOTE

- ▶ If you intend to be away on vacation, disconnect the power plug from the wall power outlet.

CHANNEL SELECTION

- 1** Press the **CH (^ or v)** or **NUMBER** buttons to select a channel number.
-

VOLUME ADJUSTMENT

Adjust the volume to suit your personal preference.

- 1** Press the **VOL (+ or -)** button to adjust the volume.
 - 2** If you want to switch the sound off, press the **MUTE** button.
 - 3** You can cancel the Mute function by pressing the **MUTE** or **VOL (+ or -)** button.
-



QUICK MENU

Your TV's OSD (On Screen Display) may differ slightly from what is shown in this manual.

Q.Menu (Quick Menu) is a menu of features which users might use frequently.

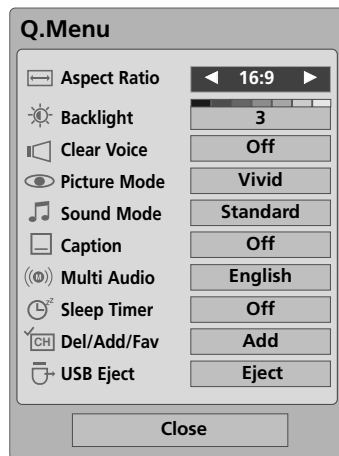
- **Aspect Ratio:** Selects your desired picture format.
- **Backlight:** Adjust the brightness of LCD panel to control the brightness of the screen.
- **Clear Voice:** By differentiating the human sound range from others, it helps make human voices sound better.
- **Picture Mode:** Selects the factory preset picture depend on the viewing environment.
- **Sound Mode:** Selects the factory preset sound for type of program.
- **Caption:** Select on or off.
- **Multi Audio:** Changes the audio language (Digital signal).
SAP: Selects MTS sound (Analog signal).
- **Sleep Timer:** Select the amount of time before your TV turns off automatically.
- **Del/Add/Fav:** Select channel you want to add/delete or add the channel to the Favorite List.
- **USB Eject:** Select "USB Eject" in order to eject USB device.



1   Display each menu.

2  Make appropriate adjustments.

3  Return to TV viewing.

WATCHING TV / CHANNEL CONTROL

INITIAL SETTING

This Function guides the user to easily set the essential items for viewing the TV for the first time when purchasing the TV. It will be displayed on the screen when turning the TV on for the first time. It can also be activated from the user menus.

- Default selection is “Home”. We recommend setting the TV to “Home” mode for the best picture in your home environment.
- “In-store” Mode is only intended for use in retail environments. Customers can adjust the “Picture menu - Picture mode” manually while inspecting the TV, but the TV will automatically return to preset in-store mode after 5 minutes.

Step1. Mode Setting

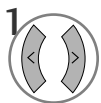

Select **Home** Mode.



Step2. Time Setting

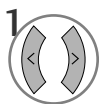
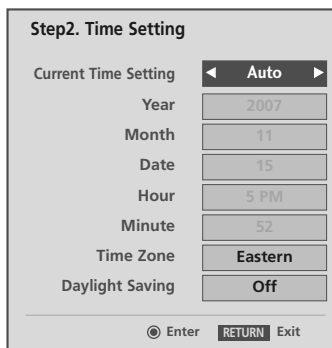

Select **Auto** or **Manual**.



Select desired time option.



Step3. Option Setting

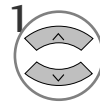
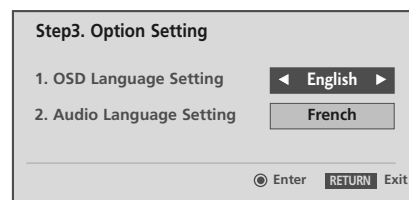

Select **OSD Language Setting** or **Audio Language Setting**.

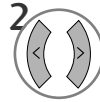

Select your desired language.

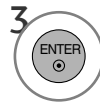

Step4. Auto Tuning

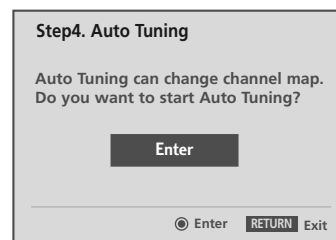

Start **Auto Tuning**.





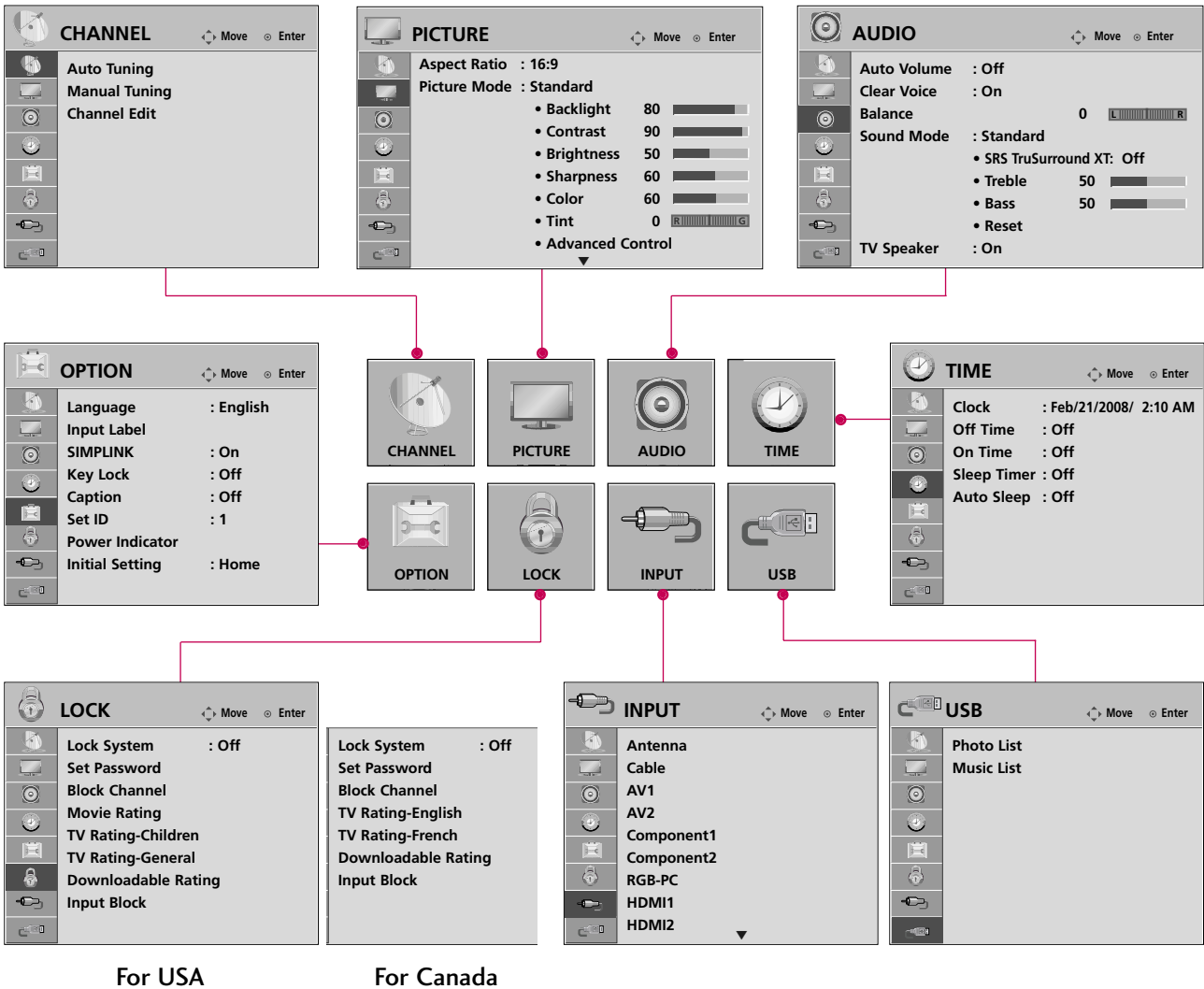

! NOTE

- You can also adjust **Initial Setting** in the **OPTION** menu.

ON-SCREEN MENUS SELECTION

Your TV's OSD (On Screen Display) may differ slightly from that shown in this manual.



- 1   Display each menu.
- 2   Select a menu item.
- 3  Enter to the pop up menu.
- 4  Return to TV viewing.

WATCHING TV / CHANNEL CONTROL







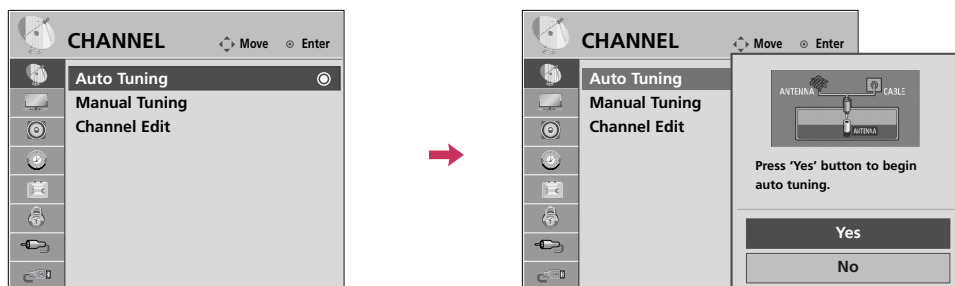

CHANNEL SETUP

Auto Scan (Auto Tuning)

Automatically finds all channels available through antenna or cable inputs, and stores them in memory on the channel list.

Run Auto Tuning again after any Antenna/Cable connection changes.









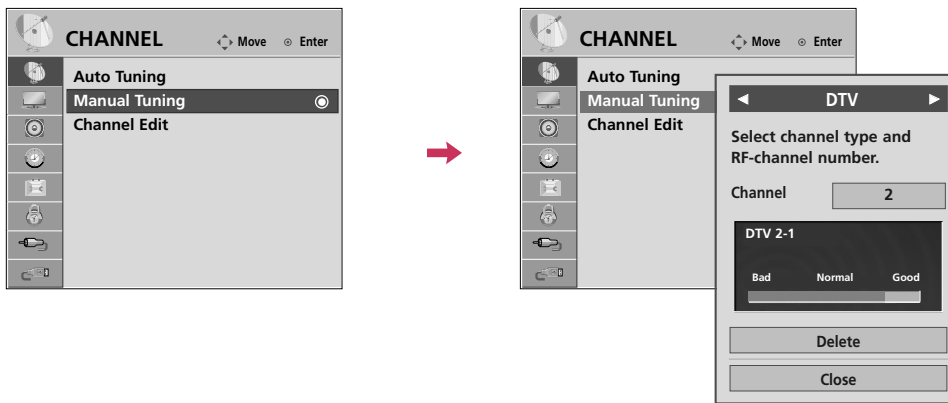

- 1   Select **CHANNEL**.
- 2   Select **Auto Tuning**.
- 3   Select **Yes**.
- 4  Run **Auto tuning**.
- 5  Return to the previous menu.
-  Return to TV viewing.

- A password is required to gain access to Auto Tuning menu if the Lock System is turned on.

Add/Delete Channel (Manual Tuning)

If selecting DTV or CADTV input signal, you can view the on-screen signal strength monitor to see the quality of the signal being received.



- 1   Select **CHANNEL**.
- 2   Select **Manual Tuning**.
- 3   Select **DTV, TV, CADTV, or CATV**.
- 4   Select channel you want to add or delete.
- 5   Select **Add** or **Delete**.
- 6  Return to the previous menu.
-  Return to TV viewing.

- A password is required to gain access to Manual Tuning menu if the Lock System is turned on.

WATCHING TV / CHANNEL CONTROL





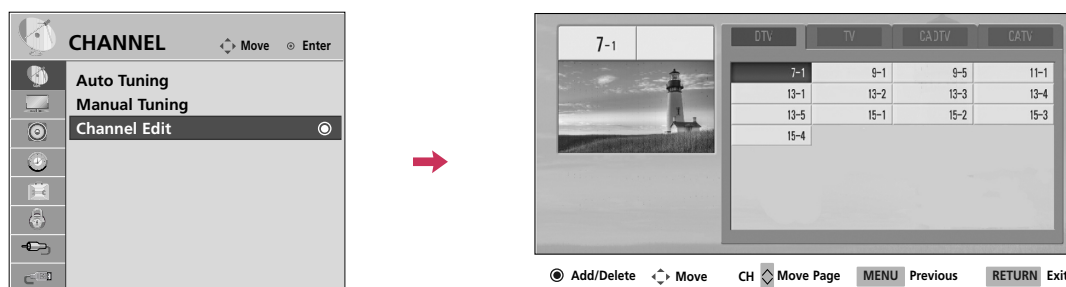

CHANNEL SETUP

Channel Editing

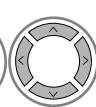
A custom list can be created by toggling each channel on or off with **ENTER** button. The channels in the Custom List are displayed in black and the channels deleted from the Custom List are displayed in gray.

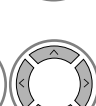
Once a channel is highlighted you can add or delete the channel by referring to the small window at the top-right corner of the screen.



-   Select **CHANNEL**.
-   Select **Channel Edit**.
-   Select a channel.
-  Select channel you want to add or delete.
-  Return to the previous menu.
-  Return to TV viewing.

INPUT LIST

Only these input signals which are connected to a TV can be activated and selected.

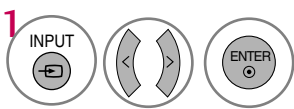

Select the desired input source.

- You can also select the desired input source in the **INPUT** menu.

37/42/47/52LG50

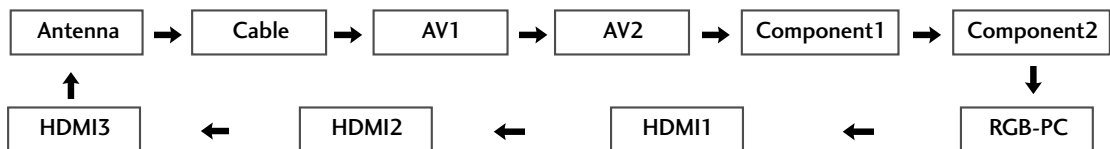

42LG50DC

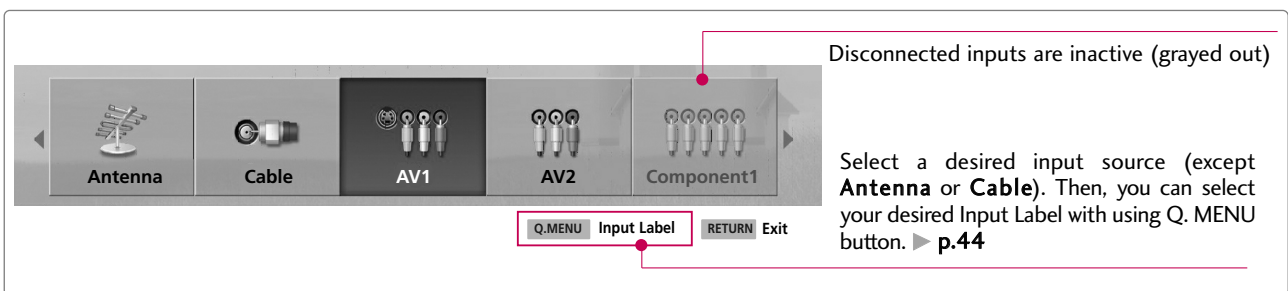
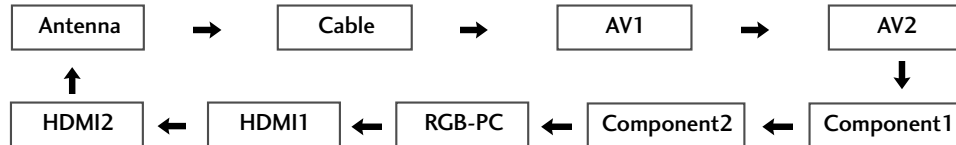

- **Antenna:** Select it to watch over-the-air broadcasts.
- **Cable:** Select it to watch cable and digital cable.
- **AV:** Select them to watch a VCR or other external equipment.
- **Component:** Select them to watch DVD or a Digital set-top box.
- **RGB-PC:** Select it to view PC input.
- **HDMI:** Select them to watch high definition devices.

WATCHING TV / CHANNEL CONTROL

INPUT LABEL

You can set a label for each input source when it's not in use.

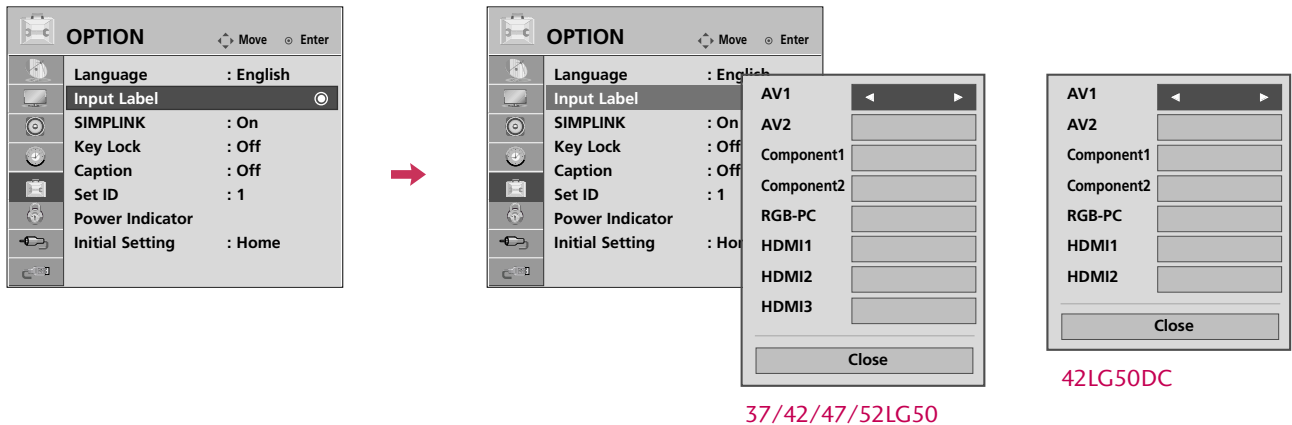

WATCHING TV / CHANNEL CONTROL

With using OPTION menu

- 1 Select **OPTION**.
- 2 Select **Input Label**.
- 3 Select the source.
- 4 Select the label.
- 5 Return to the previous menu.
- Return to TV viewing.

With using INPUT button

- 1 Select the source.
- 2 Select the label.
- 3 Return to the previous menu.
- Return to TV viewing.

- When new external device is connected, this popup menu is displayed automatically. If selecting **Yes**, you can select input source that you want to appreciate.
- But, when selecting “**SIMPLINK - On**”, popup menu for HDMI input will not be displayed.

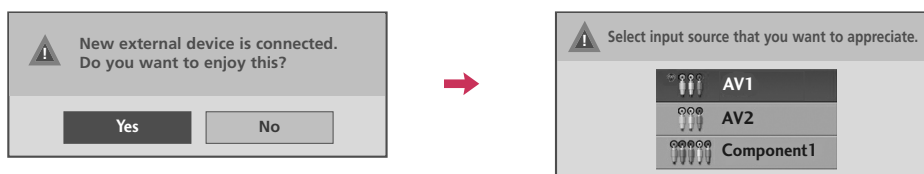

AV MODE

You can select the optimal images and sounds.

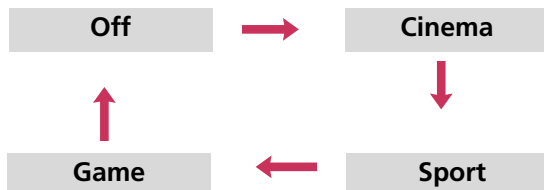

Press the **AV MODE** button repeatedly to select the desired source.



- If you select “**Cinema**” in AV mode, **Cinema** will be selected both for “**PICTURE** menu - Picture Mode” and “**AUDIO** menu - Sound Mode” respectively.
- If you select “**Off**” in AV mode, the “**Picture Mode**” and “**Sound Mode**” return to previous selected value.

WATCHING TV / CHANNEL CONTROL



This function operates only with devices with the logo.

The TV might not function properly when using it with other products with HDMI-CEC function.

This allows you to control and play other AV devices connected with HDMI cable without additional cables and settings.

To start using SIMPLINK, turn it on in the user menus.

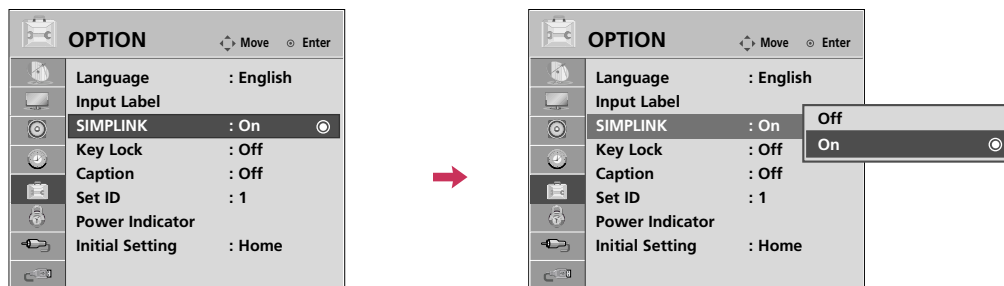

- Select **OPTION**.
- Select **SIMPLINK**.
- Select **On** or **Off**.
- Return to the previous menu.
- Return to TV viewing.

NOTE

- ▶ Connect the HDMI/DVI IN or HDMI IN terminal of the TV to the rear terminal (HDMI terminal) of the SIMPLINK device with the HDMI cable.
- ▶ When you switch the Input source with the INPUT button on the remote control, the SIMPLINK device will stop.
- ▶ When you select a device with home theater functionality, the sound output automatically switches to the home theater speakers.
- ▶ If a connected SIMPLINK home theater system doesn't play the audio from the TV, connect the DIGITAL AUDIO OUT terminal on the back of the TV to the DIGITAL AUDIO IN terminal on the back of the SIMPLINK device with an OPTICAL cable.

SIMPLINK Functions

- **Direct Play:** After connecting AV devices to the TV, you can directly control the devices and play media without additional settings.
- **Select AV device:** Enables you to select one of the AV devices connected to TV.
- **Disc playback:** Control connected AV devices by pressing the \wedge \vee \lt \gt , ENTER, \blacktriangleright , \blacksquare , \parallel , \blacktriangleleft and \blacktriangleright buttons.
- **Power off all devices:** When you power off the TV, all connected devices are turned off.
- **Switch audio-out:** Offers an easy way to switch audio-out.
- **Sync Power on:** When you play the connected AV device, TV will automatically turn on.

(A device, which is connected to the TV through a HDMI cable but does not support SIMPLINK, does not provide this function)

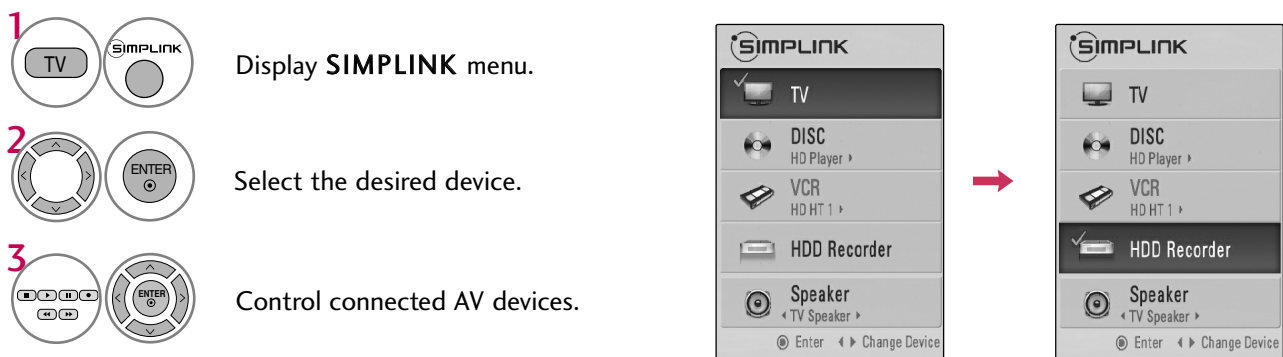

SIMPLINK Menu

- 1 TV viewing:** Switch to the previous TV channel regardless of the current mode.
- 2 DISC playback:** Select and play discs. When multiple discs are available, the titles of discs are conveniently displayed at the bottom of the screen.
- 3 VCR playback:** Control the connected VCR.
- 4 HDD Recordings playback:** Control recordings stored in HDD.
- 5 Audio Out to Home Theater speaker/Audio Out to TV:** Select Home Theater speaker or TV speaker for Audio Out.



- ▶ When no device is connected (displayed in gray)
- ▶ Selected Device
- ▶ When a device is connected (displayed in bright color)

USB

ENTRY MODES

When you connect a USB device, this screen is displayed automatically.
In USB device, you can not add a new folder or delete the existing folder.

- 1 Connect the USB device to the **USB IN** jacks on the side of TV.

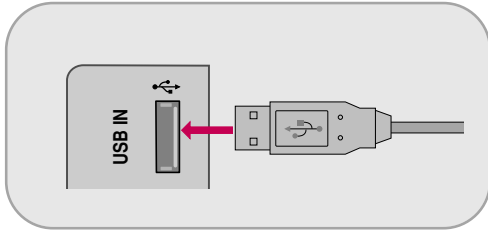

- 2 Select **Photo List** or **Music List**.

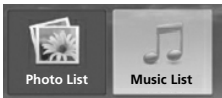
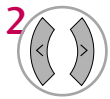

- It doesn't support USB HDD
- This TV supports JPG and MP3.

When removing the USB device

Select the **USB Eject** menu before removing the USB device.

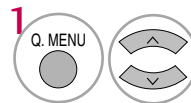

Select **USB Eject**.



Precautions when using the USB device

- ▶ Only a USB storage device is recognizable.
- ▶ If the USB storage device is connected through a USB hub, the device is not recognizable.
- ▶ A USB storage device using an automatic recognition program may not be recognized.
- ▶ A USB storage device which uses its own driver may not be recognized.
- ▶ USB multi-card reader or USB hard drive may not operate smoothly or may not operate at all.
- ▶ The recognition speed of a USB storage device may depend on each device.
- ▶ Please do not turn off the TV or unplug the USB device when the connected USB storage device is working. When such device is suddenly separated or unplugged, the stored files or the USB storage device may be damaged.
- ▶ Please do not connect the USB storage device which was artificially maneuvered on the PC. The device may cause the product to malfunction or fail to be played. Never forget to use only a USB storage device which has normal music files or image files.
- ▶ Please use only a USB storage device which was formatted as a FAT or NTFS file system provided with the Windows operating system. In case of a storage device formatted as a different utility program which is not supported by Windows, it may not be recognized.
- ▶ Please connect power to a USB storage device which requires an external power supply. If not, the device may not be recognized.
- ▶ Please connect a USB storage device with cable is offered by USB maker. If connected with cable is not offered by USB maker or an excessively long cable, the device may not be recognized.
- ▶ Some USB storage devices may not be supported or operated smoothly.
- ▶ Because the TV doesn't support file sorting for USB storage device, the file on the storage device will be displayed in the order saved.
- ▶ Please backup important files because data on USB device may be damaged. Data management is consumer's responsibility and as a result, the manufacturer does not cover data damage.

PHOTO LIST

You can view .JPG files from USB storage devices.
The On Screen Display on your model may be slightly different.

Supported photo file: *.JPG

- You can play JPG files only.
- Only baseline scan is supported among JPG.

USB

Screen Components

1

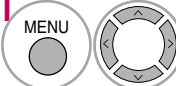

Select **USB**.

2

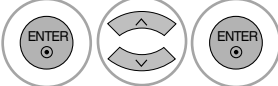

Select **Photo List**.

- ① Moves to upper level folder
- ② Preview: Display the thumbnail/folder name of the photo in the selected folder
- ③ Current page/Total pages
- ④ Total number of marked photos
- ⑤ Usable USB memory
- ⑥ Corresponding buttons on the remote control

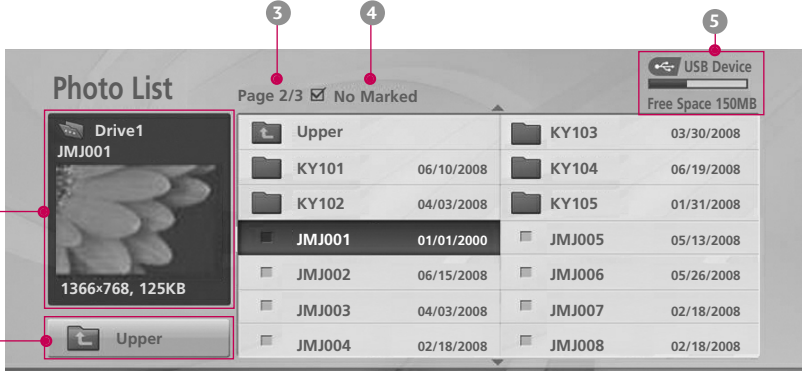

| Upper | | Upper | | Upper | |
|--------|------------|--------|------------|--------|------------|
| Upper | | Upper | | Upper | |
| KY101 | 06/10/2008 | KY103 | 03/30/2008 | KY105 | 01/31/2008 |
| KY102 | 04/03/2008 | KY104 | 06/19/2008 | KY107 | 02/18/2008 |
| JMJ001 | 01/01/2000 | JMJ005 | 05/13/2008 | JMJ008 | 02/18/2008 |
| JMJ002 | 06/15/2008 | JMJ006 | 05/26/2008 | | |
| JMJ003 | 04/03/2008 | JMJ007 | 02/18/2008 | | |
| JMJ004 | 02/18/2008 | JMJ008 | 02/18/2008 | | |



⑥

- Non-supported files are displayed in the form of bitmap.



- Some files may be displayed the preview image by icon only.

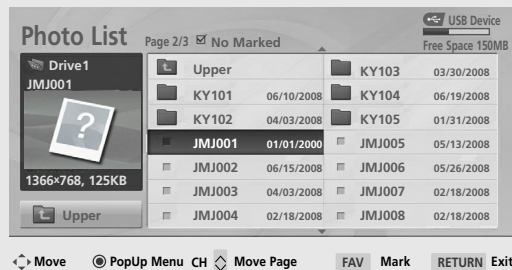
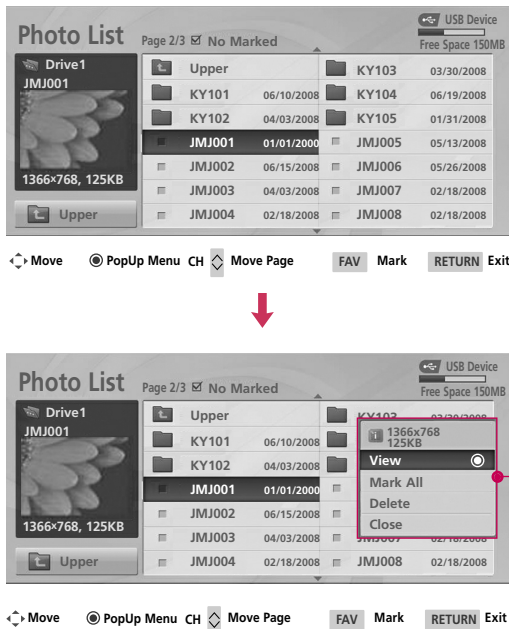







Photo Selection and PopUp Menu

USB



When you select a file (not folder), this PopUp menu is displayed.

- ▶ **View:** Display the selected item.
- ▶ **Mark All:** Mark all photos on the screen.
- ▶ **Unmark All:** Deselect all marked photos.
- ▶ **Delete:** Delete the selected photo item.
- ▶ **Close:** Close the pop-up menu.

- 1  Select the target folder or drive.
- 2   Select the desired photos.
- 3  Show the Popup menu.
- 4   Select the desired Popup menu.

- Use the **CH** ^ v button to navigation in the photo page.
- Use the **FAV** button to mark or unmark a photo. When one or more photos are marked, you can view individual photos or a slide show of the marked photos. If no photos are marked, you can view all photos individually or all photos in the folder in a slide show.