

APPENDIX H
: USER'S MANUAL



LCD TV | PLASMA TV OWNER'S MANUAL

LCD TV MODEL

26LG30 37LG50
 32LG30 42LG50
 37LG30 47LG50
 42LG30 52LG50

 32LG60 32LG70
 37LG60 42LG70
 42LG60 47LG70
 47LG60 52LG70
 52LG60

PLASMA TV MODELS

42PG10 50PG60F
 50PG10 60PG60F

 42PG20 42PG20C
 50PG20 50PG20C

Please read this manual carefully before operating your set.

Retain it for future reference.

Record model number and serial number of the set. See the label attached on the back cover and quote this information to your dealer when you require service.

ENERGY STAR is a set of power-saving guidelines issued by the U.S. Environmental Protection Agency(EPA).



As an ENERGY STAR Partner LGE U. S. A.,Inc. has determined that this product meets the ENERGY STAR guidelines for energy efficiency.

P/NO : SAC30708020 (0711-REV00)

WARNING / CAUTION



WARNING / CAUTION

**RISK OF ELECTRIC SHOCK
DO NOT OPEN**



**TO REDUCE THE RISK OF ELECTRIC SHOCK
DO NOT REMOVE COVER (OR BACK). NO
USER SERVICEABLE PARTS INSIDE. REFER TO
QUALIFIED SERVICE PERSONNEL.**



The lightning flash with arrowhead symbol, within an equilateral triangle, is intended to alert the user to the presence of uninsulated “dangerous voltage” within the product’s enclosure that may be of sufficient magnitude to constitute a risk of electric shock to persons.



The exclamation point within an equilateral triangle is intended to alert the user to the presence of important operating and maintenance (servicing) instructions in the literature accompanying the appliance.

WARNING/CAUTION

TO REDUCE THE RISK OF FIRE AND ELECTRIC SHOCK, DO NOT EXPOSE THIS PRODUCT TO RAIN OR MOISTURE.

NOTE TO CABLE/TV INSTALLER

This reminder is provided to call the CATV system installer’s attention to Article 820-40 of the National Electric Code (U.S.A.). The code provides guidelines for proper grounding and, in particular, specifies that the cable ground shall be connected to the grounding system of the building, as close to the point of the cable entry as practical.

WARNING / CAUTION

To prevent fire or shock hazards, do not expose this product to rain or moisture.

FCC NOTICE

Class B digital device

This equipment has been tested and found to comply with the limits for a Class B digital device, pursuant to Part 15 of the FCC Rules. These limits are designed to provide reasonable protection against harmful interference in a residential installation. This equipment generates, uses and can radiate radio frequency energy and, if not installed and used in accordance with the instructions, may cause harmful interference to radio communications. However, there is no guarantee that interference will not occur in a particular installation. If this equipment does cause harmful interference to radio or television reception, which can be determined by turning the equipment off and on, the user is encouraged to try to correct the interference by one or more of the following measures:

- Reorient or relocate the receiving antenna.
- Increase the separation between the equipment and receiver.
- Connect the equipment to an outlet on a circuit different from that to which the receiver is connected.
- Consult the dealer or an experienced radio/TV technician for help.

Any changes or modifications not expressly approved by the party responsible for compliance could void the user’s authority to operate the equipment.

CAUTION

Do not attempt to modify this product in any way without written authorization from LG Electronics. Unauthorized modification could void the user’s authority to operate this product

SAFETY INSTRUCTIONS

IMPORTANT SAFETY INSTRUCTIONS

Important safety instructions shall be provided with each apparatus. This information shall be given in a separate booklet or sheet, or be located before any operating instructions in an instruction for installation for use and supplied with the apparatus.

This information shall be given in a language acceptable to the country where the apparatus is intended to be used. The important safety instructions shall be entitled "Important Safety Instructions". The following safety instructions shall be included where applicable, and, when used, shall be verbatim as follows. Additional safety information may be included by adding statements after the end of the following safety instruction list. At the manufacturer's option, a picture or drawing that illustrates the intent of a specific safety instruction may be placed immediately adjacent to that safety instruction:

Read these instructions.

Keep these instructions.

Heed all warnings.

Follow all instructions.



- 1 Do not use this apparatus near water.

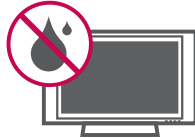

- 2 Clean only with dry cloth.



- 3 Do not block any ventilation openings. Install in accordance with the manufacturer's instructions.



- 4 Do not install near any heat sources such as radiators, heat registers, stoves, or other apparatus (including amplifiers) that produce heat.



- 5 When mounting a TV it on the wall, make sure not to install TV by hanging power and signal cables on the back of the TV.

- 6 Do not defeat the safety purpose of the polarized or grounding-type plug. A polarized plug has two blades with one wider than the other. A grounding type plug has two blades and a third grounding prong. The wide blade or the third prong are provided for your safety. If the provided plug does not fit into your outlet, consult an electrician for replacement of the obsolete outlet.



- 7 Protect the power cord from being walked on or pinched particularly at plugs, convenience receptacles, and the point where they exit from the apparatus.



- 8 Only use attachments/accessories specified by the manufacturer.



- 9 Unplug this apparatus when unused for long periods of time.



- 10** Use only with the cart, stand, tripod, bracket, or table specified by the manufacturer, or sold with the apparatus. When a cart is used, use caution when moving the cart/apparatus combination to avoid injury from tip-over.



- 11** Never touch this apparatus or antenna during a thunder or lightning storm.

- 12** Do not allow an impact shock or any objects to fall into the product, and do not drop onto the screen with something.

- 13** Refer all servicing to qualified service personnel. Servicing is required when the apparatus has been damaged in any way, such as power-supply cord or plug is damaged, liquid has been spilled or objects have fallen into the apparatus, the apparatus has been exposed to rain or moisture, does not operate normally, or has been dropped.

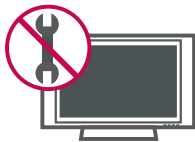

- 14** CAUTION concerning the Power Cord : Most appliances recommend they be placed upon a dedicated circuit; that is, a single outlet circuit which powers only that appliance and has no additional outlets or branch circuits. Check the specification page of this owner's manual to be certain.

Do not overload wall outlets. Overloaded wall outlets, loose or damaged wall outlets, extension cords, frayed power cords, or damaged or cracked wire insulation are dangerous. Any of these conditions could result in electric shock or fire. Periodically examine the cord of your appliance, and if its appearance indicates damage or deterioration, unplug it, discontinue use

of the appliance, and have the cord replaced with an exact replacement part by an authorized servicer. Protect the power cord from physical or mechanical abuse, such as being twisted, kinked, pinched, closed in a door, or walked upon. Pay particular attention to plugs, wall outlets, and the point where the cord exits the appliance.



- 15** Outdoor use marking :
WARNING - To reduce the risk of fire or electric shock, do not expose this appliance to rain or moisture.



- 16** Wet Location Marking : Apparatus shall not be exposed to dripping or splashing and no objects filled with liquids, such as vases, shall be placed on or over apparatus.



17 GROUNDING

Ensure that you connect the earth ground wire to prevent possible electric shock. If grounding methods are not possible, have a qualified electrician install a separate circuit breaker. Do not try to ground the unit by connecting it to telephone wires, lightening rods, or gas pipes.

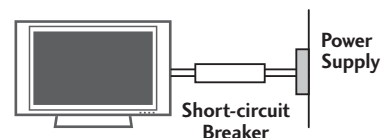

- 18** DISCONNECTING DEVICE FROM MAINS
Mains plug is the disconnecting device. The plug must remain readily operable.

CONTENTS

WARNING / CAUTION	1
SAFETY INSTRUCTIONS	2
FEATURE OF THIS TV	6

PREPARATION

Accessories	7
Front Panel Information	8
Back Panel Information	10
Stand Installation	14
Back Cover for Wire Arrangement	16
Desktop Pedestal Installation	18
VESA Wall Mounting	18
Swivel Stand	19
Not Using the Desk-Type Stand	19
Attaching the TV to a Desk	19
How to join the TV Assemble to the wall to protect the TV tumbling	20
Antenna or Cable Connection	21

EXTERNAL EQUIPMENT SETUP

HD Receiver Setup	22
DVD Setup	25
VCR Setup	27
Other A/V Source Setup	29
PC Setup	30
USB In Setup	38
Audio Out Setup	39

WATCHING TV / CHANNEL CONTROL

Remote Control Functions	40
Turning On TV	42
Channel Selection	42
Volume Adjustment	42
Quick Menu	43
Installation Guide	44
On-Screen Menus Selection	46

Channel Setup	
- Auto Scan (Auto Tuning)	48
- Add / Delete Channel (Manual Tuning)	49
- Channel Editing	50
Input List	51
Input Label	52
AV Mode	53
Simplink	54

USB

Entry Modes	56
Photo List	57
Music List	61

PICTURE CONTROL

Picture Size (Aspect Ratio) Control	64
Preset Picture Settings	
- Picture Mode - Preset	66
- Color Tone - Preset	67
Manual Picture Adjustment	
- Picture Mode - User Mode	68
- Color Tone - User Mode	69
Picture Improvement Technology	70
Advanced - Black (Darkness) Level	71
Advanced - Eye Care	72
Advanced - Film Mode	73
Advanced - TruMotion	74
TruMotion Demo	75
Picture Reset	76
Power Indicator	77
Image Sticking Minimization (ISM) Method	78
Power Saving Picture Mode	76

SOUND & LANGUAGE CONTROL

Auto Volume Leveller (Auto Volume)	80
Preset Sound Setting (Sound Mode)	81
Sound Setting Adjustment - User Mode	82
Clear Voice	83
Balance	84
TV Speakers On/Off Setup	85
Audio Reset	86
Stereo/SAP Broadcasts Setup	87
Audio Language	88
On-Screen Menus Language Selection	89
Caption Mode	
- Analog Broadcasting System Captions	90
- Digital Broadcasting System Captions	91
- Caption Option	92

TIME SETTING

Clock Setting	
- Auto Clock Setup	93
- Manual Clock Setup	94
Auto On/Off Timer Setting	95
Sleep Timer Setting	96
Auto Shut-off Setting	97

PARENTAL CONTROL / RATINGS

Set Password & Lock System	98
Channel Blocking	101
Movie & TV Rating	102
Downloadable Rating	107
External Input Blocking	108
Key lock	109

APPENDIX

Troubleshooting	110
Maintenance	112
Product Specifications	113
Programming the Remote Control	116
IR Codes	119
External Control Through RS-232C	121

FEATURE OF THIS TV



SRS is a trademark of SRS Labs, Inc. TruSurround XT technology is incorporated under license from SRS Labs, Inc.

USB

LG TV with this logo can play MP3 music from a MP3 player, such as iPOD, and JPEG images from a digital camera through the USB device.



With HDMI CEC support of LG's audio/video device connected to the HDMI (high-definition multimedia interface), LG TV with this logo works easily with one remote control.



It has three HDMI ports that connect audio and video devices with one cable and produces the highest quality digital images and sound.



It has 2 HDMI ports that connect audio and video devices with one cable and produces the highest quality digital images and sound.



Manufactured under license from Dolby Laboratories. "Dolby" and the double-D symbol are trademarks of Dolby Laboratories.



High-definition television. High-resolution digital television broadcast and playback system composed of roughly a million or more pixels, 16:9 aspect-ratio screens, and AC3 digital audio. A subset of digital television, HDTV formats include 1080i and 720p resolutions.



LG's own special digital image generator, consisting of a full digital image processor, six different main picture quality factors.

FOR LCD TV

- If the TV feels cold to the touch, there may be a small "flicker" when it is turned on. This is normal, there is nothing wrong with TV.
- Some minute dot defects may be visible on the screen, appearing as tiny red, green, or blue spots. However, they have no adverse effect on the monitor's performance.
- Avoid touching the LCD screen or holding your finger(s) against it for long periods of time. Doing so may produce some temporary distortion effects on the screen.

On Disposal

- a. The fluorescent lamp used in this product contains a small amount of mercury.
- b. Do not dispose of this product with general household waste.
- c. Disposal of this product must be carried out in accordance to the regulations of your local authority.

PREPARATION

ACCESSORIES

Ensure that the following accessories are included with your product. If an accessory is missing, please contact the dealer where you purchased the product.

User must use shielded signal interface cables (D-sub 15 pin cable) with ferrite cores to maintain standard compliance for the product.

The accessories can be different from the figures shown here.

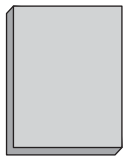

Owner's Manual



CD Manual

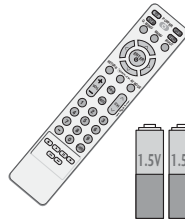

Remote Control, Batteries

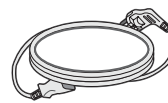

Power Cord



75ohm Round Cable



Protection Cover
(Refer to P.19)

(This accessories can be different from the figures shown here depending on your models.)

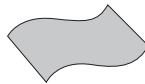

Polishing Cloth
(This feature is not available for all models.)

* Slightly wipe stained spot on the exterior only with the polishing cloth for the product exterior if there is stain or fingerprint on surface of the exterior.

* Do not wipe roughly when removing stain. Please be cautions of that excessive pressure may cause scratch or discoloration.

For Plasma TV models



Cable Management Clip

Option Extras

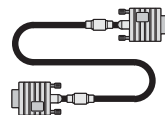

D-sub 15 pin Cable

For LCD TV models

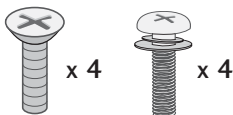

Bolts for stand assembly
(Refer to P.15)

(Only 26/32/37/42LG30, 37/42LG50)

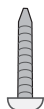

Screw for stand fixing
(Refer to P.19)

(Only 26/32LG30, 32LG50)

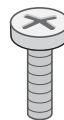

7-Bolts for stand assembly
(Refer to P.15)

(Only 32/37/42/47/52LG60)

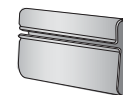

Cable Management Clip

PREPARATION

FRONT PANEL INFORMATION

- Image shown may differ from your TV
- **NOTE:** If your product has a protection tape attached, remove the tape. And then wipe the product with a cloth (If a polishing cloth is included with your product, use it).

Plasma TV Model

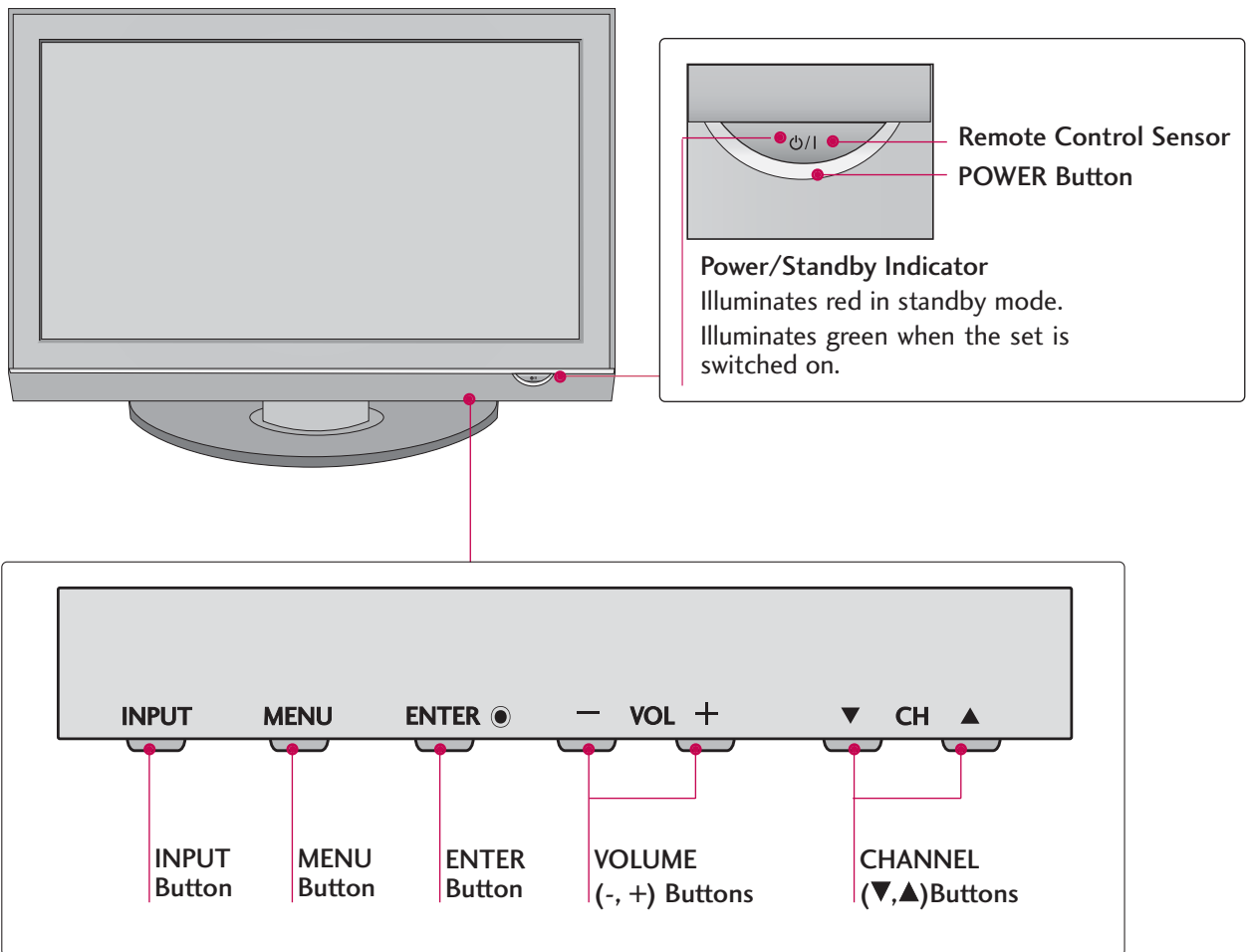

LCD TV Model

26/32/37/42/47/52LG30/50/70

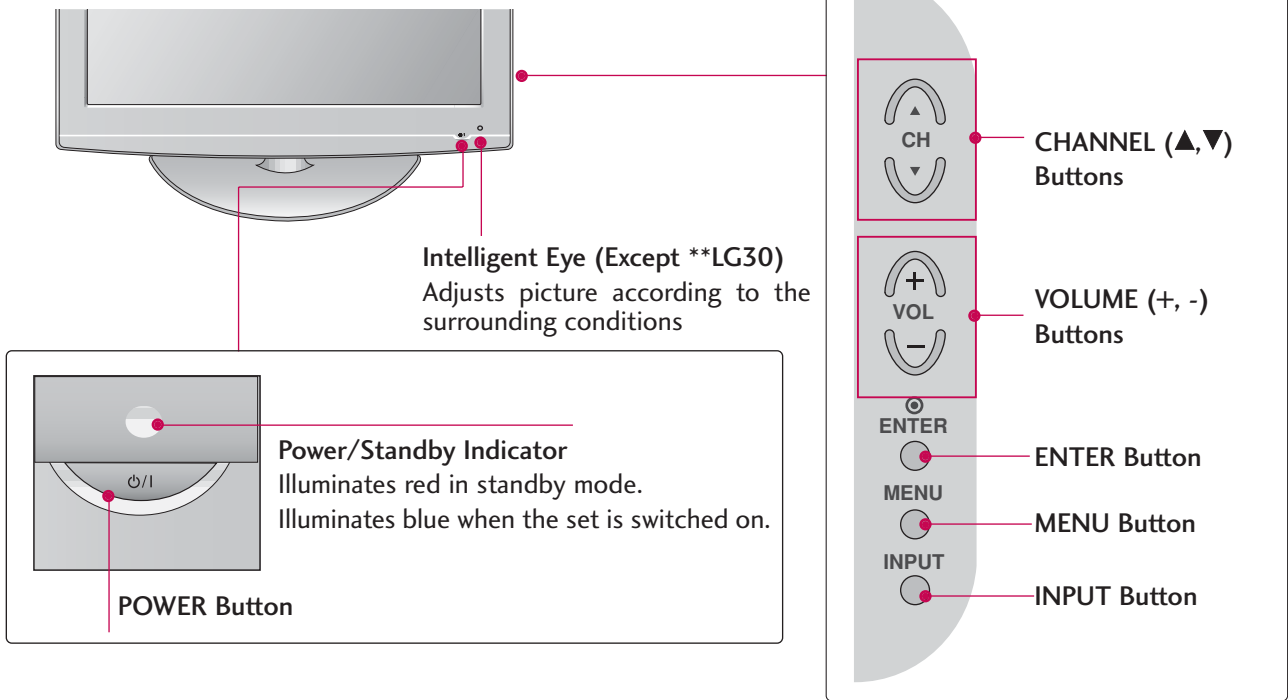

32/37/42/47/52LG60

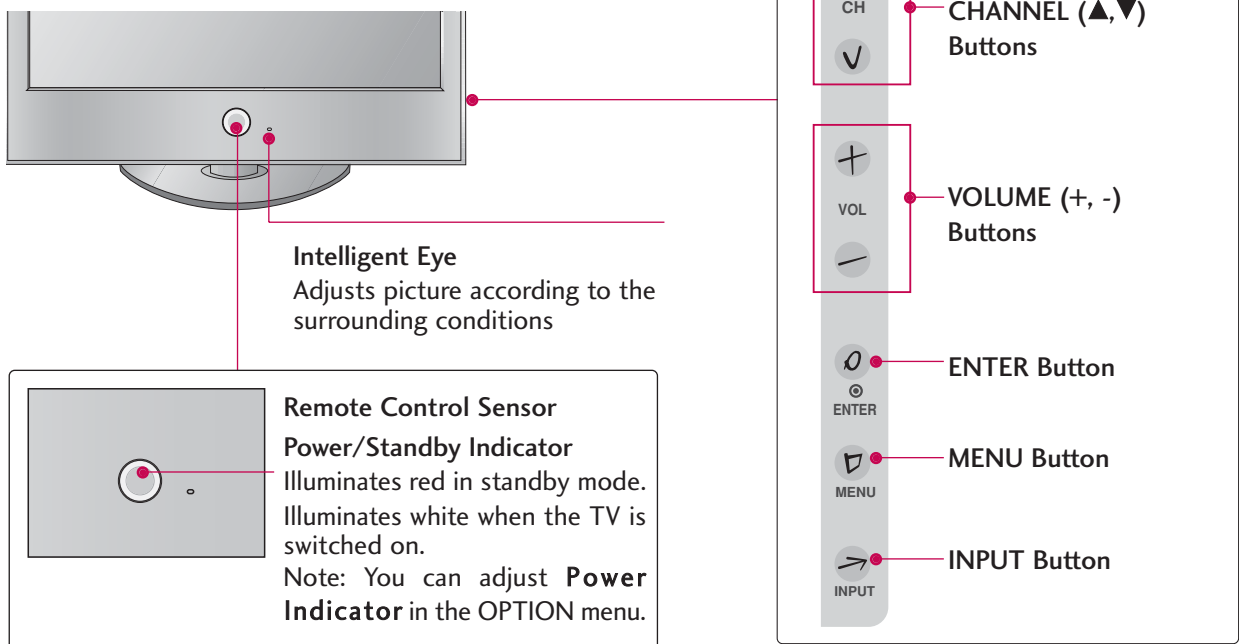

PREPARATION

BACK PANEL INFORMATION

Image shown may differ from your TV

Plasma TV Model

PREPARATION

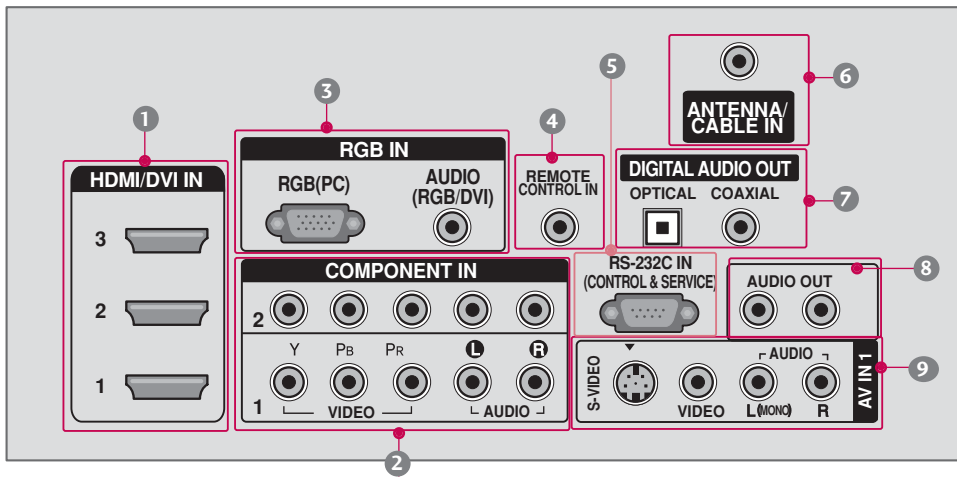
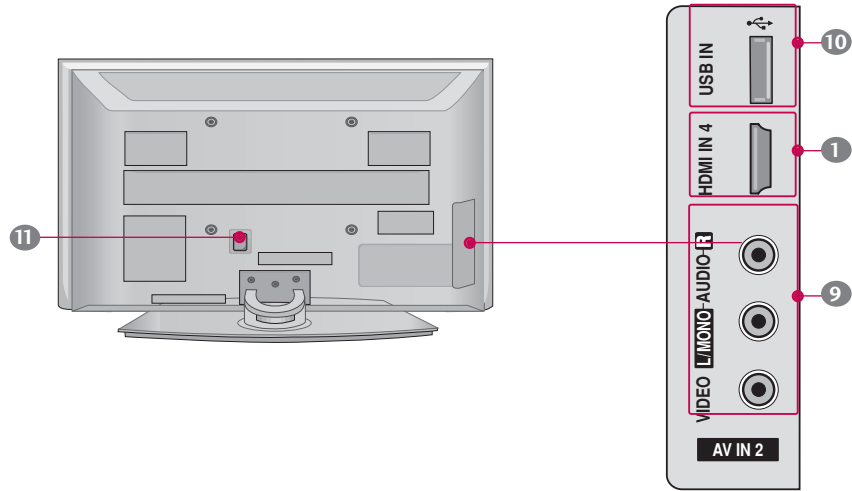

1 HDMI/DVI IN, HDMI IN

Connect a HDMI signal to HDMI port.
Or DVI (VIDEO) signal to the HDMI port with a DVI to HDMI cable.

2 COMPONENT IN

Connect a component video/audio device to these jacks.

3 RGB (PC)

Connect the output from a PC.

AUDIO (RGB/DVI)

Connect the audio from a PC.

4 REMOTE CONTROL PORT

Connect your wired remote control.

5 RS-232C IN (CONTROL & SERVICE) PORT

Connect to the RS-232C port on a PC.

6 ANTENNA/CABLE IN

Connect over-the air signals to this jack.

Connect cable signals to this jack.

7 DIGITAL AUDIO OUT

Connect digital audio to various types of equipment.

Note: In standby mode, these ports do not work.

8 AUDIO OUT

Connect analog audio to various types of equipment.

9 AV (Audio/Video) IN

Connect audio/video output from an external device to these jacks.

S-VIDEO

Connect S-Video out from an S-VIDEO device.

10 USB INPUT**11 Power Cord Socket**

For operation with AC power.

Caution: Never attempt to operate the TV on DC power.

PREPARATION

Image shown may differ from your TV

LCD TV Model

PREPARATION

26/32/37/42/47/52LG30/50

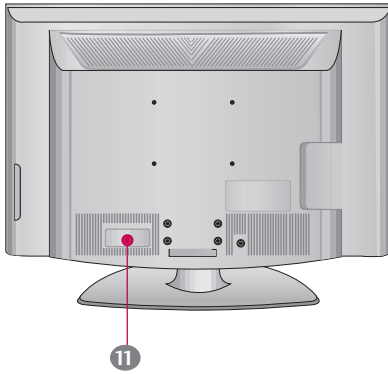

32/37/42/47/52LG60

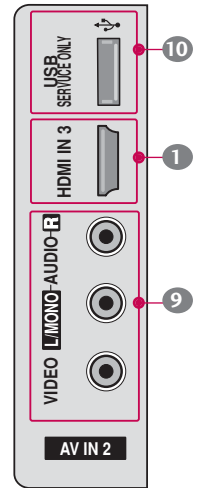
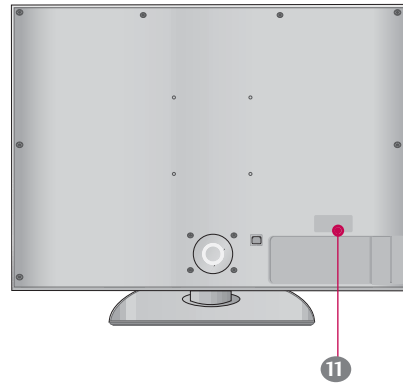

37/42/47/52LG50

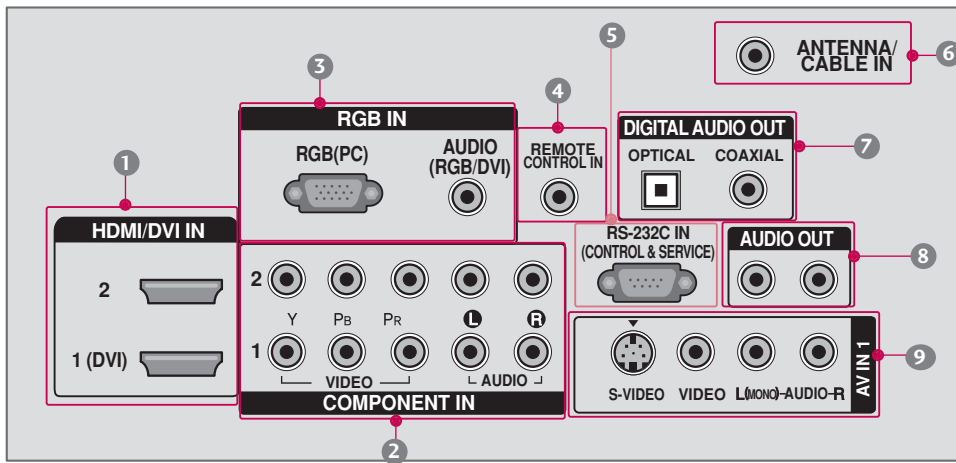

26/32/37/42LG30

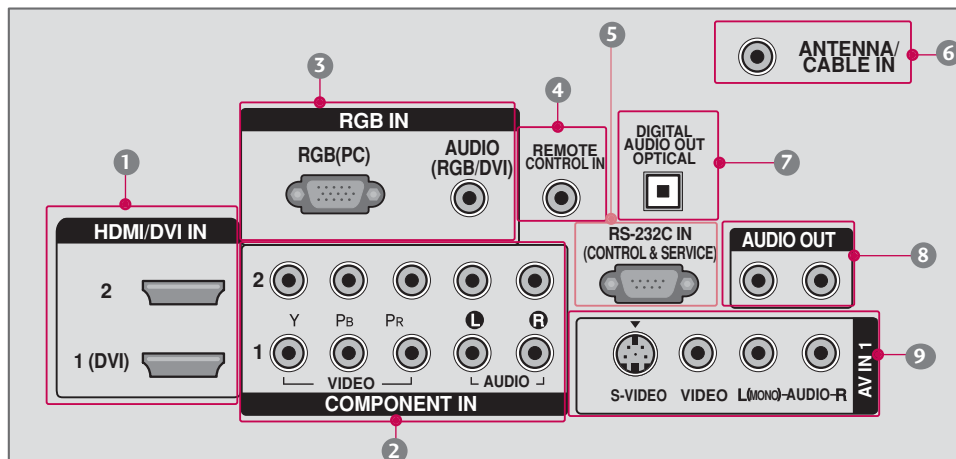

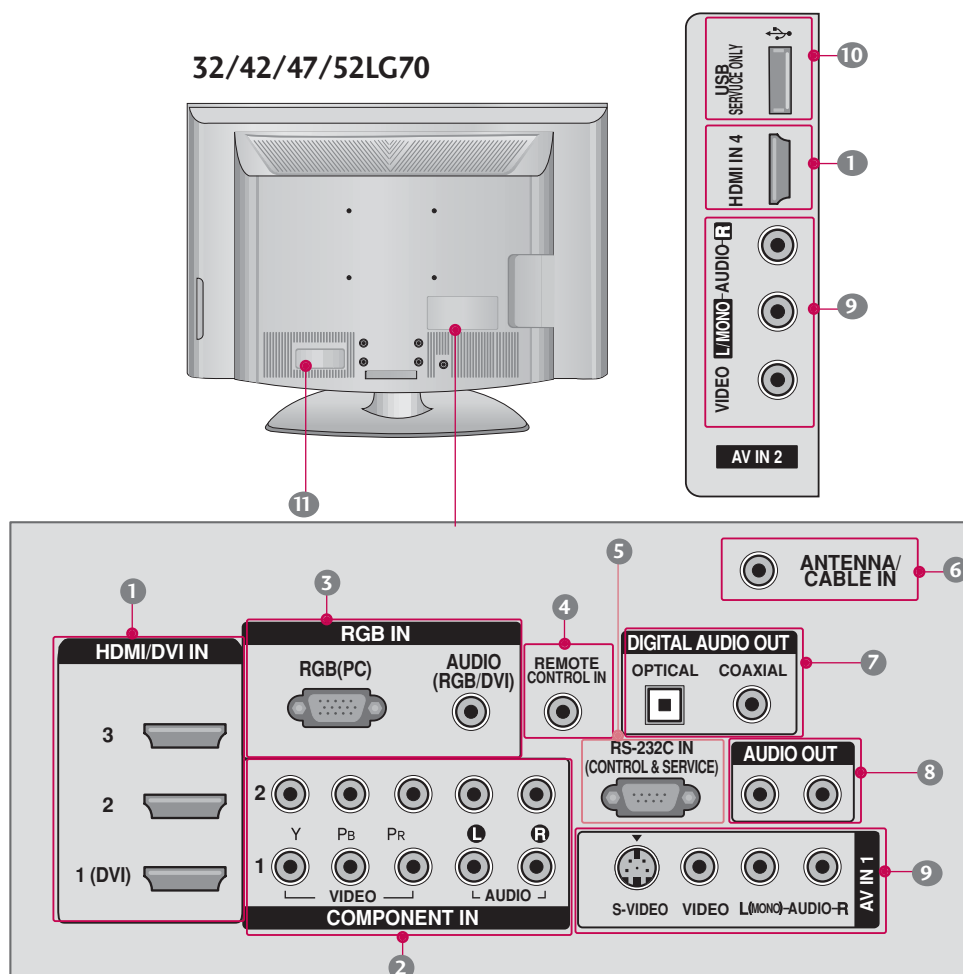

- 1 HDMI/DVI IN, HDMI IN**
 Connect a HDMI signal to HDMI port.
 Or DVI (VIDEO) signal to the HDMI port with a DVI to HDMI cable.
- 2 COMPONENT IN**
 Connect a component video/audio device to these jacks.
- 3 RGB (PC)**
 Connect the output from a PC.
AUDIO (RGB/DVI)
 Connect the audio from a PC.
- 4 REMOTE CONTROL PORT**
 Connect your wired remote control.
- 5 RS-232C IN (CONTROL & SERVICE) PORT**
 Connect to the RS-232C port on a PC.
- 6 ANTENNA/CABLE IN**
 Connect over-the air signals to this jack.
 Connect cable signals to this jack.
- 7 DIGITAL AUDIO OUT**
 Connect digital audio to various types of equipment.
 Note: In standby mode, these ports do not work.
- 8 AUDIO OUT**
 Connect analog audio to various types of equipment.
- 9 AV (Audio/Video) IN**
 Connect audio/video output from an external device to these jacks.
S-VIDEO
 Connect S-Video out from an S-VIDEO device.
- 10 USB INPUT**
- 11 Power Cord Socket**
 For operation with AC power.
 Caution: Never attempt to operate the TV on DC power.

PREPARATION

STAND INSTALLATION

■ Image shown may differ from your TV

Plasma TV Model

42PG10/20

- 1 Carefully place the TV screen side down on a cushioned surface to protect the screen from damage.

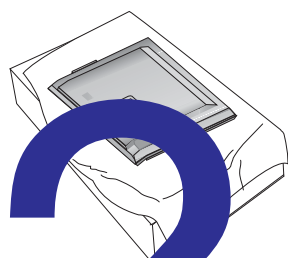

- 2 Assemble the TV stand.

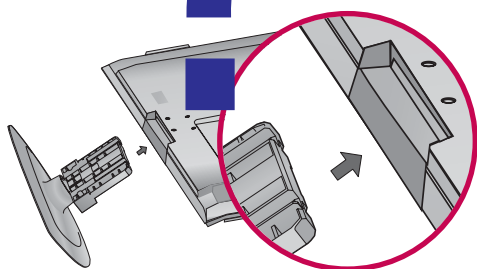

- 3 Fix the 4 bolts securely using the holes in the back of the TV

LCD TV Model

Only 26/32/37/42LG30, 37/42LG50

- 1 Carefully place the TV screen side down on a cushioned surface to protect the screen from damage.

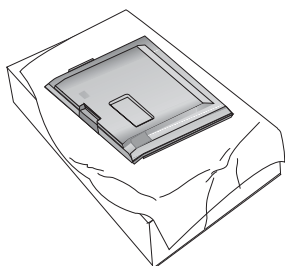

- 2 Assemble the parts of the **STAND BODY** with **COVER BASE** of the TV.

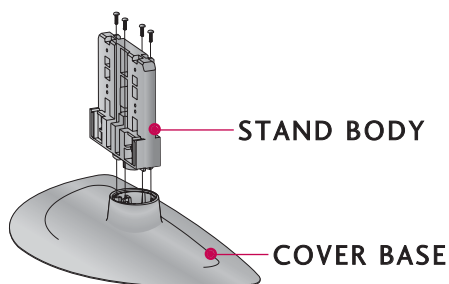

- 3 Assemble the TV as shown.

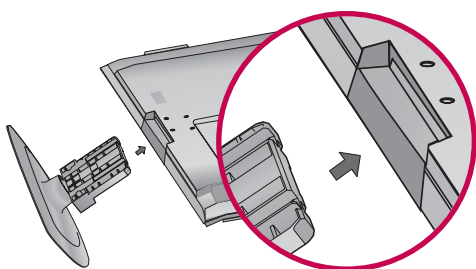

- 4 Fix the 4 bolts securely using the holes in the back of the TV

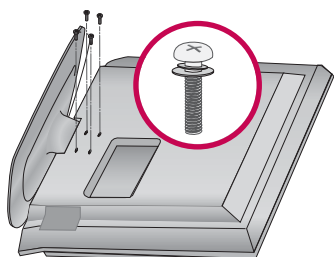

32/37/42/47/52LG60

- 1 Carefully place the TV screen side down on a cushioned surface to protect the screen from damage.

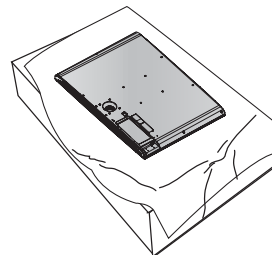

- 2 Assemble the parts of the **STAND BODY** with **COVER BASE** of the TV.

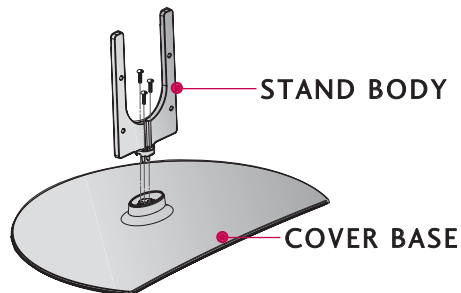

- 3 Assemble the TV as shown.

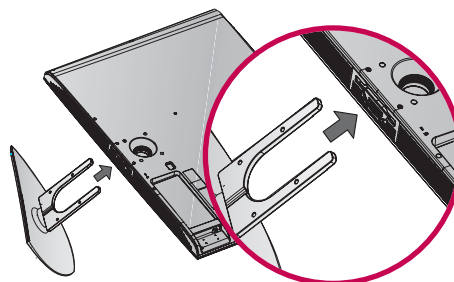

- 4 Fix the 4 bolts securely using the holes in the back of the TV

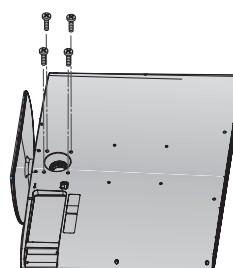

PREPARATION

BACK COVER FOR WIRE ARRANGEMENT

■ Image shown may differ from your TV.

Plasma TV Model

50/60PG60F

- 1 Connect the cables as necessary.
To connect an additional equipment, see the **EXTERNAL EQUIPMENT SETUP** section.

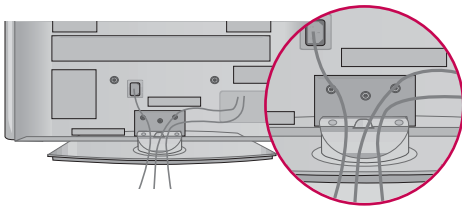

- 2 Install the **CABLE MANAGEMENT CLIP** as shown and manage the cable.

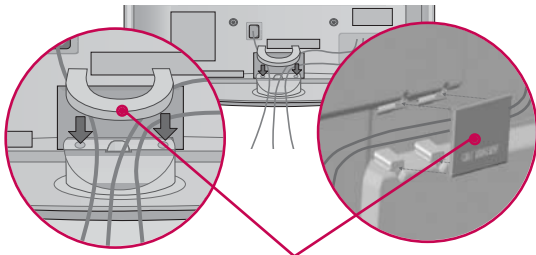

CABLE MANAGEMENT CLIP

How to remove the CABLE MANAGEMENT CLIP

- ▶ Hold the **CABLE MANAGEMENT CLIP** with both hands and pull it backward.

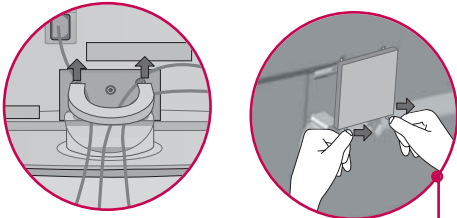

Separate **CABLE MANAGEMENT CLIP** from TV by pressing two latches.

NOTE

- ▶ Do not hold the **CABLE MANAGEMENT CLIP** when moving the TV.
- If the TV is dropped, you may be injured or the product may be broken.

42/50PG10/20

- 1 Arrange the cables as shown.

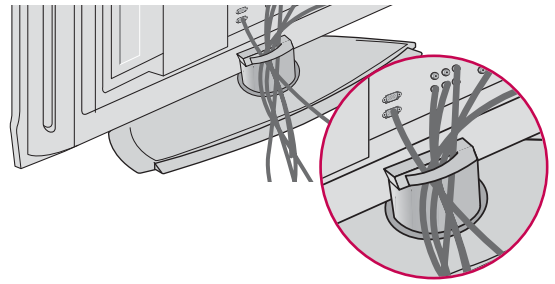

LCD TV Model

26/32/37/42/47/52LG30/50/70

- 1 Connect the cables as necessary.
To connect an additional equipment, see the **EXTERNAL EQUIPMENT SETUP** section.

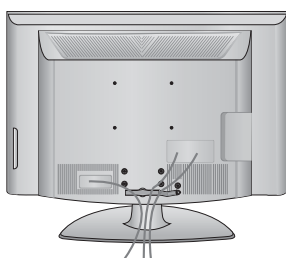

- 2 Install the **CABLE MANAGEMENT CLIP** as shown and manage the cable.

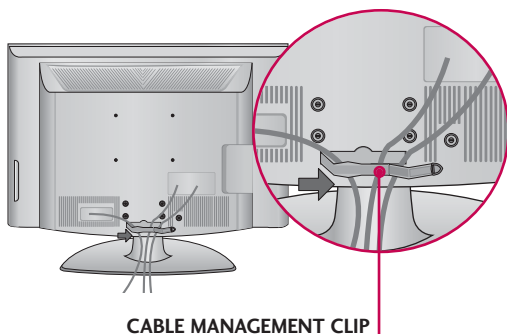

- 3 Fit the **CABLE MANAGEMENT CLIP** as shown.

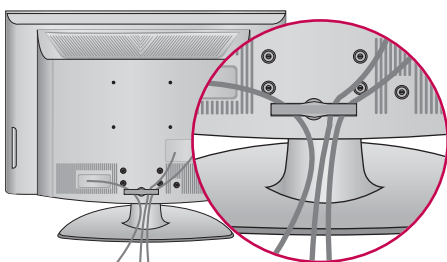

32/37/42/47/52LG60

- 1 Connect the cables as necessary.
To connect an additional equipment, see the **EXTERNAL EQUIPMENT SETUP** section of the manual.

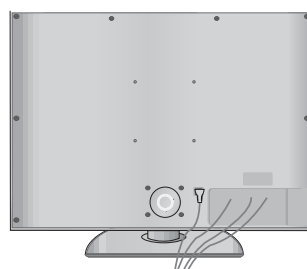

- 2 Bundle the cables together using the supplied **CABLE MANAGEMENT CLIP**.

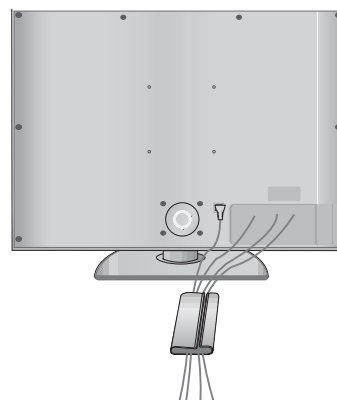

PREPARATION

DESKTOP PEDESTAL INSTALLATION

Image shown may differ from your TV.

For proper ventilation, allow a clearance of 4 inches on all four sides from the wall.

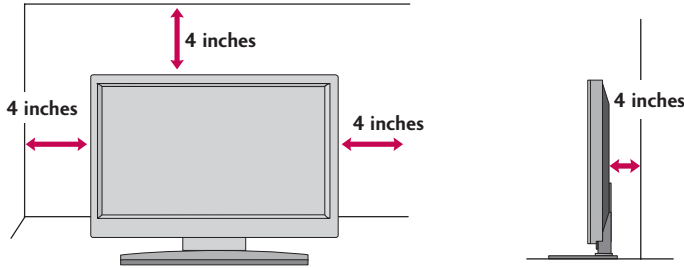

PREPARATION

VESA WALL MOUNTING

This product accepts a VESA-compliant mounting interface pad. (optional)
There 4 threaded holes are available for attaching the bracket.

Plasma TV Model

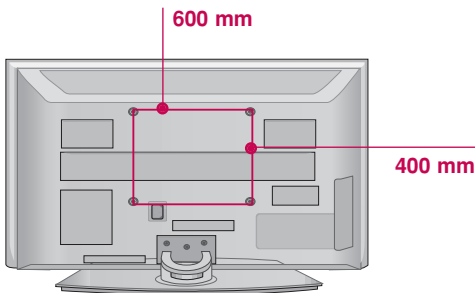

LCD TV Model

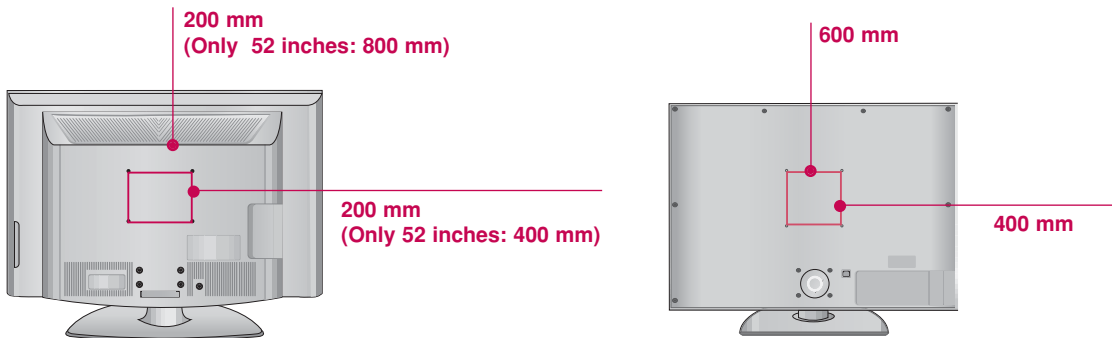

NOTE

- Screw length needed depends on the wall mount used. For further information, refer to the VESA Wall Mounting Instruction Guide.

SWIVEL STAND

After installing the TV, you can adjust the TV set manually to the left or right direction by 20 degrees to suit your viewing position.

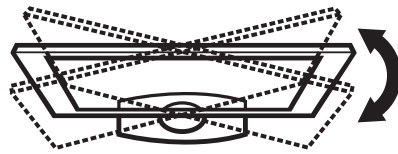

NOT USING THE DESK-TYPE STAND

When installing the wall-mounted unit, use the protection cover for desk-type stand installation.

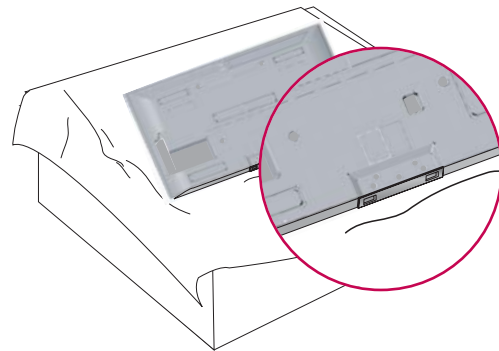

ATTACHING THE TV TO A DESK (Only 26/32LG30, 32LG50)

The TV must be attached to a desk so it cannot be pulled in a forward/backward direction, potentially causing injury or damaging the product.

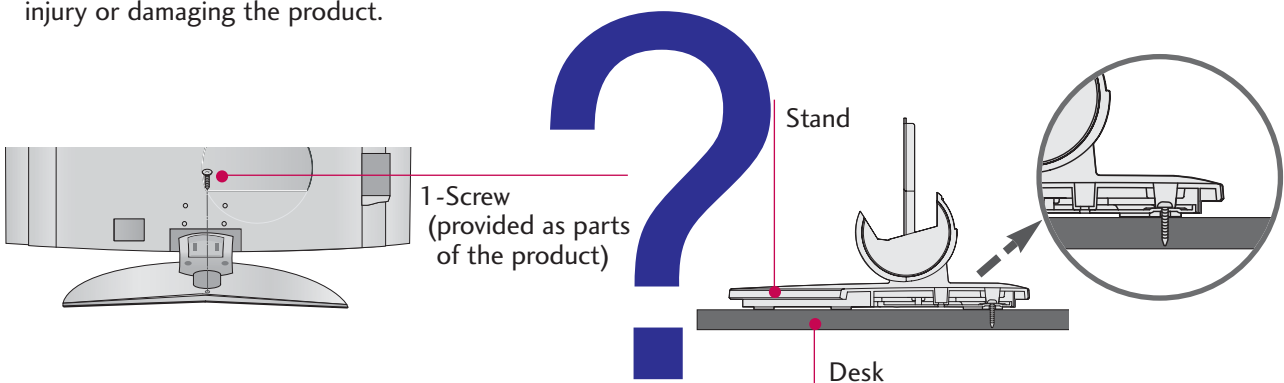

⚠ WARNING

- ▶ This apparatus must be securely attached to the floor/wall per installation instructions. Tipping, shaking, or rocking the machine may cause injury/death.

PREPARATION

PLEASE SET IT UP CAREFULLY SO THE PRODUCT DOESN'T FALL OVER.

- You should purchase necessary components to prevent TV from falling off of the stand.
- Image shown may differ from your TV.

We recommend that you set up the TV close to a wall so it cannot fall over if pushed backwards. Additionally, we recommend that the TV be attached to a wall so it cannot be pulled in a forward direction, potentially causing injury or damaging the product.

Caution: Please make sure that children don't climb on or hang from the TV.

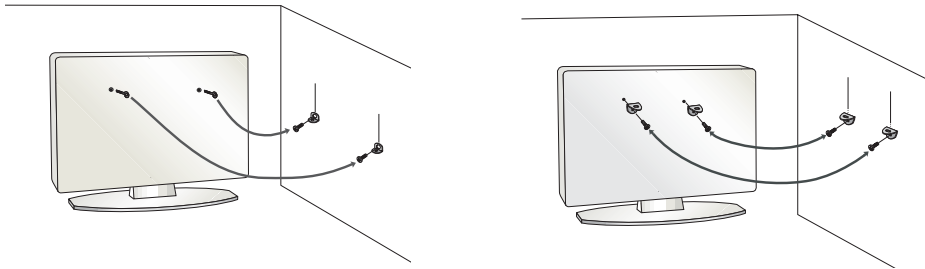

- Insert the eye-bolts (or TV brackets and bolts) to tighten the product to the wall as shown in the picture.
 - * If your product has the bolts in the eye-bolts position before inserting the eye-bolts, loosen the bolts.
 - * Insert the eye-bolts or TV brackets/bolts and tighten them securely in the upper holes.

Secure the wall brackets with the bolts (not provided as parts of the product, must purchase separately) to the wall. Match the height of the bracket that is mounted on the wall to the holes in the product.

Ensure the eye-bolts or brackets are tightened securely.

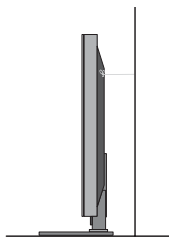

- Use a sturdy rope (not provided as parts of the product, must purchase separately) to tie the product. It is safer to tie the rope so it becomes horizontal between the wall and the product.

! NOTE

- ▶ When moving the TV, undo the cords first.
- ▶ Use a platform or cabinet strong and large enough to support the size and weight of the TV
- ▶ To use the TV safely make sure that the height of the bracket on the wall and on the TV is the same.

ANTENNA OR CABLE CONNECTION

■ Image shown may differ from your TV.

1. Antenna (Analog or Digital)

Wall Antenna Socket or Outdoor Antenna without a Cable Box Connections.

For optimum picture quality, adjust antenna direction if needed.

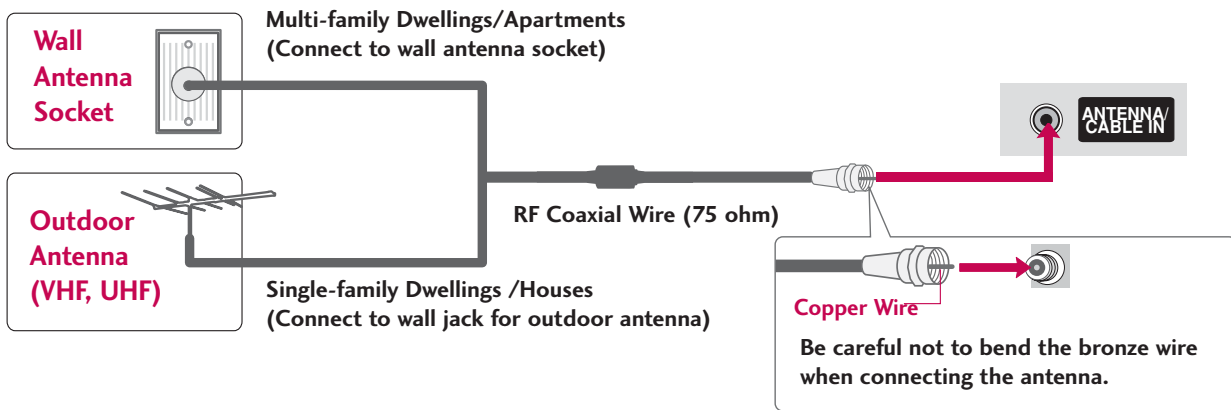

2. Cable

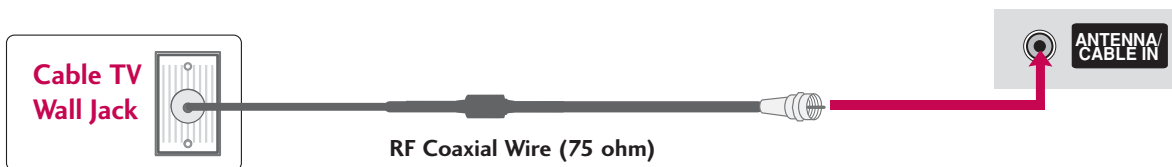

- To improve the picture quality in a poor signal area, please purchase a signal amplifier and install properly.
- If the antenna needs to be split for two TV's, install a 2-Way Signal Splitter.
- If the antenna is not installed properly, contact your dealer for assistance.

NOTE ▶ The TV will let you know when the analog, cable, and digital channel scans are complete.

EXTERNAL EQUIPMENT SETUP

- To prevent the equipment damage, never plug in any power cords until you have finished connecting all equipment.
- This part of EXTERNAL EQUIPMENT SETUP mainly use picture for 37/42/47/52LG50 models.

HD RECEIVER SETUP

This TV can receive Digital Over-the-air/Cable signals without an external digital set-top box. However, if you do receive digital signals from a digital set-top box or other digital external device, refer to the figure as shown below.

When connecting Component cable

1. How to connect

- 1 Connect the video outputs (Y, PB, PR) of the digital set top box to the **COMPONENT IN VIDEO 1** jacks on the set. Match the jack colors (Y = green, PB = blue, and PR = red).
- 2 Connect the audio output of the digital set-top box to the **COMPONENT IN AUDIO 1** jacks on the set.

2. How to use

- Turn on the digital set-top box.
(Refer to the owner's manual for the digital set-top box. operation)
- Select **Component 1** input source by using the **INPUT** button on the remote control.
- If connected to **COMPONENT IN2** input, select **Component 2** input source.

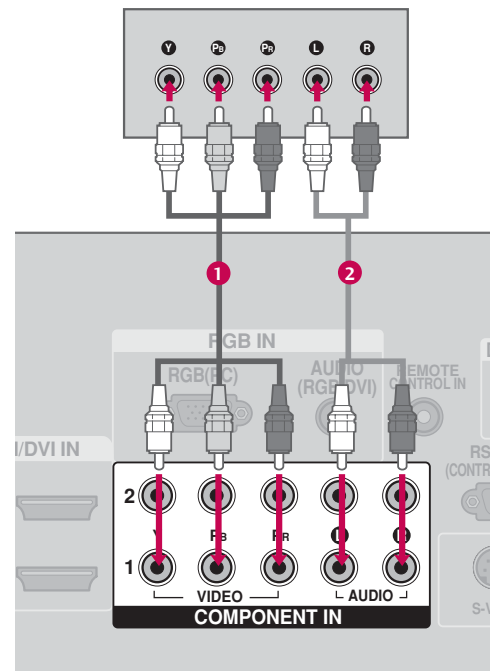

Signal	Component	HDMI
480i	Yes	No
480p	Yes	Yes
720p	Yes	Yes
1080i	Yes	Yes
1080p	Yes	Yes

Y, CB/PB, CR/PR

Resolution	Horizontal Frequency(KHz)	Vertical Frequency(Hz)
720x480i	15.73	59.94
	15.73	60.00
720x480p	31.47	59.94
	31.50	60.00
1280x720p	44.96	59.94
	45.00	60.00
1920x1080i	33.72	59.94
	33.75	60.00
1920x1080p	26.97	23.976
	27.00	24.00
	33.71	29.97
	33.75	30.00
	67.432	59.94
	67.50	60.00

When connecting HDMI cable

1. How to connect

- 1 Connect the digital set-top box to **HDMI/DVI IN1**, **2**, **3** or **4** jack on the set.
- 2 No separated audio connection is necessary. HDMI supports both audio and video.

2. How to use

- Turn on the digital set-top box.
(Refer to the owner's manual for the digital set-top box.)
- Select **HDMI1**, **HDMI2**, **HDMI3**, or **HDMI4** input source with using the **INPUT** button on the remote control.

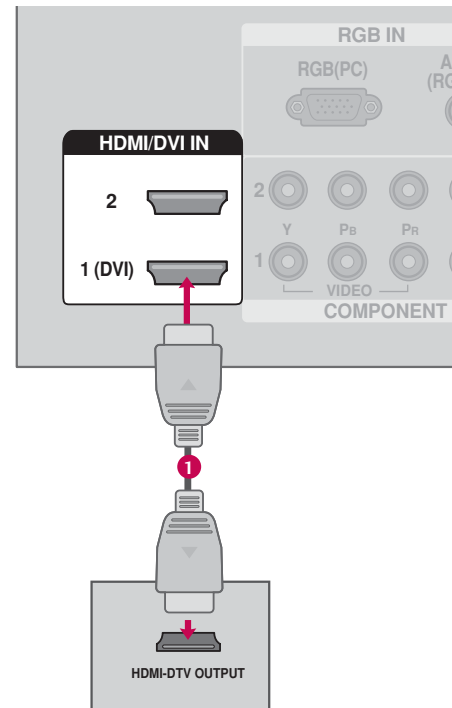

HDMI-DTV

Resolution	Horizontal Frequency(KHz)	Vertical Frequency(Hz)
720x480p	31.47	59.94
	31.50	60.00
1280x720p	44.96	59.94
	45.00	60.00
1920x1080i	33.72	59.94
	33.75	60.00
1920x1080p	26.97	23.976
	27.00	24.00
	33.71	29.97
	33.75	30.00
	67.432	59.939
	67.50	60.00

EXTERNAL EQUIPMENT SETUP

When connecting HDMI to DVI cable

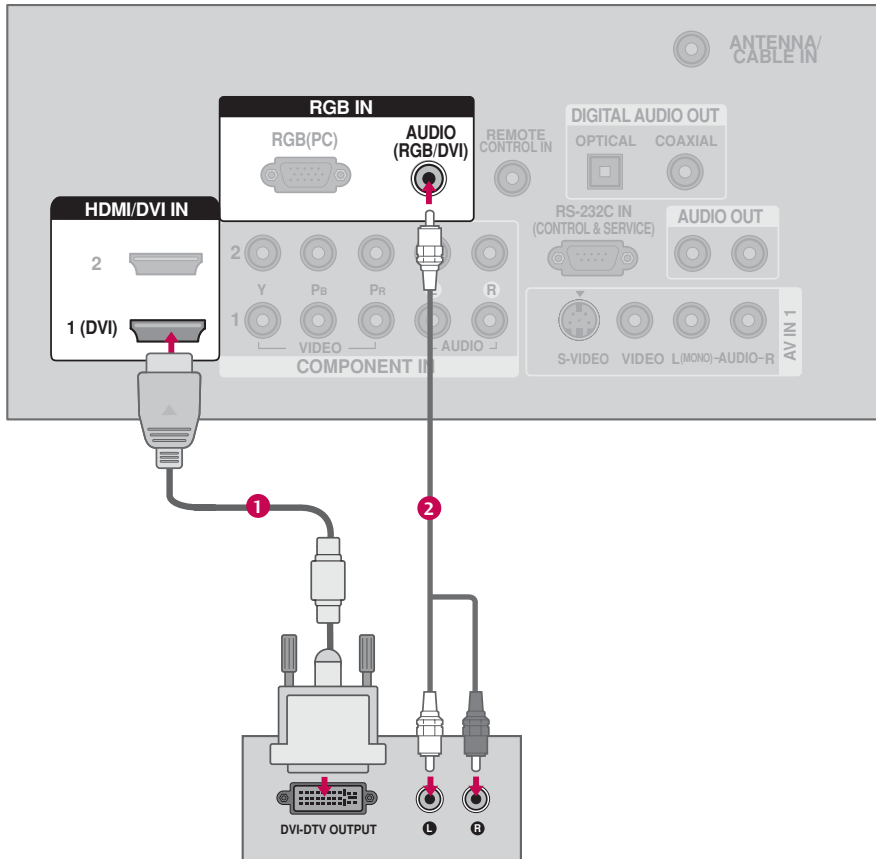

1. How to connect

- 1 Connect the DVI output of the digital set-top box to the **HDMI/DVI IN1 (DVI)** jack on the set.
- 2 Connect the audio output of the digital set-top box to the **AUDIO (RGB/DVI)** jack on the set.

2. How to use

- Turn on the digital set-top box. (Refer to the owner's manual for the digital set-top box.)
- Select **HDMI1** input source with using the **INPUT** button on the remote control.

DVD SETUP

When connecting Component cable

1. How to connect

- 1 Connect the video outputs (Y, P_B, P_R) of the DVD to the **COMPONENT IN VIDEO1** jacks on the set. Match the jack colors (Y = green, P_B = blue, and P_R = red).
- 2 Connect the audio outputs of the DVD to the **COMPONENT IN AUDIO1** jacks on the set.

2. How to use

- Turn on the DVD player, insert a DVD.
- Select **Component 1** input source by using the **INPUT** button on the remote control.
- If connected to **COMPONENT IN 2** input, select **Component 2** input source.
- Refer to the DVD player's manual for operating instructions.

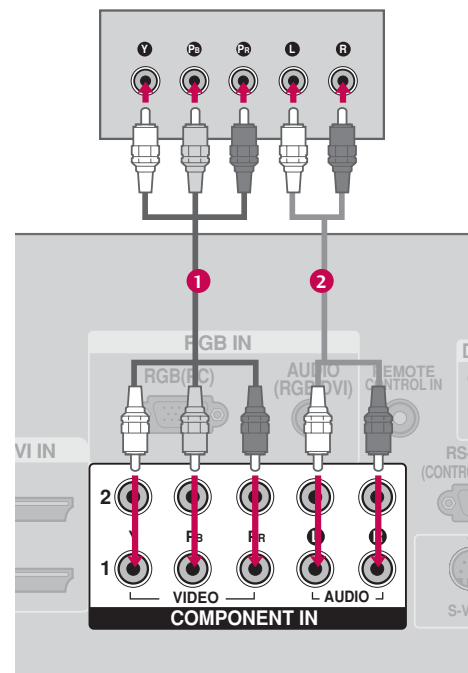

Component Input ports

To get better picture quality, connect a DVD player to the component input ports as shown below.

Component ports on the TV	Y	P _B	P _R
Video output ports on DVD player	Y	P _B	P _R
	Y	B-Y	R-Y
	Y	Cb	Cr
	Y	Pb	Pr

EXTERNAL EQUIPMENT SETUP

When connecting with an S-Video cable

1. How to connect

- 1 Connect the S-VIDEO output of the DVD to the S-VIDEO input on the set.
- 2 Connect the audio outputs of the DVD to the AUDIO input jacks on the set.

2. How to use

- Turn on the DVD player, insert a DVD.
- Select **AV1** input source by using the **INPUT** button on the remote control.
- Refer to the DVD player's manual for operating instructions.

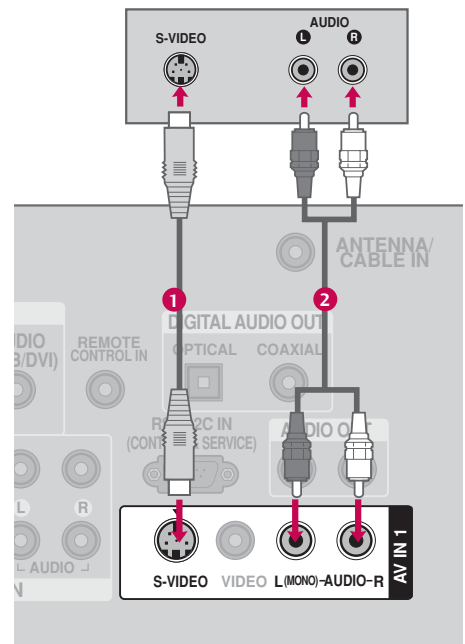

When connecting HDMI cable

1. How to connect

- 1 Connect the HDMI output of the DVD to the HDMI/DVI IN1, 2, 3 or 4 jack on the set.
- 2 No separated audio connection is necessary. HDMI supports both audio and video.

2. How to use

- Select **HDMI1**, **HDMI2**, **HDMI3**, or **HDMI4** input source by using the **INPUT** button on the remote control.
- Refer to the DVD player's manual for operating instructions.

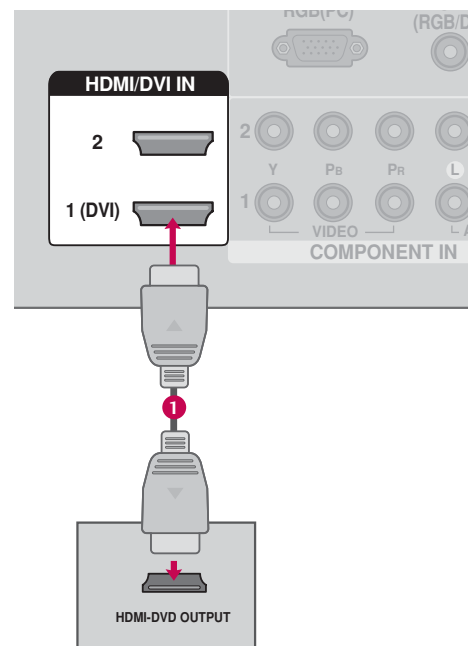

VCR SETUP

- To avoid picture noise (interference), leave an adequate distance between the VCR and TV.
- Use the ISM feature in the Option menu to avoid having a fixed image remain on the screen for a long period of time (Only Plasma TV model). If the 4:3 picture format is used; the fixed images on the sides of the screen may remain visible on the screen. This phenomenon is common to all manufactures and in consequence the manufactures warranty does not cover the product bearing this phenomenon.

When connecting with an antenna

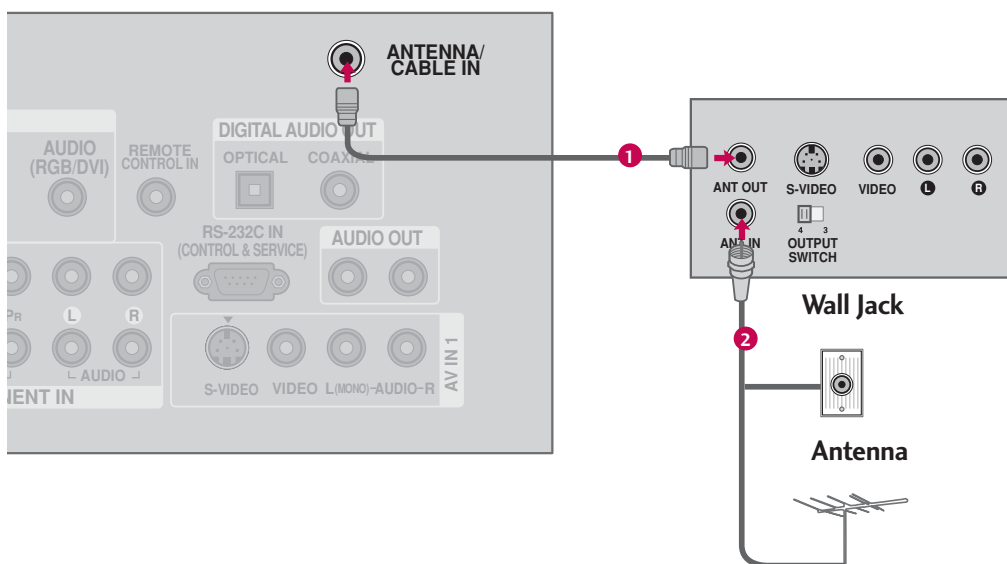

1. How to connect

- 1 Connect the RF antenna out socket of the VCR to the **ANTENNA/CABLE IN** socket on the set.
- 2 Connect the antenna cable to the RF antenna in socket of the VCR.

2. How to use

- Set VCR output switch to 3 or 4 and then tune TV to the same channel number.
- Insert a video tape into the VCR and press PLAY on the VCR. (Refer to the VCR owner's manual.)

EXTERNAL EQUIPMENT SETUP

When connecting with a RCA cable

1. How to connect

- 1 Connect the **AUDIO/VIDEO** jacks between TV and VCR. Match the jack colors (Video = yellow, Audio Left = white, and Audio Right = red)

2. How to use

- Insert a video tape into the VCR and press PLAY on the VCR. (Refer to the VCR owner's manual.)
- Select **AV1** input source by using the **INPUT** button on the remote control.
- If connected to **AV IN2**, select **AV2** input source.

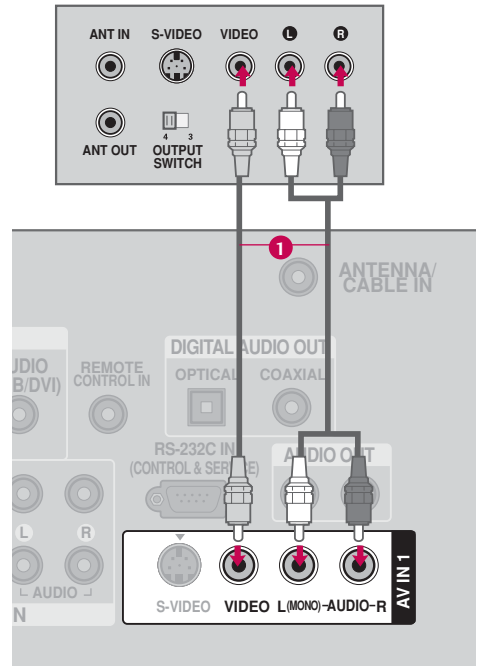

NOTE ▶ If you have a mono VCR, connect the audio cable from the VCR to the **AUDIO L/MONO** jack of the set.

When connecting with an S-Video cable

1. How to connect

- 1 Connect the S-VIDEO output of the VCR to the S-VIDEO input on the set.
- 2 Connect the audio outputs of the VCR to the **AUDIO** input jacks on the set.

2. How to use

- Insert a video tape into the VCR and press PLAY on the VCR. (Refer to the VCR owner's manual.)
- Select **AV1** input source by using the **INPUT** button on the remote control.

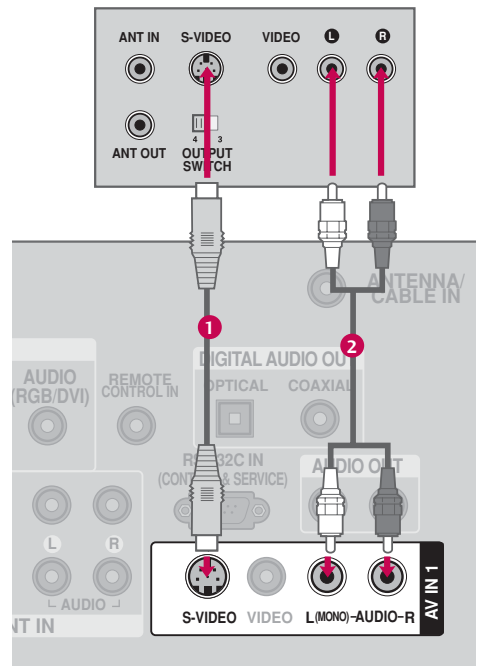

NOTE
▶ The picture quality is improved: compared to normal composite (RCA cable) input.

CAUTION
▶ Do not connect to both Video and S-Video at the same time. In the event that you connect both Video and the S-Video cables, only the S-Video will work.

OTHER A/V SOURCE SETUP

1. How to connect

- 1 Connect the **AUDIO/VIDEO** jacks between TV and external equipment. Match the jack colors. (Video = yellow, Audio Left = white, and Audio Right = red)

2. How to use

- Select **AV2** input source by using the **INPUT** button on the remote control.
- If connected to **AV IN1** input, select **AV1** input source.
- Operate the corresponding external equipment.

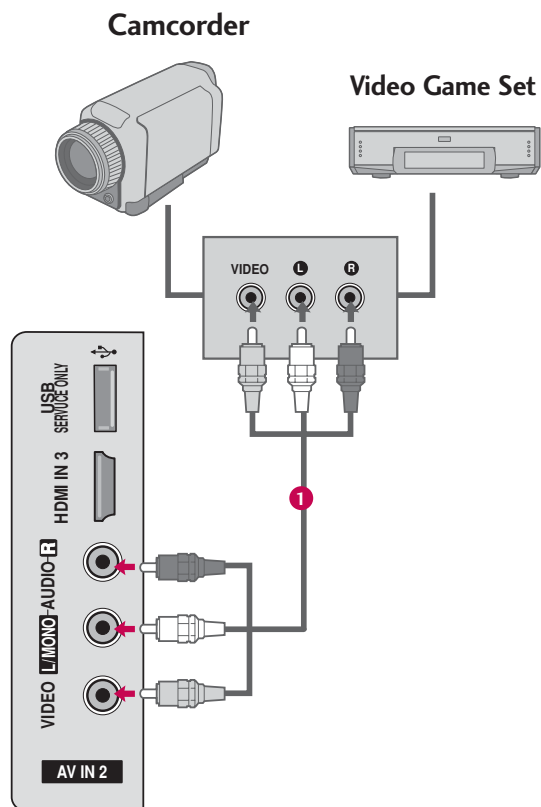

EXTERNAL EQUIPMENT SETUP

PC SETUP

This TV provides Plug and Play capability, meaning that the PC adjusts automatically to the TV's settings.

When connecting D-sub 15 pin cable

EXTERNAL EQUIPMENT SETUP

1. How to connect

- 1 Connect the RGB output of the PC to the **RGB (PC)** jack on the set.
- 2 Connect the PC audio output to the **AUDIO (RGB/DVI)** jack on the set.

2. How to use

- Turn on the PC and the TV.
- Select **RGB-PC** input source by using the **INPUT** button on the remote control.

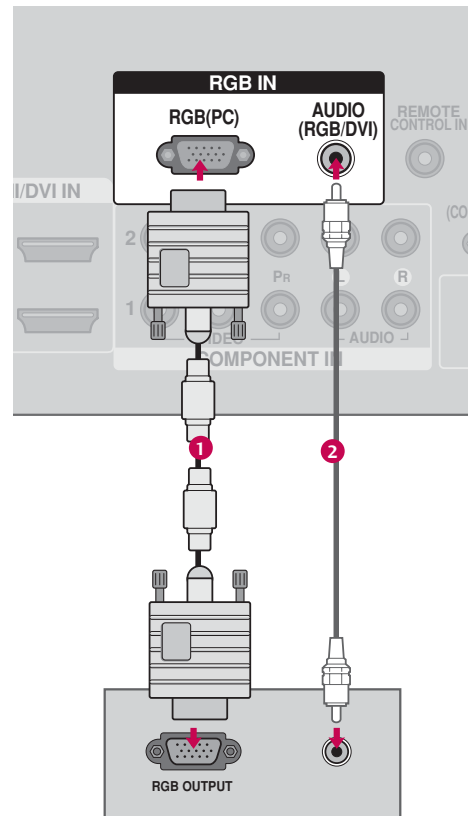

When connecting HDMI to DVI cable

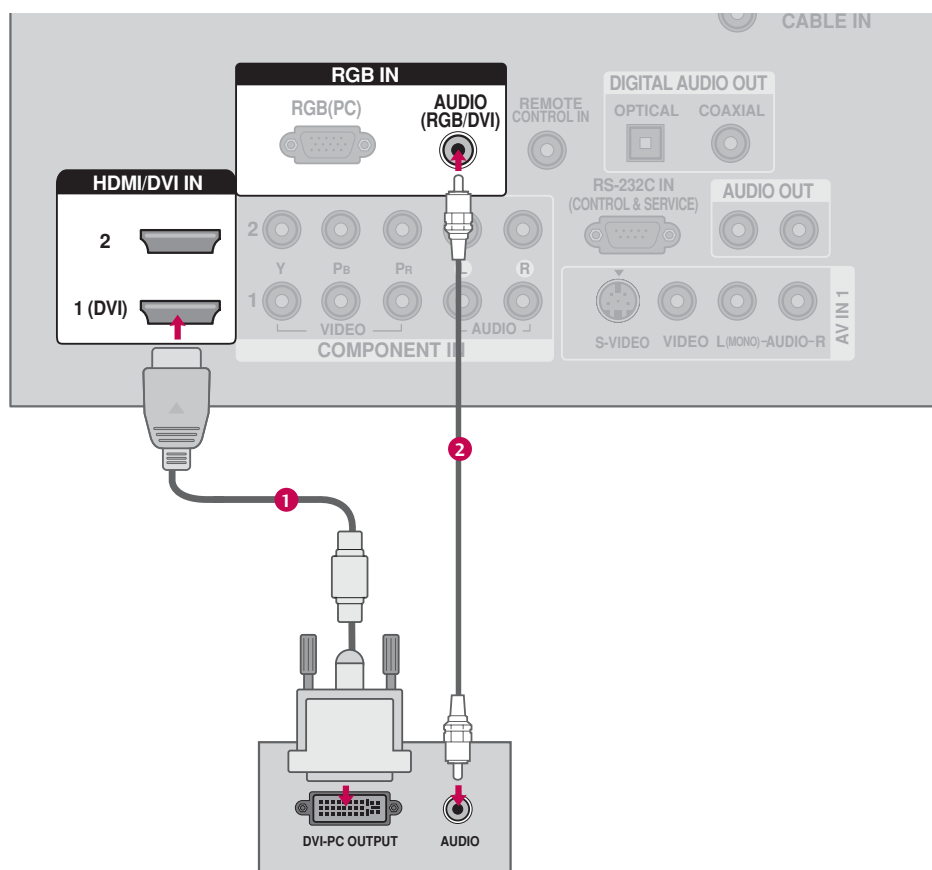

1. How to connect

- 1 Connect the DVI output of the PC to the **HDMI/DVI IN1 (DVI)** jack on the set.
- 2 Connect the PC audio output to the **AUDIO (RGB/DVI)** jack on the set.

2. How to use

- Turn on the PC and the TV.
- Select **HDMI1** input source with using the **INPUT** button on the remote control.

EXTERNAL EQUIPMENT SETUP

! NOTES

- ▶ For LCD TV: To get the the best picture quality, adjust the PC graphics card to 1366x768.
- ▶ For Plasma TV: To get the the best picture quality, adjust the PC graphics card to 1360x768.
- ▶ Depending on the graphics card, DOS mode may not work if a HDMI to DVI Cable is in use.
- ▶ Check the image on your TV. There may be noise associated with the resolution, vertical pattern, contrast or brightness in PC mode. If noise is present, change the PC output to another resolution, change the refresh rate to another rate or adjust the brightness and contrast on the PICTURE menu until the picture is clear. If the refresh rate of the PC graphic card can not be changed, change the PC graphic card or consult the manufacturer of the PC graphic card.
- ▶ Avoid keeping a fixed image on the screen for a long period of time. The fixed image may become permanently imprinted on the screen.
- ▶ The synchronization input form for Horizontal and Vertical frequencies is separate.

Supported Display Specifications

For 26/32/37/42LG30, 42/50PG10, 42/50PG20

RGB-PC, HDMI-PC

Resolution	Horizontal Frequency(KHz)	Vertical Frequency(Hz)
640x350	31.469	70.08 ●
720x400	31.469	70.08 ●
640x480	31.469	59.94
800x600	37.879	60.31
1024x768	48.363	60.00
1280x768	47.776	59.87
1360x768	47.720	59.799
1366x768	47.130	59.65 ●

* Only RGB-PC mode

* Only LCD TV

Supported Display Specifications

For 37/42/47/52LG50, 32/37/42/47/52LG60
32/42/47/52LG70, 50/60PG60F

RGB-PC, HDMI-PC

Resolution	Horizontal Frequency(KHz)	Vertical Frequency(Hz)
640x350	31.468	70.09
720x400	31.469	70.08
640x480	31.469	59.94
	37.500	75.00
	37.861	72.80
800x600	35.156	56.25
	37.879	60.31
	46.875	75.00
	48.077	72.18
1024x768	48.363	60.00
	56.476	70.06
	60.023	75.02
1280x768	47.776	59.87
	60.289	74.893
		* RGB-PC mode only
1280x1024	63.981	60.02
	79.976	75.025
1360x768	47.712	60.015
1600x1200	75.00	60.00
1920x1080	66.587	59.934

NOTE

- ▶ Depending on graphic card and signal status, there can be some shaking to find best picture in a little time.

EXTERNAL EQUIPMENT SETUP







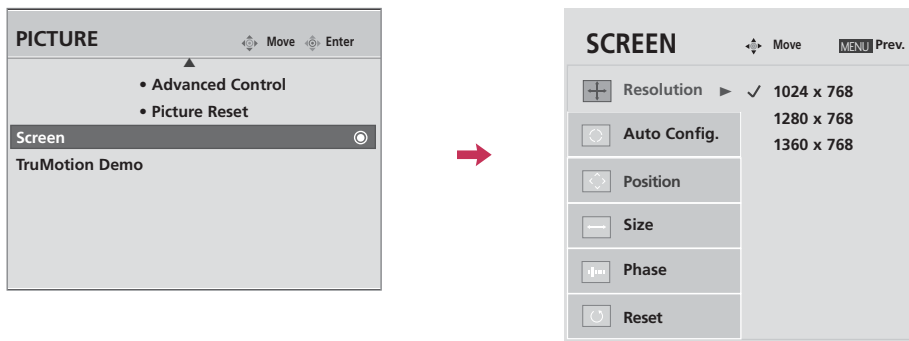

Screen Setup for PC mode

Selecting Resolution

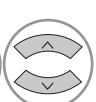
When you change the resolution, select the proper resolution in present input to see the best picture appearance. XGA (1024, 1280, 1360) isn't distinguished because of having the same H/V Sync Time. This function is you to select the Default Sync Time.

This feature operates only in RGB-PC mode.

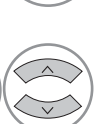

-   Select **PICTURE**.
-   Select **SCREEN**.
-   Select **Resolution**.
-   Select the desired resolution.
-  Return to the previous menu.









Auto Configure

Automatically adjusts picture position and minimizes image instability. After adjustment, if the image is still not correct, your TV is functioning properly but needs further adjustment.

Auto configure

This function is for automatic adjustment of the screen position, clock, and phase. The displayed image will be unstable for a few seconds while the auto configuration is in progress.



- 1   Select **PICTURE**.
- 2   Select **SCREEN**.
- 3   Select **Auto Config.**
- 4   Select **Yes**.
- 5  Start Auto Configuration.

- If the position of the image is still not correct, try Auto adjustment again.
- If picture needs to be adjusted again after Auto adjustment in RGB-PC, you can adjust the **Position**, **Size** or **Phase**.

PREPARATION

Adjustment for screen Position, Size, and Phase

If the picture is not clear after auto adjustment and especially if characters are still trembling, adjust the picture phase manually.

This feature operates only in RGB-PC mode.

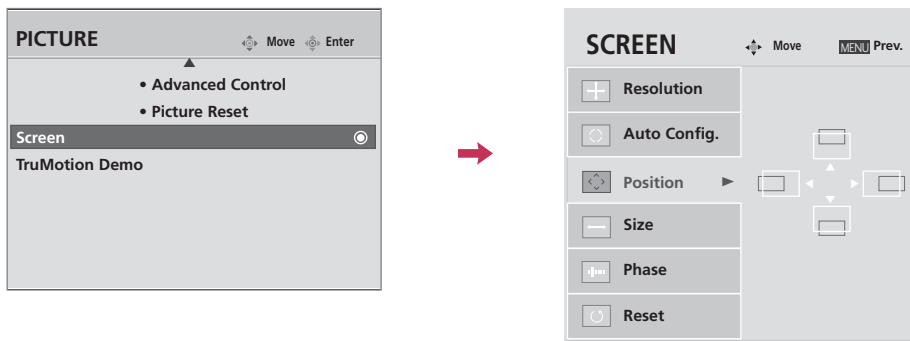









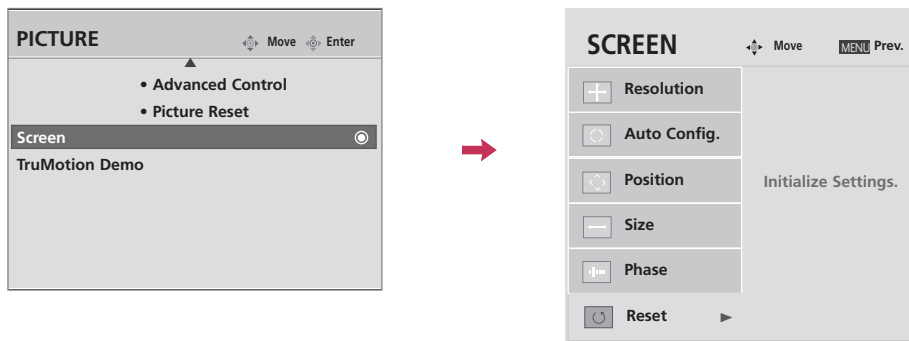

- 1 MENU Select **PICTURE**.
- 2 ENTER Select **SCREEN**.
- 3 ENTER Select **Position, Size, or Phase**.
- 4 ENTER Make appropriate adjustments.

- **Position:** This function is to adjust picture to left/right and up/down as you prefer.
- **Size:** This function is to minimize any vertical bars or stripes visible on the screen background. And the horizontal screen size will also change. The **Size** adjustment range is **-30 ~ +30**.
- **Phase:** This function allows you to remove any horizontal noise and clear or sharpen the image of characters. The **Phase** adjustment range is **-16 ~ +16**.

Screen Reset (Reset to original factory values)

Returns to the default settings Resolution, Auto Config., Position, Size and Phase at the factory.



- 1   Select **PICTURE**.
- 2   Select **SCREEN**.
- 3   Select **Reset**.
- 4   Select **Yes**.
- 5 

EXTERNAL EQUIPMENT SETUP

USB IN SETUP

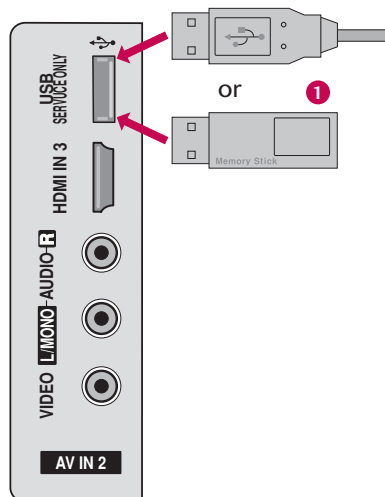

1. How to connect

- 1 Connect the USB device to the **USB SERVICE ONLY** jack on the side of TV.

2. How to use

- After connecting the **USB** jack, you use the USB function.
(▶ p.56)

AUDIO OUT SETUP

Send the TV's audio to external audio equipment via the Audio Output port.

Analog

1. How to connect

- 1 Connect audio outputs to the TV's **AUDIO OUT** jacks.
- 2 Set the "TV Speaker option - Off" in the AUDIO menu. (▶ p.85). See the external audio equipment instruction manual for operation.

Digital

1. How to connect

- 1 Connect one end of the optical or coaxial cable to the TV's **OPTICAL** or **COAXIAL** (Except **LG30) port of **DIGITAL AUDIO OUT**.
- 2 Connect the other end of the optical or coaxial cable to the digital audio input on the audio equipment.
- 3 Set the "TV Speaker option - Off" in the AUDIO menu. (▶ p.85). See the external audio equipment instruction manual for operation.

NOTE

- ▶ When connecting with external audio equipments, such as amplifiers or speakers, please turn the TV speakers off. (▶ p.85)

CAUTION

- ▶ Do not look into the optical output port. Looking at the laser beam may damage your vision.
- ▶ Block the SPDIF out (optical/coaxial) about the contents with ACP(Audio Copy Protection) function.

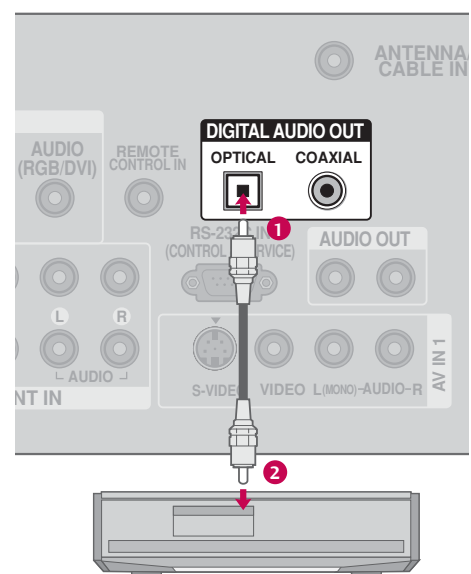
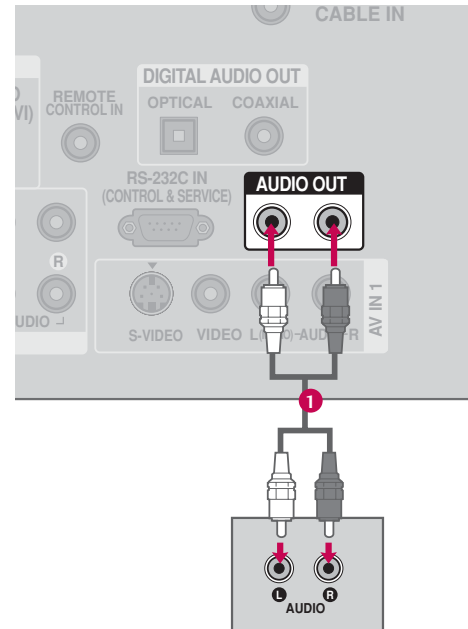

WATCHING TV / CHANNEL CONTROL

REMOTE CONTROL FUNCTIONS

When using the remote control, aim it at the remote control sensor on the TV.

TV/STB/DVD/VCR Select the remote operating mode: TV, STB, DVD, or VCR.
 * If the mode of another product is selected, a button on the remote control which is not used for the selected product can control the TV.

POWER Turns your TV or any other programmed equipment on or off, depending on the mode.

Q.MENU Select the desired quick menu source. ▶ p.43

MENU Displays the main menu.

INPUT External input modes rotate in regular sequence

VOLUME UP /DOWN Increase/decrease the sound level.

FAV Scroll through the programmed Favorite channels. ▶ p.43

MUTE Switch the sound on or off. ▶ p.42

CHANNEL UP/DOWN Select available channels.

PAGE UP/DOWN Move from one full set of screen information to the next one.

NUMBER button

— (DASH) Used to enter a program number for multiple program channels such as 2-1, 2-2, etc.

BACK Tune to the last channel viewed.

VCR/DVD buttons

- Control video cassette recorders or DVD players.
- Control USB menu (PHOTO LIST and MUSIC LIST.)
- Control the SIMPLINK compatible devices.

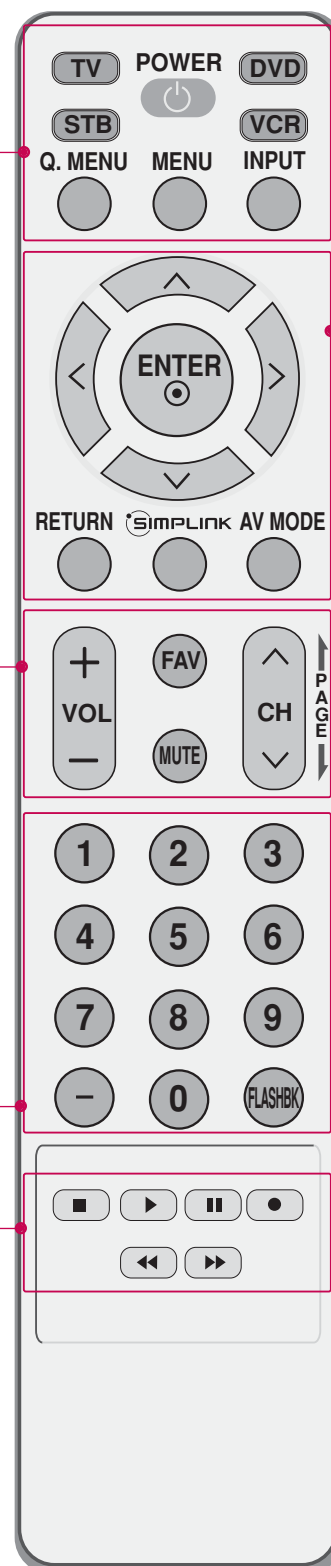

THUMBSTICK (Up/Down/Left Right/ENTER) Navigate the on-screen menus and adjust the system settings to your preference.

RETURN Clear all on-screen displays and return to TV viewing from any menu.

SIMPLINK See a list of AV devices connected to TV.
When you toggle this button, the SimpLink menu appears at the screen. ► p.54-55

AV MODE It helps you select and set images and sounds when connecting AV devices. ► p.53

Installing Batteries

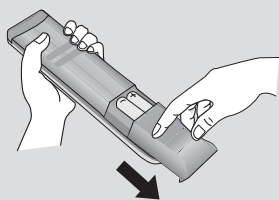

- Open the battery compartment cover on the back side and install the batteries matching correct polarity (+with +,-with -).
- Install two 1.5V AAA batteries. Don't mix old or used batteries with new ones.
- Close cover.

WATCHING TV / CHANNEL CONTROL

TURNING ON TV

- 1** First, connect power cord correctly.
At this moment, the TV switches to standby mode.
 - In standby mode to turn TV on, press the $\phi/|$, **INPUT**, **CH** (\blacktriangle or \blacktriangledown) button on the TV or press the **POWER**, **INPUT**, **CH** (\wedge \vee), **Number** (0~9) button on the remote control.
 - 2** Select the viewing source by using the **INPUT** button on the remote control.
 - This TV is programmed to remember which power state it was last set to, even if the power cord is out.
 - 3** When finished using the TV, press the **POWER** button on the remote control. The TV reverts to standby mode.
-

! NOTE

- ▶ If you intend to be away on vacation, disconnect the power plug from the wall power outlet.

CHANNEL SELECTION

- 1** Press the **CH** (\wedge \vee) or **NUMBER** buttons to select a channel number.
-



VOLUME ADJUSTMENT

Adjust the volume to suit your personal preference.

- 1** Press the **VOL** (+ or -) button to adjust the volume.
 - 2** If you want to switch the sound off, press the **MUTE** button.
 - 3** You can cancel the Mute function by pressing the **MUTE** or **VOL** (+ or -) button.
-

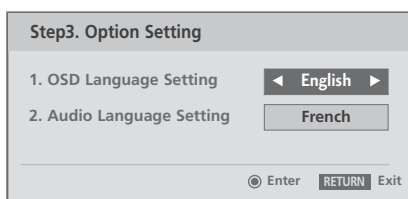
Step3. Option setting



- 1  Select **OSD Language Setting** or **Audio Language Setting**.
- 2  Select your desired language.
- 3 

Step4. Auto Tuning

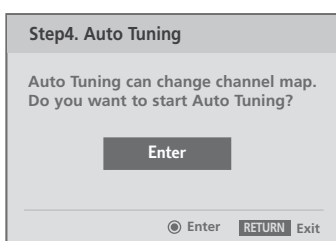



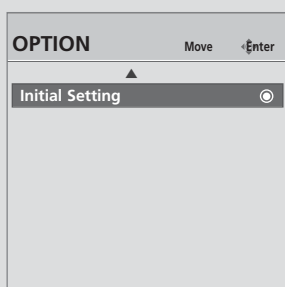

- 1  Start **Auto Tuning**.

! NOTE

- You can also adjust **Initial Setting** in the **OPTION** menu.



- 1   Select **OPTION**.
- 2   Select **Initial Setting**.
- 3 

WATCHING TV / CHANNEL CONTROL

CHANNEL SETUP





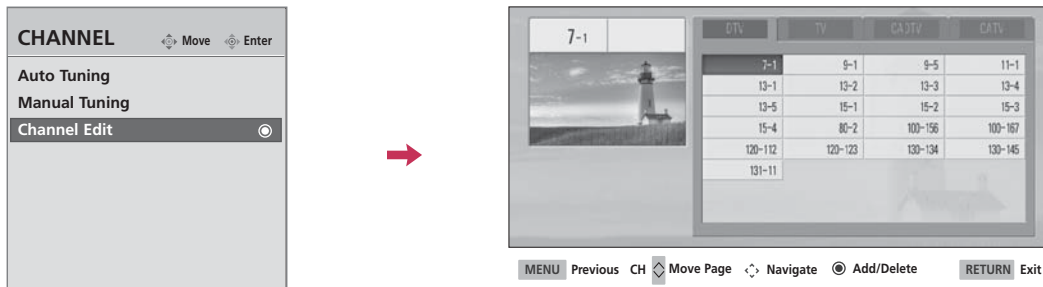

Channel Editing

From the default channel list created from the Auto Tuning channel search, you can create two different types of channel lists in memory: “custom list” and “favorite channel list”.

A custom list can be created by toggling each channel on or off with **ENTER** button. The channels in the Custom List are displayed in black and the channels deleted from the Custom List are displayed in gray.

Once a channel is highlighted you can add or delete the channel by referring to the small window at the top-left corner of the screen.



-   Select **CHANNEL**.
-   Select **Channel Edit**.
-   Select a channel.
-  Select channel you want to add or delete.
-  Return to the previous menu.
-  Return to TV viewing

AV MODE

You can select the optimal images and sounds when connecting AV devices to external input.

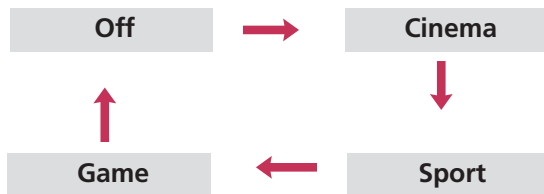

Press the **AV MODE** button repeatedly to select the desired source.



Return to the previous menu.

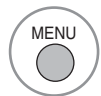

Return to TV viewing

- If you select Cinema Mode in AV mode, Cinema mode will be selected both for Picture and Sound Mode in PICTURE and AUDIO menu respectively.
- If you select “Off” in AV mode, the picture and image which you initially set will be selected.

USB

- This feature is only for 32/37/42/47/52LG50/60/70, 50/60PG60F.

ENTRY MODES

When you connect a USB device, this screen is displayed, automatically.
In USB device, you can not add a new folder or delete the existing folder.

- 1 Connect the USB device to the **USB IN** jacks on the side of TV.

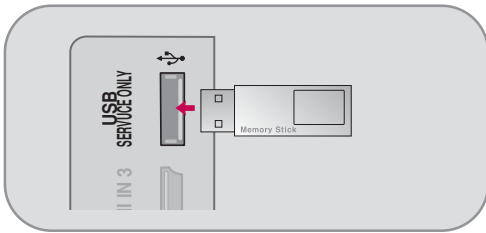

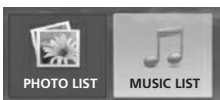

- 2  Select **PHOTO LIST** or **MUSIC LIST**



- 3 

When removing the USB device

Select the USB EJECT menu before removing the USB device.

- 1   Select **USB Eject**.
- 2 

Precautions when using the USB device

- ▶ Only a USB storage device is recognizable.
- ▶ If the USB storage device is connected through a USB hub, the device is not recognizable.
- ▶ A USB storage device using an automatic recognition program may not be recognized.
- ▶ A USB storage device which uses its own driver may not be recognized.
- ▶ In case of a card reader, up to four memory cards are concurrently recognizable.
- ▶ The recognition speed of a USB storage device may depend on each device.
- ▶ Please do not turn off the TV or unplug the USB device when the connected USB storage device is working. When such device is suddenly separated or unplugged, the stored files or the USB storage device may be damaged.
- ▶ Please do not connect the USB storage device which was artificially maneuvered on the PC. The device may cause the product to malfunction or fail to be played. Never forget to use only a USB storage device which has normal music files or image files.
- ▶ Please use only a USB storage device which was formatted as a FAT32 file system provided with the Windows operating system. In case of a storage device formatted as a different utility program which is not supported by Windows, it may not be recognized.
- ▶ Please connect power to a USB storage device which requires an external power supply. If not, the device may not be recognized.
- ▶ Please connect a USB storage device with cable is offered by USB maker. If connected with cable is not offered by USB maker or an excessively long cable, the device may not be recognized.
- ▶ Some USB storage devices may not be supported or operated smoothly.
- ▶ If the name of a folder or file is too long, it will not be displayed or recognized.
- ▶ Please backup the important file because a data of USB device may be damaged. Data management is consumer's responsibility and in consequence the manufactures does not cover the product bearing data damage.

PHOTO LIST

It's available to playback the photo file(*.jpg) in the USB device.

The On Screen Display may be different from your set. Images are an example to assist with the TV operation.

PHOTO (*.JPEG) supporting file

Baseline: width<=4800, height is no limit

- You can play JPEG files only.
- Only baseline scan is supported among JPEG.
- Non-supported files are displayed in the form of icon.

Screen Components

1

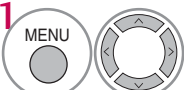

Select **USB**.

2



Select **Photo List**.

- ① Moves to upper level file
- ② Current page/Total pages
- ③ Total number of marked thumbnail photos
- ④ Usable USB memory
- ⑤ Corresponding buttons on the remote control

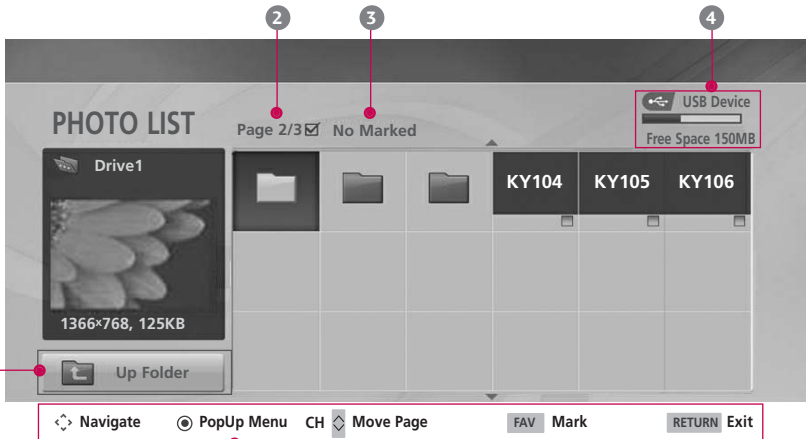



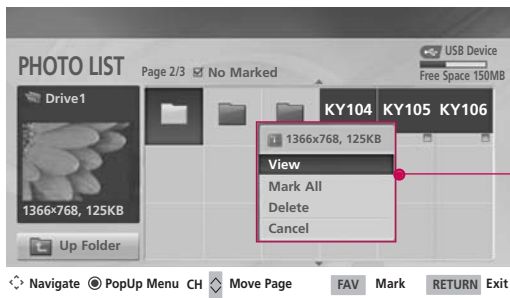
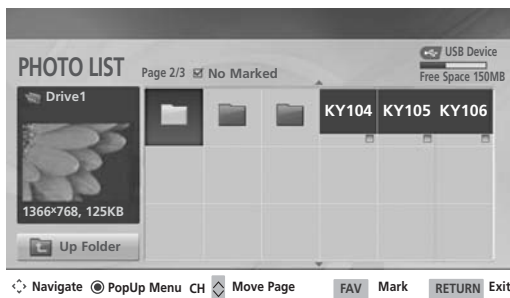

The screenshot shows a 'PHOTO LIST' interface. At the top, it displays 'Page 2/3' and 'No Marked'. A 'USB Device' icon is shown with 'Free Space 150MB'. Below this, there are thumbnails for 'Drive1' (1366x768, 125KB) and folders 'KY104', 'KY105', and 'KY106'. A 'Up Folder' button is at the bottom left. A red box highlights the bottom of the screen, showing remote control buttons: 'Navigate', 'PopUp Menu', 'CH', 'Move Page', 'FAV', 'Mark', and 'RETURN Exit'. Numbered callouts 1-5 point to these elements: 1 to 'Up Folder', 2 to 'Page 2/3', 3 to 'No Marked', 4 to 'USB Device', and 5 to the 'PopUp Menu' button.

USB

Photo Selection and PopUp Menu

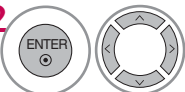

- ▶ **View:** Display the selected item.
- ▶ **Mark All:** Mark all photos on the screen.
- ▶ **Unmark All:** Deselect all marked photos.
- ▶ **Delete:** Delete the selected photo item.
- ▶ **Cancel:** Close the pop-up menu.

-  Select the target folder or drive.
-  Select the desired photos.
-  Show the PopUp menu.
-  Select the desired PopUp menu.
-  Return to TV viewing
-  Return to the previous menu.





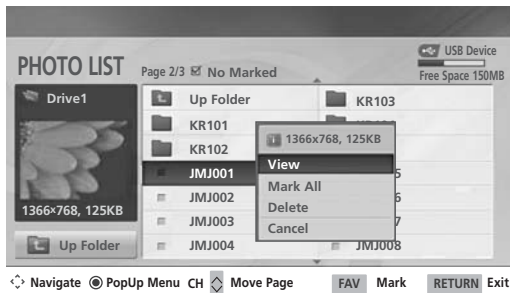
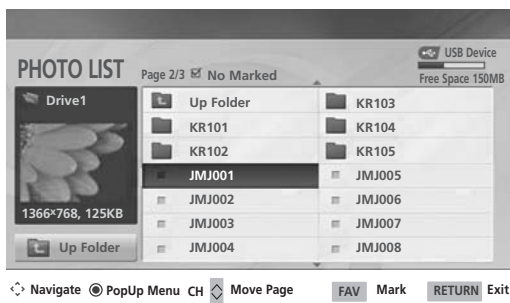

- Use the **CH** \wedge \vee button to navigation in the thumbnail photo page.
- Use the **FAV** button to mark or unmark a photo. When one or more photos are marked, you can view individual photos or a slide show of the marked photos. If no photos are marked, you can view all photos individually or all photos in the folder in a slide show.



Set up the menu in Full-Sized Screen

You can change the settings to display photos stored on a USB device, on a full-sized screen. Detailed operations are available on full-sized photo view screen.



The aspect ratio of a photo may change the size of the photo displayed on the screen in full size.

- 1  Select the target folder or drive.
- 2   Select the desired photos.
- 3  show the PopUp menu.
- 4  Select **View**
- 5  The selected photo is displayed in full size.

- Use the CH   button to navigation in the thumbnail photo page.

USB



The aspect ratio of a photo may change the size of the photo displayed on the screen in full size.

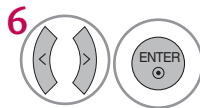

Select the **Slideshow**, **BGM**, **Rotate**, **Delete**, **Option**, or **Hide**.

- Use **^** **v** **<** **>** button to select the previous or next photo.
- Use **^** **v** **<** **>** button to select and control the menu on the full-sized screen.

- ▶ **Slideshow** : When no picture is selected, all photos in the current folder are displayed during slide show. When selected, the selected photos are displayed during slide show.
 - Set the time interval of the slide show in **Option**.
- ▶ **BGM** : Listen to music while viewing photos in full size.
 - Set the BGM device and album in **Option**.
- ▶ **Rotate** : Rotate photos.
 - Rotates the photo 90°, 180°, 270°, 360° clockwise.
 - A slide show continues for a maximum of 4 hours. After 4 hours, the slide show will end and go to TV mode or external input mode.
- ▶ **Delete** : Delete photos.
- ▶ **Option** : Set values for **Slide Speed** and **Music Folder**.
 - Use **<** **>** button and **ENTER** button to set values. Then go to **Enter** and press **ENTER** to save the settings.
 - You cannot change **Music Folder** while BGM is playing.
- ▶ **Hide** : Hide the menu on the full-sized screen.
 - To see the menu again on the full-sized screen, press **ENTER** button to display.

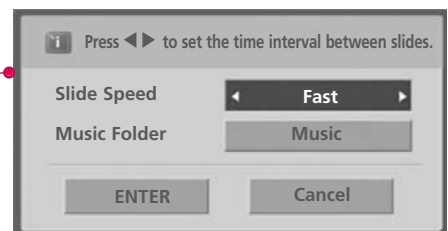

NOTE

- ▶ If it is Progressive JPEG format, some photos may be not decoded.

PICTURE CONTROL

PICTURE IMPROVEMENT TECHNOLOGY

Fresh Contrast: Optimizes the contrast automatically according to the brightness of the reflection.







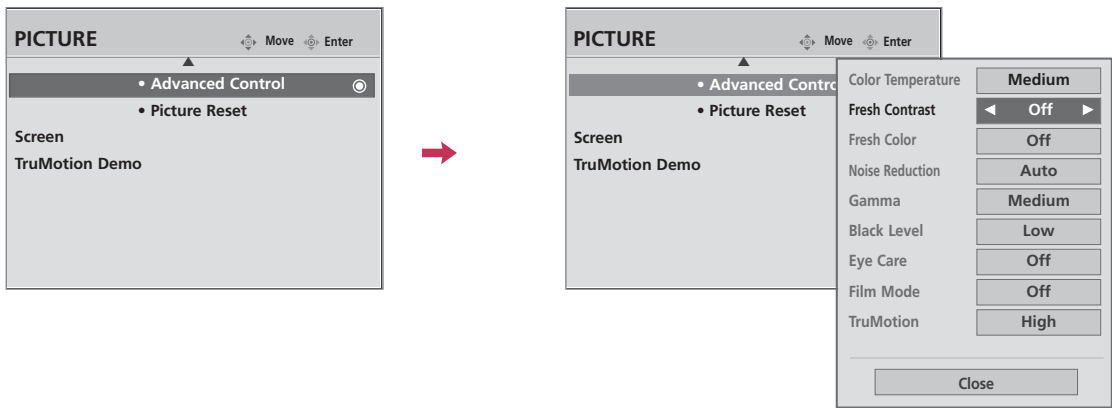

Fresh Color: Adjusts the color of the reflection automatically to reproduce as close as possible natural colors.

Noise Reduction: Removes interference up to the point where it does not damage the original picture.

Gamma: High gamma values display whitish images and low gamma values display high contrast images.



PICTURE CONTROL

-   Select **PICTURE**.
-   Select **Advanced Control**.
-   Select **Fresh Contrast, Fresh Color, Noise Reduction, or Gamma**.
-  Select your desired options.
-  Return to the previous menu.
-  Return to TV viewing

KEY LOCK

The TV can be set up so that it can only be used with the remote control.

This feature can be used to prevent unauthorized viewing by locking out the front panel controls.

This TV is programmed to remember which option it was last set to even if you turn the TV off.

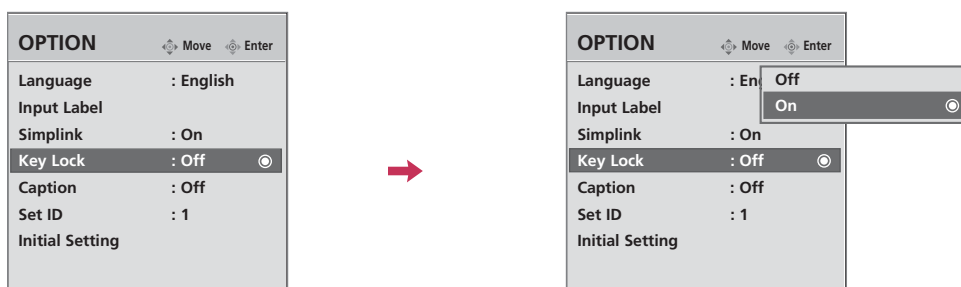

1   Select **OPTION**.

2   Select **Key Lock**

3   Select **On** or **Off**.

4  Return to the previous menu.

 Return to TV viewing

- In **Key Lock 'On'**, if the TV is turned off, press the ϕ / I, **INPUT**, **CH ▲** or **▼** button on the TV or **POWER**, **INPUT**, **CH ^** **∨** or **NUMBER** buttons on the remote control.
- With the **Key Lock On**, the display '**Key Lock On**' appears on the screen if any button on the front panel is pressed while viewing the TV.

APPENDIX

TROUBLESHOOTING

The operation does not work normally.

The remote control doesn't work

- Check to see if there is any object between the product and the remote control causing obstruction. Ensure you are pointing the remote control directly at the TV.
- Ensure that the batteries are installed with correct polarity (+ to +, - to -).
- Ensure that the correct remote operating mode is set: TV, VCR etc.
- Install new batteries.

Power is suddenly turned off

- Is the sleep timer set?
- Check the power control settings. Power interrupted.
- No broadcast on station tuned with Auto off activated.

The video function does not work.

No picture & No sound

- Check whether the product is turned on.
- Try another channel. The problem may be with the broadcast.
- Is the power cord inserted into wall power outlet?
- Check your antenna direction and/or location.
- Test the wall power outlet, plug another product's power cord into the outlet where the product's power cord was plugged in.

Picture appears slowly after switching on

- This is normal, the image is muted during the product startup process. Please contact your service center, if the picture has not appeared after five minutes.

No or poor color or poor picture

- Adjust Color in menu option.
- Keep a sufficient distance between the product and the VCR.
- Try another channel. The problem may be with the broadcast.
- Are the video cables installed properly?
- Activate any function to restore the brightness of the picture.

Horizontal/vertical bars or picture shaking

- Check for local interference such as an electrical appliance or power tool.

Poor reception on some channels

- Station or cable product experiencing problems, tune to another station.
- Station signal is weak, reorient antenna to receive weaker station.
- Check for sources of possible interference.

Lines or streaks in pictures

- Check antenna (Change the direction of the antenna).

The audio function does not work.

Picture OK & No sound	<ul style="list-style-type: none">■ Press the VOL or VOLUME button.■ Sound muted? Press MUTE button.■ Try another channel. The problem may be with the broadcast.■ Are the audio cables installed properly?
No output from one of the speakers	<ul style="list-style-type: none">■ Adjust Balance in menu option.
Unusual sound from inside the product	<ul style="list-style-type: none">■ A change in ambient humidity or temperature may result in an unusual noise when the product is turned on or off and does not indicate a fault with the product.

There is a problem in PC mode. (Only PC mode applied)

The signal is out of range	<ul style="list-style-type: none">■ Adjust resolution, horizontal frequency, or vertical frequency.■ Check the input source.
Vertical bar or stripe on background & Horizontal Noise & Incorrect position	<ul style="list-style-type: none">■ Work the Auto configure or adjust clock, phase, or H/V position. (Option)
Screen color is unstable or single color	<ul style="list-style-type: none">■ Check the signal cable.■ Reinstall the PC video card.

MAINTENANCE

Early malfunctions can be prevented. Careful and regular cleaning can extend the amount of time you can enjoy your new TV.

Caution: Be sure to turn the power off and unplug the power cord before you begin any cleaning.

Cleaning the Screen

- 1 Here's a great way to keep the dust off your screen for a while. Wet a soft cloth in a mixture of lukewarm water and a little fabric softener or dish washing detergent. Wring the cloth until it's almost dry, and then use it to wipe the screen.
- 2 Make sure the excess water is off the screen, and then let it air-dry before you turn on your TV.

Cleaning the Cabinet

- To remove dirt or dust, wipe the cabinet with a soft, dry, lint-free cloth.
- Please be sure not to use a wet cloth.

Extended Absence

CAUTION

- ▶ If you expect to leave your TV dormant for a long time (such as a vacation), it's a good idea to unplug the power cord to protect against possible damage from lightning or power surges.

PRODUCT SPECIFICATIONS

MODELS		26LG30 (26LG30-UA)	32LG30 (32LG30-UA)
Dimensions (Width x Height x Depth)	With stand	26.1 x 20.0 x 9.1 inches 663.8 x 508.2 x 231.9 mm	31.8 x 23.8 x 9.1 inches 807.7 x 604.2 x 232.0 mm
	Without stand	26.1 x 17.7 x 3.6 inches 663.8 x 449.8 x 91.4 mm	31.8 x 21.4 x 4.0 inches 807.7 x 544.1 x 101.0 mm
Weight	With stand	22.3 pounds / 10.1 kg	29.1 pounds / 13.2 kg
	Without stand	19.0 pounds / 8.6 kg	25.4 pounds / 11.5 kg
MODELS		37LG30 (37LG30-UA)	42LG30 (42LG30-UA)
Dimensions (Width x Height x Depth)	With stand	36.2 x 26.9 x 11.6 inches 919.6 x 682.3 x 293.8 mm	40.7 x 29.2 x 11.6 inches 1032.8 x 742.3 x 293.8 mm
	Without stand	36.2 x 24.0 x 4.5 inches 919.6 x 610.3 x 114.3 mm	40.7 x 26.4 x 4.5 inches 1032.8 x 670.1 x 115.1 mm
Weight	With stand	45.6 pounds / 20.7 kg	51.8 pounds / 23.5 kg
	Without stand	37.9 pounds / 17.2 kg	44.1 pounds / 20.0 kg
MODELS		37LG50 (37LG50-UA)	42LG50 (42LG50-UA)
Dimensions (Width x Height x Depth)	With stand	36.9 x 27.0 x 11.6 inches 936.4 x 684.4 x 293.8 mm	36.9 x 27.0 x 11.6 inches 936.4 x 684.4 x 293.8 mm
	Without stand	36.9 x 24.1 x 3.5 inches 936.4 x 612.8 x 88.0 mm	36.9 x 24.1 x 3.5 inches 936.4 x 612.8 x 88.0 mm
Weight	With stand	40.3 pounds / 18.3 kg	40.3 pounds / 18.3 kg
	Without stand	34.4 pounds / 15.6 kg	34.4 pounds / 15.6 kg
MODELS		47LG50 (47LG50-UA)	52LG50 (52LG50-UA)
Dimensions (Width x Height x Depth)	With stand	45.4 x 31.8 x 12.8 inches 1153.7 x 807.2 x 326.0 mm	50.9 x 35.1 x 13.5 inches 1291.7 x 892.2 x 342.9 mm
	Without stand	45.4 x 29.0 x 4.1 inches 1153.7 x 734.5 x 103.0 mm	50.9 x 32.2 x 4.5 inches 1291.7 x 817.0 x 115.3 mm
Weight	With stand	85.1 pounds / 38.6 kg	87.1 pounds / 39.5 kg
	Without stand	77.0 pounds / 34.9 kg	77.0 pounds / 34.9 kg
Power requirement Television System Program Coverage External Antenna Impedance		AC100-240V ~ 50/60Hz NTSC-M, ATSC, 64 & 256 QAM VHF 2-13, UHF 14-69, CATV 1-135, DTV 2-69, CADTV 1-135 75 ohm	
Environment condition	Operating Temperature Operating Humidity	32 ~ 104°F (0 ~ 40°C) Less than 80%	
	Storage Temperature Storage Humidity	-4 ~ 140°F (-20 ~ 60°C) Less than 85%	

■ The specifications shown above may be changed without prior notice for quality improvement.

APPENDIX

MODELS		32LG60 (32LG60-UA)	37LG60 (37LG60-UA)	42LG60 (42LG60-UA)
Dimensions (Width x Height x Depth)	With stand	31.8 x 23.9x 9.8 inches 806.6 x 606.5 x 249.0mm	36.5 x 27.3 x 11.0 inches 927.0 x 692.8 x 280.5 mm	40.7 x 29.5 x 11.3 inches 1033.4 x 750.0 x 287.6 mm
	Without stand	31.8 x 21.7 x 3.1 inches 806.6 x 552.3 x 79.0 mm	36.5 x 24.8 x 3.5 inches 927.0 x 630.0 x 88.0 mm	40.7 x 27.0x 3.5 inches 1033.4 x 686.8 x 88.5 mm
Weight	With stand	30.2 pounds / 13.7 kg	44.1 pounds / 20.0 kg	54.9 pounds / 24.9 kg
	Without stand	24.7 pounds / 11.2 kg	35.3 pounds / 16.0 kg	45.0 pounds / 20.4 kg
MODELS		47LG60 (47LG60-UA)	52LG60 (52LG60-UA)	
Dimensions (Width x Height x Depth)	With stand	45.4 x 31.8 x 12.8 inches 1153.7 x 807.2 x 326.0 mm	50.9 x 35.1 x 13.5 inches 1291.7 x 892.2 x 342.9 mm	
	Without stand	45.4 x 29.0 x 4.1 inches 1153.7 x 734.5 x 103.0 mm	50.9 x 32.2 x 4.5 inches 1291.7 x 817.0 x 115.3 mm	
Weight	With stand	85.1 pounds / 38.6 kg	87.1 pounds / 39.5 kg	
	Without stand	77.0 pounds / 34.9 kg	77.0 pounds / 34.9 kg	
MODELS		32LG70 (32LG70-UA)	42LG70 (42LG70-UA)	
Dimensions (Width x Height x Depth)	With stand	31.8 x 23.9x 9.8 inches 806.6 x 606.5 x 249.0mm	40.7 x 29.5 x 11.3 inches 1033.4 x 750.0 x 287.6 mm	
	Without stand	31.8 x 21.7 x 3.1 inches 806.6 x 552.3 x 79.0 mm	40.7 x 27.0x 3.5 inches 1033.4 x 686.8 x 88.5 mm	
Weight	With stand	30.2 pounds / 13.7 kg	54.9 pounds / 24.9 kg	
	Without stand	24.7 pounds / 11.2 kg	45.0 pounds / 20.4 kg	
MODELS		47LG70 (47LG70-UA)	52LG70 (52LG70-UA)	
Dimensions (Width x Height x Depth)	With stand	45.4 x 31.8 x 12.8 inches 1153.7 x 807.2 x 326.0 mm	50.9 x 35.1 x 13.5 inches 1291.7 x 892.2 x 342.9 mm	
	Without stand	45.4 x 29.0 x 4.1 inches 1153.7 x 734.5 x 103.0 mm	50.9 x 32.2 x 4.5 inches 1291.7 x 817.0 x 115.3 mm	
Weight	With stand	85.1 pounds / 38.6 kg	87.1 pounds / 39.5 kg	
	Without stand	77.0 pounds / 34.9 kg	77.0 pounds / 34.9 kg	
Power requirement Television System Program Coverage External Antenna Impedance		AC100-240V ~ 50/60Hz NTSC-M, ATSC, 64 & 256 QAM VHF 2-13, UHF 14-69, CATV 1-135, DTV 2-69, CADTV 1-135 75 ohm		
Environment condition	Operating Temperature Operating Humidity	32 ~ 104°F (0 ~ 40°C) Less than 80%		
	Storage Temperature Storage Humidity	-4 ~ 140°F (-20 ~ 60°C) Less than 85%		

■ The specifications shown above may be changed without prior notice for quality improvement.

MODELS		42PG10 (42PG10-UA)	50PG10 (50PG10-UA)
Dimensions (Width x Height x Depth)	With stand	41.3 x 30.2 x 12.2 inches 1048.0 x 766.0 x 310.0 mm	48.9 x 34.9 x 14.6 inches 1242.0 x 887.6 x 370.0 mm
	Without stand	41.3 x 28.1 x 3.3 inches 1048.0 x 713.0 x 83.5 mm	48.9 x 32.6 x 3.5 inches 1242.0 x 827.2 x 88.0 mm
Weight	With stand	61.7 pounds / 28.0 kg	86.6 pounds / 39.3 kg
	Without stand	54.2 pounds / 24.6 kg	76.3 pounds / 34.6 kg
MODELS		42PG20 (42PG20-UA)	50PG20 (50PG20-UA)
Dimensions (Width x Height x Depth)	With stand	41.3 x 30.2 x 12.2 inches 1048.0 x 766.0 x 310.0 mm	48.9 x 34.9 x 14.6 inches 1242.0 x 887.6 x 370.0 mm
	Without stand	41.3 x 28.1 x 3.3 inches 1048.0 x 713.0 x 83.5 mm	48.9 x 32.6 x 3.5 inches 1242.0 x 827.2 x 88.0 mm
Weight	With stand	61.7 pounds / 28.0 kg	86.6 pounds / 39.3 kg
	Without stand	54.2 pounds / 24.6 kg	76.3 pounds / 34.6 kg
MODELS		50PG60F-UA (50PG60F-UA)	60PG60F-UA (60PG60F-UA)
Dimensions (Width x Height x Depth)	With stand	48.9 x 34.9 x 14.6 inches 1242.0 x 887.6 x 370.0 mm	57.3 x 38.8 x 16.3 inches 1455.0 x 985.0 x 414.0 mm
	Without stand	48.9 x 32.6 x 3.5 inches 1242.0 x 827.2 x 88.0 mm	57.3 x 38.5 x 15.8 inches 1455.0 x 914.8 x 82.8 mm
Weight	With stand	86.6 pounds / 39.3 kg	137.6 pounds / 62.4 kg
	Without stand	76.3 pounds / 34.6 kg	127.8 pounds / 58.0 kg
MODELS		50PG70F-UA (50PG70F-UA)	60PG70F-UA (60PG70F-UA)
Dimensions (Width x Height x Depth)	With stand	48.9 x 34.9 x 14.6 inches 1242.0 x 887.6 x 370.0 mm	57.5 x 38.5 x 15.8 inches 1459.4 x 976.8 x 401.0 mm
	Without stand	48.9 x 32.6 x 3.5 inches 1242.0 x 827.2 x 88.0 mm	57.5 x 38.5 x 15.8 inches 1459.4 x 914.8 x 82.8 mm
Weight	With stand	86.6 pounds / 39.3 kg	86.6 pounds / 39.3 kg
	Without stand	76.3 pounds / 34.6 kg	76.3 pounds / 34.6 kg
Power requirement Television System Program Coverage External Antenna Impedance		AC100-240V ~ 50/60Hz NTSC-M, ATSC, 64 & 256 QAM VHF 2-13, UHF 14-69, CATV 1-135, DTV 2-69, CADTV 1-135 75 ohm	
Environment condition	Operating Temperature Operating Humidity	32 ~ 104°F (0 ~ 40°C) Less than 80%	
	Storage Temperature Storage Humidity	-4 ~ 140°F (-20 ~ 60°C) Less than 85%	

■ The specifications shown above may be changed without prior notice for quality improvement.

APPENDIX

PROGRAMMING THE REMOTE CONTROL

The provided universal remote control can be programmed to operate most remote-controllable devices. Note that the remote may not control all models of other brands.

Programming a code into a remote mode

- 1** Testing your remote control.
To find out whether your remote control can operate other components without programming, turn on a component such as a STB and press the corresponding mode button (such as **STB**) on the remote control, while pointing at the component. Test the **POWER** and **CH** \wedge \vee buttons to see if the component responds correctly. If the component does not operate correctly, the remote control requires programming to operate the device.
- 2** Switch on the component to be programmed, then press the corresponding mode button (such as **STB**) on the remote control. The remote control button of the desired device is illuminated.
- 3** Press the **MENU** and **MUTE** buttons simultaneously, the remote control is ready to be programmed with the code.
- 4** Enter a code number using the number buttons on the remote control. Programming code numbers for the corresponding component can be found on the following pages. If the code is correct, the device will turn off.
- 5** Press the **MENU** button to store the code.
- 6** Test the remote control functions to see if the component responds correctly. If not, repeat from step 2.

VCR

Brand	Codes	Brand	Codes	Brand	Codes
AIWA	034	MAGNAVOX	031 033 034 041	SAMSUNG	032 040 102 104
AKAI	016 043 046 124		067 068		105 107 109 112
	125 146	MARANTZ	012 031 033 067		113 115 120 122
AMPRO	072		069		125
ANAM	031 033 103	MARTA	101	SANSUI	022 043 048 135
AUDIO DYNAMICS	012 023 039 043	MATSUI	027 030	SANYO	003 007 010 014
BROKSONIC	035 037 129	MEI	031 033		102 134
CANON	028 031 033	MEMOREX	003 010 014 031	SCOTT	017 037 112 129
CAPEHART	108		033 034 053 072		131
CRAIG	003 040 135		101 102 134 139	SEARS	003 008 009 010
CURTIS MATHES	031 033 041	MGA	045 046 059		013 014 017 020
DAEWOO	005 007 010 064	MINOLTA	013 020		031 042 073 081
	065 108 110 111	MITSUBISHI	013 020 045 046		101
	112 116 117 119		049 051 059 061	SHARP	031 054 149
DAYTRON	108		151	SHINTOM	024
DBX	012 023 039 043	MTC	034 040	SONY	003 009 031 052
DYNATECH	034 053	MULTITECH	024 034		056 057 058 076
ELECTROHOME	059	NEC	012 023 039 043		077 078 149
EMERSON	006 017 025 027		048	SOUNDESIGN	034
	029 031 034 035	NORDMENDE	043	STS	013
	036 037 046 101	OPTONICA	053 054	SYLVANIA	031 033 034 059
	129 131 138 153	PANASONIC	066 070 074 083		067
FISHER	003 008 009 010		133 140 145	SYMPHONIC	034
FUNAI	034			TANDY	010 034
GE	031 033 063 072	PENTAX	013 020 031 033	TATUNG	039 043
	107 109 144 147		063	TEAC	034 039 043
GO VIDEO	132 136	PHILCO	031 034 067	TECHNICS	031 033 070
HARMAN KARDON	012 045	PHILIPS	031 033 034 054	TEKNIKA	019 031 033 034
HITACHI	004 018 026 034		067 071 101		101
	043 063 137 150	PILOT	101	THOMAS	034
INSTANTREPLAY	031 033	PIONEER	013 021 048	TMK	006
JCL	031 033	PORTLAND	108	TOSHIBA	008 013 042 047
JCPENNY	012 013 015 033	PULSAR	072		059 082 112 131
	040 066 101	QUARTZ	011 014	TOTEVISION	040 101
JENSEN	043	QUASAR	033 066 075 145	UNITECH	040
JVC	012 031 033 043	RCA	013 020 033 034	VECTOR RESEARCH	012
	048 050 055 060		040 041 062 063	VICTOR	048
	130 150 152		107 109 140 144	VIDEO CONCEPTS	012 034 046
KENWOOD	014 034 039 043		145 147	VIDEOSONIC	040
	047 048	REALISTIC	003 008 010 014	WARDS	003 013 017 024
LG (GOLDSTAR)	001 012 013 020		031 033 034 040		031 033 034 040
	101 106 114 123		053 054 101		053 054 131
LLOYD	034	RICO	058	YAMAHA	012 034 039 043
LXI	003 009 013 014	RUNCO	148	ZENITH	034 048 056
	017 034 101 106	SALORA	014		058 072 080 101
MAGIN	040				

APPENDIX

Remote Control Code

HDSTB

Brand	Codes	Brand	Codes	Brand	Codes
ALPHASTAR DSR	123	HOUSTON TRACKER	033 037 039 051	PROSAT	072
AMPLICA	050		057 104	RCA	066 106
BIRDVIEW	051 126 129	HUGHES	068	REALISTIC	043 074
CHANNEL MASTER	013 014 015 018 036 055	JANIEL	060 147	SAMSUNG	123
CHAPARRAL	008 009 012 077	JERROLD	061	SATELLITE SERVICE CO	028 035 047 057 085
CITOH	054	KATHREIN	108	SCIENTIFIC ATLANTA	032 138
CURTIS MATHES	050 145	LEGEND	057	SONY	103
DRAKE	005 006 007 010 011 052 112 116 141	LG	001	STARCAST	041
DX ANTENNA	024 046 056 076	LUTRON	132	SUPER GUIDE	020 124 125
ECHOSTAR	038 040 057 058 093 094 095 096 097 098 099 100 122	MACOM	010 059 063 064 065	TEECOM	023 026 075 087 088 090 107 130 137
ELECTRO HOME	089	MEMOREX	057	TOSHIBA	002 127
EUROPLUS	114	NEXTWAVE	028 124 125	UNIDEN	016 025 042 043 044 045 048 049 078 079 080 086 101 135 136
FUJITSU	017 021 022 027 133 134	NORSAT	069 070	VIEWSTAR	115
GENERAL INSTRUMENT	003 004 016 029 031 059 101	PACE SKY SATELLITE	143	WINEGARD	128 146
HITACHI	139 140	PANASONIC	060 142	ZENITH	081 082 083 084 091 120
		PANSAT	121		
		PERSONAL CABLE	117		
		PHILIPS	071		
		PICO	105		
		PRESIDENT	019 102		
		PRIMESTAR	030 110 111		

DVD

Brand	Codes	Brand	Codes	Brand	Codes
APEX DIGITAL	022	mitsubishi	002	RCA	005 006
DENON	020 014	NAD	023	SAMSUNG	011 015
GE	005 006	ONKYO	008 017	SONY	007
HARMAN KARDON	027	PANASONIC	003 009	THOMPSON	005 006
JVC	012	PHILIPS	013	TOSHIBA	019 008
LG	001 010 016 025	PIONEER	004 026	YAMAHA	009 018
MAGNAVOX	013	PROCEED	021	ZENITH	010 016 025
MARANTZ	024	PROSCAN	005 006		

IR CODES

1. How to Connect

- Connect your wired remote control to the Remote Control port on the TV.

2. Remote Control IR Codes

Output waveform

Single pulse, modulated with 37.917KHz signal at 455KHz

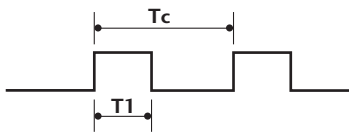

Carrier frequency
 $FCAR = 1/TC = fOSC/12$
 Duty ratio = $T1/TC = 1/3$

Configuration of frame

1st frame



Repeat frame

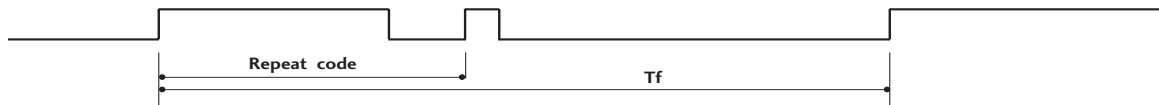

Lead code

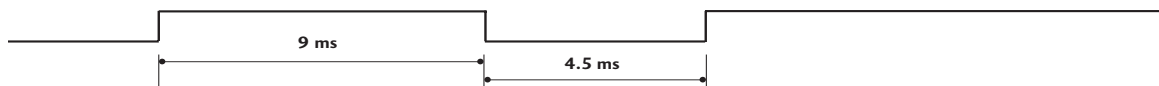

Repeat code

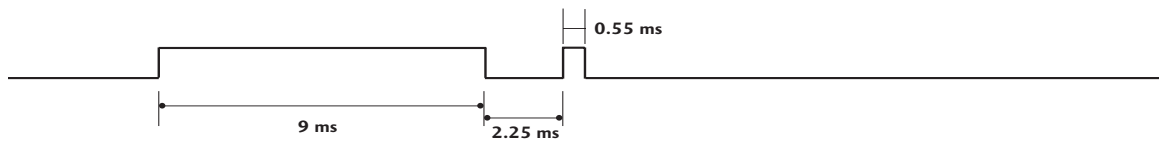

Bit description

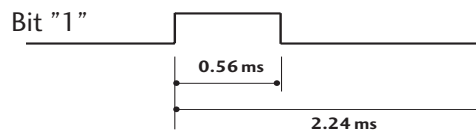
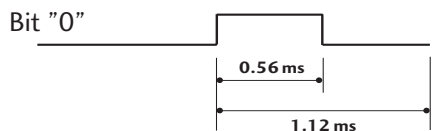

Frame interval: Tf

The waveform is transmitted as long as a key is depressed.

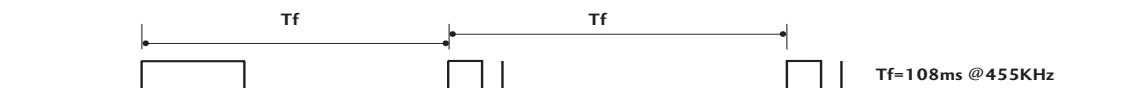

APPENDIX

Code (Hexa)	Function	Note
08	POWER	Remote control Button (Power On/Off)
45	Q.MENU	Remote control Button
43	MENU	Remote control Button
0B	INPUT	Remote control Button
10-19	Number Key 0-9	Remote control Button
4C	- (Dash)	Remote control Button
1A	FLASHBK	Remote control Button
09	MUTE	Remote control Button
02	VOL +	Remote control Button
03	VOL -	Remote control Button
00	CH ^	Remote control Button
01	CH v	Remote control Button
1E	FAV	Remote control Button
40	^	Remote control Button
41	v	Remote control Button
07	<	Remote control Button
06	>	Remote control Button
44	ENTER	Remote control Button
5B	RETURN	Remote control Button
7E	SIMPLINK	Remote control Button
30	AV MODE	Remote control Button
B0	PLAY	Remote control Button
BA	PAUSE	Remote control Button
B1	STOP	Remote control Button
BD	REC	Remote control Button
8F	REW	Remote control Button
8E	FF	Remote control Button

EXTERNAL CONTROL THROUGH RS-232C

The RS-232C port allows you connect the RS-232C input jack to an external control device (such as a computer or an A/V control system) to control the TV's functions externally.

- Note: RS-232C on this unit is intended to be used with third party RS-232C control hardware and software. The instructions below are provided to help with programming software or to test functionality using telenet software.

RS-232C Setup

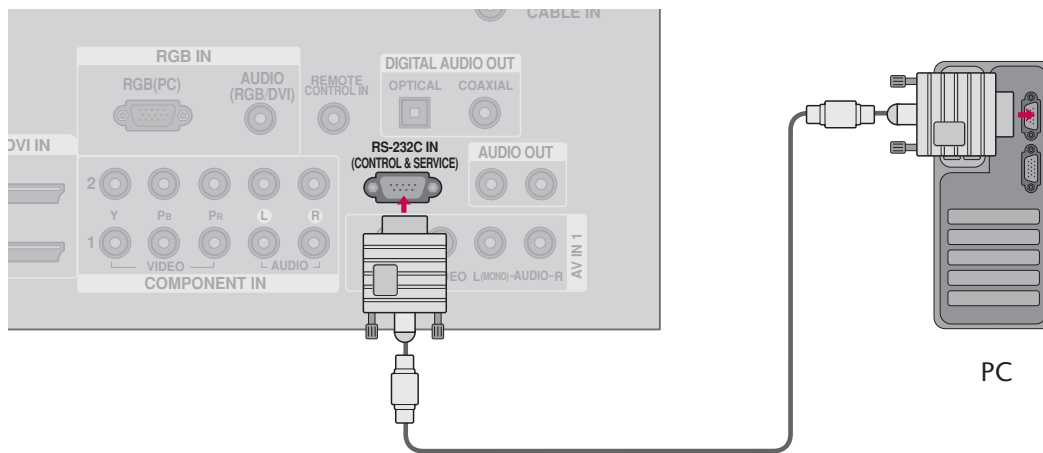

Type of Connector; D-Sub 9-Pin Male

No.	Pin Name
1	No connection
2	RXD (Receive data)
3	TXD (Transmit data)
4	DTR (DTE side ready)
5	GND
6	DSR (DCE side ready)
7	RTS (Ready to send)
8	CTS (Clear to send)
9	No Connection

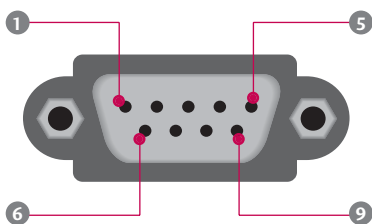

Communication Parameters

- Baud rate : 9600 bps (UART)
- Data length : 8 bits
- Parity : None
- Stop bit : 1 bit
- Communication code : ASCII code
- Use a crossed (reverse) cable.

! NOTE

- ▶ This product has command echo back in the RS-232C Command.

APPENDIX

RS-232C Configurations



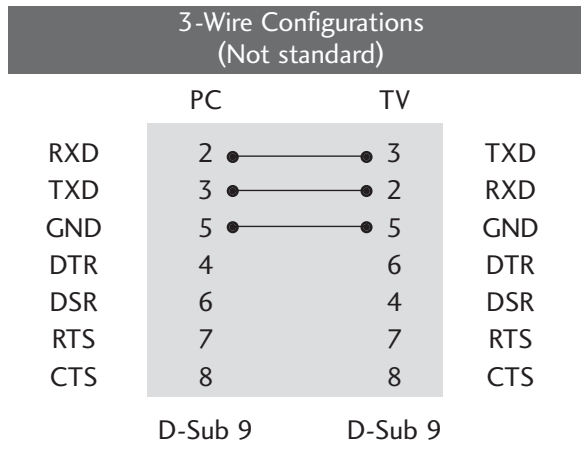
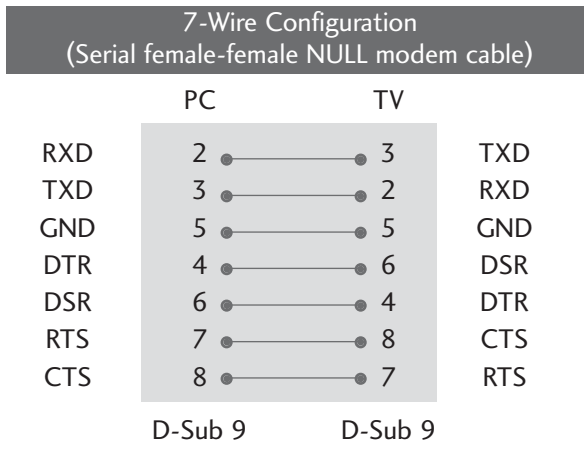



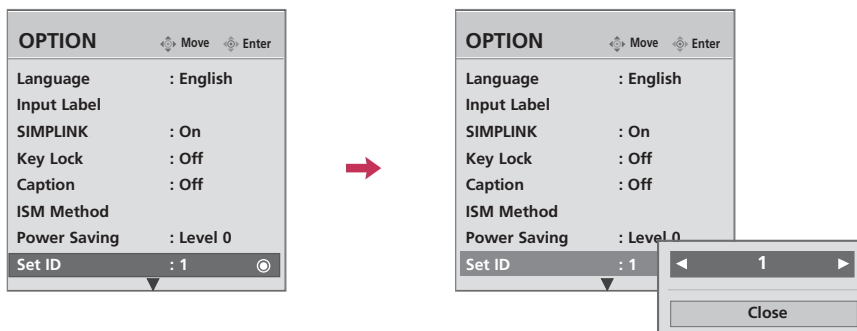

Either cable below can be used.



Set ID

Use this function to specify a TV ID number.
Refer to 'Real Data Mapping1'. ▶ p.125.



- 1   Select **OPTION**.
- 2   Select **Set ID**.
- 3   Choose the desired TV ID number.
The adjustment range of Set ID is 1 ~ 99.
- 4  Return to the previous menu.
-  Return to TV viewing

Command Reference List

	COMMAND1	COMMAND2	DATA (Hexadecimal)		COMMAND1	COMMAND2	DATA (Hexadecimal)
01. Power	k	a	0 ~ 1	15. Treble	k	r	0 ~ 64
02. Input Select	k	b	(▶ p.124)	16. Bass	k	s	0 ~ 64
03. Input Select	x	b	(▶ p.124)	17. Balance	k	t	0 ~ 64
04. Aspect Ratio	k	c	(▶ p.124)	18. Color Temperature	k	u	0 ~ 3
05. Screen Mute	k	d	0 ~ 1	19. Red Adjustment	k	v	0 ~ C8
06. Volume Mute	k	e	0 ~ 1	20. Green Adjustment	k	w	0 ~ C8
07. Volume Control	k	f	0 ~ 64	21. Blue Adjustment	k	\$	0 ~ C8
08. Contrast	k	g	0 ~ 64	22. ISM Method	j	p	(▶ p.126)
09. Brightness	k	h	0 ~ 64	23. Low Power	j	q	0 ~ 1
10. Color	k	i	0 ~ 64	25. Channel Add/Del	m	b	0 ~ 1
11. Tint	k	j	0 ~ 64	26. Key	m	c	(▶ p.127)
12. Sharpness	k	k	0 ~ 64	27. Back Light	m	g	0 ~ 64
13. OSD Select	k	l	0 ~ 1				
14. Remote Control Lock Mode	k	m	0 ~ 1				

Only LCD TV Model

Only Plasma TV Model

	COMMAND1	COMMAND2	DATA0 (Hexadecimal)	DATA1 (Hexadecimal)	DATA2 (Hexadecimal)	DATA3 (Hexadecimal)	DATA4 (Hexadecimal)	DATA5 (Hexadecimal)
24. Channel Tuning	m	a	physical program high	major program low	major low	minor high	minor low	attribute

Transmission / Receiving Protocol

Transmission

[Command1][Command2][][Set ID][][Data][Cr]

[Command 1] : First command to control the set.(j, k, m or x)

[Command 2] : Second command to control the set.

[Set ID] : You can adjust the set ID to choose desired TV ID number in Setup menu. Adjustment range is 1 ~ 99. When selecting Set ID '0', every connected the TV is controlled. Set ID is indicated as decimal (1 ~ 99) on menu and as Hexa decimal (0x0~0x63) on transmission /receiving protocol.

[DATA] : To transmit the command data.

Transmit the 'FF' data to read status of command.

[Cr] : Carriage Return

ASCII code '0x0D'

[] : ASCII code 'space (0x20)'

* In this model, TV will not send the status during the standby mode.

OK Acknowledgement

[Command2][][Set ID][][OK][Data][x]

The TV transmits ACK (acknowledgement) based on this format when receiving normal data. At this time, if the data is data read mode, it indicates present status data. If the data is data write mode, it returns the data of the PC computer.

* In this model, TV will not send the status during the standby mode.

* Data Format

[Command 2] : Use as command.

[Set ID] : Use the small character, if set ID is 10, it will send the '0', 'a'.

[DATA] : Use the small character, if data is 0 x ab, it will send the 'a', 'b'.

[OK] : Use the large character.

Error Acknowledgement

[Command2][][Set ID][][NG][Data][x]

The TV transmits ACK (acknowledgement) based on this format when receiving abnormal data from non-viable functions or communication errors.

Data1: Illegal Code

Data2: Not supported function

Data3: Wait more time

* In this model, TV will not send the status during the standby mode.

* Data Format

[Command 2] : Use as command.

[Set ID] : Use the small character, if set ID is 10, it will send the '0', 'a'.

[DATA] : Use the small character, if data is 0 x ab, it will send the 'a', 'b'.

[NG] : Use the large character

01. Power (Command: k a)

To control Power On/Off of the TV.

Transmission [k][a][] [Set ID][] [Data][Cr]

Data 0: Power Off Data 1: Power On

Acknowledgement [a][] [Set ID][] [OK/NG][Data][x]

* In a like manner, if other functions transmit 'FF' data based on this format, Acknowledgement data feedback presents status about each function.

* Note: In this model, TV will send the Acknowledge after power on processing completion.

There might be a time delay between command and acknowledge.

02. Input Select (Command: k b)

To select input source for the TV.

Transmission [k][b][] [Set ID][] [Data][Cr]

Data 0: DTV Data 1: Analog
Data 2: AV1 Data 3: AV2
Data 4: Component 1 Data 5: Component 2
Data 7: RGB-PC Data 8: HDMI1
Data 9: HDMI2

Acknowledgement [b][] [Set ID][] [OK/NG][Data][x]

* You can select HDMI3 using "command x b".

* If you select input source, we recommend "command x b".

03. Input Select (Command: x b)

To select input source for TV.

Transmission [x][b][] [Set ID][] [Data][Cr]

Data 00: DTV (Antenna) Data 01: DTV (Cable)
Data 10: Analog (Antenna) Data 11: Analog (Cable)
Data 20: AV1 Data 21: AV2
Data 40: Component 1 Data 41: Component 2
Data 60: RGB-PC Data 90: HDMI1
Data 91: HDMI2 Data 92: HDMI3

Acknowledgement [b][] [Set ID][] [OK/NG][Data][x]

04. Aspect Ratio (Command: k c)

To adjust the screen format.

You can also adjust the screen format using the RATIO button on remote control or in the Picture menu.

Transmission [k][c][] [Set ID][] [Data][Cr]

Data 1: 4:3 5: Zoom 2
 2: 16:9 6: Set by program
 4: Zoom 1 9: Just scan
 ⋮
 Reserved

Acknowledgement [c][] [Set ID][] [OK/NG][Data][x]

05. Screen Mute (Command: k d)

To select screen mute on/off.

Transmission [k][d][] [Set ID][] [Data][Cr]

Data 0: Screen mute off (Picture on)

Data 1: Screen mute on (Picture off)

Acknowledgement [d][] [Set ID][] [OK/NG][Data][x]

06. Volume Mute (Command: k e)

To control volume mute on/off.

You can also adjust mute using the MUTE button on remote control.

Transmission [k][e][] [Set ID][] [Data][Cr]

Data 0 : Volume mute on (Volume off)

Data 1 : Volume mute off (Volume on)

Acknowledgement [e][] [Set ID][] [OK/NG][Data][x]

07. Volume Control (Command: k f)

To adjust volume.

You can also adjust volume with the volume buttons on remote control.

Transmission [k][f][] [Set ID][] [Data][Cr]

Data Min : 0 ~ Max : 64 (*transmit by Hexadecimal code)

*Refer to 'Real data mapping 1'. See page 125.

Acknowledgement [f][] [Set ID][] [OK/NG][Data][x]

08. Contrast (Command: k g)

To adjust screen contrast.

You can also adjust contrast in the Picture menu.

Transmission [k][g][] [Set ID][] [Data][Cr]

Data Min : 0 ~ Max : 64 (*transmit by Hexadecimal code)

*Refer to 'Real data mapping 1'. See page 125.

Acknowledgement [g][] [Set ID][] [OK/NG][Data][x]

09. Brightness (Command: k h)

To adjust screen brightness.

You can also adjust brightness in the Picture menu.

Transmission [k][h][] [Set ID][] [Data][Cr]

Data Min : 0 ~ Max : 64 (*transmit by Hexadecimal code)

*Refer to 'Real data mapping 1'. See page 125.

Acknowledgement [h][] [Set ID][] [OK/NG][Data][x]

10. Color (Command: k i)

To adjust screen color.

You can also adjust color in the Picture menu.

Transmission [k][i][][Set ID][][Data][Cr]

Data Min : 0 ~ Max : 64 (*transmit by Hexadecimal code)

*Refer to 'Real data mapping 1' as shown below.

Acknowledgement [i][][Set ID][][OK/NG][Data][x]

11. Tint (Command: k j)

To adjust screen tint.

You can also adjust tint in the Picture menu.

Transmission [k][j][][Set ID][][Data][Cr]

Data Red: 0 ~ Green: 64 (*transmit by Hexadecimal code)

*Refer to 'Real data mapping 1' as shown below.

Acknowledgement [j][][Set ID][][OK/NG][Data][x]

12. Sharpness (Command: k k)

To adjust screen sharpness.

You can also adjust sharpness in the Picture menu.

Transmission [k][k][][Set ID][][Data][Cr]

Data Min : 0 ~ Max : 64 (*transmit by Hexadecimal code)

*Refer to 'Real data mapping 1' as shown below.

Acknowledgement [k][][Set ID][][OK/NG][Data][x]

13. OSD Select (Command: k l)

To select OSD (On Screen Display) on/off.

Transmission [k][l][][Set ID][][Data][Cr]

Data 0: OSD off Data 1: OSD on

Acknowledgement [l][][Set ID][][OK/NG][Data][x]

14. Remote Control Lock Mode (Command: k m)

To lock the remote control and the front panel controls on the set.

Transmission [k][m][][Set ID][][Data][Cr]

Data 0: Lock off Data 1: Lock on

Acknowledgement [m][][Set ID][][OK/NG][Data][x]

If you're not using the remote control and front panel controls on the TV, use this mode. When main power is on/off, remote control lock is released.

15. Treble (Command: k r)

To adjust treble.

You can also adjust treble in the Audio menu.

Transmission [k][r][][Set ID][][Data][Cr]

Data Min: 0 ~ Max: 64 (*transmit by Hexadecimal code)

*Refer to 'Real data mapping 1' as shown.

Acknowledgement [r][][Set ID][][OK/NG][Data][x]

16. Bass (Command: k s)

To adjust bass.

You can also adjust bass in the Audio menu.

Transmission [k][s][][Set ID][][Data][Cr]

Data Min: 0 ~ Max: 64 (*transmit by Hexadecimal code)

*Refer to 'Real data mapping 1' as shown below.

Acknowledgement [s][][Set ID][][OK/NG][Data][x]

17. Balance (Command: k t)

To adjust balance.

You can also adjust balance in the Audio menu.

Transmission [k][t][][Set ID][][Data][Cr]

Data Min: 0 ~ Max: 64 (*transmit by Hexadecimal code)

*Refer to 'Real data mapping 1' as shown below.

Acknowledgement [t][][Set ID][][OK/NG][Data][x]

18. Color Temperature (Command: k u)

To adjust color temperature.

You can also adjust color temperature in the Picture menu.

Transmission [k][u][][Set ID][][Data][Cr]

Data 0: Medium 1: Cool 2: Warm 3: User

Acknowledgement [u][][Set ID][][OK/NG][Data][x]

19. Red Adjustment (Command: k v)

To adjust red in color temperature

Transmission [k][v][][Set ID][][Data][Cr]

Data Min: 0 ~ Max: C8

*Refer to 'Real data mapping 2' as shown below.

Acknowledgement [v][][Set ID][][OK/NG][Data][x]

20. Green Adjustment (Command: k w)

To adjust green in color temperature.

Transmission [k][w][][Set ID][][Data][Cr]

Data Min: 0 ~ Max: C8

*Refer to 'Real data mapping 2' as shown below.

Acknowledgement [w][][Set ID][][OK/NG][Data][x]

*Real data mapping 1	*Real data mapping 2
0 : Step 0	0 : -20
⋮	5 : -19
A : Step 10 (SET ID 10)	A : -18
⋮	⋮
F : Step 15 (SET ID 15)	5F: -1
10 : Step 16 (SET ID 16)	64: 0
⋮	69: +1
63 : Step 99 (SET ID 99)	⋮
64 : Step 100	C3 : +19
	C8 : +20

APPENDIX

21. Blue Adjustment (Command: k \$)

To adjust blue in color temperature.

Transmission [k][\$][][Set ID][][Data][Cr]

Data Min: 0 ~ Max: C8

*Refer to 'Real data mapping 2': See page 125.

Acknowledgement [\$][][Set ID][][OK/NG][Data][x]

22. ISM Method (Command2: j p)

(Only Plasma TV model)

To avoid having a fixed image remain on screen.

Transmission [j][p][][Set ID][][Data][Cr]

Data 1: Inversion 2: Orbiter

4: White Wash 8: Normal

Acknowledgement [p][][Set ID][][OK/NG][Data][x]

23. Low Power (Command2: j q)

(Only Plasma TV model)

To control the low power function on/off.

Transmission [j][q][][Set ID][][Data][Cr]

Data 0: Low Power off

1: Low Power on

Acknowledgement [q][][Set ID][][OK/NG][Data][x]

24. Channel Tuning (Command: m a)

To tune channel to following physical/major/minor number.

Transmission [m][a][][Set ID][][Data0][][Data1][][Data2][][Data3][][Data4][][Data5][Cr]

Digital channels have a Physical, Major, and Minor channel number. The Physical number is the actual digital channel number, the Major is the number that the channel should be mapped to, and the Minor is the sub-channel. Since the ATSC tuner automatically maps the channel to the Major number, the Physical number is not required when sending a command.

Data 0: Physical Channel Number

NTSC air: 02~45, NTSC cable: 01, 0E~7D

ATSC air: 01~45, ATSC cable: 01~87

Data1 & 2: Major Channel Number

Data1: High byte Data2: Low byte

Two bytes are available for the Major and Minor, normally only the second byte is used.

Data3 & 4: Minor Channel Number

Not needed for NTSC.

Data5:

7	Main/Sub Picture	6	Two/One Part Channel	5	Using Physical Channel	4	Reserved	3	2	1	0	Step
0	Main	0	Two	0	Use	x		0	0	0	0	NTSC Air
1	Sub	1	One	1	No Use	x		0	0	0	1	NTSC Cable
						x		0	0	1	0	ATSC Air
						x		0	0	1	1	ATSC Cable_std
						x		0	1	0	0	ATSC Cable_hrc
						x		0	1	0	1	ATSC Cable_irc
						x		0	1	1	0	ATSC cable_auto
						x		0	1	1	1	Reserved
						x	x	x	x	x	x	...
						x	1	1	1	1	1	Reserved

The table above lists the binary code which must be converted to Hexadecimal before sending. For example: The binary code to tune the sub source to an NTSC cable channel is "1000 0001", which translates to "81" in Hex.

- * 7th bit : For which source do you want to change the channel.
- * 6th bit: Use a two part or one part channel. Most cases just use 0 since it's ignored when using NTSC.
- * 5th bit: Use 0 with NTSC since it can only use the physical channel number. Normally use 1 for ATSC since most times it doesn't matter what the physical number is.
- * 4th bit: Set to 0.
- * 3-0 bits: Choose signal type.

* Tune Command Examples:

1. Tune to the analog (NTSC) cable channel 35.

Data 0 = Physical of 35 = 23
 Data 1 & 2 = No Major = 00 00
 Data 3 & 4 = No Minor = 00 00
 Data 5 = 0000 0001 in binary = 01
 Total = ma 00 23 00 00 00 00 01

2. Tune to the digital (ATSC) local channel 30-3.

Data 0 = Don't know Physical = 00
 Data 1 & 2 = Major is 30 = 00 1E
 Data 3 & 4 = Minor is 3 = 00 03
 Data 5 = 0010 0010 in binary = 22
 Total = ma 00 00 00 1E 00 03 22

```
Acknowledgement[a][ ][Set ID][ ][OK][Data0][Data1]
[Data2][Data3][Data4][x][a][ ][Set ID]
[ ][NG][Data0][x]
```

25. Channel Add/Del (Command: m b)

To add and delete the channels

```
Transmission [m][b][ ][Set ID][ ][Data][Cr]
```

Data 0: Channel Delete Data 1: Channel Add

```
Acknowledgement [b][ ][Set ID][ ][OK/NG][Data][x]
```

26. Key (Command: m c)

To send IR remote key code.

```
Transmission [m][c][ ][Set ID][ ][Data][Cr]
```

Data Key code: Refer to page 120.

```
Acknowledgement [c][ ][Set ID][ ][OK/NG][Data][x]
```

27. Back Light (Command: m g)

(Only LCD TV model)

To adjust screen back light.

```
Transmission [m][g][ ][Set ID][ ][Data][Cr]
```

Data Min:0 ~ Max:64 (*transmit by Hexadecimal code)

*Refer to 'Real data mapping 1'. See page 125.

```
Acknowledgement [g][ ][Set ID][ ][OK/NG][Data][x]
```

LG Electronics Inc.



Regulatory information

Regulatory information

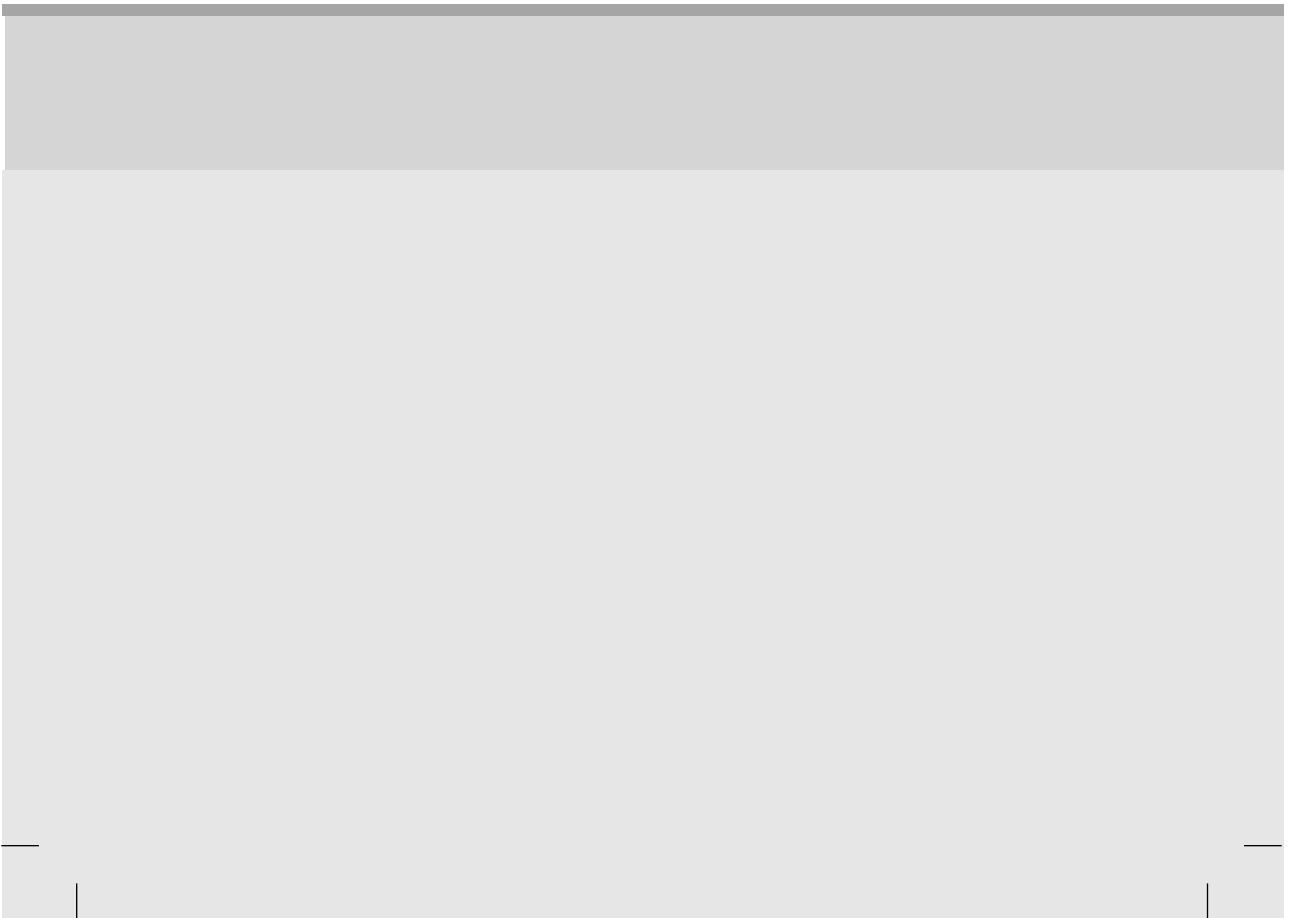

■■■ Regulatory Information cont.

:: FCC Compliance Statement

This equipment has been tested and found to comply within the limits of a Class B digital device pursuant to Part 15 of the FCC Rules. These limits are designed to provide reasonable protection against harmful interference in a residential installation.

This equipment generates, uses, and can radiate radio frequency energy and if not installed and used in accordance with the instructions, may cause harmful interference to radio communications. However, there is no guarantee that interference will not occur in a particular installation.

If this equipment does cause harmful interference to radio or television reception (which can be determined by turning the equipment on and off), the user is encouraged to try to correct the interference by using one or more of the following measures:

- Reorient or relocate the receiving antenna.
- Increase the separation between the equipment and the receiver.
- Connect the equipment into an outlet on a circuit different from that to which the receiver is connected.
- Consult the dealer or an experienced radio/TV technician for help.

Caution: Changes or modifications not expressly approved by the party responsible for compliance could void the user's (or your) authority to operate the equipment. Only peripherals (digital input/output devices, terminals, printers, etc.) certified to comply with the Class B limits may be attached to this monitor. Operation with non-certified peripherals is likely to result in interference to radio and TV reception. Only shielded signal cables may be used with this System.

NOTICE

The regulations are applied only to the products with the ID LABEL indicating specific requirements.

:: Canadian DOC Notice

This Class B digital apparatus meets all requirements of the Canadian Interference-Causing Equipment Regulations. Cet appareil numérique de la classe B

respecte toutes les exigences du Règlement sur le matériel brouilleur du Canada.

NOTICE

The regulations are applied only to the products with the ID LABEL indicating specific requirements.

:: CE Conformity Notice (for Europe)

Products with the "CE" Marking comply with the EMC Directive(89/336/EEC) and LOW VOLTAGE Directive (73/23/EEC) issued by the Commission of the European Community.

Compliance with these directives implies conformity to the following European Norms :

- EN 55022 ; Radio Frequency Interference
- EN 55024 ; Electromagnetic Immunity
- EN 61000-3-2 ; Power Line Harmonics
- EN 61000-3-3 ; Voltage Fluctuations
- EN 60950 ; Product Safety

NOTICE

The regulations are applied only to the products with the ID LABEL indicating specific requirements.

:: Low Radiation Compliance (MPR II)

This monitor meets one of the strictest guidelines available today for low radiation emissions, offering the user extra shielding and an antistatic screen coating. These guidelines, set forth by a government agency in Sweden, limit the amount of emission allowed in the Extremely Low Frequency (ELF) and Very Low Frequency (VLF) electromagnetic range.

:: TCO95 (TCO95 applied model only)



Congratulations!

You have just purchased a TCO95 approved and labelled product! Your choice has provided you with a product developed for professional use. Your purchase has also contributed to reducing the burden on the environment and to the further development of environmentally-adapted electronic products.

■■■ Regulatory Information cont.

Why do we have environmentally labelled computers?

In many countries, environmental labelling has become an established method for encouraging the adaptation of goods and services to the environment. The main problem as far as computers and other electronic equipment are concerned is that environmentally harmful substances are used both in the products and during their manufacture. Since it has not been possible so far for the majority of electronic equipment to be recycled in a satisfactory way, most of these potentially damaging substances sooner or later enter Nature.

There are also other characteristics of a computer, such as energy consumption levels, that are important from both the working and natural environment viewpoints. Since all types of conventional electricity generation have a negative effect on the environment (acidic- and climatic-influencing emissions, radioactive waste, etc.), it is vital to conserve energy. Electronic equipment in offices consumes an enormous amount of energy, since it is often routinely left running continuously.

What does the environmental labelling involve?

This product meets the requirements for the TCO'95 scheme, which provides for international environmental labelling of personal computers. The labelling scheme was developed as a joint effort by the TCO (The Swedish Confederation of Professional Employees), Naturkyddsforeningen (The Swedish Society for Nature Conservation), and NUTEK (The National Board for Industrial and Technical Development in Sweden), and SEMKO AB (an international certification agency).

The requirements cover a wide range of issues: environment, ergonomics, usability, emission of electrical and magnetic fields, energy consumption and electrical and fire safety.

The environmental demands concern, among other things, restriction on the presence and use of heavy metals, brominated and chlorinated flame retardants, CFCs (freons), and chlorinated solvents. The product must be prepared for recycling, and the manufacturer is obliged to have an environmental plan, which must be adhered to in each country where the company implements its operational policy.

The energy requirements include a demand that the

computer and/or display, after a certain period of inactivity, shall reduce its power consumption to a lower level, in one or more stages. The length of time to reactivate the computer shall be reasonable for the user.

Labelled products must meet strict environmental demands, for example, in respect of the reduction of electric and magnetic fields, along with physical and visual ergonomics and good usability.

The following is a brief summary of the environmental requirements met by this product. The complete environmental criteria document may be ordered from:

TCO Development Unit
Linnegatan 14, S-11494 Stockholm, Sweden
FAX +46-8 782 92 07
E-mail (Internet): development@tco.se

Current information regarding TCO'95 approved and labelled products may also be obtained on the Internet using the address: <http://www.tco-info.com/>

TCO'95 is a co-operative project between:



Naturkydds
foreningen



NUTEK

SEMKO

Närings- och teknikutvecklingsverket

Environmental requirements

Brominated flame retardants are present in printed circuit boards, cabling, casings, and housings, and are added to delay the spread of fire. Up to 30% of the plastic in a computer casing can consist of flame-retardant substances. These are related to another group of environmental toxins, PCBs, and are suspected of giving rise to similar harm, including reproductive damage in fish-eating birds and mammals. Flame retardants have been found in human blood, and researchers fear that they can disturb fetus development.

Bio-accumulative¹ TCO'95 demands require that plastic components weighing more than 25 grams must not contain flame retardants with organically bound chlorine or bromine.

Lead can be found in picture tubes, display screens, solder, and capacitors. Lead damages the nervous system and in higher doses causes lead poisoning. The

■■■ Regulatory Information cont.

relevant bio-accumulative TCO'95 requirement permits the inclusion of lead, as no replacement has yet been developed.

Cadmium is present in rechargeable batteries and in the color-generating layers of certain computer displays. Cadmium damages the nervous system and is toxic in high doses. The relevant bio-accumulative TCO'95 requirement states that batteries may not contain more than 25 ppm (parts per million) of cadmium. The color-generating layers of display screens must not contain any cadmium.

Mercury is sometimes found in batteries, relays and switches. Mercury damages the nervous system and is toxic in high doses. The relevant bio-accumulative TCO'95 requirement states that batteries may not contain more than 25 ppm of mercury and that no mercury is present in any of the electrical or electronic components concerned with the display unit.

CFCs (freons) are sometimes used for washing printed circuit boards and in the manufacture of expanded foam for packaging. CFCs break down ozone and thereby damage the ozone layer in the atmosphere, causing increased reception on Earth of ultra-violet light with consequent increased risks of skin cancer (malignant melanoma). The relevant TCO'95 requirement: Neither CFCs nor HCFCs may be used during the manufacture of the product or its packaging.

¹ Bio-accumulative means that the substance accumulates within living organisms.

Shipping Package

The packaging material can be recycled, or you can save it to return the monitor to a service center for repair or disposal.

CFC Compounds in Distribution Packaging

Cushioning material used for shipping finished monitors are not manufactured with nor do they contain any CFC compounds.

Design for Disassembly/Recycling

These monitors have been designed for easy end-of-life disassembly and recycling. Fasteners are generally of the same type for efficient disassembly. Components made of different materials can be easily separated and plastics have been identified using international symbols to aid in recycling.

Monitor Disposal

WARNING

If you need to dispose of a monitor, ask a qualified service representative for the proper procedure. Improper disposal could result in personal injury from implosion.

:: **TCO'99** (TCO'99 applied model only)



Congratulations!

You have just purchased a TCO'99 approved and labelled product! Your choice has provided you with a product developed for professional use. Your purchase has also contributed to reducing the burden on the environment and also to the further development of environmentally adapted electronics products.

Why do we have environmentally labelled computers?

In many countries, environmental labelling has become an established method for encouraging the adaptation of goods and services to the environment. With the growing manufacture and usage of electronic equipment throughout the world, there is a recognized concern for the materials and substances used by electronic products with regards to their eventual recycling and disposal. By proper selection of these materials and substances, the impact on the environment can be minimized.

There are also other characteristics of a computer, such as energy consumption levels, that are important from the viewpoints of both the work (internal) and natural (external) environments. Electronic equipment in offices is often left running continuously, resulting in unnecessary consumption of large amounts of energy and additional power generation. From the standpoint of carbon dioxide emissions alone, it is vital to save energy.

What does labelling involve?

The product meets the requirements for the TCO'99 scheme which provides for international and environmental labelling of personal computers and/or displays.

The labelling scheme was developed as a joint effort by the TCO (The Swedish Confederation of Professional Employees), Svenska Naturskyddsforeningen (The Swedish Society for Nature Conservation) and Statens Energimyndighet (The Swedish National Energy Administration).

■ ■ ■ Regulatory Information cont.

Approval requirements cover a wide range of issues: ecology, ergonomics, emission of electrical and magnetical fields, energy consumption and electrical safety.

Ecological criteria impose restrictions on the presence and use of heavy metals, brominated and chlorinated flame retardants, and other substances. The product must be prepared for recycling and the manufacturing site(s) shall be certified according to ISO14001 or EMAS registered.

Energy requirements include a demand that the system unit and/or display, after a certain period of inactivity, shall reduce its power consumption to a lower level in one or more stages. The length of time to reactivate the system unit shall be reasonable for the user.

Labelled products must meet strict environmental demands, for example, in respect of the reduction of electrical and magnetical fields as well as work load and visual ergonomics.

Below you will find a brief summary of the ecological requirements met by this product. The complete ecological criteria document can be found at TCO Development's website <http://www.tcodevelopment.com> or may be ordered from:

TCO Development
SE-114 94 STOCKHOLM, Sweden
Fax: +46 8 782 92 07
Email : development@tco.se
Information regarding TCO'99 approved and labelled products may also be obtained at <http://www.tcodevelopment.com>

Ecological requirements

Flame retardants

Flame retardants may be present in printed wiring board laminates, cables, and housings. Their purpose is to prevent, or at least to delay the spread of fire. Up to 30% by weight of the plastic in a computer casing can consist of flame retardant substances. Many flame retardants contain bromine or chlorine, and these flame retardants are chemically related to PCBs (polychlorinated biphenyls). Both the flame retardants containing bromine or chlorine and the PCBs are suspected of giving rise to health effects, including reproductive damage in fish-eating birds and mammals, due to the bio-accumulative* processes when not disposed of in accordance with strict standards for disposal.

TCO'99 requires that plastic components weighing more than 25 grams shall not contain flame retardants with organically bound bromine or chlorine. Flame retardants are allowed in the printed wiring board laminates due to the lack of commercially available alternatives.

Cadmium**

Cadmium is present in rechargeable batteries and in the colour-generating layers of certain computer displays. TCO'99 requires that batteries, the colour-generating layers of display screens, and the electrical or electronics components shall not contain any cadmium.

Mercury**

Mercury is sometimes found in batteries, relays and switches. TCO'99 requires that batteries shall not contain any mercury. It also demands that mercury is not present in any of the electrical or electronics components associated with the labelled unit. There is however one exception. Mercury is, for the time being, permitted in the back light system of flat panel monitors as there today is no commercially available alternative. TCO aims on removing this exception when a mercury free alternative is available.

Lead**

Lead can be found in picture tubes, display screens, solders and capacitors. TCO'99 permits the use of lead due to the lack of commercially available alternatives, but in future requirements TCO Development aims at restricting the use of lead.

* Bio-accumulative is defined as substances which accumulate in living organisms.

**Lead, Cadmium and Mercury are heavy metals which are bio-accumulative.

■■■ Regulatory Information cont.

:: **TCO'03** (TCO'03 applied model only)



Congratulations!

The display you have just purchased carries the TCO'03 Displays label.

This means that your display is designed, manufactured and tested according to some of the strictest quality and environmental requirements in the world. This makes for a high performance product, designed with the user in focus that also minimizes the impact on our natural environment. Some of the features of the TCO'03 Display requirements:

Ergonomics

- Good visual ergonomics and image quality in order to improve the working environment for the user and to reduce sight and strain problems. Important parameters are luminance, contrast, resolution, reflectance, colour rendition and image stability.

Energy

- Energy-saving mode after a certain time – beneficial both for the user and the environment
- Electrical safety

Emissions

- Electromagnetic fields
- Noise emissions

Ecology

- The product must be prepared for recycling and the manufacturer must have a certified environmental management system such as EMAS or ISO 14 001
- Restrictions on
 - chlorinated and brominated flame retardants and polymers
 - heavy metals such as cadmium, mercury and lead.

The requirements included in this label have been developed by TCO Development in co-operation with scientists, experts, users as well as manufacturers all over the world. Since the end of the 1980s TCO has been involved in influencing the development of IT equipment in a more user-friendly direction. Our labelling system started

with displays in 1992 and is now requested by users and IT-manufacturers all over the world.

For more information, please visit
www.tcodevelopment.com

English

Information for Environmental Preservation

LGE. announced the 'LG Declaration for a Cleaner Environment' in 1994, and this ideal has served as a guiding managerial principle ever since. The Declaration is a foundation that has allowed us to undertake environmentally friendly activities in careful consideration of economic, environmental, and social aspects.

We promote activities for environmental preservation, and we specifically develop our products to embrace the concept of environment-friendly.

We minimize the hazardous materials contained in our products. For example, there is no cadmium to be found in our monitors.

Information for recycling

This monitor may contain parts which could be hazardous to the environment. It is important that this monitor be recycled after use.

LGE. handles all waste monitors through an environmentally acceptable recycling method. There are several take-back and recycling systems currently in operation worldwide. Many parts will be reused and recycled, while harmful substances and heavy metals are treated by an environmentally friendly method.

If you want to find out more information about our recycling program, please contact your local LG vendor or a corporate representative of LG.

We set our vision and policies on a cleaner world by selecting the issue of the global environment as a task for corporate improvement. Please visit our website for more information about our 'green' policies.

http://www.lge.com/experience/social_commitment/environment.jsp

■■■ Regulatory Information cont.

■ ■ ■ Deutsch

Informationen zur Erhaltung der Umwelt

Im Jahr 1994 verkündete LGE die 'LG Declaration for a Cleaner Environment' (LG Erklärung für eine sauberere Umwelt). Seitdem dient dieses Ideal als führendes Prinzip des Unternehmens. Diese Erklärung war die Basis für die Durchführung von

umweltfreundlichen Aktivitäten, wobei wirtschaftliche, umweltbezogene und soziale Aspekte in die Überlegungen mit einbezogen wurden.

Wir fördern Aktivitäten zum Schutz der Umwelt und die Entwicklung unserer Produkte ist darauf ausgerichtet, unserem Konzept bezüglich Umweltfreundlichkeit gerecht zu werden.

Wir sind darauf bedacht, den Anteil der in unseren Produkten enthaltenen schädlichen Materialien zu minimieren. So ist in unseren Monitoren beispielsweise kein Kadmium zu finden.

Informationen zum Thema Recycling

Dieser Monitor enthält Teile, die umweltschädlich sein können. Es ist unbedingt erforderlich, dass der Monitor recycelt wird, nachdem er außer Dienst gestellt wurde.

Bei LGE werden alle ausrangierten Monitore in einem unter umweltbezogenen Aspekten geeigneten Verfahren recycelt. Augenblicklich sind weltweit mehrere Rücknahme- und Recyclingsysteme im Einsatz. Viele Teile werden wieder verwendet und recycelt. Schädliche Substanzen und Schwermetalle werden durch umweltverträgliche Verfahren behandelt.

Falls Sie mehr über unser Recyclingprogramm erfahren möchten, wenden Sie sich bitte an Ihren lokalen LG-Händler oder einen Unternehmensvertreter von LG.

Wir richten unsere Firmenpolitik auf eine sauberere Umwelt hin aus, indem wir umweltspezifische Aspekte als wichtigen Punkt in die Weiterentwicklung unseres Unternehmens einfließen lassen. Zusätzliche Informationen über unsere 'grüne' Firmenpolitik erhalten Sie auf unserer Website.

http://www.lge.com/experience/social_commitment/environment.jsp

■ ■ ■ Français

Information sur la protection de l'environnement

LGE a publié sa 'Déclaration en faveur d'un

environnement plus propre' en 1994 et celle-ci est restée, depuis lors, un principe directeur de notre entreprise. Cette déclaration a servi de base à notre réflexion et nous a permis de prendre en compte à la fois les aspects économiques et sociaux de nos activités, tout en respectant l'environnement.

Nous encourageons les activités en faveur de la préservation de l'environnement et c'est dans cet esprit que nous développons nos produits : nous réduisons au minimum les matières dangereuses qui entrent dans leur composition et l'on ne trouve pas de cadmium, par exemple, dans nos moniteurs.

Information sur le recyclage

Ce moniteur peut contenir des composants qui présentent un risque pour l'environnement. Il est donc important que celui-ci soit recyclé après usage.

LGE traite les moniteurs en fin de cycle conformément à une méthode de recyclage respectueuse de l'environnement. Nous reprenons nos produits et les recyclons dans plusieurs sites répartis dans le monde entier. De nombreux composants sont réutilisés et recyclés, et les matières dangereuses, ainsi que les métaux lourds, sont traités selon un procédé écologique.

Si vous souhaitez plus de renseignements sur notre programme de recyclage, veuillez contacter votre revendeur LG ou un l'un de nos représentants.

Nous voulons agir pour un monde plus propre et croyons au rôle de notre entreprise dans l'amélioration de l'environnement. Pour plus de renseignements sur notre politique "verte", rendez visite à notre site :

http://www.lge.com/experience/social_commitment/environment.jsp

■ ■ ■ Italiano

Informazioni per la tutela dell'ambiente

La LGE ha annunciato nel 1994 la cosiddetta 'LG Declaration for a Cleaner Environment' (Dichiarazione di LG a favore di un ambiente più pulito), un ideale che da allora funge da principio ispiratore della gestione aziendale. La dichiarazione rappresenta il fondamento che consente di intraprendere attività a favore dell'ambiente tenendo conto degli aspetti economici, ambientali e sociali.

■■■ Regulatory Information cont.

Noi della LG, promuoviamo attività a favore della tutela dell'ambiente sviluppando appositamente i nostri prodotti per cogliere il concetto del rispetto dell'ambiente riducendo i materiali dannosi presenti nei nostri prodotti. Ad esempio nei nostri monitor non è presente il cadmio.

Informazioni per il riciclaggio

Il monitor può presentare componenti che potrebbero risultare eventualmente dannosi per l'ambiente. È importante che il monitor sia riciclato al termine del suo utilizzo.

La LGE. gestisce tutti i monitor di rifiuto con un metodo di riciclaggio soddisfacente dal punto di vista ambientale. In tutto il mondo sono attualmente in funzione numerosi sistemi di riciclaggio e recupero. I diversi componenti sono riutilizzati e riciclati, mentre le sostanze dannose e i metalli pesanti vengono trattati con un metodo rispettoso dell'ambiente.

Se si desiderano maggiori informazioni in merito al programma di riciclaggio, è consigliabile rivolgersi al proprio rivenditore LG o ad un rappresentante aziendale della LG.

Noi della LG impostiamo la nostra visione e le nostre politiche a favore di un mondo più pulito ponendo la questione dell'ambiente dal punto di vista globale come una mansione rivolta al miglioramento della nostra azienda. Vi invitiamo a visitare il nostro sito internet per ulteriori informazioni sulla nostra politica "verde".

http://www.lge.com/experience/social_commitment/enviro ment.jsp

■■■ Español

Información para la conservación medioambiental

LGE. presentó la 'Declaración para un entorno más limpio de LG' en 1994 y este ideal ha servido para guiar nuestros principios empresariales desde entonces. La Declaración es la base que nos ha permitido llevar a cabo tareas que respetan el medio ambiente siempre teniendo en cuenta aspectos sociales, económicos y medioambientales.

Promocionamos actividades orientadas a la conservación del medio ambiente y desarrollamos nuestros productos específicamente para que se ajusten a la filosofía que protege el entorno.

Reducimos al máximo el uso de materiales de riesgo en nuestros productos. Un ejemplo de ello es la ausencia total de cadmio en nuestros monitores.

Información para el reciclaje

Este monitor puede contener piezas que entrañen riesgos medioambientales. Es importante reciclar este monitor después de su utilización.

LGE. trata todos los monitores usados siguiendo un método de reciclaje que no daña al entorno. Contamos con diversos sistemas de recuperación y reciclaje que funcionan a nivel mundial en la actualidad. Es posible reciclar y reutilizar muchas de las piezas, mientras que las sustancias dañinas y los metales pesados se tratan siguiendo un método que no perjudique al medio ambiente. Si desea obtener más información acerca del programa de reciclaje, póngase en contacto con su proveedor local de LG o con un representante empresarial de nuestra marca.

Basamos nuestra visión y nuestras políticas en un mundo más limpio y para ellos optamos por un entorno global como tarea principal de nuestra evolución como empresa. Visite nuestra página Web para obtener más información sobre nuestras políticas ecológicas.

http://www.lge.com/experience/social_commitment/enviro ment.jsp

■■■ Português

Informações relacionadas à preservação ambiental

A LGE. anunciou a 'LG Declaration for a Cleaner Environment' (Declaração da LG para um ambiente mais limpo) em 1994 e esse ideal tem servido desde então como um princípio administrativo de orientação. A Declaração é a base que nos tem permitido realizar atividades favoráveis ao ambiente com consideração atenta aos aspectos econômicos, ambientais e sociais.

Promovemos atividades de preservação ambiental e desenvolvemos nossos produtos para englobar especificamente o conceito de favorável ao ambiente.

Reduzimos os materiais perigosos contidos em nossos produtos. Por exemplo, não há cádmio em nossos monitores.

■■■ Regulatory Information cont.

Informações relacionadas à reciclagem

Este monitor pode conter peças que podem representar riscos ao ambiente. É importante que ele seja reciclado após o uso.

A LGE cuida de todos os monitores descartados através de um método de reciclagem agradável ao ambiente. Há vários sistemas de devolução e reciclagem atualmente em operação no mundo. Muitas peças serão reutilizadas e recicladas e as substâncias nocivas e os metais pesados passarão por tratamento através de um método favorável ao ambiente.

Para obter mais informações sobre nosso programa de reciclagem, entre em contato com seu fornecedor LG local ou com um representante corporativo da LG.

Definimos nossa visão e nossas políticas relacionadas a um mundo mais limpo selecionando a questão do ambiente global como uma tarefa de aprimoramento corporativo. Visite nosso site para obter mais informações sobre nossas políticas de meio ambiente.

http://www.lge.com/experience/social_commitment/environment.jsp

■ ■ ■ Nederlands

Informatie met betrekking tot het behoud van het milieu

LGE publiceerde in 1994 de 'LG Declaration for a Cleaner Environment' (de LG-verklaring met betrekking tot een schoner milieu). Deze verklaring en het ideaal van een schoner milieu fungeren sindsdien als een bestuurlijke leidraad voor onze onderneming. Op basis van deze verklaring ontplooiën wij milieuvriendelijke activiteiten, waarbij er zowel met sociale en economische aspecten, als met milieuaspecten zorgvuldig rekening wordt gehouden.

Wij ondersteunen activiteiten die zijn gericht op het behoud van het milieu en wij houden bij het ontwikkelen onze producten specifiek rekening met de milieuvriendelijkheid van onze producten.

Wij minimaliseren het gebruik van schadelijke stoffen in onze producten. Er wordt bijvoorbeeld geen cadmium verwerkt in onze monitoren.

Informatie met betrekking tot recycling

Deze monitor bevat materialen die schadelijk zouden kunnen zijn voor het milieu. Het is belangrijk dat deze

monitor aan het einde van zijn levensduur wordt gerecycled.

LGE verwerkt alle afvalmonitoren via een milieuvriendelijke recyclingmethode. Hiervoor worden er momenteel wereldwijd verscheidene inname- en recyclingsystemen gehanteerd. Een groot aantal onderdelen wordt opnieuw gebruikt en gerecycled, waarbij schadelijke stoffen en zware metalen volgens een milieuvriendelijke methode worden verwerkt.

Voor meer informatie over ons recyclingprogramma kunt u contact opnemen met uw plaatselijke LG-vertegenwoordiger of een LG-vestiging.

Onze visie en ons beleid met betrekking tot een schonere wereld vloeien voort uit het feit dat wij het milieu hebben aangemerkt als een onderwerp dat speciale aandacht verdient binnen onze onderneming. Bezoek onze website voor meer informatie over ons 'groene' beleid.

http://www.lge.com/experience/social_commitment/environment.jsp

■ ■ ■ Russian

Информация по охране окружающей среды

В 1994 году корпорация LGE опубликовала 'Декларацию LG по охране окружающей среды', которая с тех пор служит основным принципом управления. На основе этой декларации мы смогли предпринять действия, обеспечивающие безопасность окружающей среды, уделяя при этом должное внимание экономическим, экологическим и социальным аспектам.

Мы стимулируем деятельность по охране окружающей среды, уделяя особое внимание разработке нашей продукции в соответствии с концепцией экологической безопасности.

Мы сводим к минимуму содержание опасных веществ в нашей продукции. Например, в наших мониторах вы не найдете кадмия.

Информация по утилизации отходов

Этот монитор может содержать компоненты, которые могут нанести ущерб окружающей среде.

Необходимо утилизировать монитор после использования.

■■■ Regulatory Information cont.

Корпорация LGE перерабатывает все бракованные мониторы с помощью экологически приемлемого метода утилизации отходов. По всему миру действуют системы утилизации отходов и возврата использованной продукции. Многие компоненты будут вторично использованы и утилизированы, в то время как вредные вещества и тяжелые металлы будут обработаны с помощью экологически приемлемого метода.
 За более подробной информацией по нашей программе утилизации отходов обращайтесь к местному поставщику или представителю корпорации LG.

Мы ориентируемся на обеспечение экологической безопасности, ставя себе целью глобальную защиту окружающей среды. Дополнительную информацию о нашей политике по охране окружающей среды вы можете найти на нашем сайте:
http://www.lge.com/experience/social_commitment/environment.jsp

한국어

환경 보존 정보

LG 전자는 1994년 'LG 환경 선언문'을 발표한 후 현재까지 이를 기업 경영의 이념으로 삼아왔습니다. 이 선언문을 바탕으로 LG 전자는 모든 경영 활동에서 경제성뿐만 아니라 환경성 및 사회성을 주요 의사 결정의 기준으로 삼음으로써 지속적으로 환경 친화적인 경영을 전개하고 있습니다.

본사는 보다 활발한 환경 보존 활동과 더불어 환경 친화적 제품 개발에 주력해 왔습니다.
 또한 제품에 포함되는 환경 위해 요소를 최소화하는 데에도 노력을 기울이지 않고 있습니다. LG 전자 모니터의 경우 카드뮴을 전혀 사용하지 않는 것에서도 이러한 노력을 알 수 있습니다.

재활용 정보

본 모니터에는 환경에 위해를 주는 부품이 포함되어 있을 수도 있습니다. 따라서 사용이 끝난 모니터는 재활용하는 것이 좋습니다.

폐모니터는 모두 환경 친화적 방식으로 처리됩니다. 현재 세계적으로 운영되고 있는 회수 및 재활용 시스템에는 여러 가지가 있습니다. 대부분의 부품의 경우 재사용

또는 재활용되지만 환경 위해 물질과 중금속은 환경 친화적 방법으로 처리됩니다.
 본사의 재활용 프로그램에 대한 자세한 정보는 각 지역의 LG 공급업체나 LG 기업 대표부에 문의하시기 바랍니다.

LG 전자는 기업 개선 정책의 하나로 지구 환경 문제를 채택함으로써 보다 나은 환경을 만들어 나가기 위한 비전과 정책을 수립했습니다. 본사의 친환경 정책에 대한 자세한 정보를 보시려면 아래의 웹 사이트를 방문하십시오.
<http://www.lge.co.kr/about/digitalg/environment/environment.jsp>

∴ EPA (U.S.A only) (EPA applied model only)

ENERGYSTAR is a set of power-saving guidelines issued by the U.S. Environmental Protection Agency(EPA).



As an ENERGY STAR Partner LGE U. S. A.,Inc. has determined that this product meets the ENERGY STAR guidelines for energy efficiency.

∴ NOM MARK (Mexico only)

