



APPENDIX G
: USER'S MANUAL



LG

Life's Good

OWNER'S MANUAL PLASMA TV

Please read this manual carefully before operating your set and retain it for future reference.

42PN450H
50PN450H

50PN530H
60PN530H

IMPORTANT SAFETY INSTRUCTIONS

Always comply with the following precautions to avoid dangerous situations and ensure peak performance of your product.

ENGLISH



WARNING / CAUTION

RISK OF ELECTRIC SHOCK

DO NOT OPEN



TO REDUCE THE RISK OF ELECTRIC SHOCK DO NOT REMOVE COVER (OR BACK). NO USER SERVICEABLE PARTS INSIDE. REFER TO QUALIFIED SERVICE PERSONNEL.

 The lightning flash with arrowhead symbol, within an equilateral triangle, is intended to alert the user to the presence of uninsulated "dangerous voltage" within the product's enclosure that may be of sufficient magnitude to constitute a risk of electric shock to persons.

 The exclamation point within an equilateral triangle is intended to alert the user to the presence of important operating and maintenance (servicing) instructions in the literature accompanying the appliance.

WARNING/CAUTION

- TO REDUCE THE RISK OF FIRE AND ELECTRIC SHOCK, DO NOT EXPOSE THIS PRODUCT TO RAIN OR MOISTURE.

 **WARNING**

If you ignore the warning message, you may be seriously injured or there is a possibility of accident or death.

 **CAUTION**

If you ignore the caution message, you may be slightly injured or the product may be damaged.

 **NOTE**

The note helps you understand and use the product safely. Please read the note carefully before using the product.

Read these instructions.
Keep these instructions.
Heed all warning.
Follow all instruction.



- Do not use this apparatus near water.



- Clean only with a dry cloth.



- Do not block any ventilation openings. Install in accordance with the manufacturer's instructions.



- Do not install near any heat sources such as radiators, heat registers, stoves, or other apparatus (including amplifiers) that produce heat.



- Do not defeat the safety purpose of the polarized or grounding-type plug. A polarized plug has two blades with one wider than the other. A grounding type plug has two blades and a third grounding prong. The wide blade or the third prong are provided for your safety. If the provided plug does not fit into your outlet, consult an electrician for replacement of the obsolete outlet (Can differ by country).



- Keep the product away from direct sunlight.



- Protect the power cord from being walked on or pinched particularly at plugs, convenience receptacles, and the point where they exit from the apparatus.



- Only use attachments/accessories specified by the manufacturer.



- Use only with a cart, stand, tripod, bracket, or table specified by the manufacturer, or sold with the apparatus. When a cart is used, use caution when moving the cart/apparatus combination to avoid injury from tip-over.



- Unplug this apparatus during lightning storms or when unused for long periods of time.

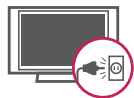

- Refer all servicing to qualified service personnel. Servicing is required when the apparatus has been damaged in any way, such as power-supply cord or plug is damaged, liquid has been spilled or objects have fallen into the apparatus, the apparatus has been exposed to rain or moisture, does not operate normally, or has been dropped.



- Do not stick metal objects or any other conductive material into the power cord. Do not touch the end of the power cord while it is plugged in.

- Keep the packing anti-moisture material or vinyl packing out of the reach of children. Anti-moisture material is harmful if swallowed. If swallowed by mistake, force the patient to vomit and visit the nearest hospital. Additionally, vinyl packing can cause suffocation. Keep it out of the reach of children.

- CAUTION concerning the Power Cord (Can differ by country):

It is recommended that appliances be placed upon a dedicated circuit; that is, a single outlet circuit which powers only that appliance and has no additional outlets or branch circuits. Check the specification page of this owner's manual to be certain. Do not connect too many appliances to the same AC power outlet as this could result in fire or electric shock. Do not overload wall outlets. Overloaded wall outlets, loose or damaged wall outlets, extension cords, frayed power cords, or damaged or cracked wire insulation are dangerous. Any of these conditions could result in electric shock or fire. Periodically examine the cord of your appliance, and if its appearance indicates damage or deterioration, unplug it, discontinue use of the appliance, and have the cord replaced with an exact replacement part by an authorized service. Protect the power cord from physical or mechanical abuse, such as being twisted, kinked, pinched, closed in a door, or walked upon. Pay particular attention to plugs, wall outlets, and the point where the cord exits the appliance. Do not move the TV with the power cord plugged in. Do not use a damaged or loose power cord. Be sure do grasp the plug when unplugging the power cord. Do not pull on the power cord to unplug the TV.



- **Warning** - To reduce the risk of fire or electrical shock, do not expose this product to rain, moisture or other liquids. Do not touch the TV with wet hands. Do not install this product near flammable objects such as gasoline or candles, or expose the TV to direct air conditioning.



- Do not expose to dripping or splashing and do not place objects filled with liquids, such as vases, cups, etc. on or over the apparatus (e.g. on shelves above the unit).



- **Grounding**
(Except for devices which are not grounded.)
Ensure that you connect the earth ground wire to prevent possible electric shock (i.e. a TV with a three-prong grounded AC plug must be connected to a three-prong grounded AC outlet). If grounding methods are not possible, have a qualified electrician install a separate circuit breaker. Do not try to ground the unit by connecting it to telephone wires, lightning rods, or gas pipes.

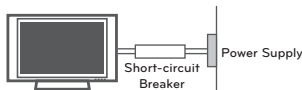

- As long as this unit is connected to the AC wall outlet, it is not disconnected from the AC power source even if the unit is turned off.
- Do not attempt to modify this product in any way without written authorization from LG Electronics. Unauthorized modification could void the user's authority to operate this product.

- **ANTENNAS Outdoor Antenna Grounding**
(Can differ by country):

If an outdoor antenna is installed, follow the precautions below. An outdoor antenna system should not be located in the vicinity of overhead power lines or other electric light or power circuits, or where it can come in contact with such power lines or circuits as death or serious injury can occur. Be sure the antenna system is grounded so as to provide some protection against voltage surges and built-up static charges. Section 810 of the National Electrical Code (NEC) in the U.S.A. provides information with respect to proper grounding of the mast and supporting structure, grounding of the lead-in wire to an antenna discharge unit, size of grounding conductors, location of antenna discharge unit, connection to grounding electrodes and requirements for the grounding electrode.

Antenna grounding according to the National Electrical Code, ANSI/NFPA 70

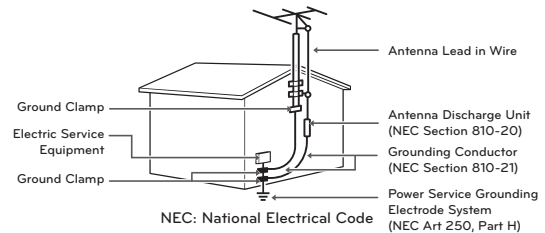

- **Cleaning**
When cleaning, unplug the power cord and wipe gently with a soft cloth to prevent scratching. Do not spray water or other liquids directly on the TV as electric shock may occur. Do not clean with chemicals such as alcohol, thinners or benzine.
- **Moving**
Make sure the product is turned off, unplugged and all cables have been removed. It may take 2 or more people to carry larger TVs. Do not press or put stress on the front panel of the TV.

- **Ventilation**

Install your TV where there is proper ventilation. Do not install in a confined space such as a bookcase. Do not cover the product with cloth or other materials while plugged. Do not install in excessively dusty places.

- If you smell smoke or other odors coming from the TV, unplug the power cord and contact an authorized service center.
- Do not press strongly upon the panel with a hand or a sharp object such as a nail, pencil or pen, or make a scratch on it.
- Never touch this apparatus or antenna during a thunder or lightning storm.
- When mounting a TV on the wall, make sure not to install the TV by hanging the power and signal cables on the back of the TV.
- Do not allow an impact shock or any objects to fall into the product, and do not drop anything onto the screen.

- **Disconnecting the Main Power**

Mains plug is the disconnecting device. The plug must remain readily operable.

- Store the accessories (battery, etc.) in a safe location out of the reach of children.
- This apparatus use batteries. In your community there might be regulations that require you to dispose of these batteries properly due to environmental considerations. Please contact your local authorities for disposal or recycling information.
- Do not dispose of batteries in a fire.
- Do not short circuit, disassemble or allow the batteries to overheat.

- **Dot Defect**

The Plasma or LCD panel is a high technology product with resolution of two million to six million pixels. In a very few cases, you could see fine dots on the screen while you're viewing the TV. Those dots are deactivated pixels and do not affect the performance and reliability of the TV.

- **Generated Sound**

“Cracking” noise: A cracking noise that occurs when watching or turning off the TV is generated by plastic thermal contraction due to temperature and humidity. This noise is common for products where thermal deformation is required.

Electrical circuit humming/panel buzzing: A low level noise is generated from a high-speed switching circuit, which supplies a large amount of current to operate a product. It varies depending on the product.

This generated sound does not affect the performance and reliability of the product.

- Take care not to touch the ventilation openings. When watching the TV for a long period, the ventilation openings may become hot. This does not affect the performance of the product or cause defects in the product.

Preventing "Image burn" or "Burn-in" on your TV screen

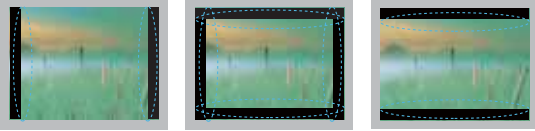

- If a fixed image displays on the TV screen for a long period of time, it will be imprinted and become a permanent disfigurement on the screen. This is "image burn" or "burn-in" and not covered by the warranty.
- If the aspect ratio of the TV is set to 4:3 for a long period of time, image burn may occur on the letterboxed area of the screen.
- Avoid displaying a fixed image on the TV screen for a long period of time (2 or more hours for LCD, 1 or more hours for the Plasma TV) to prevent image burn.

For USA and Canada

FCC NOTICE

This equipment has been tested and found to comply with the limits for a Class B digital device, pursuant to Part 15 of the FCC Rules. These limits are designed to provide reasonable protection against harmful interference in a residential installation.

This equipment generates, uses and can radiate radio frequency energy and, if not installed and used in accordance with the instructions, may cause harmful interference to radio communications. However, there is no guarantee that interference will not occur in a particular installation. If this equipment does cause harmful interference to radio or television reception, which can be determined by turning the equipment off and on, the user is encouraged to try to correct the interference by one or more of the following measures:

- Reorient or relocate the receiving antenna.
- Increase the separation between the equipment and the receiver.
- Connect the equipment to an outlet on a circuit different from that to which the receiver is connected.
- Consult the dealer or an experienced radio/TV technician for help.

This device complies with part 15 of the FCC Rules. Operation is subject to the following two conditions: (1) this device may not cause harmful interference and (2) this device must accept any interference received, including interference that may cause undesired operation of the device.

Any changes or modifications in construction of this device which are not expressly approved by the party responsible for compliance could void the user's authority to operate the equipment.

NOTE TO CABLE/TV INSTALLER

This reminder is provided to call the CATV system installer's attention to Article 820-40 of the National Electric Code (U.S.A.). The code provides guidelines for proper grounding and, in particular, specifies that the cable ground shall be connected to the grounding system of the building, as close to the point of the cable entry as practical.

LICENSES

Supported licenses may differ by model. For more information about licenses, visit 'www.lg.com'.



Manufactured under license from Dolby Laboratories. "Dolby" and the double-D symbol are trademarks of Dolby Laboratories.



HDMI, the HDMI logo and High-Definition Multimedia Interface are trademarks or registered trademarks of HDMI Licensing LLC.

TABLE OF CONTENTS

2 IMPORTANT SAFETY INSTRUCTIONS

7 LICENSES

8 TABLE OF CONTENTS

10 INSTALLATION PROCEDURE

10 ASSEMBLING AND PREPARING

- 10 Unpacking
- 12 Parts and buttons
- 13 Lifting and moving the TV
- 14 Setting up the TV
 - 14 - Attaching the stand
 - 16 - Mounting on a table
 - 17 - Mounting on a wall
 - 18 - Tidying cables

19 REMOTE CONTROL

21 WATCHING TV

- 21 Turning the TV on for the first time
- 22 Watching TV
- 22 Managing channels
 - 22 - Setting up channels
 - 23 - Using favorite channels
 - 24 - Checking current program info
- 25 Using additional options
 - 25 - Adjusting aspect ratio
 - 26 - Changing AV modes
 - 26 - Using the input list
- 27 Using the quick menu

28 ENTERTAINMENT

- 28 - Connecting USB storage devices
- 29 - Browsing files
- 30 - Viewing Photos
- 31 - Listening to music

33 CUSTOMIZING TV SETTINGS

- 33 The Main Menu
- 34 Customizing Settings
 - 34 - PICTURE Settings
 - 37 - AUDIO Settings
 - 38 - CHANNEL Settings
 - 39 - TIME Settings
 - 40 - OPTION Settings
 - 42 - LOCK Settings

44 MAKING CONNECTIONS

- 44 Connecting to an antenna or cable
- 45 Connection Overview
- 46 Connecting to a HD receiver, DVD Player or VCR
 - 46 - HDMI Connection
 - 47 - DVI to HDMI Connection
 - 48 - Component Connection
 - 49 - Composite Connection
- 50 Connecting to a PC
 - 50 - HDMI Connection or DVI to HDMI Connection
- 52 Connecting to an Audio System
 - 52 - Digital Optical Audio Connection
- 53 Connecting a USB Device
- 54 SIMPLINK Connection
 - 54 - Activating and Using the SIMPLINK menus

55 MAINTENANCE

- 55 Cleaning Your TV
- 55 - Screen, frame, cabinet and stand
- 55 - Power cord

56 TROUBLESHOOTING

57 EXTERNAL CONTROL DEVICE SETUP

58 SPECIFICATIONS

 **NOTE**

- Image shown may differ from your TV.
- Your TV's OSD (On Screen Display) may differ slightly from that shown in this manual.
- The available menus and options may differ from the input source or product model that you are using.
- New features may be added to this TV in the future.

INSTALLATION PROCEDURE

- 1 Open the package and make sure all the accessories are included.
- 2 Attach the stand to the TV set.
- 3 Connect an external device to the TV set.

ASSEMBLING AND PREPARING

Unpacking

Check your product box for the following items. If there are any missing accessories, contact the local dealer where you purchased your product. The illustrations in this manual may differ from the actual product and item.

ENGLISH

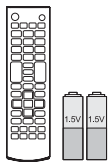

**Remote control,
Batteries (AAA)**
(See p.19)

(For 42PN450H)



Stand Screws
7 EA, M4 x 14
(See p.14)

(For 50PN450H, 50PN530H)

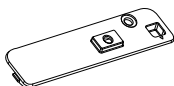

Protection Cover
(See p.15)

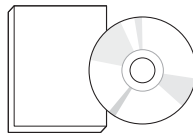

**Owner's manual,
CD manual**

(For 50PN450H,
50/60PN530H)



Stand Screws
7 EA, M5 x 16
(See p.14)

Power Cord holder
(See p.18)

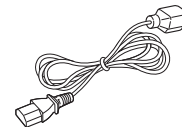

Power Cord

(For 42PN450H)

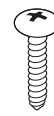

Desk-mount Screw
(See p.16)

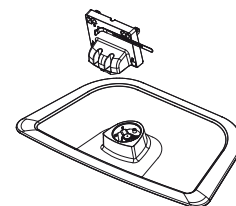

Stand Body, Stand Base
(See p.14)

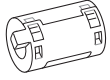

Ferrite core
(Depending on model)



CAUTION

- Do not use any unapproved items to ensure the safety and product life span.
- Any damages or injuries by using unapproved items are not covered by the warranty.
- Some models appear to have a thin film on the screen. It is actually part of the screen, do not remove it.



NOTE

- The items supplied with your product may vary depending on the model.
- Product specifications or contents of this manual may be changed without prior notice due to upgrade of product functions.
- How to use the ferrite core

1 Use the ferrite core to reduce the electromagnetic interference in the power cable.
Wind the power cable on the ferrite core once. Place the ferrite core close to the TV and a wall plug.

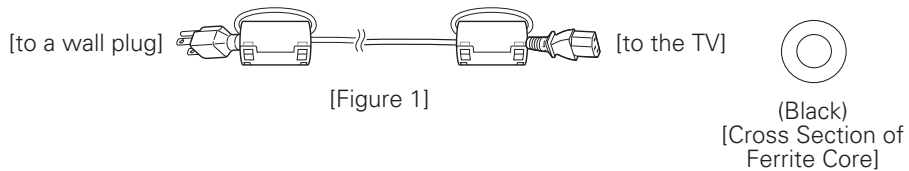

2 Use the ferrite core to reduce the electromagnetic interference in the cable.
Place the ferrite core close to the TV.
Wind the component cable on the ferrite core once.

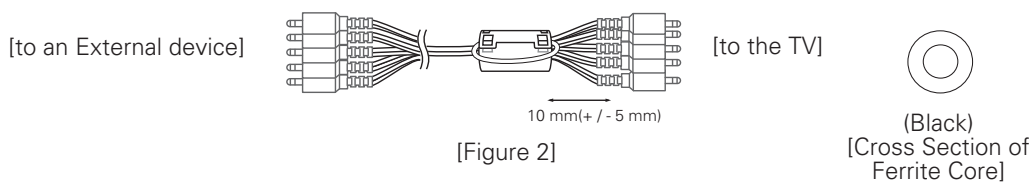

3 Use the ferrite core to reduce the electromagnetic interference in the PC audio cable.
Wind the PC audio cable on the ferrite core thrice. Place the ferrite core close to the TV.

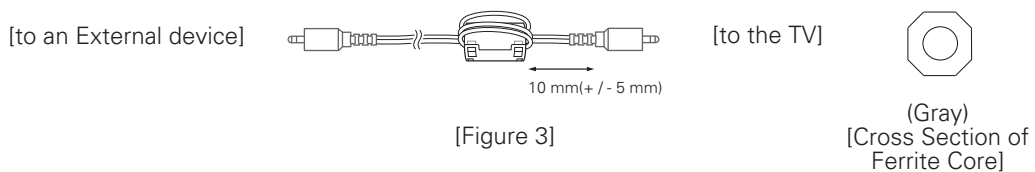

Parts and buttons

ENGLISH

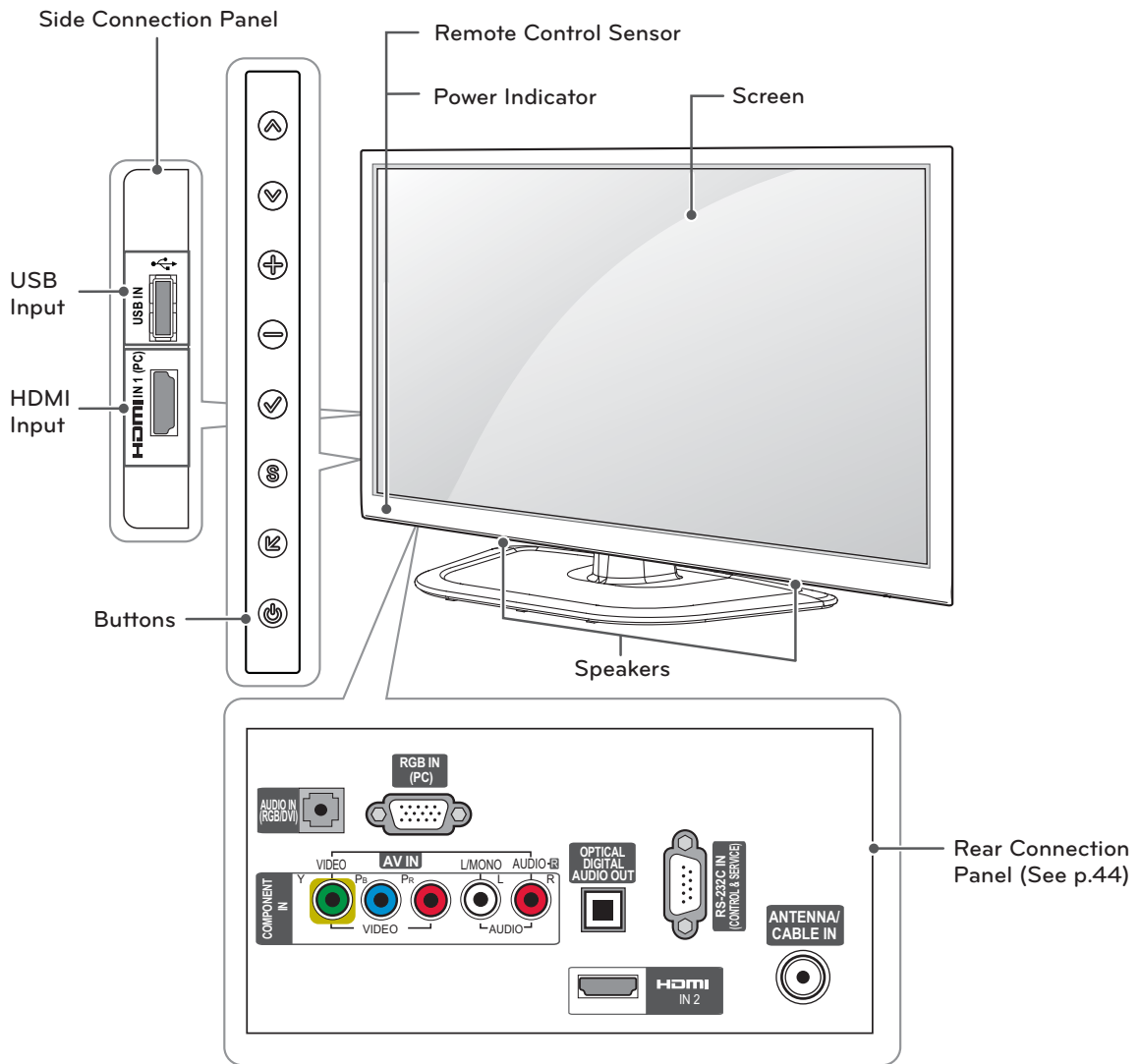

Button	Description
▲ / ▼	Scrolls through the saved channels.
+ / -	Adjusts the volume level.
✓	Selects the highlighted menu option or confirms an input.
S	Accesses the main menus, or saves your input and exits the menus.
↶	Changes the input source.
⏻	Turns the power on or off.

Lifting and moving the TV

When moving or lifting the TV, read the following to prevent the TV from being scratched or damaged and for safe transportation regardless of its type and size.



CAUTION

- Avoid touching the screen at all times, as this may result in damage to the screen.
- It is recommended to move the TV in the box or packing material that the TV originally came in.
- Before moving or lifting the TV, disconnect the power cord and all cables.
- When holding the TV, the screen should face away from you to prevent damage.



- Hold the top and bottom of the TV frame firmly. Make sure not to hold the transparent part, speaker, or speaker grill area.

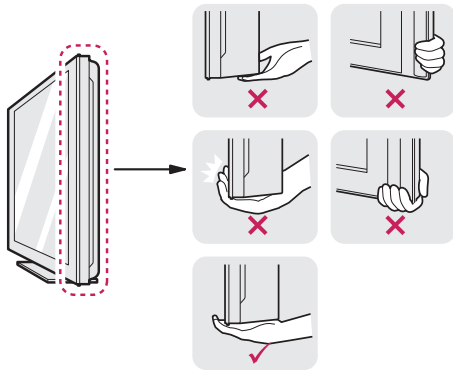

- When transporting a large TV, there should be at least 2 people.
- When transporting the TV by hand, hold the TV as shown in the following illustration.

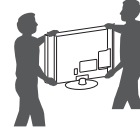

- When transporting the TV, do not expose the TV to jolts or excessive vibration.
- When transporting the TV, keep the TV upright, never turn the TV on its side or tilt towards the left or right.

Setting up the TV

Put your TV on a pedestal stand and mount the TV on a table or wall.

Attaching the stand

If you are not mounting the TV to a wall, use the following instructions to attach the stand.

CAUTION

- When attaching the stand to the TV set, place the screen facing down on a cushioned table or flat surface to protect the screen from scratches.
- Make sure that the screws are fastened completely. (If they are not fastened securely enough, the TV may tilt forward after being installed.)
- Do not fasten the screws with too much force; otherwise they may be worn out and get loosened.

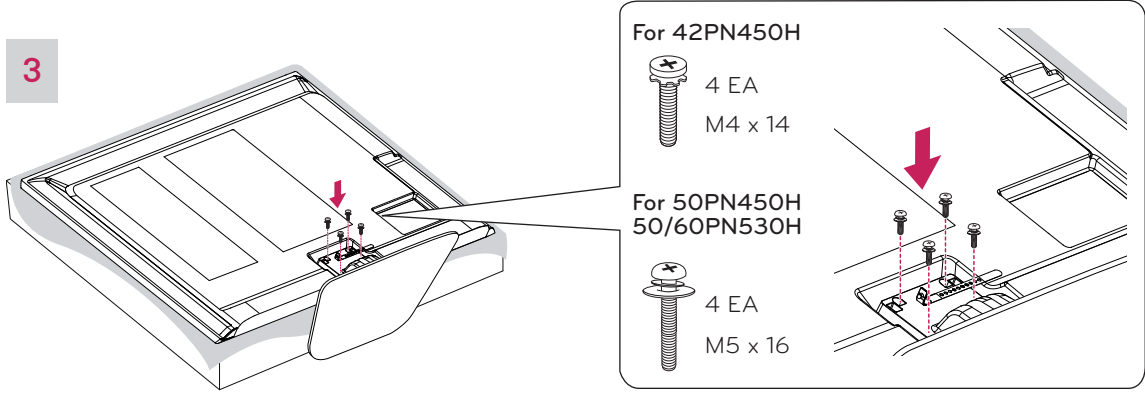
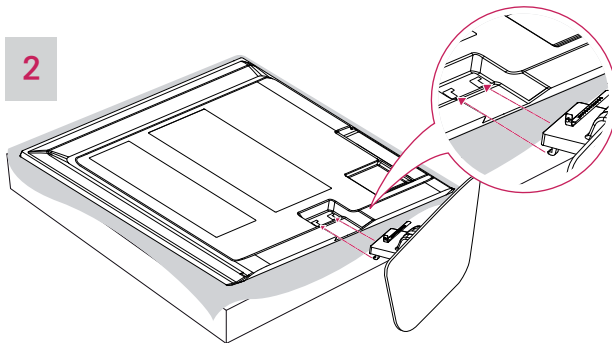
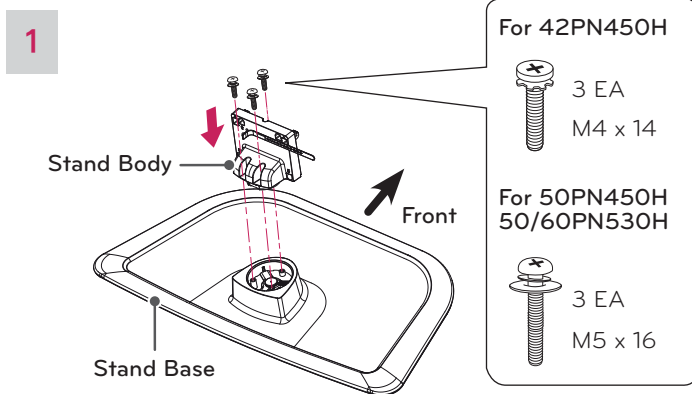

ENGLISH

To detach the stand,

For 50PN450H, 50PN530H

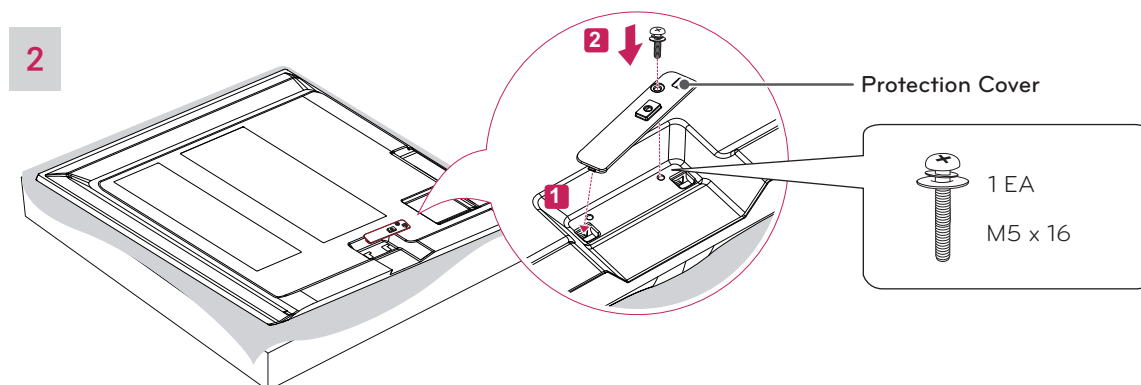
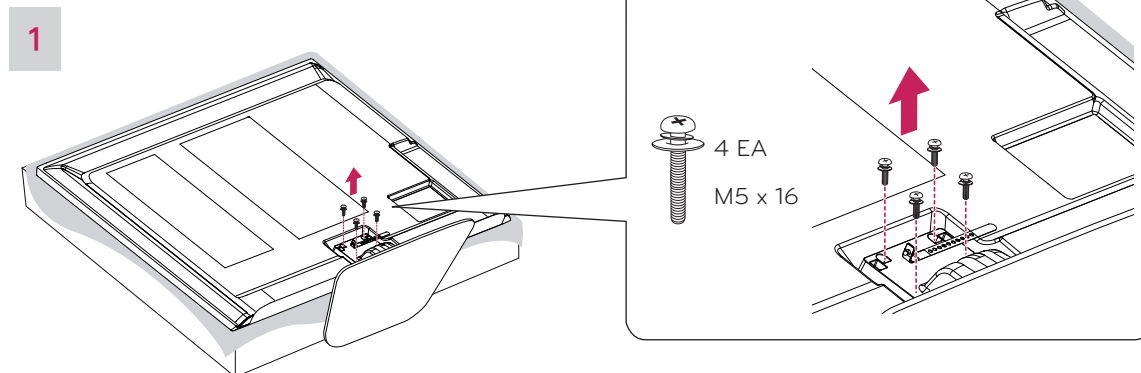

ENGLISH

NOTE

- Remove the stand before installing the TV on a wall mount by performing the stand attachment in reverse.
- When installing the wall mounting bracket, use the Protection cover. This will protect the opening from accumulating dust and dirt.

Mounting on a table

- 1 Lift and tilt the TV into its upright position on a table.
 - Leave a 10 cm (4 inches) (minimum) space from the wall for proper ventilation.

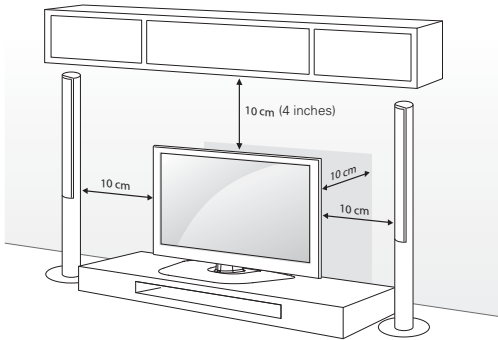

- 2 Connect the power cord to a wall outlet.



CAUTION

- Do not place the TV near or on sources of heat, as this may result in fire or other damage.

Securing the TV to a table

(For 42PN450H)

Fix the TV to a table to prevent from tilting forward, damage, and potential injury. Mount the TV on a table, and then insert and tighten the supplied screw on the rear of the stand.

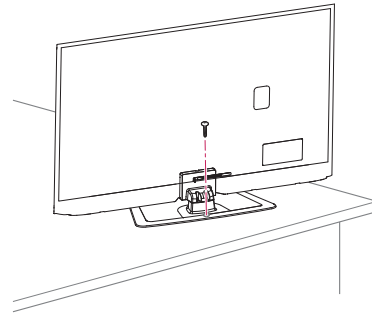

WARNING

- To prevent TV from falling over, the TV should be securely attached to the floor/wall per installation instructions. Tipping, shaking, or rocking the TV may cause injury.

ENGLISH

Adjusting the angle of the TV to suit view

Swivel 20 degrees to the left or right and adjust the angle of the TV to suit your view.

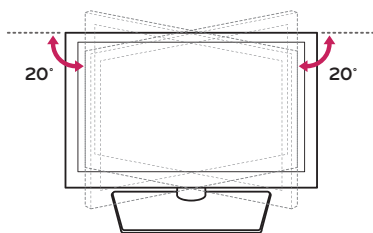

CAUTION

- When adjusting the angle of the TV, watch out for your fingers.
 - Personal injury may occur if hands or fingers are pinched. If the product is tilted too much, it may fall, causing damage or injury.

Securing the TV to a wall (optional)

(Depending on model)

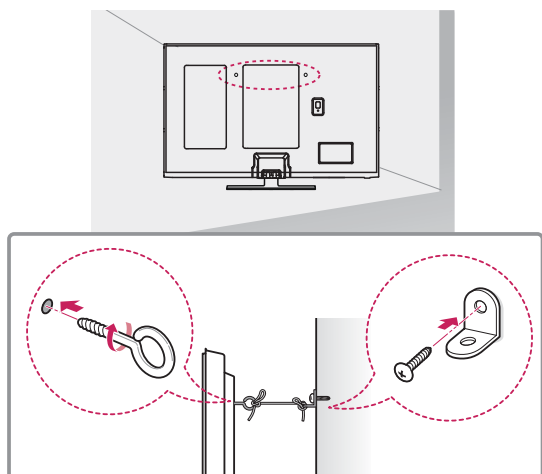

- 1 Insert and tighten the eye-bolts, or TV brackets and bolts on the back of the TV.
 - If there are bolts inserted at the eye-bolts position, remove the bolts first.
- 2 Mount the wall brackets with the bolts to the wall. Match the location of the wall bracket and the eye-bolts on the rear of the TV.
- 3 Connect the eye-bolts and wall brackets tightly with a sturdy rope. Make sure to keep the rope horizontal with the flat surface.



CAUTION

- Make sure that children do not climb on or hang on the TV.



NOTE

- Use a platform or cabinet that is strong and large enough to support the TV securely.
- Brackets, bolts and ropes are optional. You can obtain additional accessories from your local dealer.

Mounting on a wall

Attach an optional wall mount bracket at the rear of the TV carefully and install the wall mount bracket on a solid wall perpendicular to the floor. When you attach the TV to other building materials, please contact qualified personnel. We recommend that you use an LG brand wall mount when mounting the TV to a wall.

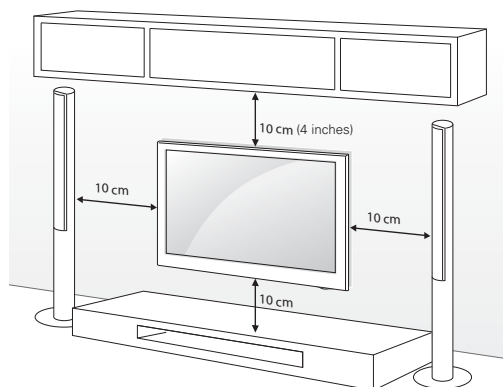

Make sure to use screws and wall mounts that meet the VESA standard. Standard dimensions for the wall mount kits are described in the following table.

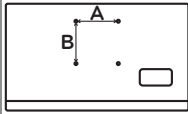
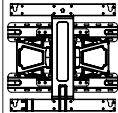
Model	42/50PN450H 50/60PN530H
VESA (A x B)	400 x 400
	
Standard screw	M6
Number of screws	4
Wall mount bracket (optional)	PSW420BX 

CAUTION

- Disconnect the power before moving or installing the TV. Otherwise electric shock may occur.
- If you install the TV on a ceiling or slanted wall, it may fall and result in severe injury. Use an authorized LG wall mount and contact the local dealer or qualified personnel.
- Do not over tighten the screws as this may cause damage to the TV and void your warranty.
- Use only screws and wall mounts that meet the VESA standard. Any damages or injuries by misuse or using an improper accessory are not covered by the warranty.

NOTE

- Use only screws that are listed on the VESA standard screw specifications.
- The wall mount kit includes an installation manual and necessary parts.
- The wall mount bracket is optional. You can obtain additional accessories from your local dealer.
- The length of screws may differ depending on the wall mount. Make sure to use the proper length.
- For more information, refer to the manual supplied with the wall mount.

ENGLISH

Tidying cables

- 1 Install the power cord holder and power cord. It will help prevent the power cable from being removed by accident.

(For 42PN450H)

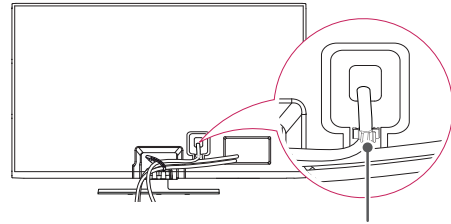

Power Cord Holder

(For 50PN450H, 50/60PN530H)

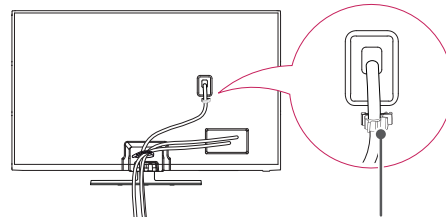

Power Cord Holder

- 2 Gather and bind the cables with the cable holder.

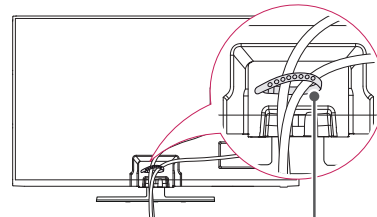

Cable Holder

CAUTION

- Do not move the TV by holding the cable holder and power cord holder, as the cable holders may break, and injuries and damage to the TV may occur.

REMOTE CONTROL

The descriptions in this manual are based on the buttons on the remote control. Please read this manual carefully and use the TV correctly. To install batteries, open the battery cover, replace batteries (1.5 V AAA) matching the ⊕ and ⊖ ends to the label inside the compartment, and close the battery cover. To remove the batteries, perform the installation actions in reverse.

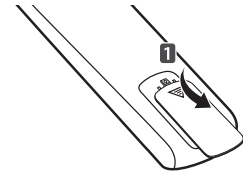

CAUTION

- Do not mix old and new batteries, as this may damage the remote control.

Make sure to point the remote control toward at the remote control sensor on the TV.

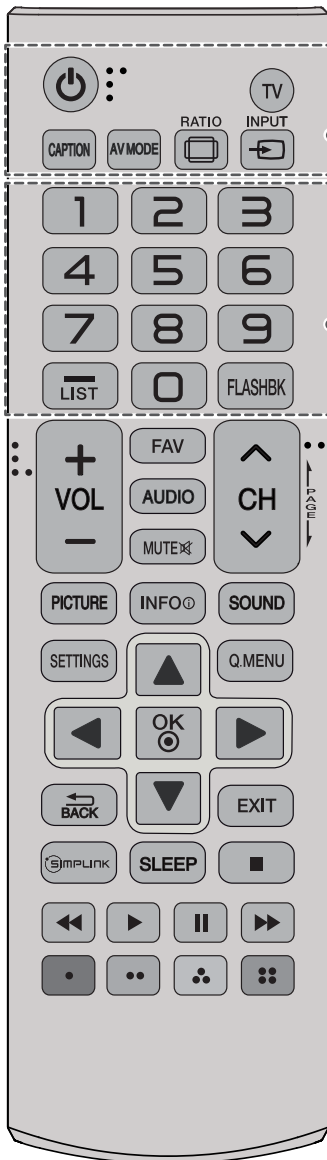

- ⏻ (POWER)**
Turns the TV on or off.
- TV**
Returns to the last TV channel.
- CAPTION**
Activates or deactivate the subtitles.
- AV MODE** (See p.26)
Selects an AV mode.
- ⏏ RATIO** (See p.25)
Resizes an image.
- ⏏ INPUT** (See p.26)
Changes the input source; Turns the TV on.

- Number button**
Enters numbers.
- LIST** (See p.23), **- (Dash)**
LIST: Accesses the saved channel list.
- (Dash): Inserts a dash between numbers such as 2-1 and 2-2.
- FLASHBK**
Alternates between the two last channels selected (pressing repeatedly).

ENGLISH

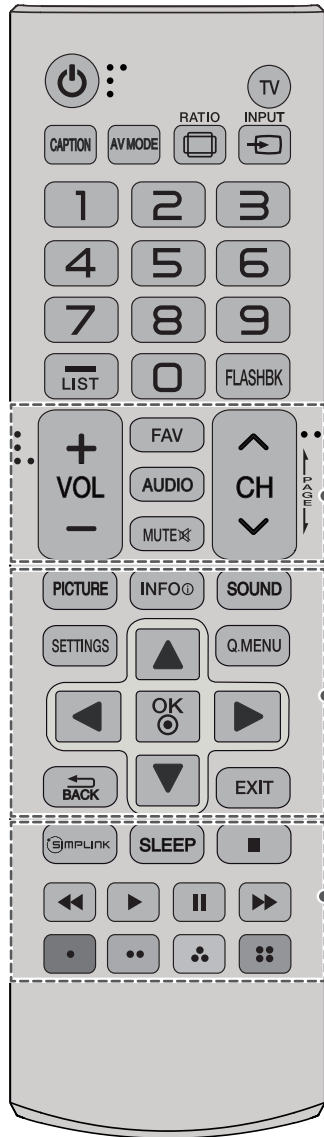

+ VOL -
Adjusts the volume level.

FAV (See p.23)
Accesses your favorite channel list;
Selects a menu or option.

AUDIO (See p.37)
Digital signal: Changes the audio language.
Analog signal: Changes the MTS sound.

MUTE
Mutes all sounds.

^ CH v, ↑ PAGE ↓
CH: Scrolls through the saved channels.
PAGE: Moves to the previous or next screen.

PICTURE (See p.34)
Changes the image mode.

INFO (See p.24)
Views the information of the current program and screen.

SOUND (See p.37)
Changes the sound mode.

SETTINGS
Accesses the main menu.

●. MENU (See p.27)
Accesses the quick menu.

Navigation buttons (up/down/left/right)
Scrolls through menus or options.

OK
Selects menus or options and confirms your input.

↶ BACK
Returns to the previous level.

EXIT
Clears all on-screen displays and returns to TV viewing.

SIMPLINK (See p.54)
Accesses the AV devices connected to the TV;
Opens the SIMPLINK menu.

SLEEP (See p.39)
Sets the length of time until the TV to turns off.

Control buttons (■, ▶, ||, ◀, ▶▶)
Controls the SIMPLINK compatible devices (USB, SIMPLINK).

|| (FREEZE)
Freezes the current frame
(Not supported when using USB Mode and Simplink).

Color buttons
These access special functions in some menus.
(: Red, : Green, : Yellow, : Blue)

WATCHING TV

Turning the TV on for the first time

When you turn the TV on for the first time, the Initial setting screen appears. Select a language and customize the basic settings.

- 1 Connect the power cord to a power outlet.
- 2 In Standby mode, press the power button on the remote control to turn the TV on.
The Initial setting screen appears when you turn the TV on for the first time.

! NOTE

- You can also access **Initial Setting** by accessing **OPTION** in the main menu.

- 3 Follow the on-screen instructions to customize your TV settings according to your preferences.

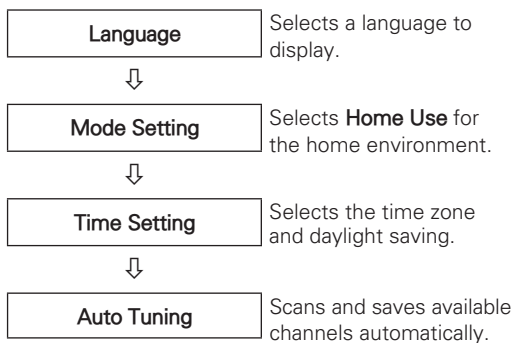

! NOTE

- To display images in the best quality for your home environment, select **Home Use**.
- **Store Demo** is suitable for the retail environment.
- If you select **Store Demo**, any customized settings will switch back to the default settings of **Store Demo** in 5 minutes.

- 4 When the basic settings are complete, press **OK**.

! NOTE

- If you do not complete the Initial setting, it will appear whenever the TV turns on.
- Disconnect the power cord from the power outlet when you do not use the TV for a long period of time.

- 5 To turn the TV off, press the power button on the remote control.

Watching TV

- 1 In Standby mode, press the power button on the remote control to turn the TV on.
- 2 Press **INPUT** and select TV.
- 3 Control the TV using the following buttons while you are watching TV.

Button	Description
CH (^, v)	Scrolls through saved channels.
LIST	Selects a channel on the saved channel list.
0 - 9	Selects a channel by entering numbers.
VOL (+, -)	Adjusts the volume level.
MUTE	Mutes all sounds.
AV MODE ¹	Selects an AV mode (See p.26).
●.MENU	Accesses the quick menus (See p.27).
FLASHBK	Alternates between the last two channels selected.
RATIO	Resizes an image (See p.25).
(FREEZE)	Freezes the current frame while you are watching TV.

1 Each **AV mode** has different optimized image and sound settings. If you select **Off**, the image and sound settings will be restored to the previously customized settings.

- 4 To turn the TV off, press the power button on the remote control.
The TV switches to Standby mode.

Managing channels

*Digital broadcasting (DTV, Cable DTV) is not supported in the Philippines.

Setting up channels

Storing channels

To store channels automatically,

- 1 Press **SETTINGS** to access the main menus.
- 2 Press the Navigation buttons to scroll to **CHANNEL** and press **OK**.
- 3 Press the Navigation buttons to scroll to **Auto Tuning** and press **OK**.
- 4 Select **Start** to start automatic tuning. The TV scans and saves available channels automatically.

! NOTE

- If the TV scans and saves channels, the previously saved channels will be overwritten.

- 5 When you are finished, press **EXIT**.
When you return to the previous menu, press **↶ BACK**.

To store channels manually,

- 1 Press **SETTINGS** to access the main menus.
- 2 Press the Navigation buttons to scroll to **CHANNEL** and press **OK**.
- 3 Press the Navigation buttons to scroll to **Manual Tuning** and press **OK**.
- 4 Scroll through the channel types, and then add or delete channels.
- 5 When you are finished, press **EXIT**.
When you return to the previous menu, press **↶ BACK**.

! NOTE

- You can store up to 700 channels. The number of channels that you can store differs depending on the broadcasting signal environment.
- The channels are stored in the order of **DTV**, **TV**, **Cable DTV** and **Cable TV**.

Editing your channel list

- 1 Press **SETTINGS** to access the main menus.
- 2 Press the Navigation buttons to scroll to **CHANNEL** and press **OK**.
- 3 Press the Navigation buttons to scroll to **Channel Edit** and press **OK**.
- 4 Edit channels using the following buttons.

Button	Description
▲	Highlights the channel type.
▲, ▼, ◀, ▶	Scrolls through channel types or channels.
OK ●	Selects the highlighted channel to view.
CH (▲, ▼)	Moves to the previous or next page.
Blue button	Adds or deletes a channel. The deleted channel displays in grey.

- 5 When you are finished, press **EXIT**.
When you return to the previous menu, press **BACK**.

Selecting a channel on the channel list

- 1 Press **LIST** to access the channel list.
- To move to the previous or next page, press **CH (▲, ▼)**.
- 2 Select a channel you want and press **OK**.

Using favorite channels

Add the channels that you watch frequently to the favorite list.

Setting up your favorite list

- 1 Select a channel to add to the favorite list.
- 2 Press **●.MENU**.
- 3 Press the Navigation buttons to scroll to **Del/Add/Fav**.
- 4 Press the Navigation buttons to scroll to **Favorite**.
- 5 Press **OK** to add the selected channel to the favorite list.
- 6 When you are finished, press **EXIT**.

Selecting a channel on the favorite list

- 1 Press **FAV** to access the favorite list.
- To move to the previous or next page, press **CH (▲, ▼)**.
- 2 Select a channel you want and press **OK**.

Checking current program info

Press **OK** to view the information of the currently program while you are watching. The following information appears at the top of the screen.

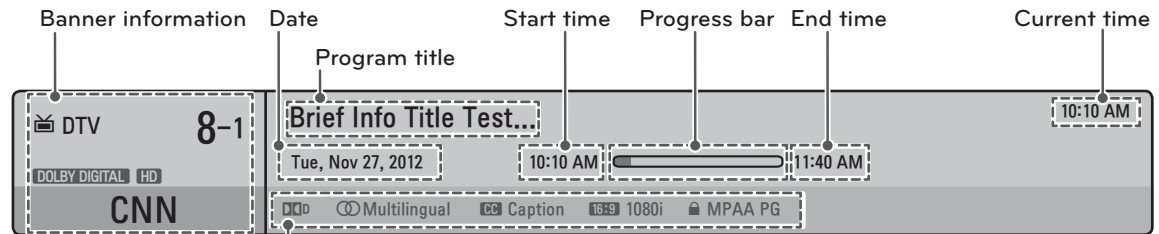

Icon		Description
Dolby Digital		The program contains a Dolby Digital audio signal. Supported by TV and HDMI input sources.
Multilingual		The program contains two or more audio language services. You can change the audio language using the quick menu.
Caption		The program contains one or more language caption services. You can change the caption language using the quick menu.
Aspect ratio		The original aspect ratio of the video is 4:3. The original aspect ratio of the video is 16:9 (wide).
Resolution		The video resolution is 720 x 480i. The video resolution is 720 x 480p. The video resolution is 1280 x 720p. The video resolution is 1920 x 1080i. The video resolution is 1920 x 1080p.
Rating		The program contains Rating information. See "LOCK Settings" on p.42.

Using additional options

Adjusting aspect ratio

Resize an image to its optimal size by pressing **RATIO** while you are watching TV.

! NOTE

- You can also change the image size by pressing **MENU** or accessing **Aspect Ratio** in the **PICTURE** menu.
- The available ratio varies depending on the input source.
 - The input sources: HDMI-PC and RGB-PC support 4:3 and 16:9.

- **16:9**: Resizes images to fit the screen width.



- **Just Scan**: Displays video images in the original size without cutting off the edges.



! NOTE

- If you select **Just Scan**, you may see image noise at the edges of the screen.
- The input sources: DTV, Component, HDMI-DTV, and DVI-DTV (720p/1080i/1080p) support Just Scan.

- **4:3**: Resizes images to the previous standard 4:3.



- **Set By Program**: Displays images in the same aspect ratio as the original image.

(4:3 → 4:3)



(16:9 → 16:9)



- **Zoom**: Formats an image to fit the screen width. The top and bottom of the image may not appear.



- **Cinema Zoom**: Formats an image to the cinemascope ratio, 2.35:1.
 - To change the ratio of the cinema zoom, press **<** or **>** and its range is from 1 to 16.



! NOTE

- If you enlarge or reduce an image, the image may be distorted.

Changing AV modes

Each **AV mode** has optimized image and sound settings.

Press **AV MODE** repeatedly to select an appropriate mode.

Mode	Description
Off	Changes to the previously customized settings.
Cinema	Uses the optimized image and sound settings for a cinematic look.
Game	Uses the optimized image and sound settings for fast gaming. When playing a video game using PlayStation or Xbox, it is recommended to use the Game mode. When in Game mode, functions related to picture quality will be optimized for playing games.

Using the input list

Selecting an input source

- 1 Press **INPUT** to access the input sources.
 - The connected device displays on each input source.

NOTE

- You can also access the input source list by selecting **INPUT** in the **SETTINGS** menu.

- 2 Press the Navigation buttons to scroll to one of the input sources and press **OK**.

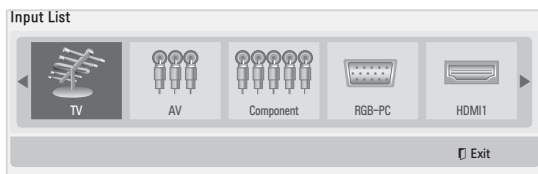

Input source	Description
TV	Watch TV over the air, cable, and digital cable broadcast.
AV	Watch video from a VCR or other external devices.
Component	Watch video from a DVD or other external devices, or through a digital set-top box.
RGB-PC	Use the TV as a computer monitor.
HDMI	Watches video from a HTS or other high definition devices.

The disconnected input sources will be gray.

- To add an input label, press the **Blue** button. You can easily identify a device connected to each input source.
- If you connect a new external device to the TV, a pop-up window appears. Select Yes on the pop-up window to switch to that input source.

Adding an Input label

Add a label to an input source so that you can easily identify a device connected to each input source.

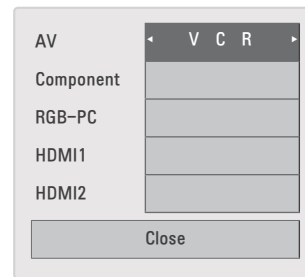









- 1 Press **INPUT** to access the input sources.
- 2 Press the Navigation buttons to scroll to one of the input sources.
- 3 Press the **Blue** button.
- 4 Press the Navigation buttons to scroll to one of the input labels and press **OK**.
- 5 When you are finished, press **EXIT**. When you return to the previous menu, press **BACK**.

Using the quick menu

Customize frequently used menus.

- 1 Press **●.MENU** to access the quick menus.
- 2 Press the Navigation buttons to scroll through the following menus and press **OK**.

Menu	Description
 Aspect Ratio	Changes the image size.
 Picture Mode	Changes the image mode.
 Sound Mode	Changes the sound mode.
 Caption	Activates or deactivate the subtitles.
 Multi Audio (Digital signal)	Changes the audio language .
 SAP (Analog signal)	Changes the MTS sound.
 Sleep Timer	Sets the length of time until the TV to turns off.
 Del/Add/Fav	Edits the channels to add or delete the channel.
 Eject USB	Eject a USB device. The menu is activated only when the USB device is connected.

NOTE

- The available menus and options may differ from the input source that you are using.

- 3 Press the Navigation buttons to scroll to the option you want.
- 4 When you are finished, press **●.MENU**.

ENTERTAINMENT

Connecting USB storage devices

Connect USB storage devices such as a USB flash drive or external hard drive to the TV and use multimedia features ("Browsing files" on p. 29). Connect a USB flash drive or USB memory card reader to the TV as shown in the following illustration.

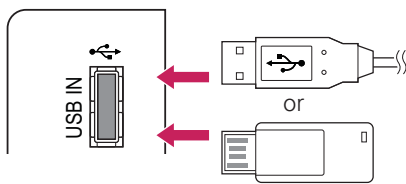

To disconnect a USB storage device, make sure to end the connection properly to prevent damages to the TV or files.

- 1 Press **●.MENU** to access the quick menus.
- 2 Press the Navigation buttons to scroll to **Eject USB** and press **OK**.
- 3 Disconnect the USB storage device only when the message says that it is safe to remove.

CAUTION

- Do not turn the TV off or remove a USB storage device while the USB storage device is connected to the TV, as this could result in loss of files or damage to the USB storage device.
- Back up your files saved on a USB storage device frequently, as you may lose or damage the files and this is not covered by the warranty.

Tips for using USB storage devices

- The TV recognizes only a USB storage device.
- If you connect a USB storage device to the TV through a USB hub, your TV may not recognize the USB storage device.
- The TV may not recognize a USB storage device that requires a special driver.
- The recognition speed of a USB storage device may differ depending on the device.
- Only use a USB storage device which has normal music or image files.
- Use only USB storage devices that are formatted as a FAT 32 or NTFS file system.
- You may need to connect a USB storage device to an external power supply with a power adapter.
- If the TV does not recognize a connected USB storage device, replace the cable and try again. Do not use an excessively long cable.
- The TV does not support some USB storage devices properly.
- You can use a multi-partition (up to 4) USB storage device.
- The file alignment method of a USB storage device is similar to the one of Window XP.
- You cannot create or delete a folder saved in a USB storage device directly on the TV.
- The number of characters for a file name is up to 100 English characters.
- If there are too many folders and files in one folder, it may not operate properly.
- The recommended capacity for a USB external hard disk is 1 TB or less and for a USB storage device is 32 GB or less.
- If a USB external hard disk with the Energy Saving feature does not work, turn the USB external hard disk off and on again to make it work properly. For more information, refer to the user manual of the USB external hard disk.
- The electrostatic can cause USB device's malfunction. In this case, USB Device has to be plugged again.

Browsing files

Access the photo or music list to browse files.

- 1 Connect a USB storage device.
- 2 Press **SETTINGS** to access the main menus.
- 3 Press the Navigation buttons to scroll to **USB** and press **OK**.
- 4 Press Navigation buttons to scroll to **Photo List** or **Music List** and press **OK**.



- 5 Select **DriveA** to access the connected USB storage device.
- 6 Press the Navigation buttons to Select a folder/file you want.

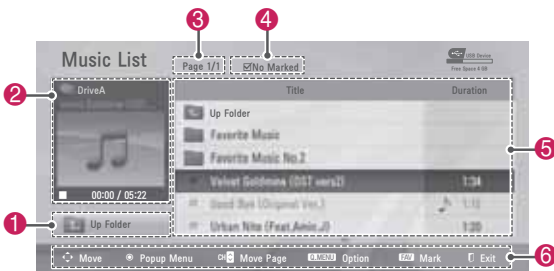
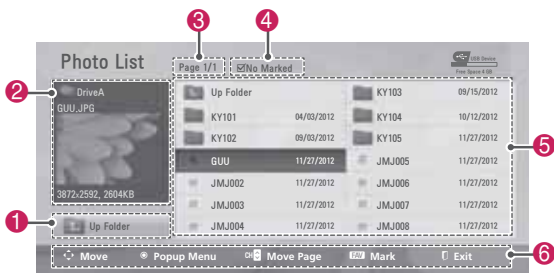

No.	Description
①	Moves to the upper level folder.
②	Preview
③	Current page/Total pages
④	Total number of marked files
⑤	Contents under the folder focused on ①
⑥	Available buttons on the remote control

Tips for using USB storage devices

Type	Supported File Formats
Photo	<ul style="list-style-type: none"> • JPG • Available size Baseline: 64 pixel (W) x 64 pixel (H) - 15360 pixel (W) x 8640 pixel (H) Progressive: 64 pixel (W) x 64 pixel (H) - 1024 pixel (W) x 768 pixel (H) * Do not use the progressive option when saving JPG files on your PC. • It may take some time to open high-resolution images in full screen.
Music	<ul style="list-style-type: none"> • MP3 • Bit rate range 32 Kbps - 320 Kbps • Sampling rate (Sampling Frequency) MPEG1 layer 3: 32 kHz, 44.1 kHz, 48 kHz MPEG2 layer 3: 16 kHz, 22.05 kHz, 24 kHz MPEG2.5 layer 3: 8 kHz, 11.025 kHz, 12 kHz * A copy-protected file will not play.

Viewing Photos

You can view image files saved on a USB storage device. The displays on the screen may differ based on the model.

- 1 Press **SETTINGS** to access the main menus.
- 2 Press the Navigation buttons to scroll to **USB** and press **OK**.
- 3 Press the Navigation buttons to scroll to **Photo List** and press **OK**.
- 4 Select **DriveA** to access the connected USB storage device.
- 5 Press the Navigation buttons to scroll to a folder/file you want and press **OK**.
- 6 View photos by using the following menus/buttons.



Button	Description
Navigation button	Scrolls the file.
OK	Views the highlighted file or enters the mark mode.
CH (⤴, ⤵)	Moves to the previous or next page.
FAV	Enters the mark mode.
Menu	Description
View	Views the selected photo.
Mark All	Selects all files
Unmark All	Clears all of your selections.
Close	Exits the Mark Mode.

NOTE

-  : Non-supported files are displayed using this graphic.

- 7 The following options are available while viewing photos.



Option	Description
Slideshow	<ul style="list-style-type: none"> • Starts or stops a slideshow with selected photos. • If there are no selected photos, all photos saved in the current folder display during a slideshow. • To set a slideshow speed, select Option.
BGM (Background Music)	<ul style="list-style-type: none"> • Turns the background music on or off. To set the background music folder, select Option.
⤵ (Rotate)	<p>Rotates photos clockwise (90°, 180°, 270°, 360°).</p> <p>NOTE</p> <ul style="list-style-type: none"> • The supported photo size is limited. You cannot rotate a photo if the resolution of the rotated width is larger than the supported resolution size.
Hide	Hides the option window. To display the options, press OK .
Exit	Moves to the previous menu screen.

NOTE

- Option values changed in Photo List do not affect Music List.
- Option values changed in Photo List or Music List are changed likewise in Photo List and Music List.

Q.MENU options for photo list

- 1 Press **Q.MENU**.
A pop-up window will appear.
- 2 Press the Navigation buttons to scroll to photo list option and press **OK**.
- 3 Press the Navigation buttons to scroll to one of the following options and press **OK**.

Set Photo View.

Option	Description
Slide Speed	Selects a slideshow speed (Fast, Normal, Slow).
Music Folder	Selects a music folder for the background music. NOTE • You cannot change the music folder while the background music is playing.

Set Video.

Allows you to change Video presets. (Refer to "PICTURE Settings" on p.34).

Set Audio.

Allows you to change Audio presets. (Refer to "AUDIO Settings" on p.37).

Listening to music

- 1 Press **SETTINGS** to access the main menus.
- 2 Press the Navigation buttons to scroll to **USB** and press **OK**.
- 3 Press the Navigation buttons to scroll to **Music List** and press **OK**.
- 4 Select **DriveA** to access the connected USB storage device.
- 5 Press the Navigation buttons to scroll to a folder/file you want and press **OK**.
- 6 Play music by using the following menus/buttons.

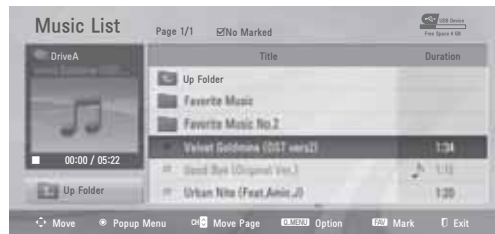

Button	Description
Navigation button	Scrolls through the files.
OK	Plays the highlighted file or enters the mark mode.
CH (⏮, ⏭)	Moves to the previous or next page.
FAV	Enters the mark mode.
Menu	Description
Play	Plays the selected music file.
Play with Photo	Displays photos during playback.
Mark All	Selects all files.
Unmark All	Clears all of your selections.
Close	Exits the Mark Mode.

NOTE

- : Abnormal files are displayed using this graphic.
- : Non-supported files are displayed using this graphic.

7 Control playing by using the following buttons.

Button	Description
■	Stops playback.
▶	Plays a music file.
	Pauses or resumes playback.
◀	Skips to the previous file.
▶▶	Skips to the next file.

Q.MENU options for music list

- 1 Press ●. **MENU**.
A pop-up window will appear.
- 2 Press the Navigation buttons to scroll to music list option and press **OK**.
- 3 Press the Navigation buttons to scroll to one of the following options and press **OK**.

! NOTE

- Option value changed in Photo List and Music List are changed likewise in Photo List and Music List.

Set audio.

Allows you to change Audio presets.
(Refer to "AUDIO Settings" on p.37).

! NOTE



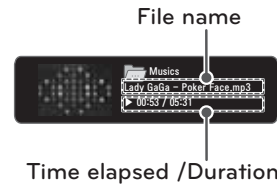





- The TV will not play copy protected files.
- If the TV is not in use for some time during playback, the information box as a screensaver will appear to prevent image burn.
To return to the Music list screen, press **OK** or ↶ **BACK**.



CUSTOMIZING TV SETTINGS

The Main Menu

- 1 Press **SETTINGS** to access the main menus.
- 2 Press the Navigation buttons to scroll to one of the following menus and press **OK**.
- 3 Press the Navigation buttons to scroll to the setting or option you want and press **OK**.
- 4 When you are finished, press **EXIT**.

Menu (Depending on model)		Description
	PICTURE	Adjusts the image size, quality, or effect.
	AUDIO	Adjusts the sound quality, effect, or volume level.
	CHANNEL	Sets up and edits channels.
	TIME	Sets the time, date, or Timer feature.
	OPTION	Customizes general settings.
	LOCK	Locks or unlocks channels and programs.
	INPUT	Views the input sources with their labels.
	USB	Displays photo and play music content stored on your USB.

Customizing Settings

PICTURE Settings

- 1 Press **SETTINGS** to access the main menus.
- 2 Press the Navigation buttons to scroll to **PICTURE** and press **OK**.
- 3 Press the Navigation buttons to scroll to the setting or option you want and press **OK**.
- To return to the previous level, press **↶ BACK**.
- 4 When you are finished, press **EXIT**.

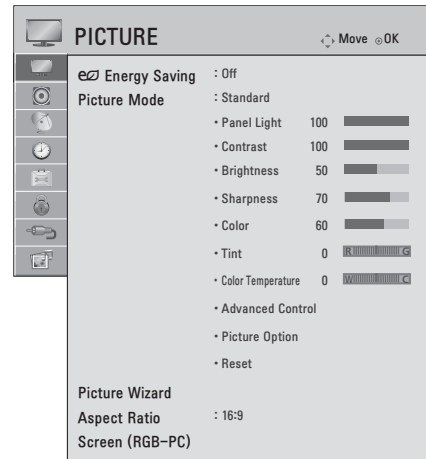

The available picture settings are described in the following.

Setting	Description	
Energy Saving	Reduces the power consumption by adjusting the screen brightness.	
	Option	
	Off	Select if this feature is not necessary.
	Minimum/ Medium/Maximum	Selects the brightness level.
Screen off	The screen turns off in 3 seconds. Pressing any button of the remote control will turn on the screen again.	
Picture Mode	Selects one of the preset image or customizes options in each mode for the best TV screen performance. You are also able to customize advanced options of each mode. The available preset picture modes vary depending on the TV.	
	Mode	
	Vivid	Adjusts the video image for the retail environment by enhancing the contrast, brightness, color, and sharpness.
	Standard	Adjusts the image for the normal environment.
	Eco / APS (Depending on country)	The Energy Saver feature changes settings on the TV to reduce power consumption.
	Cinema	Optimizes the video image for a cinematic look to enjoy movies as if you are in a movie theater.
	Game	Optimizes the video image for a fast gaming screen such as PCs or games.
	Photo	Displays the optimum picture for photo (still image).
Expert1, 2	Adjusts the detailed video image settings for video experts as well as general viewers.	
Picture Wizard	Adjusts the image quality and calibrates the screen. The customized options will be saved as Expert1 in the Picture Mode .	
	<div style="border: 1px solid black; padding: 5px;"> <p>NOTE</p> <ul style="list-style-type: none"> If you use Picture Wizard, the Energy saving feature will turn off automatically. To reset changes made by Picture Wizard, operate Picture Reset when Picture Mode is on Expert1. </div>	

Setting	Description	
Aspect Ratio	Changes the image size to view images at its optimal size (See p.25).	
SCREEN (RGB-PC)	Customizes the PC display options.	
	Option	
	Resolution	Selects a proper resolution when your PC uses 1024 X 768, 1280 X 768, or 1360 X 768 resolution.
	Auto Configure	Sets the TV to optimize the options automatically for the TV display.
	Position	Locates the image at the proper position.
	Size	Adjusts the image size.
	Phase	Eliminates horizontal streaking.
	Reset	Restores the options to the default setting.

Basic Image Options

Setting	Description
Panel Light	Adjusts the display brightness by varying the brightness of the PDP panel.
Contrast	Increases or decreases the amplitude of the video signal. You may use Contrast when the bright part of the picture is saturated.
Brightness	Adjusts the base level of the signal in the picture.
Sharpness	Adjusts the level of crispness in the edges between the light and dark areas of the picture. The lower the level, the softer the image.
Color	Adjusts intensity of all colors.
Tint	Adjusts the balance between red and green levels.
Color Temperature	Sets to warm to enhance hotter colors such as red, or set to cool to enhance cooler colors such as blue.
Advanced Control or Expert Control	Customizes the advanced options.
Picture Option	Adjusts detailed setting for images.
Reset	Restores the options of each mode to the factory default.

Advanced or Expert Image Options

Setting	Description		
Dynamic Contrast	Adjusts the contrast to keep it at the best level according to the brightness of the screen. The picture is improved by making bright parts brighter and dark parts darker.		
Dynamic Color	Adjusts screen colors so that they look livelier, richer and clearer. This feature enhances hue, saturation and luminance so that red, blue and green white look more vivid.		
Skin Color	Skin color spectrum can be separately set to implement the skin color defined by the user.		
Grass Color	Natural color spectrum(meadows, hills, etc.) can be separately set.		
Sky Color	Sky color is set separately.		
Gamma	Sets the gradation curve according to the output of picture signal in relation to the input signal.		
Color Gamut	Displays color domain of the signal. <ul style="list-style-type: none"> » Standard: Displays standard set of colors. » EBU: Mode to display EBU standard color area. » SMPTE: Mode to display SMPTE standard color area. » BT709: Mode to display BT709 standard color area. » Wide: Increase number of colors used. 		
Edge Enhancer	Shows clearer and distinctive yet natural edges of the video. This function works well over Sharpness UI 30 value.		
Color Filter	This is the function to filter the specific colors of the video. You can use the RGB filter to set color saturation and hue accurately.		
Color Temperature	Adjusts the overall color of the screen by changing the white baseline. <table border="0" style="width: 100%; border-collapse: collapse;"> <tr> <td style="width: 50%; vertical-align: top;"> <p>a. Gamma : Select Cool, Medium, Warm1, Warm2</p> <p>b. Method : 2 Points</p> <ul style="list-style-type: none"> • Pattern: Inner, Outer • Points: Low, High • Red/Green/Blue: The adjustment range is -50 - +50 </td> <td style="width: 50%; vertical-align: top;"> <p>c. Method : 20 Point IRE</p> <ul style="list-style-type: none"> • Pattern: Inner, Outer • IRE (Institute of Radio Engineers) is the unit to display the size of the video signal and can be set among 0, 5, 10, 15 - 100 Plasma TV. You can adjust Red, Green or Blue according to each setting. • Red/Green/Blue: The adjustment range is -50 - +50. <p>d. Apply to all inputs</p> </td> </tr> </table>	<p>a. Gamma : Select Cool, Medium, Warm1, Warm2</p> <p>b. Method : 2 Points</p> <ul style="list-style-type: none"> • Pattern: Inner, Outer • Points: Low, High • Red/Green/Blue: The adjustment range is -50 - +50 	<p>c. Method : 20 Point IRE</p> <ul style="list-style-type: none"> • Pattern: Inner, Outer • IRE (Institute of Radio Engineers) is the unit to display the size of the video signal and can be set among 0, 5, 10, 15 - 100 Plasma TV. You can adjust Red, Green or Blue according to each setting. • Red/Green/Blue: The adjustment range is -50 - +50. <p>d. Apply to all inputs</p>
<p>a. Gamma : Select Cool, Medium, Warm1, Warm2</p> <p>b. Method : 2 Points</p> <ul style="list-style-type: none"> • Pattern: Inner, Outer • Points: Low, High • Red/Green/Blue: The adjustment range is -50 - +50 	<p>c. Method : 20 Point IRE</p> <ul style="list-style-type: none"> • Pattern: Inner, Outer • IRE (Institute of Radio Engineers) is the unit to display the size of the video signal and can be set among 0, 5, 10, 15 - 100 Plasma TV. You can adjust Red, Green or Blue according to each setting. • Red/Green/Blue: The adjustment range is -50 - +50. <p>d. Apply to all inputs</p>		
Color Management System	As the tool used by the experts to make adjustments by using the test patterns, this does not affect other colors but can be used to selectively adjust the 6 color areas (Red/Green/Blue/Cyan/Magenta/Yellow). Color difference may not be distinctive even when you make the adjustments for the general video. Adjusts Red/Green/Blue/Yellow/Cyan/Magenta. Red/Green/Blue/Yellow/Cyan/Magenta Color: The adjustment range is -30 - +30. Red/Green/Blue/Yellow/Cyan/Magenta Tint: The adjustment range is -30 - +30. Red/Green/Blue/Yellow/Cyan/Magenta Luminance: The adjustment range is -30 - +30. This feature is disabled in RGB-PC mode.		

Picture Options

Setting	Description
Noise Reduction	Reduces screen noise without compromising video quality.
MPEG Noise Reduction	Reduces noise caused by compressing digital video.
Black Level	Sets black level of the screen to proper level. This function is available in the following modes: TV(NTSC-M/J, PAL-M, PAL-N), AV (NTSC-M/J, PAL-M, PAL-N), HDMI or Component. <ul style="list-style-type: none"> » Auto: Realizing the black level of the screen and set it to High or Low automatically. » Low: The reflection of the screen gets darker. » High: The reflection of the screen gets brighter.
Real Cinema	Optimizes the screen for movie viewing
Motion Eye Care	Saves power consumption by adjusting the brightness corresponding to movement in the video.

AUDIO Settings

- 1 Press **SETTINGS** to access the main menus.
- 2 Press the Navigation buttons to scroll to **AUDIO** and press **OK**.
- 3 Press the Navigation buttons to scroll to the setting or option you want and press **OK**.
- To return to the previous level, press **BACK**.
- 4 When you are finished, press **EXIT**.

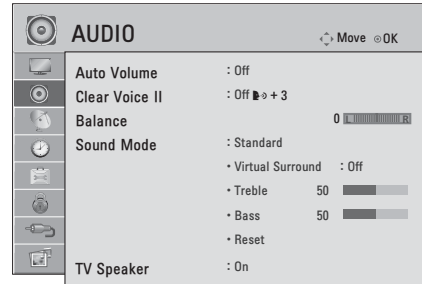

The available audio settings are described in the following.

Setting	Description																						
Auto Volume	Activates the Auto Volume feature to keep the volume level consistent whenever you change channels. The volume level may not be consistent due to different signal conditions of broadcasting stations.																						
Clear Voice II	Enhances human voice clarity. You can adjust the level of clarity after you turn this feature on.																						
Balance	Adjust balance between the left and right speakers according to your room environment.																						
Sound Mode	Selects one of the preset sound modes or allows you to customize options in each mode. <table border="1" style="width: 100%; border-collapse: collapse;"> <thead> <tr> <th colspan="2">Mode</th> </tr> </thead> <tbody> <tr> <td>Standard</td> <td>Select when you want standard-quality sound.</td> </tr> <tr> <td>Music</td> <td>Select when you listen to music.</td> </tr> <tr> <td>Cinema</td> <td>Select when you watch movies.</td> </tr> <tr> <td>Sport</td> <td>Select when you watch sports events.</td> </tr> <tr> <td>Game</td> <td>Select when you play games.</td> </tr> </tbody> </table> <div style="border: 1px solid black; padding: 5px; margin-top: 5px;"> <p>NOTE</p> <ul style="list-style-type: none"> If sound quality or volume is not at the level you want, it is recommended to use a separate home theater system or amplifier to cope with different user environments. If the Clear Voice II feature is on, Virtual Surround will not be activated. </div> <table border="1" style="width: 100%; border-collapse: collapse; margin-top: 5px;"> <thead> <tr> <th colspan="2">Option</th> </tr> </thead> <tbody> <tr> <td>Virtual Surround</td> <td>Virtual Surround is a patented LG proprietary sound processing technology that produces immersive 5.1 surround sound with just two front speakers.</td> </tr> <tr> <td>Treble</td> <td>Controls the dominant sounds in the output. When you turn up the treble, it will increase the output to the higher frequency range.</td> </tr> <tr> <td>Bass</td> <td>Controls the softer sounds in the output. When you turn up the bass, it will increase the output to the lower frequency range.</td> </tr> <tr> <td>Reset</td> <td>Resets the sound mode to the default setting.</td> </tr> </tbody> </table>	Mode		Standard	Select when you want standard-quality sound.	Music	Select when you listen to music.	Cinema	Select when you watch movies.	Sport	Select when you watch sports events.	Game	Select when you play games.	Option		Virtual Surround	Virtual Surround is a patented LG proprietary sound processing technology that produces immersive 5.1 surround sound with just two front speakers.	Treble	Controls the dominant sounds in the output. When you turn up the treble, it will increase the output to the higher frequency range.	Bass	Controls the softer sounds in the output. When you turn up the bass, it will increase the output to the lower frequency range.	Reset	Resets the sound mode to the default setting.
Mode																							
Standard	Select when you want standard-quality sound.																						
Music	Select when you listen to music.																						
Cinema	Select when you watch movies.																						
Sport	Select when you watch sports events.																						
Game	Select when you play games.																						
Option																							
Virtual Surround	Virtual Surround is a patented LG proprietary sound processing technology that produces immersive 5.1 surround sound with just two front speakers.																						
Treble	Controls the dominant sounds in the output. When you turn up the treble, it will increase the output to the higher frequency range.																						
Bass	Controls the softer sounds in the output. When you turn up the bass, it will increase the output to the lower frequency range.																						
Reset	Resets the sound mode to the default setting.																						
TV Speaker	Turns on the internal speaker of the TV when using an external Hi-Fi system. You can use the TV speaker as an audio output device even if there is no video input.																						

CHANNEL Settings

- 1 Press **SETTINGS** to access the main menus.
- 2 Press the Navigation buttons to scroll to **CHANNEL** and press **OK**.
- 3 Press the Navigation buttons to scroll to the setting or option you want and press **OK**.
 - To return to the previous level, press **↶ BACK**.
- 4 When you are finished, press **EXIT**.

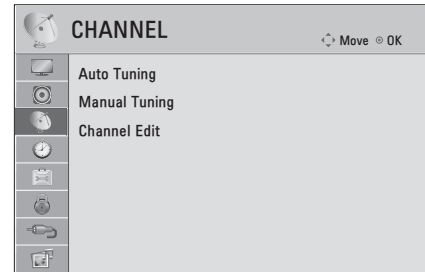

The available channel settings are described in the following.

Setting	Description
Auto Tuning	Tunes and stores all available channels through antennas or cable inputs (See p.22).
Manual Tuning	Tunes and stores the channels you want manually (See p.22).
Channel Edit	Adds or deletes channels on the channel (See p.23).

TIME Settings

- 1 Press **SETTINGS** to access the main menus.
- 2 Press the Navigation buttons to scroll to **TIME** and press **OK**.
- 3 Press the Navigation buttons to scroll to the setting or option you want and press **OK**.
- To return to the previous level, press **BACK**.
- 4 When you are finished, press **EXIT**.

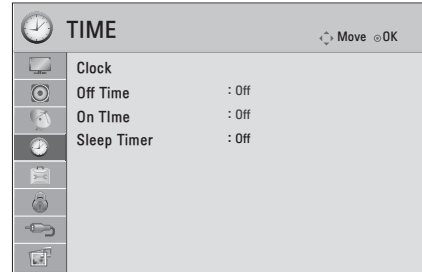

The available time settings are described in the following

Setting	Description
Clock	Sets the time, date, time zone, and daylight-saving time feature. The time will be set automatically according to a digital channel signal which includes time information provided by the broadcasting station. If not, set the time and date manually.
Off Time/On Time	Sets the time to turn on or off the TV automatically. To use this function, you should set the current time and date in advance. <div style="border: 1px solid black; padding: 5px;"> <p>NOTE</p> <ul style="list-style-type: none"> If you do not press any button within 2 hours after the TV turns on by the On Time feature, the TV will enter Standby mode automatically. If you set both Off time and On time features to the same time, the Off time feature overrides the On time feature. </div>
Sleep Timer	Sets the length of time until the TV to turns off. When you turn the TV off and turn it on again, the Sleep timer feature will be set to off.

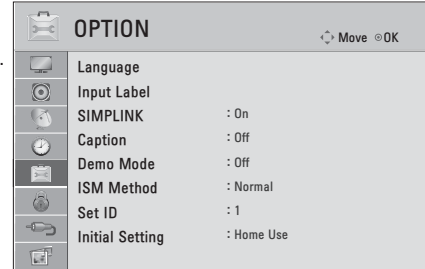

OPTION Settings

- 1 Press **SETTINGS** to access the main menus.
- 2 Press the Navigation buttons to scroll to **OPTION** and press **OK**.
- 3 Press the Navigation buttons to scroll to the setting or option you want and press **OK**.
 - To return to the previous level, press **↶ BACK**.
- 4 When you are finished, press **EXIT**.



The available general settings are described in the following.

Setting	Description
Language	Selects a desired language.
	Option
	Menu Language Selects a language for the display text.
	Audio Language Selects an audio language for your program. This feature operates only in the DTV or CADTV mode.
Input Label	Indicates which device is connected to which input port.
SIMPLINK	Use the TV remote control to play and control the AV device connected with the HDMI cable through HDMI-CEC.
Demo Mode	Shows special features of the TV. You can cancel the demo mode by pressing any button.
Caption	Sets whether to display captions and customize your option in each mode.
	Mode
	CC 1-4 (Closed Captioning) Displays the audio portion of a TV program as text on the TV screen. CC1 is the most common mode in use.
	Text 1-4 - Field 1 data channels: two Captions (CC1, CC2) and two Text (T1, T2). - Field 2 data channels: two Captions (CC3, CC4) and two Text (T3, T4).
	Service 1-6 This is only available for the digital broadcasting system.
	Option (For DTV, CADTV)
	Size Selects the word size.
	Font Selects a typeface for the text.
	Text Color Selects a color for the text.
	Text Opacity Adjusts the opacity for the text color.
	Bg Color Selects a background color.
	Bg Opacity Adjusts the opacity for the background color.
	Edge Type Selects an edge type.
Edge Color Selects a color for the edges.	

Setting	Description
ISM Method	Prevents image sticking or removes a ghost image. A frozen still picture displayed on the screen for prolonged periods can result in a ghost image.
	Mode
	Normal Use this setting if you are careful not to leave a stationary image on the screen for long periods of time.
	Orbiter Avoids a ghost image on the screen. The image will move every 2 minutes to help prevent ghost images. However, it is best not to allow any fixed image to remain on the screen.
Color Wash Removes a ghost image on the screen. The color block with the screen moved a little and the white pattern are alternately displayed. It is difficult to see the after image on all colors. Once it has been corrected it will not be visible in any color.	
Set ID	Adds an ID to the connected devices.
Initial Setting	Resets the TV to factory default and erases all stored channels. Customizes the TV settings to suit your preference. The initial setup screen will appear when you turn on the TV for the first time.
	 NOTE <ul style="list-style-type: none"> When selecting "Lock System - On" in the LOCK menu, the message to enter the password appears. If you forget your password, press "0-3-2-5" on the remote control.
	Setting
	Language Selects a desired language.
	Mode Setting Selects Home Use for the home environment. Selects Store Demo for the retail environment. Selects Demo Mode to set to show special features of the TV. You can cancel the demo mode by pressing any buttons.
 NOTE <ul style="list-style-type: none"> When selecting Store Demo, Demo Mode will be activated. 	
Time Setting Sets the time zone and daylight savings.	
Auto Tuning Scans and saves available channels automatically.	

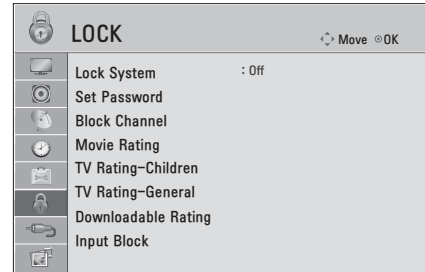

LOCK Settings

- 1 Press **SETTINGS** to access the main menus.
- 2 Press the Navigation buttons to scroll to **LOCK** and press **OK**.
- 3 Press the Navigation buttons to scroll to the setting or option you want and press **OK**.
 - To return to the previous level, press **↶ BACK**.
- 4 When you are finished, press **EXIT**.



The available lock settings are described in the following.

Setting	Description	
Lock System	Activates or deactivates the lock system.	
Set Password	Changes the 4-digit password. The default PIN is "0 0 0 0". If you forget your password, press "0-3-2-5" on the remote control.	
Block Channel	Blocks channels that contain inappropriate content for children by pressing the Blue button. The Lock icon appears in front of the blocked channels. The channels can be selected but the screen is blanked and the audio is muted. To watch a locked channel, enter the password.	
Movie Rating	Blocks the movies that are only broadcasted on the TV and contain inappropriate contents, based on the Motion Picture Association of America (MPAA) rating.	
	Rating	
	G	General audiences – All ages admitted
	PG	Parental guidance suggested – Some material may not be suitable for children
	PG-13	Parents strongly cautioned – Some material may be inappropriate for children under 13
	R	Restricted – Under 17 requires accompanying parent or adult guardian
	NC-17	No one 17 and under admitted
	X	Adults only
Blocking Off	Permits all programs	
TV Rating-Children (Depending on model)	Blocks programs that parents do not want their children to watch. To block other TV programs, you should set the TV Rating-General feature.	
	Rating	
	Age	TV-Y (All children, including children from ages 2-6) TV-Y7 (Directed to older children, suitable for children age 6 and above)
Fantasy Violence	TY-Y7 (Directed to older children – Fantasy violence, suitable for children age 6 and above, containing more intense or combative fantasy violence)	

Setting	Description	
TV Rating- General (Depending on model)	Blocks the TV programs based on the ratings by using the Parental Control Function (V-Chip).  NOTE • The V-Chip electronically reads TV program ratings and allows parents to block programs that are unsuitable for children.	
	Rating	
	Age	TV-G (General audience, suitable for all ages) TV-PG (Parental guidance suggested, containing material that are unsuitable for younger children) TV-14 (Parents strongly cautioned, containing material that are unsuitable for children age 14 and under) TV-MA (Mature audience only, unsuitable for children age under 17)
	Dialog (suggestive dialogue)	TV-PG or TV-14
	Language (coarse language)	TV-PG, TV-14, or TV-MA
	Sex (sexual situation)	TV-PG, TV-14, or TV-MA
	Violence	TV-PG, TV-14, or TV-MA
TV Rating- English (Depending on model)	Selecting Canadian English rating system.	
	Rating	
	E	Exempt
	C	Children
	C8+	Children eight years and older
	G	General programming, suitable for all audiences
	PG	Parental Guidance
	14+	Viewers 14 years and older
	18+	Adult programming
Blocking Off	Permits all programs	
TV Rating- French (Depending on model)	Selecting Canadian French rating system.	
	Rating	
	E	Exempt
	G	General
	8ans+	General-Not convenient for little children
	13ans+	Not convenient for children of 13 years and younger
	16ans+	Not convenient for children of 16 years and younger
	18ans+	This programs is only for adults
Blocking Off	Permits all programs	
Downloadable Rating	This function operates only when the TV has received Region 5 Rating data. The name of the rating option may differ.  NOTE • This feature is available only for digital channels.	
Input Block	Blocks the input sources.	

MAKING CONNECTIONS

You can connect various external devices to the TV. Supported external devices are: HD receivers, DVD players, VCRs, audio systems, USB storage devices, PC, gaming devices, and other external devices. For more information on external device's connection, refer to the manual provided with each device.

! NOTE

- If you record a TV program on a DVD recorder or VCR, make sure to connect the TV signal input cable to the TV through a DVD recorder or VCR. For more information on recording, refer to the manual provided with the connected device.
- The external device connections show may differ from the model.
- Connect external devices to the TV regardless of the order of the TV port.
- If you connect a gaming device to the TV, use the cable supplied with the gaming device.
- Refer to the external equipment's manual for operating instructions.

Connecting to an antenna or cable

Connect an antenna, cable, or cable box to watch TV while referring to the following. The illustrations may differ from the actual items and a RF cable is optional.

ENGLISH

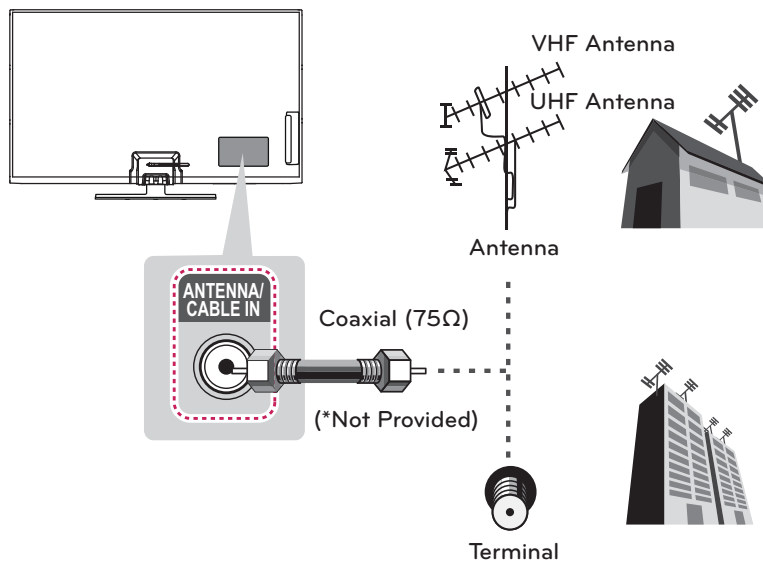

! CAUTION

- Make sure not to bend the copper wire of the RF cable.

Copper wire

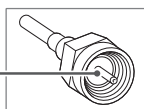

- Complete all connections between devices, and then connect the power cord to the power outlet to prevent damage to your TV.

! NOTE

- Use a signal splitter to use more than 2 TVs.
- Visit <http://lgknowledgebase.com> for more information about the antenna and cable connection. Search for antenna.
- DTV Audio Supported Codec: MPEG, Dolby Digital

Connection Overview

Connect various external devices to the ports on the TV back panel.

- 1 Find an external device you want to connect to your TV as shown on the following illustration.
- 2 Check the connection type of the external device.
- 3 Go to the appropriate illustration and check the connection details.

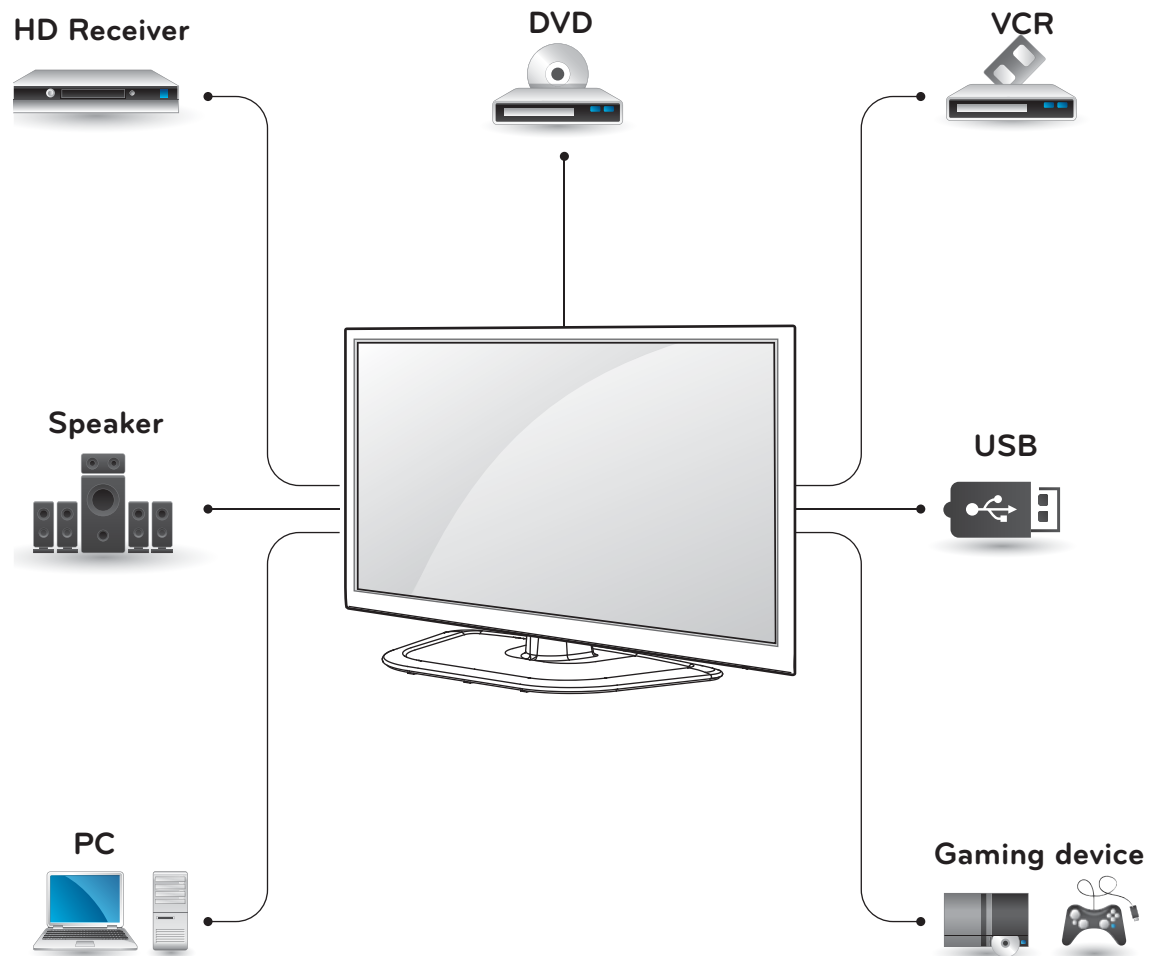

Connecting to a HD receiver, DVD Player or VCR

Connect a HD receiver, DVD Player or VCR to the TV and select an appropriate input mode.

HDMI Connection

HDMI is the best way to connect a device.

Transmits digital video and audio signals from an external device to the TV. Connect the external device and the TV with the HDMI cable as shown in the following illustration.

NOTE

- Use the latest High Speed HDMI™ Cable that supports CEC (Customer Electronics Control) function.
- High Speed HDMI™ Cables are tested to carry an HD signal up to 1080p and higher.
- HDMI Audio Supported Format: PCM (Up to 192 KHz, 32k/ 44.1k/ 48k/ 96k/ 192k)
-> Not supported DTS.

ENGLISH

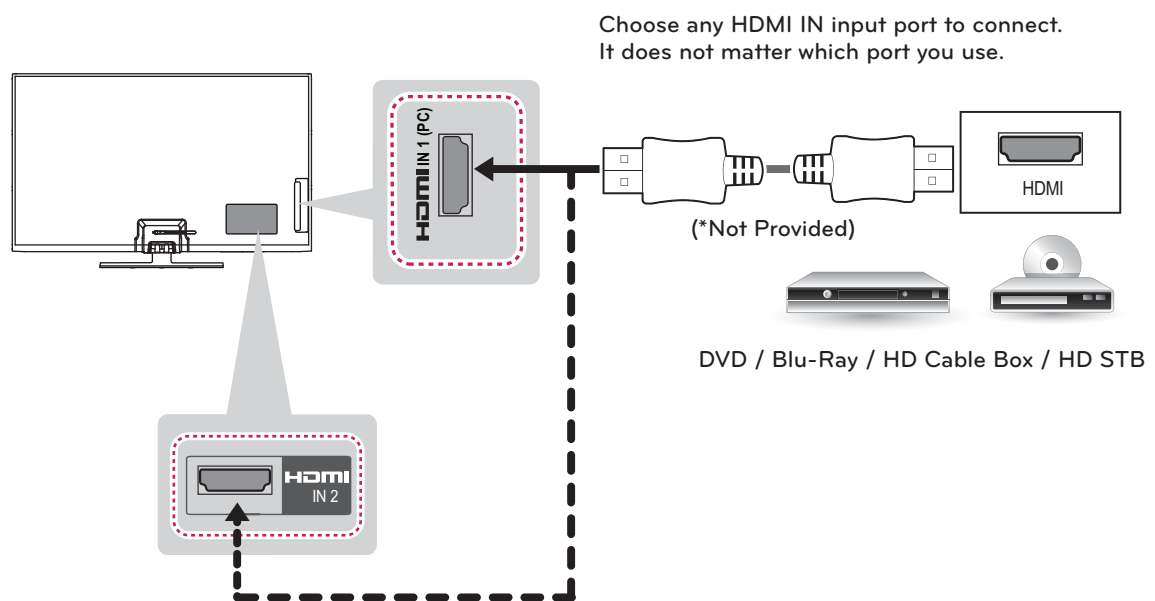

DVI to HDMI Connection

Transmits the digital video signal from an external device to the TV. Connect the external device and the TV with the DVI-HDMI cable as shown in the following illustration. To transmit an audio signal, connect an audio cable.

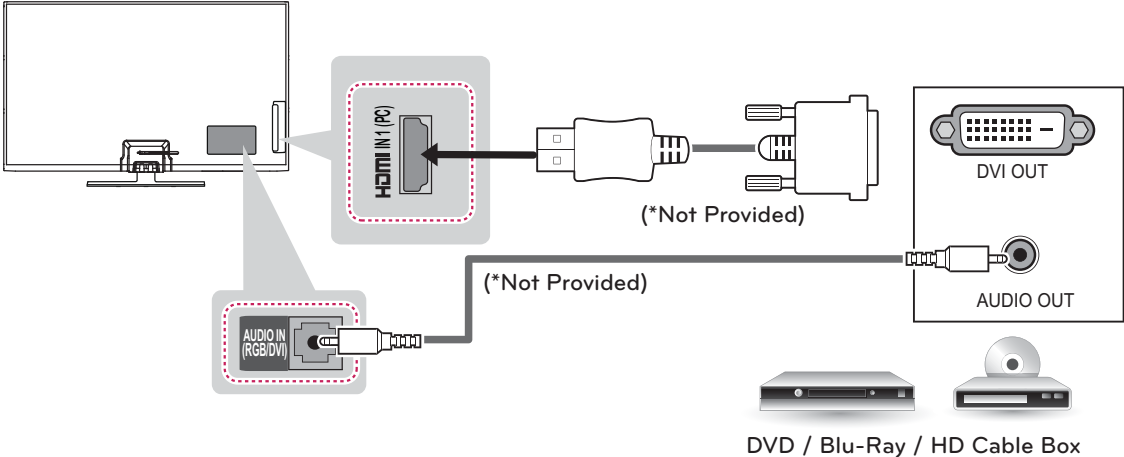

Component Connection

Transmits the analog video and audio signals from an external device to the TV. Connect the external device and the TV with the component cable as shown in the following illustration.

NOTE

- If cables are installed incorrectly, it could cause the image to display in black and white or with distorted color.
- **Check to ensure each cable is matched with the corresponding color connection.**

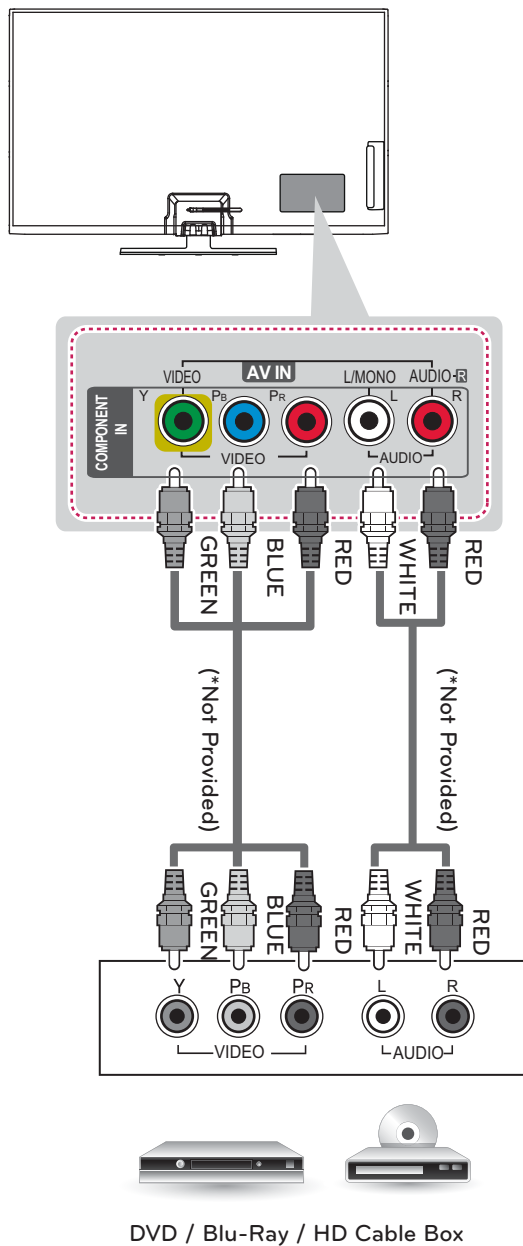

ENGLISH

Composite Connection

Transmits the analog video and audio signals from an external device to the TV. Connect the external device and the TV with the composite cable as shown in the following illustration.

- NOTE** If you have a mono VCR, connect the audio cable from the VCR to the AUDIO L/MONO jack of the TV.

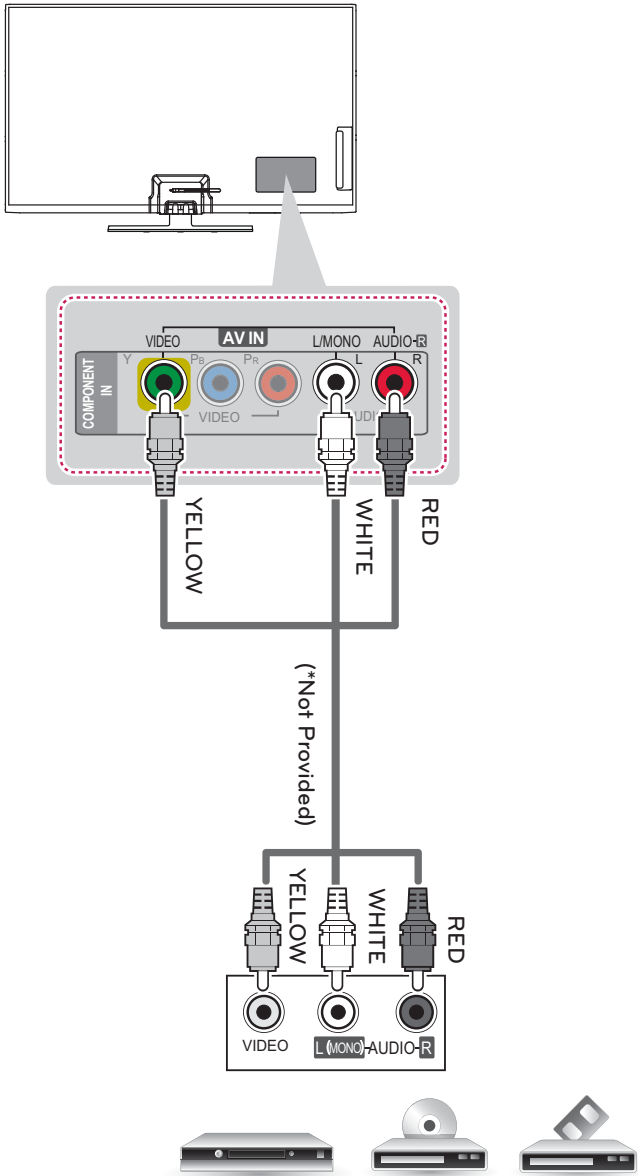

VCR / DVD / Blu-Ray / HD Cable Box

Connecting to a PC

NOTE

- It is recommended to use an HDMI connection for the best image quality.
- Depending on the graphics card, DOS mode may not work if a HDMI to DVI Cable is in use.
- In PC mode, there may be noise associated with the resolution, vertical pattern, contrast or brightness. If noise is present, change the PC output to another resolution, change the refresh rate to another rate or adjust the brightness and contrast on the PICTURE menu until the picture is clear.
- The synchronization input form for Horizontal and Vertical frequencies is separate.
- Depending on the graphics card, some resolution settings may not allow the image to be positioned on the screen properly.

HDMI Connection or DVI to HDMI Connection

Choose method A or B to make connection.

Method A: HDMI Connection

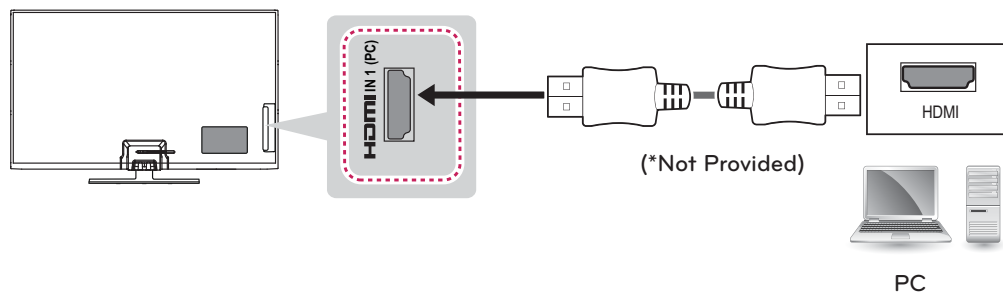

Method B: DVI to HDMI Connection

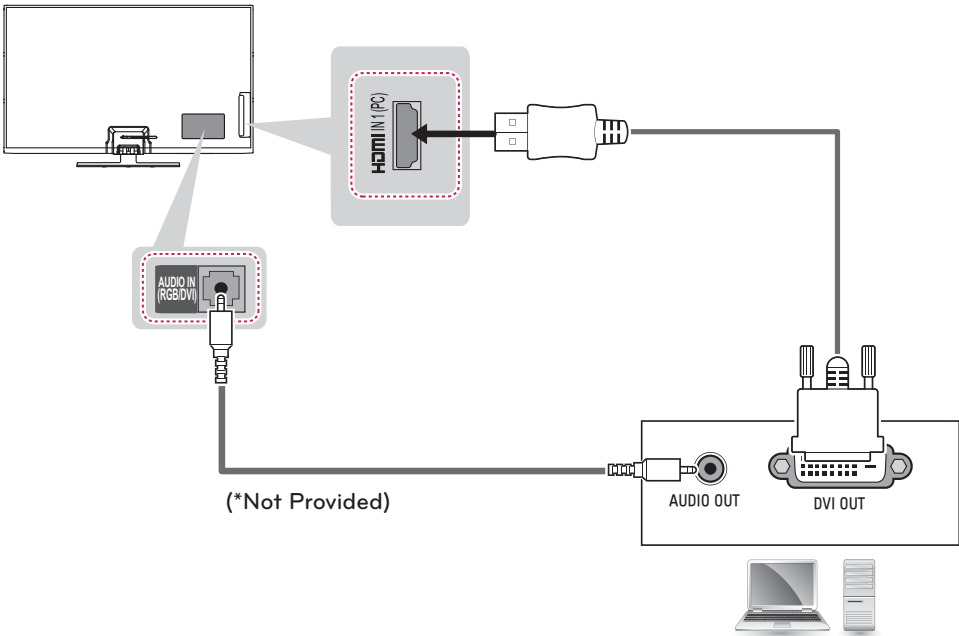

Method C: RGB Connection

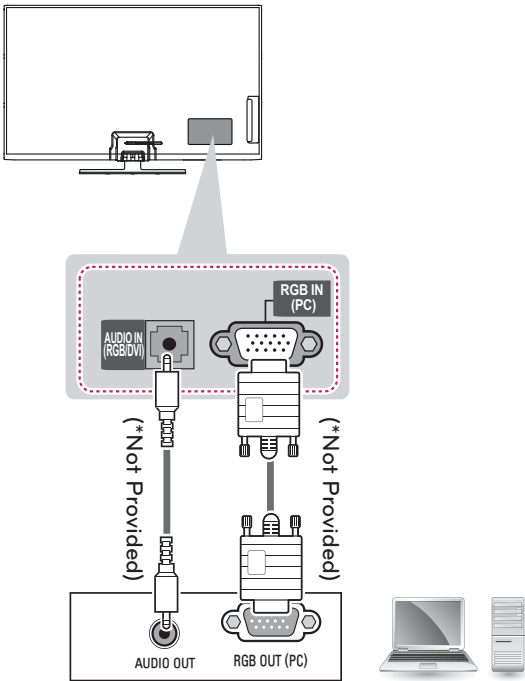

Connecting to an Audio System

You can use an optional external audio system instead of the built-in speaker.

NOTE

- If you use an optional external audio device instead of the built-in speaker, set the TV speaker feature to off.

Digital Optical Audio Connection

Transmits the digital audio signal from the TV to an external device. Connect the external device and the TV with the optical audio cable as shown in the following illustration.

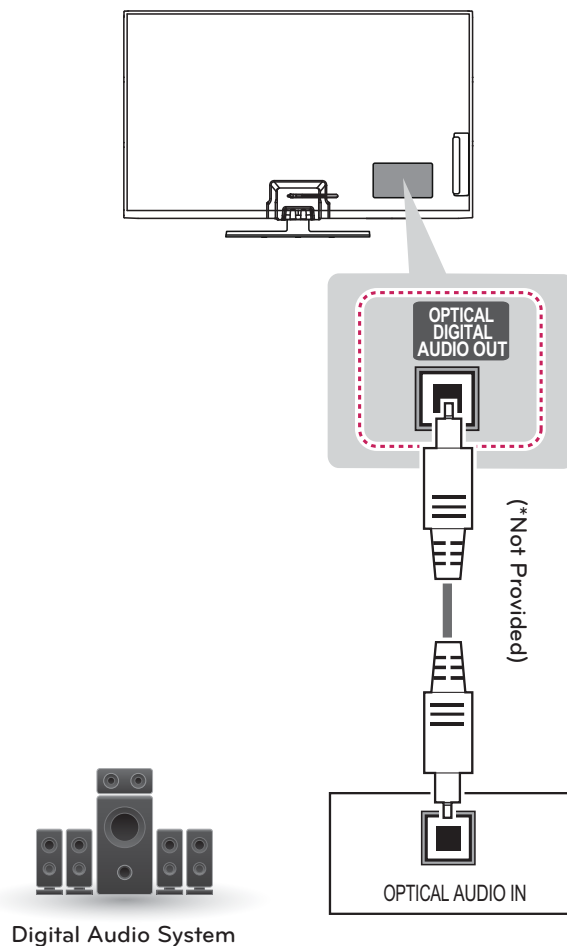

Connecting a USB Device

Connect a USB storage device such as a USB flash memory, external hard drive, or a USB memory card reader to the TV and access the USB menu to use various multimedia files.

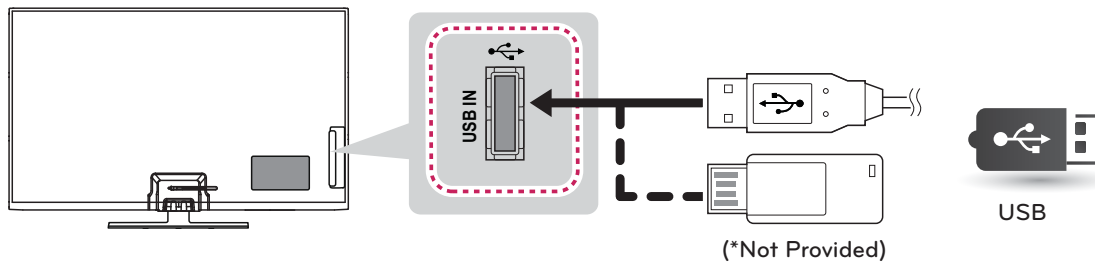

SIMPLINK Connection

Use the TV remote control to play and control the AV device connected with the HDMI cable through HDMI-CEC. Your TV only works with the devices that support HDMI-CEC. But only devices with the **SIMPLINK** logo are fully supported.

Connect one end of the HDMI cable to the HDMI IN terminal on the rear of the TV and the other end to the SIMPLINK device.

NOTE

- If the connected device does not support HDMI-CEC, the SIMPLINK feature is unavailable.
- To operate SIMPLINK, you should use a High Speed HDMI cable that supports CEC (Consumer Electronics Control) function.
- SIMPLINK may not work properly with third-party devices.

Activating and Using the SIMPLINK menus

- 1 Press **SIMPLINK** to access the SIMPLINK menus.
- 2 Press the Navigation buttons to scroll to one of the devices and press **OK**.

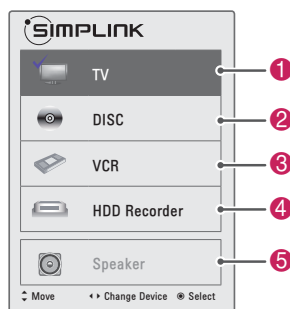

No.	Description
1	Displays the previously viewed TV channel.
2	Plays discs. When multiple discs are available, the title of the disc appears at the bottom of the screen.
3	Controls the connected VCR.
4	HDD recordings playback: Controls the recording stored in HDD.
5	Changes the audio output between Home theater speaker and TV speaker.

- A check mark appears in front of the selected device.
- Available devices display in a bright color.
- Unavailable devices display in grey.

3 Control the selected AV device.

- Direct Play: After connecting AV devices to the TV, you can directly control the devices and play media without additional settings.
- Select AV device: Enables you to select one of the AV devices connected to the TV.
- Disc playback: Control connected AV devices by pressing the Navigation buttons, **OK**, **▶**, **■**, **⏪**, **◀** and **▶▶**.
- Power off all devices: When you power off the TV, all connected devices are turned off.
- Switch audio-out: Offers an easy way to switch audio-out.
- Sync Power on: When the equipment with SIMPLINK function connected HDMI terminal starts to play, The TV will automatically turn on.

NOTE

- If you change the input source by pressing **INPUT**, the progressing function of the SIMPLINK device will stop.
- If you select a device that has the home theater feature, the sound output automatically switches to the home theater speaker and the TV speaker turns off.
- If a connected SIMPLINK home theater system does not play the audio from the TV, connect the DIGITAL AUDIO OUT terminal on the rear of the TV to the DIGITAL AUDIO IN terminal on the back of the SIMPLINK device with an optical cable.

MAINTENANCE

Cleaning Your TV

Clean your TV regularly to keep it at peak performance and to extend the product lifespan.



CAUTION

- Before Cleaning, turn the power off and disconnect the power cord and all other cables.
- When the TV is left unattended and unused for a long time, disconnect the power cord from the wall outlet to prevent possible damage from lightning or power surges.

Screen, frame, cabinet and stand

To remove dust or light dirt, wipe the surface with a dry, clean, and soft cloth.

To remove major dirt, wipe the surface with a soft cloth dampened in clean water or a diluted mild detergent. Then wipe immediately with a dry cloth.



CAUTION

- Do not push, rub, or hit the surface with your fingernail or a sharp object, as this may result in scratches on the screen and image distortions.
- Do not use any chemicals, such as waxes, benzene, alcohol, thinners, insecticides, air fresheners, lubricants, as these may damage the screen's finish and cause discoloration.
- Do not spray liquid onto the surface. If water enters the TV, it may result in fire, electric shock, or malfunction.

Power cord

Remove the accumulated dust or dirt on the power cord regularly.

TROUBLESHOOTING

General

Problem	Solution
Cannot control the TV with the remote control.	<ul style="list-style-type: none"> • Check the remote control sensor on the product and try again. • Check if there is any obstacle between the product and the remote control. • Check if the batteries are still working and properly installed (⊕ to ⊕, ⊖ to ⊖).
No image display and no sound is produced.	<ul style="list-style-type: none"> • Check if the product is turned on. • Check if the power cord is connected to a wall outlet. • Check if there is a problem in the wall outlet by connecting other products.
Image appears slowly when the TV turns on.	<ul style="list-style-type: none"> • The image is muted during the product startup process. This is normal. If the image does not appear in a few minutes, unplug the TV for 30 seconds and try again. If the image still does not appear, contact the authorized service center in your local area.
Cannot connect external devices.	<ul style="list-style-type: none"> • Refer to the "Connection Overview" and connect an external device.
The TV turns off suddenly.	<ul style="list-style-type: none"> • Check the power control settings. The power supply may be interrupted. • Check if the Auto sleep feature is activated in the Time settings. Refer to the "Sleep Timer". • If there is no signal while the TV is on, the TV will turn off automatically after 15 minutes of inactivity.

ENGLISH

Audio

Problem	Solution
No sound is produced while images are displaying.	<ul style="list-style-type: none"> • Press VOL + or - button. • Check if the sound is muted by pressing MUTE. • Scroll to other channels. There may a problem with the broadcast. • Check if the audio cables are connected properly. • Check if the TV Speaker feature is activated in the menu option.
No output from one of the speakers	<ul style="list-style-type: none"> • Adjust Balance in the menu option.
Unusual sound from inside the TV is produced.	<ul style="list-style-type: none"> • A change in ambient humidity or temperature may result in an unusual noise when the product turns on or off. There is no problem with your product.

Video

Problem	Solution
An image displays in black and white or the color quality is poor.	<ul style="list-style-type: none"> Adjust the color setting in the menu option. Keep a sufficient distance between this product and other electronic products. Scroll to other channels. There may a problem with the broadcast.
Horizontal or vertical bars appears or images blur	<ul style="list-style-type: none"> Check if there are local interferences such as an electrical appliance or power tool.
Lines or streaks appear on images	<ul style="list-style-type: none"> Check the antenna or aim the antenna to the proper direction.
Afterimages (ghosts) appear when the product turns off	<ul style="list-style-type: none"> Pixels may have been damaged from a fixed image displayed for a long time (image burn). Use a screen saver to prevent the pixel damage on the screen.
The power is on but the screen appears extremely dark.	<ul style="list-style-type: none"> Adjust the brightness and contrast in the menu option.
"No Signal" appears on the screen.	<ul style="list-style-type: none"> Check if the signal cable is connected between the TV and products properly. Check the selected input source by pressing INPUT.
Black spots appear on the screen.	<ul style="list-style-type: none"> Several pixels in red, green, white, or black may appear on the screen that can attribute to the characteristics of the panel. This is normal.
The display offset is wrong.	<ul style="list-style-type: none"> Adjust the position setting in the Picture menu. Check if the video card resolution and frequency are supported by the product. If the frequency is out of range, set to the recommended resolution using the display settings on the external device.
Thin lines appear in the background of the screen.	<ul style="list-style-type: none"> Check the video cable connections.
Horizontal noises appear or characters blur.	<ul style="list-style-type: none"> Adjust the Phase setting in the menu option. Refer to the "SCREEN (RGB-PC)".
The reception on some channels is poor	<ul style="list-style-type: none"> Scroll to other channels. There may a problem with the broadcast. The station signal may be weak. Aim the antenna to the proper direction. Check if there is local interferences such as an electrical appliance or power tool.

EXTERNAL CONTROL DEVICE SETUP

To obtain the external control device setup information, please visit 'www.lg.com'.

SPECIFICATIONS

Product specifications may be changed without prior notice due to upgrade of product functions.

Power requirement	AC100 - 240 V ~ 50/60 Hz	
Television System	NTSC-M, ATSC, 64 & 256 QAM	
Program Coverage	VHF 2-13, UHF 14-69, CATV 1-135, DTV 2-69, CADTV 1-135	
External Antenna Impedance	75 Ω	
Environment condition	Operating Temperature	0 - 40 °C
	Operating Humidity	Less than 80 %
	Storage Temperature	-20 - 60 °C
	Storage Humidity	Less than 85 %

MODELS		42PN450H (42PN450H-UA)	50PN450H (50PN450H-UA)
Dimensions (W x H x D)	With stand	983.6 x 650.3 x 250.0 (mm)	1,168.0 x 755.4 x 292.7 (mm)
		38.7 x 25.6 x 9.8 (inch)	45.9 x 29.7 x 11.5 (inch)
	Without stand	983.6 x 595.6 x 57.0 (mm)	1,168.0 x 698.6 x 57.0 (mm)
		38.7 x 23.4 x 2.2 (inch)	45.9 x 27.5 x 2.2 (inch)
Weight	With stand	19.6 kg (43.2 lbs)	25.4 kg (55.9 lbs)
	Without stand	18.4 kg (40.5 lbs)	24.0 kg (52.9 lbs)
Current Value / Power consumption		2.1 A / 210 W	2.75 A / 275 W

ENGLISH

MODELS		50PN530H (50PN530H-UF)	60PN530H (60PN530H-UF)
Dimensions (W x H x D)	With stand	1,168.0 x 755.4 x 292.7 (mm)	1,386.8 x 874.0 x 340.0 (mm)
		45.9 x 29.7 x 11.5 (inch)	54.5 x 34.4 x 13.3 (inch)
	Without stand	1,168.0 x 698.6 x 57.0 (mm)	1,386.8 x 821.7 x 57.0 (mm)
		45.9 x 27.5 x 2.2 (inch)	54.5 x 32.3 x 2.2 (inch)
Weight	With stand	26.1 kg (57.5 lbs)	37.7 kg (83.1 lbs)
	Without stand	24.7 kg (53.7 lbs)	34.5 kg (76.0 lbs)
Current Value / Power consumption		2.9 A / 290 W	3.9 A / 390 W

RGB (PC), HDMI (PC) supported mode

Resolution	Horizontal Frequency (KHz)	Vertical Frequency (Hz)
720x400	31.469	70.08
640x350	31.468	70.09
640x480	31.469	59.94
800x600	37.879	60.31
1024x768	48.363	60.00
1360x768	47.712	60.015
1280x1024 HDMI-PC	63.981	60.02
1920x1080	67.5	60.00

For 50/60PN530H

HDMI (DTV) supported mode

Resolution	Horizontal Frequency (KHz)	Vertical Frequency (Hz)
720x480p	31.47 31.50	59.94 60.00
1280x720p	44.96 45.00	59.94 60.00
1920x1080i	33.72 33.75	59.94 60.00
1920x1080p	26.97 27.00 33.71 33.75 67.432 67.50	23.976 24.00 29.97 30.00 59.94 60.00

Component port connecting information

Component ports on the TV	Y	P _B	P _R
---------------------------	---	----------------	----------------

Video output ports on DVD player	Y	P _B	P _R
	Y	B-Y	R-Y
	Y	Cb	Cr
	Y	Pb	Pr

Component supported mode

Resolution	Horizontal Frequency (KHz)	Vertical Frequency (Hz)
720x480i	15.73 15.73	59.94 60.00
720x480p	31.47 31.50	59.94 60.00
1280x720p	44.96 45.00	59.94 60.00
1920x1080i	33.72 33.75	59.94 60.00
1920x1080p	26.97 27.00 33.71 33.75 67.432 67.50	23.976 24.00 29.97 30.00 59.94 60.00



The model and serial numbers of the TV is located on the back of the TV
Record it below should you ever need service.

MODEL _____

SERIAL _____