



LCD TV OWNER'S MANUAL

37LG50
42LG50
47LG50
52LG50

42LG50DC
47LG50DC
52LG50DC

42LG55
47LG55

Please read this manual carefully before operating your set.

Retain it for future reference.

Record model number and serial number of the set.

See the label attached on the back cover and quote this information to your dealer when you require service.

An extended owner's manual that contains information on the advanced features of these LG TV sets is located on the CD-ROM provided in an electronic version.

To read these files, you will need to use personal computer (PC) equipped with a CD-ROM drive.

P/NO : MFL34797082 (0810-REV03)
Printed in Korea

WARNING / CAUTION



WARNING / CAUTION
RISK OF ELECTRIC SHOCK
DO NOT OPEN



TO REDUCE THE RISK OF ELECTRIC SHOCK
DO NOT REMOVE COVER (OR BACK). NO
USER SERVICEABLE PARTS INSIDE. REFER TO
QUALIFIED SERVICE PERSONNEL.



The lightning flash with arrowhead symbol, within an equilateral triangle, is intended to alert the user to the presence of uninsulated “dangerous voltage” within the product’s enclosure that may be of sufficient magnitude to constitute a risk of electric shock to persons.



The exclamation point within an equilateral triangle is intended to alert the user to the presence of important operating and maintenance (servicing) instructions in the literature accompanying the appliance.

WARNING/CAUTION

TO REDUCE THE RISK OF FIRE AND ELECTRIC SHOCK, DO NOT EXPOSE THIS PRODUCT TO RAIN OR MOISTURE.

NOTE TO CABLE/TV INSTALLER

This reminder is provided to call the CATV system installer’s attention to Article 820-40 of the National Electric Code (U.S.A.). The code provides guidelines for proper grounding and, in particular, specifies that the cable ground shall be connected to the grounding system of the building, as close to the point of the cable entry as practical.

WARNING / CAUTION

To prevent fire or shock hazards, do not expose this product to rain or moisture.

FCC NOTICE

Class B digital device

This equipment has been tested and found to comply with the limits for a Class B digital device, pursuant to Part 15 of the FCC Rules. These limits are designed to provide reasonable protection against harmful interference in a residential installation. This equipment generates, uses and can radiate radio frequency energy and, if not installed and used in accordance with the instructions, may cause harmful interference to radio communications. However, there is no guarantee that interference will not occur in a particular installation. If this equipment does cause harmful interference to radio or television reception, which can be determined by turning the equipment off and on, the user is encouraged to try to correct the interference by one or more of the following measures:

- Reorient or relocate the receiving antenna.
- Increase the separation between the equipment and receiver.
- Connect the equipment to an outlet on a circuit different from that to which the receiver is connected.
- Consult the dealer or an experienced radio/TV technician for help.

Any changes or modifications not expressly approved by the party responsible for compliance could void the user’s authority to operate the equipment.

CAUTION

Do not attempt to modify this product in any way without written authorization from LG Electronics. Unauthorized modification could void the user’s authority to operate this product

SAFETY INSTRUCTIONS

IMPORTANT SAFETY INSTRUCTIONS

Read these instructions.
Keep these instructions.
Heed all warnings.
Follow all instructions.



- 1 Do not use this apparatus near water.



- 2 Clean only with dry cloth.



- 3 Do not block any ventilation openings. Install in accordance with the manufacturer's instructions.

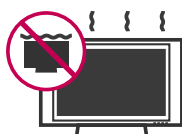

- 4 Do not install near any heat sources such as radiators, heat registers, stoves, or other apparatus (including amplifiers) that produce heat.



- 5 Do not defeat the safety purpose of the polarized or grounding-type plug. A polarized plug has two blades with one wider than the other. A grounding type plug has two blades and a third grounding prong. The wide blade or the third prong are provided for your safety. If the provided plug does not fit into your outlet, consult an electrician for replacement of the obsolete outlet.



- 6 Protect the power cord from being walked on or pinched particularly at plugs, convenience receptacles, and the point where they exit from the apparatus.



- 7 Only use attachments/accessories specified by the manufacturer.



- 8 Use only with the cart, stand, tripod, bracket, or table specified by the manufacturer, or sold with the apparatus. When a cart is used, use caution when moving the cart/apparatus combination to avoid injury from tip-over.



- 9 Unplug this apparatus during lightning storms or when unused for long periods of time.

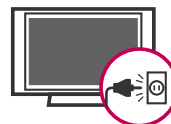

- 10 Refer all servicing to qualified service personnel. Servicing is required when the apparatus has been damaged in any way, such as power-supply cord or plug is damaged, liquid has been spilled or objects have fallen into the apparatus, the apparatus has been exposed to rain or moisture, does not operate normally, or has been dropped.

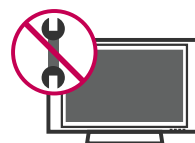

- 11 Never touch this apparatus or antenna during a thunder or lightning storm.

- 12 When mounting a TV on the wall, make sure not to install the TV by the hanging power and signal cables on the back of the TV.

- 13 Do not allow an impact shock or any objects to fall into the product, and do not drop onto the screen with something.

- 14 CAUTION concerning the Power Cord: It is recommend that appliances be placed upon a dedicated circuit; that is, a single outlet circuit which powers only that appliance and has no additional outlets or branch circuits. Check the specification page of this owner's manual to be certain.

Do not connect too many appliances to the same AC power outlet as this could result in fire or electric shock.

SAFETY INSTRUCTIONS

Do not overload wall outlets. Overloaded wall outlets, loose or damaged wall outlets, extension cords, frayed power cords, or damaged or cracked wire insulation are dangerous. Any of these conditions could result in electric shock or fire. Periodically examine the cord of your appliance, and if its appearance indicates damage or deterioration, unplug it, discontinue use of the appliance, and have the cord replaced with an exact replacement part by an authorized servicer. Protect the power cord from physical or mechanical abuse, such as being twisted, kinked, pinched, closed in a door, or walked upon. Pay particular attention to plugs, wall outlets, and the point where the cord exits the appliance.

Do not make the TV with the power cord plugged in. Do not use a damaged or loose power cord. Be sure do grasp the plug when unplugging the power cord. Do not pull on the power cord to unplug the TV.

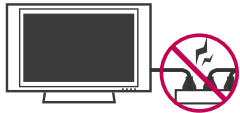

- 15** **WARNING** - To reduce the risk of fire or electrical shock, do not expose this product to rain, moisture or other liquids. Do not touch the TV with wet hands. Do not install this product near flammable objects such as gasoline or candles or expose the TV to direct air conditioning.



- 16** Do not expose to dripping or splashing and do not place objects filled with liquids, such as vases, cups, etc. on or over the apparatus (e.g. on shelves above the unit).



- 17** **GROUNDING**
Ensure that you connect the earth ground wire to prevent possible electric shock (i.e. a TV with a three-prong grounded AC plug must be connected to a three-prong grounded AC outlet). If grounding methods are not possible, have a qualified electrician install a separate circuit breaker.

Do not try to ground the unit by connecting it to telephone wires, lightning rods, or gas pipes.

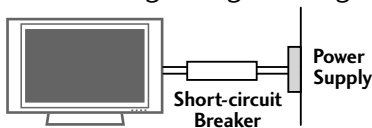

- 18** **DISCONNECTING DEVICE FROM MAINS**
Mains plug is the disconnecting device. The plug must remain readily operable.

- 19** Keep the product away from direct sunlight.

20 **ANTENNAS** **Outdoor antenna grounding**

If an outdoor antenna is installed, follow the precautions below. An outdoor antenna system should not be located in the vicinity of overhead power lines or other electric light or power circuits, or where it can come in contact with such power lines or circuits as death or serious injury can occur.

Be sure the antenna system is grounded so as to provide some protection against voltage surges and built-up static charges.

Section 810 of the National Electrical Code (NEC) in the U.S.A. provides information with respect to proper grounding of the mast and supporting structure, grounding of the lead-in wire to an antenna discharge unit, size of grounding conductors, location of antenna discharge unit, connection to grounding electrodes and requirements for the grounding electrode.

Antenna grounding according to the National Electrical Code, ANSI/NFPA 70

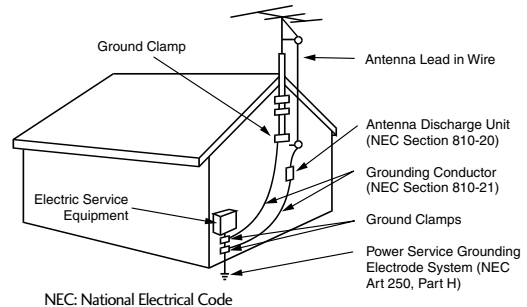

- 21** **Cleaning**
When cleaning, unplug the power cord and scrub gently with a soft cloth to prevent scratching. Do not spray water or other liquids directly on the TV as electric shock may occur. Do not clean with chemicals such as alcohol, thinners or benzene.

- 22** **Moving**
Make sure the product is turned off, unplugged and all cables have been removed. It may take 2 or more people to carry larger TVs. Do not press against or put stress on the front panel of the TV.

- 23** **Ventilation**
Install your TV where there is proper ventilation. Do not install in a confined space such as a bookcase. Do not cover the product with cloth or other materials (e.g.) plastic while plugged in. Do not install in excessively dusty places.

- 24** If you smell smoke or other odors coming from the TV or hear strange sounds, unplug the power cord contact an authorized service center.

- 25** Do not press strongly upon the panel with hand or sharp object such as nail, pencil or pen, or make a scratch on it.

CONTENTS

WARNING / CAUTION	2
SAFETY INSTRUCTIONS	3

PREPARATION

Accessories	6
Front Panel Information	7
Back Panel Information	8
Remote Control Functions	9
Stand Instruction	10
VESA Wall Mounting	11
Cable Management	12
Desktop Pedestal Installation	13
Swivel Stand	13
Attaching the TV to a Desk	13
Securing the TV to the wall to prevent falling when the tv is used on a stand	14
Antenna or Cable Connection	15

EXTERNAL EQUIPMENT SETUP

HD Receiver Setup	16
DVD Setup	17

VCR Setup	18
PC Setup	19

WATCHING TV

Turning On TV	20
Channel Setup	20
Initial Setting	21
Quick Menu / Favorite Channel Setup	22
On-Screen Menus Selection	22

USB

Entry Modes	26
Photo List	27
Music List	29

APPENDIX

Troubleshooting	31
Maintenance	33
Product Specifications	34

HOW TO USE THE OWNER'S MANUAL ON THE CD-ROM

To view the Owner's Manual on the CD-ROM, Adobe Acrobat Reader must be installed on your PC. The "ACRORD" folder on the CD-ROM contains the installation programs for them. If you want to install those programs, Open the "My Computer" → Open the "LG" → Open the "ACRORD" → double-click your language.

TO VIEW THE OWNER'S MANUAL ON THE CD-ROM

The Owner's Manual files are included in the supplied CD-ROM. Load the supplied CD-ROM into the CD-ROM drive of your PC. After a while, the web page of the CD-ROM will open automatically. (for Window only)

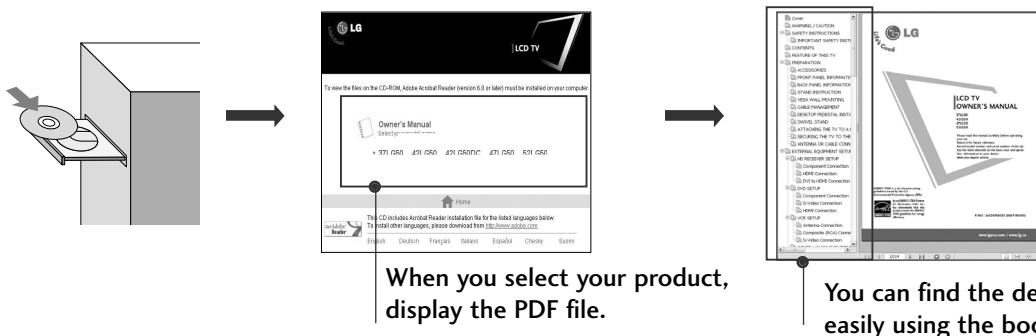

NOTE ▶ If the web page does not appear automatically, open the Owner's Manual file directly. Open the "My computer" → Open the "LG" → Open the "index.htm" file.

FOR LCD TV

- If the TV feels cold to the touch, there may be a small "flicker" when it is turned on. This is normal, there is nothing wrong with TV.
- Some minute dot defects may be visible on the screen, appearing as tiny red, green, or blue spots. However, they have no adverse effect on the monitor's performance.
- Avoid touching the LCD screen or holding your finger(s) against it for long periods of time. Doing so may produce some temporary distortion effects on the screen.

On Disposal (Only Hg lamp used LCD TV)

The fluorescent lamp used in this product contains a small amount of mercury. Do not dispose of this product with general household waste. Disposal of this product must be carried out in accordance to the regulations of your local authority.

PREPARATION

ACCESSORIES

Ensure that the following accessories are included with your TV. If an accessory is missing, please contact the dealer where you purchased the product.

The accessories included may differ from the images below.

For further information, see the the Owner's Manual files supplied CD-ROM.

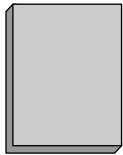

Owner's Manual



CD Manual
(Refer to P.5)

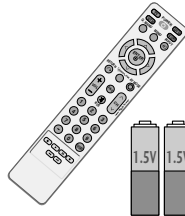

Remote Control,
Batteries

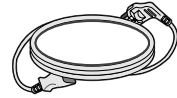

Power Cord

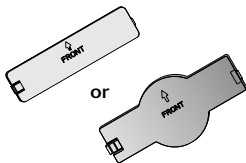

Protection Cover

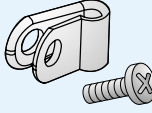

Protective Bracket and Bolt for Power Cord
(This feature is not available for all models.)
(Refer to P.12)

Only 37/42LG5*



Bolts for stand assembly
(Refer to P.10)



Screw for stand fixing
(Refer to P.13)



Polishing Cloth
(This feature is not available for all models.)

- * Wipe spots on the exterior only with the polishing cloth.
- * Do not wipe roughly when removing stain. Excessive pressure may cause scratch or discoloration.

Option Extras

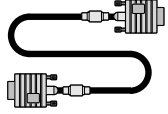

D-sub 15 pin Cable

When using the VGA (D-sub 15 pin cable) PC connection, the user must use shielded signal interface cables with ferrite cores to maintain standards compliance.

FRONT PANEL INFORMATION

- Image shown may differ from your TV.
- **NOTE:** If your TV has a protection tape attached, remove the tape. And then wipe the TV with a cloth (If a polishing cloth is included with your TV, use it).

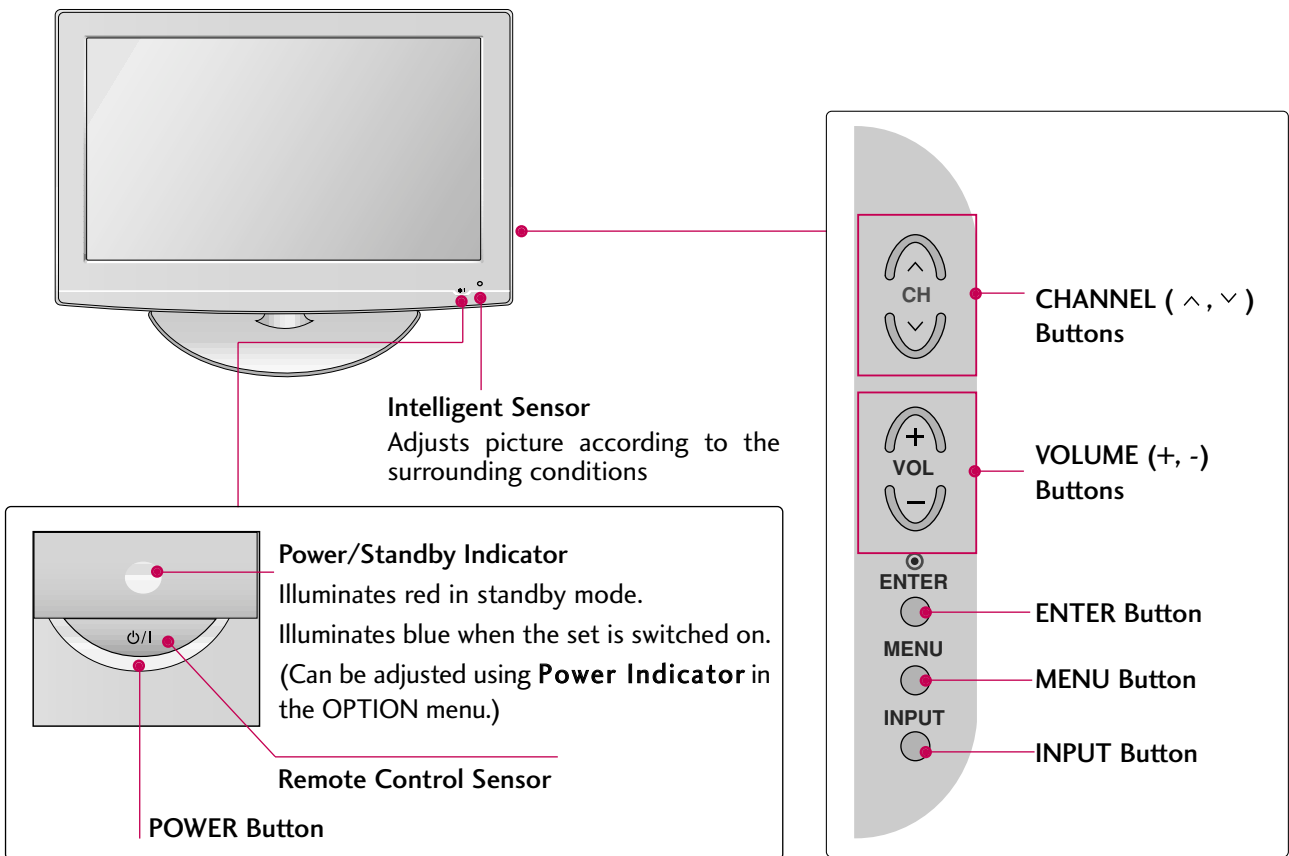

PREPARATION

BACK PANEL INFORMATION

Image shown may differ from your TV.

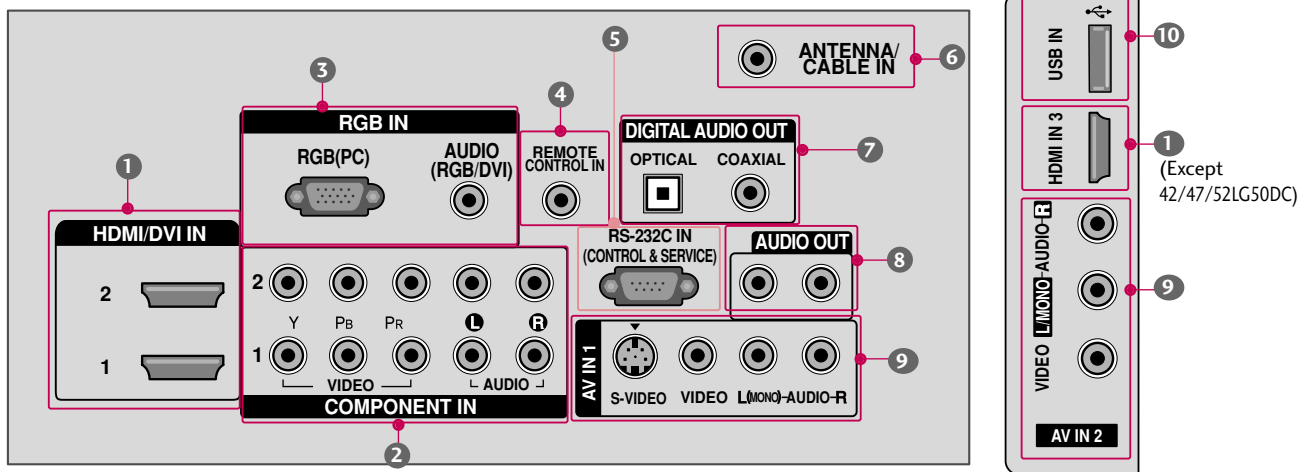
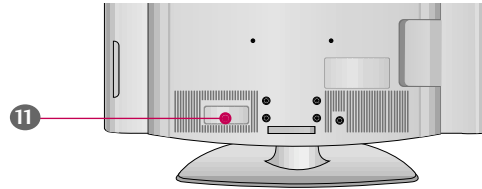

- 1 HDMI/DVI IN, HDMI IN**
 Digital Connection.
 Supports HD video and Digital audio. Doesn't support 480i.
 Accepts DVI video using an adapter or HDMI to DVI cable (not included).
- 2 COMPONENT IN**
 Analog Connection.
 Supports HD.
 Uses a red, green, and blue cable for video & red and white for audio.
- 3 RGB (PC)**
 Analog PC Connection. Uses a D-sub 15 pin cable (VGA cable).
AUDIO (RGB/DVI)
 1/8" headphone jack for analog PC audio input.
- 4 REMOTE CONTROL IN PORT**
 For a wired remote control.
- 5 RS-232C IN (CONTROL & SERVICE) PORT**
 Used by third party devices.
- 6 ANTENNA/CABLE IN**
 Connect over-the air signals to this jack.
 Connect cable signals to this jack.
- 7 DIGITAL AUDIO OUT**
 Digital audio output for use with amps and home theater systems.
 Includes an optical and coaxial connection.
 Note: In standby mode, these ports do not work.
- 8 AUDIO OUT**
 Analog audio output for use with amps and home theater systems.
- 9 AV (Audio/Video) IN**
 Analog composite connection. Supports standard definition video only (480i).
S-VIDEO
 Better quality than standard composition. Supports standard definition video only (480i).
- 10 USB INPUT**
 Used for viewing photos and listening to MP3s.
- 11 Power Cord Socket**
 For operation with AC power.
 Caution: Never attempt to operate the TV on DC power.

REMOTE CONTROL FUNCTIONS

When using the remote control, aim it at the remote control sensor on the TV.

TV/STB/DVD/VCR Select the remote operating mode: TV, STB, DVD, or VCR.

POWER Turns your TV or any other programmed equipment on or off, depending on the mode.

Q.MENU Select the desired quick menu source.

MENU Displays the main menu.
Clear all on-screen displays and return to TV viewing from any menu.

INPUT External input modes rotate in regular sequence.

THUMBSTICK (Up/Down/Left Right/ENTER) Navigate the on-screen menus and adjust the system settings to your preference.

RETURN Allows the user to move return one step in an interactive application or other user interaction function.

SIMPLINK See a list of AV devices connected to TV.
When you toggle this button, the SIMPLINK menu appears at the screen.

AV MODE It helps you select and set images and sounds.

VOLUME UP /DOWN Increase/decrease the sound level.

FAV Scroll through the programmed Favorite channels.

MUTE Switch the sound on or off.

CHANNEL UP/DOWN Select available channels.

PAGE UP/DOWN Move from one full set of screen information to the next one.

NUMBER button

— (DASH) Used to enter a program number for multiple program channels such as 2-1, 2-2, etc.

FLASHBK Tune to the last channel viewed.

VCR/DVD, USB, SIMPLINK Control buttons

- Control video cassette recorders or DVD players.
- Control USB menu (Photo List and Music List.)
- Control the SIMPLINK compatible devices.

Installing Batteries

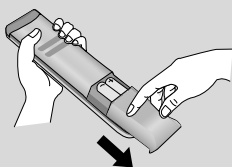

- Open the battery compartment cover on the back side and install the batteries matching correct polarity (+with +,-with -).
- Install two 1.5V AAA batteries. Don't mix old or used batteries with new ones.
- Close cover.

PREPARATION

STAND INSTRUCTION

■ Image shown may differ from your TV.

INSTALLATION (Only 37/42LG5*)

- 1 Carefully place the TV screen side down on a cushioned surface to protect the screen from damage.

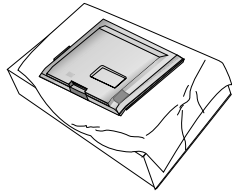

- 2 Assemble the parts of the **STAND BODY** with **COVER BASE** of the TV.

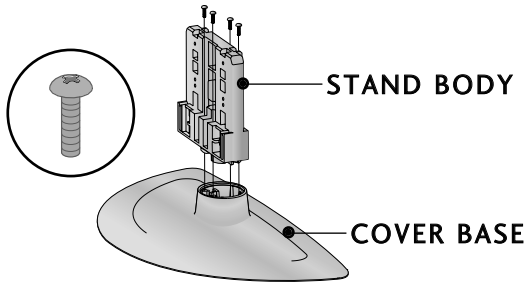

- 3 Assemble the TV as shown.

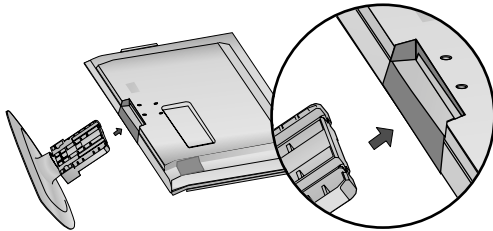

- 4 Fix the 4 bolts securely using the holes in the back of the TV.

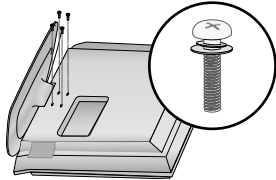

! NOTE

- ▶ When assembling the desk type stand, make sure the bolt is fully tightened. (If not tightened fully, the TV can tilt forward after the product installation). Do not over tighten.

DETACHMENT

- 1 Carefully place the TV screen side down on a cushioned surface to protect the screen from damage.

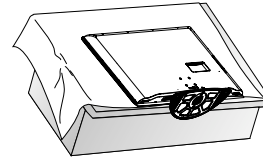

- 2 Loosen the bolts from TV.

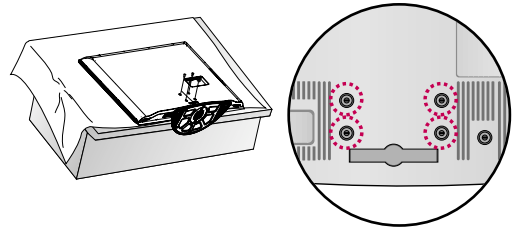

- 3 Detach the stand from TV.

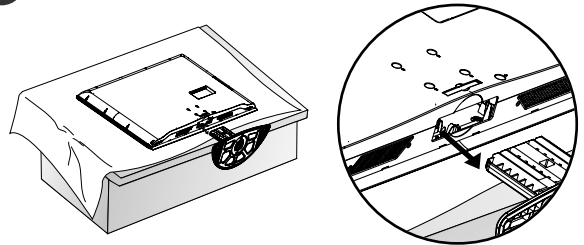

PROTECTION COVER

After removing the stand, install the included **protection cover** over the hole for the stand.

Press the **PROTECTION COVER** into the TV until you hear it click.

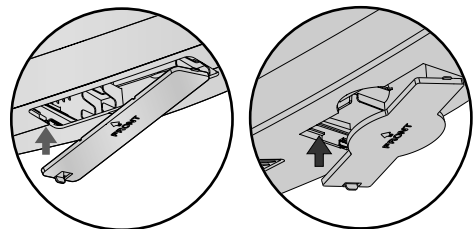
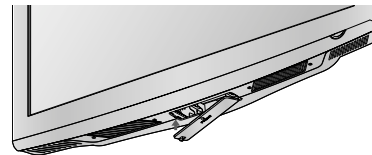

VESA WALL MOUNTING

Install your wall mount on a solid wall perpendicular to the floor. When attaching to other building materials, please contact your nearest dealer.

If installed on a ceiling or slanted wall, it may fall and result in severe personal injury.

We recommend that you use an LG brand wall mount when mounting the TV to a wall.

LG recommends that wall mounting be performed by a qualified professional installer.

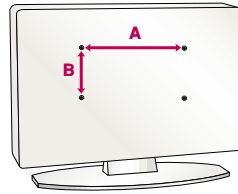

Product	Model	VESA (A * B)	Standard Screw	Quantity
LCD TV	37LG5* 42LG5* 47LG5*	200 * 200	M6	4
	52LG5*	800 * 400	M6	4

! NOTE

- ▶ Screw length needed depends on the wall mount used. For further information, refer to the instructions included with the mount.
- ▶ Standard dimensions for wall mount kits are shown in the table.
- ▶ When purchasing our wall mount kit, a detailed installation manual and all parts necessary for assembly are provided.
- ▶ Do not use screws longer than the standard dimension, as they may cause damage to the inside of the TV.
- ▶ For wall mounts that do not comply with the VESA standard screw specifications, the length of the screws may differ depending on their specifications.
- ▶ Do not use screws that do not comply with the VESA standard screw specifications. Do not use fasten the screws too strongly, this may damage the TV or cause the TV to a fall, leading to personal injury. LG is not liable for these kinds of accidents.
- ▶ LG is not liable for TV damage or personal injury when a non-VESA or non specified wall mount is used or the consumer fails to follow the TV installation instructions.

! CAUTION

- ▶ Do not install your wall mount kit while your TV is turned on. It may result in personal injury due to electric shock.

PREPARATION

CABLE MANAGEMENT

■ Here shown may be somewhat different from your TV.

- 1 Connect the cables as necessary.
To connect additional equipment, see the **EXTERNAL EQUIPMENT SETUP** section.
Secure the power cable with the **PROTECTIVE BRACKET** and the screw as shown. It will help prevent the power cable from being removed by accident.

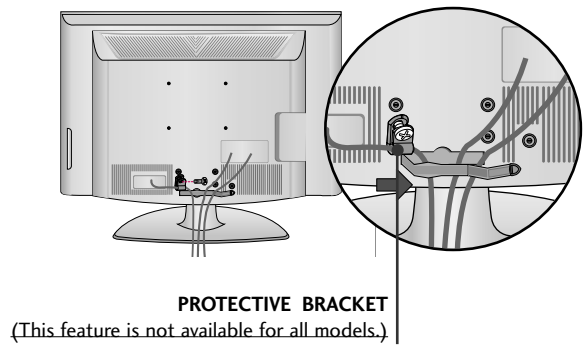

- 2 Install the **CABLE MANAGEMENT CLIP** as shown.

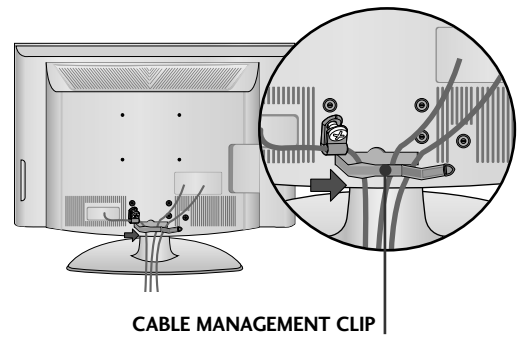

- 3 Put the cables inside the **CABLE MANAGEMENT CLIP** and snap it closed.

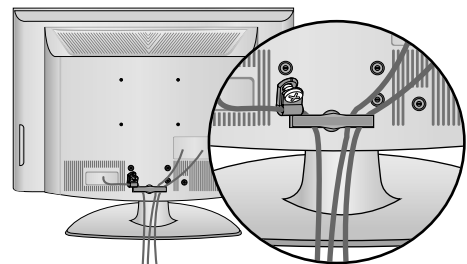

DESKTOP PEDESTAL INSTALLATION

- Image shown may differ from your TV.

For proper ventilation, allow a clearance of 4 inches on all four sides from the wall.

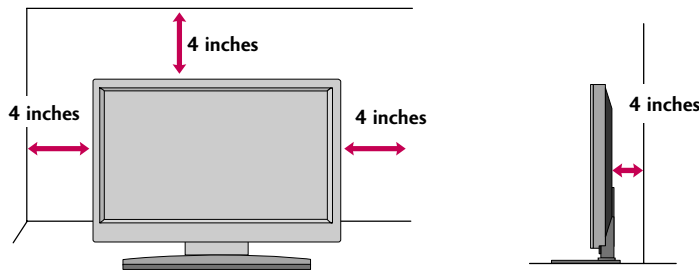

CAUTION

- Ensure adequate ventilation by following the clearance recommendations.
- Do not mount near or above any type of heat source.

SWIVEL STAND

After installing the TV, you can adjust the TV set manually to the left or right direction by 20 degrees to suit your viewing position.

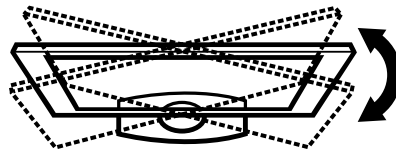

ATTACHING THE TV TO A DESK (Only 37/42LG5*)

The TV must be attached to a desk so it cannot be pulled in a forward/backward direction, potentially causing injury or damaging the product.

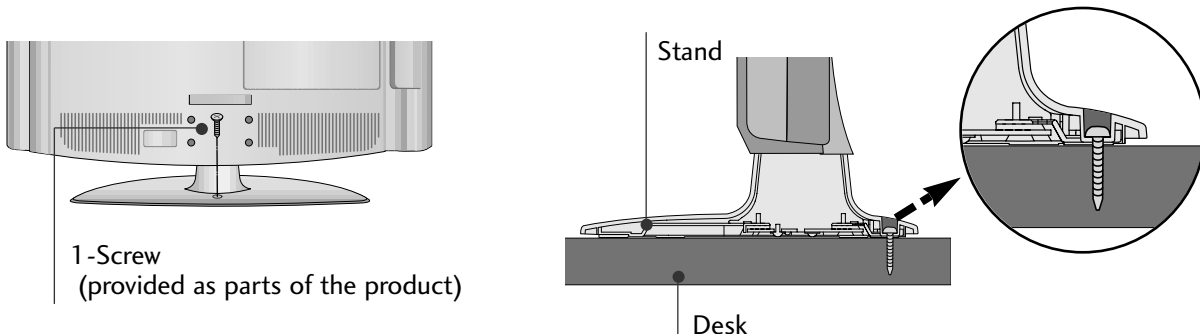

WARNING

- To prevent TV from falling over, the TV should be securely attached to the floor/wall per installation instructions. Tipping, shaking, or rocking the machine may cause injury.

PREPARATION

PREPARATION

SECURING THE TV TO THE WALL TO PREVENT FALLING WHEN THE TV IS USED ON A STAND

- You should purchase necessary components to prevent TV from falling off of the stand.
- Image shown may differ from your TV.

We recommend that you set up the TV close to a wall so it cannot fall over if pushed backwards. Additionally, we recommend that the TV be attached to a wall so it cannot be pulled in a forward direction, potentially causing injury or damaging the product.

Caution: Please make sure that children don't climb on or hang from the TV.

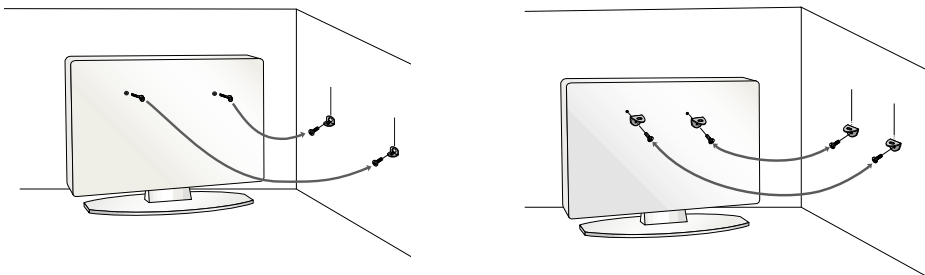

- Insert the eye-bolts (or TV brackets and bolts) to tighten the product to the wall as shown in the picture.

* If your product has the bolts in the eye-bolts position before inserting the eye-bolts, loosen the bolts.

* Insert the eye-bolts or TV brackets/bolts and tighten them securely in the upper holes.

Secure the wall brackets with the bolts (sold separately) to the wall. Match the height of the bracket that is mounted on the wall to the holes in the product.

Ensure the eye-bolts or brackets are tightened securely.

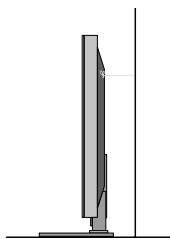

- Use a sturdy rope (sold separately) to tie the product. It is safer to tie the rope so it becomes horizontal between the wall and the product.

! NOTE

- ▶ Use a platform or cabinet strong enough and large enough to support the size and weight of the TV.
- ▶ To use the TV safely make sure that the height of the bracket on the wall and the one on the TV are the same.

- To prevent damage do not connect to the power outlet until all connections are made between the devices.

ANTENNA OR CABLE CONNECTION

1. Antenna (Analog or Digital)

Wall Antenna Socket or Outdoor Antenna without a Cable Box Connection.

For optimum picture quality, adjust antenna direction if needed.

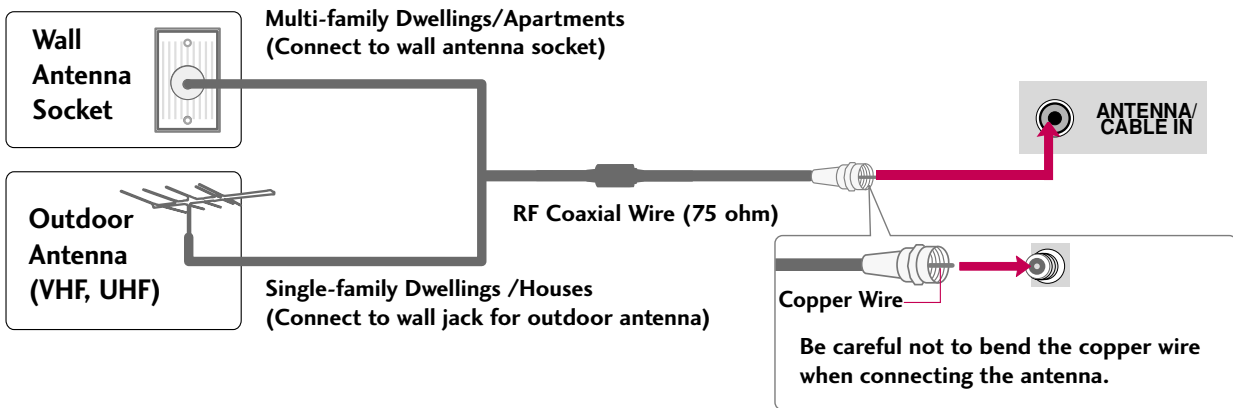

2. Cable

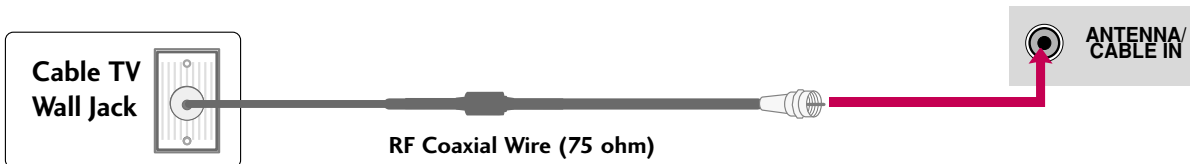

- To improve the picture quality in a poor signal area, please purchase a signal amplifier and install properly.
- If the antenna needs to be split for two TV's, install a 2-Way Signal Splitter.
- If the antenna is not installed properly, contact your dealer for assistance.

EXTERNAL EQUIPMENT SETUP

- To prevent the equipment damage, never plug in any power cords until you have finished connecting all equipment.
- Image shown may differ from your TV.

HD RECEIVER SETUP

This TV can receive Digital Over-the-air/Cable signals without an external digital set-top box. However, if you do receive digital signals from a digital set-top box or other digital external device, refer to the figure as shown below.

Component Connection

1. How to connect

- 1 Connect the video outputs (Y, PB, PR) of the digital set-top box to the **COMPONENT IN VIDEO 1** jacks on the TV. Match the jack colors (Y = green, PB = blue, and PR = red).
- 2 Connect the audio output of the digital set-top box to the **COMPONENT IN AUDIO 1** jacks on the TV.

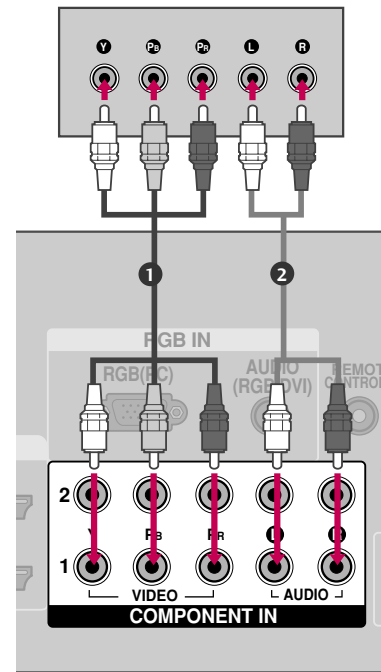

2. How to use

- Turn on the digital set-top box.
(Refer to the owner's manual for the digital set-top box. operation)
- Select the **Component 1** input source on the TV using the **INPUT** button on the remote control.
- If connected to **COMPONENT IN2** input, select the **Component 2** input source on the TV.

Supported Resolutions

Signal	Component	HDMI
480i	Yes	No
480p	Yes	Yes
720p	Yes	Yes
1080i	Yes	Yes
1080p	Yes	Yes

Y, CB/PB, CR/PR

Resolution	Horizontal Frequency(KHz)	Vertical Frequency(Hz)
720x480i	15.73	59.94
	15.73	60.00
720x480p	31.47	59.94
	31.50	60.00
1280x720p	44.96	59.94
	45.00	60.00
1920x1080i	33.72	59.94
	33.75	60.00
1920x1080p	26.97	23.976
	27.00	24.00
	33.71	29.97
	33.75	30.00
	67.432	59.94
	67.50	60.00

DVD SETUP

Component Connection

1. How to connect

- 1 Connect the video outputs (Y, PB, PR) of the DVD to the **COMPONENT IN VIDEO1** jacks on the TV.
Match the jack colors (Y = green, PB = blue, and PR = red).
- 2 Connect the audio outputs of the DVD to the **COMPONENT IN AUDIO1** jacks on the TV.

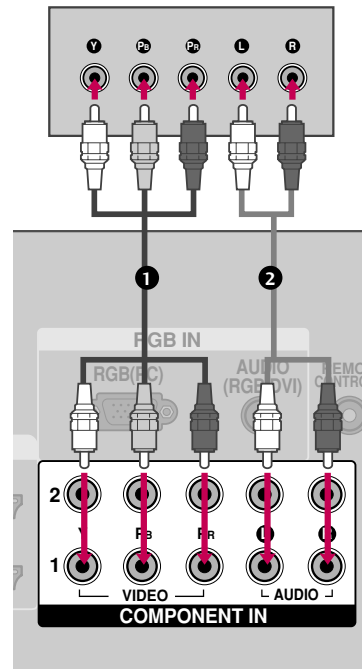

2. How to use

- Turn on the DVD player, insert a DVD.
- Select the **Component 1** input source on the TV using the **INPUT** button on the remote control.
- If connected to **COMPONENT IN 2** input, select the **Component 2** input source on the TV.
- Refer to the DVD player's manual for operating instructions.

HDMI Connection

1. How to connect

- 1 Connect the HDMI output of the DVD to the **HDMI/DVI IN1, 2, or 3*** jack on the TV.
- 2 No separate audio connection is necessary.
HDMI supports both audio and video.

2. How to use

- Select the **HDMI1, HDMI2, or HDMI3*** input source on the TV using the **INPUT** button on the remote control.
- Refer to the DVD player's manual for operating instructions.

* HDMI 3: Except 42/47/52LG50DC

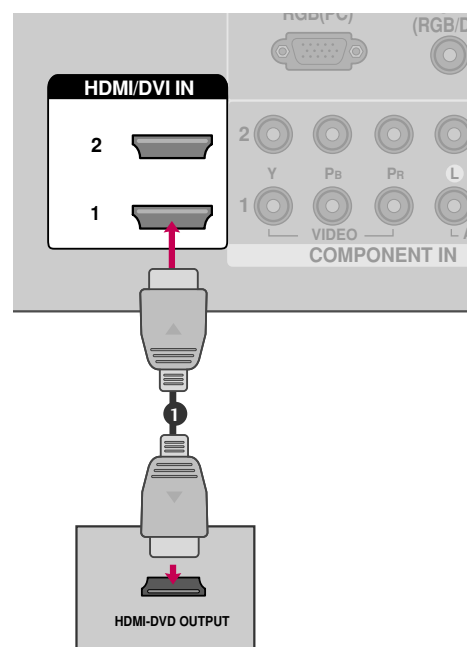

EXTERNAL EQUIPMENT SETUP

VCR SETUP

Composite (RCA) Connection

1. How to connect

- 1 Connect the **AUDIO/VIDEO** jacks between TV and VCR. Match the jack colors (Video = yellow, Audio Left = white, and Audio Right = red)

2. How to use

- Insert a video tape into the VCR and press **PLAY** on the VCR. (Refer to the VCR owner's manual.)
- Select the **AV1** input source on the TV using the **INPUT** button on the remote control.
- If connected to **AV IN2**, select **AV2** input source on the TV.

NOTE

- ▶ If you have a mono VCR, connect the audio cable from the VCR to the **AUDIO L/MONO** jack of the TV.

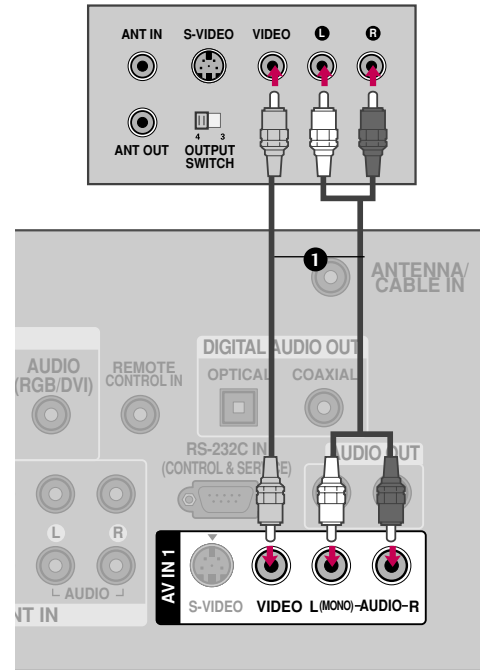

S-Video Connection

1. How to connect

- 1 Connect the S-VIDEO output of the VCR to the **S-VIDEO** input on the TV.
- 2 Connect the audio outputs of the VCR to the **AUDIO** input jacks on the TV.

2. How to use

- Insert a video tape into the VCR and press **PLAY** on the VCR. (Refer to the VCR owner's manual.)
- Select the **AV1** input source on the TV using the **INPUT** button on the remote control.

NOTE

- ▶ S-Video provides better quality than composite. Use it when available.

CAUTION

- ▶ Do not connect to both Video and S-Video at the same time. In the event that you connect both Video and the S-Video cables, only the S-Video will work.

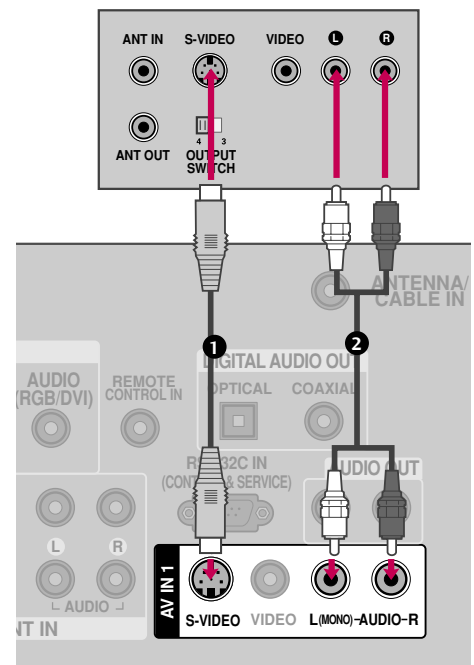

PC SETUP

VGA (D-Sub 15 pin) Connection

1. How to connect

- 1 Connect the VGA output of the PC to the **RGB (PC)** jack on the TV.
- 2 Connect the PC audio output to the **AUDIO (RGB/DVI)** jack on the TV.

2. How to use

- Turn on the PC and the TV.
- Select the **RGB-PC** input source on the TV using the **INPUT** button on the remote control.

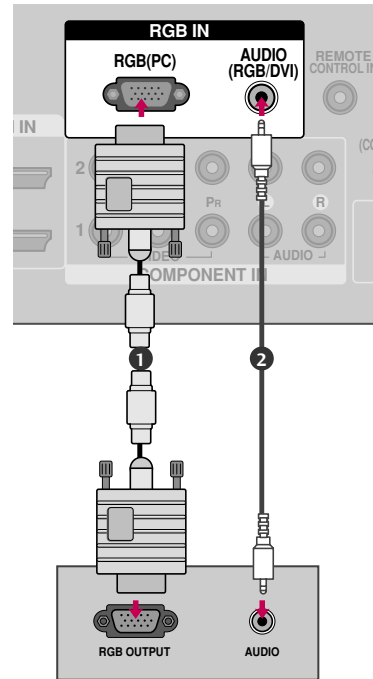

Supported Display Specifications (RGB-PC, HDMI-PC)

Resolution	Horizontal Frequency(KHz)	Vertical Frequency(Hz)
640x350	31.468	70.09
720x400	31.469	70.08
640x480	31.469	59.94
800x600	35.156 37.879	56.25 60.31
1024x768	48.363 56.476	60.00 70.06
1280x768	47.776	59.87
1280x1024	63.981	60.02
1360x768	47.712	60.015
1600x1200	75.00	60.00
1920x1080 RGB-PC	66.587	59.934
1920x1080 HDMI-PC	67.5	60.00

WATCHING TV

TURNING ON TV

- 1 First, connect power cord correctly.
At this moment, the TV switches to standby mode.
 - In standby mode to turn TV on, press the ⏻ / I , **INPUT**, (^ v) button on the TV or press the **POWER**, **INPUT**, **CH** (^ or v), **Number (0~9)** button on the remote control.
- 2 Select the viewing source by using the **INPUT** button on the remote control.
 - This TV is programmed to remember which power state it was last set to, even if the power cord is out.
- 3 When finished using the TV, press the **POWER** button on the remote control. The TV reverts to standby mode.

! NOTE ▶ If you intend to be away on vacation, disconnect the power plug from the wall power outlet.

CHANNEL SETUP

Auto Scan (Auto Tuning)

Automatically finds all channels available through antenna or cable inputs, and stores them in memory on the channel list.

Run Auto Tuning again after any Antenna/Cable connection changes.

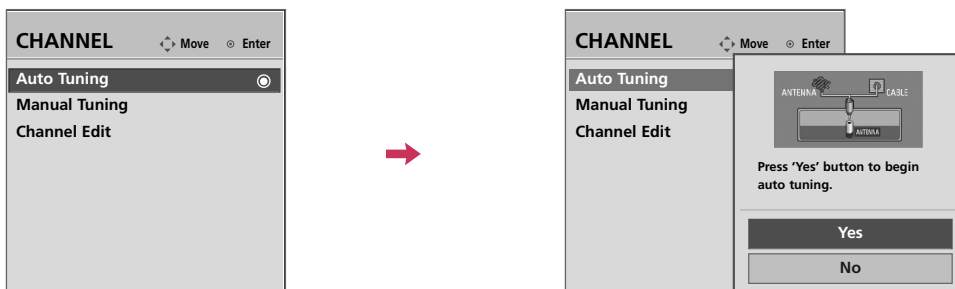

- 1 **MENU** Select **CHANNEL**.
- 2 **ENTER** Select **Auto Tuning**.
- 3 **ENTER** Select **Yes**.
- 4 **ENTER** Run **Auto tuning**.

- 5 **RETURN** Return to the previous menu.
- MENU** Return to TV viewing.

■ A password is required to gain access to Auto Tuning menu if the Lock System is turned on.

INITIAL SETTING

This Function guides the user to easily set the essential items for viewing the TV for the first time when purchasing the TV. It will be displayed on the screen when turning the TV on for the first time. It can also be activated from the user menus.

- Default selection is “**Home**”. We recommend setting the TV to “**Home**” mode for the best picture in your home environment.
- “**In-store**” Mode is only intended for use in retail environments. Customers can adjust the “**Picture menu - Picture mode**” manually while inspecting the TV, but the TV will automatically return to preset in-store mode after 5 minutes.

Step1. Mode Setting

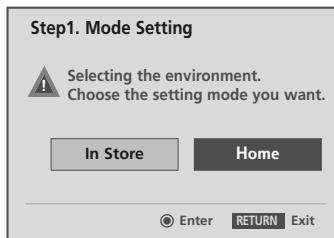

- 1 Select **Home** Mode.
- 2

Step2. Time Setting



- 1 Select **Auto** or **Manual**.
- 2 Select desired time option.
- 3

Step3. Option Setting

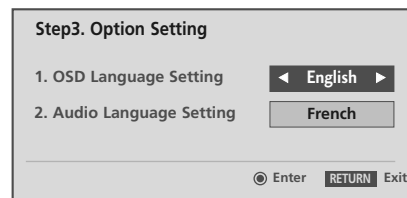

- 1 Select **OSD Language Setting** or **Audio Language Setting**.
- 2 Select your desired language.
- 3

Step4. Auto Tuning

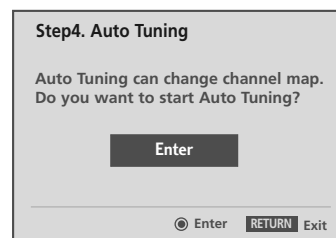

- 1 Start **Auto Tuning**.

! NOTE

- You can also adjust **Initial Setting** in the **OPTION** menu.

QUICK MENU / FAVORITE CHANNEL SETUP

Q.Menu (Quick Menu) is a menu of features which users might use frequently.

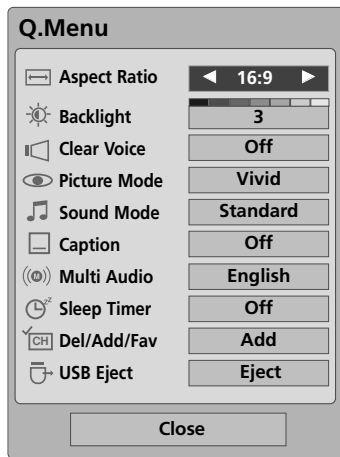

Q.MENU

- 1 Display each menu.
- 2 Make appropriate adjustments.
- 3 Return to TV viewing.

Favorite Channle Setup

- 1 Select your desired channel.
- 2 Select **Del/Add/Fav**.
- 3 Select **Favorite**.
- 4 Return to TV viewing.

ON-SCREEN MENUS SELECTION

Your TV's OSD (On Screen Display) may differ slightly from that shown in this manual.

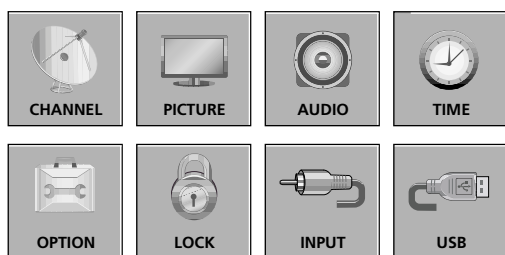

- 1 Display each menu.
- 2 Select a menu item.
- 3 Enter to the pop up menu.
- 4 Return to TV viewing.

CHANNEL

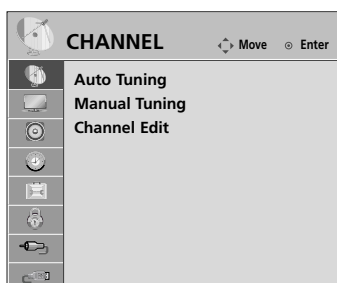

Auto Tuning	<ul style="list-style-type: none"> All available TV channels are searched and stored automatically.
Manual Tuning	<ul style="list-style-type: none"> User can do manual channel selection and add or delete individual channels.
Channel Edit	<ul style="list-style-type: none"> You can add or delete in the channel list.

PICTURE

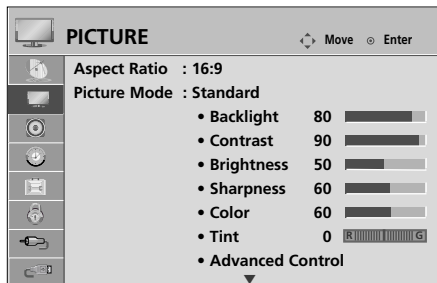

Aspect Ratio	<ul style="list-style-type: none"> Select the desired picture format: Set by program, 4:3, 16:9, Zoom1, Zoom2, Just Scan.
Picture Mode	<ul style="list-style-type: none"> Select the Intelligent Sensor, Vivid, Standard, Cinema, Sport, Game, Expert1, Expert2. Adjust the Backlight, Contrast, Brightness, Sharpness, Color, Tint. Advanced Control: Adjust the Color Temperature, Fresh Contrast, Fresh Color, Noise Reduction, Gamma, Black Level, Eye Care, Real Cinema. Reset: Settings of the selected picture modes return to the default factory settings.
Screen (RGB-PC)	<ul style="list-style-type: none"> Adjust the screen Resolution, Auto config, Position, Size, Phase, Reset.

AUDIO

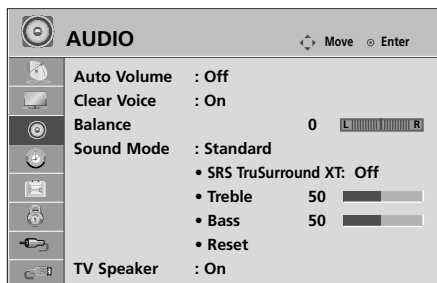

Auto Volume	<ul style="list-style-type: none"> Auto Volume makes sure that the volume level remains consistent whether you are watching a commercial or a regular TV program.
Clear Voice	<ul style="list-style-type: none"> By differentiating the human sound range from others, it helps users listen to human voices better.
Balance	<ul style="list-style-type: none"> Adjust the left/right sound of speaker.
Sound Mode	<ul style="list-style-type: none"> Select the Standard, Music, Cinema, Sport, and Game. SRS TruSurround XT, Treble, Bass: Adjust the sound to suit your taste and room situations. Reset: Settings of the selected Sound Mode return to the default factory settings.
TV Speaker	<ul style="list-style-type: none"> Turn the TV speaker On or off.

TIME

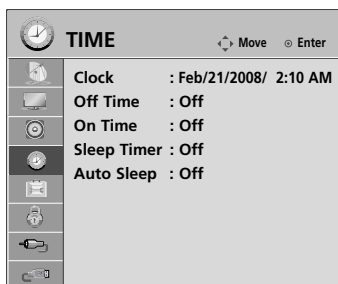

Clock	<ul style="list-style-type: none"> Auto: The time is set automatically from a digital channel signal. Select your viewing area time zone. Select Auto, Off, On depending on whether or not your viewing area observes Daylight Saving time. Manual: Set the clock manually.
On/Off Time	<ul style="list-style-type: none"> Use this feature to turn on/off TV at a scheduled time.
Sleep Timer	<ul style="list-style-type: none"> Select the amount of time before your TV turns off automatically: Off, 10, 20, 30, 60, 90, 120, 180, 240.
Auto Sleep	<ul style="list-style-type: none"> TV will be automatically turned off, in case of no signal for 10 minutes.

WATCHING TV

OPTION

OPTION		Move	Enter
Language	: English		
Input Label			
SIMPLINK	: On		
Key Lock	: Off		
Caption	: Off		
Set ID	: 1		
Power Indicator			
Initial Setting	: Home		

Language	<ul style="list-style-type: none"> Select your desired language for on screen menus : English, Spanish, French.
Input Label	<ul style="list-style-type: none"> Set a label to each input source.
SIMPLINK	<ul style="list-style-type: none"> Control and play other AV devices connected to the TV through HDMI cable without additional cables and settings.
key Lock	<ul style="list-style-type: none"> This feature can be used to prevent unauthorized viewing by locking out the front panel controls.
Caption	<ul style="list-style-type: none"> When selecting Off, Submenus for Analog, DTV, and Digital Option become disabled. Analog: CC1 ~ CC4 , Text1 ~ Text4. Digital: CC1 ~ CC4 , Text1 ~ Text4, Service1 ~ Service6. Digital Option: Customize the DTV/CADTV captions that appear on your screen.
Set ID	<ul style="list-style-type: none"> Choose the desired TV ID number.
Power Indicator	<ul style="list-style-type: none"> Adjust Power Indicator menu options.
Initial Setting	<ul style="list-style-type: none"> After turning on the TV, adjust Mode, Time, Language, Auto Tuning.

LOCK

LOCK		Move	Enter
Lock System	: Off		
Set Password			
Block Channel			
Movie Rating			
TV Rating-Children			
TV Rating-General			
Downloadable Rating			
Input Block			

For USA

LOCK		Move	Enter
Lock System	: Off		
Set Password			
Block Channel			
TV Rating-English			
TV Rating-French			
Downloadable Rating			
Input Block			

For Canada

Lock System	<ul style="list-style-type: none"> Select On or Off.
Set Password	<ul style="list-style-type: none"> Change the password.
Block Channel	<ul style="list-style-type: none"> Select a channel number that you wish to block.
Movie Rating	<ul style="list-style-type: none"> Blocks movies according to the movie ratings limits specified.
TV Rating-Children	<ul style="list-style-type: none"> Prevents children from watching certain children's TV programs, according to the ratings limit set.
TV Rating-General	<ul style="list-style-type: none"> Based on the ratings, blocks certain TV programs that you and your family do not want to view.
TV Rating-English	<ul style="list-style-type: none"> Selecting canadian english language rating system.
TV Rating-French	<ul style="list-style-type: none"> Selecting canadian french language rating system.
Downloadable Rating	<ul style="list-style-type: none"> This function may become available in the future and will be available only for digital channel signal.
Input Block	<ul style="list-style-type: none"> Enables you to select a source to block from the external source devices you have hooked up.

INPUT

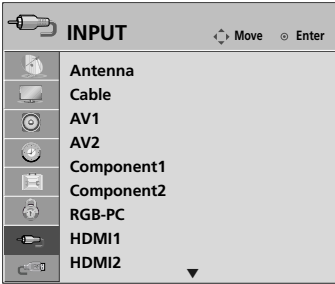

Input ■ Select desired input sources.

USB



USB ■ Use Photo List or Music List.

USB

ENTRY MODES

When you connect a USB device, this screen is displayed automatically.
In USB device, you can not add a new folder or delete the existing folder.

- 1 Connect the USB device to the **USB IN** jacks on the side of TV.

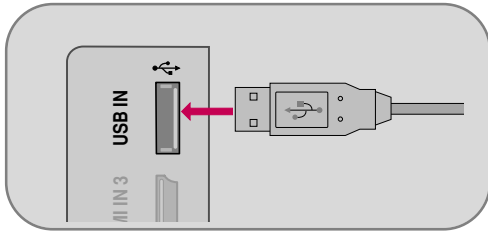

- 2 Select **Photo List** or **Music List**.

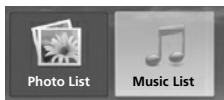

- 3

- It doesn't support USB HDD
- This TV supports JPG and MP3.

When removing the USB device

Select the **USB Eject** menu before removing the USB device.

- 1 Q. MENU Select **USB Eject**.

- 2 ENTER

Precautions when using the USB device

- ▶ Only a USB storage device is recognizable.
- ▶ If the USB storage device is connected through a USB hub, the device is not recognizable.
- ▶ A USB storage device using an automatic recognition program may not be recognized.
- ▶ A USB storage device which uses its own driver may not be recognized.
- ▶ USB multi-card reader or USB hard drive may not operate smoothly or may not operate at all.
- ▶ The recognition speed of a USB storage device may depend on each device.
- ▶ Please do not turn off the TV or unplug the USB device when the connected USB storage device is working. When such device is suddenly separated or unplugged, the stored files or the USB storage device may be damaged.
- ▶ Please do not connect the USB storage device which was artificially maneuvered on the PC. The device may cause the product to malfunction or fail to be played. Never forget to use only a USB storage device which has normal music files or image files.
- ▶ Please use only a USB storage device which was formatted as a FAT or NTFS file system provided with the Windows operating system. In case of a storage device formatted as a different utility program which is not supported by Windows, it may not be recognized.
- ▶ Please connect power to a USB storage device which requires an external power supply. If not, the device may not be recognized.
- ▶ Please connect a USB storage device with cable is offered by USB maker. If connected with cable is not offered by USB maker or an excessively long cable, the device may not be recognized.
- ▶ Some USB storage devices may not be supported or operated smoothly.
- ▶ Because the TV doesn't support file sorting for USB storage device, the file on the storage device will be displayed in the order saved.
- ▶ Please backup important files because data on USB device may be damaged. Data management is consumer's responsibility and as a result, the manufacturer does not cover data damage.

PHOTO LIST

You can view .JPG files from USB storage devices.
The On Screen Display on your model may be slightly different.



Screen Components

1



Select **USB**.

2

Select **Photo List**.

1 Moves to upper level folder

2 Preview: Display the thumbnail/folder name of the photo in the selected folder

3 Current page/Total pages

4 Total number of marked photos





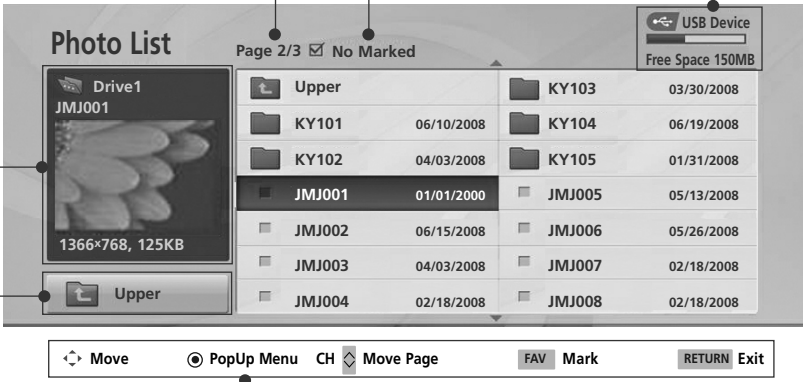

5 Usable USB memory

6 Corresponding buttons on the remote control



USB

Photo Selection and PopUp Menu

- 1**  Select the target folder or drive.
- 2**   Select the desired photos.
- 3**  Show the PopUp menu.
- 4**   Select the desired PopUp menu.

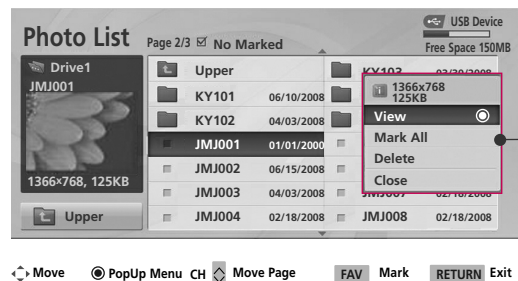









- Use the **CH** ^ v button to navigation in the photo page.
- Use the **FAV** button to mark or unmark a photo. When one or more photos are marked, you can view individual photos or a slide show of the marked photos. If no photos are marked, you can view all photos individually or all photos in the folder in a slide show.

When you select a file (not folder), this PopUp menu is displayed.

- ▶ **View:** Display the selected item.
- ▶ **Mark All:** Mark all photos on the screen.
- ▶ **Unmark All:** Deselect all marked photos.
- ▶ **Delete:** Delete the selected photo item.
- ▶ **Close:** Close the pop-up menu.

Full Screen Menu

You can change the Photo List view so that it fills the screen. More operations are available in full screen mode.

- 1  Select the target folder or drive.
- 2   Select the desired photos.
- 3  Show the Popup menu.
- 4  Select **View**.
- 5  The selected photo is displayed in full size.
- 6   Select the **Side Show**,  (**Rotate**), **Delete**, **Option**, or **Hide**.

- ▶ **Slide Show:** Selected photos are displayed during the slide show. If no photo is selected, all photos in the current folder are displayed during slide show.
 - Set the time interval of the slide show in **Option**.
 - A slide show continues for a maximum of 4 hours. After 4 hours, the slide show will end and go to TV mode or external input mode.
- ▶  (**Rotate**): Rotate photos.
 - Rotates the photo 90°, 180°, 270°, 360° clockwise.
- ▶ **Delete:** Delete photos.
- ▶ **Option:** Set values for **Slide Speed**.
 - Use < > button and **ENTER** button to set values. Then go to **Enter** and press **ENTER** to save the settings.
- ▶ **Hide** : Hide the menu on the full-sized screen.
 - To see the menu again on the full-sized screen, press **ENTER** button to display.

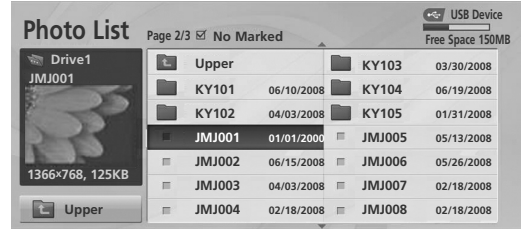

◁ Move ● PopUp Menu CH ▷ Move Page FAV Mark RETURN Exit

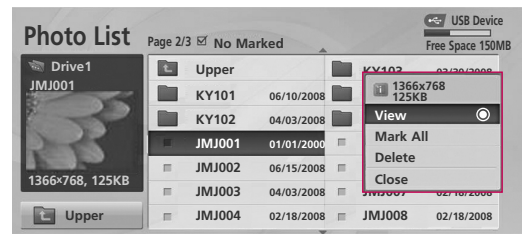

◁ Move ● PopUp Menu CH ▷ Move Page FAV Mark RETURN Exit

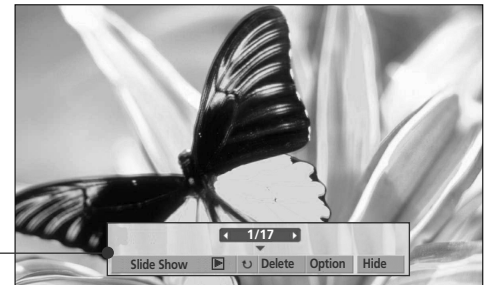

The aspect ratio of a photo may change the size of the photo displayed on the screen in full size.

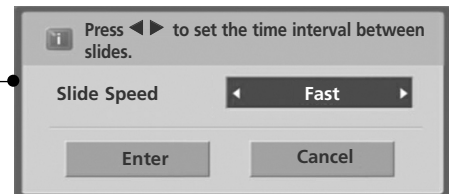

NOTE

- ▶ This TV will not be able to decode most JPG images saved using the Progressive option.



MUSIC LIST



You can use the Music List menu to play MP3 files from a USB storage device.
 This TV cannot play back copy-protected files.
 The On Screen Display on your model may be slightly different.

Supported music file: *.MP3
 Bit rate range 40Kbps ~ 320Kbps

- Sampling rate (Sampling Frequency)
 - MPEG1 : 32000, 44100, 48000Hz
 - MPEG2 : 16000, 24000, 22050Hz
 - MPEG2.5 : 16 ~ 48KHz

Screen Components

1   Select **USB**.

2    Select **Music List**.

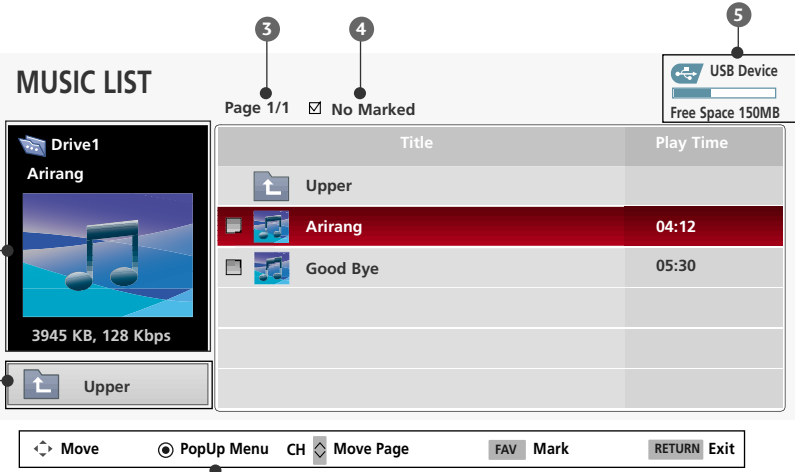

1 Moves to upper level folder

2 Preview: If any album jacket for the file exists, this jacket is displayed.

3 Current page/Total pages







4 Total number of marked musics

5 Usable USB memory

6 Corresponding buttons on the remote control

Music Selection and PopUp Menu

Up to 6 music titles are listed per page.

- 1  Select the target folder or drive.
- 2   Select the desired musics.
- 3  show the PopUp menu.
- 4   Select the desired PopUp menu.
- 5  Return to TV viewing.

- Use the **CH** ^ v button to navigation in the music page.
- Use **FAV** button to mark or unmark a music file. If no music is marked, all the music in the folder will be played in sequence. When one or more music files are marked, the marked music files will be played in sequence. If you want to listen to only one song repeatedly, just mark that one file and play.

- The play information box (as shown below) will automatically move across the screen when there is no user input to prevent a fixed image remaining on the screen for a extended period of time.

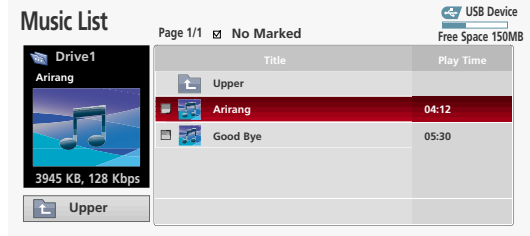
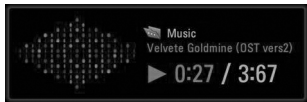

Move PopUp Menu CH Move Page FAV Mark RETURN Exit

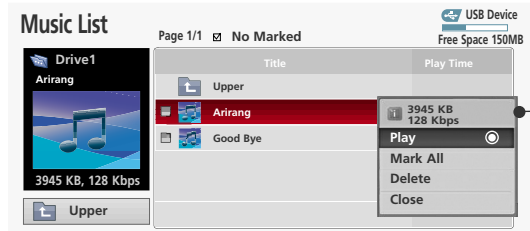

Move PopUp Menu CH Move Page FAV Mark RETURN Exit

- ▶ **Play** (During stop): Play the selected music. Once a song finishes playing, the next selected one will be played. When there are no selected musics to play, the next one in the current folder will be played. If you go to a different folder and press the **ENTER** button, the current music in playback will stop.
- ▶ **Stop Play** (During playback): Stop the playing musics.
- ▶ **Mark All**: Mark all musics in the folder.
- ▶ **Unmark All**: Deselect all marked music.
- ▶ **Delete**: Delete the selected music.
- ▶ **Close**: Close the pop-up menu.

NOTE

- ▶ When music is playing,  is displayed in front of the music play time.
- ▶ A damaged or corrupted music file that does not play displays 00:00 as the play time.
- ▶ Music files with copy-protection will not play.
- ▶ Press **ENTER**, **■**, or **RETURN** button to stop the screen saver.
- ▶ This TV can not play music files less than 16 Kbytes.

APPENDIX

TROUBLESHOOTING

The operation does not work normally.	
The remote control doesn't work	<ul style="list-style-type: none"> Check to see if there is any object between the product and the remote control causing obstruction. Ensure you are pointing the remote control directly at the TV. Ensure that the batteries are installed with correct polarity (+ to +, - to -). Ensure that the correct remote operating mode is set: TV, VCR etc. Install new batteries.
Power is suddenly turned off	<ul style="list-style-type: none"> Is the sleep timer set? Check the power control settings. Power interrupted.

The video function does not work.	
No picture & No sound	<ul style="list-style-type: none"> Check whether the product is turned on. Try another channel. The problem may be with the broadcast. Is the power cord inserted into wall power outlet? Check your antenna direction and/or location. Test the wall power outlet, plug another product's power cord into the outlet where the product's power cord was plugged in.
Picture appears slowly after switching on	<ul style="list-style-type: none"> This is normal, the image is muted during the product startup process. Please contact your service center, if the picture has not appeared after five minutes.
No or poor color or poor picture	<ul style="list-style-type: none"> Adjust Color in menu option. Keep a sufficient distance between the product and the VCR. Try another channel. The problem may be with the broadcast. Are the video cables installed properly? Activate any function to restore the brightness of the picture.
Horizontal/vertical bars or picture shaking	<ul style="list-style-type: none"> Check for local interference such as an electrical appliance or power tool.
Poor reception on some channels	<ul style="list-style-type: none"> Station or cable product experiencing problems, tune to another station. Station signal is weak, reorient antenna to receive weaker station. Check for sources of possible interference.
Lines or streaks in pictures	<ul style="list-style-type: none"> Check antenna (Change the direction of the antenna).
No picture when connecting HDMI	<ul style="list-style-type: none"> Check HDMI cable over version 1.3. The HDMI cables don't support HDMI version 1.3, it cause flickers or no screen display. In this case use the latest cables that support HDMI version 1.3.

The audio function does not work.

Picture OK & No sound	<ul style="list-style-type: none"> ■ Press the VOL or VOLUME button. ■ Sound muted? Press MUTE button. ■ Try another channel. The problem may be with the broadcast. ■ Are the audio cables installed properly?
No output from one of the speakers	<ul style="list-style-type: none"> ■ Adjust Balance in menu option.
Unusual sound from inside the product	<ul style="list-style-type: none"> ■ A change in ambient humidity or temperature may result in an unusual noise when the product is turned on or off and does not indicate a fault with the product.
No sound when connecting HDMI or USB	<ul style="list-style-type: none"> ■ Check HDMI cable over version 1.3. ■ Check USB cable over version 2.0. ■ Use normal MP3 file.

There is a problem in PC mode. (Only PC mode applied)

The signal is out of range	<ul style="list-style-type: none"> ■ Adjust resolution, horizontal frequency, or vertical frequency. ■ Check the input source.
Vertical bar or stripe on background & Horizontal Noise & Incorrect position	<ul style="list-style-type: none"> ■ Work the Auto configure or adjust clock, phase, or H/V position. (Option)
Screen color is unstable or single color	<ul style="list-style-type: none"> ■ Check the signal cable. ■ Reinstall the PC video card.

MAINTENANCE

Early malfunctions can be prevented. Careful and regular cleaning can extend the amount of time you can enjoy your new TV.

Caution: Be sure to turn the power off and unplug the power cord before you begin any cleaning.

Cleaning the Screen

- 1 Here's a great way to keep the dust off your screen for a while. Wet a soft cloth in a mixture of lukewarm water and a little fabric softener or dish washing detergent. Wring the cloth until it's almost dry, and then use it to wipe the screen.
- 2 Make sure the excess water is off the screen, and then let it air-dry before you turn on your TV.

Cleaning the Cabinet

- To remove dirt or dust, wipe the cabinet with a soft, dry, lint-free cloth.
- Please be sure not to use a wet cloth.

Extended Absence

CAUTION

- ▶ If you expect to leave your TV dormant for a long time (such as a vacation), it's a good idea to unplug the power cord to protect against possible damage from lightning or power surges.

APPENDIX

PRODUCT SPECIFICATIONS

MODELS		37LG50 (37LG50-UG)	42LG50 (42LG50-UG) 42LG50DC (42LG50DC-UG) 42LG55 (42LG55-UE)
Dimensions (Width x Height x Depth)	With stand	36.8 x 26.9 x 11.5 inches 936.4 x 685.4 x 293.4 mm	40.7 x 28.9 x 11.5 inches 1034.0 x 735.0 x 294.0 mm
	Without stand	36.8 x 24.1 x 3.4 inches 936.4 x 612.8 x 88.0 mm	40.7 x 26.1 x 3.5 inches 1034.0 x 663.0 x 91.0 mm
Weight	With stand	40.3 pounds / 18.3 kg	54.0 pounds / 24.5 kg
	Without stand	34.3 pounds / 15.6 kg	48.5 pounds / 22.0 kg
MODELS		47LG50 (47LG50-UG) 47LG50DC (47LG50DC-UG) 47LG55 (47LG55-UE)	52LG50 (52LG50-UG) 52LG50DC (52LG50DC-UG)
Dimensions (Width x Height x Depth)	With stand	45.5 x 32.0 x 13.5 inches 1156.2 x 813.1 x 342.9 mm	50.8 x 35.1 x 13.5 inches 1291.7 x 892.2 x 342.9 mm
	Without stand	45.5 x 29.1 x 4.0 inches 1156.2 x 739.2 x 103.0 mm	50.8 x 32.1 x 4.5 inches 1291.7 x 817.0 x 115.3 mm
Weight	With stand	64.3 pounds / 29.2 kg	87.0 pounds / 39.5 kg
	Without stand	54.2 pounds / 24.6 kg	76.9 pounds / 34.9 kg
Power requirement Television System Program Coverage External Antenna Impedance		AC100-240V ~ 50/60Hz NTSC-M, ATSC, 64 & 256 QAM VHF 2-13, UHF 14-69, CATV 1-135, DTV 2-69, CADTV 1-135 75 ohm	
Environment condition	Operating Temperature Operating Humidity	32 ~ 104°F (0 ~ 40°C) Less than 80%	
	Storage Temperature Storage Humidity	-4 ~ 140°F (-20 ~ 60°C) Less than 85%	

■ The specifications shown above may be changed without prior notice for quality improvement.

CHILD SAFETY:

It Makes A Difference How and Where You Use Your Flat Panel Display

Congratulations on your purchase! As you enjoy your new product, please keep these safety tips in mind:



THE ISSUE

- The home theater entertainment experience is a growing trend and larger flat panel displays are popular purchases. However, flat panel displays are not always supported on the proper stands or installed according to the manufacturer's recommendations.
- Flat panel displays that are inappropriately situated on dressers, bookcases, shelves, desks, speakers, chests or carts may fall over and cause injury.

THIS MANUFACTURER CARES!

- The consumer electronics industry is committed to making home entertainment enjoyable and safe.

TUNE INTO SAFETY

- One size does NOT fit all. Follow the manufacturer's recommendations for the safe installation and use of your flat panel display.
- Carefully read and understand all enclosed instructions for proper use of this product.
- Don't allow children to climb on or play with furniture and television sets.
- Don't place flat panel displays on furniture that can easily be used as steps, such as a chest of drawers.
- Remember that children can become excited while watching a program, especially on a "larger than life" flat panel display. Care should be taken to place or install the display where it cannot be pushed, pulled over, or knocked down.
- Care should be taken to route all cords and cables connected to the flat panel display so that they cannot be pulled or grabbed by curious children.

WALL MOUNTING: IF YOU DECIDE TO WALL MOUNT YOUR FLAT PANEL DISPLAY, ALWAYS:

- Use a mount that has been recommended by the display manufacturer and/or listed by an independent laboratory (such as UL, CSA, ETL).
- Follow all instructions supplied by the display and wall mount manufacturers.
- If you have any doubts about your ability to safely install your flat panel display, contact your retailer about professional installation.
- Make sure that the wall where you are mounting the display is appropriate. Some wall mounts are not designed to be mounted to walls with steel studs or old cinder block construction. If you are unsure, contact a professional installer.
- A minimum of two people are required for installation. Flat panel displays can be heavy.

