



**APPENDIX G**  
**: USER'S MANUAL**



**LG**

Life's Good

# OWNER'S MANUAL

# GOOGLE TV

Please read this manual carefully before operating the set and retain it for future reference.

LMG620 series

## Table of Contents

### 4 BEFORE USE

---

- 4 LICENSES
- 5 IMPORTANT SAFETY INSTRUCTIONS
- 10 Viewing 3D Imaging (For 3D models)
- 12 Unpacking
- 14 Optional Extras
- 15 Parts and buttons
- 16 Magic Remote Control Functions
- 18 - Registering the Remote Control
- 18 - Precautions to Take when Using the Remote Control

### 19 INSTALLATION

---

- 19 Lifting and moving the TV
- 20 Setting up the TV
- 20 - Attaching the stand
- 22 - Mounting on a table
- 23 - Mounting on a wall
- 24 - Tidying cables
- 25 Connecting to an antenna or cable
- 25 - Connecting an antenna or basic cable
- 25 - Connecting a cable box

### 26 CONNECTIONS

---

- 26 Connecting to an antenna or cable
- 27 Connection Overview
- 28 Connecting to a HD receiver, DVD, or VCR player
- 28 - HDMI Connection
- 29 - DVI to HDMI Connection
- 30 - Component Connection
- 31 - Composite Connection
- 32 Connecting to a PC
- 32 - HDMI Connection, DVI to HDMI Con-

- nection or RGB Connection
- 34 Connecting to an Audio System
- 34 - Digital Optical Audio Connection
- 35 Connecting to a USB

### 36 USING (BASIC)

---

- 36 Turning the TV on for the first time
- 36 Setting the Mode
- 37 Accessing Home Menu
- 38 Setting up channels
- 39 Checking current program info
- 40 Adjusting aspect ratio
- 41 Using the input list
- 42 Using the customer support
- 42 - Testing the Picture / Sound
- 42 - Using the product or service information

### 43 APPLICATIONS

---

- 43 Google Chrome
- 43 - Getting started
- 43 - Browser windows
- 44 - Bookmarks
- 44 - Safety and security settings
- 44 - Advanced settings
- 45 Android Market
- 45 - Getting Started
- 45 - How to download or remove apps
- 46 - Charges
- 47 - Returning apps
- 48 Live TV
- 48 - Picture in Picture
- 49 3D World
- 49 - When watching 3D imaging
- 49 - When using 3D Glasses
- 49 - Viewing 3D Imaging
- 50 - Setting 3D Imaging

51	Media Player
51	- Options
52	Netflix
52	Photos
53	Search
53	TV & Movies
54	YouTube

## 55 SETTINGS

---

55	The Main Menus
56	- Network
56	- Video input
57	- Picture & sound
57	- ATSC
57	- Input List
58	- Picture
59	- Audio
59	- 3D Setting
59	- Search
59	- Applications
60	- Language & input devices
60	- Accounts & sync
60	- Privacy & safety
61	- Storage
61	- Date, time & location
62	- Safety(Lock)
62	- Accessibility
63	- About
63	- Option
63	- Customer Support

## 64 APPENDIX

---

64	Updating the TV Firmware
65	Cleaning Your TV
65	- Screen, frame, cabinet and stand
65	- Power cord
65	Preventing "Image burn" or "Burn-in" on your TV screen
66	IR Blaster Guide
67	- IR Code list
103	Troubleshooting
106	Specifications
109	Open Source Software Notice
110	Privacy Notice for the Google TV
111	Google TV Safety

# BEFORE USE

## LICENSES

Supported licenses may differ by model. For more information about licenses, visit [www.lg.com](http://www.lg.com).



Manufactured under license from Dolby Laboratories. "Dolby" and the double-D symbol are trademarks of Dolby Laboratories.



HDMI, the HDMI logo and High-Definition Multimedia Interface are trademarks or registered trademarks of HDMI Licensing LLC.



### NOTE

- Image shown may differ from your TV.
- Your TV's OSD (On Screen Display) may differ slightly from that shown in this manual.

## IMPORTANT SAFETY INSTRUCTIONS

Always comply with the following precautions to avoid dangerous situations and ensure peak performance of your product.





**WARNING / CAUTION**

RISK OF ELECTRIC SHOCK  
DO NOT OPEN



TO REDUCE THE RISK OF ELECTRIC SHOCK DO NOT REMOVE COVER (OR BACK). NO USER SERVICEABLE PARTS INSIDE. REFER TO QUALIFIED SERVICE PERSONNEL.

 The lightning flash with arrowhead symbol, within an equilateral triangle, is intended to alert the user to the presence of uninsulated "dangerous voltage" within the product's enclosure that may be of sufficient magnitude to constitute a risk of electric shock to persons.

 The exclamation point within an equilateral triangle is intended to alert the user to the presence of important operating and maintenance (servicing) instructions in the literature accompanying the appliance.

**WARNING/CAUTION**

- TO REDUCE THE RISK OF FIRE AND ELECTRIC SHOCK, DO NOT EXPOSE THIS PRODUCT TO RAIN OR MOISTURE.

Read these instructions.

Keep these instructions.

Heed all warnings.

Follow all instructions.



- Do not use this apparatus near water.



- Clean only with a dry cloth.



- Do not block any ventilation openings. Install in accordance with the manufacturer's instructions.



- Do not install near any heat sources such as radiators, heat registers, stoves, or other apparatus (including amplifiers) that produce heat.



- Do not defeat the safety purpose of the polarized or grounding-type plug. A polarized plug has two blades with one wider than the other. A grounding type plug has two blades and a third grounding prong. The wide blade or the third prong are provided for your safety. If the provided plug does not fit into your outlet, consult an electrician for replacement of the obsolete outlet (Can differ by country).

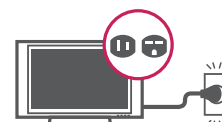

- Protect the power cord from being walked on or pinched particularly at plugs, convenience receptacles, and the point where they exit from the apparatus.



- Only use attachments/accessories specified by the manufacturer.



- Use only with a cart, stand, tripod, bracket, or table specified by the manufacturer, or sold with the apparatus. When a cart is used, use caution when moving the cart/apparatus combination to avoid injury from tip-over.



- Unplug this apparatus during lightning storms or when unused for long periods of time.

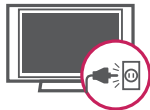

- Refer all servicing to qualified service personnel. Servicing is required when the apparatus has been damaged in any way, such as power-supply cord or plug is damaged, liquid has been spilled or objects have fallen into the apparatus, the apparatus has been exposed to rain or moisture, does not operate normally, or has been dropped.



- Never touch this apparatus or antenna during a thunder or lightning storm.
- When mounting a TV on the wall, make sure not to install the TV by hanging the power and signal cables on the back of the TV.

- Do not allow an impact shock or any objects to fall into the product, and do not drop anything onto the screen.
- Keep the packing anti-moisture material or vinyl packing out of the reach of children. Anti-moisture material is harmful if swallowed. If swallowed by mistake, force the patient to vomit and visit the nearest hospital. Additionally, vinyl packing can cause suffocation. Keep it out of the reach of children.
- CAUTION concerning the Power Cord (Can differ by country):

It is recommended that appliances be placed upon a dedicated circuit; that is, a single outlet circuit which powers only that appliance and has no additional outlets or branch circuits. Check the specification page of this owner's manual to be certain. Do not connect too many appliances to the same AC power outlet as this could result in fire or electric shock. Do not overload wall outlets. Overloaded wall outlets, loose or damaged wall outlets, extension cords, frayed power cords, or damaged or cracked wire insulation are dangerous. Any of these conditions could result in electric shock or fire. Periodically examine the cord of your appliance, and if its appearance indicates damage or deterioration, unplug it, discontinue use of the appliance, and have the cord replaced with an exact replacement part by an authorized service. Protect the power cord from physical or mechanical abuse, such as being twisted, kinked, pinched, closed in a door, or walked upon. Pay particular attention to plugs, wall outlets, and the point where the cord exits the appliance. Do not move the TV with the power cord plugged in. Do not use a damaged or loose power cord. Be sure do grasp the plug when unplugging the power cord. Do not pull on the power cord to unplug the TV.



- Do not stick metal objects or any other conductive material into the power cord. Do not touch the end of the power cord while it is plugged in.

- **Warning** - To reduce the risk of fire or electrical shock, do not expose this product to rain, moisture or other liquids. Do not touch the TV with wet hands. Do not install this product near flammable objects such as gasoline or candles, or expose the TV to direct air conditioning.



- Do not expose to dripping or splashing and do not place objects filled with liquids, such as vases, cups, etc. on or over the apparatus (e.g. on shelves above the unit).



- **Grounding**

(Except for devices which are not grounded.) Ensure that you connect the earth ground wire to prevent possible electric shock (i.e. a TV with a three-prong grounded AC plug must be connected to a three-prong grounded AC outlet). If grounding methods are not possible, have a qualified electrician install a separate circuit breaker. Do not try to ground the unit by connecting it to telephone wires, lightning rods, or gas pipes.

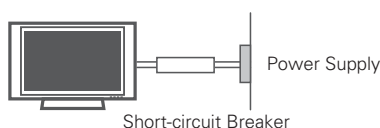

- **DISCONNECTING DEVICE FROM THE MAIN POWER**

The power outlet must remain readily accessed in the event the device needs to be unplugged.

- As long as this unit is connected to the AC wall outlet, it is not disconnected from the AC power source even if the unit is turned off.
- Do not attempt to modify this product in any way without written authorization from LG Electronics. Unauthorized modification could void the user's authority to operate this product.

- **ANTENNAS Outdoor antenna grounding**  
(Can differ by country):

If an outdoor antenna is installed, follow the precautions below. An outdoor antenna system should not be located in the vicinity of overhead power lines or other electric light or power circuits, or where it can come in contact with such power lines or circuits as death or serious injury can occur. Be sure the antenna system is grounded so as to provide some protection against voltage surges and built-up static charges. Section 810 of the National Electrical Code (NEC) in the U.S.A. provides information with respect to proper grounding of the mast and supporting structure, grounding of the lead-in wire to an antenna discharge unit, size of grounding conductors, location of antenna discharge unit, connection to grounding electrodes and requirements for the grounding electrode.

**Antenna grounding according to the National Electrical Code, ANSI/NFPA 70**

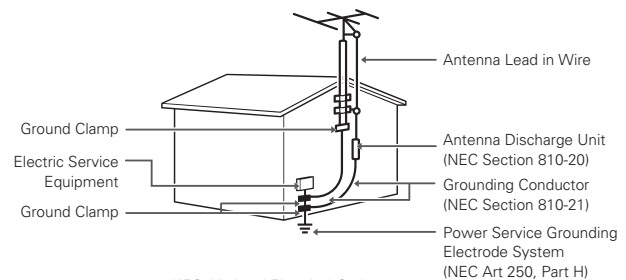

NEC: National Electrical Code

- **Cleaning**

When cleaning, unplug the power cord and wipe gently with a soft cloth to prevent scratching. Do not spray water or other liquids directly on the TV as electric shock may occur. Do not clean with chemicals such as alcohol, thinners or benzine.

- **Moving**

Make sure the product is turned off, unplugged and all cables have been removed. It may take 2 or more people to carry larger TVs. Do not press or put stress on the front panel of the TV.

- **Ventilation**

Install your TV where there is proper ventilation. Do not install in a confined space such as a bookcase. Do not cover the product with cloth or other materials while plugged. Do not install in excessively dusty places.



- If you smell smoke or other odors coming from the TV, unplug the power cord and contact an authorized service center.
- Do not press strongly upon the panel with your hand or a sharp object such as a nail, pencil or pen, or make a scratch on it.
- Keep the product away from direct sunlight.

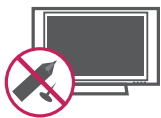

- **Dot Defect**

The Plasma or LCD panel is a high technology product with resolution of two million to six million pixels. In a very few cases, you could see fine dots on the screen while you're viewing the TV. Those dots are deactivated pixels and do not affect the performance and reliability of the TV.

- **Generated Sound**

"Cracking" noise: A cracking noise that occurs when watching or turning off the TV is generated by plastic thermal contraction due to temperature and humidity. This noise is common for products where thermal deformation is required.

Electrical circuit humming/panel buzzing: A low level noise is generated from a high-speed switching circuit, which supplies a large amount of current to operate a product. It varies depending on the product.

This generated sound does not affect the performance and reliability of the product.

- Take care not to touch the ventilation openings. When watching the TV for a long period, the ventilation openings may become hot. This does not affect the performance of the product or cause defects in the product.
- If the TV feels cold to the touch, there may be a small "flicker" when it is turned on. This is normal, there is nothing wrong with TV. Some minute dot defects may be visible on the screen, appearing as tiny red, green, or blue spots. However, they have no adverse effect on the TV's performance. Avoid touching the LCD screen or holding your finger(s) against it for long periods of time. Doing so may produce some temporary distortion effects on the screen.

#### DISPOSAL (Hg lamp only used in LCD TVs)

The fluorescent lamp used in this product contains a small amount of mercury. Do not dispose of this product with general household waste. Disposal of this product must be carried out in accordance to the regulations of your local authority.

#### NOTE TO CABLE/TV INSTALLER

This reminder is provided to call the CATV system installer's attention to Article 820-40 of the National Electric Code (U.S.A.). The code provides guidelines for proper grounding and, in particular, specifies that the cable ground shall be connected to the grounding system of the building, as close to the point of the cable entry as practical.

**FCC NOTICE**

This equipment has been tested and found to comply with the limits for a Class B digital device, pursuant to Part 15 of the FCC Rules. These limits are designed to provide reasonable protection against harmful interference in a residential installation. This equipment generates, uses and can radiate radio frequency energy and, if not installed and used in accordance with the instructions, may cause harmful interference to radio communications. However, there is no guarantee that interference will not occur in a particular installation. If this equipment does cause harmful interference to radio or television reception, which can be determined by turning the equipment off and on, the user is encouraged to try to correct the interference by one or more of the following measures:

- Reorient or relocate the receiving antenna.
- Increase the separation between the equipment and the receiver.
- Connect the equipment to an outlet on a circuit different from that to which the receiver is connected.
- Consult the dealer or an experienced radio/TV technician for help.

This device complies with part 15 of the FCC Rules. Operation is subject to the following two conditions: (1) this device may not cause harmful interference and (2) this device must accept any interference received, including interference that may cause undesired operation of the device.

Any changes or modifications in construction of this device which are not expressly approved by the party responsible for compliance could void the user's authority to operate the equipment.

**NOTE TO CABLE/TV INSTALLER**

This reminder is provided to call the CATV system installer's attention to Article 820-40 of the National Electric Code (U.S.A.). The code provides guidelines for proper grounding and, in particular, specifies that the cable ground shall be connected to the grounding system of the building, as close to the point of the cable entry as practical.

## Viewing 3D Imaging (For 3D models)

### WARNING

#### Viewing Environment

- Viewing Hour  
When watching 3D videos, take a 5 - 15 minute break every hour. Watching TV for a long time may cause headache, dizziness, fatigue or eye strain.

#### Viewing Age

- Infants/Children
  - Prohibit children under the age of 5 from watching or using 3D videos.
  - Children under the age of 10 may react overly excited, for example, trying to touch the screen or jumping into it because their vision is in development. Extra special monitoring is required for children watching 3D videos.
  - For children, the distance between eyes is shorter than one of adults, so they have greater binocular disparity of 3D presentations than adults, perceiving more stereoscopic depth even for the same 3D image.
- Teenagers  
Teenagers under the age of 19 may be stimulated to light coming from 3D videos. Advise them not to watch 3D videos for a long time when they are tired.
- Elderly  
The elderly may perceive less of a 3D effect than the youth. Do not sit closer to the TV than the recommended distance.

#### Those who have a photosensitive seizure or chronic illness

- Some users may experience a seizure or other abnormal symptoms when they are exposed to a flashing light or particular pattern from 3D videos.
- Do not watch 3D videos if you have a chronic illness (epilepsy, cardiac disorder, or blood pressure disease, etc.); if you often feel nausea; or if you are pregnant.
- If you suffer from stereo blindness or stereo anomaly, it is not recommended to watch 3D videos. You may experience double images or discomfort in viewing.
- If you have squint, amblyopia (weak eyesight) or astigmatism, you may have a trouble sensing depth and easily feel fatigue due to double images. It is advised to take a break more often than general adults do.
- If you have different eyesight between your right and left eyes, revise your eyesight first before watching 3D videos.

#### Symptoms requiring to refrain from or stop watching 3D videos

- Symptoms requiring to refrain from or stop watching 3D videos  
Do not watch 3D videos when you feel fatigue due to lack of sleep, overwork or drinking.  
If you experience those symptoms, stop using/watching 3D videos and rest until the symptom disappear.
  - Headache, eyeball pain, dizziness, nausea, palpitation, blurriness, discomfort, double image, visual inconvenience or fatigue
 If your symptoms persist, please consult your doctor.

 **CAUTION****Viewing Environment**

- Viewing Distance  
Maintain a distance of at least twice the screen diagonal length when watching 3D videos. If you feel uncomfortable viewing 3D videos, move farther away from the TV.
- Viewing Position (Only for SG Mode)  
You should also be able to see the centre of the screen at eye level with the head looking straight up. Otherwise, you may not be able to view 3D videos properly.
- Viewing Environment
  - Before watching 3D videos, adjust first the viewing level, brightness, focus, and sound to ensure comfortable viewing.
  - Proper lighting and ventilation also help you watch TV comfortably.

**Cautions when using the 3D glasses**

- Make sure to use LG 3D glasses. Otherwise, you may not be able to view 3D videos properly.
- Do not use the 3D glasses instead of your normal glasses, sunglasses or protective goggles.
- Using modified 3D glasses may cause eye strain or image distortion.
- Do not keep your 3D glasses in extremely high or low temperatures to prevent them from deformation.
- The 3D glasses are fragile, and easy to scratch. Always use a soft, clean piece of cloth when wiping the lenses. Do not scratch the lenses of the 3D glasses with sharp objects or wipe them with any chemicals.
- When watching 3D videos under fluorescent lighting or with three wave length lamps, you may see the screen blinking. In this case, turn the light off or turn it down. (Only for SG mode)
- Put other electronic or communication devices away from the TV or turn them off. Interference may occur, which prevents the 3D function from working properly. (Only for SG mode)
- If you watch TV lying down, 3D images become to look dark or invisible. (Only for SG mode)

## Unpacking

Check your product box for the following items. If there are any missing accessories, contact the local dealer where you purchased your product. The illustrations in this manual may differ from the actual product and item.



### NOTE

- The items supplied with your product may vary depending on the model.
- Product specifications or contents of this manual may be changed without prior notice due to upgrade of product functions.
- For an optimal connection, HDMI cables and USB devices should have bezels less than 10 mm (0.39 inches) thick and 18 mm (0.7 inches) width.
- Use an extension cable that supports USB 2.0 if the USB cable or USB memory stick does not fit into your TV's USB port.

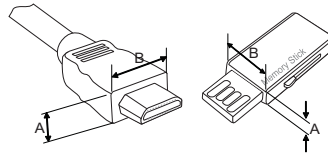

\*A ≤ 10 mm (0.39 inches)

\*B ≤ 18 mm (0.7 inches)



### CAUTION

- Do not use any unapproved items to ensure the safety and product life span.
- Any damages or injuries by using unapproved items are not covered by the warranty.
- In case of some model, the thin film on screen is a part of TV, So don't take it off.

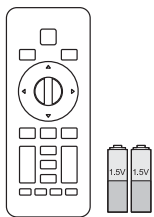

●WERTY Remote Control,  
Batteries (AA)  
(See p.16)

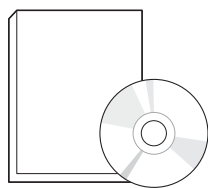

Owner's manual,  
CD manual

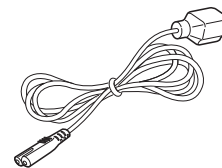

Power Cord



Cinema 3D Glasses  
3 Box(6 EA)

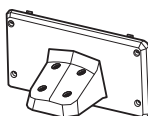

Stand Body  
(See p.17)

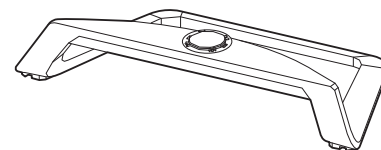

Stand Base  
(See p.17)



Stand Screws  
8 EA, M4 x 16  
(See p.17)



Wall mount inner spacers  
4 E

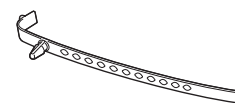

Cable holder  
(See p.16)

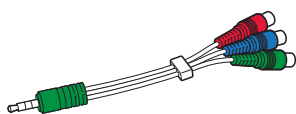

Component video cable  
(See p.20, 21)

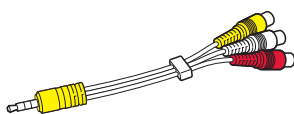

Composite video cable  
(See p.21)

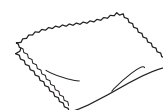

Polishing cloth  
Use this to remove dust  
from the cabinet.

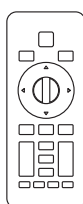

IR Blaster cable  
(See p. 66)

AN-MR300 ●  
QWERTY Remote Control

## Optional Extras

Optional extras can be changed or modified for quality improvement without any notification.

Contact your dealer for buying these items.

These devices only work with certain models.



### **AG-F3\*\***

Cinema 3D Glasses

The model name  
or design may be  
changed manufacturer's  
circumstances or policies.

## Parts and buttons

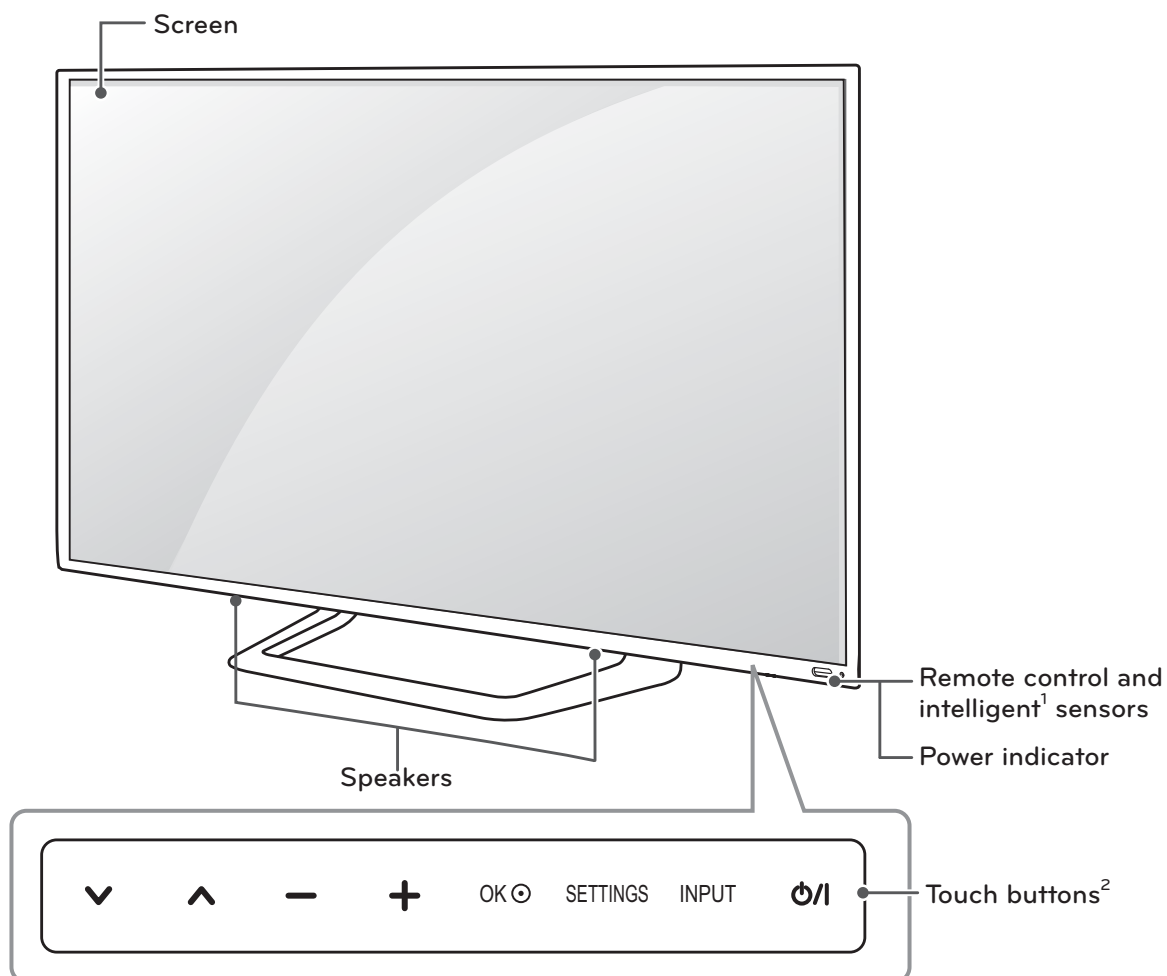

Button	Description
⏻ / ⏻	Turns the power on or off.
INPUT	Changes the input source.
SETTINGS	Accesses the main menus, or saves your input and exits the menus.
OK	Selects the highlighted menu option or confirms an input.
- +	Adjusts the volume level.
✓ ^	Scrolls through the saved channels.

1 Intelligent sensor - Adjusts the image quality and brightness based on the surrounding environment.

2 All of the buttons are touch sensitive and can be operated through simple touch with your finger.



## Magic Remote Control Functions

When the message "Remote control battery is low. Change the battery." is displayed, replace the batteries.

To replace batteries, open the battery cover, replace batteries (1.5 V AA) matching ⊕ and ⊖ ends to the label inside the compartment, and close the battery cover.

Be sure to point the remote control at the remote control sensor on the TV.

To remove the batteries, perform the installation actions in reverse.



### CAUTION

- Do not mix old and new batteries, as this may damage the remote control.

Make sure to point the remote control at the remote control sensor on the TV.

### Remote Control Side - Front

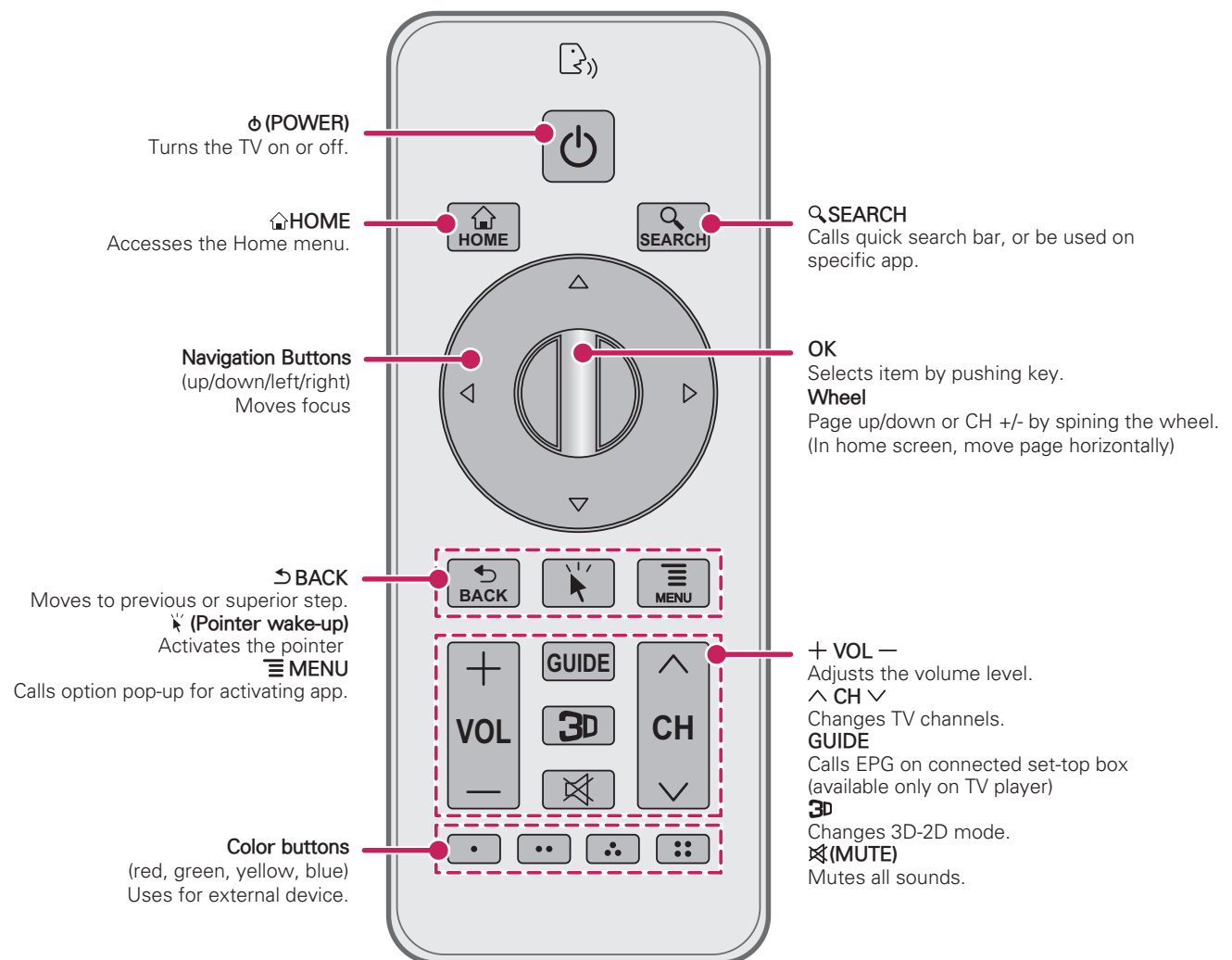

**QWERTY Side - Back**

**TV (FN+1)**

Activate TV player app

**PIP (FN+4)**

Activate/Deactivate PIP

**INFO (FN+7)**

Show channel information(available only on TV player)

**EXT1 PWR (FN+2)**

Turn on/off external device 1  
(see 'IR blaster' UX document for detail)

**EXT 2 PWR (FN+5)**

Turn on/off external device 2

**INPUT (FN+8)**

Show external input list

**ESC**

Cancel state or command

**Tab**

Move focus to next depth or step

**X (Backspace)**

Deletes the preceding character  
and moves the cursor one position backwards

**Enter**

Finish text input

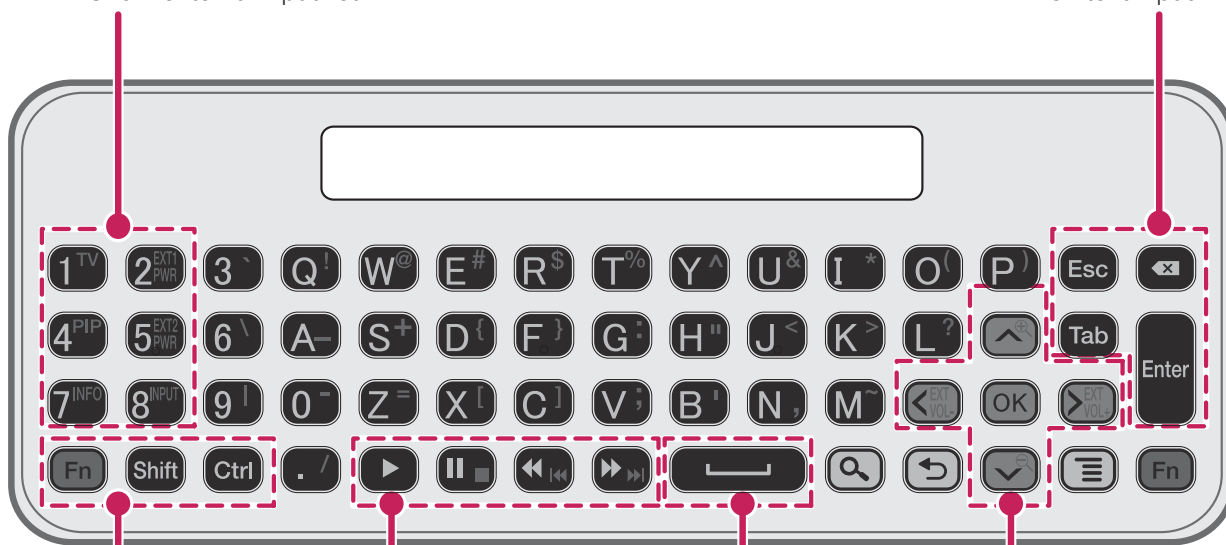

**Spacebar**

Enter the space

**Trick play keys**

(play, pause, stop, scan +/-, skip +/-)  
Combination key with other keys

**⊕ / ⊖ (FN+^ / FN+V)**

Zoom in/out

**EXT VOL +/- (FN+< / FN+>)**

Volume up/down of audio receiver

**Fn**

Combination key with other keys

**Shift**

Combination key with alphabet keys;input upper case

**Ctrl**

Combination key with other keys



\* Search, Back, Menu, OK : Operate as same keys on R side

## Registering the Remote Control



The Remote Control operates by pairing with your TV.

Once you purchased the TV, please register the Remote Control as follows;

### How to register the Remote Control

	<p>To register the remote control, press the  (Pointer wake-up) button on the remote control while aiming it at your TV.</p>
---	---

### How to Re-register the Remote Control after Registration Failure

	<p>Reset the remote control by pressing and holding the  <b>BACK</b> button for 3 seconds. (Once the reset is complete, the light on the Pointer blinks.) Then repeat the above procedure to register the remote control.</p>
---	--

## Precautions to Take when Using the Remote Control

- Use the remote control within the maximum communication distance (XX m, XXft). Using the remote control beyond this distance, or with an object obstructing it, may cause a communication failure.
- A communication failure may occur due to nearby devices. Electrical devices such as a microwave oven or wireless LAN product may cause interference, as these use the same bandwidth (2.4 GHz) as the Remote Control.
- The Remote Control may be damaged or may malfunction if it is dropped or receives a heavy impact.
- Manufacturer and installer cannot provide service related to human safety as the applicable wireless device has possibility of electric wave interference.
- It is recommended that an Access Point (AP) be located more than XX m (XX ft) away from the TV. If the AP is installed closer than XX m (XX ft), the Remote Control may not perform as expected due to frequency interference.

# INSTALLATION

## Lifting and moving the TV

When moving or lifting the TV, read the following to prevent the TV from being scratched or damaged and for safe transportation regardless of its type and size.

### CAUTION

- Avoid touching the screen at all times, as this may result in damage to the screen.

- It is recommended to move the TV in the box or packing material that the TV originally came in.
- Before moving or lifting the TV, disconnect the power cord and all cables.
- When holding the TV, the screen should face away from you to avoid damage.



- Hold the top and bottom of the TV frame firmly. Make sure not to hold the transparent part, speaker, or speaker grill area.

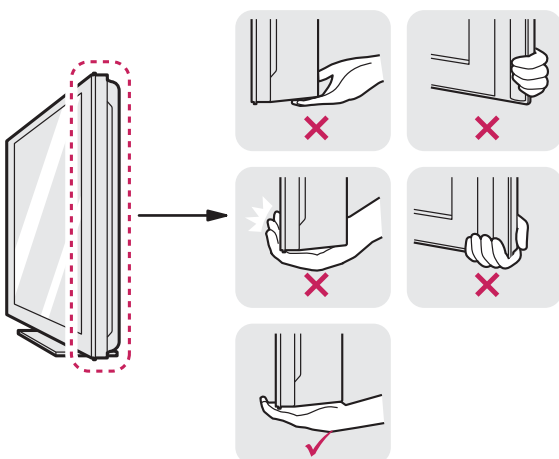

- When transporting a large TV, there should be at least 2 people.
- When transporting the TV by hand, hold the TV as shown in the following illustration.

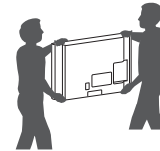

- When transporting the TV, do not expose the TV to jolts or excessive vibration.
- When transporting the TV, keep the TV upright, never turn the TV on its side or tilt towards the left or right.

## Setting up the TV

Put your TV on a pedestal stand and mount the TV on a table or wall.

### Attaching the stand

If you are not mounting the TV to a wall, use the following instructions to attach the stand.

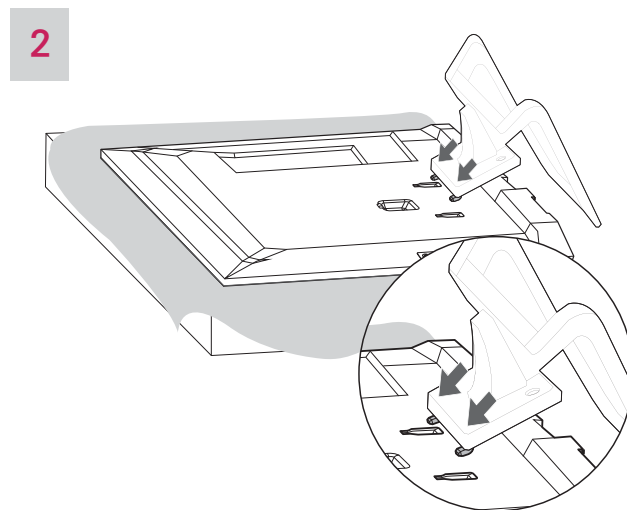
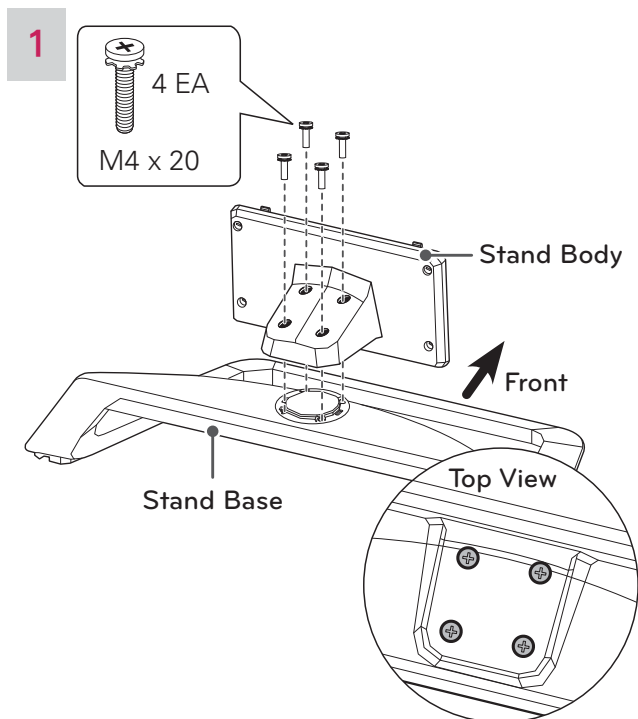

#### **CAUTION**

- When attaching the stand to the TV set, place the screen facing down on a cushioned table or flat surface to protect the screen from scratches.

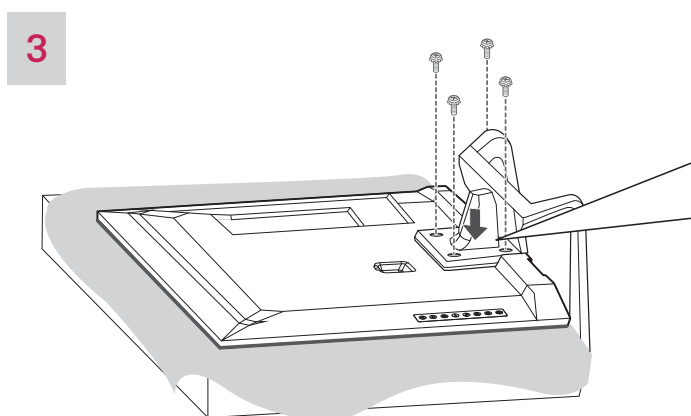

#### **NOTE**

- Remove the stand before installing the TV on a wall mount by performing the stand attachment in reverse.

#### **CAUTION**

- Tighten the screws firmly to prevent the TV from tilting forward. Do not over tighten.

To detach the stand,

1

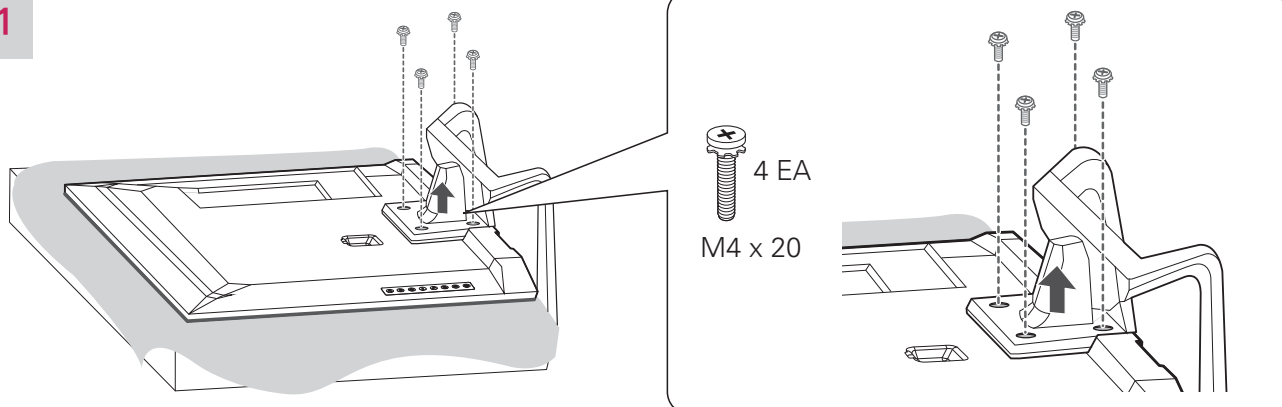

**CAUTION**

- When attaching the stand to the TV set, place the screen facing down on a cushioned table or flat surface to protect the screen from scratches.

## Mounting on a table

- Lift and tilt the TV into its upright position on a table.
  - Leave a 10 cm (4 inch) (minimum) space from the wall for proper ventilation.

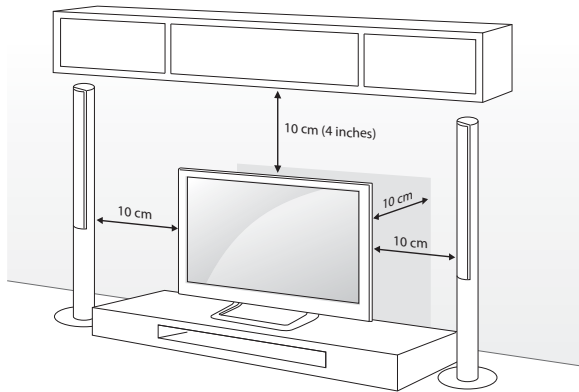

- Connect the power cord to a wall outlet.



### CAUTION

- Do not place the TV near or on sources of heat, as this may result in fire or other damage.

### Adjusting the angle of the TV to suit view

Swivel  $10 \pm 2$  degrees to the left or right and adjust the angle of the TV to suit your view.

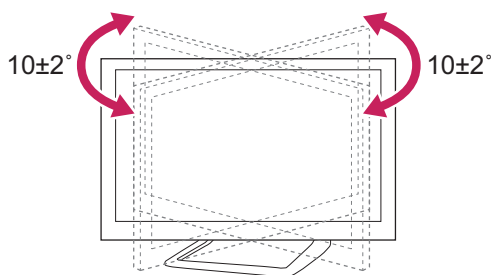

### NOTE

- When adjusting the angle of the TV, watch out for your fingers.

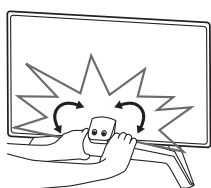

Rear

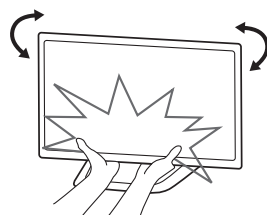

Front

### Securing the TV to a wall (optional)

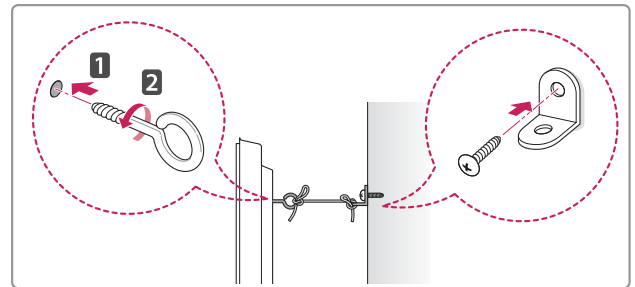
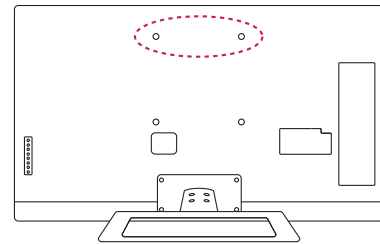

- Insert and tighten the eye-bolts, or TV brackets and bolts on the back of the TV.
  - If there are bolts inserted at the eye-bolts position, remove the bolts first.
- Mount the wall brackets with the bolts to the wall. Match the location of the wall bracket and the eye-bolts on the rear of the TV.
- Connect the eye-bolts and wall brackets tightly with a sturdy rope. Make sure to keep the rope horizontal with the flat surface.



### CAUTION

- Make sure that children do not climb on or hang on the TV.



### NOTE

- Use a platform or cabinet that is strong and large enough to support the TV securely.
- Brackets, bolts and ropes are optional. You can obtain additional accessories from your local dealer.

## Mounting on a wall

Attach an optional wall mount bracket at the rear of the TV carefully and install the wall mount bracket on a solid wall perpendicular to the floor. When you attach the TV to other building materials, please contact qualified personnel.

We recommend that you use an LG brand wall mount when mounting the TV to a wall.

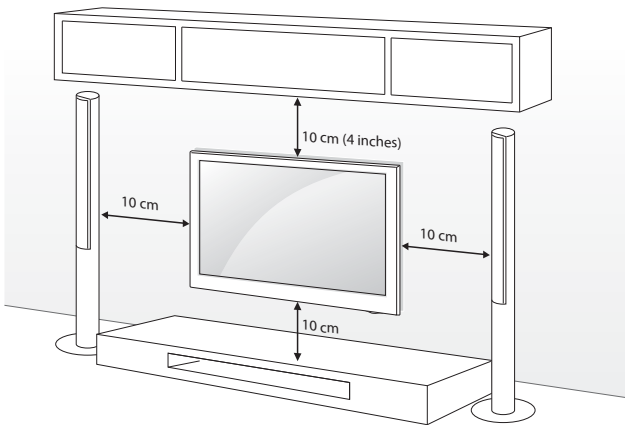

Make sure to use screws and wall mounts that meet the VESA standard. Standard dimensions for the wall mount kits are described in the following table.

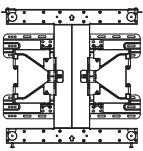
<b>Model</b>	47/55LMG620
<b>VESA</b>	400 x 400
<b>Standard screw</b>	M6
<b>Number of screws</b>	4
<b>Wall mount bracket (optional)</b>	LSW400BX, LSW400BXG 

### ! CAUTION

- Disconnect the power first, and then move or install the TV. Otherwise electric shock may occur.
- If you install the TV on a ceiling or slanted wall, it may fall and result in severe injury. Use an authorized LG wall mount and contact the local dealer or qualified personnel.
- Do not over tighten the screws as this may cause damage to the TV and void your warranty.
- Use the screws and wall mounts that meet the VESA standard. Any damages or injuries by misuse or using an improper accessory are not covered by the warranty.

### ! NOTE

- Use the screws that are listed on the VESA standard screw specifications.
- The wall mount kit includes an installation manual and necessary parts.
- The wall mount bracket is optional. You can obtain additional accessories from your local dealer.
- The length of screws may differ depending on the wall mount. Make sure to use the proper length.
- For more information, refer to the manual supplied with the wall mount.
- When attaching a third-party wall mounting bracket to the TV, insert the wall mount inner spacers into the TV wall mount holes to move your TV in vertical angle. Please make sure not to use the spacers for LG wall mounting bracket.

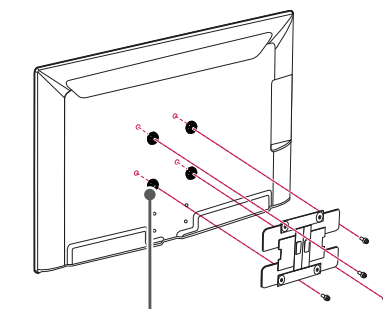

Wall Mount Inner Spacer



## Tidying cables

- 1 Gather and bind the cables with the cable holder.

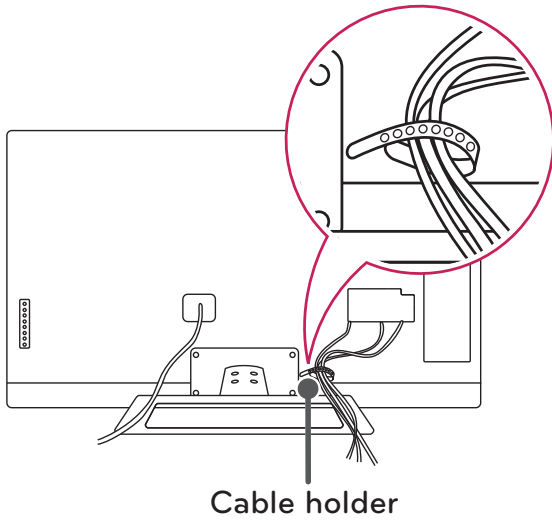

- 2 Fix the cable management clip firmly to the TV.

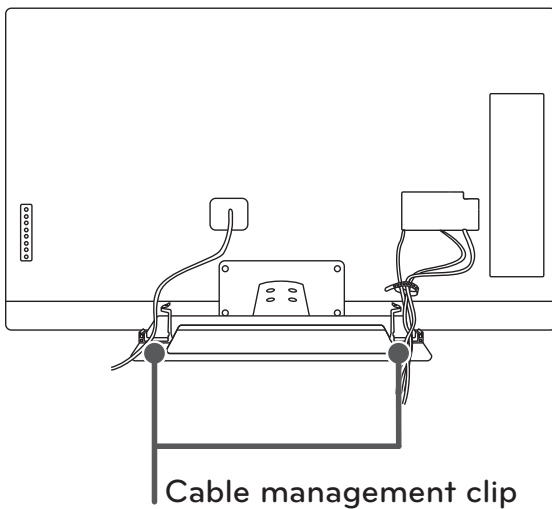

### CAUTION

- Do not move the TV by holding the cable holder and power cord holder, as the cable holders may break, and injuries and damage to the TV may occur.

## Connecting to an antenna or cable

Connect an antenna, cable, or cable box to watch TV while referring to the following. The illustrations may differ from the actual items and a RF cable is optional.

### Connecting an antenna or basic cable

Connect the TV to a wall antenna socket with an RF cable (75  $\Omega$ ).

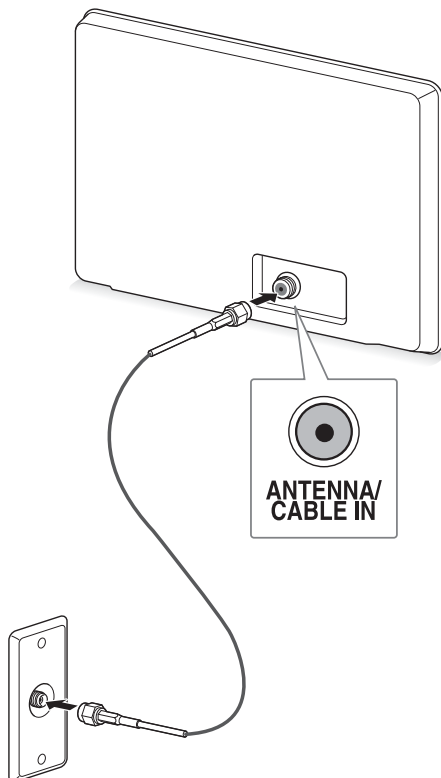

#### NOTE

- Use a signal splitter to use more than 2 TVs.
- Visit <http://lgknowledgebase.com> for more information about the antenna and cable connection. Search for antenna.

## Connecting a cable box

Connect the TV to a cable box and the cable box to a wall antenna socket with 2 RF cables (75  $\Omega$ ).

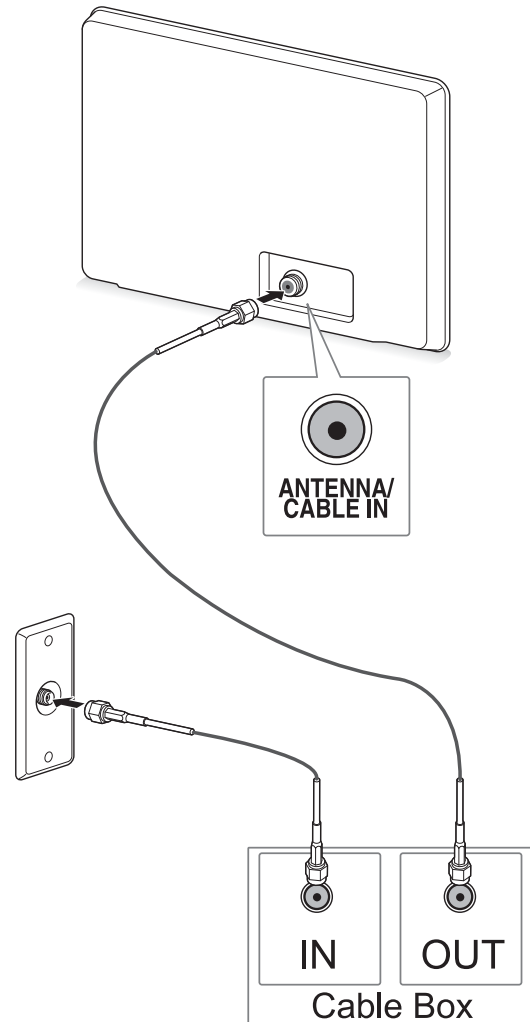

#### CAUTION

- Make sure not to bend the copper wire of the RF cable.

Copper wire

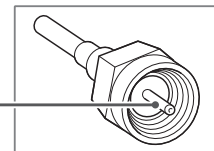

- Complete all connections between devices, and then connect the power cord to the power outlet to prevent damage to your TV.

# CONNECTIONS

Connect various external devices to the TV and switch input modes to select an external device. For more information on an external device's connection, refer to the manual provided with each device.

Available external devices are: HD receivers, DVD players, VCRs, audio systems, USB storage devices, PC, gaming devices, and other external devices.

## NOTE

- If you record a TV program on a DVD recorder or VCR, make sure to connect the TV signal input cable to the TV through a DVD recorder or VCR. For more information on recording, refer to the manual provided with the connected device.
- The external device connection may differ from the model.
- Connect external devices to the TV regardless of the order of the TV port.
- If you connect a gaming device to the TV, use the cable supplied with the gaming device.
- Refer to the external equipment's manual for operating instructions.

## Connecting to an antenna or cable

Connect an antenna, cable, or cable box to watch TV while referring to the following. The illustrations may differ from the actual items and a RF cable is optional.

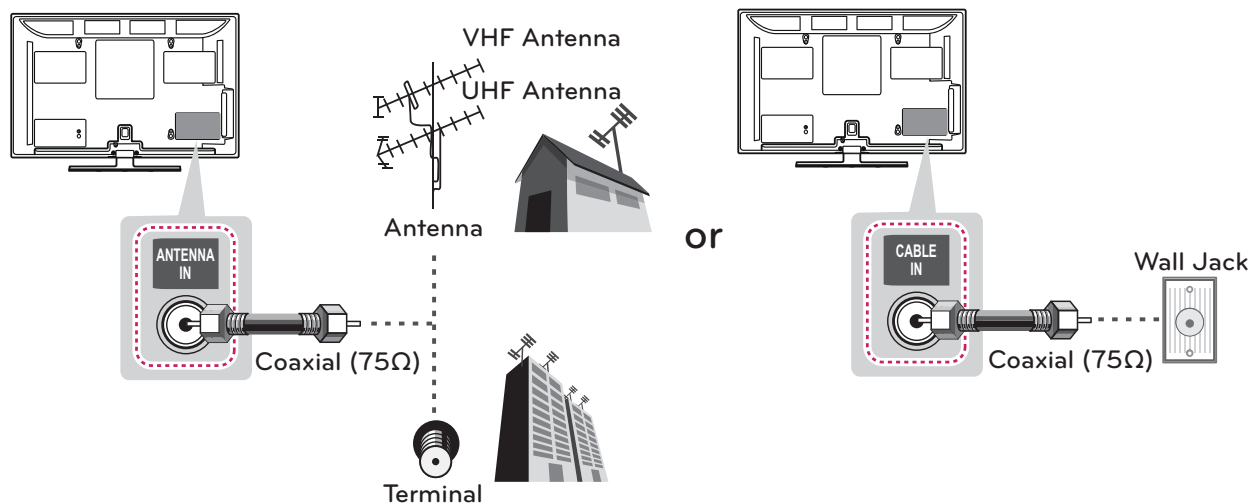

## CAUTION

- Make sure not to bend the copper wire of the RF cable.



- Complete all connections between devices, and then connect the power cord to the power outlet to prevent damage to your TV.

## NOTE

- To improve the picture quality in a poor signal area, please purchase a signal amplifier and install properly.
- Use a signal splitter to use more than 2 TVs.
- If the antenna is not installed properly, contact your dealer for assistance.

## Connection Overview

Connect various external devices to the ports on the TV back panel.

- 1 Find an external device you want to connect to your TV as shown on the following illustration.
- 2 Check the connection type of the external device.
- 3 Go to the appropriate illustration and check the connection details.

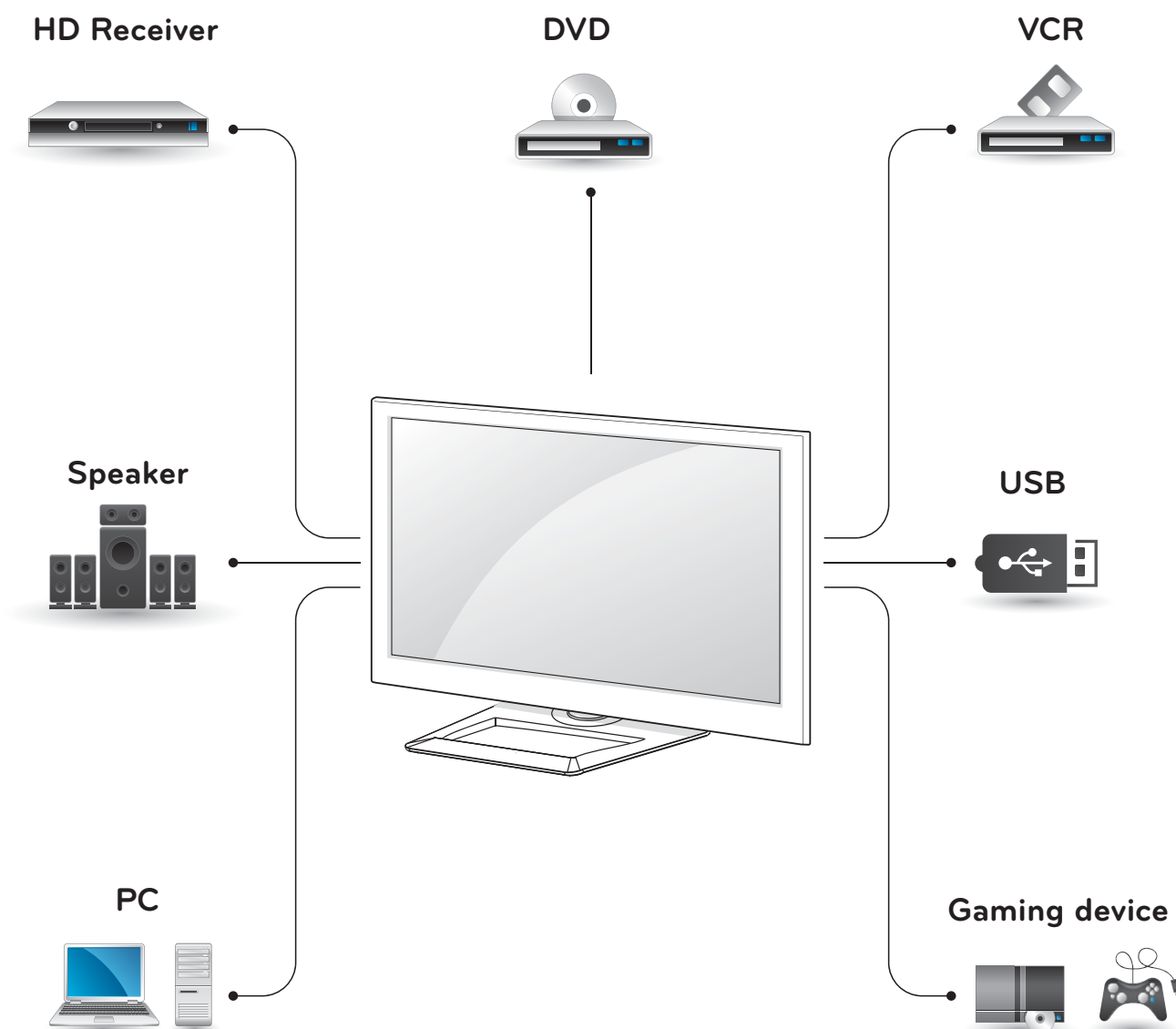

## Connecting to a HD receiver, DVD, or VCR player

Connect a HD receiver, DVD, or VCR player to the TV and select an appropriate input mode.

### HDMI Connection

**HDMI is the best way to connect a device.**

Transmits the digital video and audio signals from an external device to the TV. Connect the external device and the TV with the HDMI cable as shown in the following illustration.

#### ! NOTE

- Use the latest High Speed HDMI™ Cable with CEC (Customer Electronics Control) function.
- High Speed HDMI™ Cables are tested to carry an HD signal up to 1080p and higher.

Choose any HDMI input port to connect.  
It does not matter which port you use.

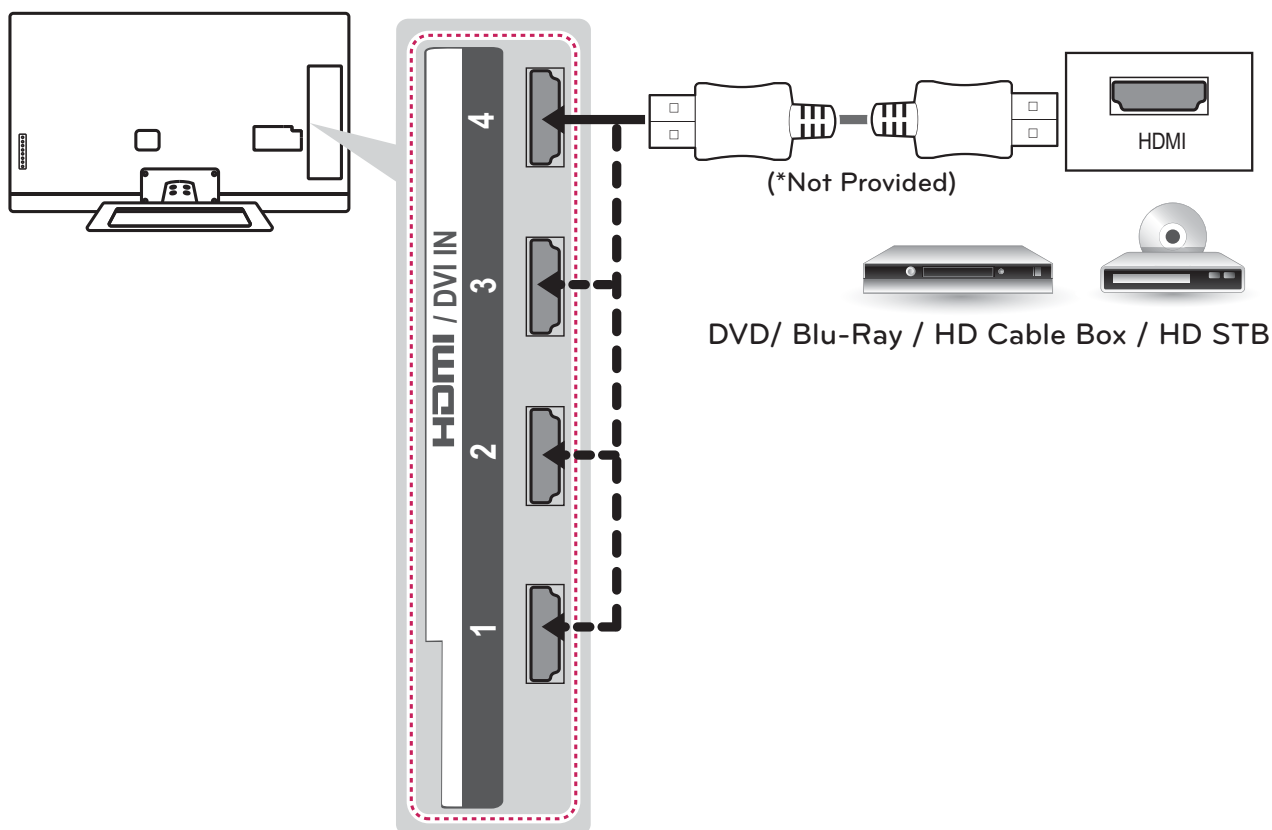

#### ! NOTE

- DTV Audio Supported Codec: MPEG, Dolby Digital
- HDMI Audio Supported Format: Dolby Digital, PCM (Up to 192 KHz, 32k/44.1k/48k /88k/96k/176k/192k) -> Not supported DTS.

## DVI to HDMI Connection

Transmits the digital video signal from an external device to the TV. Connect the external device and the TV with the DVI-HDMI cable as shown in the following illustration. To transmit an audio signal, connect an audio cable.

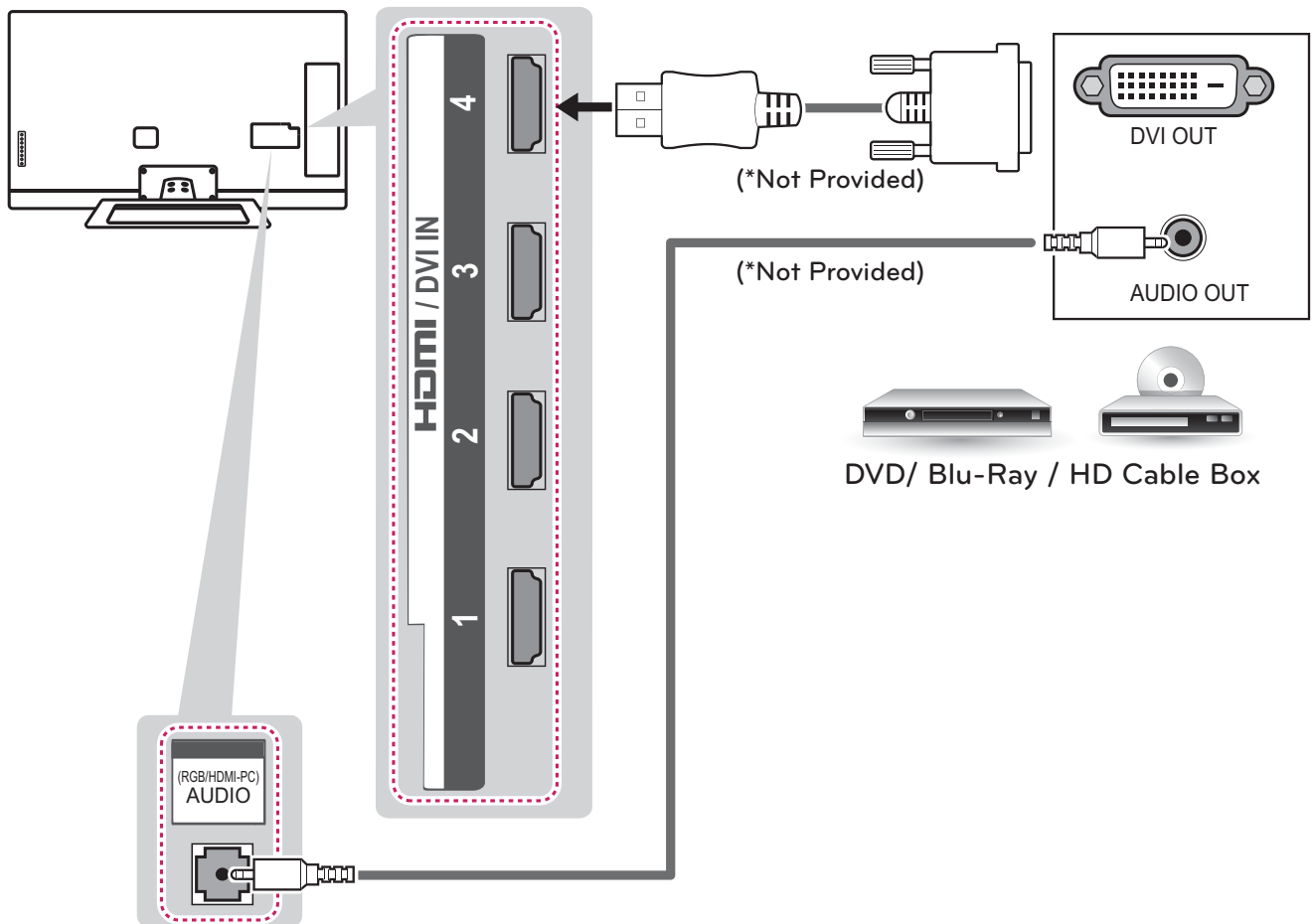

## Component Connection

Transmits the analog video and audio signals from an external device to the TV. Connect the external device and the TV with the component cable as shown in the following illustration.

**NOTE**

- If cables are installed incorrectly, it could cause the image to display in black and white or with distorted color.
- **Check to ensure each cable is matched with the corresponding color connection.**

ENGLISH

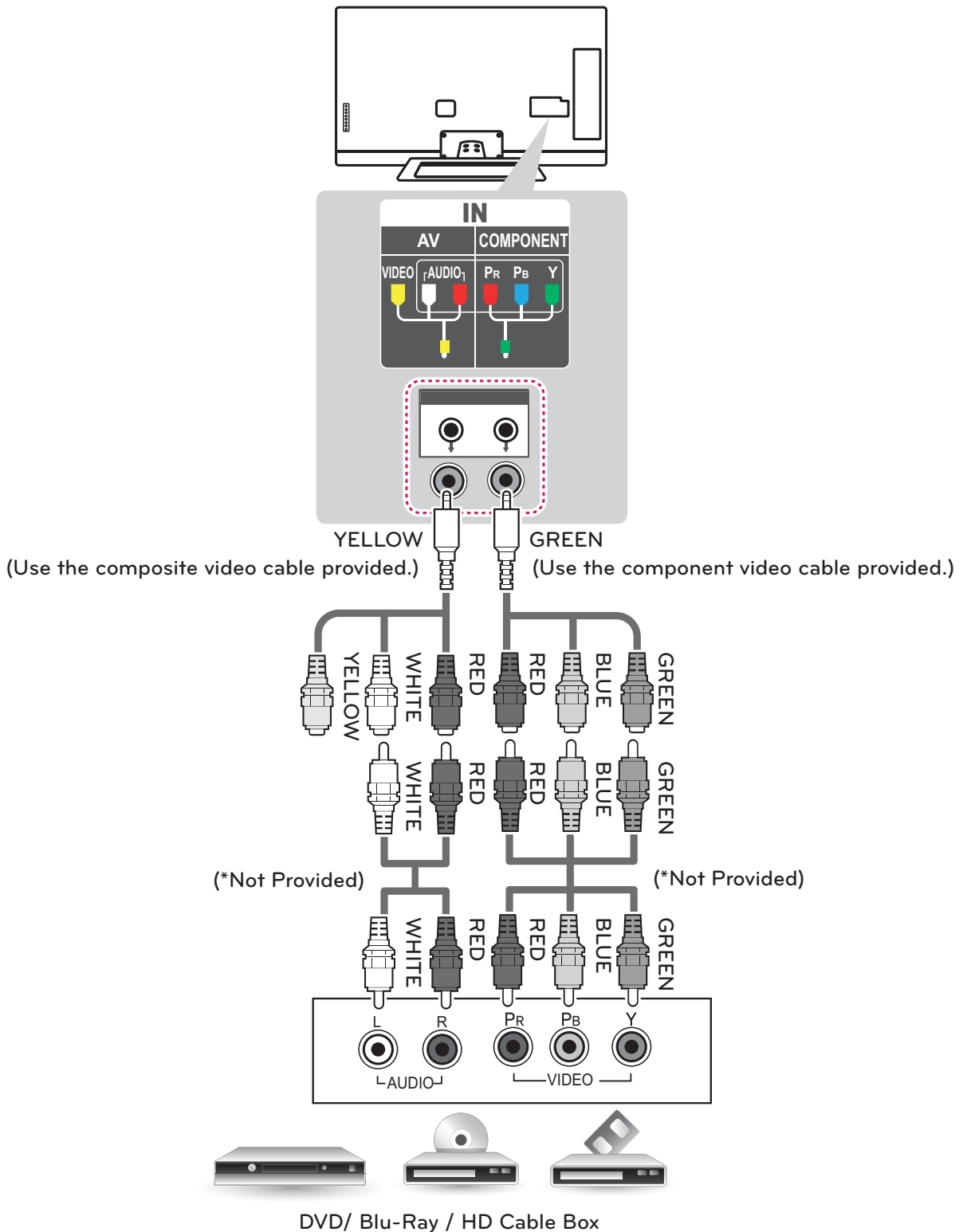

## Composite Connection

Transmits the analog video and audio signals from an external device to the TV. Connect the external device and the TV with the composite cable as shown in the following illustration.

### ! NOTE

- If you have a mono VCR, connect the audio cable from the VCR to the AUDIO L/MONO jack of the TV.

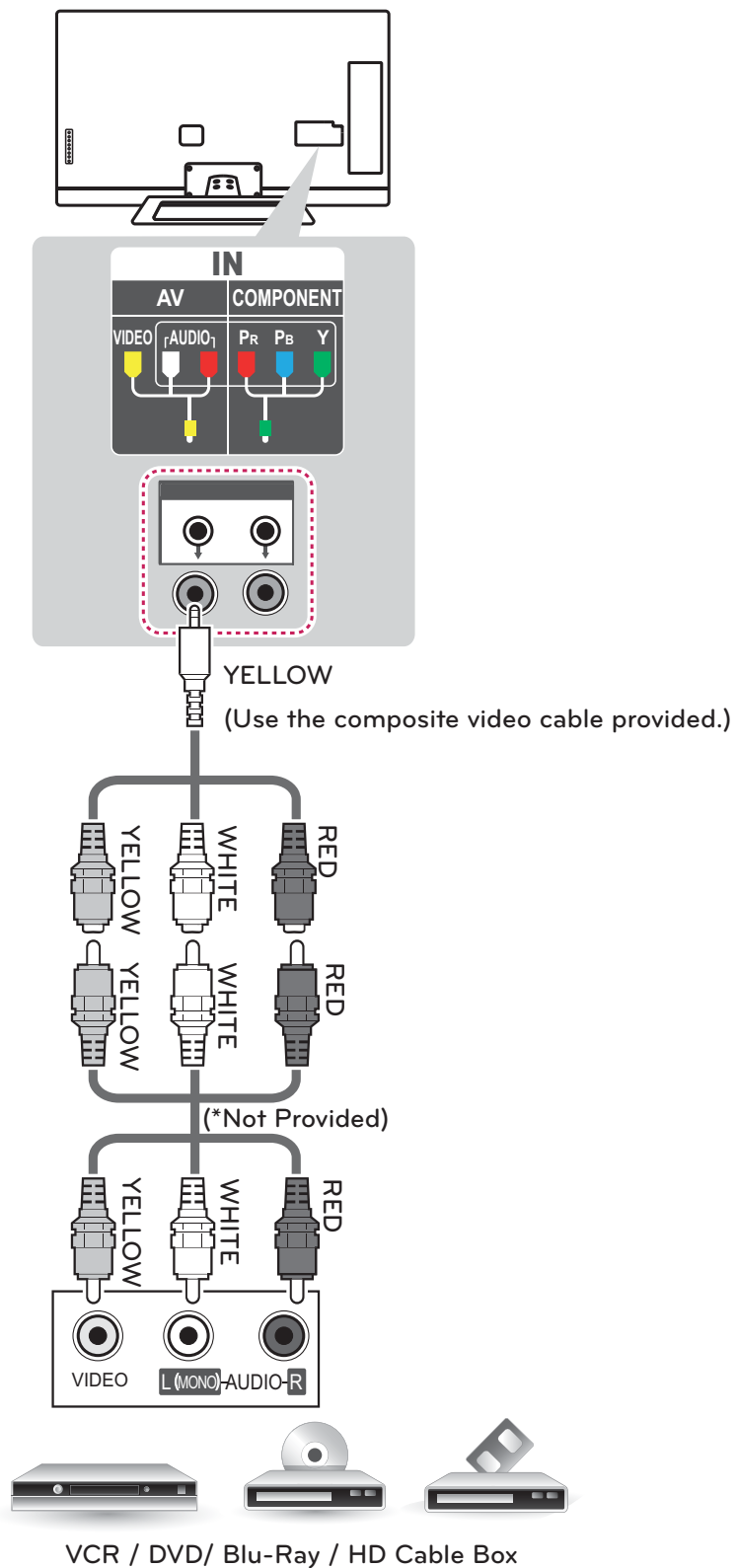



## Connecting to a PC

### NOTE

- It is recommended to use the TV with the HDMI connection for the best image quality.
- Depending on the graphics card, DOS mode may not work if a HDMI to DVI Cable is in use.
- In PC mode, there may be noise associated with the resolution, vertical pattern, contrast or brightness. If noise is present, change the PC output to another resolution, change the refresh rate to another rate or adjust the brightness and contrast on the PICTURE menu until the picture is clear.
- The synchronization input form for Horizontal and Vertical frequencies is separate.
- Depending on the graphics card, some resolution settings may not allow the image to be positioned on the screen properly.

## HDMI Connection, DVI to HDMI Connection or RGB Connection

Choose method A, B, or C to make connection.

### Method A: HDMI Connection

Choose any HDMI input port to connect.  
It does not matter which port you use.

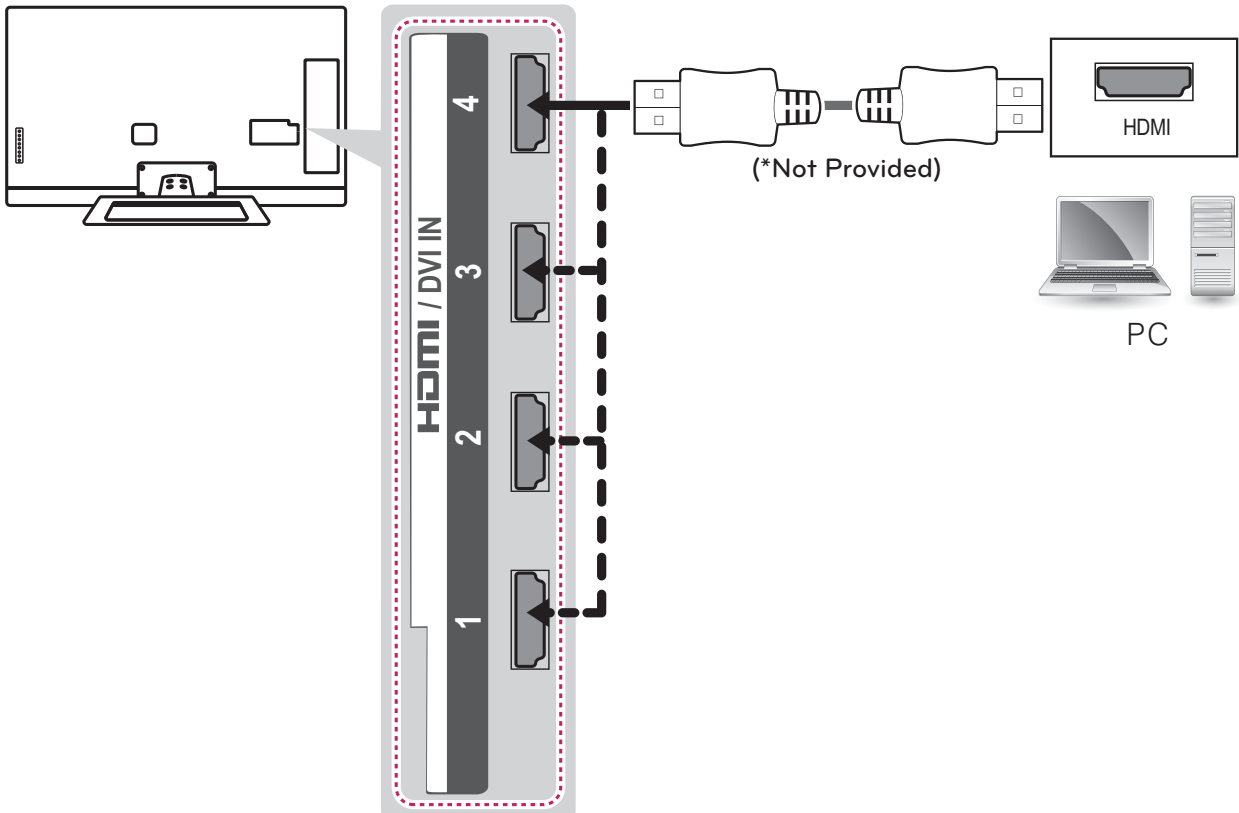

Method B: DVI to HDMI Connection

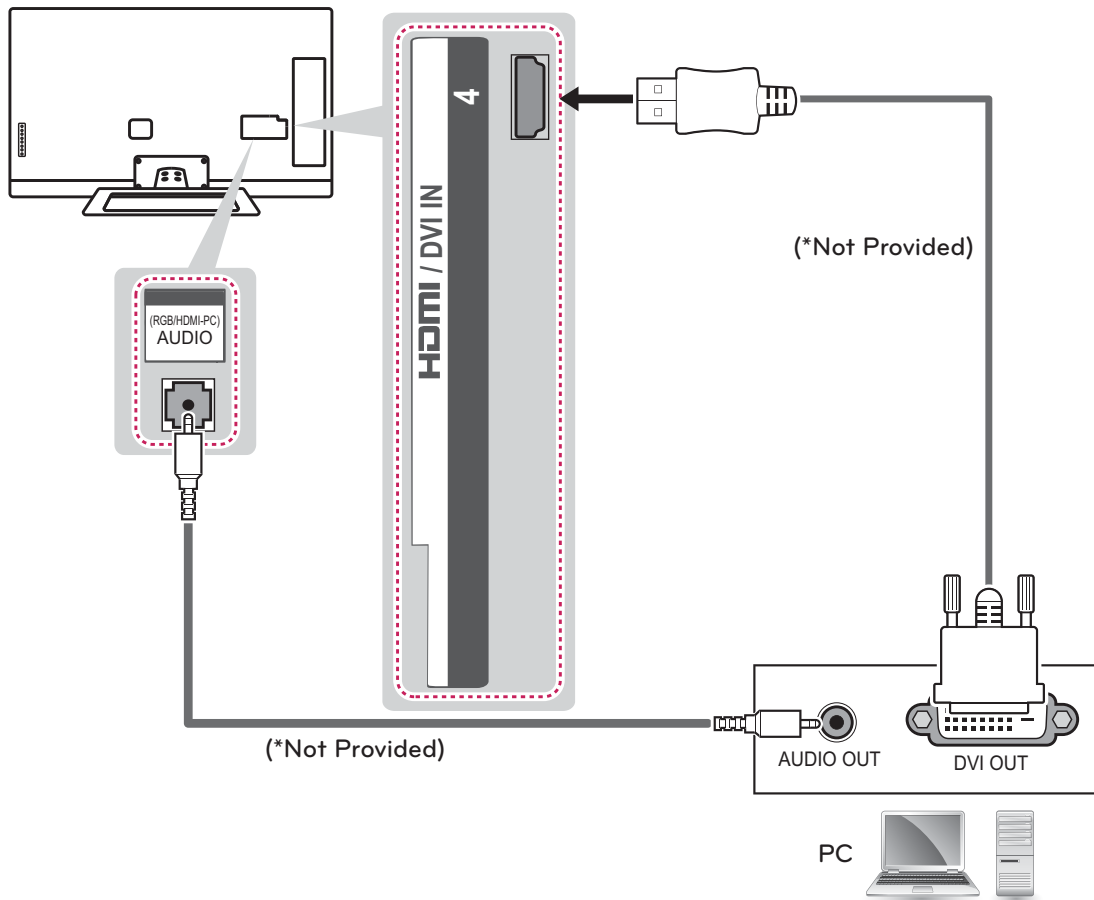

Method C: RGB Connection

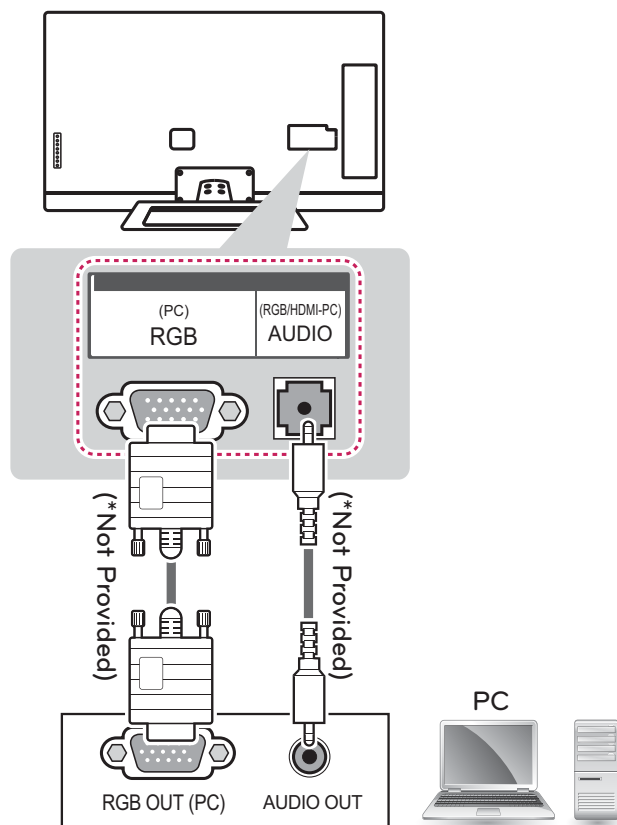

## Connecting to an Audio System

Use an optional external audio system instead of the built-in speaker.



### NOTE

- If you use an optional external audio device instead of the built-in speaker, set the TV speaker feature to off.

### Digital Optical Audio Connection

Transmits the digital audio signal from the TV to an external device. Connect the external device and the TV with the optical audio cable as shown in the following illustration.

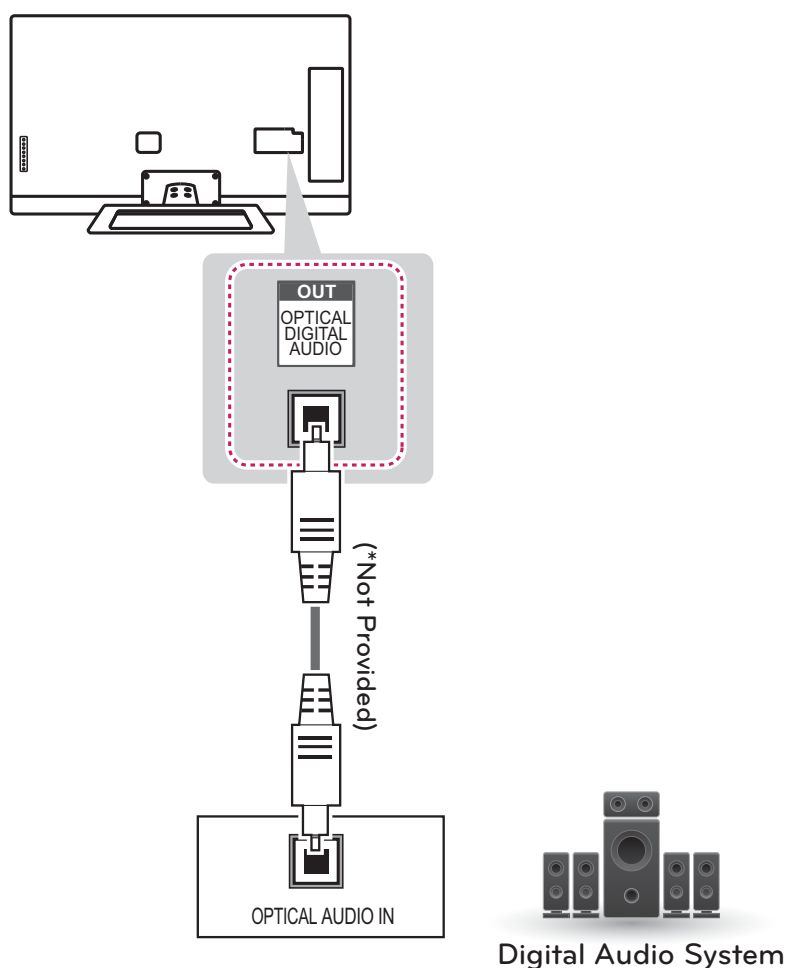

## Connecting to a USB

Connect a USB storage device such as a USB flash memory, external hard drive, or a USB memory card reader to the TV and access the My media menu to use various multimedia files.

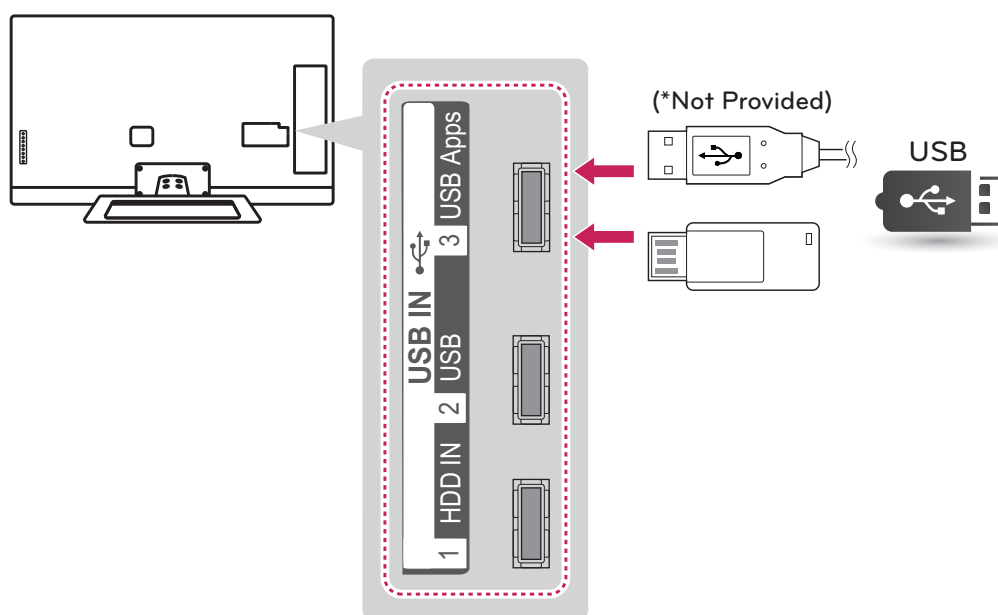

## USING (BASIC)

### Turning the TV on for the first time

When you turn the TV on for the first time, the Initial setting screen appears. Customize the basic settings.

- 1 Connect the power cord to a power outlet.
- 2 In Standby mode, press the power button on the remote control to turn the TV on.  
The Initial setting screen appears if you turn the TV on for the first time.
- 3 Follow the on-screen instructions to customize your TV settings according to your preferences.

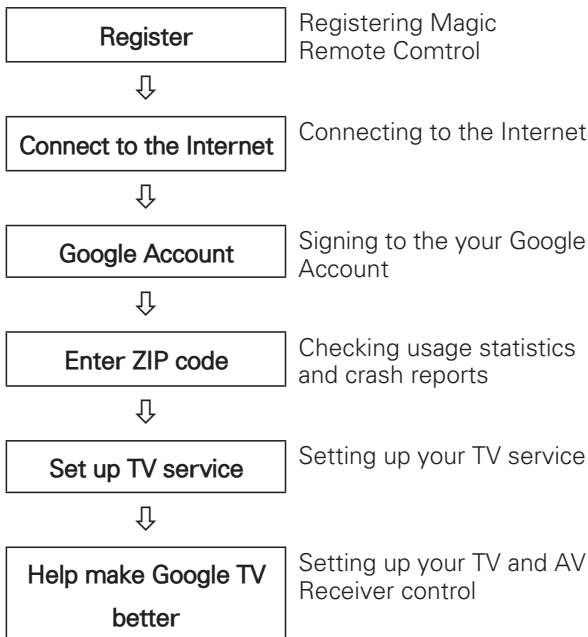

- 4 When the basic settings are completed, select **Finish**.



#### NOTE

- If you do not complete the Initial setting, it will appear whenever the TV turns on.

- 5 To turn the TV off, press the power button.

### Setting the Mode

- 1 Press **Home** to access the Home menu.
- 2 Go to **All Apps > Settings > Option > Mode Setting**.
- 3 Select **Store Demo** for in-store display. For use in-home, select **Home Use**.

## Accessing Home Menu

- 1 Press **Home** to access the Home menu.
- 2 Press the Navigation buttons to scroll to one of the following menus and press **ENTER**.
- 3 Press the Navigation buttons to scroll to the setting or option you want and press **ENTER**.
- 4 When you are finished, press **EXIT**.

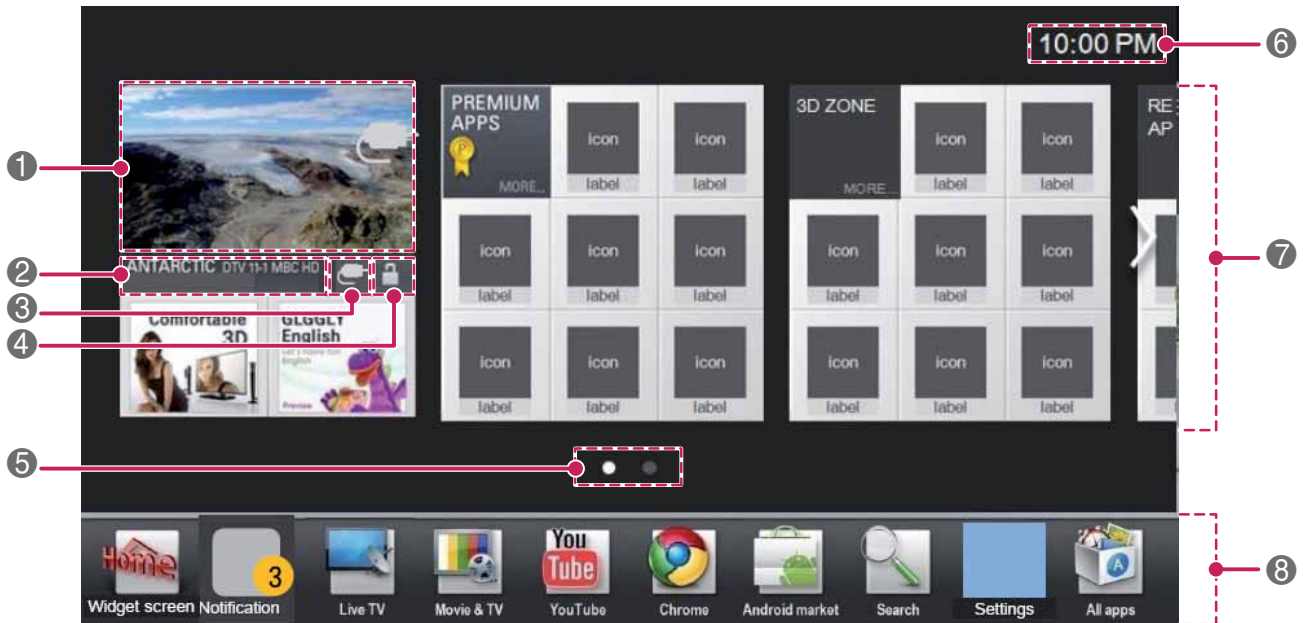

Option	Description
①	Current watching channel screen
②	Channel description
③	Input List
④	Settings
⑤	Current Page
⑥	Current Time
⑦	Home Dashboard
⑧	Launcher Bar

## Setting up channels

### Storing channels

To store channels automatically,

- 1 Press **Home** to access the Home menu.
- 2 Go to **All Apps > Settings > ATSC > Auto Tuning**.
- 3 Select **Start** to start automatic tuning.  
The TV scans and saves available channels automatically.
- 4 When you return to the previous menu, press **BACK**.

To store channels manually,

- 1 Press **Home** to access the Home menu.
- 2 Go to **All Apps > Settings > ATSC > Manual Tuning**.
- 3 Scroll through the channel types, and then add or delete channels.
- 4 When you return to the previous menu, press **BACK**.

### ! NOTE

- If the TV scans a blocked channel, you will be prompted to enter your password to keep the channel scanned.
- You can store up to 1000 channels. The number of channels that you can store differs depending on the broadcasting signal environment.
- The channels are stored in the order of **DTV, TV, Cable DTV** and **Cable TV**.

## Checking current program info

Press **INFO** to view the information of the currently program while you are watching. The following information appears at the bottom of the screen.

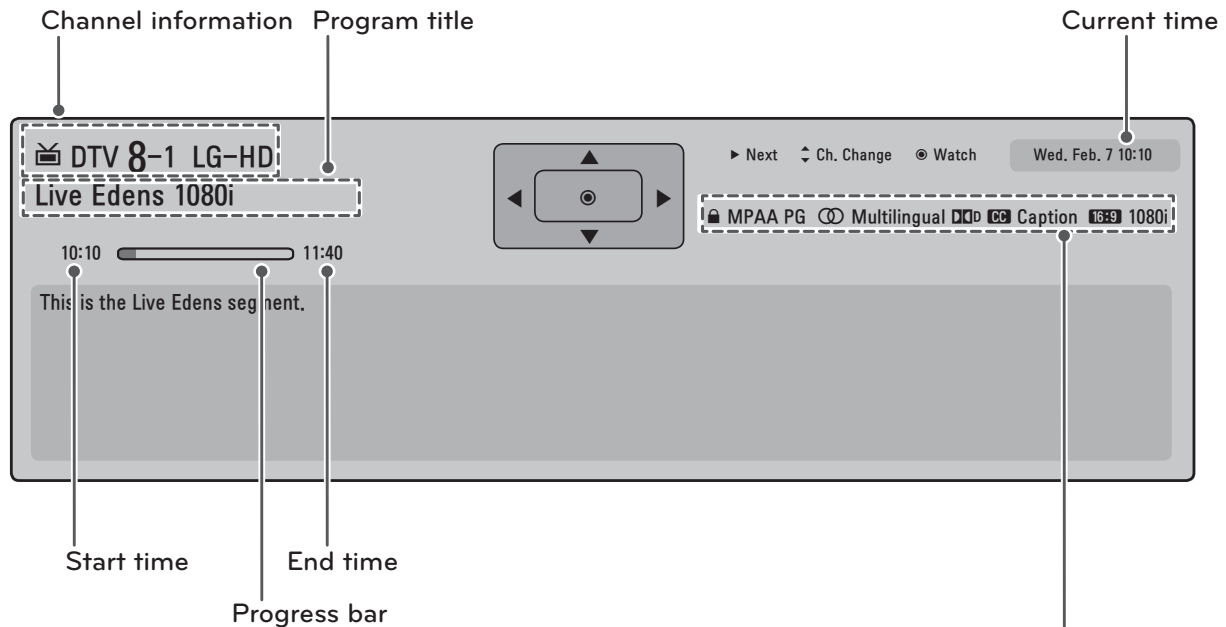

Icon		Description
Multilingual		The program contains two or more audio language services. You can change the audio language using the quick menu.
Dolby Digital		The program contains a Dolby Digital audio signal in TV and HDMI input sources.
Dolby Digital Plus		The program contains a Dolby Digital Plus audio signal in TV and HDMI input sources.
Caption		The program contains one or more language caption services. You can select a closed caption you want by using the quick menu.
Aspect ratio		The original aspect ratio of the video is 4:3.
		The original aspect ratio of the video is 16:9 (wide).
Resolution		The video resolution is 720 x 480i.
		The video resolution is 720 x 480p.
		The video resolution is 1280 x 720p.
		The video resolution is 1920 x 1080i.
		The video resolution is 1920 x 1080p.
V-Chip		The program contains Lock information.



## Adjusting aspect ratio

Resize an image to view its optimal size while you are watching TV.

- 1 Press **Home** to access the Home menu.
- 2 Go to **All Apps > Settings > Picture**.
- 3 Press the Navigation buttons to scroll to **Aspect Ratio** and press **Wheel**.
- 4 Select a display method.

### ! NOTE

- The available ratio varies depending on the input source.
  - The input sources: HDMI-PC and RGB-PC support 4:3 and 16:9.
  - The input sources: HDMI-PC 1920 X 1080 supports all of the aspect ratios.

- **16:9:** Resizes images to fit the screen width.



- **Original:** When your TV receives a wide screen signal it will automatically change to the picture format broadcast.



- **4:3:** Resizes images to the previous standard 4:3.



- **Cinema Zoom:** Formats an image to the cinemascope ratio, 2.35:1.
  - To change the ratio of the cinema zoom, press **<** or **>** and its range is from 1 to 16.
  - To move the zoom focus up or down, press **^** or **v**.



### ! NOTE

- If you enlarge or reduce an image, the image may be distorted.

## Using the input list

### Selecting an input source

- 1 Press **INPUT** to access the input sources.  
- The connected device displays on each input source.



#### NOTE

- You can also access the input source list by selecting **Input List** in the **Settings** menu.

- 2 Press the Navigation buttons to scroll to one of the input sources and press **OK**.

Input source	Description
<b>TV</b>	Watch TV over the air, cable, and digital cable broadcast.
<b>AV</b>	Watch video from a VCR or other external devices.
<b>COMPONENT</b>	Watch video from a DVD or other external devices, or through a digital set-top box.
<b>RGB-PC</b>	Use the TV as a computer monitor.
<b>HDMI</b>	Watch video from a HTS or other high definition devices.

### Editing input name

Edit the input name so that you can easily identify a device connected to each input source.

- 1 Press **Home** to access the Home menu.
- 2 Go to **All Apps > Settings > Input List > Edit Input Name**.
- 3 Input **New Input Name** and select **Set**.
- 4 When you return to the previous menu, press ↶ (**BACK**).

## Using the customer support

### Testing the Picture / Sound

To execute picture and sound tests.

- 1 Press **Home** to access the Home menu.
- 2 Go to **All Apps > Settings > Customer Support > Picture Test** or **Sound Test**.
- 3 If you have any problem, select **OK**. LG customer service center and product information appears. Contact LG customer service center for help.
- 4 When you are finished, select **Close**.  
When you return to the previous menu, press **↶ (BACK)**.

### Using the product or service information

To check the product or service information

- 1 Press **Home** to access the Home menu.
- 2 Go to **All Apps > Settings > Customer Support > Product/Service Info.**
- 3 You can check the various Product/Service information based on your model.
- 4 When you are finished, select **Close**.  
When you return to the previous menu, press **↶ (BACK)**.

# APPLICATIONS

## Google Chrome

### Getting started

- 1 Select the Google Chrome in **Home** or in **All Apps**, or simply by typing a URL or search query directly into the search bar. Use the **Search** key to open the search bar.
- 2 While using Google Chrome, press the **Menu** key to manage your browser windows, bookmarks, viewing history, and more. Select **Settings** to configure your browser settings.

### Browser windows

- To open a new window, press the **Menu** key, select **Windows**, then select **New window** or press **Ctrl + T** on your controller.
- To view all open windows, press the **Menu** key and select **Windows**. You can have 3 open Chrome windows at one time.
- To reload a browser window, press the **Menu** key and then **Reload** or press **Ctrl + R** on your controller.

### Google Chrome shortcuts

<b>Ctrl + R</b>	Reloads the current tab
<b>Ctrl + ↑</b>	Zooms in
<b>Ctrl + ↓</b>	Zooms out
<b>Ctrl + 0</b>	Resets zoom level to 100%
<b>Ctrl + T</b>	Opens a new tab
<b>Ctrl + Shift + T</b>	Opens a new tab in an incognito window
<b>Ctrl + W</b>	Closes the current tab
<b>Ctrl + D</b>	Add to Bookmarks or Home Screen.
<b>Ctrl + F</b>	Opens the find on page bar
<b>Space bar</b>	Scrolls down the current web page

### Browsing history

- To access your Google Chrome browsing history, press the **Menu** key and select **History**. To clear your history, select **Clear history**.
- To clear all browsing data, including clearing your cache, history and cookie data, press the **Menu** key and select **Settings**.

### Incognito Browsing

If you don't want your website visits to be recorded in your browser history, you can browse in incognito mode. To open a new incognito window, press the **Menu** key, select **Windows**, then select **New incognito window** or press **Ctrl + Shift + T** on your controller.

## Bookmarks

Bookmarking allows you to save websites without having to remember URLs. Your web bookmarks are located within your Google Chrome browser for easy access while you're surfing the web.

### To Bookmark a Webpage:

- 1 Open Google Chrome.
- 2 Navigate to the webpage you want to bookmark.
- 3 Press the ☆ **Star** key on your controller, or press the ≡ **Menu** key then select **Save**.
- 4 From the following menu, select **Add to bookmarks** or **Add to home screen**. You can name your bookmark on the next screen.
- 5 Select **OK** to save changes.

### To Access your Bookmarks:

- 1 Open Google Chrome.
- 2 Long-press (press and hold) the ☆ **Star** key, or press the ≡ **Menu** key and select **Bookmarks**.

### To Delete a Bookmark:

- 1 Open your bookmarks using the steps above.
- 2 Navigate to the bookmark you'd like to delete, then long-press (press and hold) the **Enter** or **OK** key on your remote.
- 3 Select **Delete bookmark**.

## Safety and security settings

### Lock Google Chrome

Lock Google Chrome by setting a PIN password to open the application. Press the ≡ **Menu** key and select **Settings**. Under **Privacy & safety**, select **Chrome lock settings**.

#### ! NOTE

- Locking Google Chrome will also lock the Android Market with the same PIN.

### Enable SafeSearch:

Enabling SafeSearch on Google Chrome is a little bit different from enabling it for Google TV Search. To enable SafeSearch for in-browser searches, press the 🔍 **Search** key and enter <http://www.google.com/preferences>. Select your preferred option under SafeSearch Filtering. Visit this article for more information about SafeSearch on Google.

## Advanced settings

Press the ≡ **Menu**, select **Settings**, then **Advanced settings** to configure several advanced options, including:

- **Personal Stuff**
  - Passwords
  - From autofill
- **Under the Hood**
  - Privacy
  - Web Content
  - Security
  - User Agent

# Android Market

## Getting Started

The Android Market offers easy access to Android applications available on Google TV. These have been created by developers all around the world, and have been rated by your fellow users.

### Google Accounts and the Android Market

The first time you open the Market, you'll be prompted to select your Google Account. This will be the default Google Account for Market purchases and downloads.

All items downloaded to your Google TV will be accessible under **All Apps** (press the **Home** key and select **All Apps**), regardless of which Google Account was used to download them.

## How to download or remove apps

### Downloading Apps

#### Free Apps

- 1 Navigate to an item you want to install and select it. The item details screen will appear and you can read more about the item and its developer.
- 2 If you want to install the item, select the **INSTALL**. Allow access appears.
- 3 Select **Install** to accept the permissions for the app, the item will start downloading immediately.

#### Paid Apps

- 1 Navigate to an item you want to install and select it. The item details screen will appear and you can read more about the item and its developer.
- 2 If you want to install the item, select the **BUY** button.
- 3 Press **Continue** to accept the permissions for the app.

### ! NOTE

- You may be asked to sign in to your Google Checkout account if it's the first time you're purchasing from the Android Market.
- Sign in and select **Purchase now** if you want to proceed.

### Removing Applications

- 1 On your Android device, open the Market app and select **My apps** from the Market home screen. (On some devices, press **Menu** and then select **My apps**)
- 2 Select the item you'd like to uninstall.
- 3 On the application home screen, select the **"Uninstall"** button.

### ! NOTE

- You will be able to return to **My apps** at any time to reinstall a purchased application that you've previously removed.

## Charges

### When to Expect Charges

Once you place an order, charges generally post to your credit/debit card within a few days. Check your receipt in the **Purchase History** section of your account to see if your card has been charged or the exact date your credit/debit card was charged for your purchase.

Please note, if you cancelled your order within the first 15 minutes, rest assured that your credit/debit card has not been charged. Any line items on your statement are only authorizations.

### Charges and Cancelled Orders

If you believe you were charged for an order you cancelled, please verify that your order was cancelled in your Google Checkout account. Here's how:

- 1 Sign in to your account at <https://checkout.google.com/>.
- 2 On the **Purchase History** page, click **View Order** next to the order containing the item you'd like to review.
- 3 If your order has been cancelled, the order details should read **Your order has been cancelled**.



#### NOTE

- If your order has been cancelled, the pending amount that you've noticed on your credit/debit card statement is only an authorization, not an actual charge.
- If your order details do not reflect cancellation, or if you're waiting for a refund, learn more about cancelling your order directly through the seller.

## Returning apps

### Refund Policy

You have **15 minutes** from the time of download to return an application purchased through Android Market for a full refund. You may only return a given application once; if you subsequently purchase the same app again, you may not return it a second time.

### How to return an app within the 15 minute return period:

- 1 Launch Android Market on your device
- 2 Select **Menu > My Apps**
- 3 Select the app you'd like to return

#### NOTE

- If the 15 minute refund window has not yet passed, the app is eligible for return and will have two buttons saying "Open" or "Refund"

- 4 Select the **Refund** option

#### NOTE

- The Refund button will now say "Uninstall." Press "Uninstall" to remove the app from your device and initiate the refund.
- After the 15 minute return period has expired, the Refund option will not be available. Selecting the "Uninstall" button at this point will simply remove the application from your device.

### After the 15 minute return period:

If you're unsatisfied with an application after the 15 minute return period has expired, we recommend contacting the developer directly.

### You may find developers' contact information here:

1. Go to Android Market and select the app in question.
2. On the app's description page, scroll down to the "Developer" section
3. One of the following contact options will be provided: an email address, a phone number, or a website.



## Live TV

Google TV works with your existing cable or satellite TV service to help you find what you want to watch through search and to bring you access to the full internet to find great web content.

### To Watch Live TV:

- 1 Press the **TV** key on your controller, **or**
- 2 Press the **Home** key on your controller and navigate to **TV**.

### To Save a TV Channel to your Favorites:





- 1 Press the ☆ **Star** key and select **Add channel to favorites**, **or**
- 2 Long-press the ☆ **Star** key and select **Add channel**.
- 3 Choose the channel you wish to add, then press the **Enter or OK** key on your controller.

### To Access your Saved Favorites:

- 1 Press the ☆ **Star** key on your controller and select **View favorite channels**, **or**
- 2 Long-press the ☆ **Star** key, **or**
- 3 Press the ≡ **Menu** key and select **Favorite channels**.

## Picture in Picture



Picture in Picture allows you to watch a live TV feed while simultaneously using other features on your Google TV. Surf the web, browse pictures, or play a game without missing a second of your favorite TV program.

When watching live TV, press the  **Picture in Picture** key to minimize the TV feed to a smaller window, then press  **Home** or  **Search** to access other features and apps. To return to viewing live TV in full screen, press the  **Picture in Picture** key again.

### Open a Picture in Picture TV feed from another app

- 1 While using another app, long-press (press and hold) the  **Picture in Picture** key
- 2 Select **TV**.

### Picture in Picture Settings

- 1 To edit your settings, click on the  **Picture in Picture** window on your TV **or**
- 2 Long press (press and hold) the  **Picture in Picture** key.
- 3 To exit settings, press **Back** or **Esc**.

### TV and DVR shortcuts

<b>Tab</b>	Recalls the previous channel
<b>Menu + G</b>	Opens the TV guide
<b>Menu + L</b>	Returns to live TV from DVR content
<b>Menu + D</b>	Opens the DVR menu
<b>Menu + I</b>	Shows information for the current show
<b>Ctrl + D</b>	Bookmark channel, share, or record program

## 3D World

This TV can display in 3D via 3D broadcasting or when the TV is connected to a compatible device, such as a Blu-ray 3D Player. The viewer must wear compatible 3D glasses in order to see these images in 3D format.

### When watching 3D imaging

- To watch the TV in 3D, you must put on your 3D glasses. For best results, you should wear LG Brand 3D glasses. The 3D imaging may not display properly when using another brand of 3D glasses. Please see the 3D glasses manual for instructions on how to use the 3D glasses.
- When watching 2D images, it is recommended to take off the 3D glasses. If you watch 2D images with the 3D glasses on, you may see distorted images.
- We recommend that you maintain a distance of at least twice the screen diagonal length when watching 3D videos.



#### NOTE

- If 3D TV broadcast standard changes in the future and it is not supported by this TV set, you may need a separate device, such as a set-top-box.

### When using 3D Glasses

- Do not use the 3D glasses to replace your corrective glasses, sunglasses or protective goggles.
- Do not store the 3D glasses in hot or cold locations.
- Do not drop objects onto the 3D glasses. Do not drop or bend the glasses.
- Since the lenses of the 3D glasses are easily scratched, make sure to clean only with a soft cloth. Shake off any dust before using the cloth since the glasses are easily scratched.

- A communication failure may occur if the glasses are near electronic devices that use the same bandwidth (2.4 GHz), such as a microwave oven or wireless LAN product.

### Viewing 3D Imaging

- 1 Play the video produced in 3D.
- 2 Press **3D** to watch 3D imaging.
- 3 Wear the 3D glasses.
- 4 Press the Navigation buttons to scroll the **OK** and press **ENTER**.
- 5 Press the Navigation buttons to select the shape and press **ENTER**.

**2D » 3D**

Changed from 2D imaging to 3D imaging.

2D-to-3D converted videos may appear less realistic than titles originally produced as 3D videos.



**Side by Side**



**Top & Bottom**



**Checker Board**



**Frame Sequential**



- 6 Press **3D** button to **2D Off** or **3D Off**.

**3D -> 2D**

Displays images in 2D without any 3D effects.

**3D Off**

Displays images in original format.

**2D -> 3D**

Displays images in 3D.

**Cancel**

Close the pop-up window.

## Setting 3D Imaging

- 1 Press the **3D OPTION** while viewing 3D imaging.  
A pop-up window will appear.
- 2 Press the Navigation buttons to scroll to one of the following options and press **ENTER**.

### 3D Mode Setting

<b>3D Picture Size</b>	Cuts off the outer edges of the picture and stretch it to fit the full screen in 3D mode.
<b>3D Picture Correction</b>	Select <b>Left/Right</b> or <b>Right/Left</b> . Select the screen with 3D video with better visibility.
<b>3D Depth</b>	Adjusts the stereoscopic effect of the 3D image converted from 2D image.
<b>3D Viewpoint</b>	Moves the 3D image to front and back to adjust the 3D perspective view.
<b>3D Picture Balance</b>	Adjusts the color and brightness difference between the right and left sides of the picture in 3D mode.
<b>3D Optimization</b>	Optimizes the 3D image screen for the viewing environment.

### Set Video.

Allows you to change Video settings (Refer to "Picture" on p.57).

### Set Audio.

Allows you to change Audio settings (Refer to "Audio" on p.59).



### CAUTION

- Some menus may not work while viewing 3D imaging.
- The 3D imaging is disabled automatically when switching input source or DTV channel.
- The screen may not be displayed properly if you view 2D images in 3D imaging mode.
- 3D effect can be seen when 3D Mode is selected appropriately for the 3D input signal supplied to the TV.
- For \*.mpo files (3D camera files), the 3D imaging mode is enabled automatically.



### NOTE





- If viewing 3D imaging, "Power indicator" is turned off automatically.
- You can only choose "Off or **Cinema**" with the **AV MODE** button on the remote control.
- Energy Saving is disabled while playing in 3D.
- Home menu is not available while playing in 3D.
- You cannot enter the Home menu while watching 3D imaging.

## Media Player

Play back audio/video/image files.

- 1 Insert a USB device containing files into the USB jack.
- 2 Go to **All Apps > Media Player**.
- 3 Select a file from the list and press **OK**.

### Keys available during playback

-  Starts or re-starts playback (video/music playback). Starts Slideshow or starts moving a panoramic photo (photo playback)..
-  Pauses or re-starts playback (video/music playback) /Slideshow (photo playback). Pauses or re-starts movement of a panoramic photo (photo playback).
-  Stops playback and returns to the file list (video/music playback). Stops Slideshow or Image viewer, and returns to the file list (photo playback).
-  Fast rewinds/Fast forwards the title/track. The search speed changes each time you press the button during playback.
-  Skips to the previous/next title (video playback)/track (music playback)/file (photo playback).



### NOTE

- USB devices must be less than 2TB.
- Connection via a USB-hub is not supported.

## Options

Various settings and playback operations are available by pressing **MENU** during playback. The available items differ depending on the situation.

### Photo playback

- Slide show** You can start (Play Slideshow) or pause (Pause Slideshow) a slideshow.
- Rotate** You can rotate photo files counterclockwise (Left) or clockwise (Right) by 90 degrees.
- Slide show setting** You can adjust the speed or random play of the slide show.

## Netflix

Sign in to your Netflix® account to browse by genre, search for titles, manage your Instant Queue and review Netflix® recommendations all from your Google TV. If you do not have a Netflix® account, you will need to create a new account to use this feature.

For more information, visit [www.Netflix.com](http://www.Netflix.com).

Watch TV shows and movies online or by streaming them from Netflix.

## Photos

Browse photos on a photo sharing website, such as Picasa. You can also browse photos in the connected USB devices.

### To View Albums from Local Media

- 1 Insert your USB device into the USB slot on your TV.
- 2 In the **Photos** app, navigate to **Local media** on the left navigation bar.
- 3 Select your USB device and you will then be able to navigate through the folders on your device.

### To Link your Picasa Album:

- 1 While in the **Photos** app, press the **≡ Menu** key on remote control or select **Options** on the left navigation.
- 2 Select **Settings**. Check the box next to the account that you want to link to the **Photos** app.
- 3 If your Google account is not listed, select **New Account** where you will be asked to Create a new account or Sign-In to an existing account.

## Search

- 1 Press the **Q Search** key on your remote control. The **Q Search** key works no matter where you are on your Google TV, and searches across all applications, bookmarks, TV content, web video, and web pages.
- 2 When you enter a search query, a drop-down list will display a selection of results.
- 3 Navigate search results using the directional arrow keys, then press **Enter** to select an option. You can also enter a URL into Google TV search to navigate directly to a website.

### To customize Search Results

It's easy to configure your Google TV search experience to include results from TV & Movies, Apps, Podcasts, and more.

- 1 Press the **Q Search** key, type 'Settings,' and select the **Settings** application.
- 2 Select **Search**, then **Searchable items** to customize what appears when you search.

### SafeSearch

Use SafeSearch to block adult content from appearing in search results.

- 1 Press the **Q Search** key, type 'Settings,' and select the **Settings** application.
- 2 Select **Privacy & safety**, navigate to **Safety**, and select **SafeSearch**.

## TV & Movies

TV & Movies is the simplest way to find shows and movies to watch instantly. In addition to live TV, you can browse and search for video on demand options, and filter results by price (paid vs. all) and streaming quality (HD vs. all).

### ! NOTE

TV & Movies provides:

- Access to content from your Netflix subscription
- Access to web video content from 100+ web domains
- Access to VOD rentals on Amazon and YouTube

### To access TV & Movies:

- 1 Press the **Home** key and select **TV & Movies**.
- 2 Once in **TV & Movies**, use the left navigation bar to filter by **On TV**, **Shows** and **Movies**

### To filter available TV & Movies:

- **On TV:** Use the top toolbar to filter live TV listings by time and quality (HD or HD & SD)
- **Shows:** Use the top toolbar to filter shows by price (free or free & paid) and quality
- **Movies:** Use the top toolbar to filter movies by price and quality

## YouTube

Full-length feature films from many major Hollywood studios are now available for rent on YouTube. Discover a universe of related remixes, clips, and behind the scenes footage with YouTube Movie Extras. On Google TV, navigate to YouTube.com/Movies to browse and search for movies, and rent titles using your Google Account.

Google TV offers two different YouTube experiences:

- The YouTube on TV app, an Android-based app that makes it easy to find and watch content on YouTube.
- Through **YouTube.com**: Use the Chrome browser to access the desktop YouTube experience you're used to.



### NOTE

- YouTube Movies (video-on-demand rentals) are currently only available through the YouTube.com experience.
- Browse movies and shows in TV & Movies or at YouTube.com/movies. To learn more about Google TV's video on demand options, please visit the Video on Demand article.

# SETTINGS

## The Main Menu

You can review or edit your TV settings by typing **Settings** into the Search bar or by navigating to **Settings** in **All Apps**. Add Settings as a shortcut to your Home Bar by pressing the **Home** key, then **Menu** key, selecting Customize home items and adding/replacing a current shortcut with the **Settings** shortcut.

You will be able to review or update the TV settings including:

<b>Network</b>	Manages Internet connection.
<b>Video input</b>	Sets up TV service provider.
<b>Picture &amp; sound</b>	Adjusts resolution, screen size, sound effects.
<b>ATSC</b>	Sets the channel.
<b>Input List</b>	Views the input sources with their labels.
<b>Picture</b>	Adjusts resolution, screen size.
<b>Audio</b>	Adjusts the sound quality, effect, or volume level.
<b>3D Setting</b>	Sets up 3D mode.
<b>Search</b>	Manages searchable items, clear shortcuts.
<b>Applications</b>	Manages applications and development options.
<b>Language &amp; input devices</b>	Manages system language, input devices, IP remotes.
<b>Account &amp; sync</b>	Manages accounts and sata sync.
<b>Privacy &amp; safety</b>	Manages privacy, safety and lock settings.
<b>Storage</b>	Unmounts USB storage, view available storage.
<b>Date, time &amp; location</b>	Sets date, time, time zone and formats.
<b>Safety(Lock)</b>	Locks or unlocks channels and programs.
<b>Accessibility</b>	Manages accessibility options
<b>About</b>	System information
<b>Option</b>	Manages system option.
<b>Customer Support</b>	Checks the customer information.



## Network

Manages Internet connection.

<b>Ethernet</b>	You can check the status of the wired network connection.
<b>Wi-Fi</b>	You can select an available Wi-Fi network from the list of Wi-Fi networks found in your area or set up a new Wi-Fi network.
<b>Status</b>	You can check the network information, such as IP address, Ethernet MAC address, and Wi-Fi MAC address.

## Video input

### Edit configured devices

You can select the device to control or to set as the tuner.

### Select available source

To add a device, select it from the list. You can add a device you want to control using the IR Blaster.

## Picture & sound

Adjusts resolution, screen size, sound effects.

### Picture

<b>Resolution</b>	Selects output resolution
<b>Picture size</b>	Maximizes your screen area.
<b>Screen saver</b>	Adjusts the screen saver timeout.
<b>Screen off timeout</b>	Sets the time to turn off the TV automatically. To use this function, you should set the current time and date in advance.

### Sound

<b>Volume</b>	Adjusts the volume level.
<b>Sound effects</b>	Set the sound effects enabled or disabled.
<b>Notification sounds</b>	Select <b>Silent</b> if you want to silence the notification sounds.
<b>Text-to-speech</b>	Sets the time to turn off the TV automatically. To use this function, you should set the current time and date in advance.

## ATSC

The available settings are described in the following.

<b>Auto Tuning</b>	Tunes and stores all available channels through antennas or cable inputs.
<b>Manual Tuning</b>	Tunes and stores the channels you want manually.

## Input List

Views the input sources with their labels. You can select a input source.

## Picture

The available network settings are described in the following.

**Energy Saving** Reduces the power consumption by adjusting the screen brightness.

**Picture Mode** Selects one of the preset image or customizes options in each mode for the best TV screen performance. You are also able to customize advanced options of each mode. The available preset picture modes vary depending on the TV.



### NOTE

- If you select **Intelligent Sensor**, the Energy saving feature will switch to **Auto** automatically.

**- Backlight** Adjusts the brightness of the screen by controlling the LCD backlight. If you decrease the brightness level, the screen becomes darker and the power consumption will be reduced without any video signal loss.



### NOTE

- If you use the “**Energy saving - Off, Minimum, Medium**”, Backlight will be available.

**- Contrast** Increases or decreases the gradient of the video signal. You may use Contrast when the bright part of the picture is saturated.

**- Brightness** Adjusts the base level of the signal in the picture.

**- Sharpness** Adjusts the level of sharpness in the edges between the light and dark areas of the picture. The lower the level, the softer the image.

**- Color** Adjusts intensity of all colors.

**- Tint** Adjusts the balance between red and green levels.

**- Color Temperature** Set to warm to enhance hotter colors such as red, or set to cool to enhance cooler colors such as blue.

**Advanced Control** Customizes the advanced options.

**Picture Reset** Restores the options of each mode to the factory default.

**Aspect Ratio** Changes the image size to view images at its optimal size.

**SCREEN (RGB-PC)** Customizes the PC display options.

Resolution	Selects a proper resolution.
Auto Configure	Sets the TV to optimize the options automatically for the TV display.
Position	Locates the image at the proper position.
Size	Adjusts the image size.
Phase	Eliminates horizontal streaking.
Reset	Restores the options to the default setting.

**Picture Wizard** Adjusts the image quality and calibrates the screen. The customized options will be saved as **Expert1** in the **Picture Mode**.



### NOTE

- If you use **Picture Wizard**, the **Energy Saving** feature will turn off automatically.
- To reset changes made by **Picture Wizard**, operate **Picture Reset** when **Picture Mode** is on **Expert1**.

## Audio

<b>Sound Mode</b>	Sets the sound mode.
<b>User E●</b>	Setting User Equalizer.
<b>Volume Mode</b>	Select Auto Volume mode or Volume level.
<b>Sound Optimizer</b>	Optimizing the sound to Normal, Wall Mount Type or Stand Type.
<b>Virtual Surround</b>	Selects Virtual Surround mode.
<b>Clear Voice</b>	Sets the clear voice mode.
<b>AV Sync</b>	Synchronize AV, TV Speaker or SPDIF.
<b>Sound Setting</b>	Sets the sound balance, TV speaker enable or Digital sound out format.

## 3D Setting

<b>3D-On-Start-Setting</b>	
<b>3D Mode</b>	
<b>3D Depth</b>	Adjusts the stereoscopic effect of the 3D image converted from a 2D image.
<b>3D Viewpoint</b>	Moves the 3D image to the front and back to adjust the 3D perspective view.
<b>3D Color Correction</b>	
<b>3D Sound Zooming</b>	
<b>Normal Image View</b>	
<b>3D Image Correction</b>	Select <b>Left/Right</b> or <b>Right/Left</b> . Select the screen with 3D video with better visibility.

## Search

Manages searchable items, clear shortcuts

<b>Searchable items</b>	Chooses applications to search.
<b>Clear shortcuts</b>	Clears shortcuts to recently chosen search suggestions.

## Applications

Manage applications and development options.

<b>Manage applications</b>	Manages and remove installed applications.
<b>Running services</b>	Views and control currently running services.
<b>Development</b>	Set options for application development

## Language & input devices

Manage system language, input devices, IP remotes

<b>Manage IP remotes</b>	Connect and disconnect IP remotes.
<b>Chrome to TV</b>	Push links to this device from Google Chrome.
<b>Pointer speed</b>	Adjusts mouse and trackpad speed.
<b>Select language</b>	Selects a language
<b>Current keyboard</b>	Configures current keyboard
<b>Configure input methods</b>	Configures input methods.

## Accounts & sync

Manages accounts and data sync.

### General sync settings

<b>Background data</b>	Applications can sync, send and receive data at anytime.
<b>Auto-sync</b>	Applications sync data automatically.

### Manage accounts

You can clear the saved password or remove account.

<b>Add account</b>	Adds a new account.
--------------------	---------------------

## Privacy & safety

Manages privacy, safety and lock settings.

### Personal data

<b>Reporting</b>	Automatically send Google TV usage statistics and crash reports to Google.
<b>Factory data reset</b>	Erases all data on device.
<b>Video history</b>	Enable history of video watching such as TV channels.
<b>Clear video history</b>	Erases the video history.

### Safety

<b>SafeSearch</b>	Block adult content from appearing in search results.
<b>Application lock</b>	Require PIN to use Google Chrome & Market.

### Backup and restore

<b>Back up my data</b>	Back up application data and other settings to Google servers.
------------------------	--

<b>Backup account</b>	Sets the backup account.
<b>Automatic restore</b>	If you reinstall an application, restore backup settings or other data.

## Storage

Unmount USB storage, view available storage.

### Internal memory

<b>Total</b>	Views the total internal memory size.
<b>Available</b>	Views the available memory size.

### External access via FTP

<b>Enable FTP access</b>	Sets the FTP server to be disabled.
--------------------------	-------------------------------------

### Media storage

Views the connected storage devices.

## Date, time & location

Sets the date, time, time zone and formats.

### Date & time

<b>Automatic</b>	Uses network provided time.
<b>Set date</b>	Sets the date manually.
<b>Set time</b>	Sets the time manually.
<b>Select time zone</b>	Sets the time zone.
<b>Use 24-hour format</b>	Selects the 24-hour format.
<b>Select date format</b>	Selects the date format.

### Timer

<b>Off Time</b>	Sets the Off Time.
<b>On Time</b>	Sets the On Time.
<b>Sleep Timer</b>	Sets the Sleep timer.
<b>Auto Off</b>	Sets the Auto Off mode.

### Location

<b>Select country</b>	Select your country.
<b>Set location</b>	Set the your location by ZIP code.

## Safety(Lock)

To access this setting, you need to enter the password.

### Set Password

**Set Password** You can set new password

### Parental Service

**Lock System** Check the Lock system to set the lock system.

**Block Channel** You can choose Block Channel Lock.

**Movie Rating** You can choose Movie Rating Lock.

**TV Rating-Children** You can choose TV Children Rating Lock

**TV Rating-General** You can choose TV General Rating Lock.

**Downloadable Rating** You can choose DRRT Rating Lock.

**Input Block** You can set input block.

## Accessibility

Manages accessibility options. Check the box to enable accessibility.

### Accessibility services

**TalkBack** Check the box to provide audible explanations for Google TV features.

### Accessibility scripts

**Download accessibility scripts** Allows applications to download accessibility scripts from Google.

## About

Views the system information.

<b>System updates</b>	Updates the system.
<b>System tutorial</b>	Learn about the key features of Google TV.
<b>Model number</b>	Views the model number.
<b>Firmware version</b>	Views the firmware version.
<b>Build number</b>	Views the build number.

### Legal information

<b>Open source licenses</b>	Views the open source licenses.
<b>Google legal</b>	Views the Google legal information.

## Option

<b>AV Receiver</b>	Sets the IR Blaster mode. Universal remote control setting enables user to control multiple devices with a single remote controller.
<b>Initial Setting</b>	Factory reset. All user settings and channel settings will be reset.
<b>Audio Language</b>	Sets the audio language.
<b>Caption</b>	Sets the caption.
<b>Standby Light</b>	Sets the standby light.
<b>Pointer Alignment</b>	Sets the pointer alignment.
<b>Mode Setting</b>	Sets the TV to Home use or Store demo.

## Customer Support

<b>Picture Test</b>	Testing your TV screen.
<b>Sound Test</b>	Testing your TV sound system.
<b>Product/ Service Info</b>	Views your product and service information.



# APPENDIX

## Updating the TV Firmware

Download and install the latest firmware through DTV signal to enhance or change the product function, or add new features.

To check the current firmware version or update the firmware,

- 1 Press **SETTINGS** to access the main menu.
- 2 Press the **Red** button to scroll **Customer Support**.
- 3 Press the Navigation buttons to scroll to **Software Update** and press **OK**.

The current firmware version displays.

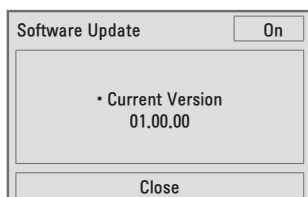

OTA (Over-The-Air): When software update is on, the TV will automatically check for software updates. A pop-up window will appear on the screen when an update is available.

### ! NOTE

- If you change the channel during the firmware update through OTA, the update is stopped.
- The process resumes when you go back to the original channel. The update continues even when the power is switched off using the remote control. The system operates normally once the update is complete.
- You can check the software update status in the Software Update menu or from the update information displayed under the channel banner.

- 4 When the update is complete, the TV will automatically restart in 5 seconds.

You may need to reset some **SETUP**, **PICTURE**, or **AUDIO** menus.

### ! NOTE

- You cannot downgrade back to an older firmware version.
- The period of time for the firmware update may be different depending on the firmware size and DTV signal strength.

## Cleaning Your TV

### CAUTION

- Make sure to turn the power off and disconnect the power cord and all other cables first.
- When the TV is left unattended and unused for a long time, disconnect the power cord from the wall outlet to prevent possible damage from lightning or power surges.

## Screen, frame, cabinet and stand

To remove dust or light dirt, wipe the surface with a dry, clean, and soft cloth.

To remove major dirt, wipe the surface with a soft cloth dampened in clean water or a diluted mild detergent. Then wipe immediately with a dry cloth.

### CAUTION

- Do not push, rub, or hit the surface with your fingernail or a sharp object, as this may result in scratches on the screen and image distortions.
- Do not use any chemicals, such as waxes, benzene, alcohol, thinners, insecticides, air fresheners, lubricants, as these may damage the screen's finish and cause discoloration.
- Do not spray liquid onto the surface. If water enters the TV, it may result in fire, electric shock, or malfunction.

## Power cord

Remove the accumulated dust or dirt on the power cord regularly.

## Preventing "Image burn" or "Burn-in" on your TV screen

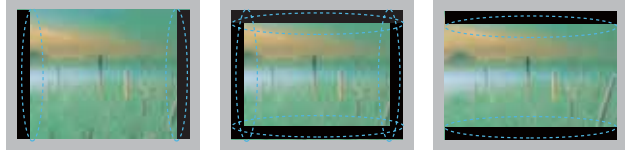

- If a fixed image displays on the TV screen for a long period of time, it will be imprinted and become a permanent disfigurement on the screen. This is "image burn" or "burn-in" and not covered by the warranty.
- If the aspect ratio of the TV is set to 4:3 for a long period of time, image burn may occur on the letterboxed area of the screen.
- Avoid displaying a fixed image on the TV screen for a long period of time (1 or more hours for the Plasma TV) to prevent image burn.

## IR Blaster Guide

Universal remote control setting enables user to control multiple devices with a single remote controller. In order to continue the setting, please check, if IR Blaster and other devices are connected with TV properly.

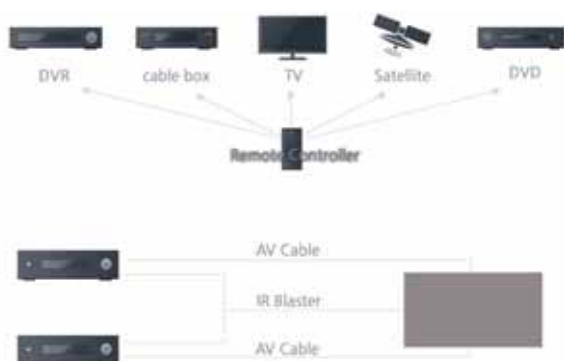

### When AV receiver is connected:

- 1 Connect the IR Blaster Cable to the TV. Place the transmitter in front of the AV receiver.
- 2 Go to **Home > All Apps > Settings > Video input > Add device manually**.
- 3 Select a device and **Next**. The TV signal playing is displayed.
- 4 Select the device style and manufacturer of the selected device.
- 5 Select **Send Powerkey** to test the code. If the code is not matched, select **Next Code** to find the corresponding code.
- 6 Select **Next**. Your device is registered.

### When set-top box is connected:

- 1 Connect the IR Blaster Cable to the TV. Place the transmitter in front of the AV receiver.
- 2 Go to **Home > All Apps > Settings > Video input > Add device manually**.
- 3 Select a device and **Next**. The TV signal playing is displayed.
- 4 Select the device style and manufacturer of the selected device.
- 5 Select **Send Powerkey** to test the code. If the code is not matched, select **Next Code** to find the corresponding code.
- 6 If your ZIP code is not correct, change the ZIP code by selecting **Change ZIP code**.
- 7 Select **Next**. Your device is registered.

## IR Code list

## AUDIO

Manufacturer & Brand	Supported models	Code_Number	
ADCOM	GSA-700,GSP-560	082	
	GFP-710,715,750,Pre-502	092	
	GTP-450,502,506,550,600,740,830		
		225	
	GFB-800,GTP-500_II,RC-800	161	
		269	
	GFR-700,700HD,GTP-870HD,880	356	
AIWA		018	
	RC-T770F	104	
	RC-TN4000EX	202	
	CX-NDV526,NSX-990,999,AV90,AVF99,V90	203	
	RC-T500EX,TN270EX,TN330,TN5200EXU,XR-DV526,H330MD		
	AV-DV75U,RC-8AR03	213	
	RC-T800F	211	
	RC-T779	188	
AKAI	RC-A905	189	
ANTHEM	AVM_2MAIN	335	
	AVM_20MAIN,30MAIN,40MAIN,50MAIN,50V MAIN	337	
	STATEMENT_D1MAIN,D2MAIN		
ARAGON	STAGE_ONE1	687	
ARCAM	ALPGA_10DAVE,AMP-AV50,CR-30,TunerA8	141	
	AR32,65,70,75,80,90,AVR100,C30,31,P1,P35,P90,P90/3	077	
	AV8,9[ZONE1-SYS16]		
	AVP700[ZONE1,2-SYS16]		
	AVR250[ZONE1,2-SYS16]		
	AVR280[ZONE1,2-SYS16]		
	AVR300,350[ZONE1,2-SYS16]		

ATLANTIC_ TECHNOLOGY	P-2000	342	
AUDIO_FILE		071	
B_&_K	3090,4090,HT_Products(1),REF-20,30,ST1400-II	096	
	AVP1000,1030,2000,2030,3000,3090,4000,4090		
	AVR101,202,305,307,317,505,505_S2,507,507_S2,515,517		
	Reference10,20,20+,21,30,31,50,50_S2,51		
	AVP1000,1030,2000,2030,3000,3090,4000,4090[ZONE_B]	097	
	AVR101,202,305,307,317,505,505_S2,507,507_S2,515,517[ZONE_B]		
	Audio_Products(2),PT3,5[ZONE_B]		
	Reference10,20,20+,21,30,31,50,50_S2,51,5_S2[ZONE_B]		
BOSE	RC-SC-6	070	
	ACOUSTIC_WAVE	224	
BOSTON_ACOUSTICS	AVP-7,AVR-7120	447	
CAMBRIGE_AUDIO	AZUR_640R	684	
CARVER	RH-DD51(2)	006	077
	PRE-CT-26V,RH-20(1),RH-88B(1)	492	
	RH-20(2),RH-88B(2)	028	
		061	
		071	
	CM-1090,CT-17,6,HR-722,752,875,RH-17,75,TX-8,8R	201	
		214	
		226	
		185	
	RH-DD51(1)	013	
	CR-27V,RH-27v	284	
CARY_AUDIO_DESIGN	CINEMA6	378	
CITATION	5.0,500(5.0AV)	148	
CLARION		026	

DENON	RC-136	109	
		215	
	T-270,380RD,TU-1500RD	230	
	RC-122	234	
	DRA-295,395,685	330	
	270LII,AMP-AVC-A1,A10SE,CA1,KVAC-A10SE,POA-5200,TU-580RD,S10	340	
	AVC-A10,A1D,A1SE,A1SR		
	AVR-1083,1507,1800,1802,2400,2800,2803,3802		
	DRA-297,37,397,697CI,697CIHD[MAIN]	679	
	AVR-1609,1610,1709,1909,1910,2309CI,2809CI,4810,589,689,789,889,989[SIRIUS]	569	
		774	
DIGITAL_PROJECTION	TITAN_1080p	660	
DVICO	TVIX_HD_M-4000,4100,5000,5100,6500A,7000A	570	
	TVIX_HD_PVR_M-4010,TVIX_HD_TUNER_T-430,431		
	TVIX_PVR_M-4110,4130,5010,5110,5130		
ELAN	HDR-2000	057	
		290	
ENLIGHTENED_AUDIO		099	
		098	
ESCIENT	DVDM-100[ID#1],FIREBALL_AVX-211,331,552[ID#1]	451	
	FIREBALL_DVDM_FB1,FIREBALL_E-120,2,40[ID#1],FIREBALL_E2_FB1		
	FIREBALL_FP-1[ID#1],FIREBALL_MP-100,150,200[ID#1]		
	FIREBALL_MX-111,311,531,752[ID#1],FIREBALL_SE-80,SE-D1,ZP-1[ID#1]		
	VISION_VC-1[R1],VISION_VS-100,600[R1]		
FISHER	REM-380	214	
		182	
FLEXTRONICS	CINEMA8	378	

FOSGATE_AUDIONICS	MODEL3	148	
	FAP_T1	342	
HARMAN_KARDON		148	
	AVR_4000,45RDS,110,25,3,30,HARMAN2,HK 3385,3485,HK-3250,RRV-101,102	233	
		077	
		028	
	AVR-75(1),85(1)	118	
	AVR_120,125,130,135,140,144,145,146,147,2 00,210,220,225,235,240,245,247	318	
	AVR_300,300RDS,310,325,330,335,340,347,4 30,435,445,500,500EU,500RDS		
	AVR_510,520,525,630,645,7300,745,7000,700 0RDS,7200,7500,8000		
	CP_15,25,35,40,45,55,60,DPR_1001,1005,200 5,HS_100		
HITACHI	RB-V5	020	
INTEGRA		275	
		017	
		046	
		108	
		080	
		209	
		381	
JAMO	DMR40,45,70	399	
JCPENNEY	JCP1	216	
JVC	RM-SR818U,SR884U,RX-884VBK,905VTN	163	
	RM-SR515,RX-515V	191	
	UX-A4	114	
	RX-1028,5000VBK,6000VBK,6010VBK,6020VB K,6500VBK,7000VBK7010VBK	279	
	RX-7020VBK,778V,8000VBK,8010VBK,8020VB K,884,9000VBK,9010,9010VBK		
	RX-DP10VBK,DP15B,DP9VBK		
	RM-RK32	291	

KENWOOD		026	
		066	
	KR-V6050,KRX-1000,RC-120,R0600	145	
	RC-F4	192	
	FISHER2,KR-V8090,V888D,V999D,KRF-V5030D,V5050D,RC-R0905,R0907,SEA-950S	182	
	VR-1060,1090,209,309,507		
		005	
	RC-W0501	280	
	UD-351M	374	
KLEGG	M6_501	686	
KLH	R5000	331	
KLIPSCH	STAGE_ONE(1)	687	
KOSS		216	
KRELL	KRC-2,PRE-KRC3	072	
	HTS-7.1,S-1000,SHOWCASE	384	
	EVOLUTION_ONE(1),TWO(1)	672	
LEXICON	DC-1(1),MC-1	120	
	CP-3-1,2	235	
		236	
		237	
	MC-8(MAIN),RV-8(MAIN)	357	
	MC-12(MAIN)	360	
LG		008	
		002	
LINN	AV5103,KAIRM,KUDOS,WAKONDA	124	
	CLASSIK_MOVIE,MOVIE_Di	377	
LUXMAN	RRV-371	009	
	R-341	139	
		052	
		165	
		115	
	RTP-117	004	



MAGNAVOX		086	
		164	
		152	
		077	
MARANTZ	D-870,RC-2000,RC-600-AV,RC-73SR	006	
	AV-500	028	
		031	
		040	
	RC-4000-SR	063	
		185	
		186	
	RC-1132	265	
		289	
	SR6300,6400,7400,8400	492	
	SR5005[MAIN]	712	
		719	
MCINTOSH	C100,15,38,39,41,42,712,CR12,MHT100,MX-132,MX118,PRE-Tune-MX-130	238	
	HR35	286	
	C1000,2300,500	311	
MERIDIAN	500SERIES,501,501V,502,504,507,551,561,562V3,565_PRE-AMP,568,558,PRE-565,TunePRE-504	100	
	601_PRE-AMP	012	
	200SERIES	013	
	G_SERIES,G01,02,51,61,68,91	628	
MITSUBISHI		242	
	M-VR400,600	204	
MONDIAL	AMPHITHEATER1	157	
	28K	158	
	ACT-3	042	
	DIA-150	043	
	RH-11	081	
		112	
MYRYAD	MDP500	077	

NAD	450,AMP-C340	186	
	705,C422,Tuner-C-420	113	
NAKAMICHI	AV-1RC,2	040	
	RE-1RC,2RC,3RC,RECEIVER2	244	
		245	
	RM-1m	172	
	AV-10,1s,8,RE-10	183	
		287	
NEC	AR-300	176	
NILES	A4.6CI,ZR-4630,-8630AV	403	
ONKYO	TX-DS575,DS575X,DS676,DS757X,DS777	275	
	RC-199M	017	
	DTR-7.1,TS-DS676B,TS-SV828THX	046	
		108	
	TX-DS747[TUNER],DS838[TUNER],DS939[TUNER]	080	
	RC-313S	209	
		381	
OPTIMUS		026	
		041	
OUTLAW	MODEL950	342	
PANASONIC		032	
	RAK-SC509W	195	
		219	
		177	
		292	
	SC-HT820V[AMP&DVD]	626	
PARASOUND	R-1,U/RC-1500	129	
	R-2,U/RC-1500	130	
	AVC-1800,R-15,R-15ADVANCED,U/RC-1500	132	
	AVC-2500U	261	
		294	
		295	
	C1/C2	333	
	T3	334	

PHILIPS	FA360	249	
		250	
	FR-930,FR975	063	
PIONEER	CV-VSX159,Elite-VSX-07TX,37TX,VSX-308,36TX,37TX,906RDS,D308,D458	014	
		039	
	AXD-1394	044	
		069	
	XC-L11,L77	168	
	NS-1,XR-P150	116	
	CV-VSX097,VSX-D3S	035	
		063	
		198	
		VSX-1014TX,1015TX,194TX,415,515-K,516-K,52TX,815,816-K,9100TX,915,D814,D914	480
PROCEED	PAV/PDSD	144	
		268	
RCA	RV-3793	010	
		048	
		117	
	5-4030	156	
	RS-AVC50	067	
		288	
REALISTIC		019	
		073	
		075	
		095	
ROTEL	RR-922,RT-940,940AX,990,RTC-940AX,RX-950	074	
	AMP-RA-1060,1070,932,PRE-RC-1070,RA-985,985BX,RC-972,995,RDP-980,RR-930	083	
	RSP-1066,966,976,985,RSX-1050,1055,1065,965,965A,972,975,RTC-965,970,RX-950AX,975		
	RR-907	085	
SAMSUNG		016	

SANSUI		040	
		048	
	MICRO200,MS-6901,7766	110	
		063	
	RS-1560	065	
	RZ-6100AV	228	
SANYO	RB-D10	214	
SCOTT		019	
SHARP		026	
		094	
		175	
SHERWOOD		024	
	R-945	102	
	R-325,525,725,RM-RV-60,RV-6010R	106	
	P-965(RNC-510),R-865(RNC-510),R-963,R-965(RNC-510)	447	
	R-765,903,RD-8105,8108,8601	370	

SONY	DDS8943,8949,HT-5500,5500D,550D,DDW750,HTD-D840,DW840,DW8401	001	
	STR-DE685,DE695,DE697,DE698,DE885,DE895,DE897,DE985,DE995,DG600,DR898,K840,K840P		
	RM-S102,S241,S441,U421,U54,U541,STD905,STR-DB1070,TA-D905	018	
	RM-E7(2),RM-P341,P351,P501,U241,TA-V909	247	
	STR-D1011,D1015,D611,D965,DA50ES,DE325,DE345,DE525,DE545,DE715,DE835		
	RM-P1	248	
	STR-DB925,DB930	166	
	RM-E800,EP9,SDP-EP9ES	101	
	RM-PP402	184	
	RM-J55	218	
	RM-SG9AV	271	
	STR-DA2400ES[MAIN],DA3300ES[MAIN],DA3400ES[MAIN],DA4300ES[MAIN],DA4400ES[MAIN]	560	
	STR-DA5300ES[MAIN],DA5400ES[MAIN],DA6400ES[MAIN]		
CAV-CVS12ES[ALL_ZONES]	612		
SOUNDESIGN		036	
SUNFIRE	Theater_Grand_III,IV(ZONE1)	344	
	Theater_Grand_III,IV(ZONE2)	345	
		182	
TEAC		005	
		019	
		049	
		040	
	AG-D9100,D9260,UR-407	212	
	RC-660	217	

TECHNICS	RAK-SA609MH,SA-AX6,AX7,SU-A700MK3	122	
		176	
		193	
		219	
		178	
	RAK-SA501P1,SA-GX130,SD-S3300	177	
	EUR643853,RAK-SA122MH,SA614MH	200	
	SA-TX50,SA-DX930,DX950,EX-300,GX550,SH-CH950,ST-GT550,K55	257	
		262	
THETA_DIGITAL	CASA_NOVA,CASABLANCA,CASABLANCA_II	136	
TOSHIBA		060	
	CT-821(2)	087	
	CT-812(1)	198	
	SE-R0022	278	

YAMAHA		026	
	DSP-A990,VP37310	253	
	AX-596,DSP-A5,RX-V396RDS,VM70290,VP49730,VR09410,VS71360,90590	169	
	RS-AVC50,AVX100	067	
	AVS700,VID5400	173	
	AX-380,892,DSP-A505A,A592,A595,A595A,AX620,HTR-5150,5250,5280,5460,5490	205	
	R-V1103,V1105,V902,RAV-110,130,150,RS-7,TX-350,492RDS,590,592RDS,670RDS,950		
	RX-3000,V1000,V1200,V2090,V2092,V2095,V2200,V3000,V495,V495RDS,V592,V595A,V595RDS		
	RX-V596,V596RDS,V620RDS,V690,V692,V793,V795,V795A,V800,V992,V995		
		264	
	SYS4	232	
	RAV7	089	
	RAV6	274	
	HTR-6040,RX-V361[MAIN-ID1],RX-V461[MAIN-ID1]	715	
	YHT-280[MAIN],YHT-580[MAIN],YHT-680[MAIN],YHT-685[MAIN],YHT-780[MAIN]		
	RX-397,497,RX-797[MAIN]	717	
	YSP-1100[STANDARD]	644	
		695	
	RX-V1065[MAIN],RX-V2065[MAIN],RX-V465[MAIN],RX-V565[MAIN],RX-V665[MAIN],RX-V765[MAIN]	738	
	RX-A1000[MAIN],RX-A2000[MAIN],RX-A700[MAIN],RX-A800[MAIN],RX-V667[MAIN]	756	
ZENITH	Z712B	143	
		210	

## CABLE Set-top Box

Manufacturer & Brand	Supported models	Code_Number							
CISCO/SA	EXPLORERSeries	001							
	8300,8540HD,8550HD,8552HDC,8560HDC,8640HD,8640HDC,8642HDC,8652HDC								
		003							
	8550/8590,8590/8540	041							
	8540,8570,8590	042							
		045							
	8500	046							
	OCAPMODELS	123							
PIONEER	VOYAGERSeries	001							
	BR-360								
		103							
	BC4100,4200	034							
	BA4600,5000,6000,BC5400	051							
		063							
		076							
	BR-95A	105							
PACE	DC501P,DC511P,DC550P,DC551P	001							
	TDC460NF,TDC575D_VEGAS,TDC577X_VEGAS	002							
	TDC775D_TAHOE,TDC778X_TAHOE,TDC779X_TAHOE								
	TDC850,TDC850NF,TDC758D_SUMMIT,TDC787X_ASPEN								
		005							
SAMSUNG	SMT-3090HD,3270HD,SMT-3260HD	001							
		030							



MOTOROLA	DCH70,100,200,3200,3416,6200,6416	002								
	DCT700,2500,3080,3400,6200,6208,6400,6412,6416									
	DCX3200,3400									
	QIP2500,2708,6200,6416,7100,7216									
	RG3000	112								
	OCAPMODELS	120								
BELGACOM	IPP430MC	171								
CABLEVISION		001								
CE-LABS	HD100QA	164								
DIGEO	2056-MSX	153								
DIGITAL_STREAM	DCS1000	180								
DUNE	SMARTB1,BE,D1,H1,HE,ME	184								
	MINI,ULTRA	185								
DSTV	DSTV[PVR1]	182								
	DSTV[PVR2]	183								
EVOLUTION-FTA	X0-01	158								
FOXTEL	DIGITAL,IQ,IQ2	172								
GENERAL-INSTRUMENT		005								
	DL4,DQNV/DRX	103								
	DPBB,DPV/DP/DQN									
	DRZ									
	STARGATE	104								
	3000R									
HAMLIN		049								
	CR6000,6600	050								
	CR6800,CR-83	055								
HITACHI		055								
		103								
HOMECAST	NC3000C01	176								

JERROLD		003							
		004							
		005							
		008							
		009							
		010							
		069							
	DL4,DQNV/DRX	103							
	DPBB,DPV/DP/DQN								
	DRZ								
MAGNAVOX		010							
		012							
MEMOREX		052							
MOXI	MOXIMEDIACENTER	111							
	2065-MSX	153	252						
NBOX	ADB-5720SX	181							
	ABD5720SX	186							
NFUSION	NOVA,NUVENIOHD,NUVENIOSDP HOENIX,SOLARIS	192							
PANASONIC	140,170,175	044							
	110,120,130,150	047							
PHILIPS		006							
		012							
		013							
		020							
		085							
PULSAR		052							
RCA		047							
REGAL		049							
		050							
REGENCY	ALLMODELS	057							
SKY	SKYHD	204							
SONY	DHG-M55CV	108							
SPRUCER		047							
SUDDENLINK	DC730	179							

TELNET	RC-RW100	354							
THOMPSON	DCI1011GEM,DCI1011GEM1,DCI104ICS	188							
TILEVISION	TV19,26	187							
TIVO	SERIES1	790							
	HD,HR10-250,SERIES2,3	817							
	HD,SERIES2,3_ID#1	821							
	HD,SERIES2,3_ID#2	822							
	HD,SERIES2,3_ID#3	823							
	HD,SERIES2,3_ID#4	824							
	HD,SERIES2,3_ID#5	825							
	HD,SERIES2,3_ID#6	826							
	HD,SERIES2,3_ID#7	827							
	HD,SERIES2,3_ID#8	828							
		PREMIERE	821	822	823	824	825	826	827
TOCOM	5503VIP,5507	039							
		040							
		056							
TOSHIBA		052							
VERIZON	DCT6416	002							
	FIOSTV	121							
VIEWSTAR		012							
		015							
ZENITH		052							
	PM,ZTAC/PM	060							
	MN2500	093							
		100							

## IPTV Set-top Box

Manufacturer & Brand	Supported models	Code Number	
ADB	ADBSeries	254	255
	ADB5810WX	315	
	ADB5810W	259	163
AMINO	AmiNETSeries	249	
	A125,A130,A530	256	257
	A110	260	261
AT&T	U-VERSE	148	
CISCO	RNG200	313	
	IPNSeries	148	
	CIS330,CIS430	316	
COMCAST	RNG200	313	
DREAM	DM7020S	159	
ENTONE	URCPLUS	155	
	AMULET,HydraHD	258	
MINERVA	MINERVASOLUTIONS	178	
MOTOROLA	U-VERSE	253	
	VIPSeries		
MYRIO	EvoSeries	254	255
NOWTV	NOWTV	314	
PAGE	DTASeries	313	
VERIZON	FIOSTV	002	
SCIENTIFICATLANTA	IPNSeries	148	
WEGENER	SMD515	250	

## Satellite Set-top Box

Manufacturer & Brand	Supported models	Code Number							
CABLEVISION		148							
	DIRECTV	D10, D10-200, D10-300, D11, D12	173						
	H10,H20,H21								
	HR20,HR21								
	R15								
	SAT-GO								
	HDVR2,HR10-250_ID#1,2	221							
	HDVR2,HR10-250_ID#3	223							
	HDVR2,HR10-250_ID#4	224							
	HDVR2,HR10-250_ID#5	225							
	HDVR2,HR10-250_ID#6	226							
	HDVR2,HR10-250_ID#7	227							
	HDVR2,HR10-250_ID#8	228							
	DISH	DISH1 11,30 1,311, 322,3 51,41 1,501, 508,7 21,81 1	122						
	DVR508,510,522,625, 721,921,942								
	MODEL6000								
	VIP211,222,612, 622DVR,722DVR								
	ID#2	167							
	ID#3	168							
	ID#4	184							

CABLEVISION	ID#5	185							
	ID#6	186							
	ID#7	187							
	ID#8	188							
ECHOSTAR	DISH111,301,311,322,351,411, 501,508,721,811	122							
	DVR508, 510, 522, 625, 721, 921, 942								
	MODEL6000								
	VIP211, 222,612, 622DVR, 722DVR								
	ECHOSTAR3100, 4100, 6131, 9241, 9242								
	ID#2	167							
	ID#3	168							
	ID#4	184							
	ID#5	185							
	ID#6	186							
	ID#7	187							
	ID#8	188							
EXPRESSVU		122							
		167							
GE	GRD122GW, GRD33G2A, GRD33G3A	151							
		116							
GENERAL_ INSTRUMENT	4D-TV	148							
GOI		122							
		167							
HITACHI		001							
	HDS100R,HDS210R	154							
HTS		122							
		167							
HUGHES	GENERICID1	001							
	HIRD-4532PLATINUM								

HUGHES	HIRD-D45,E86								
	HIRD-E11	154							
	HIRD-B1, B3, B4, C2, D01, D11, D2, E25, E45, E61	001	154						
	MOSTMODELS	001	154						
JVC	TU-6000, DP301, PVR508, PVR721, PVR921	122							
		167							
LG	LSS-3200A	170							
	DiercTV_H23	173							
MAGNAVOX		136							
MEMOREX		136							
MITSUBISHI	SR-HD400,HD500, SD100,SD200,SD50	001	154						
MOTOROLA	DSR209, DSR505HD,DVR530HD	148							
NEXT_LEVEL		148							
PANASONIC	TU1RD10,TU1RD20	142							
	TU-HDS20,HDS20B	160							
	TZ-DBS01,DRD100								
PAYSAT		136							
PHILIPS	DSHD800R	001	154						
		136							
	DIGITURK	156							
	DSX-3150,DSX5150R,DSX5250R/I,DSX5350R								
	DSX5353C,R,X, DSX5375,DSX5500,DSX5540								
	WIZJATV								
	DiercTV_R16,HR23	173							
PROSCAN		116							
	PRD8630A,B,PSHD-105	151							
RADIOSHACK		148							

RCA	DRD202RD,221RD,222RA,222RD,223RD,225RD,420RE,	116							
	DRD430RG,431RG,440RE,450G,450RG,451RG,460RE,480RE,485RG,486RG								
RCA	DS2122RD,503MLB,515MLB								
	DTC-100								
	DXD402RA,DXD506DD								
	DRD102RW,203RW,301RA,302RA,303RA,403RA,502RB	151							
	DRD503RB,505RB,515RB,523RB,703RA,705RB								
SAMSUNG		123							
	SIR-TS160	163							
	SIR-TS360	169							
	SIR-S300W,S310W	175							
SONY	RM-Y182	115							
	SAS-A3,A4,AD3								
	SAT-A1,A2,A3,A4,A5,A50,A55,A65,A65A,AD4,AT4								
	SAT-B1,B2,B3,B4,B50,B55,B65,B65A,BS3								
	SAT-HD100,HD300								
STARCHOICE		148							
TIVO	SERIES1	790							
	HD,HR10-250,SERIES2,3	817							
	HD,SERIES2,3_ID#1	821							
	HD,SERIES2,3_ID#2	822							
	HD,SERIES2,3_ID#3	823							
	HD,SERIES2,3_ID#4	824							
	HD,SERIES2,3_ID#5	825							
	HD,SERIES2,3_ID#6	826							
	HD,SERIES2,3_ID#7	827							
	HD,SERIES2,3_ID#8	828							
	PREMIERE	821	822	823	824	825	826	827	828



TOSHIBA	DST-3000	001	154						
	TSR-101	127							
	DST-3100	157							
UNIDEN	UDS100	136							
VOOM		148							
ZENITH	DTV1080	159							
	HD-SAT520								

## DVD

Manufacturer & Brand	Supported models	Code_Number
ACCURIAN		003
		268
ADCOM	GCV-850, 870	157
ADVENT		005
AIWA	VX-F20DV1	146
AKAI	LC-T2701TD, LCT2701AD, LCT3701AD, LCT3701AD-II	281
ALLEGRO		091
ALPINE		098
AMW		006
		007
ANTHEM	BLX-200	361
APEX_DIGITAL	AD-1500, 1600, 1700M, 600A	087
	AD-703	111
		115
ARCAM	BDP100, DiVA_DV78, DV79, DV135, 137, 139, 88, FMJ_DV27A, 29	122
ASPIRE_DIGITAL		008
		009
AUDIOVOX		003
		010
		014
		015
		149
	FPE1506DV, FPE1906DV	284
BEL_CANTO_DESIGN		016
BLAUPUNKT		111
BROKSONIC		130
BUFFALO		264
CALIFORNIA_AUDIO_ LABS	CL-20, CL20&CL25	021
	CL-2500, CL2500DVD	124

CAMBRIDGE_AUDIO	DVD79, 85, 86, 87, 89, 99	323
	AZUR_540D	333
	AZUR650BD	360
CARY_AUDIO_DESIGN	DVD-6, 7	174
	DVD-8	266
CENTRIOS		019
CINEVISION		091
CITIZEN		020
COBY	DVD-514	260
CYBERHOME	DVR_1200, 1600	271
DAEWOO	8000K	132
DENON	DVD-1000, 1500, 1800, 2800, 2800_MK_II_N, 4800, 9000, DVM-1800, 1805, 3700, RC-540	080
	DVD-1200, 1710, 1910, 2200, 2900, 2910, 3800, 3910, 555, 556, 5900, 5910, 5910CI, 755, 756, 910, 955	173
	DVM-4800	
	DVD-1600, 800	138
	DBP-2010, 2010CI, 4010UDCI, 1610, 1800, DVD- 1800BD, 2500BTCI, 3800BDCI, A1UD, AIUDCI	329
	S-5BD	358
DIAMOND_VISION		037
		038
		039
DISNEY		040
		096
DURABRAND		091
	DCC0903D	143
DVD_2000		017
DYNEX	DX-UPDVD2	349
EMERSON		091
	CETD204	143
ENTERPRISE		074
ESA		022
	EC520E, EC720E	143
FISHER		147

FUNAI	SRTD219	143
GATEWAY	AR-230	222
GE	1105P	027
GO_VIDEO	DVR-4000, 4300, 4400	137
	DV1000, 1130, 1140, 2140, 3140	091
	R6540	220
	R6640	221
	R6740, R6750	222
GPX		044
		045
GRADIENTE		021
GREENHILL		111
GRUNDIG		083
HARMAN_KARDON	DVD_5	084
	DVD_22, 25, 27, 30, 31, 37, 38, 47, 48, 50	140
HITACHI	DV-P315U, RM500	101
HITEKER		087
ILO	DVDR04	268
INITIAL		111
INSIGNIA	IS-TV040921	143
	NS-20CLTV	292
	IS-TV040918	297
		091
		096
	NS-WBRDVD	349
INTEGRA	DPS-5.3	142
	DPC-5.1, 6.1, 7.4, 7.5, 7.7, 7.9, 8.5, DPS-5.2, 5.4, 5.5, 6.5, 7.2, 7.3, 9.1	180
	DPS-10.5, 5.9, 6.7, 6.9, RDV1.1	280
		273
	DBS-30.1, 30.2, 50.2, 6.9(RC-730DV), 6.9(RC-749DV)	338
JATON		046
JBL		084
JSI		047

JVC	RM-SXV525J, SV-S40BK	012
	XV-30SL, 421BK, 501BK, 521BK, 523GD, 525BK, 555BK, D701, D701BK, D723GD	
	XV-F80, F80BK, F85GD, FA900BK, FA902SL, FA90BK, FA95GD, M50BK, M555BK	
	XV-N222, N222S, N310B, N312S, N320B, N322, N322S, N330B, N332S, N340B, N342S, N40BK, N410B	
	XV-N420, N420B, N422S, N44SL, N510B, N512S, N55SL, NA70BK, NA7SL, NP10S, NP15L	
	XV-S300BK, S400BK, S402BK, S45GD, S500BK, S502SL, S60BK, S65, S65GD, S75GF	
	XV-SA600BK, SA60SL, SA70, SA70BK, SA75GD	
JWIN		048
		050
KAWASAKI		149
KENWOOD	DV-505	151
KISS	DP-558	279
KLH	KF-8000A	135
KONKA		051
		052
		054
		055
KOSS		047
		058
		059
KREISEN		060
KRELL	DVD_STANDARD, SHOWCASE	104
LASONIC		061
		062
LEXICON	RT-10, 20	148

LG	DN191H, DN788, DN798, DR1F9H, DV7711, 7821, DVB418, DVD-3200E, LDA-511, LDX-514, LGDVB418	091
	LRA-516, LRY-517, RC199H, V782NWK, VK661WK	
	BD-300, 390, 550, 570, 590, BH100, 200, BX580, DR781T, DR787T, LXV-6846, RC797T	057
		074
	LHB953, LHB977	350
		002
LITEON	LVD-2001	264
	LVW-5001, 5005	265
	LVW-1101, 1105, 1107	268
LOEWE		063
MAGNAVOX		066
	N9353, ZC320MW8, ZC352MW8	096
	17MD288V/17, 26MD255V/17	282
	19MDTR20, 27MDTR20	143
MALATA	DVDN996	267
MARANTZ		066
	BD5004, 7003, 7004, 8002, UD5005, 7006, 8004, 9004	332
MCINTOSH	MP831, 841, 842, MVP831, 842/841	125
MEMOREX		040
		096
	MVD-2025	163
MERIDIAN	596, 598, 800, 861	153
MICROSOFT		027
		206
MINTEK	DVD-1600, PORTBLE_DVD	111
	DTV-173, 233, 263, 323, 370	282
MITSUBISHI	DD-3000, 4000, 4020, 4030, 5000, 6000, 6020, 6030, 6040, 6050, 7040, 8020, 8030, 8040, 8050	017
MYRYAD	MDV200, Z120	102
	M_SERIES	134

NAD	T550	088
	M56, T557, T577, T587	353
NAKAMICHI	DVD-10, 10S	103
NESA		111
NEUNEO		067
NEXXTECH		068
NORCENT		005
		006
		007
		069
		071
		072
		073
ONKYO	DV-C501, C503, C600, S525, S535, S939, Intergra-DFS5, INTEGRAM_DPS5, RC-335C, RC-388DV	076
		141
	DR-90, DV-353, C601, CP500, CP701, CP702, CP706, CP802, L5, M301	180
	DV-S555, S901, SP300, SP303, SP303E, SP500, SP502, SP502E	
		273
	BD-SP308, SP807, SP808, DV-BD606, DVD-BD507	338
OPPO	OPDV971H	266
	BDP-80, 83, 93, 95	341
OPTIMUS		023
ORION		130
ORITRON		058

PANASONIC	PV-DM2799	144
	PV-D4733S, 4734S, 4742, 4743, 4743S, 4744, 4744S, 4745, 4745S, 4752, 4752S, 4762, 4763S, DV4752	150
	DMP-BD10, BD10AK, BD30	285
	DVD-CV36, 36U, 51, 51U, RP56, RP56U, RP82, RV21U, RV26, RV26U	138
	DVD-RV31, RV31UK, RV31US, RV31USK, RV41U, S1S, DVDA112, DVDA115, DVDA120	
	DVD-CP67, 71, 72, CV52P, H2000D, RP91, RP91DN, RV10, RV10U, RV20, RV20U	021
	DVD-RV30, RV30U, RV30UK, RV30US, RV60, RV60U, RV65, RV65U, RV80, RV80U, XP30	
	DMP-BD35, 45, 55, 60, 601, 601K, 605, 605K, 60K, 65, 655, 70V, 80, 80K, 85, T100, T110, T210, T350	346
	SA-PT660, 754, SC-PT660, 754	347
PARASOUND	D3, MODEL_D200	245
PHILIPS	DVD622, 702, 711AT, 751AT, 763SA, 781CH, 782, 941AT, 951, 951AT, 953, 962SA, 972, Q50, 727	066
	DVP637, 642	
	DVP3040, 5140, 5960	276
	DVDR3475/37	317
	BDP5005, 5010, 5012	344
PHILIPS_MAGNAVOX		141
		066
PIONEER	CU-DV001, DV-05, 3020, 333, 340, 341, 343, 353, 37, 38A, 434, 440, 444, 626D, 656A, C36, C505, C525, C603	023
	DV-F07, DV09, DVL-91, 919, Elite-DV37, PDV-10, LC10	
		099
	DV-C503	131
	BDP-94HD, HD1	304
	BDP-05FD, 09FD, 120, 23FD, 320, 51FD	337
	BDP-31FD, 330, 33FD	354



POLAROID	DHM-0100, DHX1-1000A, DVP-110M	233
	FXM-1911C	284
	FDM-0700A, 0715, 1000A, 1015, FDX-0700T	295
	TDM-1311	297
POLK_AUDIO		141
		066
PRESIDIAN		003
		096
PRIMA		005
PRIMARE	DVD26, 30	193
	V10, 20, 25	194
PRINCETON		078
PROSCAN		027
RCA	DRC220N, 300N, 350N, 480N, 500N, DRS550N, 700N	027
	RC5215P, 5220P, 5225P, 5240P, 5255P, 527P, 5400P, 5910, 5910P, 5915P, 6001P	
	DRC200N	307
RIO		091
RJTECH	RJ-1500DVXII	269
ROTEL	RDV-1093	204
SAMPO		081
		082
		085

SAMSUNG	DVD-511, 611, 612, 709, 711, 739, 811, 812, 818, 819, 839, 909, C600, C601, C621, C700	070
	DVD-M101, M201, M301, N2000, N501, P230, P231, P331, P401, P421, P721M, S221, S222, S320, S321	
	CSN2077DV, CXM2785TP	165
	DVD-P701, V2000, V2500	137
	DVD-V3500, V3650, V3800, V4600, V4700, V4800, V5500, V5650, V5650B	159
	DVD-V6700, V8500, V8600, V8650, V9500, V9650, V9700, V9800	
	BD-C5500, C6500, C7500, D5300, D5500, D5700, D6500, D6700, D7500	275
	BD-P1000, D1200, D1400, P1500, P1580, P1590, P1595, P1600, P1620, P1650, P2500, P3600, P4600, UP5000	
DVD-R130, R135, R155, R157, R160	301	
SANSUI	VRDVD4000, 4005	154
SANYO	DWM-370	147
SEARS		130
SENSORY_SCIENCE	SR674	222
SHARP	DV-710U, DV-S1U	094
SHERWOOD	SD-860, 871	245
	BDP-5003	345
SHINSONIC		033
SONIC_BLUE		091

SONY	DVD-NC600, DVP-D116A, NC555ES, NC625, NC665, NC675P/B, NC685V, NC800H, NC80V, NC85H, NC875	001
	DVP-NS400D, NS41P, NS501PS, NS50P, NS55P, NS575P, NS57P	
	DVP-NS700H, NS700P, NS70H, NS71HP, NS725, NS75H, NS77H, NS90V, NS9100ES, NS975V, S36, S360	
	DVP-550, C600D, C650D, C660, C660D, C670, F21, F41MS, PQ1	033
	DVP-NC615, NC655P, NS300, NS315, NS415, NS715P, NS755V	
	DVP-S500D, S530D, S550S, S600D, S7700, S9000ES, RMT-D102A, D104A	
	SLV-D100, D300P, D350P, D360P, D370P, D550P, D560P	145
	RDR-GX7	191
	BDP-BX1, BX2, N460, S1, S1000ES, S2000ES, S300, S301, S350, S360, S500, S5000ES, S550, S560	286
	RDR-GX300(1), HX715(1), HX900(1)	241
	RDR-GX300(2), HX715(2), HX900(2)	242
	RDR-GX300(3), HX715(3), HX900(3)	243
	BDP-CX7000ES, CX960, S7000ES	340
	DVP-NS710H	343
	BDV-E300, E500W, T10, HCD-E300, T10	351
SPECTRONIQ	PD-3000HD	310
SUNGALE		090
		223
SUPERSCAN	19TVD3S, 19TVD4S	143
SVA		092
		093

SYLVANIA	6509DD, 6513DD, 6513DE, 6513DF, 6513VD, 6519DB, 6519DD, 6519VD, 6520FDD, 6520FDE, 6520FDF	143
	6615LDF, 6615LDG, 6620LDF, 6620LDG, 6620LDT, 6719, 6719DC, 6719DD, 6719DDS, 6719DE, 6719DES, 6719DF	
	6720, 6720FDD, 6720FED, 6720FDF, 6720FDFA, 6724DF, 6724FDF, 6727, 6727DC, 6727DD, 6727DE	
	C6513DD, C6513DE, C6519DD, C6520FDE	
	RSEC520E, RSEC720E, SRCD223, SRCD223B, SRCD227, SRCD227B, SRCD420P, SRCD427P	
	SRTD219, SRTD309, SRTD313, SRTD319, SRTD413, SRTD420, SSC509D, SSC719C, SSC727C, SSL15D5	
SYMPHONIC	CSC520DE, CSTL20D5, CSF719, RSMGD134, RMSD513E, RMSD520FE	143
	SC513DF, SC519DD, SC520FDF, SC720FDF, SC724DF, SC724FDF, SRTD219, STL20D5, WF719	
TAG_MCLAREN	DVD32FLR, DVD32R	156
TATUNG		102
TEAC		023
	DV-H350	270
TECHNICS		138
TECHWOOD		088
THETA_DIGITAL		023
THOMPSON		027

TOSHIBA	MD13M1, MD13P1, MD13P3, MD13Q11, MD13Q41, MD14F11, MD14F51, MD14FP1	130
	MD20F11, MD20F51, MD20FL1, MD20FL3, MD20FM1, MD20FM3, MD20FN1, MD20FP1, MD20FP3, MD20P1, MD20Q41	
	MD24F51, MD24F52, MD24FP1, MD9DL1, MDPDM1, MD9DN1, MD9P1	
	SD-4700, 5700, V280	141
	MW14F51, MW20F11, MW20F51, MW20F52, MW20FM1, MW20FP1, MW20FP3, MW20H63	164
	MW24F11, MW24F51, MW24F52, MW24FM1, MW24FM3, MW24FP1, MW24FP3, MW24FPX, MW24H63	
	MW26G71, MW26H82, MW27F51, MW27FP1, MW27FPX, MW27H62, MW27H63, MW30G71	
	15DLV77, 17HLV85, 19HLV87, 20HLV15, 20HLV16, 20HLV85, 20HLV86, 23HVL86, 23HLV87	
	D-KR2SU, KR4SU, R2SC, R2SU, R4SC, R4SU, RD- XS32SC, XS32SU, XS34SC, XS34SU, XS35SC, XS35SU, XS54, XS55	188
	BD-HP20, HD-A1, A2, A20, A3, A30, A35, D2, XA1, XA2	273
	BDX1100KU	356
	SD-1200, 1700, 1800, 1810, 2109, 2200, 2300, 2700, 2705, 2715, 2800, 2805, 2815, 2900	035
	SD-3109, 3205, 3750, 3780, 3800, 3805, 3815, 3950, 3960, 3980SC, 3980SU, 3990	
	SD-4000, 4205, 4800, 4900, 4901XU, 4980SU, 4990, 5000, 5109, 5915, 6000, 6100, 7990	
	SD-K510, K530SU, K600, 610, K740SU, K760, K770, K860, V291, V391, V392, V592SU, V594, V596SU, V630SU	
SE-R0022	034	
TRUTECH	293	
URBAN_CONCEPTS	035	
US_LOGIC		111
		282
VENTURER	STS31-S	149
VINC	BRAVO_D1	161
	BRAVO_D2	308

X-BOX		027
		206
YAMAHA	DVD-C900, C996, S996, DVD1	089
	DV-5650, SL100, S540	066
	DV-C6860, S5950, S1700, S2300MKII, S2700, S659, YHT-680	197
	DVD-S1200	138
	BD-A1000, S2900, S667, BDP-110	334
ZENITH		057
	DVIX	074
	DVB251, 312, 317, 318, 352, XBV243, XBV342, XBV343, XBV443	091

## DVR

Manufacturer & Brand	Supported models	Code_Number
DIRECTV	HR20,21	819
DSTV	DSTV[D]	786
	DSTV[A]	787
	DSTV[B]	788
	DSTV[C]	789
HUGHES	GXCEBOT	817
	HDVR2	
	SD-DVR120,DVR40	
HUMAX		817
ICREALTIME	FLEX16,4,8	784
	MAX16,4,8	
MOXI	HD_DVR_MR-1500T3	782
PHILIPS	TIVO1	790
	DSR6000R,7000,704,708	817
RCA	DVD490RE	809
REPLAYNETWORKS	REPLAY1	001
	RTV5040,5060,5080,5160,5504,5508,5516,5532	
SONY	RM-Y809	804
	SAT-T60,W60	
	SVR-2000	805
TOSHIBA		817

## Troubleshooting

### General

Problem	Resolution
Cannot control the TV with the remote control.	<ul style="list-style-type: none"> <li>• Check the remote control sensor on the product and try again.</li> <li>• Check if there is any obstacle between the product and the remote control.</li> <li>• Check if the batteries are still working and properly installed (⊕ to ⊕, ⊖ to ⊖).</li> </ul>
No image display and no sound is produced.	<ul style="list-style-type: none"> <li>• Check if the product is turned on.</li> <li>• Check if the power cord is connected to a wall outlet.</li> <li>• Check if there is a problem in the wall outlet by connecting other products.</li> </ul>
Image appears slowly when the TV turns on.	<ul style="list-style-type: none"> <li>• The image is muted during the product startup process. This is normal. If the image does not appear in a few minutes, unplug the TV for 30 seconds and try again. If the image still does not appear, contact the authorized service center in your local area.</li> </ul>
Cannot connect external devices.	<ul style="list-style-type: none"> <li>• Refer to the "Connection Overview" and connect an external device.</li> </ul>
The TV turns off suddenly.	<ul style="list-style-type: none"> <li>• Check the power control settings. The power supply may be interrupted.</li> <li>• Check if the Auto sleep feature is activated in the Time settings. Refer to the "Sleep Timer".</li> <li>• If there is no signal while the TV is on, the TV will turn off automatically after 15 minutes of inactivity.</li> </ul>

### Audio

Problem	Resolution
No sound is produced while images are displaying.	<ul style="list-style-type: none"> <li>• Press <b>VOL +</b> or <b>-</b> button.</li> <li>• Check if the sound is muted by pressing <b>MUTE</b>.</li> <li>• Scroll to other channels. There may a problem with the broadcast.</li> <li>• Check if the TV Speaker feature is activated in the menu option.</li> </ul>
No output from one of the speakers	<ul style="list-style-type: none"> <li>• Adjust Balance in the menu option.</li> </ul>
Unusual sound from inside the TV is produced.	<ul style="list-style-type: none"> <li>• A change in ambient humidity or temperature may result in an unusual noise when the product turns on or off. There is no problem with your product.</li> </ul>



## Video

Problem	Resolution
An image displays in black and white or the color quality is poor.	<ul style="list-style-type: none"> <li>Adjust the color setting in the menu option.</li> <li>Keep a sufficient distance between this product and other electronic products.</li> <li>Scroll to other channels. There may a problem with the broadcast.</li> </ul>
Horizontal or vertical bars appears or images blur	<ul style="list-style-type: none"> <li>Check if there are local interferences such as an electrical appliance or power tool.</li> </ul>
Lines or streaks appear on images	<ul style="list-style-type: none"> <li>Check the antenna or aim the antenna to the proper direction.</li> </ul>
Afterimages (ghosts) appear when the product turns off	<ul style="list-style-type: none"> <li>Pixels may have been damaged from a fixed image displayed for a long time (image burn). Use a screen saver to prevent the pixel damage on the screen.</li> </ul>
The power is on but the screen appears extremely dark.	<ul style="list-style-type: none"> <li>Adjust the brightness and contrast in the menu option.</li> </ul>
"No Signal" appears on the screen.	<ul style="list-style-type: none"> <li>Check if the signal cable is connected between the TV and products properly.</li> <li>Check the selected input source by pressing <b>INPUT</b>.</li> </ul>
Black spots appear on the screen.	<ul style="list-style-type: none"> <li>Several pixels in red, green, white, or black may appear on the screen that can attribute to the characteristics of the panel. This is normal.</li> </ul>
The display offset is wrong.	<ul style="list-style-type: none"> <li>Adjust the position setting in the Picture menu.</li> <li>Check if the video card resolution and frequency are supported by the product. If the frequency is out of range, set to the recommended resolution using the display settings on the external device.</li> </ul>
Thin lines appear in the background of the screen.	<ul style="list-style-type: none"> <li>Check the video cable connections.</li> </ul>
Horizontal noises appear or characters blur.	<ul style="list-style-type: none"> <li>Adjust the Phase setting in the menu option. Refer to the "SCREEN (RGB-PC)".</li> </ul>
The reception on some channels is poor	<ul style="list-style-type: none"> <li>Scroll to other channels. There may a problem with the broadcast.</li> <li>The station signal may be weak. Aim the antenna to the proper direction.</li> <li>Check if there is local interferences such as an electrical appliance or power tool.</li> </ul>

## Movie

Problem	Resolution
The file does not appear on the Movie List.	<ul style="list-style-type: none"> <li>Check whether the extension is supported.</li> </ul>
Message is displayed saying "This file is invalid" or the audio is working normally but the video is not working normally.	<ul style="list-style-type: none"> <li>Check whether the file is playing normally on a PC. (Check whether the file is damaged.)</li> <li>Check whether the resolution is supported.</li> <li>Check whether the video/audio codec is supported.</li> <li>Check whether the frame rate is supported.</li> </ul>
Message is displayed saying "Unsupported Audio" or the video is working normally but the audio is not working normally.	<ul style="list-style-type: none"> <li>Check whether the file is playing normally on a PC. (Check whether the file is damaged.)</li> <li>Check whether the audio codec is supported.</li> <li>Check whether the bit rate is supported.</li> <li>Check whether the sample rate is supported.</li> </ul>
Subtitle is not working.	<ul style="list-style-type: none"> <li>Check whether the file is playing normally on a PC. (Check whether the file is damaged.)</li> <li>Check whether the video file and subtitle file name are the same.</li> <li>Check whether the video file and subtitle file are located in the same folder.</li> <li>Check whether the subtitle file is supported.</li> <li>Check whether the language is supported. (When you open the subtitle file in Memo Pad, you can check the language of the subtitle file.)</li> </ul>

## Pentouch

Problem	Resolution
The touch pen does not work.	<ul style="list-style-type: none"> <li>• Check that you used the remote control to enter Pentouch mode.</li> <li>• Check that the Pentouch dongle is connected to the computer and the red LED is on.</li> <li>• Press the <b>⏻ (POWER)</b> button on the touch pen to check that it is powered on.</li> <li>• Check that the touch pen is paired for use. (The touch pen is correctly paired if the red LED is on once when you press the <b>Home</b> button on the touch pen.)</li> <li>• Set the computer screen to display only on the TV.</li> </ul>
The TV screen doesn't look normal when using Pentouch.	<ul style="list-style-type: none"> <li>• Check that the computer is correctly connected to the TV.</li> <li>• Check that you are using the optimal resolution.</li> <li>• Set the aspect ratio on the TV to Just Scan.</li> </ul>
The touch pen is touched on wrong positions.	<ul style="list-style-type: none"> <li>• Set the computer screen to display only on the TV.</li> <li>• If the point you touch on the TV screen using the touch pen and the point indicated as touched on the computer screen do not match when the computer and the TV are connected by a PC signal (RGB) cable, use the TV remote control to select [SETTINGS] → [Picture] → [Screen] (RGB-PC), then select [Auto Config.] to adjust the screen.</li> </ul>
The touch pen movement is not smooth.	<ul style="list-style-type: none"> <li>• Check whether the computer and the TV are too far from each other. Check whether there are too many obstructions between the computer and the TV.</li> <li>• Check whether many other applications are running on the computer. (Please avoid running other applications while using the Pentouch program.)</li> </ul>

## Specifications

Product specifications may be changed without prior notice due to upgrade of product functions.

Power requirement	USA, Canada, Mexico: AC 120 V ~ 50 / 60 Hz Other Country: AC 100 - 240 V ~ 50 / 60 Hz	
Television System	NTSC-M, ATSC, 64 & 256 QAM	
Program Coverage	VHF 2-13, UHF 14-69, CATV 1-135, DTV 2-69, CADTV 1-135	
External Antenna Impedance	75 $\Omega$	
Environment condition	Operating Temperature	0 - 40 °C
	Operating Humidity	Less than 80 %
	Storage Temperature	-20 - 60 °C
	Storage Humidity	Less than 85 %

MODELS		47LMG620 (47LMG620-UG)	55LMG620 (55LMG620-UG)
Dimensions (W x H x D)	With stand	1089 x 722 x 263 mm (42.9 x 28.4 x 10.4 inch)	1263 x 830 x 331 mm (49.7 x 32.7 x 13.0 inch)
	Without stand	1089 x 655 x 35.5 mm (42.9 x 25.8 x 1.4 inch)	1263 x 754 x 35.5 mm (49.7 x 29.7 x 1.4 inch)
Weight	With stand	17.8 kg (39.2 lbs)	25.7 kg (56.7 lbs)
	Without stand	15.6 kg (34.4 lbs)	21.9 kg (48.3 lbs)
Current Value / Power consumption		1.2 A / 120 W	1.5 A / 150 W

## RGB (PC), HDMI (PC) supported mode

Resolution	Horizontal Frequency (KHz)	Vertical Frequency (Hz)
640x350	31.468	70.09
720x400	31.469	70.08
640x480	31.469	59.94
800x600	37.879	60.31
1024x768	48.363	60.00
1360x768	47.712	60.015
1280x1024 HDMI-PC	63.981	60.02
1920x1080 HDMI-PC	67.50	60.00

## HDMI (DTV) supported mode

Resolution	Horizontal Frequency (KHz)	Vertical Frequency (Hz)
720x480p	31.47	59.94
	31.50	60.00
1280x720p	44.96	59.94
	45.00	60.00
1920x1080i	33.72	59.94
	33.75	60.00
1920x1080p	26.97	23.976
	27.00	24.00
	33.71	29.97
	33.75	30.00
	67.432	59.94
	67.50	60.00

## Component port connecting information

Component ports on the TV	Y	P <sub>B</sub>	P <sub>R</sub>
---------------------------	---	----------------	----------------

Video output ports on DVD player	Y	P <sub>B</sub>	P <sub>R</sub>
	Y	B-Y	R-Y
	Y	Cb	Cr
	Y	Pb	Pr

## Component supported mode

Resolution	Horizontal Frequency (KHz)	Vertical Frequency (Hz)
720x480i	15.73	59.94
	15.73	60.00
720x480p	31.47	59.94
	31.50	60.00
1280x720p	44.96	59.94
	45.00	60.00
1920x1080i	33.72	59.94
	33.75	60.00
1920x1080p	26.97	23.976
	27.00	24.00
	33.71	29.97
	33.75	30.00
	67.432	59.94
	67.50	60.00

## Video Supported Formats (Depending on model)

Extension name	File	Video Decoder	Audio Codec	Max Resolution
mpg, mpeg		MPEG1, MPEG2	MP2, MP3, Dolby Digital, LPCM	1920 x 1080 @ 30p (Only Motion JPEG 640x480@30p)
dat		MPEG1	MP2	
ts, trp, tp		MPEG2, H.264, AVS, VC1	MP2, MP3, Dolby Digital, AAC, HE-AAC	
vob		MPEG1, 2	MP2, MP3, Dolby Digital, LPCM	
mp4, mov		MPEG4, DivX 3.11, DivX 4.12, DivX 5.x, DivX 6, Xvid 1.00, Xvid 1.01, Xvid 1.02, Xvid 1.03, Xvid 1.10-beta1/2H.264	AAC, HE-AAC, MP3	
mkv		H.264, MPEG-1,2,4	MP2, MP3, Dolby Digital, AAC HE-AAC, LPCM	
divx, avi		MPEG2, MPEG4, DivX 3.11, DivX 4, DivX 5, DivX 6, Xvid 1.00, Xvid 1.01, Xvid 1.02, Xvid 1.03, Xvid 1.10-beta1/2H.264	MP2, MP3, Dolby Digital, LPCM, ADPCM, AAC, HE-AAC	
Motion JPEG (avi, mp4, mkv)		JPEG	LPCM, ADPCM	
asf, wmv		VC1	WMA	
flv		Sorenson H.263, H264	MP3, AAC	

## Open Source Software Notice

To obtain the source code under GPL, LGPL, MPL and other open source licenses, that is contained in this product, please visit <http://opensource.lge.com>.

In addition to the source code, all referred license terms, warranty disclaimers and copyright notices are available for download.

LG Electronics will also provide open source code to you on CD-ROM for a charge covering the cost of performing such distribution (such as the cost of media, shipping and handling) upon email request to [opensource@lge.com](mailto:opensource@lge.com). This offer is valid for three (3) years from the date on which you purchased the product.

## Privacy Notice for the Google TV

Google takes privacy very seriously, and we work hard to ensure that we provide users with transparency, choice, and control whenever decisions regarding their personal information are involved. Our basic privacy approach is to make it easy for users to communicate and implement their own privacy choices through opt-in selections. Other privacy protections include support for Chrome's Incognito Mode for private browsing on the web, anonymization of most data collected after two weeks, and giving users options for clearing information stored on the box through the Settings menu.

Please note that Google does not collect any viewing history information unless a user opts in. We capture some limited usage and troubleshooting data which is anonymized after two weeks. In some cases, pay-TV operators like Dish may share with Google the tuning data and viewing history that they already collect if the user explicitly opts in to that sharing at setup. We provide this opt in feature for a more personalized Google TV integration.

Additionally, if the user opts in, we will collect a user's web browsing history and search history on the quick search facility on Google TV. Users may choose to opt out, use incognito mode in Chrome or control web history settings in Chrome as they do on other devices.

For more information about Google's Privacy policy visit <http://www.google.com/privacy.html>.

## Google TV Safety

There are no content-based parental controls on your Google TV device to limit what television programs can be accessed through your Google TV, however, if you have controls set up through your set-top box or through a V-Chip, they will continue to work for TV content shown through Google TV.

**Google Chrome & Android Market:** Users have the ability to lock out access to the Google TV Chrome browser and Android Market by requiring a 4-digit PIN code. To enable this option, press the **Search** key and type in 'Settings'. Navigate to **Privacy & safety** and scroll down until you reach **Application lock**. Pressing **Lock Google Chrome & Market** will allow you to type in a 4-digit PIN.

**SafeSearch:** Users can also implement **SafeSearch** to block web pages containing explicit sexual content from appearing in web and TV search results. To enable **Safe Search**, press the **Search** key and type in 'Settings'. Under **Privacy & safety**, select **SafeSearch**. There you will be able to select your Safe Search filter strength.

To help prevent malicious behavior on your TV, we take advantage of the same innovative security technology as Android and Chrome, including our Sandboxing and SafeBrowsing functionality. With Sandboxing, applications and processes on Google TV will run within a "sandbox" which limits their interaction with user data, system resources, and other apps. With SafeBrowsing, Google will present a warning if it detects that a user is trying to visit a site suspected of phishing or containing malware. We also run Chrome with lower privileges so it does not have access to information stored by other applications.

For more information about Google's safety tools, visit Google Family Safety Center at [www.google.com/familysafety/](http://www.google.com/familysafety/).



ENGLISH



The model and serial numbers of the TV is located on the back of the TV  
Record it below should you ever need service.

MODEL \_\_\_\_\_

SERIAL \_\_\_\_\_

## ■■■ Regulatory Information cont.

### :: FCC Compliance Statement

This equipment has been tested and found to comply within the limits of a Class B digital device pursuant to Part 15 of the FCC Rules. These limits are designed to provide reasonable protection against harmful interference in a residential installation.

This equipment generates, uses, and can radiate radio frequency energy and if not installed and used in accordance with the instructions, may cause harmful interference to radio communications. However, there is no guarantee that interference will not occur in a particular installation.

If this equipment does cause harmful interference to radio or television reception (which can be determined by turning the equipment on and off), the user is encouraged to try to correct the interference by using one or more of the following measures:

- Reorient or relocate the receiving antenna.
- Increase the separation between the equipment and the receiver.
- Connect the equipment into an outlet on a circuit different from that to which the receiver is connected.
- Consult the dealer or an experienced radio/TV technician for help.

Caution: Changes or modifications not expressly approved by the party responsible for compliance could void the user's (or your) authority to operate the equipment. Only peripherals (digital input/output devices, terminals, printers, etc.) certified to comply with the Class B limits may be attached to this monitor. Operation with non-certified peripherals is likely to result in interference to radio and TV reception. Only shielded signal cables may be used with this System.

#### NOTICE

The regulations are applied only to the products with the ID LABEL indicating specific requirements.

### :: Canadian DOC Notice

This Class B digital apparatus meets all requirements of the Canadian Interference-Causing Equipment Regulations. Cet appareil numérique de la classe B

respecte toutes les exigences du Règlement sur le matériel brouilleur du Canada.

#### NOTICE

The regulations are applied only to the products with the ID LABEL indicating specific requirements.

### :: CE Conformity Notice (for Europe)

Products with the "CE" Marking comply with the EMC Directive(89/336/EEC) and LOW VOLTAGE Directive (73/23/EEC) issued by the Commission of the European Community.

Compliance with these directives implies conformity to the following European Norms :

- EN 55022 ; Radio Frequency Interference
- EN 55024 ; Electromagnetic Immunity
- EN 61000-3-2 ; Power Line Harmonics
- EN 61000-3-3 ; Voltage Fluctuations
- EN 60950-1 ; Product Safety

#### NOTICE

The regulations are applied only to the products with the ID LABEL indicating specific requirements.

### :: Low Radiation Compliance (MPR II)

This monitor meets one of the strictest guidelines available today for low radiation emissions, offering the user extra shielding and an antistatic screen coating. These guidelines, set forth by a government agency in Sweden, limit the amount of emission allowed in the Extremely Low Frequency (ELF) and Very Low Frequency (VLF) electromagnetic range.

### :: TCO'99 (TCO'99 applied model only)



#### Congratulations!

You have just purchased a TCO'99 approved and labelled product! Your choice has provided you with a product developed for professional use. Your purchase has also contributed to reducing the burden on the environment and also to the further development of environmentally adapted electronics products.

## ■■■ Regulatory Information cont.

### **Why do we have environmentally labelled computers?**

In many countries, environmental labelling has become an established method for encouraging the adaptation of goods and services to the environment. With the growing manufacture and usage of electronic equipment throughout the world, there is a recognized concern for the materials and substances used by electronic products with regards to their eventual recycling and disposal. By proper selection of these materials and substances, the impact on the environment can be minimized.

There are also other characteristics of a computer, such as energy consumption levels, that are important from the viewpoints of both the work (internal) and natural (external) environments. Electronic equipment in offices is often left running continuously, resulting in unnecessary consumption of large amounts of energy and additional power generation. From the standpoint of carbon dioxide emissions alone, it is vital to save energy.

### **What does labelling involve?**

The product meets the requirements for the TCO'99 scheme which provides for international and environmental labelling of personal computers and/or displays.

The labelling scheme was developed as a joint effort by the TCO (The Swedish Confederation of Professional Employees), Svenska Naturskyddsforeningen (The Swedish Society for Nature Conservation) and Statens Energimyndighet (The Swedish National Energy Administration).

Approval requirements cover a wide range of issues: ecology, ergonomics, emission of electrical and magnetical fields, energy consumption and electrical safety.

Ecological criteria impose restrictions on the presence and use of heavy metals, brominated and chlorinated flame retardants, and other substances. The product must be prepared for recycling and the manufacturing site(s) shall be certified according to ISO14001 or EMAS registered.

Energy requirements include a demand that the system unit and/or display, after a certain period of inactivity, shall reduce its power consumption to a lower level in one or more stages. The length of time to reactivate the system unit shall be reasonable for the user.

Labelled products must meet strict environmental demands, for example, in respect of the reduction of electrical and magnetical fields as well as work load and

visual ergonomics.

Below you will find a brief summary of the ecological requirements met by this product. The complete ecological criteria document can be found at TCO Development's website <http://www.tcodevelopment.com> or may be ordered from:

#### **TCO Development**

SE-114 94 STOCKHOLM, Sweden

Fax: +46 8 782 92 07

Email : [development@tco.se](mailto:development@tco.se)

Information regarding TCO'99 approved and labelled products may also be obtained at <http://www.tcodevelopment.com>

### **Ecological requirements**

#### **Flame retardants**

Flame retardants may be present in printed wiring board laminates, cables, and housings. Their purpose is to prevent, or at least to delay the spread of fire. Up to 30% by weight of the plastic in a computer casing can consist of flame retardant substances. Many flame retardants contain bromine or chlorine, and these flame retardants are chemically related to PCBs (polychlorinated biphenyls). Both the flame retardants containing bromine or chlorine and the PCBs are suspected of giving rise to health effects, including reproductive damage in fish-eating birds and mammals, due to the bio-accumulative\* processes when not disposed of in accordance with strict standards for disposal.

TCO'99 requires that plastic components weighing more than 25 grams shall not contain flame retardants with organically bound bromine or chlorine. Flame retardants are allowed in the printed wiring board laminates due to the lack of commercially available alternatives.

#### **Cadmium\*\***

Cadmium is present in rechargeable batteries and in the colour-generating layers of certain computer displays. TCO'99 requires that batteries, the colour-generating layers of display screens, and the electrical or electronics components shall not contain any cadmium.

#### **Mercury\*\***

Mercury is sometimes found in batteries, relays and switches. TCO'99 requires that batteries shall not contain any mercury. It also demands that mercury is not present in any of the electrical or electronics components associated with the labelled unit. There is however one

## ■■■ Regulatory Information cont.

exception. Mercury is, for the time being, permitted in the back light system of flat panel monitors as there today is no commercially available alternative. TCO aims on removing this exception when a mercury free alternative is available.

### Lead\*\*

Lead can be found in picture tubes, display screens, solders and capacitors. TCO'99 permits the use of lead due to the lack of commercially available alternatives, but in future requirements TCO Development aims at restricting the use of lead.

\* Bio-accumulative is defined as substances which accumulate in living organisms.

\*\*Lead, Cadmium and Mercury are heavy metals which are bio-accumulative.

:: **TCO'03** (TCO'03 applied model only)



### Congratulations!

The display you have just purchased carries the TCO'03 Displays label.

This means that your display is designed, manufactured and tested according to some of the strictest quality and environmental requirements in the world. This makes for a high performance product, designed with the user in focus that also minimizes the impact on our natural environment. Some of the features of the TCO'03 Display requirements:

### Ergonomics

- Good visual ergonomics and image quality in order to improve the working environment for the user and to reduce sight and strain problems. Important parameters are luminance, contrast, resolution, reflectance, colour rendition and image stability.

### Energy

- Energy-saving mode after a certain time – beneficial both for the user and the environment
- Electrical safety

### Emissions

- Electromagnetic fields

- Noise emissions

### Ecology

- The product must be prepared for recycling and the manufacturer must have a certified environmental management system such as EMAS or ISO 14 001
- Restrictions on
  - chlorinated and brominated flame retardants and polymers
  - heavy metals such as cadmium, mercury and lead.

The requirements included in this label have been developed by TCO Development in co-operation with scientists, experts, users as well as manufacturers all over the world. Since the end of the 1980s TCO has been involved in influencing the development of IT equipment in a more user-friendly direction. Our labelling system started with displays in 1992 and is now requested by users and IT-manufacturers all over the world.

For more information, please visit  
[www.tcodevelopment.com](http://www.tcodevelopment.com)

## English

### Information for Environmental Preservation

LGE. announced the 'LG Declaration for a Cleaner Environment' in 1994, and this ideal has served as a guiding managerial principle ever since. The Declaration is a foundation that has allowed us to undertake environmentally friendly activities in careful consideration of economic, environmental, and social aspects.

We promote activities for environmental preservation, and we specifically develop our products to embrace the concept of environment-friendly.

We minimize the hazardous materials contained in our products. For example, there is no cadmium to be found in our monitors.

### Information for recycling

This monitor may contain parts which could be hazardous to the environment. It is important that this monitor be recycled after use.

LGE. handles all waste monitors through an environmentally acceptable recycling method. There are several take-back and recycling systems currently in

## ■■■ Regulatory Information cont.

operation worldwide. Many parts will be reused and recycled, while harmful substances and heavy metals are treated by an environmentally friendly method.

If you want to find out more information about our recycling program, please contact your local LG vendor or a corporate representative of LG.

We set our vision and policies on a cleaner world by selecting the issue of the global environment as a task for corporate improvement. Please visit our website for more information about our 'green' policies.

<http://www.lge.com/about/environment/html/Recycling.jsp>

### ■ ■ ■ Deutsch

#### Informationen zur Erhaltung der Umwelt

Im Jahr 1994 verkündete LGE die 'LG Declaration for a Cleaner Environment' (LG Erklärung für eine sauberere Umwelt). Seitdem dient dieses Ideal als führendes Prinzip des Unternehmens. Diese Erklärung war die Basis für die Durchführung von

umweltfreundlichen Aktivitäten, wobei wirtschaftliche, umweltbezogene und soziale Aspekte in die Überlegungen mit einbezogen wurden.

Wir fördern Aktivitäten zum Schutz der Umwelt und die Entwicklung unserer Produkte ist darauf ausgerichtet, unserem Konzept bezüglich Umweltfreundlichkeit gerecht zu werden.

Wir sind darauf bedacht, den Anteil der in unseren Produkten enthaltenen schädlichen Materialien zu minimieren. So ist in unseren Monitoren beispielsweise kein Kadmium zu finden.

#### Informationen zum Thema Recycling

Dieser Monitor enthält Teile, die umweltschädlich sein können. Es ist unbedingt erforderlich, dass der Monitor recycelt wird, nachdem er außer Dienst gestellt wurde.

Bei LGE. werden alle ausrangierten Monitore in einem unter umweltbezogenen Aspekten geeigneten Verfahren recycelt. Augenblicklich sind weltweit mehrere Rücknahme- und Recyclingsysteme im Einsatz. Viele Teile werden wieder verwendet und recycelt. Schädliche Substanzen und Schwermetalle werden durch umweltverträgliche Verfahren behandelt.

Falls Sie mehr über unser Recyclingprogramm erfahren möchten, wenden Sie sich bitte an Ihren lokalen LG-Händler oder einen Unternehmensvertreter von LG.

Wir richten unsere Firmenpolitik auf eine sauberere Umwelt hin aus, indem wir umweltspezifische Aspekte als wichtigen Punkt in die Weiterentwicklung unseres Unternehmens einfließen lassen. Zusätzliche Informationen über unsere 'grüne' Firmenpolitik erhalten Sie auf unserer Website.

<http://www.lge.com/about/environment/html/Recycling.jsp>

### ■ ■ ■ Français

#### Information sur la protection de l'environnement

LGE. a publié sa 'Déclaration en faveur d'un environnement plus propre' en 1994 et celle-ci est restée, depuis lors, un principe directeur de notre entreprise. Cette déclaration a servi de base à notre réflexion et nous a permis de prendre en compte à la fois les aspects économiques et sociaux de nos activités, tout en respectant l'environnement.

Nous encourageons les activités en faveur de la préservation de l'environnement et c'est dans cet esprit que nous développons nos produits : nous réduisons au minimum les matières dangereuses qui entrent dans leur composition et l'on ne trouve pas de cadmium, par exemple, dans nos moniteurs.

#### Information sur le recyclage

Ce moniteur peut contenir des composants qui présentent un risque pour l'environnement. Il est donc important que celui-ci soit recyclé après usage.

LGE. traite les moniteurs en fin de cycle conformément à une méthode de recyclage respectueuse de l'environnement. Nous reprenons nos produits et les recyclons dans plusieurs sites répartis dans le monde entier. De nombreux composants sont réutilisés et recyclés, et les matières dangereuses, ainsi que les métaux lourds, sont traités selon un procédé écologique.

Si vous souhaitez plus de renseignements sur notre programme de recyclage, veuillez contacter votre revendeur LG ou un l'un de nos représentants.

Nous voulons agir pour un monde plus propre et croyons au rôle de notre entreprise dans l'amélioration de l'environnement. Pour plus de renseignements sur notre politique "verte", rendez visite à notre site :

<http://www.lge.com/about/environment/html/Recycling.jsp>

## Regulatory Information cont.

### Italiano

#### Informazioni per la tutela dell'ambiente

La LGE. ha annunciato nel 1994 la cosiddetta 'LG Declaration for a Cleaner Environment' (Dichiarazione di LG a favore di un ambiente più pulito), un ideale che da allora funge da principio ispiratore della gestione aziendale. La dichiarazione rappresenta il fondamento che consente di intraprendere attività a favore dell'ambiente tenendo conto degli aspetti economici, ambientali e sociali. Noi della LG, promuoviamo attività a favore della tutela dell'ambiente sviluppando appositamente i nostri prodotti per cogliere il concetto del rispetto dell'ambiente riducendo i materiali dannosi presenti nei nostri prodotti. Ad esempio nei nostri monitor non è presente il cadmio.

#### Informazioni per il riciclaggio

Il monitor può presentare componenti che potrebbero risultare eventualmente dannosi per l'ambiente. È importante che il monitor sia riciclato al termine del suo utilizzo.

La LGE. gestisce tutti i monitor di rifiuto con un metodo di riciclaggio soddisfacente dal punto di vista ambientale. In tutto il mondo sono attualmente in funzione numerosi sistemi di riciclaggio e recupero. I diversi componenti sono riutilizzati e riciclati, mentre le sostanze dannose e i metalli pesanti vengono trattati con un metodo rispettoso dell'ambiente.

Se si desiderano maggiori informazioni in merito al programma di riciclaggio, è consigliabile rivolgersi al proprio rivenditore LG o ad un rappresentante aziendale della LG.

Noi della LG impostiamo la nostra visione e le nostre politiche a favore di un mondo più pulito ponendo la questione dell'ambiente dal punto di vista globale come una mansione rivolta al miglioramento della nostra azienda. Vi invitiamo a visitare il nostro sito internet per ulteriori informazioni sulla nostra politica "verde".  
<http://www.lge.com/about/environment/html/Recycling.jsp>

### Espanol

#### Información para la conservación medioambiental

LGE. presentó la 'Declaración para un entorno más limpio de LG' en 1994 y este ideal ha servido para guiar nuestros principios empresariales desde entonces. La Declaración es la base que nos ha permitido llevar a cabo tareas que

respetan el medio ambiente siempre teniendo en cuenta aspectos sociales, económicos y medioambientales.

Promocionamos actividades orientadas a la conservación del medio ambiente y desarrollamos nuestros productos específicamente para que se ajusten a la filosofía que protege el entorno.

Reducimos al máximo el uso de materiales de riesgo en nuestros productos. Un ejemplo de ello es la ausencia total de cadmio en nuestros monitores.

#### Información para el reciclaje

Este monitor puede contener piezas que entrañen riesgos medioambientales. Es importante reciclar este monitor después de su utilización.

LGE. trata todos los monitores usados siguiendo un método de reciclaje que no daña al entorno. Contamos con diversos sistemas de recuperación y reciclaje que funcionan a nivel mundial en la actualidad. Es posible reciclar y reutilizar muchas de las piezas, mientras que las sustancias dañinas y los metales pesados se tratan siguiendo un método que no perjudique al medio ambiente. Si desea obtener más información acerca del programa de reciclaje, póngase en contacto con su proveedor local de LG o con un representante empresarial de nuestra marca.

Basamos nuestra visión y nuestras políticas en un mundo más limpio y para ellos optamos por un entorno global como tarea principal de nuestra evolución como empresa. Visite nuestra página Web para obtener más información sobre nuestras políticas ecológicas.

<http://www.lge.com/about/environment/html/Recycling.jsp>

### Português

#### Informações relacionadas à preservação ambiental

A LGE. anunciou a 'LG Declaration for a Cleaner Environment' (Declaração da LG para um ambiente mais limpo) em 1994 e esse ideal tem servido desde então como um princípio administrativo de orientação. A Declaração é a base que nos tem permitido realizar atividades favoráveis ao ambiente com consideração atenta aos aspectos econômicos, ambientais e sociais.

Promovemos atividades de preservação ambiental e desenvolvemos nossos produtos para englobar

## ■■■ Regulatory Information cont.

especificamente o conceito de favorável ao ambiente.

Reduzimos os materiais perigosos contidos em nossos produtos. Por exemplo, não há cádmio em nossos monitores.

### Informações relacionadas à reciclagem

Este monitor pode conter peças que podem representar riscos ao ambiente. É importante que ele seja reciclado após o uso.

A LGE, cuida de todos os monitores descartados através de um método de reciclagem agradável ao ambiente. Há vários sistemas de devolução e reciclagem atualmente em operação no mundo. Muitas peças serão reutilizadas e recicladas e as substâncias nocivas e os metais pesados passarão por tratamento através de um método favorável ao ambiente.

Para obter mais informações sobre nosso programa de reciclagem, entre em contato com seu fornecedor LG local ou com um representante corporativo da LG.

Definimos nossa visão e nossas políticas relacionadas a um mundo mais limpo selecionando a questão do ambiente global como uma tarefa de aprimoramento corporativo. Visite nosso site para obter mais informações sobre nossas políticas de meio ambiente.

<http://www.lge.com/about/environment/html/Recycling.jsp>

### ■ ■ ■ Nederlands

#### Informatie met betrekking tot het behoud van het milieu

LGE publiceerde in 1994 de 'LG Declaration for a Cleaner Environment' (de LG-verklaring met betrekking tot een schoner milieu). Deze verklaring en het ideaal van een schoner milieu fungeren sindsdien als een bestuurlijke leidraad voor onze onderneming. Op basis van deze verklaring ontplooiën wij milieuvriendelijke activiteiten, waarbij er zowel met sociale en economische aspecten, als met milieuaspecten zorgvuldig rekening wordt gehouden.

Wij ondersteunen activiteiten die zijn gericht op het behoud van het milieu en wij houden bij het ontwikkelen onze producten specifiek rekening met de milieuvriendelijkheid van onze producten.

Wij minimaliseren het gebruik van schadelijke stoffen in onze producten. Er wordt bijvoorbeeld geen cadmium verwerkt in onze monitoren.

#### Informatie met betrekking tot recycling

Deze monitor bevat materialen die schadelijk zouden kunnen zijn voor het milieu. Het is belangrijk dat deze monitor aan het einde van zijn levensduur wordt gerecycled.

LGE verwerkt alle afvalmonitoren via een milieuvriendelijke recyclingmethode. Hiervoor worden er momenteel wereldwijd verscheidene inname- en recyclingsystemen gehanteerd. Een groot aantal onderdelen wordt opnieuw gebruikt en gerecycled, waarbij schadelijke stoffen en zware metalen volgens een milieuvriendelijke methode worden verwerkt.

Voor meer informatie over ons recyclingprogramma kunt u contact opnemen met uw plaatselijke LG-vertegenwoordiger of een LG-vestiging.

Onze visie en ons beleid met betrekking tot een schonere wereld vloeien voort uit het feit dat wij het milieu hebben aangemerkt als een onderwerp dat speciale aandacht verdient binnen onze onderneming. Bezoek onze website voor meer informatie over ons 'groene' beleid.

<http://www.lge.com/about/environment/html/Recycling.jsp>

### ■ ■ ■ Russian

#### Информация по охране окружающей среды

В 1994 году корпорация LGE опубликовала 'Декларацию LG по охране окружающей среды', которая с тех пор служит основным принципом управления. На основе этой декларации мы смогли предпринять действия, обеспечивающие безопасность окружающей среды, уделяя при этом должное внимание экономическим, экологическим и социальным аспектам.

Мы стимулируем деятельность по охране окружающей среды, уделяя особое внимание разработке нашей продукции в соответствии с концепцией экологической безопасности.

Мы сводим к минимуму содержание опасных веществ в нашей продукции. Например, в наших мониторах вы не найдете кадмия.

#### Информация по утилизации отходов

Этот монитор может содержать компоненты, которые могут нанести ущерб окружающей среде.



■■■ Regulatory Information cont.

Необходимо утилизировать монитор после использования.

Корпорация LGE перерабатывает все бракованные мониторы с помощью экологически приемлемого метода утилизации отходов. По всему миру действуют системы утилизации отходов и возврата использованной продукции. Многие компоненты будут вторично использованы и утилизированы, в то время как вредные вещества и тяжелые металлы будут обработаны с помощью экологически приемлемого метода.

За более подробной информацией по нашей программе утилизации отходов обращайтесь к местному поставщику или представителю корпорации LG.

Мы ориентируемся на обеспечение экологической безопасности, ставя себе целью глобальную защиту окружающей среды. Дополнительную информацию о нашей политике по охране окружающей среды вы можете найти на нашем сайте:  
<http://www.lge.com/about/environment/html/Recycling.jsp>

한국어

환경 보존 정보

LG 전자는 1994년 'LG 환경 선언문'을 발표한 후 현재까지 이를 기업 경영의 이념으로 삼아왔습니다. 이 선언문을 바탕으로 LG 전자는 모든 경영 활동에서 경제성뿐만 아니라 환경성 및 사회성을 주요 의사 결정의 기준으로 삼음으로써 지속적으로 환경 친화적인 경영을 전개하고 있습니다.

본사는 보다 활발한 환경 보존 활동과 더불어 환경 친화적 제품 개발에 주력해 왔습니다.

또한 제품에 포함되는 환경 위해 요소를 최소화하는 데에도 노력을 기울이지 않고 있습니다. LG 전자 모니터의 경우 카드를 전혀 사용하지 않는 것에서도 이러한 노력을 알 수 있습니다.

재활용 정보

본 모니터에는 환경에 위해를 주는 부품이 포함되어 있을 수도 있습니다. 따라서 사용이 끝난 모니터는 재활용하는 것이 좋습니다.

폐모니터는 모두 환경 친화적 방식으로 처리됩니다. 현재 세계적으로 운영되고 있는 회수 및 재활용 시스템에는

여러 가지가 있습니다. 대부분의 부품의 경우 재사용 또는 재활용되지만 환경 위해 물질과 중금속은 환경 친화적 방법으로 처리됩니다.

본사의 재활용 프로그램에 대한 자세한 정보는 각 지역의 LG 공급업체나 LG 기업 대표부에 문의하시기 바랍니다.

LG 전자는 기업 개선 정책의 하나로 지구 환경 문제를 채택함으로써 보다 나은 환경을 만들어 나가기 위한 비전과 정책을 수립했습니다. 본사의 친환경 정책에 대한 자세한 정보를 보시려면 아래의 웹 사이트를 방문하십시오.

[http://www.lge.co.kr/cckr/about/environ/purity\\_02.jsp](http://www.lge.co.kr/cckr/about/environ/purity_02.jsp)

∴EPA (EPA applied model only)

ENERGY STAR is a set of power-saving guidelines issued by the U.S. Environmental Protection Agency(EPA).



As an ENERGY STAR Partner LGE U. S. A.,Inc. has determined that this product meets the ENERGY STAR guidelines for energy efficiency.

∴NOM MARK (Mexico only)





## ■■■ Regulatory Information cont.

### :: WEEE (for Europe )



#### English

##### Disposal of your old appliance

1. When this crossed-out wheeled bin symbol is attached to a product it means the product is covered by the European Directive 2002/96/EC.
2. All electrical and electronic products should be disposed of separately from the municipal waste stream via designated collection facilities appointed by the government or the local authorities.
3. The correct disposal of your old appliance will help prevent potential negative consequences for the environment and human health.
4. For more detailed information about disposal of your old appliance, please contact your city office, waste disposal service or the shop where you purchased the product.

#### French

##### Élimination de votre ancien appareil

1. Ce symbole, représentant une poubelle sur roulettes barrée d'une croix, signifie que le produit est couvert par la directive européenne 2002/96/EC.
2. Les éléments électriques et électroniques doivent être jetés séparément, dans les vide-ordures prévus à cet effet par votre municipalité.
3. Une élimination conforme aux instructions aidera à réduire les conséquences négatives et risques éventuels pour l'environnement et la santé humaine.
4. Pour plus d'information concernant l'élimination de votre ancien appareil, veuillez contacter votre mairie, le service des ordures ménagères ou encore la magasin où vous avez acheté ce produit.

#### Italian

##### Smaltimento delle apparecchiature obsolete

1. Quando su un prodotto è riportato il simbolo di

un bidone della spazzatura barrato da una croce significa che il prodotto è coperto dalla direttiva europea 2002/96/EC.

2. Tutti i prodotti elettrici ed elettronici dovrebbero essere smaltiti separatamente rispetto alla raccolta differenziata municipale, mediante impianti di raccolta specifici designati dal governo o dalle autorità locali.
3. Il corretto smaltimento delle apparecchiature obsolete contribuisce a prevenire possibili conseguenze negative sulla salute umana e sull'ambiente.
4. Per informazioni più dettagliate sullo smaltimento delle apparecchiature obsolete, contattare il comune, il servizio di smaltimento rifiuti o il negozio in cui è stato acquistato il prodotto.

#### Swedish

##### Kassering av din gamla apparat

1. När den här symbolen med en överkryssad soptunna på hjul sitter på en produkt innebär det att den regleras av European Directive 2002/96/EC.
2. Alla elektriska och elektroniska produkter bör kasseras via andra vägar än de som finns för hushållsavfall, helst via för ändamålet avsedda uppsamlingsanläggningar som myndigheterna utser.
3. Om du kasserar din gamla apparat på rätt sätt så bidrar du till att förhindra negativa konsekvenser för miljön och människors hälsa.
4. Mer detaljerad information om kassering av din gamla apparat kan fås av kommunen, renhållningsverket eller den butik där du köpte produkten.

#### Dutch

##### Uw oude toestel wegdoen

1. Als het symbool met de doorgekruiste verrijdbare afvalbak op een product staat, betekent dit dat het product valt onder de Europese Richtlijn 2002/96/EC.
2. Elektrische en elektronische producten mogen niet worden meegegeven met het huishoudelijk afval, maar moeten worden ingeleverd bij speciale inzamelingspunten die door de lokale of landelijke overheid zijn aangewezen.
3. De correcte verwijdering van uw oude toestel helpt negatieve gevolgen voor het milieu en de menselijke gezondheid voorkomen.

## Regulatory Information cont.

4. Wilt u meer informatie over de verwijdering van uw oude toestel? Neem dan contact op met uw gemeente, de afvalophaaldienst of de winkel waar u het product hebt gekocht.

### Finnish

#### Vanhonjen laitteiden hävittäminen

1. Tämä merkki tuotteessa tarkoittaa, että tuote kuuluu sähkö- ja elektroniikkalaiteromusta annetun EU-direktiivin 2002/96/EY soveltamisalaan.
2. Kaikki elektroniset laitteet ovat ongelmajätettä, joten ne on toimitettava paikalliseen keräyspisteeseen.
3. Vanhan laitteen asianmukainen hävittäminen ehkäisee mahdollisia ympäristöön ja terveyteen kohdistuvia haittavaikutuksia.
4. Lisätietoa vanhan laitteen hävittämisestä saat ottamalla yhteyden paikallisiin viranomaisiin, kierrätyskeskukseen tai myymälään, josta ostit laitteen.

### German

#### Entsorgung von Altgeräten

1. Wenn dieses Symbol eines durchgestrichenen Abfalleimers auf einem Produkt angebracht ist, unterliegt dieses Produkt der europäischen Richtlinie 2002/96/EC.
2. Alle Elektro- und Elektronik-Altgeräte müssen getrennt vom Hausmüll über dafür staatlich vorgesehenen Stellen entsorgt werden.
3. Mit der ordnungsgemäßen Entsorgung des alten Geräts vermeiden Sie Umweltschäden und eine Gefährdung der persönlichen Gesundheit.
4. Weitere Informationen zur Entsorgung des alten Geräts erhalten Sie bei der Stadtverwaltung, beim Entsorgungsamt oder in dem Geschäft, wo Sie das Produkt erworben haben.

### Danish

#### Sådan smider du dit gamle apparat ud

1. Når der er et tegn med et kryds over en skraldespand, betyder det, at produktet er omfattet af EU-direktiv 2002/96/EC.
2. Alle elektriske og elektroniske produkter skal smides ud et andet sted end gennem den kommunale affaldsordning ved hjælp af specielle indsamlingsfaciliteter, der er organiseret af staten

eller de lokale myndigheder.

3. Korrekt bortskaffelse af dit gamle apparat er med til at forhindre mulige skadevirkninger på miljøet og menneskelig sundhed.
4. Mere detaljerede oplysninger om bortskaffelse af dit gamle apparat kan fås ved at kontakte dit lokale kommunekontor, renovationselskab eller den butik, hvor du købte produktet.

### Greek

#### Απόρριψη της παλιάς σας συσκευής

1. Όταν ένα προϊόν διαθέτει το σύμβολο ενός διαγραμμένου κάλαθου απορριμμάτων, τότε το προϊόν καλύπτεται από την Ευρωπαϊκή Οδηγία 2002/96/EOK.
2. Η απόρριψη όλων των ηλεκτρικών και ηλεκτρονικών προϊόντων πρέπει να γίνεται χωριστά από τα γενικά οικιακά απορρίμματα μέσω καθορισμένων εγκαταστάσεων συλλογής απορριμμάτων, οι οποίες έχουν δημιουργηθεί είτε από την κυβέρνηση ή από τις τοπικές αρχές.
3. Η σωστή απόρριψη της παλιάς σας συσκευής θα βοηθήσει στην αποτροπή πιθανών αρνητικών συνπειών ως προς το περιβάλλον και την υγεία του ανθρώπου.
4. Για πιο λεπτομερείς πληροφορίες σχετικά με την απόρριψη της παλιάς σας συσκευής, επικοινωνήστε με το αρμόδιο τοπικό γραφείο, υπηρεσία διάθεσης οικιακών απορριμμάτων ή το μαγαζί από το οποίο αγοράσατε το προϊόν.

### Spanish

#### Cómo deshacerse de aparatos eléctricos y electrónicos viejos

1. Si en un producto aparece el símbolo de un contenedor de basura tachado, significa que éste se acoge a la Directiva 2002/96/CE.
2. Todos los aparatos eléctricos o electrónicos se deben desechar de forma distinta del servicio municipal de recogida de basura, a través de puntos de recogida designados por el gobierno o las autoridades locales.
3. La correcta recogida y tratamiento de los dispositivos inservibles contribuye a evitar riesgos potenciales para el medio ambiente y la salud pública.
4. Para obtener más información sobre cómo deshacerse de sus aparatos eléctricos y electrónicos viejos, póngase en contacto con su ayuntamiento, el servicio de recogida de basuras o el establecimiento donde adquirió el producto.

## Regulatory Information cont.

### Portuguese

#### Eliminação do seu antigo aparelho

1. Quando este símbolo de latão cruzado estiver afixado a um produto, significa que o produto é abrangido pela Directiva Europeia 2002/96/EC.
2. Todos os produtos eléctricos e electrónicos devem ser eliminados separadamente do lixo doméstico através de pontos de recolha designados, facilitados pelo governo ou autoridades locais.
3. A eliminação correcta do seu aparelho antigo ajuda a evitar potenciais consequências negativas para o ambiente e para a saúde humana.
4. Para obter informações mais detalhadas acerca da eliminação do seu aparelho antigo, contacte as autoridades locais, um serviço de eliminação de resíduos ou a loja onde comprou o produto.

### Slovak

#### Likvidácia váš ho starého prístroja

1. Keď sa na produkte nachádza tento symbol prečiarknutej smetnej nádoby s kolieskami, znamená to, že daný produkt vyhovuje európskej Smernici č. 2002/96/EC.
2. Všetky elektrické a elektronické produkty by mali byť zlikvidované oddelene od komunálneho odpadu prostredníctvom na to určených zberných zariadení, ktoré boli ustanovené vládou alebo orgánmi miestnej správy.
3. Správnu likvidáciu starých zariadení pomôžete predchádzať potenciálnym negatívnym následkom pre prostredie a ľudské zdravie.
4. Podrobnejšie informácie o likvidácii starých zariadení nájdete na miestnom úrade, v službe na likvidáciu odpadu alebo u predajcu, kde ste tento produkt zakúpili.

### Czech

#### Likvidace starých spotřebičů

1. Pokud je u výrobku uveden symbol pojízdného kontejneru v přeškrtnutém poli, znamená to, že na výrobek se vztahuje směrnice Evropské unie číslo 2002/96/EC.
2. Všechny elektrické a elektronické výrobky by měly být likvidovány odděleně od běžného komunálního odpadu prostřednictvím sběrných zařízení zřízených za tímto účelem vládou nebo místní samosprávou.
3. Správný způsob likvidace starého elektrického spotřebiče pomáhá zamezit možným negativním dopadům na životní prostředí a zdraví.
4. Bližší informace o likvidaci starého spotřebiče získáte u místní samosprávy, ve sběrném zařízení nebo v obchodě, ve kterém jste výrobek zakoupili.

### Croatian

#### Uklanjanje starog aparata

1. Ako se na proizvodu nalazi simbol prekrizhene kante za smeće, to znači da je proizvod pokriven europskom direk-

tivom 2002/96/EC.

2. Električni i elektronski proizvodi ne smiju se odlagati zajedno s komunalnim otpadom, već u posebna odlagališta koja je odredila vlada ili lokalne vlasti.
3. Pravilno odlaganje starog proizvoda sprečiti će potencijalne negativne posljedice po okoliš i zdravlje ljudi.
4. Podrobnije informacije o odlaganju starog proizvoda potražite u gradskom uredu, službi za odlaganje otpada ili u trgovini u kojoj ste kupili proizvod.

### Hungarian

#### Régi eszközök ártalmatlanítása

1. A termékhez csatolt áthúzott, keresek szeméttároló jel jelöli, hogy a termék a 2002/96/EC EU-direktíva hatálya alá esik.
2. Minden elektromos és elektronikai terméket a lakossági hulladéktól elkülönítve kell begyűjteni, a kormány vagy az önkormányzatok által kijelölt begyűjtő eszközök használatával.
3. Régi eszközeinek megfelelő ártalmatlanítása segíthet megelőzni az esetleges egészségre vagy környezetre ártalmas hatásokat.
4. Ha több információra van szüksége régi eszközeinek ártalmatlanításával kapcsolatban, tanulmányozza a vonatkozó környezetvédelmi szabályokat, vagy lépjen kapcsolatba az üzlettel, ahol a terméket vásárolta.

### Polish

#### Utylizacja starych urządzeń

1. Kiedy do produktu dołączony jest niniejszy przekreślony symbol kołowego pojemnika na śmieci, oznacza to, że produkt jest objęty dyrektywą 2002/96/EC.
2. Wszystkie elektryczne i elektroniczne produkty powinny być utylizowane niezależnie od odpadów miejskich, z wykorzystaniem przeznaczonych do tego miejsc składowania wskazanych przez rząd lub miejscowe władze.
3. Właściwy sposób utylizacji starego urządzenia pomoże zapobiec potencjalnie negatywnemu wpływowi na zdrowie i środowisko.
4. Aby uzyskać więcej informacji o sposobach utylizacji starych urządzeń, należy skontaktować się z władzami lokalnymi, przedsiębiorstwem zajmującym się utylizacją odpadów lub sklepem, w którym produkt został kupiony.

## ■■■ Regulatory Information cont.

### ■ ■ ■ Estonian

#### Kasutuskõlbmatu seadme käitlemise kord

1. Kui seade on märgistatud selle elektri- ja elektroonikaseadmete lahuskogumist märgistava tähisega (ratastega prügikonteineri kujutis, millele on rist peale tõmmatud), tuleb toodet käidelda vastavalt Eurodirektiivile 2002/96/EÜ.
2. Elektri- ja elektroonikaseadmeid ei tohi visata tavalise prügi hulka. Nad kuuluvad lahuskogumisele selleks määratud kogumispunktides.
3. Kasutuskõlbmatu tervikseadme käitlemine tavaprügist lahus on korraldatud selleks, et vältida negatiivseid tagajärgi, mida põhjustaksid seadme osade purunemisel vabaneda võivad ohtlikud jäätmed loodusele või inimorganismile.
4. Täpsemat informatsiooni selle kohta, kuhu ja millal saab ära anda oma kasutamiskõlbmatu elektri- ja elektroonikaseadme, küsige kohalikult omavalitsuselt, prügifirmalt või kaupluselt, kust seadme ostsite.

### ■ ■ ■ Latvian

#### Vecās elektroierīces nodošana

1. Ja uz produkta ir simbols ar pārsvītrotu atkritumu tvertni, tas nozīmē, ka produkts ir iekļauts Eiropas direktīvā 2002/96/EC.
2. Visi elektriskie un elektroniskie produkti ir jāutilizē, nododot pašvaldības īpaši noteiktās pieņemšanas vietās. Tos nedrīkst izmest parastās municipalitātes atkritumu urnās.
3. Ievērojot prasības veco elektroierīču utilizēšanā, jūs pasargāsiet apkārtējo vidi un cilvēku veselību no iespējami nelabvēlīgajām sekām, kādas varētu rasties, ierīcēm sadaloties nepiemērotā vietā.
4. Lai gūtu plašāku informāciju par veco ierīču utilizēšanas iespējām, sazinieties ar pilsētas pašvaldību, atkritumu savākšanas saimniecību vai veikalu, kurā ierīci iegādājāties.

### ■ ■ ■ Lithuanian

#### Senos įrangos atliekų tvarkymas

1. Užbrauktas konteinerio simbolis priverčia ant prekės reiškia, kad įrangą saugo Europos direktyva 2002/96/EC.
2. Visos elektros ir elektroninės įrangos atliekos turi būti renkamos atskirai ir neišmetamos į atliekų konteinerį kartu su kitomis komunalinėmis atliekomis, taikant specialią atliekų surinkimo sistemą, patvirtintą vyriausybės ar vietos valdžios.
3. Teisingas senos įrangos atliekų tvarkymas, padės išvengti neigiamų pasekmių aplinkai ir žmonių sveikatai.
4. Dėl išsamesnės informacijos apie senos įrangos tvarkymą, prašome kreiptis į miesto valdžią, atliekų perdirbimo tarnybą arba parduotuvę, kurioje pirkote įrangą.