



**LG**

Life's Good

## OWNER'S MANUAL

# LED TV

\* LG LED TV applies LCD screen with LED backlights.

Please read this manual carefully before operating your set and retain it for future reference.

32LN5700  
39LN5700  
42LN5700  
47LN5700  
50LN5700  
55LN5700  
60LN5700

32LN570B

32LN5750  
39LN5750  
42LN5750  
47LN5750  
50LN5750  
55LN5750  
60LN5750

47LN5790  
55LN5790

# IMPORTANT SAFETY INSTRUCTIONS

Always comply with the following precautions to avoid dangerous situations and ensure peak performance of your product.





TO REDUCE THE RISK OF ELECTRIC SHOCK DO NOT REMOVE COVER (OR BACK). NO USER SERVICEABLE PARTS INSIDE. REFER TO QUALIFIED SERVICE PERSONNEL.

 The lightning flash with arrowhead symbol, within an equilateral triangle, is intended to alert the user to the presence of uninsulated "dangerous voltage" within the product's enclosure that may be of sufficient magnitude to constitute a risk of electric shock to persons.

 The exclamation point within an equilateral triangle is intended to alert the user to the presence of important operating and maintenance (servicing) instructions in the literature accompanying the appliance.

**WARNING/CAUTION**  
- TO REDUCE THE RISK OF FIRE AND ELECTRIC SHOCK, DO NOT EXPOSE THIS PRODUCT TO RAIN OR MOISTURE.

 **WARNING**  
If you ignore the warning message, you may be seriously injured or there is a possibility of accident or death.

 **CAUTION**  
If you ignore the caution message, you may be slightly injured or the product may be damaged.

 **NOTE**  
The note helps you understand and use the product safely. Please read the note carefully before using the product.

**WARNING:** This product contains chemicals known to the State of California to cause cancer and birth defects or other reproductive harm.

*Wash hands after handling.*

Read these instructions.  
Keep these instructions.  
Heed all warnings.  
Follow all instructions.



- Do not use this apparatus near water.



- Clean only with a dry cloth.



- Do not block any ventilation openings. Install in accordance with the manufacturer's instructions.



- Do not install near any heat sources such as radiators, heat registers, stoves, or other apparatus (including amplifiers) that produce heat.



- Do not defeat the safety purpose of the polarized or grounding-type plug. A polarized plug has two blades with one wider than the other. A grounding type plug has two blades and a third grounding prong. The wide blade or the third prong are provided for your safety. If the provided plug does not fit into your outlet, consult an electrician for replacement of the obsolete outlet (Can differ by country).



- Do not press strongly upon the panel with a hand or a sharp object such as a nail, pencil or pen, or make a scratch on it.



- Protect the power cord from being walked on or pinched particularly at plugs, convenience receptacles, and the point where they exit from the apparatus.



- Only use attachments/accessories specified by the manufacturer.



- Use only with a cart, stand, tripod, bracket, or table specified by the manufacturer, or sold with the apparatus. When a cart is used, use caution when moving the cart/apparatus combination to avoid injury from tip-over.



- Unplug this apparatus during lightning storms or when unused for long periods of time.

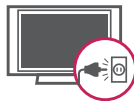

- Refer all servicing to qualified service personnel. Servicing is required when the apparatus has been damaged in any way, such as power-supply cord or plug is damaged, liquid has been spilled or objects have fallen into the apparatus, the apparatus has been exposed to rain or moisture, does not operate normally, or has been dropped.

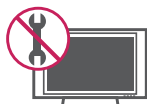

- Do not stick metal objects or any other conductive material into the power cord. Do not touch the end of the power cord while it is plugged in.
- Keep the packing anti-moisture material or vinyl packing out of the reach of children. Anti-moisture material is harmful if swallowed. If swallowed by mistake, force the patient to vomit and visit the nearest hospital. Additionally, vinyl packing can cause suffocation. Keep it out of the reach of children.

- CAUTION concerning the Power Cord (Can differ by country):

It is recommended that appliances be placed upon a dedicated circuit; that is, a single outlet circuit which powers only that appliance and has no additional outlets or branch circuits. Check the specification page of this owner's manual to be certain. Do not connect too many appliances to the same AC power outlet as this could result in fire or electric shock. Do not overload wall outlets. Overloaded wall outlets, loose or damaged wall outlets, extension cords, frayed power cords, or damaged or cracked wire insulation are dangerous. Any of these conditions could result in electric shock or fire. Periodically examine the cord of your appliance, and if its appearance indicates damage or deterioration, unplug it, discontinue use of the appliance, and have the cord replaced with an exact replacement part by an authorized service. Protect the power cord from physical or mechanical abuse, such as being twisted, kinked, pinched, closed in a door, or walked upon. Pay particular attention to plugs, wall outlets, and the point where the cord exits the appliance. Do not move the TV with the power cord plugged in. Do not use a damaged or loose power cord. Be sure do grasp the plug when unplugging the power cord. Do not pull on the power cord to unplug the TV.



- **Warning** - To reduce the risk of fire or electrical shock, do not expose this product to rain, moisture or other liquids. Do not touch the TV with wet hands. Do not install this product near flammable objects such as gasoline or candles, or expose the TV to direct air conditioning.



- Do not expose to dripping or splashing and do not place objects filled with liquids, such as vases, cups, etc. on or over the apparatus (e.g. on shelves above the unit).



• **Grounding**

(Except for devices which are not grounded.)  
 Ensure that you connect the earth ground wire to prevent possible electric shock (i.e. a TV with a three-prong grounded AC plug must be connected to a three-prong grounded AC outlet). If grounding methods are not possible, have a qualified electrician install a separate circuit breaker. Do not try to ground the unit by connecting it to telephone wires, lightning rods, or gas pipes.

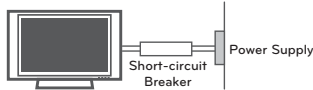

- As long as this unit is connected to the AC wall outlet, it is not disconnected from the AC power source even if the unit is turned off.
- Do not attempt to modify this product in any way without written authorization from LG Electronics. Unauthorized modification could void the user's authority to operate this product.

• **Outdoor Antenna Grounding**

(Can differ by country):  
 If an outdoor antenna is installed, follow the precautions below. An outdoor antenna system should not be located in the vicinity of overhead power lines or other electric light or power circuits, or where it can come in contact with such power lines or circuits as death or serious injury can occur. Be sure the antenna system is grounded so as to provide some protection against voltage surges and built-up static charges. Section 810 of the National Electrical Code (NEC) in the U.S.A. provides information with respect to proper grounding of the mast and supporting structure, grounding of the lead-in wire to an antenna discharge unit, size of grounding conductors, location of antenna discharge unit, connection to grounding electrodes and requirements for the grounding electrode.

**Antenna grounding according to the National Electrical Code, ANSI/NFPA 70**

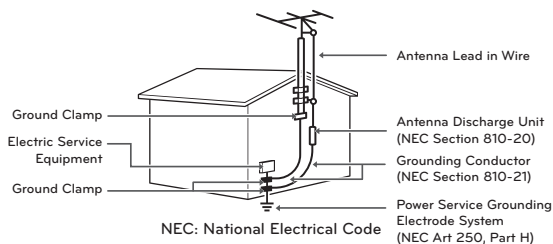

• **Cleaning**

When cleaning, unplug the power cord and wipe gently with a soft cloth to prevent scratching. Do not spray water or other liquids directly on the TV as electric shock may occur. Do not clean with chemicals such as alcohol, thinners or benzene.

• **Moving**

Make sure the product is turned off, unplugged and all cables have been removed. It may take 2 or more people to carry larger TVs. Do not press or put stress on the front panel of the TV.

• **Ventilation**

Install your TV where there is proper ventilation. Do not install in a confined space such as a bookcase. Do not cover the product with cloth or other materials while plugged. Do not install in excessively dusty places.

- If you smell smoke or other odors coming from the TV, unplug the power cord and contact an authorized service center.
- Keep the product away from direct sunlight.
- Never touch this apparatus or antenna during a thunder or lightning storm.
- When mounting a TV on the wall, make sure not to install the TV by hanging the power and signal cables on the back of the TV.
- Do not allow an impact shock or any objects to fall into the product, and do not drop anything onto the screen.
- **Disconnecting the Main Power**  
 The power outlet used with this device must remain easily accessible.
- Store the accessories (battery, etc.) in a safe location out of the reach of children.
- This apparatus use batteries. In your community there might be regulations that require you to dispose of these batteries properly due to environmental considerations. Please contact your local authorities for disposal or recycling information.
- Do not dispose of batteries in a fire.
- Do not short circuit, disassemble or allow the batteries to overheat.

• **Dot Defect**

The Plasma or LCD panel is a high technology product with resolution of two million to six million pixels. In a very few cases, you could see fine dots on the screen while you're viewing the TV. Those dots are deactivated pixels and do not affect the performance and reliability of the TV.

• **Generated Sound**

**"Cracking" noise:** A cracking noise that occurs when watching or turning off the TV is generated by plastic thermal contraction due to temperature and humidity. This noise is common for products where thermal deformation is required.

**Electrical circuit humming/panel buzzing:** A low level noise is generated from a high-speed switching circuit, which supplies a large amount of current to operate a product. It varies depending on the product.

This generated sound does not affect the performance and reliability of the product.

- Take care not to touch the ventilation openings. When watching the TV for a long period, the ventilation openings may become hot. This does not affect the performance of the product or cause defects in the product.
- If the TV feels cold to the touch, there may be a small "flicker" when it is turned on. This is normal, there is nothing wrong with TV. Some minute dot defects may be visible on the screen, appearing as tiny red, green, or blue spots. However, they have no adverse effect on the TV's performance. Avoid touching the LCD screen or holding your finger(s) against it for long periods of time. Doing so may produce some temporary distortion effects on the screen.

**Preventing "Image burn" or "Burn-in" on your TV screen**

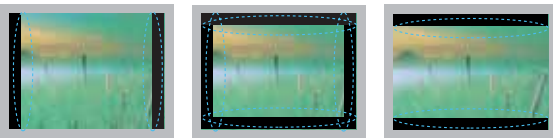

- If a fixed image displays on the TV screen for a long period of time, it will be imprinted and become a permanent disfigurement on the screen. This is "image burn" or "burn-in" and not covered by the warranty.
- If the aspect ratio of the TV is set to 4:3 for a long period of time, image burn may occur on the letterboxed area of the screen.
- Avoid displaying a fixed image on the TV screen for a long period of time (2 or more hours for LCD, 1 or more hours for the Plasma TV) to prevent image burn.

**For USA and Canada**

**FCC NOTICE**

This equipment has been tested and found to comply with the limits for a Class B digital device, pursuant to Part 15 of the FCC Rules. These limits are designed to provide reasonable protection against harmful interference in a residential installation. This equipment generates, uses and can radiate radio frequency energy and, if not installed and used in accordance with the instructions, may cause harmful interference to radio communications. However, there is no guarantee that interference will not occur in a particular installation. If this equipment does cause harmful interference to radio or television reception, which can be determined by turning the equipment off and on, the user is encouraged to try to correct the interference by one or more of the following measures:

- Reorient or relocate the receiving antenna.
- Increase the separation between the equipment and the receiver.
- Connect the equipment to an outlet on a circuit different from that to which the receiver is connected.
- Consult the dealer or an experienced radio/TV technician for help.

This device complies with part 15 of the FCC Rules. Operation is subject to the following two conditions: (1) this device may not cause harmful interference and (2) this device must accept any interference received, including interference that may cause undesired operation of the device.

Any changes or modifications in construction of this device which are not expressly approved by the party responsible for compliance could void the user's authority to operate the equipment.

**NOTE TO CABLE/TV INSTALLER**

This reminder is provided to call the CATV system installer's attention to Article 820-40 of the National Electric Code (U.S.A.). The code provides guidelines for proper grounding and, in particular, specifies that the cable ground shall be connected to the grounding system of the building, as close to the point of the cable entry as practical.

ENGLISH

## LICENSES

Supported licenses may differ by model. For more information about licenses, visit 'www.lg.com'.



Manufactured under license from Dolby Laboratories. "Dolby" and the double-D symbol are trademarks of Dolby Laboratories.



The terms HDMI and HDMI High-Definition Multimedia Interface, and the HDMI logo are trademarks or registered trademarks of HDMI Licensing LLC in the United States and other countries.



ABOUT DIVX VIDEO: DivX<sup>®</sup> is a digital video format created by DivX, LLC, a subsidiary of Rovi Corporation. This is an official DivX Certified<sup>®</sup> device that plays DivX video. Visit [divx.com](http://divx.com) for more information and software tools to convert your files into DivX video.

ABOUT DIVX VIDEO-ON-DEMAND: This DivX Certified<sup>®</sup> device must be registered in order to play purchased DivX Video-on-Demand (VOD) movies. To obtain your registration code, locate the DivX VOD section in your device setup menu. Go to [vod.divx.com](http://vod.divx.com) for more information on how to complete your registration.

"DivX Certified<sup>®</sup> to play DivX<sup>®</sup> video up to HD 1080p, including premium content."

"DivX<sup>®</sup>, DivX Certified<sup>®</sup> and associated logos are trademarks of Rovi Corporation or its subsidiaries and are used under license."

"Covered by one or more of the following U.S. patents:  
7,295,673; 7,460,668; 7,515,710; 7,519,274"



Manufactured under license under U.S. Patent Nos: 5,956,674; 5,974,380; 6,487,535 & other U.S. and worldwide patents issued & pending. DTS, the Symbol & DTS and the Symbol together are registered trademarks & DTS 2.0+Digital Out is a trademark of DTS, Inc. Product includes software. © DTS, Inc. All Rights Reserved.

ENGLISH

## OPEN SOURCE SOFTWARE NOTICE

To obtain the source code under GPL, LGPL, MPL and other open source licenses, that is contained in this product, please visit '<http://opensource.lge.com>'.

In addition to the source code, all referred license terms, warranty disclaimers and copyright notices are available for download.

LG Electronics will also provide open source code to you on CD-ROM for a charge covering the cost of performing such distribution (such as the cost of media, shipping and handling) upon email request to '[opensource@lge.com](mailto:opensource@lge.com)'. This offer is valid for three (3) years from the date on which you purchased the product.

# TABLE OF CONTENTS

<b>2</b>	<b>IMPORTANT SAFETY INSTRUCTIONS</b>	<b>28</b>	<b>REMOTE CONTROL</b>
<b>6</b>	<b>LICENSES</b>	<b>30</b>	<b>MAGIC REMOTE CONTROL FUNCTIONS</b>
<b>6</b>	<b>OPEN SOURCE SOFTWARE NOTICE</b>	31	Registering Magic Remote Control
<b>7</b>	<b>TABLE OF CONTENTS</b>	31	How to use Magic Remote Control
<b>8</b>	<b>INSTALLATION PROCEDURE</b>	31	Precautions to Take when Using the Magic Remote Control
<b>8</b>	<b>ASSEMBLING AND PREPARING</b>	<b>32</b>	<b>WATCHING TV</b>
8	Unpacking	32	Turning the TV on for the first time
10	Optional Extras	<b>33</b>	<b>USING THE USER GUIDE</b>
11	Parts and Buttons	<b>34</b>	<b>SPECIFICATIONS</b>
12	Lifting and moving the TV	<b>37</b>	<b>EXTERNAL CONTROL DEVICE SETUP</b>
13	Setting up the TV	<b>38</b>	<b>MAINTENANCE</b>
13	- Attaching the stand	38	Cleaning Your TV
14	- Mounting on a table	38	- Screen, frame, cabinet and stand
15	- Tidying cables	38	- Power cord
16	- Mounting on a wall	<b>38</b>	<b>TROUBLESHOOTING</b>
<b>17</b>	<b>MAKING CONNECTIONS</b>		
17	Connecting to an antenna or cable		
18	Connecting to a HD receiver, DVD Player, or VCR		
18	- HDMI Connection		
19	- DVI to HDMI Connection		
20	- Connecting to a mobile phone		
21	- Component Connection		
22	- Composite Connection		
23	Connecting to a PC		
23	- HDMI Connection DVI or HDMI Connection		
25	Connecting to an Audio System		
25	- Digital Optical Audio Connection		
26	Connecting to a Sound Bar		
26	- Digital Optical Audio Connection		
27	Connecting Headphones		
27	Connecting a USB Drive		

## NOTE

- Image shown may differ from your TV.
- Your TV's OSD (On Screen Display) may differ slightly from that shown in this manual.
- The available menus and options may differ from the input source or product model that you are using.
- New features may be added to this TV in the future.

## INSTALLATION PROCEDURE

- 1 Open the package and make sure all the accessories are included.
- 2 Attach the stand to the TV set.
- 3 Connect an external device to the TV set.
- 4 Make sure the network connection is available.  
You can use the TV network functions only when the network connection is made.

## ASSEMBLING AND PREPARING

### Unpacking

Check your product box for the following items. If there are any missing accessories, contact the local dealer where you purchased your product. The illustrations in this manual may differ from the actual product and item.

#### CAUTION

- Do not use any unapproved items to ensure the safety and product life span.
- Any damages or injuries by using unapproved items are not covered by the warranty.
- In case of some model, the thin film on screen is a part of TV, So don't take it off.

#### NOTE

- The items supplied with your product may vary depending on the model.
- Product specifications or contents of this manual may be changed without prior notice due to upgrade of product functions.
- For an optimal connection, HDMI cables and USB devices should have bezels less than 10 mm (0.39 inches) thick and 18 mm (0.7 inches) width.
- Use an extension cable that supports USB 2.0 if the USB cable or USB memory stick does not fit into your TV's USB port.

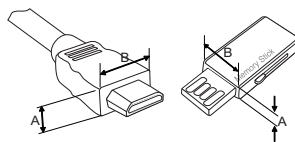

\*A ≤ 10 mm (0.39 inches)

\*B ≤ 18 mm (0.7 inches)



(For LN5700,  
LN570B, LN5790 series)

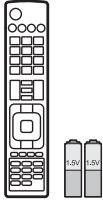

**Remote Control, Batteries (AAA)**  
(See p. 28)

(For LN5750 series)

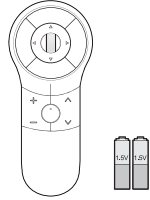

**Magic Remote Control, Batteries (AA)**  
(See p. 30)

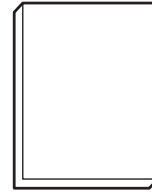

**Owner's Manual**

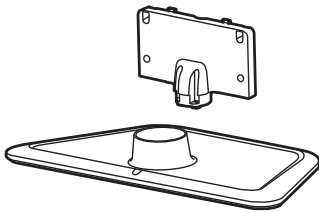

**Stand Body , Stand Base**  
(See p. 13)



**Power Cord**

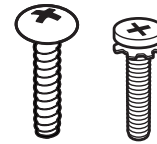

**Stand Screws**  
3 EA, P5 x 25  
4 EA, M4 x 14  
(See p. 13)

(For 32/39/42/47/50/60LN5700,  
32LN570B,  
32/39/42/47/50/60LN5750,  
47LN5790)

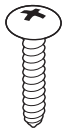

**Desk-mount Screw**  
(See p. 14)

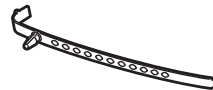

**Cable Holder**  
(See p. 15)



**Sound Bar**  
(See p. 26)

(For LN5790 series)

## Optional Extras

Optional extras can be changed or modified for quality improvement without any notification. Contact your dealer for buying these items. These devices only work with certain models. The model name or design may be changed due to the manufacturer's circumstances or policies.

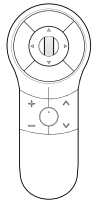

**AN-MR400**  
Magic Remote

---

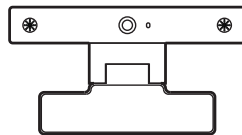

**AN-VC4\*\***  
Video Call Camera

---

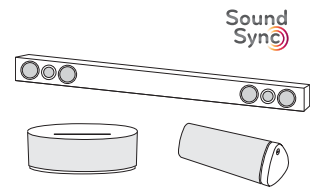

**LG Audio Device**

---



**Tag On**

---

## Parts and Buttons

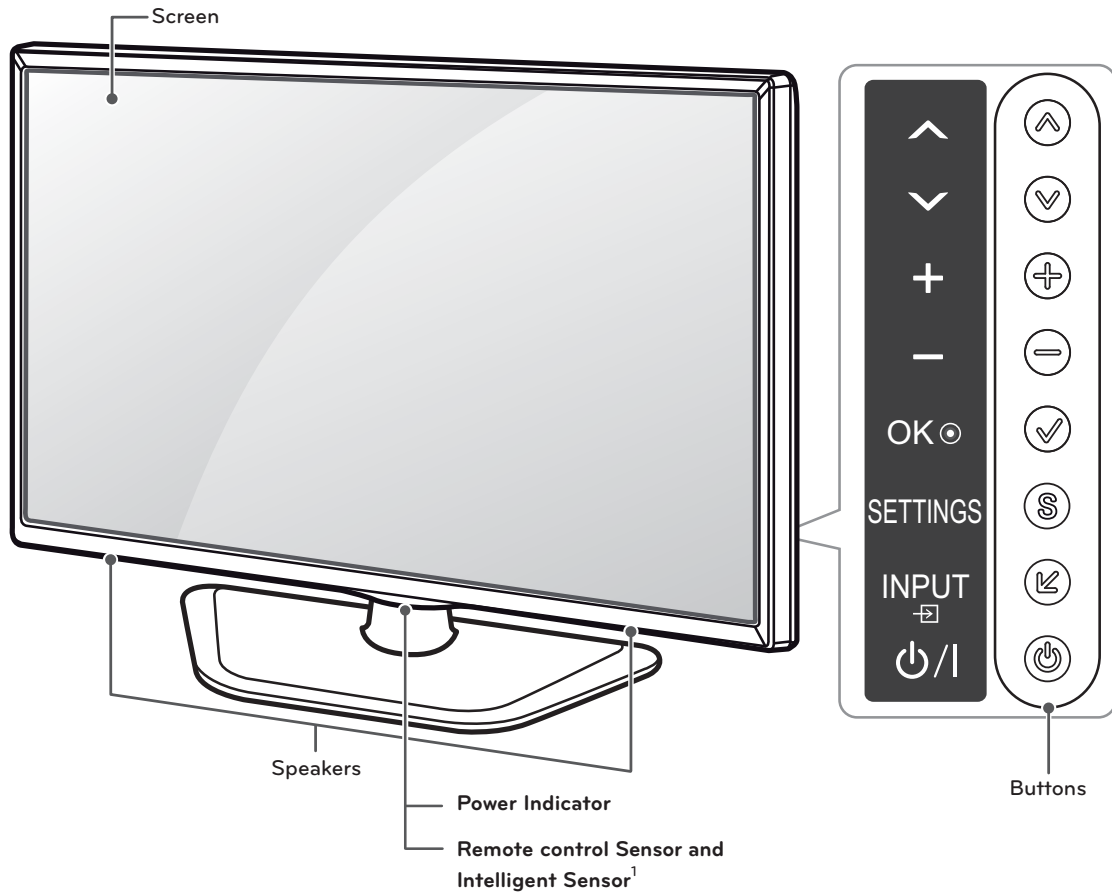

ENGLISH

Button	Description
▲ / ▼ (^ / v)	Scrolls through the saved channels.
+ / - (+ / -)	Adjusts the volume level.
✓ (OK ◉)	Selects the highlighted menu option or confirms an input.
S (SETTINGS)	Accesses the main menus, or saves your input and exits the menus.
↶ (INPUT ▢)	Changes the input source.
⏻ (⏻ /  )	Turns the power on or off.

1 Intelligent sensor - Adjusts the image quality and brightness based on the surrounding environment.

## Lifting and moving the TV

When moving or lifting the TV, read the following to prevent the TV from being scratched or damaged and for safe transportation regardless of its type and size.

### ⚠ CAUTION

- Avoid touching the screen at all times, as this may result in damage to the screen.

- It is recommended to move the TV in the box or packing material that the TV originally came in.
- Before moving or lifting the TV, disconnect the power cord and all cables.
- When holding the TV, the screen should face away from you to avoid damage.



- Hold the top and bottom of the TV frame firmly. Make sure not to hold the transparent part, speaker, or speaker grill area.

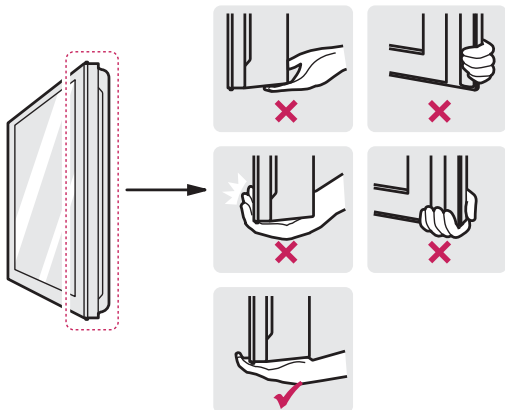

- When transporting a large TV, there should be at least 2 people.
- When transporting the TV by hand, hold the TV as shown in the following illustration.

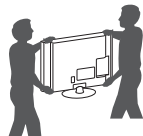

- When transporting the TV, do not expose the TV to jolts or excessive vibration.
- When transporting the TV, keep the TV upright, never turn the TV on its side or tilt towards the left or right.

## Setting up the TV

The TV can be mounted to a wall or the stand can be attached if the TV will be positioned on an entertainment center or stand.

### Attaching the stand

If you are not mounting the TV to a wall, use the following instructions to attach the stand.

**CAUTION**

- When attaching the stand to the TV set, place the screen facing down on a cushioned table or flat surface to protect the screen from scratches.
- Make sure that the screws are fastened tightly. (If they are not fastened securely enough, the TV may tilt forward after being installed.)
- Do not tighten the screws with too much force; otherwise they may be damaged and come loose later.

**NOTE**

- Remove the stand before installing the TV on a wall mount by performing the stand attachment in reverse.

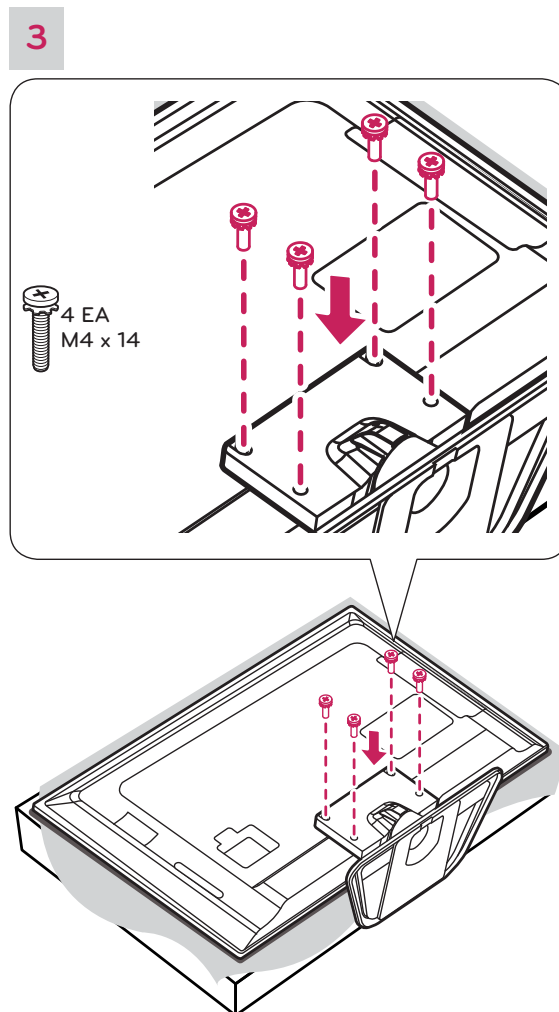
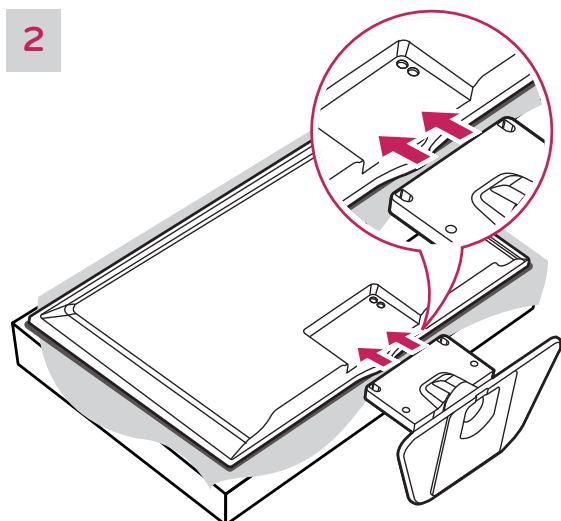
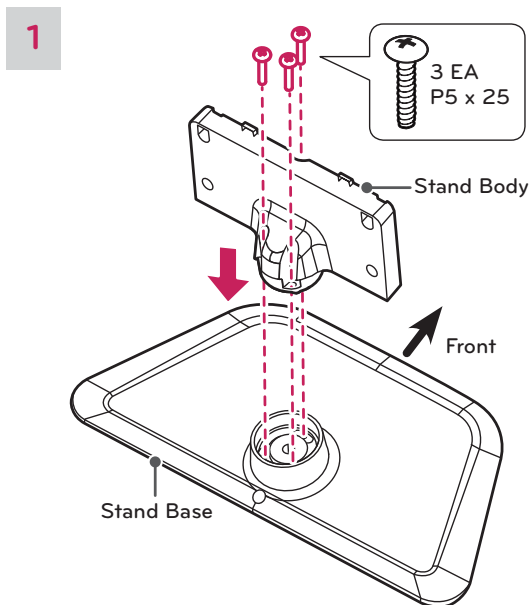

## Mounting on a table

- Lift and tilt the TV into its upright position on a table.
  - Leave a 10 cm (4 inch) (minimum) space from the wall for proper ventilation.

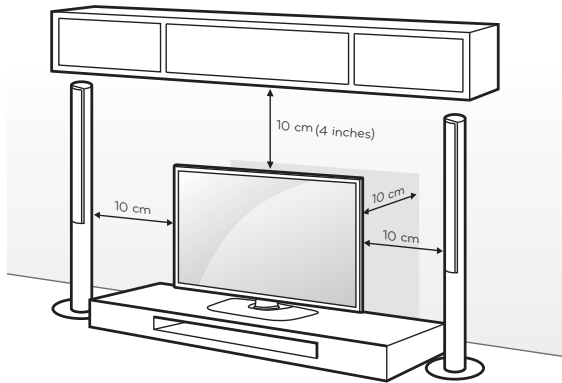

- Connect the power cord to a wall outlet.

### CAUTION

- Do not place the TV near or on sources of heat, as this may result in fire or other damage.

## Securing the TV to a table

(For 32/39/42/47/50/60LN5700, 32LN570B, 32/39/42/47/50/60LN5750, 47LN5790)

Fix the TV to a table to prevent from tilting forward, damage, and potential injury.

Mount the TV on a table, and then insert and tighten the supplied screw on the rear of the stand.

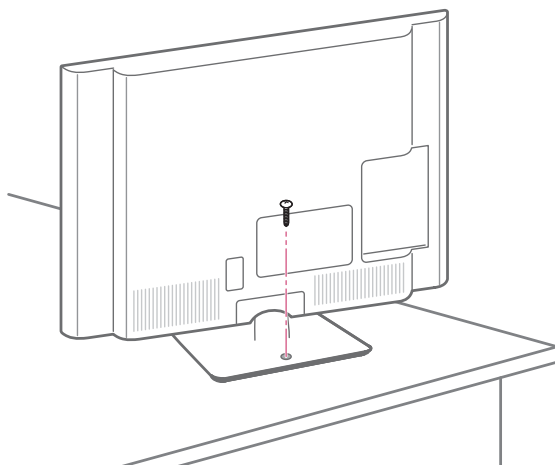

### WARNING

- To prevent TV from falling over, the TV should be securely attached to the floor/wall per installation instructions. Tipping, shaking, or rocking the TV may cause injury.

## Using the Kensington security system (optional)

(Depending on model)

The Kensington security system connector is located at the rear of the TV.

For more information of installation and using, refer to the manual provided with the Kensington security system or visit <http://www.kensington.com>.

Connect the Kensington security system cable between the TV and a table.

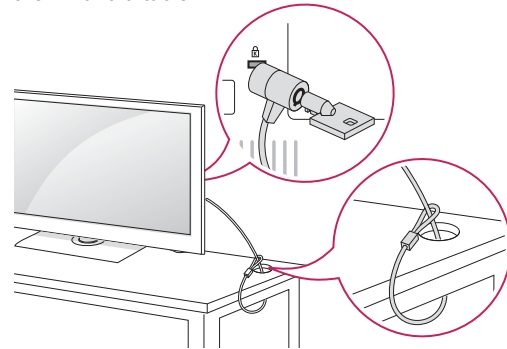

### NOTE

- The Kensington security system is optional. You can obtain additional accessories from your local dealer.

**Securing the TV to a wall (optional)**

(Depending on model)

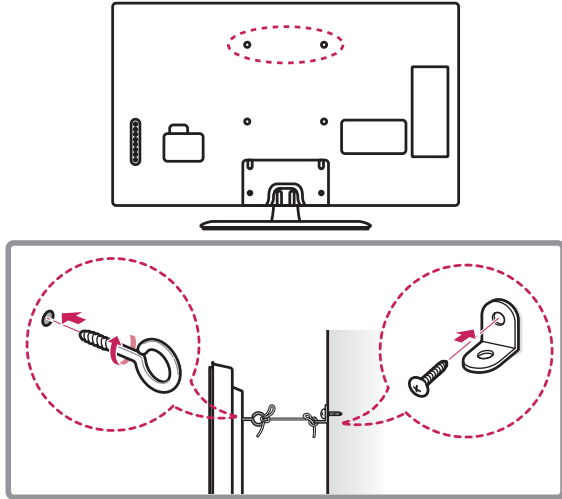

- 1 Insert and tighten the eye-bolts, or TV brackets and bolts on the back of the TV.  
- If there are bolts inserted at the eye-bolts position, remove the bolts first.
- 2 Mount the wall brackets with the bolts to the wall. Match the location of the wall bracket and the eye-bolts on the rear of the TV.
- 3 Connect the eye-bolts and wall brackets tightly with a sturdy rope. Make sure to keep the rope horizontal with the flat surface.

**CAUTION**

- Make sure that children do not climb on or hang on the TV.

**NOTE**

- Use a platform or cabinet that is strong and large enough to support the TV securely.
- Brackets, bolts and ropes are optional. You can obtain additional accessories from your local dealer.

**Tidying cables**

- 1 Gather and bind the cables with the cable holder on the back of the TV.

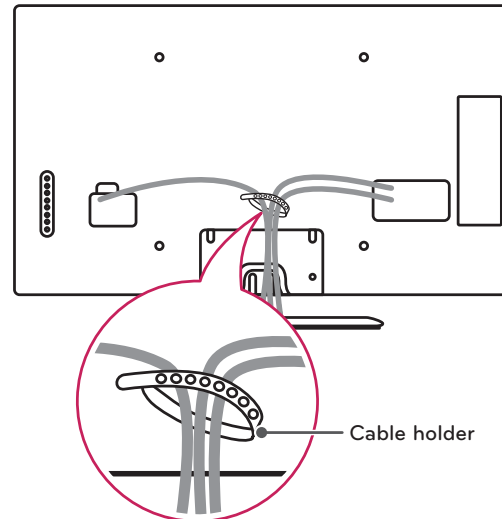
**CAUTION**



- Do not move the TV by holding the cable holder, as the cable holders may break, and injuries and damage to the TV may occur.

### Mounting on a wall

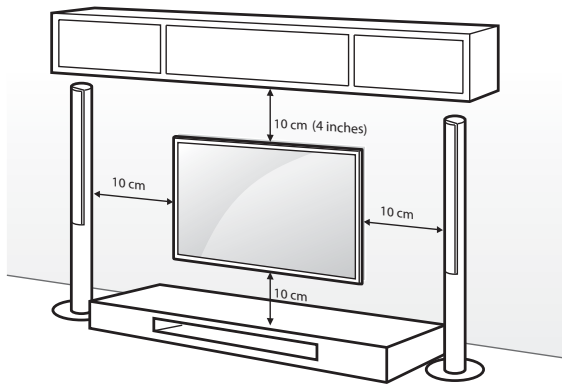
An optional wall mount can be used with your LG Television. Consult with your local dealer for a wall mount that supports the VESA standard used by your TV model. Carefully attach the wall mount bracket at the rear of the TV. Install the wall mount bracket on a solid wall perpendicular to the floor. If you are attaching the TV to other building materials, please contact qualified personnel to install the wall mount. Detailed instructions will be included with the wall mount. We recommend that you use an LG brand wall mount.

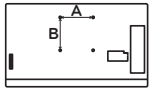
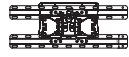

Make sure to use screws and wall mounts that meet the VESA standard. Standard dimensions for the wall mount kits are described in the following table.

<b>Model</b>	32LN5700 32LN570B 32LN5750	39/42LN5700 39/42LN5750
<b>VESA (A x B)</b>	200 x 100	200 x 200
		
<b>Standard screw</b>	M4	M6
<b>Number of screws</b>	4	4
<b>Wall mount bracket (optional)</b>	LSW130B 	LSW230B 

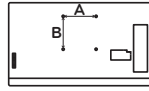
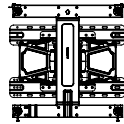
<b>Model</b>	47/50/55/60LN5700 47/50/55/60LN5750 47/55LN5790
<b>VESA (A x B)</b>	400 x 400
	
<b>Standard screw</b>	M6
<b>Number of screws</b>	4
<b>Wall mount bracket (optional)</b>	LSW430B 

**CAUTION**

- Disconnect the power before moving or installing the TV. Otherwise electric shock may occur.
- If you install the TV on a ceiling or slanted wall, it may fall and result in severe injury. Use an authorized LG wall mount and contact the local dealer or qualified personnel.
- Do not over tighten the screws as this may cause damage to the TV and void your warranty.
- Use the screws and wall mounts that meet the VESA standard. Any damages or injuries by misuse or using an improper accessory are not covered by the warranty.

**NOTE**

- Use the screws that are listed in the VESA standard screw specifications.
- The wall mount kit includes an installation manual and necessary parts.
- The wall mount bracket is optional. You can obtain additional accessories from your local dealer.
- The length of screws may differ depending on the wall mount. Make sure to use the proper length.
- For more information, refer to the manual supplied with the wall mount.



# MAKING CONNECTIONS

- This section uses illustrations of the LN5790 series.

You can connect various external devices to the TV. Supported external devices are: HD receivers, DVD players, VCRs, audio systems, USB storage devices, PC, gaming devices, and other external devices. For more information on external device's connection, refer to the manual provided with each device.

**NOTE**

- If you record a TV program on a DVD recorder or VCR, make sure to connect the TV signal input cable to the TV through a DVD recorder or VCR. For more information of recording, refer to the manual provided with the connected device.
- The external device connections shown may differ slightly from illustrations in this manual.
- Connect external devices to the TV regardless of the order of the TV port.
- If you connect a gaming device to the TV, use the cable supplied with the gaming device.
- Refer to the external equipment's manual for operating instructions.

## Connecting to an antenna or cable

Connect an antenna, cable, or cable box to watch TV while referring to the following. The illustrations may differ from the actual items and a RF cable is optional.

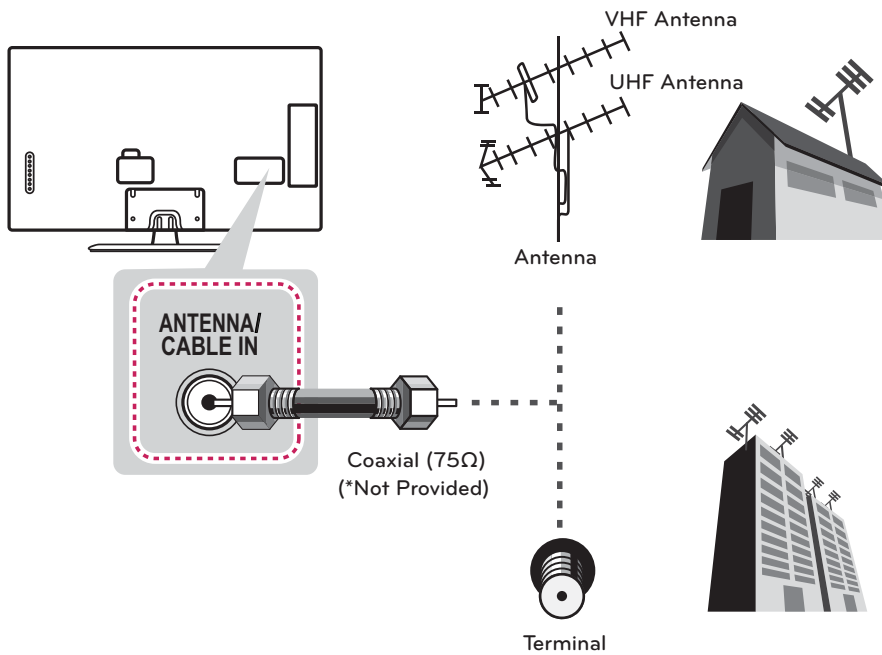

**CAUTION**

- Make sure not to bend the copper wire of the RF cable.

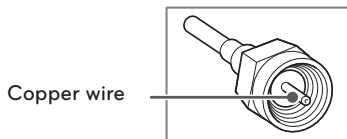

- Complete all connections between devices, and then connect the power cord to the power outlet to prevent damage to your TV.

**NOTE**

- Use a signal splitter to use more than 2 TVs.
- Visit '<http://lgknowledgebase.com>' for more information about the antenna and cable connection. Search for antenna.
- DTV Audio Supported Codec: MPEG, Dolby Digital.

## Connecting to a HD receiver, DVD Player, or VCR

Connect a HD receiver, DVD Player, or VCR to the TV and select an appropriate input mode.

### HDMI Connection

**HDMI is the best way to connect a device.**

Transmits the digital video and audio signals from an external device to the TV. Connect the external device and the TV with the HDMI cable as shown in the following illustration.



#### NOTE

- Use the latest High Speed HDMI™ Cable that supports CEC (Customer Electronics Control) function.
- High Speed HDMI™ Cables are tested to carry an HD signal up to 1080p and higher.
- HDMI Audio Supported Format: Dolby Digital, PCM (Up to 192 KHz, 32k/44.1k/48k/88k/96k/176k/192k), DTS.

Choose any HDMI input port to connect.  
It does not matter which port you use.

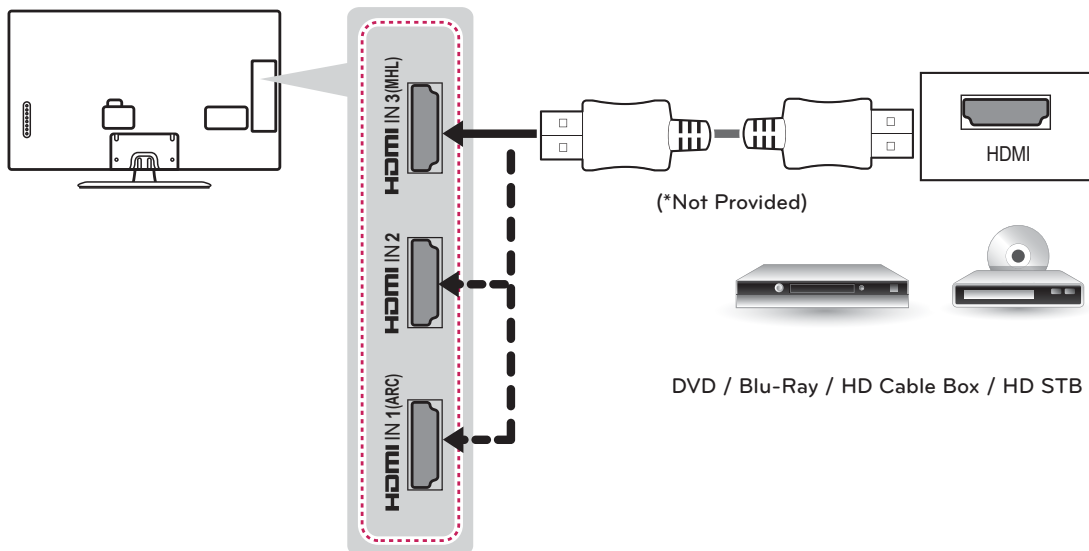

### DVI to HDMI Connection

Transmits the digital video signal from an external device to the TV. Connect the external device and the TV with the DVI-HDMI cable as shown in the following illustration. To transmit an audio signal, connect an audio cable.

**! NOTE**

- When using the HDMI/DVI cable, Single link is only supported.

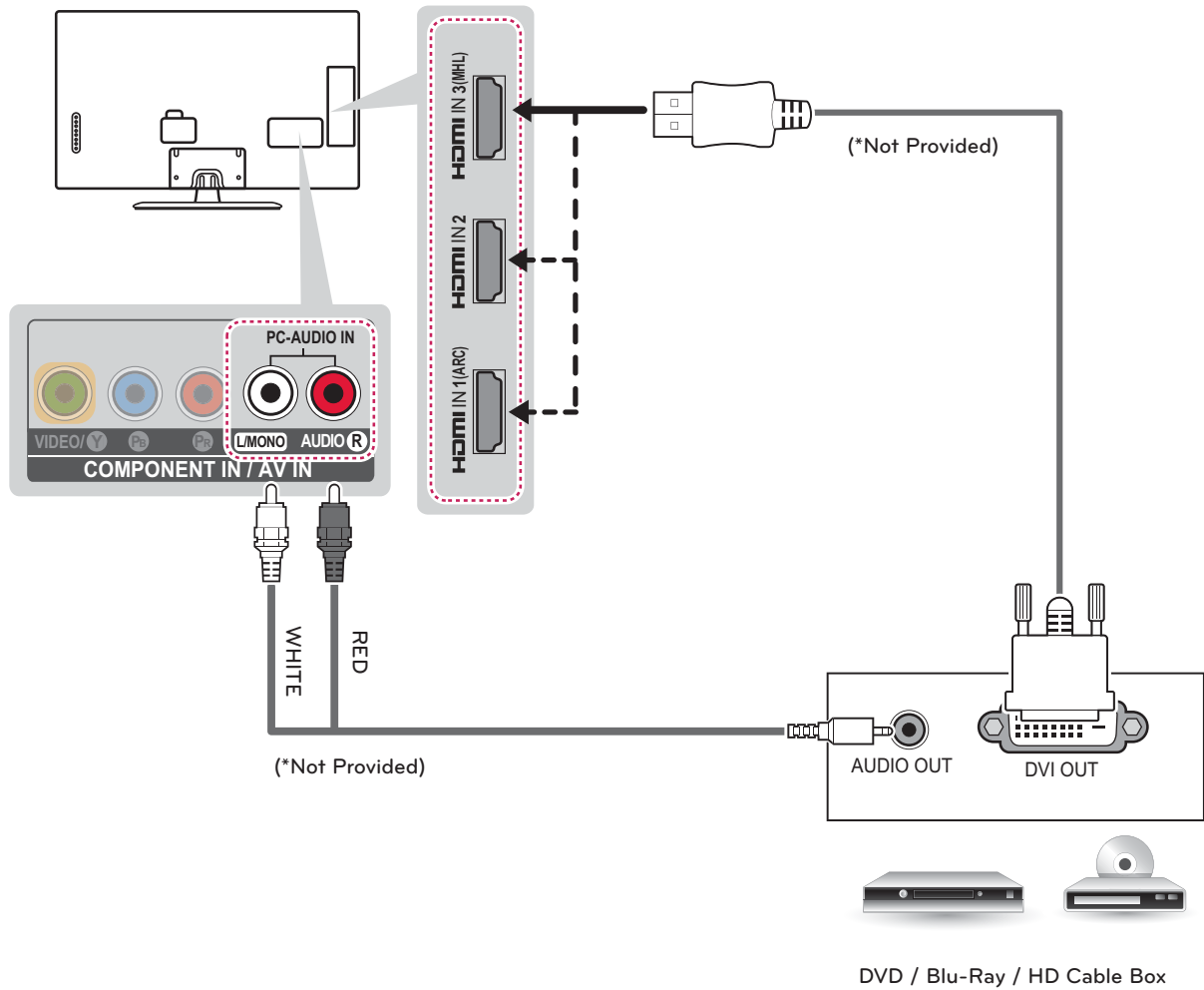

ENGLISH

DVD / Blu-Ray / HD Cable Box

## Connecting to a mobile phone

Mobile High-definition Link (MHL) is an interface for transmitting digital audiovisual signals from mobile phones to television sets.

### ! NOTE

- Connect the mobile phone to the HDMI IN 3 (MHL) port to view the phone screen on the TV.
- This only works for the MHL-enabled phone.
- With some MHL supporting mobile phones, you can use the TV remote to control the phone.
- An MHL passive cable is needed to connect the TV and a mobile phone.
- Remove the MHL cable from the TV when:
  - the MHL function is disabled.
  - your mobile device is fully charged in standby mode.

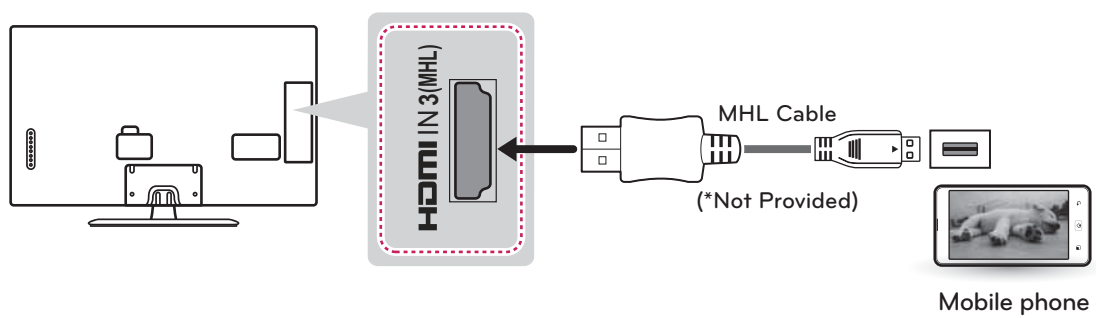

### Component Connection

Transmits analog video and audio signals from an external device to the TV. Connect the external device and the TV with a component cable as shown in the following illustration.

**NOTE**

- If cables are installed incorrectly, it could cause the image to display in black and white or with distorted color.
- **Check to ensure the cables are matched with the corresponding color connection.**

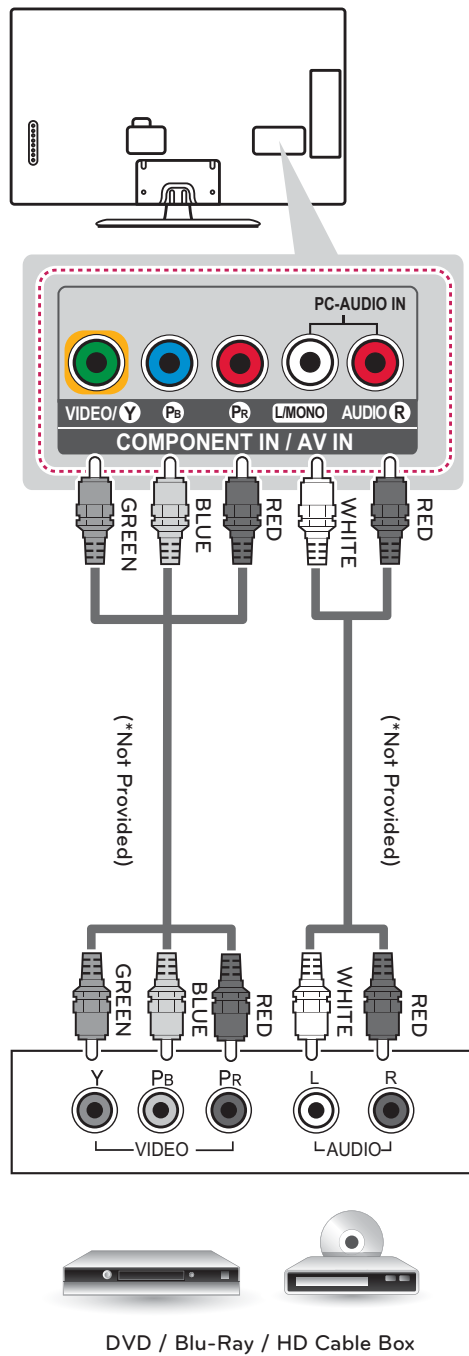

ENGLISH

### Composite Connection

Transmits analog video and audio signals from an external device to the TV. Connect the external device and the TV with the composite cable as shown in the following illustration.

**NOTE**

- Check to ensure the cables are matched with the corresponding color connection.

ENGLISH

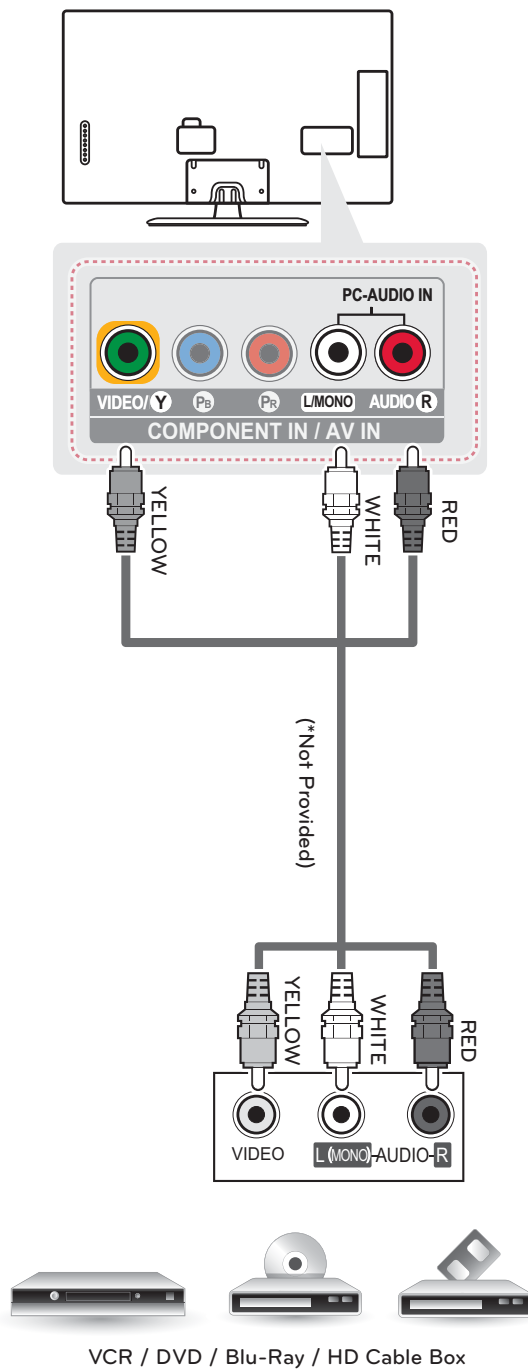

## Connecting to a PC

### ! NOTE

- It is recommended to use an HDMI connection for the best image quality.
- Depending on the graphics card, DOS mode video may not work if a HDMI to DVI Cable is in use.
- In PC mode, there may be noise associated with the resolution, vertical pattern, contrast or brightness. If noise is present, change the PC output to another resolution, change the refresh rate to another rate or adjust the brightness and contrast on the PICTURE menu until the picture is clear.
- The synchronization input form for Horizontal and Vertical frequencies is separate.
- Depending on the graphics card, some resolution settings may not allow the image to be positioned on the screen properly.
- If you are using DVI out from a PC, you have to connect analog audio separately. Refer to the instructions on the next page.
- When using the HDMI/DVI cable, Single link is only supported.

## HDMI Connection DVI or HDMI Connection

Choose method A or B to make connection.

### Method A: HDMI Connection

Choose any HDMI input port to connect.  
It does not matter which port you use.

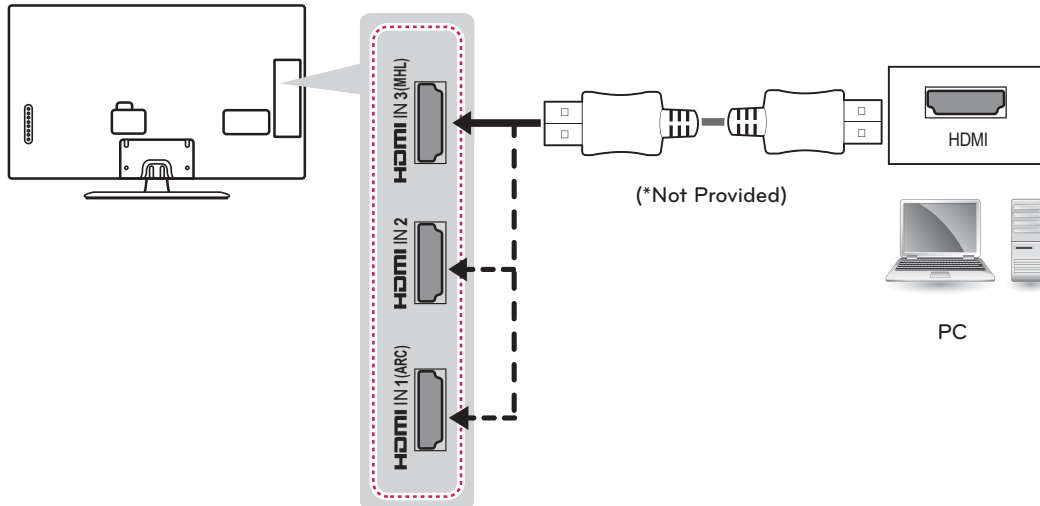

### Method B: DVI to HDMI Connection

Choose any HDMI input port to connect.  
It does not matter which port you use.

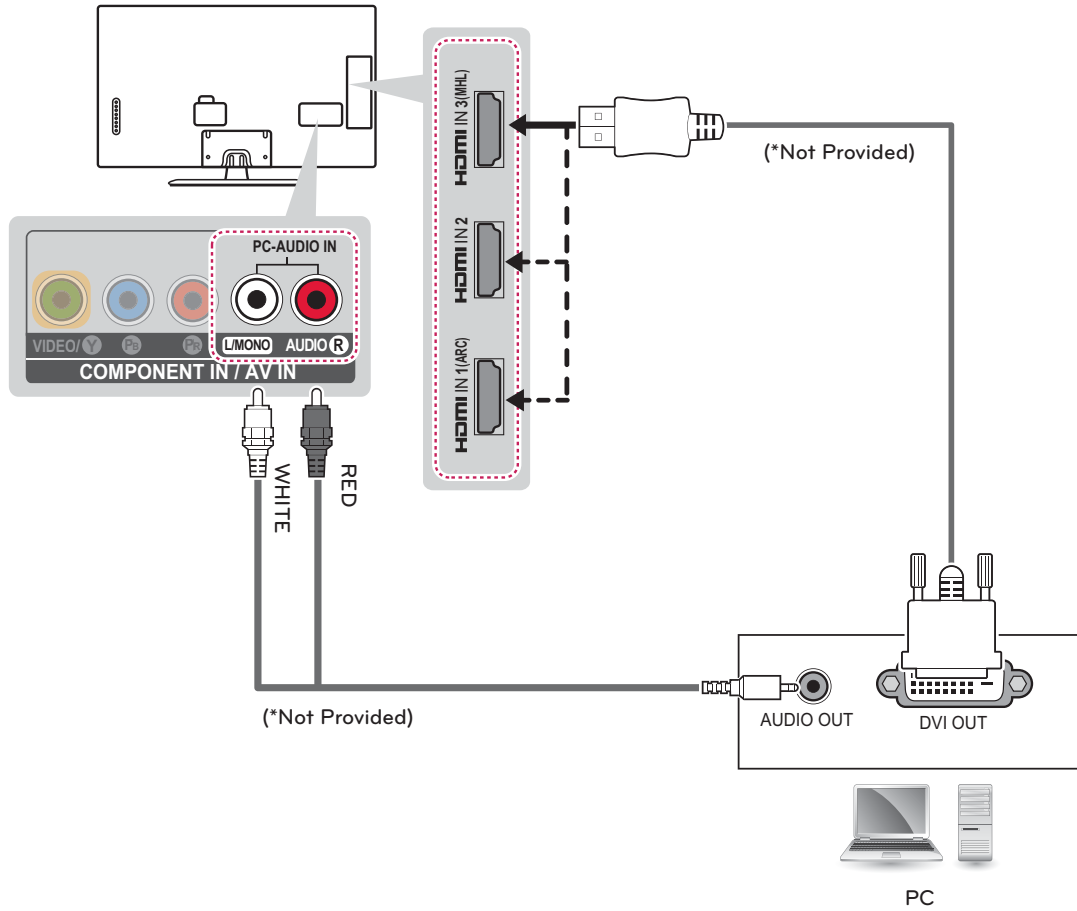

ENGLISH



## Connecting to an Audio System

You may use an optional external audio system instead of the built-in speaker.

### Digital Optical Audio Connection

Transmits a digital audio signal from the TV to an external device. Connect the external device and the TV with the optical audio cable as shown in the following illustration.

#### **!** NOTE

- Do not look into the optical output port. Looking at the laser beam may damage your vision.
- Audio with ACP (Audio Copy Protection) function may block digital audio output.

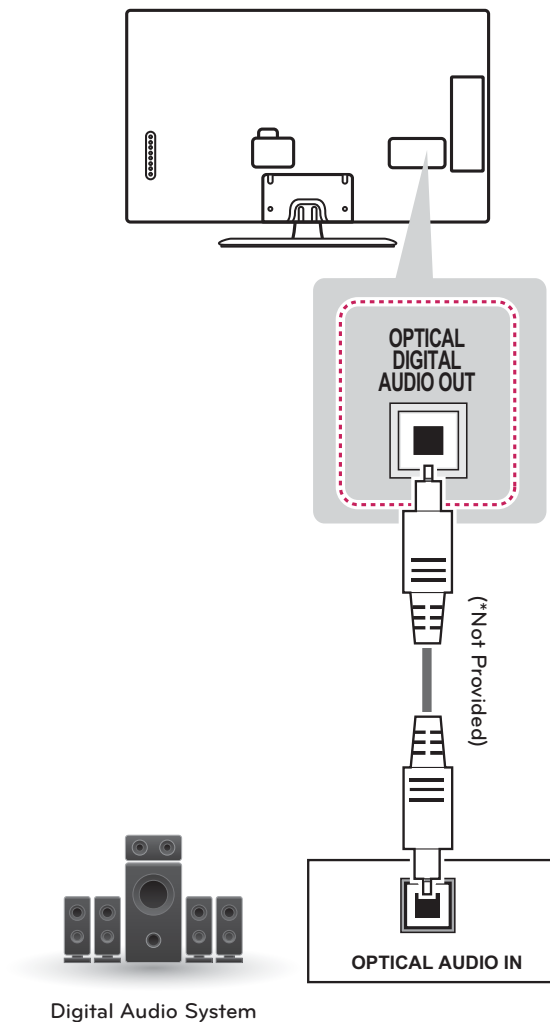

## Connecting to a Sound Bar

You may use a Sound Bar instead of the built-in speaker.

### NOTE

- If you use a Sound Bar instead of the built-in speaker, set the TV speaker to off in the user menu.

## Digital Optical Audio Connection

Transmits a digital audio signal from the TV to a Sound Bar. Connect the Sound Bar and the TV with an optical audio cable as shown in the following illustration.

For LN5790 series

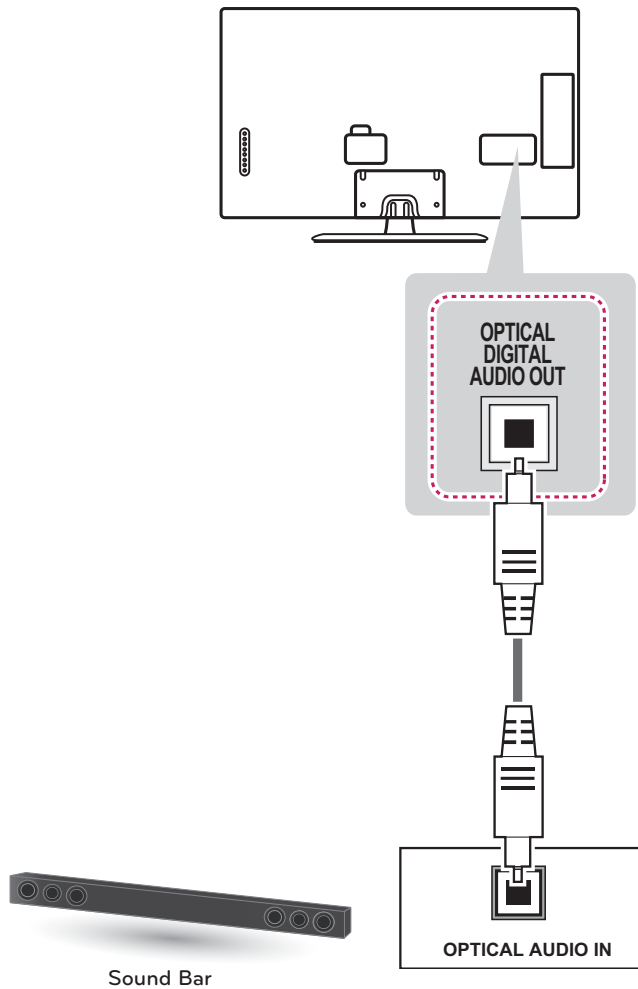

## Connecting Headphones

You listen to the sound using headphones.

**NOTE**

- AUDIO menu options are disabled when headphones are connected.
- When changing AV MODE with headphones connected, the change is applied to video but not to audio.
- Optical Digital Audio Out is not available when headphones are connected.
- Headphone impedance: 16  $\Omega$
- Max audio output: 10 mW to 15 mW
- Headphone jack size: 0.35 cm (0.13 inches)

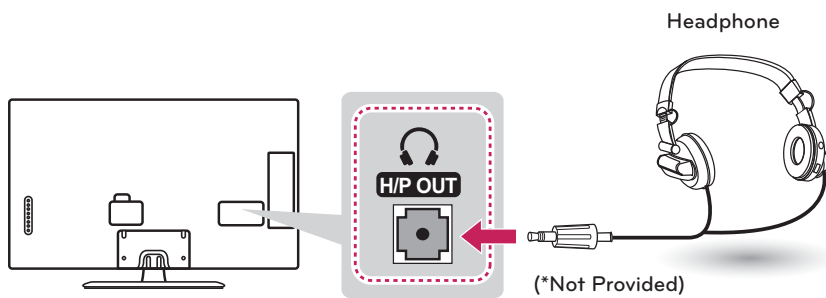

## Connecting a USB Drive

Connect a USB storage device such as a USB flash thumbdrive, external hard drive, or a USB memory card reader to the TV and access the Smart Share menu to use various multimedia files.

**NOTE**

- Some USB Hubs may not work. If a USB device connected using a USB Hub is not detected, connect it to the USB port on the TV directly.

Choose any USB input port to connect.  
It does not matter which port you use.

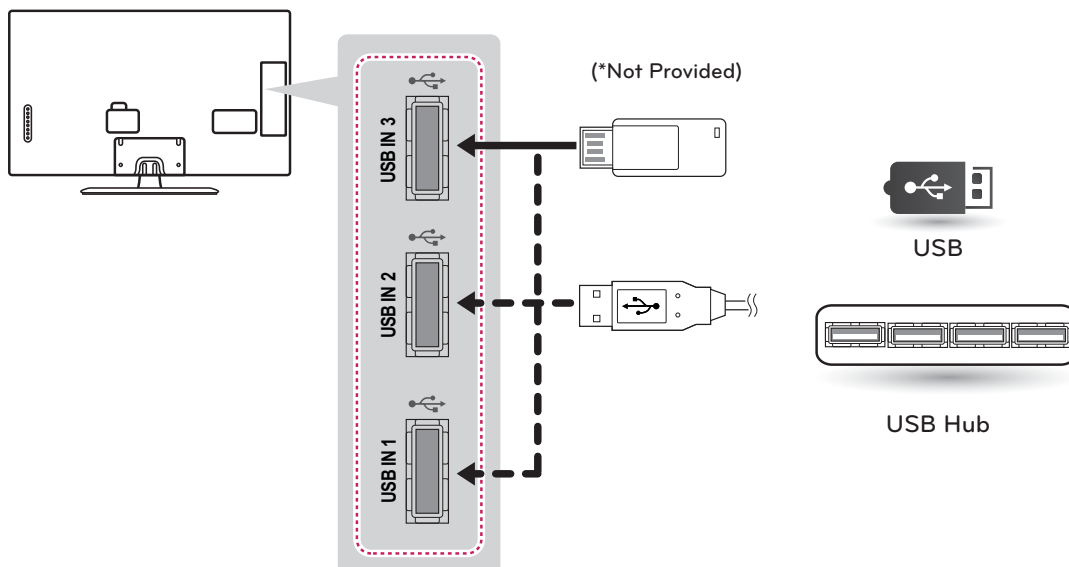

# REMOTE CONTROL

The descriptions in this manual are based on the buttons on the remote control. Please read this manual carefully and use the TV correctly. To install batteries (1.5 V AAA) matching the ⊕ and ⊖ ends to the label inside the compartment, and close the battery cover. To remove the batteries, perform the installation actions in reverse.

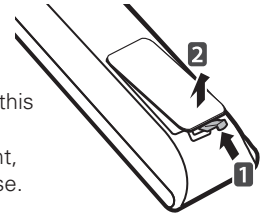

**CAUTION**

- Do not mix old and new batteries, as this may damage the remote control.

This remote uses infrared light. When in use, it should be pointed in the direction of the TV's remote sensor.

For LN5700, LN570B, LN5790 series

ENGLISH

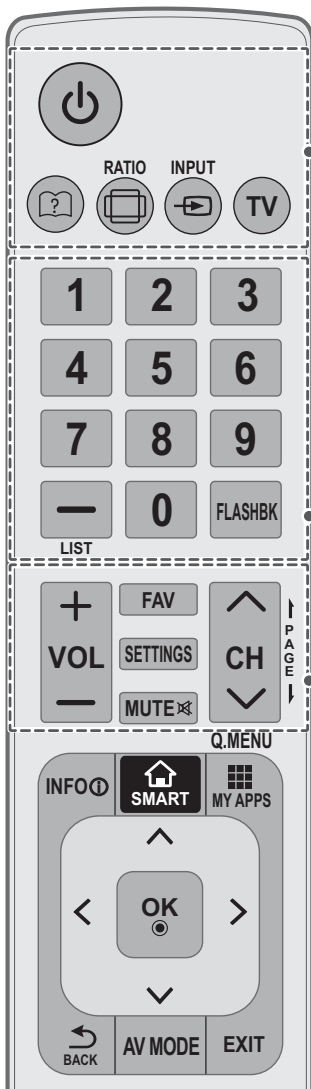

**⏻ (POWER)**  
Turns the TV on or off.

**📖 (User Guide)**  
Sees user-guide.

**📐 RATIO**  
Resizes an image.

**📺 INPUT**  
Rotates through inputs.  
Also switches the TV on from standby.

**TV**  
Returns to the last TV channel.

**Number button**  
Enters numbers.

**LIST**  
Accesses the saved channel list.

**- (Dash)**  
Inserts a dash between numbers such as 2-1 and 2-2.

**FLASHBK**  
Tunes to the last channel viewed.

**+ VOL -**  
Adjusts the volume level.

**FAV**  
Accesses your favorite channel list.

**SETTINGS**  
Accesses the main menu.

**MUTE**   
Mutes all sounds.

**^ CH v**  
Scrolls through the saved channels.

**↑ PAGE ↓**  
Moves to the previous or next screen.

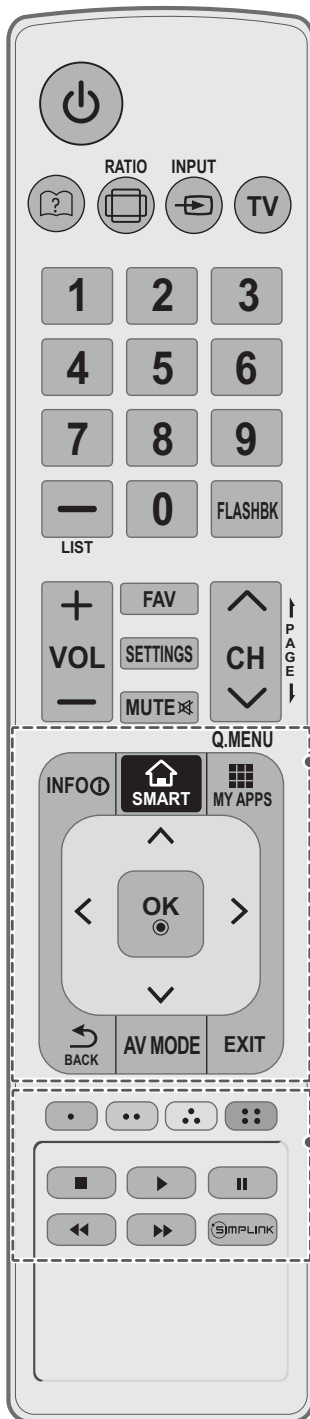

**INFO** ⓘ

Shows information on the current program.

**SMART** 🏠

Accesses the Smart Home menu.

**MY APPS** 📺

Shows the list of Apps.

**.MENU** ●

Accesses the quick menu.

**Navigation buttons** (up/down/left/right)

Scrolls through menus or options.

**OK** Ⓞ

Selects menus or options and confirms your input.

**BACK** ↶

Returns to the previous level.

**AV MODE**

Selects an AV mode.

**EXIT**

Clears all on-screen displays and returns to TV viewing.

**Color buttons**

These access special functions in some menus.

● : Red, ●● : Green, ●● : Yellow, ●● : Blue

**Control buttons** (■, ▶, ||, ◀◀, ▶▶)

Controls the SIMPLINK compatible devices (USB, SIMPLINK).

**SIMPLINK** Ⓢ

Accesses the AV devices connected to the TV;  
Opens the SIMPLINK menu.

## MAGIC REMOTE CONTROL FUNCTIONS

When the message "Magic remote control battery is low. Change the battery." is displayed, replace the battery. To install batteries, open the battery cover, replace batteries (1.5 V AA) matching ⊕ and ⊖ ends to the label inside the compartment, and close the battery cover. Be sure to point the remote control at the remote control sensor on the TV. To remove the batteries, perform the installation actions in reverse.

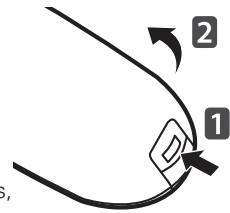

**CAUTION**

- Do not mix old and new batteries, as this may damage the remote control.

This remote uses infrared light. When in use, it should be pointed in the direction of the TV's remote sensor.

For LN5750 series

ENGLISH

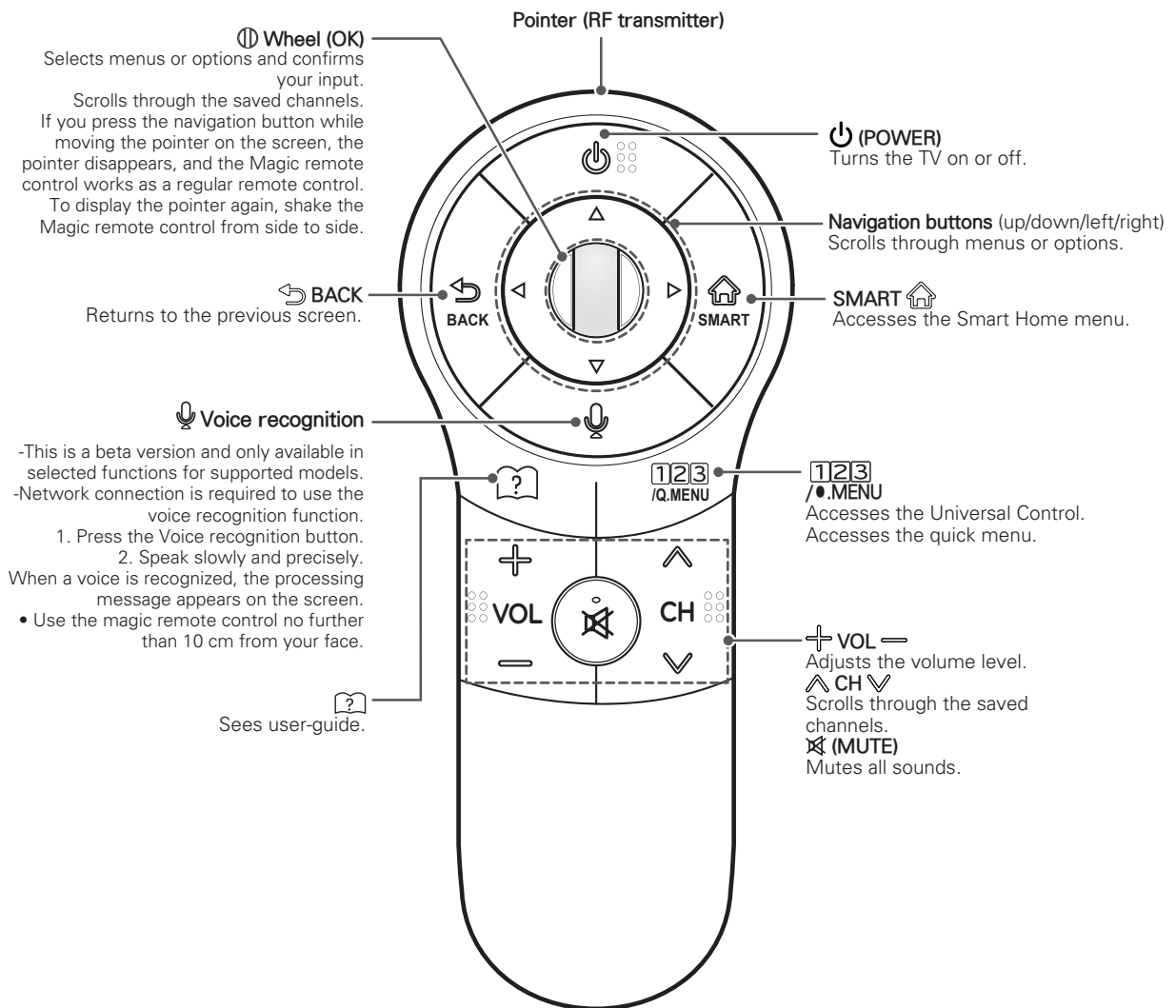



## Registering Magic Remote Control

The Magic Remote Control operates by pairing with your TV.

### How to register the Magic Remote Control

 <b>(Wheel)</b>	<p>To register automatically, turn the TV on and press the <b>Wheel (OK)</b>. When registration is completed, the completion message appears on the screen.</p> <p>If registration fails, turn the TV off and back on, then press the <b>Wheel (OK)</b> to complete registration.</p>
-----------------------------------------------------------------------------------------------------	---------------------------------------------------------------------------------------------------------------------------------------------------------------------------------------------------------------------------------------------------------------------------------------

### How to Re-register the Magic Remote Control

 <b>BACK</b>   <b>SMART</b>	<p>1 Press and hold the <b>BACK</b> and <b>SMART</b> buttons together for 5 seconds to reset, then register it by following "How to register the Magic remote control" above.</p> <p>2 To re-register the Magic remote control, press and hold the <b>BACK</b> button for 5 seconds toward the TV.</p>
-----------------------------------------------------------------------------------------------------------------------------------------------------------------------------------------------------------	--------------------------------------------------------------------------------------------------------------------------------------------------------------------------------------------------------------------------------------------------------------------------------------------------------

## How to use Magic Remote Control

	<p>1 You can move the pointer by moving the remote up and down or left and right.</p> <ul style="list-style-type: none"> <li>» If the pointer does not work properly, wait 10 seconds and then try again.</li> </ul> <p>2 If the pointer disappears, move the remote control slightly to left or right. It will then automatically appear on the screen.</p> <ul style="list-style-type: none"> <li>» If the pointer has not been used for a certain period of time, it will disappear.</li> </ul>
-------------------------------------------------------------------------------------	----------------------------------------------------------------------------------------------------------------------------------------------------------------------------------------------------------------------------------------------------------------------------------------------------------------------------------------------------------------------------------------------------------------------------------------------------------------------------------------------------

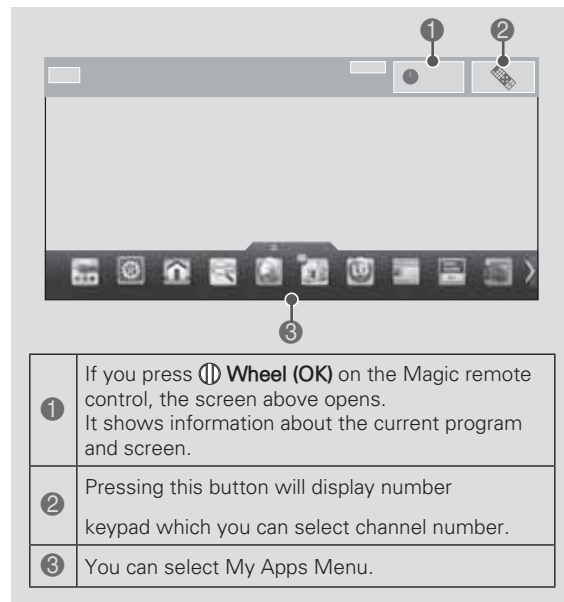

## Precautions to Take when Using the Magic Remote Control

- Use the Magic remote control within the maximum communication distance (10 m, 32.8ft). Using the remote control beyond this distance, or with an object obstructing it, may cause a communication failure.
- A communication failure may occur due to nearby devices. Electrical devices such as a microwave oven or wireless LAN product may cause interference, as these use the same bandwidth (2.4 GHz) as the Magic remote control.
- The Magic remote control may be damaged or may malfunction if it is dropped or receives a heavy impact.
- Take care not to bump into nearby furniture or other people when using the Magic remote control.
- Manufacturer and installer cannot provide service related to human safety as the applicable wireless device has possibility of electric wave interference.
- It is recommended that an Access Point (AP) be located more than 1 m (3.28 ft) away from the TV. If the AP is installed closer than 1 m (3.28 ft), the Magic remote control may not perform as expected due to frequency interference.

## WATCHING TV

### Turning the TV on for the first time

When you turn the TV on for the first time, the Initial setting screen appears. Select a language and customize the basic settings.

- 1 Connect the power cord to a power outlet.
- 2 In Standby mode, press the power button on the remote control to turn the TV on. The Initial setting screen appears if you turn the TV on for the first time.

#### NOTE

- You can also access **Initial Setting** by accessing **OPTION** in the main menu.

- 3 Follow the on-screen instructions to customize your TV settings according to your preferences.

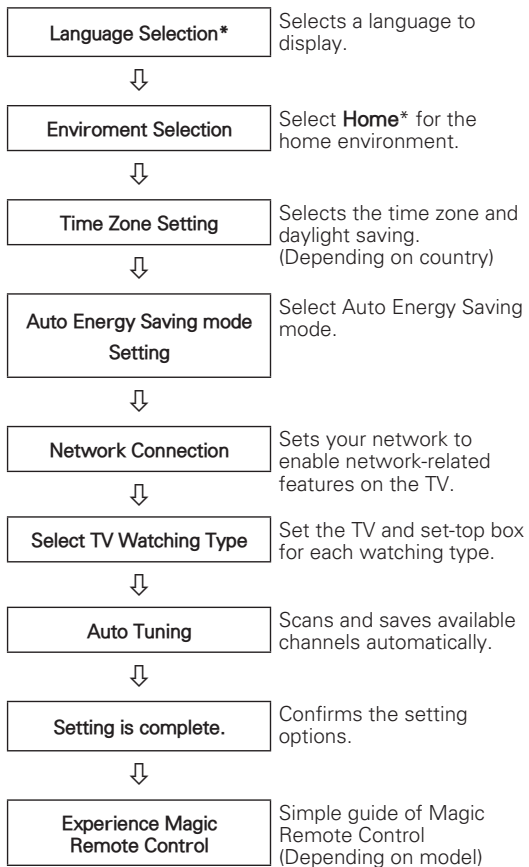

#### NOTE

- Select **Home\*** when prompted. **Store\*** mode puts the TV in demo mode.
- If you select **Store\***, the any customized settings will switch back to the default settings of **Store\*** in 5 minutes.
- The Standby light feature is disabled in Store Demo mode.

- 4 When the basic settings are complete, press the **OK** button.

#### NOTE

- If you do not complete the Initial setting, it will appear whenever the TV turns on.
- Disconnect the power cord from the power outlet when you do not use the TV for a long period of time.

- 5 To turn the TV off, press the power button on the remote control.



## USING THE USER GUIDE

User Guide allows you to easily access detailed TV information.

- 1 Press **SMART**  button to access the Smart Home menu.
- 2 Select **User Guide** and press the **OK** button.

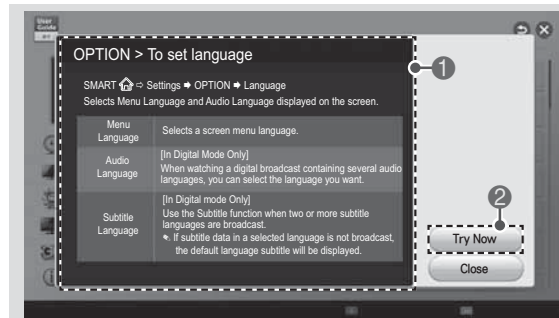
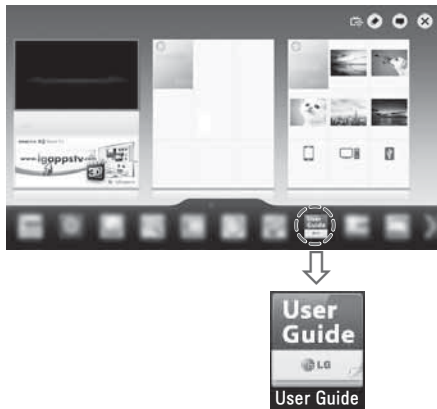

- |   |                                                                                                  |
|---|--------------------------------------------------------------------------------------------------|
| 1 | Shows the description of the selected menu. You can use $\wedge$ / $\vee$ to move between pages. |
| 2 | Moves to the selected menu directly from the User Guide.                                         |

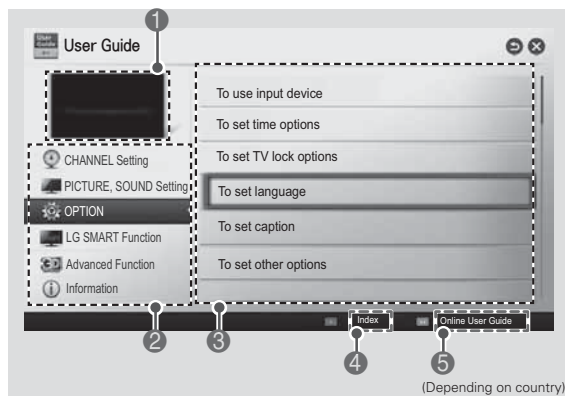

(Depending on country)

- |   |                                                                                                                                                                 |
|---|-----------------------------------------------------------------------------------------------------------------------------------------------------------------|
| 1 | Shows the video you were watching.                                                                                                                              |
| 2 | Guide categories.                                                                                                                                               |
| 3 | List of topics in the current category.<br>You can use $\wedge$ / $\vee$ button to move between pages.                                                          |
| 4 | An index of key words present in the User Guide.                                                                                                                |
| 5 | Provides the detailed information on the functions of LG Smart TV when the Internet is connected. (It may not be available depending on the country/ language.) |

# SPECIFICATIONS

Product specifications may be changed without prior notice due to upgrade of product functions.

<b>Power requirement</b>		AC 100 - 240 V ~ 50 / 60 Hz
<b>Television System</b>		ATSC / NTSC-M, 64 & 256 QAM
<b>Program Coverage</b>		VHF 2-13, UHF 14-69, CATV 1-135, DTV 2-69, CADTV 1-135
<b>External Antenna Impedance</b>		75 Ω
<b>Environment condition</b>	Operating Temperature	0 - 40 °C
	Operating Humidity	Less than 80 %
	Storage Temperature	-20 - 60 °C
	Storage Humidity	Less than 85 %

MODELS		32LN5700 (32LN5700-UH)	39LN5700 (39LN5700-UH)
		32LN570B (32LN570B-UH)	
Dimensions (Width x Height x Depth)	With stand	738 x 497 x 207 (mm)	894 x 587 x 236 (mm)
		29.0 x 19.5 x 8.1 (inch)	35.1 x 23.1 x 9.2 (inch)
	Without stand	738 x 449 x 79 (mm)	894 x 537 x 79 (mm)
		29.0 x 17.6 x 3.1 (inch)	35.1 x 21.1 x 3.1 (inch)
Weight	With stand	7.0 kg (15.4 lbs)	9.7 kg (21.3 lbs)
	Without stand	6.4 kg (14.1 lbs)	8.6 kg (18.9 lbs)
Current Value / Power consumption		1.3 A / 80 W	1.5 A / 100 W

MODELS		42LN5700 (42LN5700-UH)	47LN5700 (47LN5700-UH)
			47LN5790 (47LN5790-UI)
Dimensions (Width x Height x Depth)	With stand	968 x 629 x 236 (mm)	1,080 x 694 x 264 (mm)
		38.1 x 24.7 x 9.2 (inch)	42.5 x 27.3 x 10.3 (inch)
	Without stand	968 x 579 x 79 (mm)	1,080 x 642 x 80.5 (mm)
		38.1 x 22.7 x 3.1 (inch)	42.5 x 25.2 x 3.1 (inch)
Weight	With stand	10.7 kg (23.5 lbs)	14.5 kg (31.9 lbs)
	Without stand	9.6 kg (21.1 lbs)	13.1 kg (28.8 lbs)
Current Value / Power consumption		1.1 A / 110 W	1.3 A / 130 W

MODELS		50LN5700 (50LN5700-UH)	55LN5700 (55LN5700-UH)
			55LN5790 (55LN5790-UI)
Dimensions (Width x Height x Depth)	With stand	1,136 x 727 x 264 (mm)	1,250 x 790 x 297 (mm)
		44.7 x 28.6 x 10.3 (inch)	49.2 x 31.1 x 11.6 (inch)
	Without stand	1,136 x 673 x 82.1 (mm)	1,250 x 737 x 79.1 (mm)
		44.7 x 26.4 x 3.2 (inch)	49.2 x 29.0 x 3.1 (inch)
Weight	With stand	15.6 kg (34.3 lbs)	21.2 kg (46.7 lbs)
	Without stand	14.2 kg (31.3 lbs)	19.1 kg (42.1 lbs)
Current Value / Power consumption		1.4 A / 140 W	1.6 A / 160 W



MODELS		60LN5700 (60LN5700-UA)
Dimensions (Width x Height x Depth)	With stand	1,359 x 852 x 297 (mm)
		53.5 x 33.5 x 11.6 (inch)
	Without stand	1,359 x 799 x 67.2 (mm)
		53.5 x 31.4 x 2.6 (inch)
Weight	With stand	26.3 Kg (57.9 lbs)
	Without stand	24.2 Kg (53.3 lbs)
Current Value / Power consumption		2.0 A / 200 W

MODELS		32LN5750 (32LN5750-UH)	39LN5750 (39LN5750-UH)
Dimensions (Width x Height x Depth)	With stand	738 x 497 x 207 (mm)	894 x 587 x 236 (mm)
		29.0 x 19.5 x 8.1 (inch)	35.1 x 23.1 x 9.2 (inch)
	Without stand	738 x 449 x 79 (mm)	894 x 537 x 79 (mm)
		29.0 x 17.6 x 3.1 (inch)	35.1 x 21.1 x 3.1 (inch)
Weight	With stand	7.0 kg (15.4 lbs)	9.7 kg (21.3 lbs)
	Without stand	6.4 kg (14.1 lbs)	8.6 kg (18.9 lbs)
Current Value / Power consumption		1.3 A / 80 W	1.5 A / 100 W

MODELS		42LN5750 (42LN5750-UH)	47LN5750 (47LN5750-UH)
Dimensions (Width x Height x Depth)	With stand	968 x 629 x 236 (mm)	1,080 x 694 x 264 (mm)
		38.1 x 24.7 x 9.2 (inch)	42.5 x 27.3 x 10.3 (inch)
	Without stand	968 x 579 x 79 (mm)	1,080 x 642 x 80.5 (mm)
		38.1 x 22.7 x 3.1 (inch)	42.5 x 25.2 x 3.1 (inch)
Weight	With stand	10.7 kg (23.5 lbs)	14.5 kg (31.9 lbs)
	Without stand	9.6 kg (21.1 lbs)	13.1 kg (28.8 lbs)
Current Value / Power consumption		1.1 A / 110 W	1.3 A / 130 W

MODELS		50LN5750 (50LN5750-UH)	55LN5750 (55LN5750-UH)
Dimensions (Width x Height x Depth)	With stand	1,136 x 727 x 264 (mm)	1,250 x 790 x 297 (mm)
		44.7 x 28.6 x 10.3 (inch)	49.2 x 31.1 x 11.6 (inch)
	Without stand	1,136 x 673 x 82.1 (mm)	1,250 x 737 x 79.1 (mm)
		44.7 x 26.4 x 3.2 (inch)	49.2 x 29.0 x 3.1 (inch)
Weight	With stand	15.6 kg (34.3 lbs)	21.2 kg (46.7 lbs)
	Without stand	14.2 kg (31.3 lbs)	19.1 kg (42.1 lbs)
Current Value / Power consumption		1.4 A / 140 W	1.6 A / 160 W

MODELS		60LN5750 (60LN5750-UA)
Dimensions (Width x Height x Depth)	With stand	1,359 x 852 x 297 (mm)
		53.5 x 33.5 x 11.6 (inch)
	Without stand	1,359 x 799 x 67.2 (mm)
		53.5 x 31.4 x 2.6 (inch)
Weight	With stand	26.3 Kg (57.9 lbs)
	Without stand	24.2 Kg (53.3 lbs)
Current Value / Power consumption		2.0 A / 200 W

**HDMI (DTV) supported mode**

Resolution	Horizontal Frequency (kHz)	Vertical Frequency (Hz)
720x480	31.469 31.50	59.94 60.00
1280x720	44.96 45.00	59.94 60.00
1920x1080	33.72 33.75 26.97 27.000 33.716 33.75 67.43 67.500	59.94 60.00 23.97 24.000 29.976 30.00 59.94 60

**Component port connecting information**

Component ports on the TV	Y	PB	PR
Video output ports on DVD player	Y	PB	PR
	Y	B-Y	R-Y
	Y	Cb	Cr
	Y	Pb	Pr

**Component supported mode**

Resolution	Horizontal Frequency (kHz)	Vertical Frequency (Hz)
720x480i	15.73	59.94
	15.73	60.00
720x480p	31.47	59.94
	31.50	60
1280x720p	44.96	59.94
	45.00	60.00
1920x1080i	33.72	59.94
	33.75	60.00
1920x1080p	26.97	23.976
	27.00	24.00
	33.71	29.97
	33.75	30.00
	67.432	59.94
	67.500	60.00

**HDMI (PC) supported mode**

Resolution	Horizontal Frequency (kHz)	Vertical Frequency (Hz)
640x480	31.469	59.94
800x600	37.879	60.31
1024x768	48.363	60.00
1152x864	54.348	60.053
1360x768	47.712	60.015
1280x1024	63.981	60.020
1920x1080	67.5	60.00

**Wireless LAN module (WN8122E1) specification**

<b>Standard</b>	IEEE802.11a/b/g/n
<b>Frequency Range</b>	2400 to 2483.5 MHz 5150 to 5250 MHz 5725 to 5850 MHz
<b>Output Power (Max.)</b>	802.11a: 16.5 dBm 802.11b: 16 dBm 802.11g: 15.5 dBm 802.11n - 2.4GHz: 15.5 dBm 802.11n - 5GHz: 16.5 dBm

- Because band channel used by the country could be different, the user can not change or adjust the operating frequency and this product is set for the regional frequency table.
- Contains FCC ID: BEJWN8122E1  
Contains IC: 2703H-WN8122E1

**Bluetooth module (BM-LDS401) specification**

(For LN5750 series)

<b>Standard</b>	Bluetooth Version 3.0
<b>Frequency Range</b>	2400 ~ 2483.5 MHz
<b>Output Power (Max.)</b>	10 dBm or lower

- Contains FCC ID: BEJLDS401  
Contains IC: 2703H-LDS401

ENGLISH

## EXTERNAL CONTROL DEVICE SETUP

To obtain the external control device setup information, please visit '[www.lg.com](http://www.lg.com)'.

## MAINTENANCE

### Cleaning Your TV

Clean your TV regularly to keep it at peak performance and to extend the product lifespan.



#### CAUTION

- Before Cleaning, turn the power off and disconnect the power cord and all other cables.
- When the TV is left unattended or unused for a long time, disconnect the power cord from the wall outlet to prevent possible damage from lightning or power surges.

### Screen, frame, cabinet and stand

To remove dust or light dirt, wipe the surface with a dry, clean, and soft cloth.

To remove major dirt, wipe the surface with a soft cloth dampened in clean water or a diluted mild detergent. Then wipe immediately with a dry cloth.



#### CAUTION

- Do not push, rub, or hit the surface with your fingernail or a sharp object, as this may result in scratches on the screen and image distortions.
- Do not use any chemicals, such as waxes, benzene, alcohol, thinners, insecticides, air fresheners, lubricants, as these may damage the screen's finish and cause discoloration.
- Do not spray liquid onto the surface. If water enters the TV, it may result in fire, electric shock, or malfunction.

### Power cord

Remove the accumulated dust or dirt on the power cord regularly.

## TROUBLESHOOTING

Problem	Solution
Cannot control the TV with the remote control.	<ul style="list-style-type: none"> <li>• Check the remote control sensor on the product and try again.</li> <li>• Check if there is any obstacle between the product and the remote control.</li> <li>• Check if the batteries are still working and properly installed (⊕ to ⊕, ⊖ to ⊖).</li> </ul>
No image display and no sound is produced.	<ul style="list-style-type: none"> <li>• Check if the product is turned on.</li> <li>• Check if the power cord is connected to a wall outlet.</li> <li>• Check if there is a problem in the wall outlet by connecting other products.</li> </ul>
The TV turns off suddenly.	<ul style="list-style-type: none"> <li>• Check the power control settings. The power supply may be interrupted.</li> <li>• Check if the Auto sleep feature is activated in the Time settings.</li> <li>• If there is no signal while the TV is on, the TV will turn off automatically after 15 minutes of inactivity.</li> </ul>

# CHILD SAFETY:

It Makes A Difference How and Where You Use Your Flat Panel Display

**Congratulations on your purchase! As you enjoy your new product, please keep these safety tips in mind:**



## THE ISSUE

- The home theater entertainment experience is a growing trend and larger flat panel displays are popular purchases. However, flat panel displays are not always supported on the proper stands or installed according to the manufacturer's recommendations.
- Flat panel displays that are inappropriately situated on dressers, bookcases, shelves, desks, speakers, chests or carts may fall over and cause injury.

## THIS MANUFACTURER CARES!

- The consumer electronics industry is committed to making home entertainment enjoyable and safe.

## TUNE INTO SAFETY

- One size does NOT fit all. Follow the manufacturer's recommendations for the safe installation and use of your flat panel display.
- Carefully read and understand all enclosed instructions for proper use of this product.
- Don't allow children to climb on or play with furniture and television sets.
- Don't allow place flat panel displays on furniture that can easily be used as steps, such as a chest of drawers.
- Remember that children can become excited while watching a program, especially on a "larger than life" flat panel display. Care should be taken to place or install the display where it cannot be pushed, pulled over, or knocked down.
- Care should be taken to route all cords and cables connected to the flat panel display so that they cannot be pulled or grabbed by curious children.



## WALL MOUNTING: IF YOU DECIDE TO WALL MOUNT YOUR FLAT PANEL DISPLAY, ALWAYS:

- Use a mount that has been recommended by the display manufacturer and/or listed by an independent laboratory (such as UL, CSA, ETL).
- Follow all instructions supplied by the display and wall mount manufacturers.
- If you have any doubts about your ability to safely install your flat panel display, contact your retailer about professional installation.
- Make sure that the wall where you are mounting the display is appropriate. Some wall mounts are not designed to be mounted to walls with steel studs or old cinder block construction. If you are unsure, contact a professional installer.
- A minimum of two people are required for installation. Flat panel displays can be heavy.



The model and serial number of the TV is located on the back and one side of the TV. Record it below should you ever need service.

MODEL \_\_\_\_\_

SERIAL \_\_\_\_\_

### LG Customer Information Center

For inquires or comments, visit [www.lg.com](http://www.lg.com) or call;

**1-800-243-0000** USA, Consumer User

**1-888-865-3026** USA, Commercial User

**1-888-542-2623** CANADA

Register your product Online!

[www.lg.com](http://www.lg.com)



This product qualifies for ENERGY STAR in the "factory default (Home Use)" setting.

Changing the factory default settings or enabling other features may increase power consumption that could exceed the limits necessary to qualify for ENERGY STAR.