

**LG Electronics Inc.**  
www.lge.com

PLASMA TV | OWNER'S MANUAL



## PLASMA TV OWNER'S MANUAL

MODELS :

42PB4D      50PB4D  
60PB4D

Please read this manual carefully before operating your set.  
Retain it for future reference.  
Record model number and serial number of the set.  
See the label attached on the back cover and quote this  
information to your dealer when you require service.

ENERGY STAR is a set of power-saving  
guidelines issued by the U.S.  
Environmental Protection Agency(EPA).



As an ENERGY STAR  
Partner LGE U.S.A.,  
Inc. has determined  
that this product  
meets the ENERGY  
STAR guidelines for  
energy efficiency.

P/NO: MFL35930201

LG Electronics Inc.

# WARNING / CAUTION



**WARNING / CAUTION**  
RISK OF ELECTRIC SHOCK  
DO NOT OPEN



TO REDUCE THE RISK OF ELECTRIC SHOCK  
DO NOT REMOVE COVER (OR BACK). NO  
USER SERVICEABLE PARTS INSIDE. REFER TO  
QUALIFIED SERVICE PERSONNEL.



The lightning flash with arrowhead symbol, within an equilateral triangle, is intended to alert the user to the presence of uninsulated "dangerous voltage" within the product's enclosure that may be of sufficient magnitude to constitute a risk of electric shock to persons.



The exclamation point within an equilateral triangle is intended to alert the user to the presence of important operating and maintenance (servicing) instructions in the literature accompanying the appliance.

## WARNING/CAUTION

TO REDUCE THE RISK OF FIRE AND ELECTRIC SHOCK, DO NOT EXPOSE THIS PRODUCT TO RAIN OR MOISTURE.

## NOTE TO CABLE/TV INSTALLER

This reminder is provided to call the CATV system installer's attention to Article 820-40 of the National Electric Code (U.S.A.). The code provides guidelines for proper grounding and, in particular, specifies that the cable ground shall be connected to the grounding system of the building, as close to the point of the cable entry as practical.

## WARNING / CAUTION

To prevent fire or shock hazards, do not expose this product to rain or moisture.

## FCC NOTICE

### Class B digital device

This equipment has been tested and found to comply with the limits for a Class B digital device, pursuant to Part 15 of the FCC Rules. These limits are designed to provide reasonable protection against harmful interference in a residential installation. This equipment generates, uses and can radiate radio frequency energy and, if not installed and used in accordance with the instructions, may cause harmful interference to radio communications. However, there is no guarantee that interference will not occur in a particular installation. If this equipment does cause harmful interference to radio or television reception, which can be determined by turning the equipment off and on, the user is encouraged to try to correct the interference by one or more of the following measures:

- Reorient or relocate the receiving antenna.
- Increase the separation between the equipment and receiver.
- Connect the equipment to an outlet on a circuit different from that to which the receiver is connected.
- Consult the dealer or an experienced radio/TV technician for help.

**Any changes or modifications not expressly approved by the party responsible for compliance could void the user's authority to operate the equipment.**

## CAUTION

Do not attempt to modify this product in any way without written authorization from LG Electronics. Unauthorized modification could void the user's authority to operate this product



# SAFETY INSTRUCTION

## IMPORTANT SAFETY INSTRUCTIONS

Important safety instructions shall be provided with each apparatus. This information shall be given in a separate booklet or sheet, or be located before any operating instructions in an instruction for installation for use and supplied with the apparatus.

This information shall be given in a language acceptable to the country where the apparatus is intended to be used.

The important safety instructions shall be entitled "Important Safety Instructions". The following safety instructions shall be included where applicable, and, when used, shall be verbatim as follows. Additional safety information may be included by adding statements after the end of the following safety instruction list. At the manufacturer's option, a picture or drawing that illustrates the intent of a specific safety instruction may be placed immediately adjacent to that safety instruction :

**Read these instructions.**  
**Keep these instructions.**  
**Heed all warnings.**  
**Follow all instructions.**



- 1** Do not use this apparatus near water



- 2** Clean only with dry cloth.



- 3** Do not block any ventilation openings. Install in accordance with the manufacturer's instructions.



- 4** Do not install near any heat sources such as radiators, heat registers, stoves, or other apparatus (including amplifiers) that produce heat.



- 5** Do not defeat the safety purpose of the polarized or grounding-type plug. A polarized plug has two blades with one wider than the other. A grounding type plug has two blades and a third grounding prong. The wide blade or the third prong are provided for your safety. If the provided plug does not fit into your outlet, consult an electrician for replacement of the obsolete outlet.



- 6** Protect the power cord from being walked on or pinched particularly at plugs, convenience receptacles, and the point where they exit from the apparatus.



- 7** Only use attachments/accessories specified by the manufacturer.



- 8** Use only with the cart, stand, tripod, bracket, or table specified by the manufacturer, or sold with the apparatus. When a cart is used, use caution when moving the cart/apparatus combination to avoid injury from tip-over.



- 9** Unplug this apparatus during lightning storms or when unused for long periods of time.



- 10** Refer all servicing to qualified service personnel. Servicing is required when the apparatus has been damaged in any way, such as power-supply cord or plug is damaged, liquid has been spilled or objects have fallen into the apparatus, the apparatus has exposed to rain or moisture, does not operate normally, or has been dropped.



- 11** **CAUTION** concerning the Power Cord : Most appliances recommend they be placed upon a dedicated circuit; that is, a single outlet circuit which powers only that appliance and has no additional outlets or branch circuits. Check the specification page of this owner's manual to be certain. Do not overload wall outlets. Overloaded wall outlets, loose or damaged wall outlets, extension cords, frayed power cords, or damaged or cracked wire insulation are dangerous. Any of these conditions could result in electric shock or fire. Periodically examine the cord of your appliance, and if its appearance indicates damage or deterioration, unplug it, discontinue use of the appliance, and have the cord replaced with an exact replacement part by an

authorized servicer. Protect the power cord from physical or mechanical abuse, such as being twisted, kinked, pinched, closed in a door, or walked upon. Pay particular attention to plugs, wall outlets, and the point where the cord exits the appliance.



- 12** **Outdoor Use Marking :** **WARNING - To Reduce The Risk Of Fire Or Electric Shock, Do Not Expose This Appliance To Rain Or Moisture**



- 13** **Wet Location Marking :** Apparatus shall not be exposed to dripping or splashing and no objects filled with liquids, such as vases, shall be placed on or over apparatus.



- 14** **GROUNDING** Ensure that you connect the earth ground wire to prevent possible electric shock. If grounding methods are not possible, have a qualified electrician install a separate circuit breaker. Do not try to ground the unit by connecting it to telephone wires, lightening rods, or gas pipes.

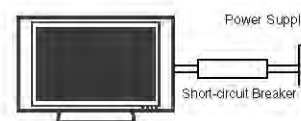

- 15** **DISCONNECTING DEVICE FROM MAINS** Main plug is the disconnecting device. The plug must remain readily operable.



# CONTENTS

<b>WARNING / CAUTION</b> .....	1
<b>SAFETY INSTRUCTION</b> .....	2
<b>TV GUIDE ON SCREEN™ NOTICES FOR U.S.A/ DIGITAL CABLE COMPATIBILITY</b> ...	6
<b>FEATURES OF THIS TV</b> .....	7

## PREPARATION

Accessories .....	8
Front Panel Controls .....	10
Back Panel Information .....	11
Attaching the TV to a Wall .....	12
Back Cover for Wire Arrangement .....	13
Vesa Wall Mounting .....	14
Desktop Pedestal Installation .....	15
Antenna or Cable Connection .....	16
CableCARD™ .....	17

## EXTERNAL EQUIPMENT SETUP

HD Receiver Setup .....	22
DVD Setup .....	25
VCR Setup .....	27
Other A/V Source Setup .....	29
PC Setup .....	30
AV Out Setup .....	35

## WATCHING TV / CHANNEL CONTROL

Remote Control Functions .....	36
Turning on TV .....	38
Channel Selection .....	39
Volume Adjustment .....	39
On-Screen Menus Selection .....	40
Channel Setup	
- Auto Scan ( EZ Scan) .....	41
- Add / Delete Channel ( Manual Scan) ...	42
- Channel Editing .....	43
Brief Info. ....	44
Input Source Selection. ....	45
Auto Link .....	46
Simplink .....	47

Input Label .....	49
DTV Signal Strength .....	50

## TV GUIDE ON SCREEN™ SYSTEM

Setup of TV Guide On Screen™ .....	51
Functions of TV Guide On Screen™ .....	55
- Overview .....	55
- Screen Components/Panel Menu .....	56
- Listings .....	58
- Search .....	59
- Recorded program list .....	63
- Schedule .....	65
- Change Setup .....	66
- Record .....	70
- Remind .....	73

## DVR (Digital Video Recording)

Timeshift ( Pause & Replay of Live TV) .....	76
Instant Recording .....	79
Programmed Recording .....	82
Recorded TV Program List .....	83
Format Hard Disc .....	89

## PICTURE CONTROL

Watching PIP ( Picture-in-Picture)/	
POP( Picture-out-of-Picture)/Twin Picture ...	90
Picture Size (Aspect Ratio) Control .....	94
Preset Picture Settings	
- EZ Picture - Preset .....	95
- Adaptive Picture Mode (APM). ....	96
- Color Tone - Preset .....	97
Manual Picture Adjustment	
- EZ Picture - User Mode .....	98
- Color Tone - User Mode. ....	99
XD - Picture Improvement Technology .....	100

Advanced - Cinema 3:2 Pulldown Mode . . . . .	101
Advanced - Black( Darkness) Level . . . . .	102
Picture Reset . . . . .	103
Image Sticking Minimization( ISM) Method . . . . .	104
Low-Power Picture Mode . . . . .	105

Programming the Remote Control . . . . .	137
IR Codes . . . . .	141
External Control through RS-232C . . . . .	143

## SOUND & LANGUAGE CONTROL

Auto Volume Leveler ( EZ SoundRite) . . . . .	106
Preset Sound Settings( EZ Sound) . . . . .	107
Sound Setting Adjustment - User Mode . . . . .	108
Balance . . . . .	110
BBE - Sound Improvement Technology . . . . .	111
Stereo / SAP Broadcast Setup . . . . .	112
TV Speakers On/ Off Setup . . . . .	113
Audio Language . . . . .	114
On-Screen Menus Lanaguage Selection . . . . .	115
Caption / Text . . . . .	116
Caption Option . . . . .	118

## TIME SETTING

Clock Setting . . . . .	119
Auto On/ Off Timer Setting . . . . .	121
Sleep Timer Setting . . . . .	122
Auto Shut-off Setting . . . . .	123

## PARENTAL CONTROL / RATINGS

Set Password & Lock System . . . . .	124
Channel Blocking . . . . .	127
Movie & TV Rating . . . . .	128
External Input Blocking . . . . .	131

## APPENDIX

Troubleshooting . . . . .	132
Maintenance . . . . .	135
Product Specifications . . . . .	136



# TV GUIDE ON SCREEN™ NOTICES FOR U.S.A.



## Trademark Notice

In the United States, TV GUIDE and other related marks are registered marks of Gemstar-TV Guide International, Inc. and/or one of its affiliates. In Canada, TV GUIDE is a registered mark of Transcontinental Inc., and is used under license by Gemstar-TV Guide International, Inc.

## License Notice

The TV Guide On Screen™ system is manufactured under license from Gemstar-TV Guide International, Inc. and/or one of its affiliates.

## Patent Notice

The TV Guide On Screen™ system is protected by one or more of the following issued United States patents 6,498,895; 6,418,556; 6,331,877; 6,239,794; 6,154,203; 5,940,073; 4,908,713; 4,751,578; 4,706,121.

Use of the CableCARD™ TradeMark.

"CableCARD™ is a trademark of Cable Television Laboratories, Inc."

## DIGITAL CABLE COMPATIBILITY

This digital television is capable of receiving basic analog, digital basic and digital premium cable television programming by direct connection to a cable system providing such programming. A security card provided by your cable operator is required to view encrypted digital programming. Cable operator enhanced program (For example, electronic program guide provided by the cable operator), and data enhanced television service may require the use of a set top box. For more information contact your local cable operator.



Official term for an HDTV that conforms to the plug-and-play digital cable TV standard using POD (Point of Deployment) access cards, also called CableCARDS, that allow users to plug the cable directly into an HDTV set and enjoy HDTV and digital cable without having to use a separate set-top box.



**SRS** is a trademark of SRS Labs, Inc. TruSurround XT technology is incorporated under license from SRS Labs, Inc.



Manufactured under license from BBE Sound, Inc.



A Digital Video Recorder (DVR) is a device that empowers you to control what you watch, when you watch it. It allows you to store and access TV programs - functioning like a VCR, but with no videotape. With a DVR, you can also pause live TV and choose the shows you want to record through an electronic program guide.



Manufactured under license from Dolby Laboratories. "Dolby" and the double-D symbol are trademarks of Dolby Laboratories.



High-definition television. High-resolution digital television broadcast and playback system composed of roughly a million or more pixels, 16:9 aspect-ratio screens, and AC3 digital audio. A subset of digital television, HDTV formats include 1080i and 720p resolutions.



HDMI™, the HDMI logo and High-Definition Multimedia Interface are trademarks or registered trademarks of HDMI Licensing."



LC's own special digital image generator, consisting of a full digital image processor, six different main picture quality factors.

# FEATURES OF THIS TV

## What is a Plasma TV ?

Using plasma is the best way to achieve flat panel displays with excellent image quality and large screen sizes that are easily viewable. The Plasma TV can be thought of as a descendant of the neon lamp and/or a series of fluorescent lamps.

## How does it work?

Plasma TV is an array of cells, known as pixels, which are comprised of three sub-pixels, corresponding to the colors red, green, and blue. Gas in a plasma state is used to react with phosphors in each sub-pixel to produce colored light (red, green, or blue). These phosphors are the same types used in Cathode Ray Tube (CRT) devices such as televisions and common computer monitors.

Plasma TV offers a rich, dynamic display because each sub-pixel is individually controlled by advanced electronics to produce over 16 million different colors. This means that you get perfect images that are easily viewable in a display that is fewer than five inches thick.

## 160° - Wide angle range of vision

Your flat panel plasma screen offers an exceptionally broad viewing angle of over 160 degrees. This means that the display is clear and visible to viewers anywhere in the room.

## Wide Screen

The wide screen offers a theater-like experience in your own home.

## Multimedia

Connect your plasma display to a PC and use it for conferencing, games, and Internet browsing. The Picture-in-Picture feature allows you to view your PC and video images simultaneously.

## Versatile

The light weight and thin size makes it easy to install your plasma display in a variety of locations where conventional TVs do not fit.

## The Plasma TV Manufacturing Process: a few minute colored dots may be present on the Plasma TV screen

The Plasma TV is composed of 0.9 to 2.2 million

cells. A few cell defects will normally occur in the Plasma TV manufacturing process. Several tiny, minute colored dots visible on the screen should be acceptable. This also occurs in other Plasma TV manufacturers' products. The tiny dots appearing does not mean that this Plasma TV is defective. Thus a few cell defects are not sufficient cause for the Plasma TV to be exchanged or returned. Our production technology minimizes these cell defects during the manufacture and operation of this product.

## Cooling Fan Noise (This feature is not available for all models.)

In the same way that a fan is used in a PC computer to keep the CPU (Central Processing Unit) cool, the Plasma TV is equipped with cooling fans to cool the Monitor and improve its reliability. Therefore, a certain level of noise could occur while the fans are operating and cooling the Plasma TV.

The fan noise doesn't have any negative effect on the Plasma TV's efficiency or reliability. The noise from these fans is normal during the operation of this product. We hope you understand that a certain level of noise from the cooling fans is acceptable and is not sufficient cause for the Plasma TV to be exchanged or returned.

## FOR LCD TV

If the TV feels cold to the touch, there may be a small "flicker" when it is turned on. This is normal, there is nothing wrong with TV.

Some minute dot defects may be visible on the screen, appearing as tiny red, green, or blue spots. However, they have no adverse effect on the monitor's performance.

Avoid touching the LCD screen or holding your finger(s) against it for long periods of time. Doing so may produce some temporary distortion effects on the screen.

## On Disposal

- The fluorescent lamp used in this product contains a small amount of mercury.
- Do not dispose of this product with general household waste.
- Disposal of this product must be carried out in accordance to the regulations of your local authority.



# PREPARATION

## ACCESSORIES

PREPARATION

Ensure that the following accessories are included with your plasma display. If an accessory is missing, please contact the dealer where you purchased the product.

User must use shielded signal interface cables(D-sub 15 pin cable) with ferrite cores to maintain standard compliance for the product.



Owner's Manual



Batteries



Remote Control



Power Cord



75Ω Round Cable



Polishing Cloth

- Slightly wipe stained spot on the exterior only with the cleansing cloths for the product exterior if there is stain or fingerprint on surface of the exterior.
- Do not wipe roughly when removing stain. Please be cautious of that excessive power may cause scratch or discoloration.

### Option Extras

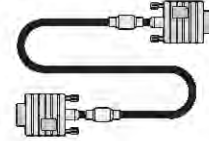

D-sub 15 pin Cable

### For 42/50 inches



2- Wall brackets



2- eye-bolts

### For 60 inch



2- Wall brackets  
2- TV brackets



2- TV Bracket Bolts

# HOME MENU

This menu is a contents guide.  
In HOME Menu, you can enter the recorded list of DVR, TV Guide, Schedule of the TV Guide, Manual Record of DVR or TV Menu.

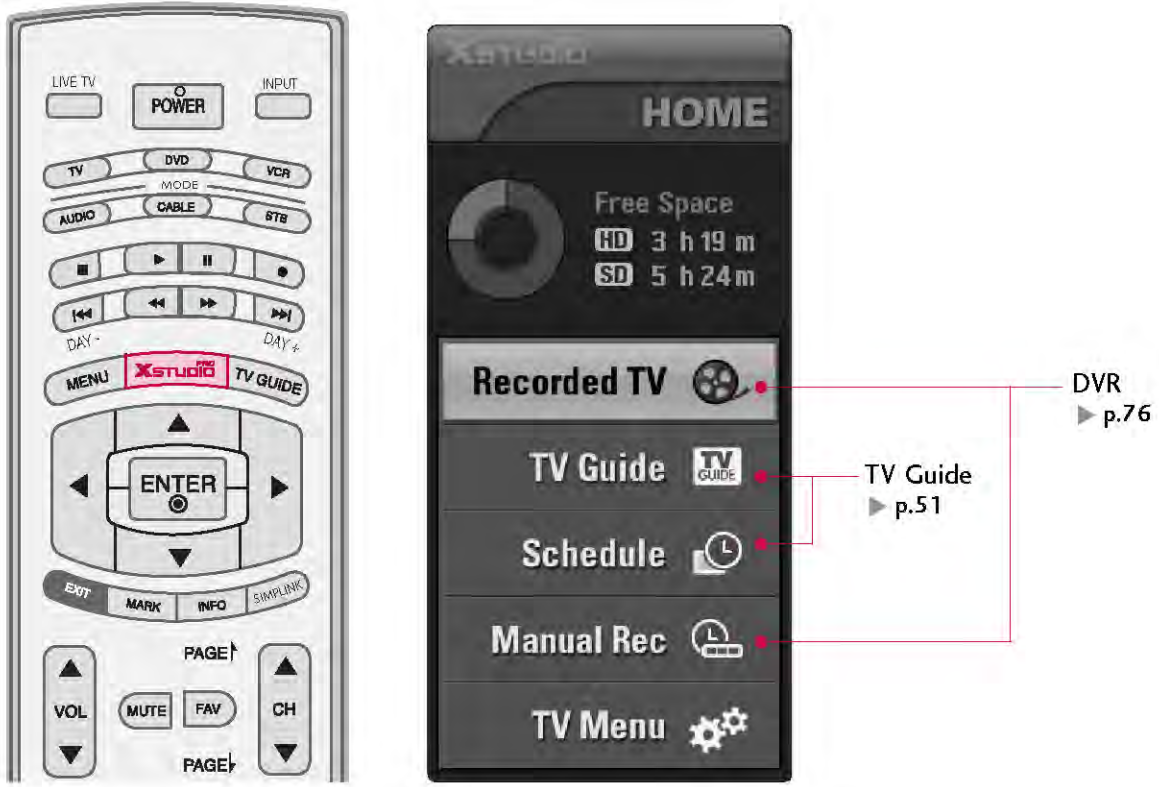



# PREPARATION

## FRONT PANEL CONTROLS

- Here shown may be somewhat different from your TV.
- If your TV stand has a protection film, remove it attached to the stand. Then wipe the stand with polishing cloth.

PREPARATION

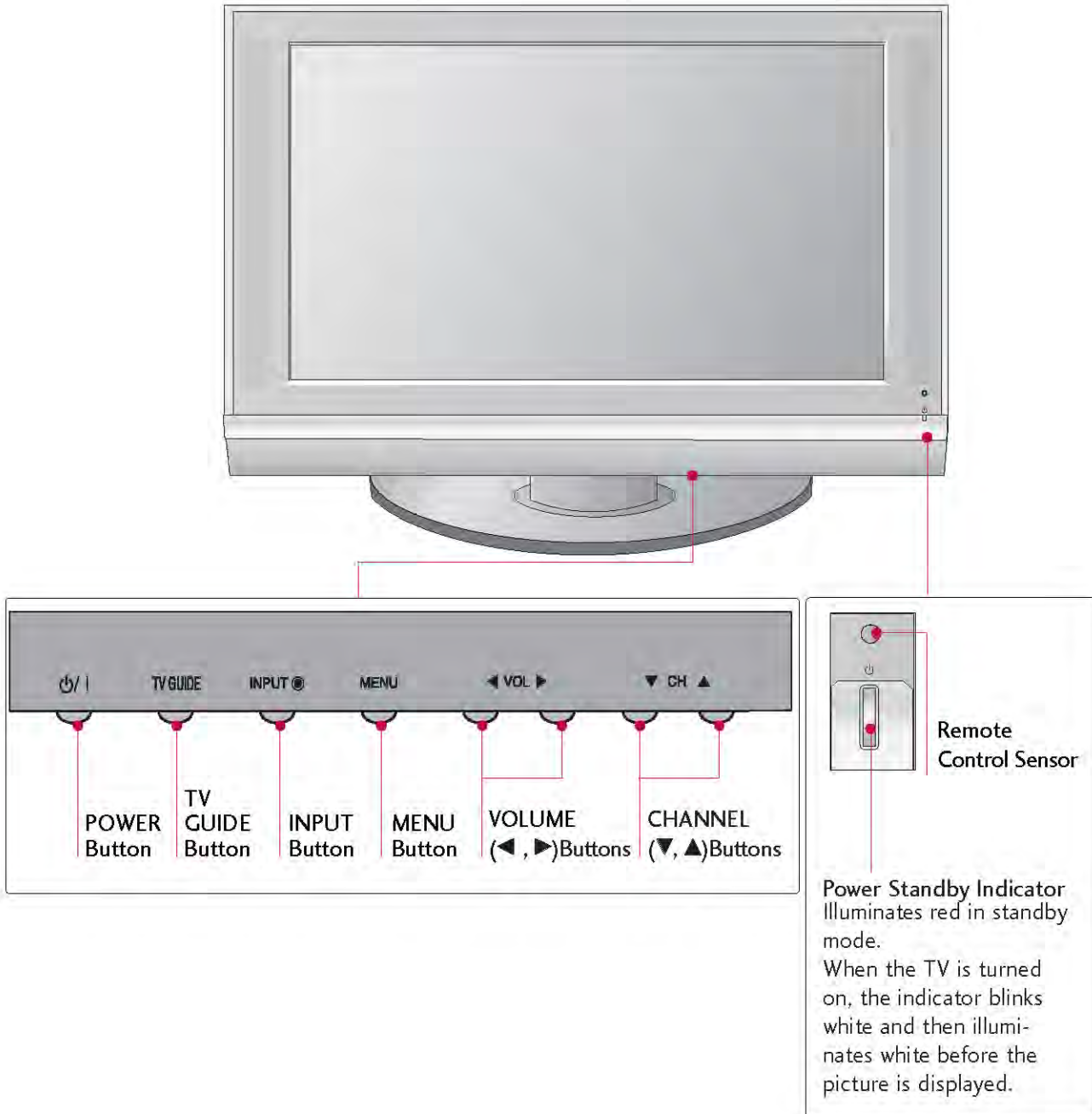

# BACK PANEL INFORMATION

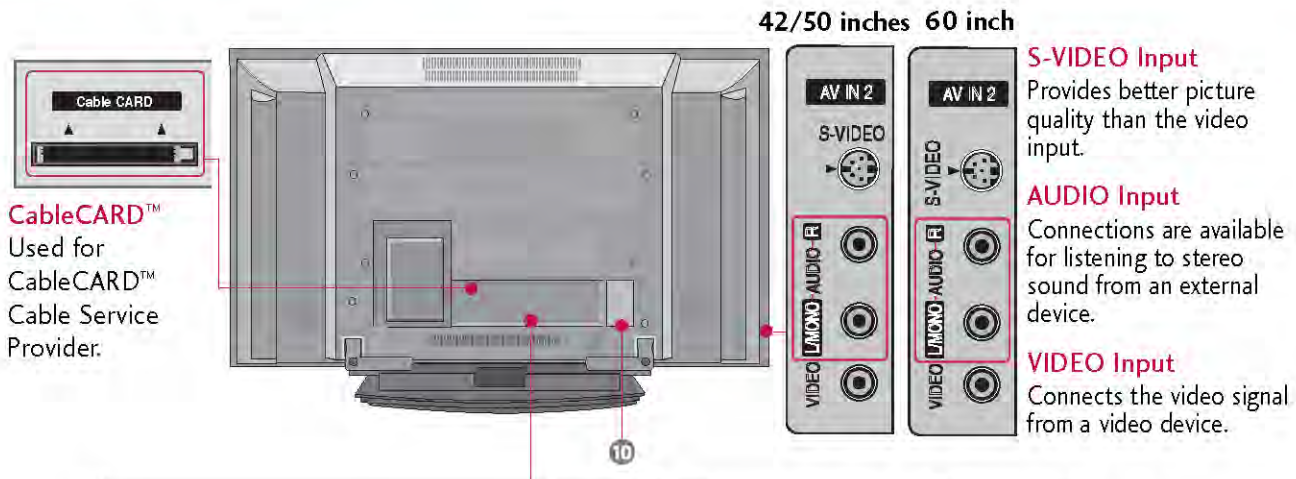

PREPARATION

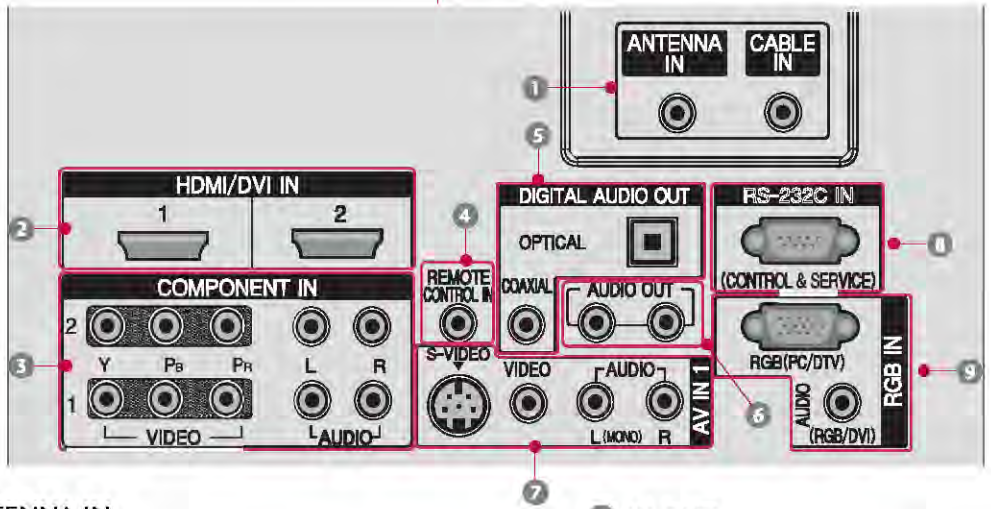

- 1 ANTENNA IN**  
Connect over-the air signals to this jack.  
**CABLE IN**  
Connect cable signals to this jack.
- 2 HDMI/DVI IN**  
Connect a HDMI signal to 1 or 2.  
Or DVI(VIDEO)signal to the 1 or 2 port with a DVI to HDMI cable.
- 3 COMPONENT IN**  
Connect a component video/audio device to these jacks.
- 4 REMOTE CONTROL IN**  
Connect your wired remote control.
- 5 DIGITAL AUDIO OUT**  
Connect digital audio from various types of equipment.  
Note: In standby mode, these ports do not work.
- 6 AV OUT**  
Connect a second TV or monitor.
- 7 AV (Audio/Video) IN 1**  
Connect audio/video output from an external device to these jacks.  
**S-VIDEO**  
Connect S-Video out from an S-VIDEO device.
- 8 RS-232C IN (CONTROL & SERVICE) PORT**  
Connect to the RS-232C port on a PC.
- 9 RGB IN**  
Connect the monitor output from a PC to the appropriate input port.
- 10 Power Cord Socket**  
For operation with AC power.  
Caution :  
Never attempt to operate the TV on DC power.



# PREPARATION

## ATTACHING THE TV TO A WALL

PREPARATION

We recommend that you set up the TV close to a wall so it cannot fall over if pushed backwards. Additionally, we recommend that the TV be attached to a wall so it cannot be pulled in a forward direction, potentially causing injury or damaging the product. Caution: Please make sure that children don't climb on or hang from the TV.

42/50 inches

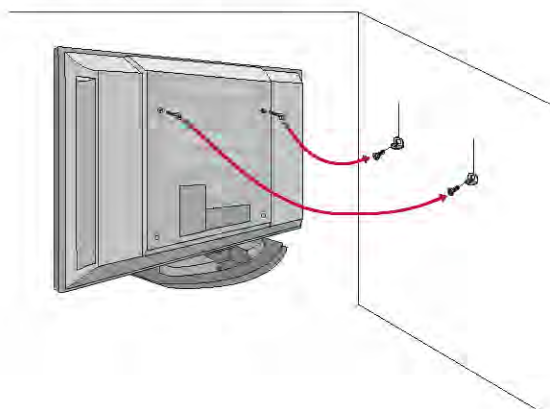

60 inch

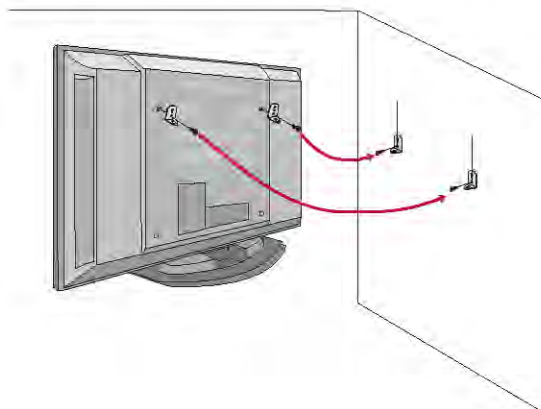

- Insert the eye-bolts (or TV brackets and bolts) to tighten the product to the wall as shown in the picture. \*Insert the eye-bolts and tighten them securely in the upper holes. Secure the wall brackets with the bolts (not provided as parts of the product, must purchase separately) on the wall. Match the height of the bracket that is mounted on the wall to the holes in the product. Ensure the eye-bolts or brackets are tightened securely.

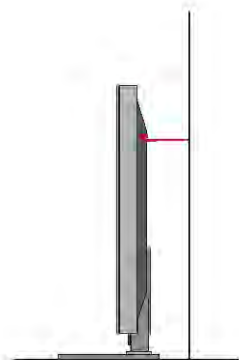

- Use a sturdy rope (not provided as parts of the product, must purchase separately) to tie the product. It is safer to tie the rope so it becomes horizontal between the wall and the product.

## BACK COVER FOR WIRE ARRANGEMENT

- 1 Hold the **CABLE MANAGEMENT** with both hands and pull it backward as shown.

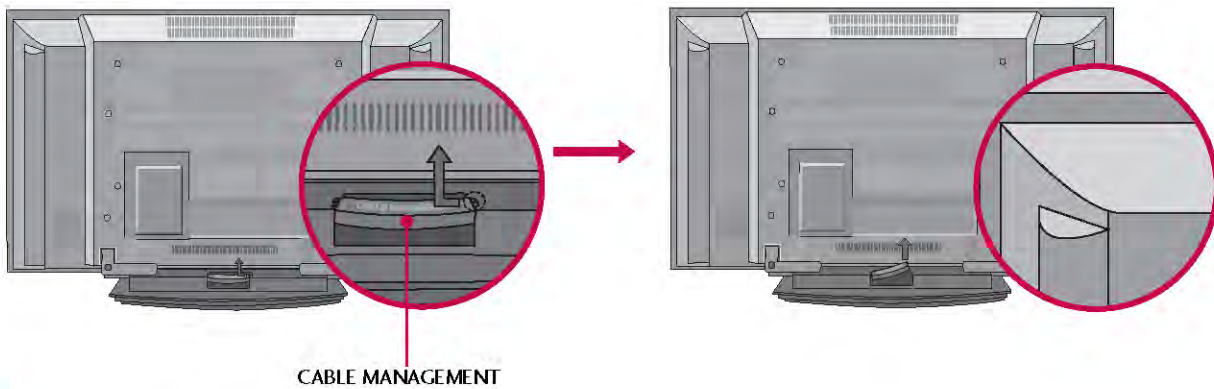

- 2 Connect the cables as necessary.  
To connect an additional equipment, see the **External equipment Connections** section.

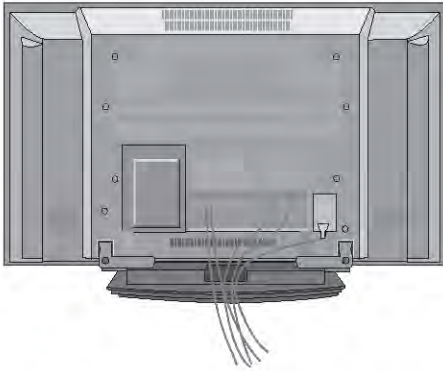

- 3 Install the **CABLE MANAGEMENT** as shown.

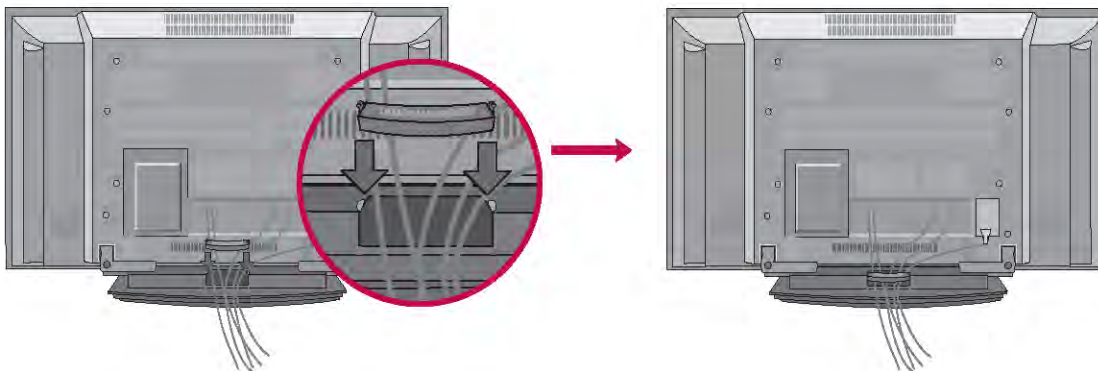



# PREPARATION

## VESA WALL MOUNTING

This product accepts a VESA-compliant mounting interface pad. (optional)  
There 4 threaded holes are available for attaching the bracket.

PREPARATION

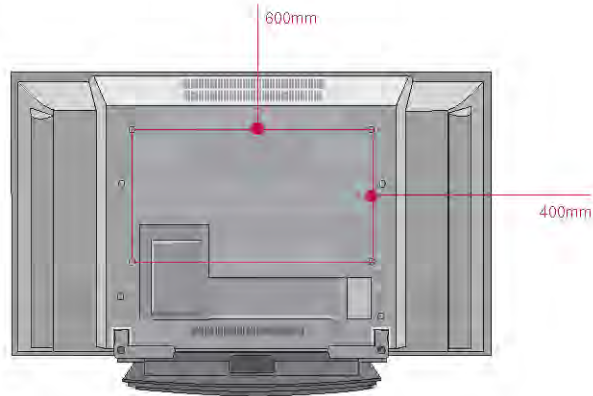

### NOTE

- ▶ Screw length needed depends on the wall mount used. For further information, refer to the VESA Wall Mounting Instruction Guide.

## DESKTOP PEDESTAL INSTALLATION

For proper ventilation, allow a clearance of 4 in. on each side and the top, 2.36 in. on the bottom, and 4 in. from the wall.

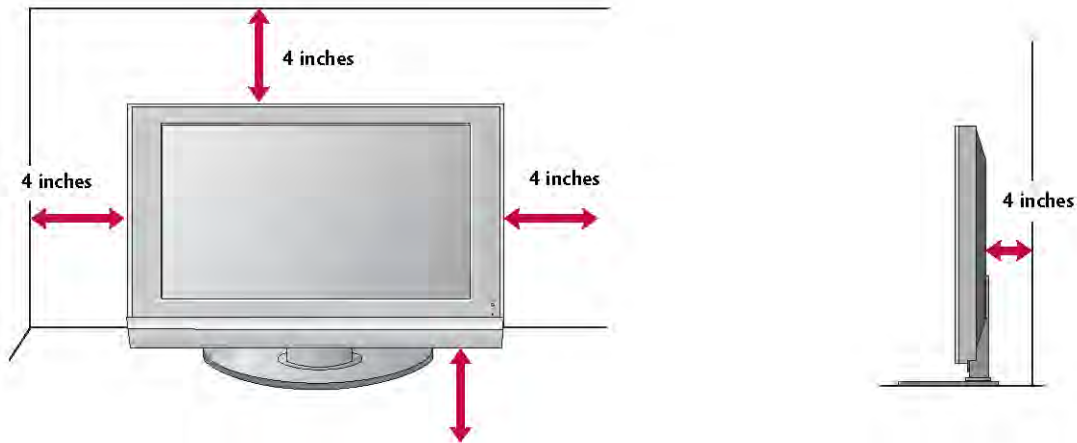

### **⚠ CAUTION**

- ▶ Ensure adequate ventilation by following the clearance recommendations.



# PREPARATION

## ANTENNA OR CABLE CONNECTION

PREPARATION

### 1. Antenna (analog or digital)

Wall Antenna Socket or Outdoor Antenna without a Cable Box Connections. For optimum picture quality, adjust antenna direction if needed.

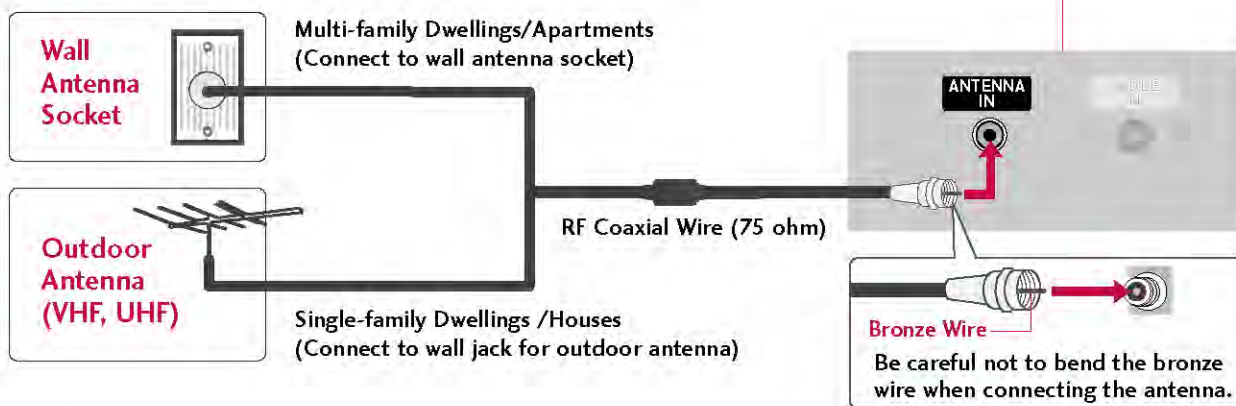

### 2. Cable



### 3. Using both cable and antenna

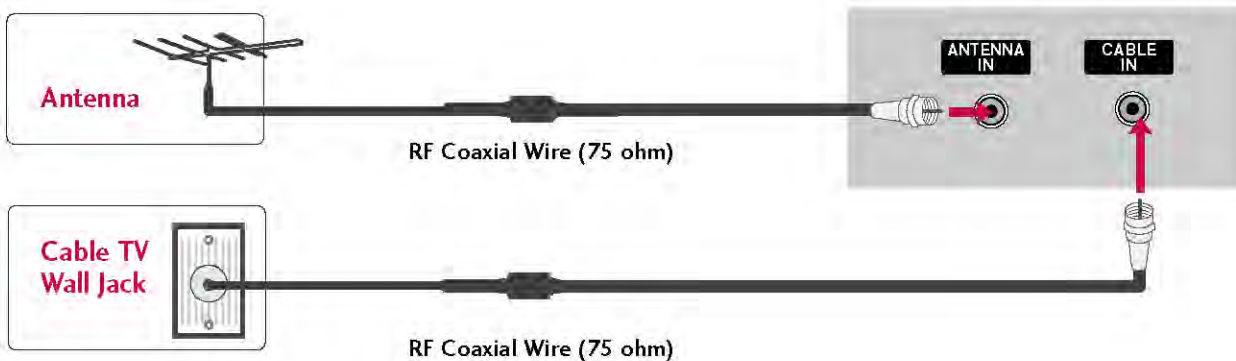

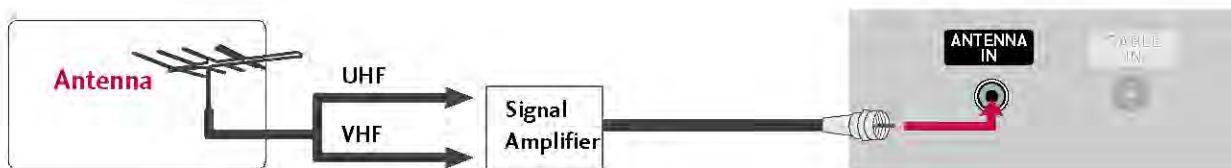

- To improve the picture quality in a poor signal area, please purchase a signal amplifier and install properly.
- If the antenna needs to be split for two TV's, install a 2-Way Signal Splitter.
- If the antenna is not installed properly, contact your dealer for assistance.

**NOTE**

▶ The TV will let you know when the analog, cable, and digital channel scans are complete.

## CABLECARD™

### CableCARD™ Setup

#### How to use

Insert the CableCARD™ from your cable service provider into the CableCARD™ slot on the back of your TV. If pairing information about this TV and the CableCARD is displayed on the screen, contact your cable service provider.

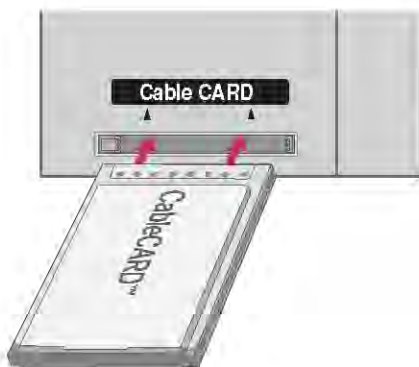

**NOTE**

▶ This TV supports CableCARD™ technology from Motorola, Scientific Atlanta, and SCM.

**CAUTION**

▶ When removing, do not drop it as this may cause damage to the CableCARD™.



# PREPARATION

## CableCARD™ Function

*In this manual, the OSD (On Screen Display) may be different from your TV's because it is just example to help the TV operation.*

### Cable menu options

The Cable sub menu displays when inserting the CableCARD™ to the TV.

The CableCARD™ type is Motorola, Scientific Atlanta (SA), or SCM etc. The OSD (On screen display) is different from your TV according to your CableCARD™ type.

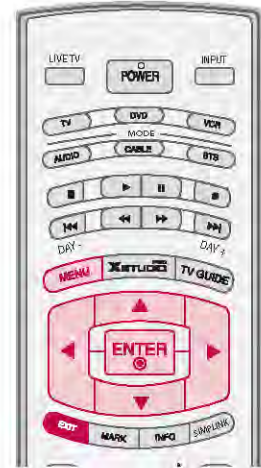

- 1 Press the **MENU** button and then use **▲** or **▼** button to select the **CABLE** menu.
- 2 Press the **▶** button and then use **▲** or **▼** button to select your desired item.
- 3 Press the **▶** button.
- 4 Press **EXIT** button to return to TV viewing.

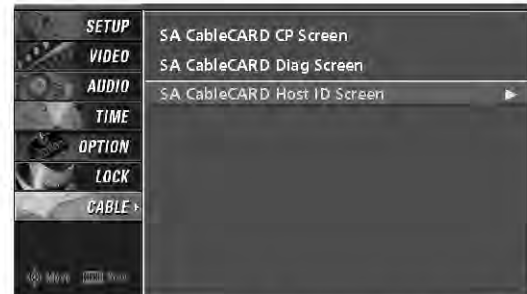

In case of Scientific Atlanta CableCARD™



CableCARD™ / Host ID Screen  
As shown, the pairing number means your TV and CableCARD™ ID. For further information regarding cable TV service, contact your local cable TV service provider(s).

## Scrambled channel

- 1 Insert the CableCARD™. It takes about 1 minute to exchange data between the TV and the CableCARD™. The screen displays information as shown to the right.

---

- 2 Let your cable TV service provider know the CableCARD™ ID and Host ID.

---

- 3 If your cable TV service provider registers the CableCARD™ ID and Host ID, you can watch premium or high value channel. If you are subscribed to them.

---

- 4 If you registered with the cable TV service provider, you can watch premium or high value channel without a message.

---

- 5 If the certificates don't match between the TV and the CableCARD™, the OSD (On screen display) displays as shown right.

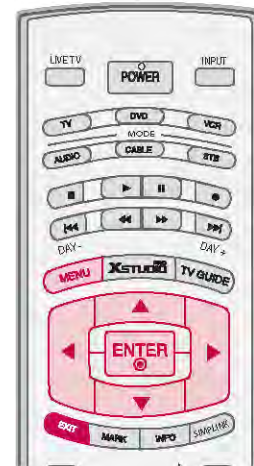

1 2 3 4



5



# PREPARATION

## Cable Channel List

- 1 If you select Channel Edit after running the EZ Scan without a CableCARD™, the cable channel list displays, as in the picture below.
- 2 Insert the CableCARD™. After a few minutes (about 2~3 minutes), the TV receives a new cable channel list. (Occasionally more time will be needed)

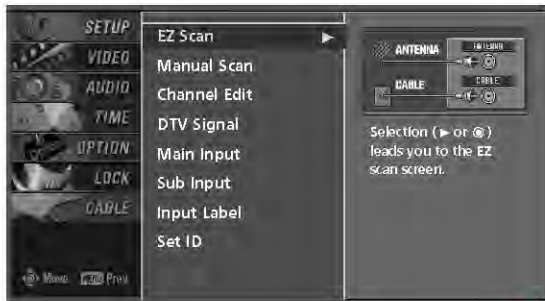

1

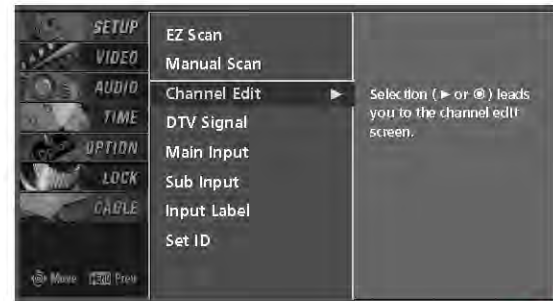

1



1



2



## Emergency Message Alert

- 1 If an emergency situation occurs while you are watching the TV/DTV/CATV/CADTV, you may receive a message from your cable TV service provider(s).
- 2 When receiving an emergency message, the message is displayed on the screen as shown or the channel is changed to one that maintains the emergency message. When the broadcast is complete the TV returns to the channel you were viewing.



# EXTERNAL EQUIPMENT SETUP

## HD RECEIVER SETUP

This TV can receive Digital Over-the-air/Cable signals without an external digital set-top box. However, if you do receive digital signals from a digital set-top box or other digital external device, refer to the figure as shown below.

This TV supports HDCP (High-bandwidth Digital Contents Protection) protocol for Digital Contents (480p,720p,1080i).

### When connecting Component cable

#### 1. How to connect

- 1 Connect the video outputs (Y, PB, PR) of the digital set top box to the **COMPONENT IN VIDEO 1** jacks on the set. Match the jack colors (Y = green, PB = blue, and PR = red).
- 2 Connect the audio output of the digital set-top box to the **COMPONENT IN AUDIO 1** jacks on the set.

#### 2. How to use

- Turn on the digital set-top box.  
(Refer to the owner's manual for the digital set-top box.)
- Select **COMPONENT 1** input source with using the **INPUT** button on the remote control.
- If connected to **COMPONENT IN 2** input, select **COMPONENT 2** input source.

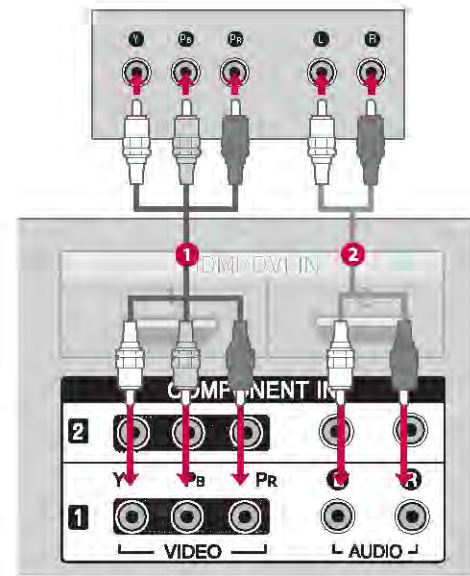

Signal	Component 1/2	RGB-DTV, HDMI1/DVI, HDMI2
480i	Yes	No
480p	Yes	Yes
720p	Yes	Yes
1080i	Yes	Yes



## When connecting D-sub 15pin cable

### 1. How to connect

- 1 Connect the RGB output of the digital set-top box to the **RGB (PC/DTV)** jack on the set.
- 2 Connect the audio outputs of the set-top box to the **AUDIO (RGB/DVI)** jack on the set.

### 2. How to use

- Turn on the digital set-top box.  
(Refer to the owner's manual for the digital set-top box.)
- Select **RGB-DTV** input source with using the **INPUT** button on the remote control.

## When connecting HDMI cable

### 1. How to connect

- 1 Connect the digital set-top box to **HDMI/DVI IN 1** or **2** jack on the set.
- 2 No separated audio connection is necessary.

### 2. How to use

- Turn on the digital set-top box.  
(Refer to the owner's manual for the digital set-top box.)
- Select **HDMI1/DVI** or **HDMI2** input source with using the **INPUT** button on the remote control.
- If the digital set-top box supports Auto HDMI function, the output resolution of the source device will be automatically set to 1280x720p.
- If the digital set-top box player does not support Auto HDMI, you need to set the output resolution appropriately.  
To get the best picture quality, adjust the output resolution of the source device to 1280x720p.

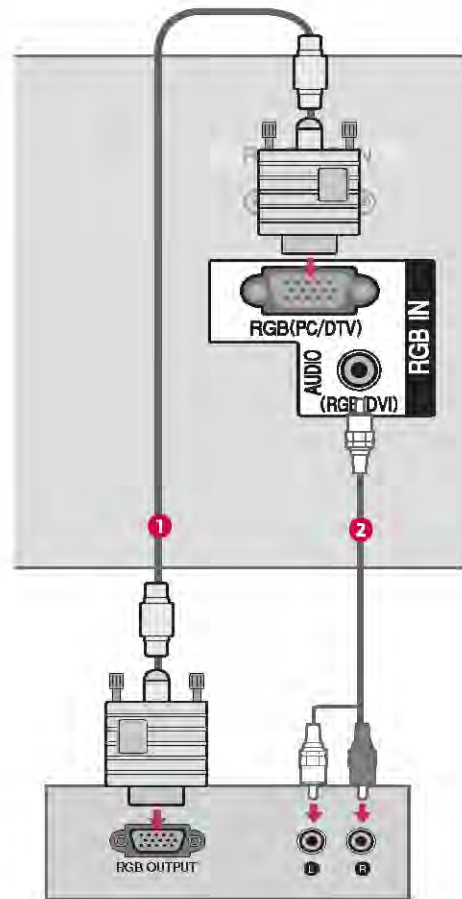

EXTERNAL EQUIPMENT SETUP

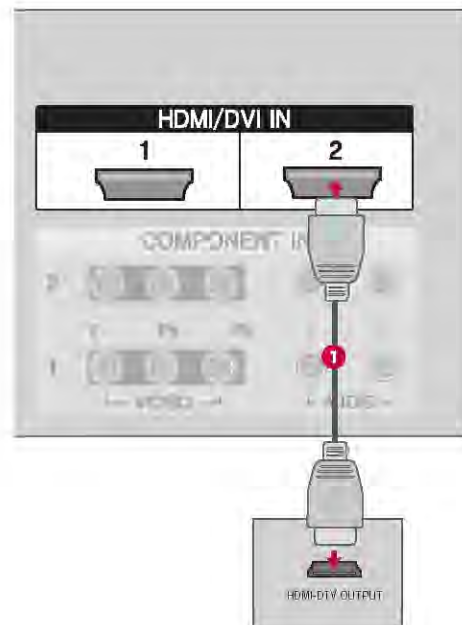

# EXTERNAL EQUIPMENT SETUP

## When connecting HDMI to DVI cable

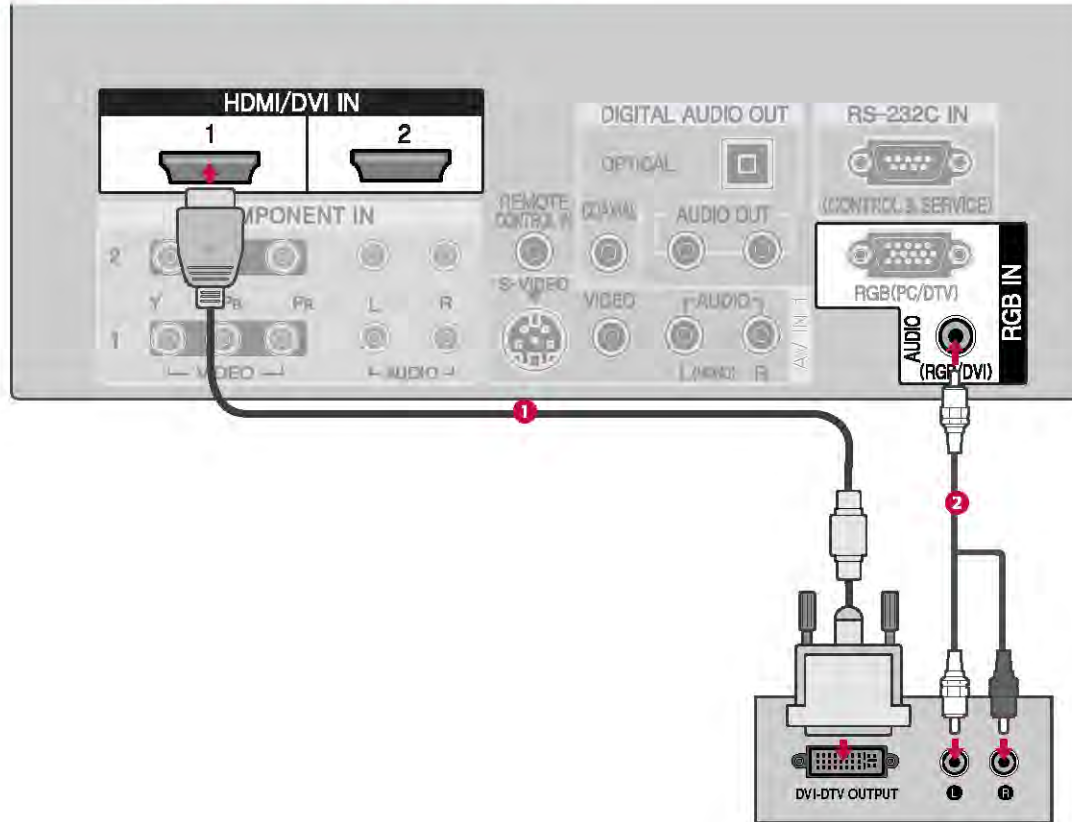

EXTERNAL EQUIPMENT SETUP

### 1. How to connect

- 1 Connect the DVI output of the digital set-top box to the **HDMI/DVI IN 1** jack on the set.
- 2 Connect the audio output of the digital set-top box to the **AUDIO(RGB/DVI)** jack on the set.

### 2. How to use

- Turn on the digital set-top box. (Refer to the owner's manual for the digital set-top box.)
- Select **HDMI1/DVI** input source with using the **INPUT** button on the remote control.

# DVD SETUP

## When connecting Component cable

### 1. How to connect

- 1 Connect the video outputs (Y, PB, PR) of the DVD to the **COMPONENT IN VIDEO1** jacks on the set. Match the jack colors (Y = green, PB = blue, and PR = red).
- 2 Connect the audio outputs of the DVD to the **COMPONENT IN AUDIO1** jacks on the set.

### 2. How to use

- Turn on the DVD player, insert a DVD.
- Select **COMPONENT 1** input source with using the **INPUT** button on the remote control.
- If connected to **COMPONENT IN 2** input, select **COMPONENT 2** input source.
- Refer to the DVD player's manual for operating instructions.

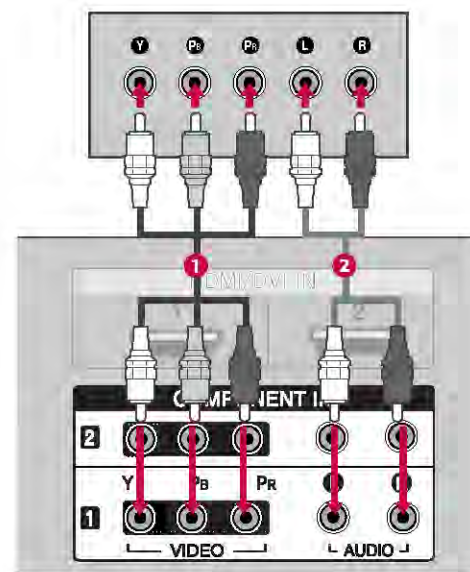

### Component Input ports

To get better picture quality, connect a DVD player to the component input ports as shown below.

Component ports on the TV	Y	P <sub>B</sub>	P <sub>R</sub>
Video output ports on DVD player	Y	P <sub>B</sub>	P <sub>R</sub>
	Y	P <sub>b</sub>	P <sub>r</sub>
	Y	B-Y	R-Y
	Y	C <sub>b</sub>	C <sub>r</sub>



# EXTERNAL EQUIPMENT SETUP

## When connecting with an S-Video cable

### 1. How to connect

- 1 Connect the S-VIDEO output of the DVD to the S-VIDEO input on the set.
- 2 Connect the audio outputs of the DVD to the AUDIO input jacks on the set.

### 2. How to use

- Turn on the DVD player, insert a DVD.
- Select **AV1** input source with using the **INPUT** button on the remote control.
- If connected to **AV IN 2**, select **AV2** input source.
- Refer to the DVD player's manual for operating instructions.

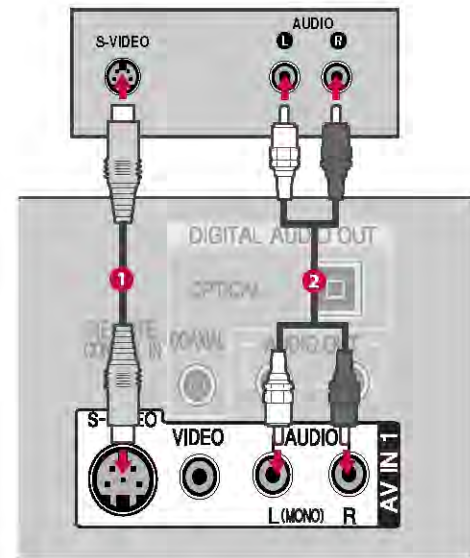

## When connecting HDMI cable

### 1. How to connect

- 1 Connect the HDMI output of the DVD to the HDMI/DVI IN1 or 2 jack on the set.
- 2 No separated audio connection is necessary.

### 2. How to use

- Select HDMI1/DVI or HDMI2 input source with using the **INPUT** button on the remote control.
- Refer to the DVD player's manual for operating instructions.
- If the DVD supports Auto HDMI function, the DVD output resolution will be automatically set to 1280x720p.
- If the DVD does not support Auto HDMI, you need to set the output resolution appropriately.  
To get the best picture quality, adjust the output resolution of the DVD to 1280x720p.

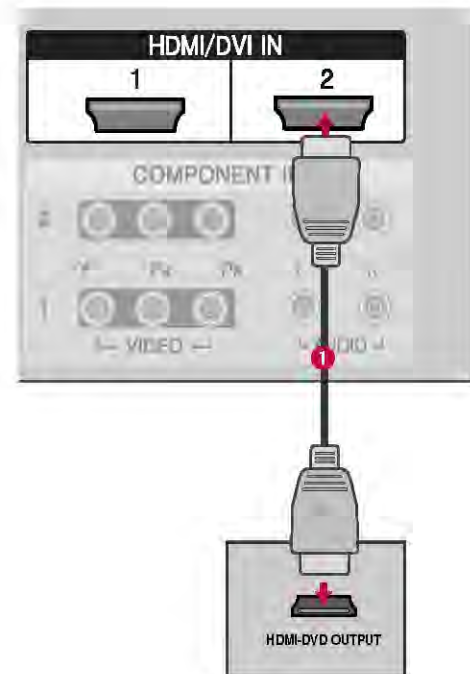

## VCR SETUP

- To avoid picture noise (interference), leave an adequate distance between the VCR and TV
- Use the ISM feature in the Option menu to avoid having a fixed image remain on the screen for a long period of time. If the 4:3 picture format is used; the fixed images on the sides of the screen may remain visible on the screen.

### When connecting with an antenna

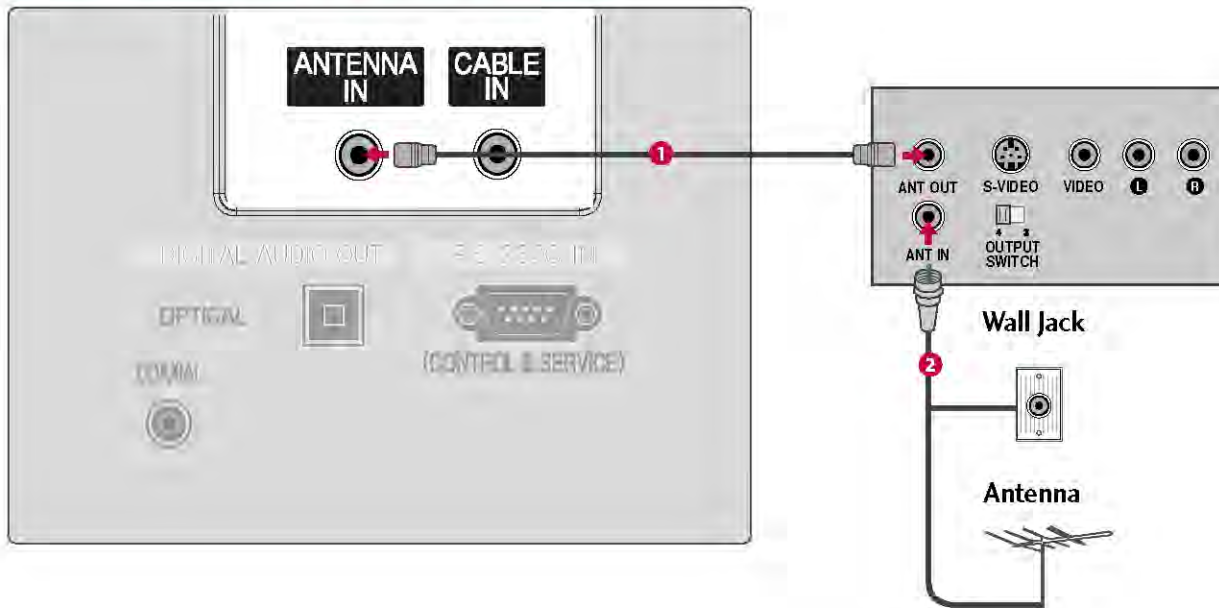

### 1. How to connect

- 1 Connect the RF antenna out socket of the VCR to the **Antenna** socket on the set.
- 2 Connect the antenna cable to the RF antenna in socket of the VCR.

### 2. How to use

- Set VCR output switch to 3 or 4 and then tune TV to the same channel number.
- Insert a video tape into the VCR and press PLAY on the VCR. (Refer to the VCR owner's manual.)

# EXTERNAL EQUIPMENT SETUP

## When connecting with a RCA cable

### 1. How to connect

- 1 Connect the **AUDIO/VIDEO** jacks between TV and VCR. Match the jack colors (Video = yellow, Audio Left = white, and Audio Right = red)

### 2. How to use

- Insert a video tape into the VCR and press **PLAY** on the VCR. (Refer to the VCR owner's manual.)
- Select **AV1** input source with using the **INPUT** button on the remote control.
- If connected to **AV IN 2**, select **AV2** input source.

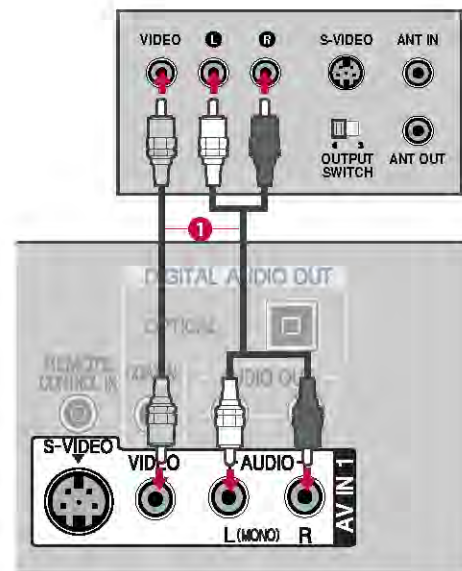

### ! NOTE

- ▶ If you have a mono VCR, connect the audio cable from the VCR to the **AUDIO L/MONO** jack of the set.

## When connecting with an S-Video

### 1. How to connect

- 1 Connect the **S-VIDEO** output of the VCR to the **S-VIDEO** input on the set. The picture quality is improved; compared to normal composite (RCA cable) input.
- 2 Connect the audio outputs of the VCR to the **AUDIO** input jacks on the set.

### 2. How to use

- Insert a video tape into the VCR and press **PLAY** on the VCR. (Refer to the VCR owner's manual.)
- Select **AV1** input source with using the **INPUT** button on the remote control.
- If connected to **AV IN 2**, select **AV2** input source.

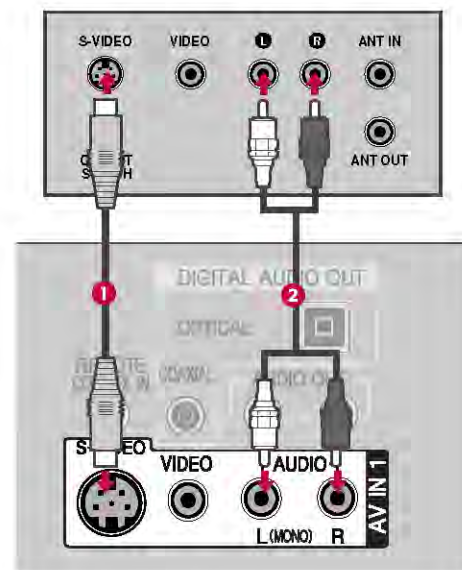

### ! CAUTION

- ▶ Do not connect to both Video and S-Video at the same time.



## OTHER A/V SOURCE SETUP

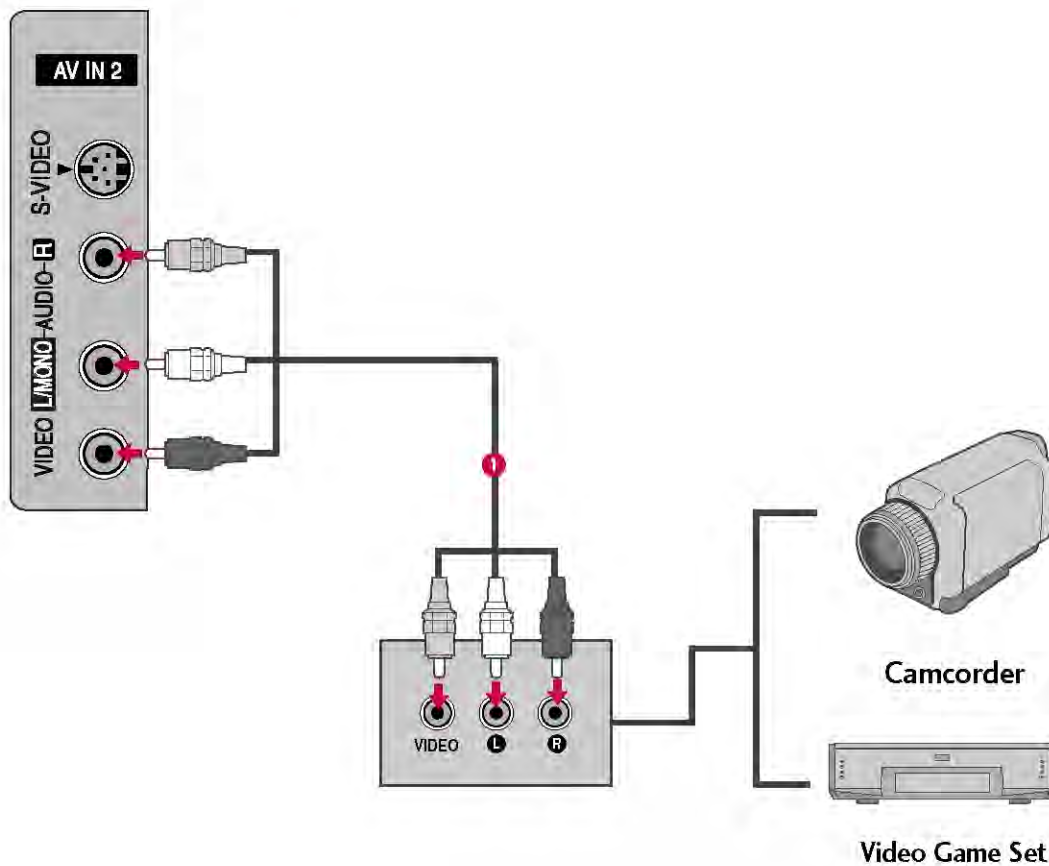

### 1. How to connect

- 1 Connect the **AUDIO/VIDEO** jacks between TV and external equipment. Match the jack colors. (Video = yellow, Audio Left = white, and Audio Right = red)

### 2. How to use

- Select **AV1** input source with using the **INPUT** button on the remote control.
- If connected to **AV IN 2** input, select **AV2** input source.
- Operate the corresponding external equipment.