

Installation and Operating Guide

Model Numbers | 42PC3DB, 50PC3DB | PLASMA TV



ENERGY STAR is a set of power-saving guidelines issued by the U.S. Environmental Protection Agency (EPA).



As an ENERGY STAR Partner LGE U. S. A., Inc. has determined that this product meets the ENERGY STAR guidelines for energy efficiency.



WARNING / CAUTION



WARNING / CAUTION
RISK OF ELECTRIC SHOCK
DO NOT OPEN



**TO REDUCE THE RISK OF ELECTRIC SHOCK
DO NOT REMOVE COVER (OR BACK). NO
USER SERVICEABLE PARTS INSIDE. REFER TO
QUALIFIED SERVICE PERSONNEL.**



The lightning flash with arrowhead symbol, within an equilateral triangle, is intended to alert the user to the presence of uninsulated “dangerous voltage” within the product’s enclosure that may be of sufficient magnitude to constitute a risk of electric shock to persons.



The exclamation point within an equilateral triangle is intended to alert the user to the presence of important operating and maintenance (servicing) instructions in the literature accompanying the appliance.

WARNING/CAUTION

TO REDUCE THE RISK OF FIRE AND ELECTRIC SHOCK, DO NOT EXPOSE THIS PRODUCT TO RAIN OR MOISTURE.

NOTE TO CABLE/TV INSTALLER

This reminder is provided to call the CATV system installer’s attention to Article 820-40 of the National Electric Code (U.S.A.). The code provides guidelines for proper grounding and, in particular, specifies that the cable ground shall be connected to the grounding system of the building, as close to the point of the cable entry as practical.

WARNING / CAUTION

To prevent fire or shock hazards, do not expose this product to rain or moisture.

FCC NOTICE

Class B digital device

This equipment has been tested and found to comply with the limits for a Class B digital device, pursuant to Part 15 of the FCC Rules. These limits are designed to provide reasonable protection against harmful interference in a residential installation. This equipment generates, uses and can radiate radio frequency energy and, if not installed and used in accordance with the instructions, may cause harmful interference to radio communications. However, there is no guarantee that interference will not occur in a particular installation. If this equipment does cause harmful interference to radio or television reception, which can be determined by turning the equipment off and on, the user is encouraged to try to correct the interference by one or more of the following measures:

- Reorient or relocate the receiving antenna.
- Increase the separation between the equipment and receiver.
- Connect the equipment to an outlet on a circuit different from that to which the receiver is connected.
- Consult the dealer or an experienced radio/TV technician for help.

Any changes or modifications not expressly approved by the party responsible for compliance could void the user’s authority to operate the equipment.

CAUTION

Do not attempt to modify this product in any way without written authorization from LG Electronics. Unauthorized modification could void the user’s authority to operate this product

SAFETY INSTRUCTIONS

IMPORTANT SAFETY INSTRUCTIONS

Important safety instructions shall be provided with each apparatus. This information shall be given in a separate booklet or sheet, or be located before any operating instructions in an instruction for installation for use and supplied with the apparatus.

This information shall be given in a language acceptable to the country where the apparatus is intended to be used. The important safety instructions shall be entitled "Important Safety Instructions". The following safety instructions shall be included where applicable, and, when used, shall be verbatim as follows. Additional safety information may be included by adding statements after the end of the following safety instruction list. At the manufacturer's option, a picture or drawing that illustrates the intent of a specific safety instruction may be placed immediately adjacent to that safety instruction:

Read these instructions.
Keep these instructions.
Heed all warnings.
Follow all instructions.



1 Do not use this apparatus near water.

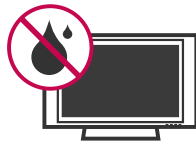

2 Clean only with dry cloth.



3 Do not block any ventilation openings. Install in accordance with the manufacturer's instructions.



4 Do not install near any heat sources such as radiators, heat registers, stoves, or other apparatus (including amplifiers) that produce heat.



5 Do not defeat the safety purpose of the polarized or grounding-type plug. A polarized plug has two blades with one wider than the other. A grounding type plug has two blades and a third grounding prong. The wide blade or the third prong are provided for your safety. If the provided plug does not fit into your outlet, consult an electrician for replacement of the obsolete outlet.



6 Protect the power cord from being walked on or pinched particularly at plugs, convenience receptacles, and the point where they exit from the apparatus.



7 Only use attachments/accessories specified by the manufacturer.



8 Unplug this apparatus when unused for long periods of time.

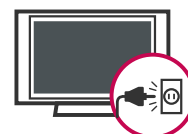

- 9 Use only with the cart, stand, tripod, bracket, or table specified by the manufacturer, or sold with the apparatus. When a cart is used, use caution when moving the cart/apparatus combination to avoid injury from tip-over.

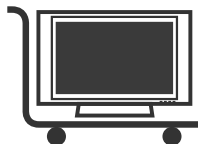

S3125A

- 10 Never touch this apparatus or antenna during a thunder or lightning storm.

- 11 Do not allow a impact shock or any objects to fall into the product, and do not drop onto the screen with something.

- 12 Refer all servicing to qualified service personnel. Servicing is required when the apparatus has been damaged in any way, such as power-supply cord or plug is damaged, liquid has been spilled or objects have fallen into the apparatus, the apparatus has exposed to rain or moisture, does not operate normally, or has been dropped.

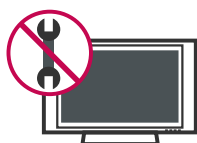

- 13 CAUTION concerning the Power Cord : Most appliances recommend they be placed upon a dedicated circuit; that is, a single outlet circuit which powers only that appliance and has no additional outlets or branch circuits. Check the specification page of this owner's manual to be certain.

Do not overload wall outlets. Overloaded wall outlets, loose or damaged wall outlets, extension cords, frayed power cords, or damaged or cracked wire insulation are dangerous. Any of these conditions could result in electric shock or fire. Periodically examine the cord of your appliance, and if its appearance indicates damage or deterioration, unplug it, discontinue use

of the appliance, and have the cord replaced with an exact replacement part by an authorized servicer. Protect the power cord from physical or mechanical abuse, such as being twisted, kinked, pinched, closed in a door, or walked upon. Pay particular attention to plugs, wall outlets, and the point where the cord exits the appliance.

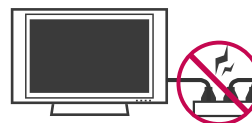

- 14 Outdoor use marking :
WARNING - To reduce the risk of fire or electric shock, do not expose this appliance to rain or moisture.



- 15 Wet Location Marking : Apparatus shall not be exposed to dripping or splashing and no objects filled with liquids, such as vases, shall be placed on or over apparatus.



16 GROUNDING

Ensure that you connect the earth ground wire to prevent possible electric shock. If grounding methods are not possible, have a qualified electrician install a separate circuit breaker.

Do not try to ground the unit by connecting it to telephone wires, lightening rods, or gas pipes.

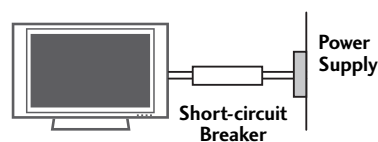

- 17 DISCONNECTING DEVICE FROM MAINS
Mains plug is the disconnecting device. The plug must remain readily operable.

CONTENTS

WARNING / CAUTION	1
SAFETY INSTRUCTIONS	2
FEATURE OF THIS TV	6

PREPARATION

Accessories	7
Front Panel Information	8
Back Panel Information	10
Stand Installation	12
VESA Wall Mounting	13
Desktop Pedestal Installation	13
Back Cover for Wire Arrangement	14
Attaching the TV to a Wall	16
Antenna or Cable Connection	17

EXTERNAL EQUIPMENT SETUP

HD Receiver Setup	18
DVD Setup	21
VCR Setup	23
Other A/V Source Setup	25
PC Setup	26
Audio Out Setup	31

WATCHING TV / CHANNEL CONTROL

Remote Control Functions	32
Turning On TV	34
Channel Selection	34
Volume Adjustment	34
On-Screen Menus Selection	35
Channel Setup	
- Auto Scan (Auto Tuning)	36
- Add / Delete Channel (Manual Tuning)	37
- Channel Editing	38
Input List	39
Simplink	40
Input Label	42
Key Lock	43

PICTURE CONTROL

Picture Size (Aspect Ratio) Control	44
Preset Picture Settings	
- Picture Mode - Preset	45
- Color Tone - Preset	46
Manual Picture Adjustment	
- Picture Mode - User Mode	47
- Color Tone - User Mode	48
Digital Booster	49
Advanced - Cinema 3:2 Pulldown Mode	50
Advanced - Black (Darkness) Level	51
Picture Reset	52
Image Sticking Minimization (ISM) Method	53
Low - Power Picture Mode	54

SOUND & LANGUAGE CONTROL

Auto Volume Leveller (Auto Volume)	55
Preset Sound Settings (Sound Mode)	56
Sound Setting Adjustment - User Mode	57
Balance	58
TV Speakers On/Off Setup	59
Stereo/SAP Broadcasts Setup	60
Audio Language	61
On-Screen Menus Language Selection	62
Caption Mode	63
- Analog Broadcasting System Captions	64
- Digital Broadcasting System Captions	65
- Caption Option	66

TIME SETTING

Clock Setting	
- Auto Clock Setup	67
- Manual Clock Setup	68
Auto On/Off Timer Setting	69
Sleep Timer Setting	70
Auto Shut-off Setting	71

PARENTAL CONTROL / RATINGS

Set Password & Lock System	72
Channel Blocking	74
External Input Blocking	74
Movie & TV Rating	75

APPENDIX

Troubleshooting	78
Maintenance	80
Product Specifications	81
Programming the Remote Control	83
IR Codes	87
External Control Through RS-232C	89
Open Source License	96

FEATURE OF THIS TV



High-definition television. High-resolution digital television broadcast and playback system composed of roughly a million or more pixels, 16:9 aspect-ratio screens, and AC3 digital audio. A subset of digital television, HDTV formats include 1080i and 720p resolutions.



With HDMI CEC support of Zenith's audio/video device connected to the HDMI (high-definition multimedia interface), Zenith TV with this logo works easily with one remote control.



Manufactured under license from Dolby Laboratories. "Dolby" and the double-D symbol are trademarks of Dolby Laboratories.



 is a trademark of SRS Labs, Inc. TruSurround XT technology is incorporated under license from SRS Labs, Inc.



It has 2 HDMI ports that connect audio and video devices with one cable and produces the highest quality digital images and sound.

FOR LCD TV

- If the TV feels cold to the touch, there may be a small "flicker" when it is turned on. This is normal, there is nothing wrong with TV.
- Some minute dot defects may be visible on the screen, appearing as tiny red, green, or blue spots. However, they have no adverse effect on the monitor's performance.
- Avoid touching the LCD screen or holding your finger(s) against it for long periods of time. Doing so may produce some temporary distortion effects on the screen.

On Disposal

- a. The fluorescent lamp used in this product contains a small amount of mercury.
- b. Do not dispose of this product with general household waste.
- c. Disposal of this product must be carried out in accordance to the regulations of your local authority.

PREPARATION

ACCESSORIES

Ensure that the following accessories are included with your product. If an accessory is missing, please contact the dealer where you purchased the product.

User must use shielded signal interface cables (D-sub 15 pin cable) with ferrite cores to maintain standard compliance for the product.

The accessories can be different from the figures shown here.

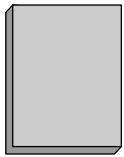

Owner's Manual



CD Manual

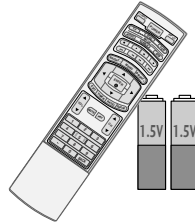

Remote Control,
Batteries



Power Cord



75ohm Round Cable

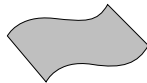

Polishing Cloth

* Slightly wipe stained spot on the exterior only with the polishing cloth for the product exterior if there is stain or fingerprint on surface of the exterior.

* Do not wipe roughly when removing stain. Please be cautious of that excessive pressure may cause scratch or discoloration.

For Plasma TV models

This feature is not available for all models



2-Eye-bolts
(Refer to p.16)



2-Wall brackets
(Refer to p.16)

42PC3DB only



2-Bolts for stand assembly
(Refer to p.12)

Option Extras

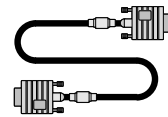

D-sub 15 pin Cable

For LCD TV models

This feature is not available for all models



Cable
Management



2- TV Bracket Bolts
(Refer to p.16)



2- TV Brackets,
2- Wall Brackets
(Refer to p.16)



Twist Holder
Arrange the wires with
the twist holder.

32/37 inches only



4-Bolts for stand assembly
(Refer to p.12)

PREPARATION

FRONT PANEL INFORMATION

- Here shown may be somewhat different from your TV.
- **NOTE:** If your product has a protection tape attached, remove the tape. And then wipe the product with a cloth (If a polishing cloth is included with your product, use it).

Plasma TV Model

42/50PC5D

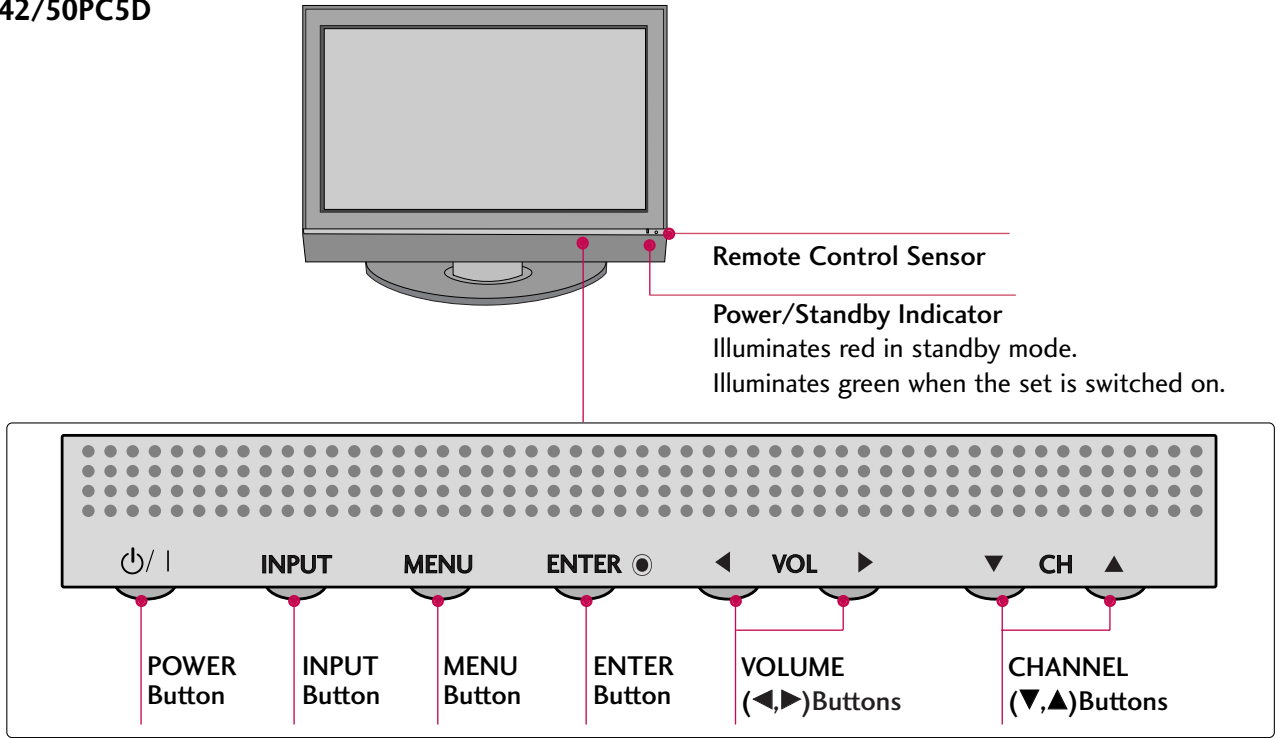

42/50PC3DB

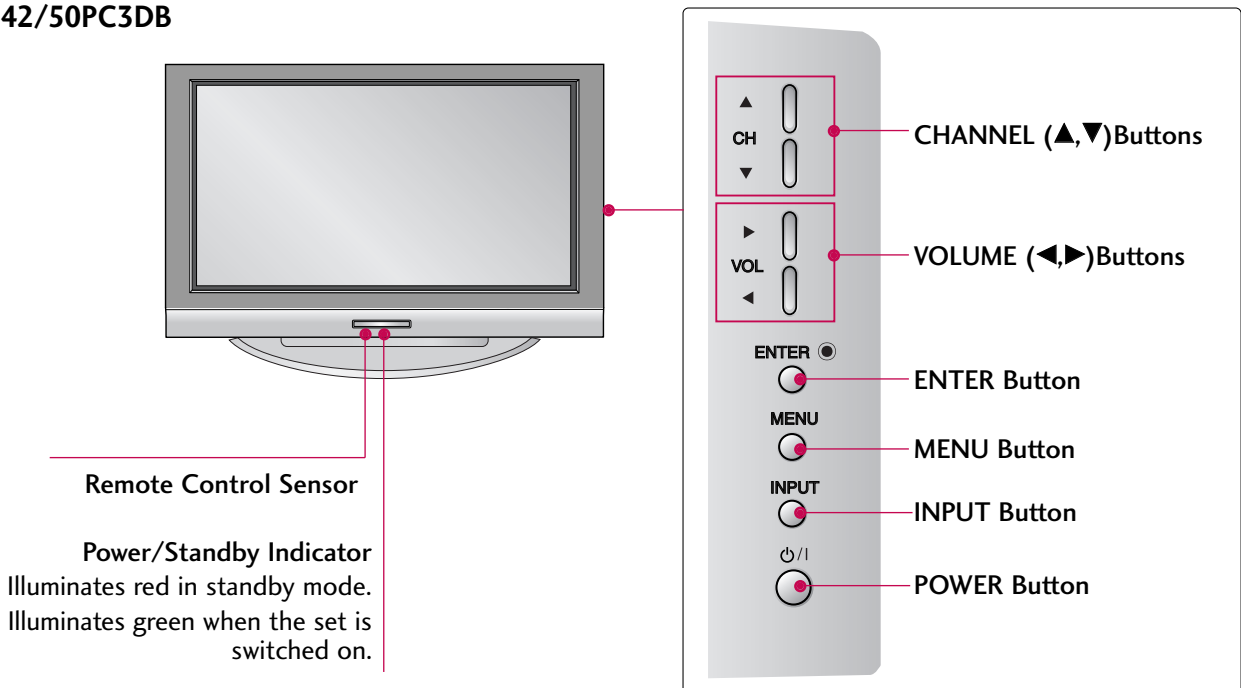

LCD TV Model

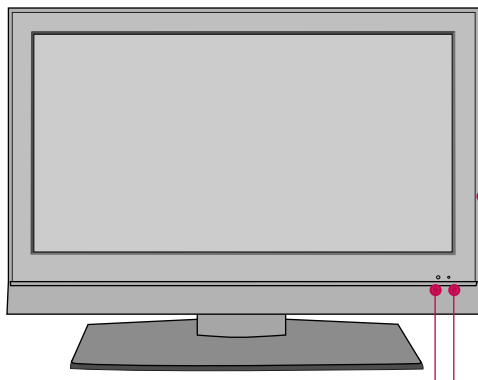

Remote Control Sensor

Power/Standby Indicator
Illuminates red in standby mode.
Illuminates green when the set is
switched on.

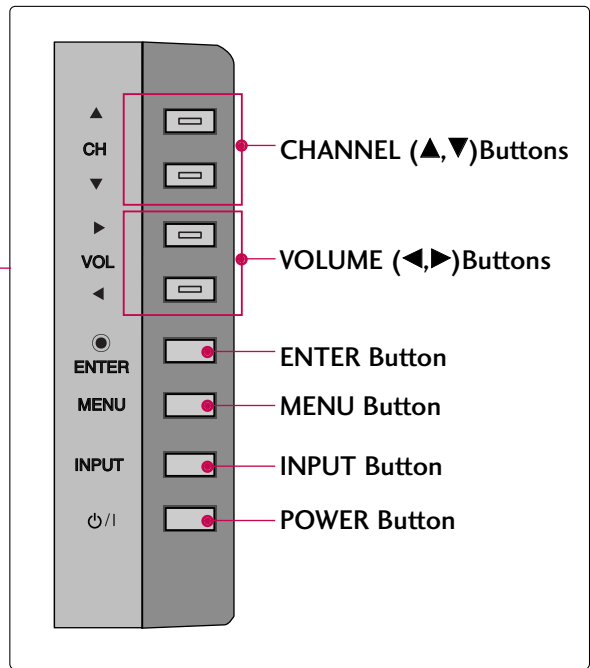

CHANNEL (▲,▼)Buttons

VOLUME (◀,▶)Buttons

ENTER Button

MENU Button

INPUT Button

POWER Button

PREPARATION

BACK PANEL INFORMATION

Here shown may be somewhat different from your TV.

Plasma TV Model

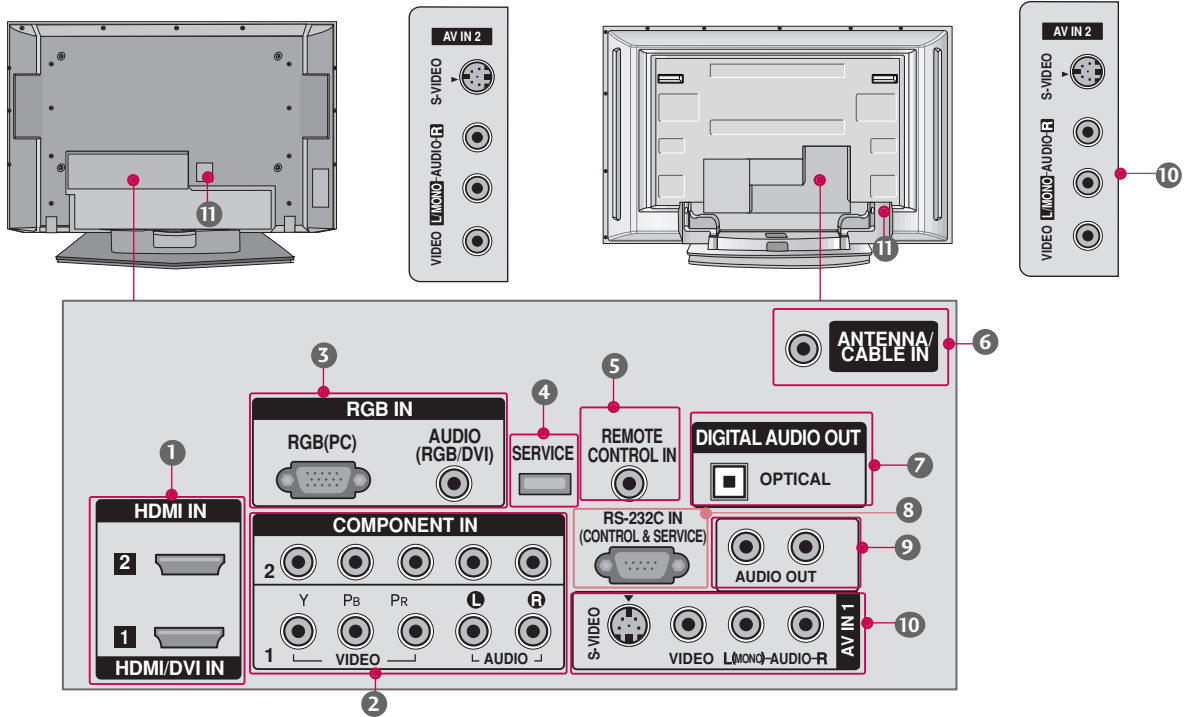

LCD TV Model

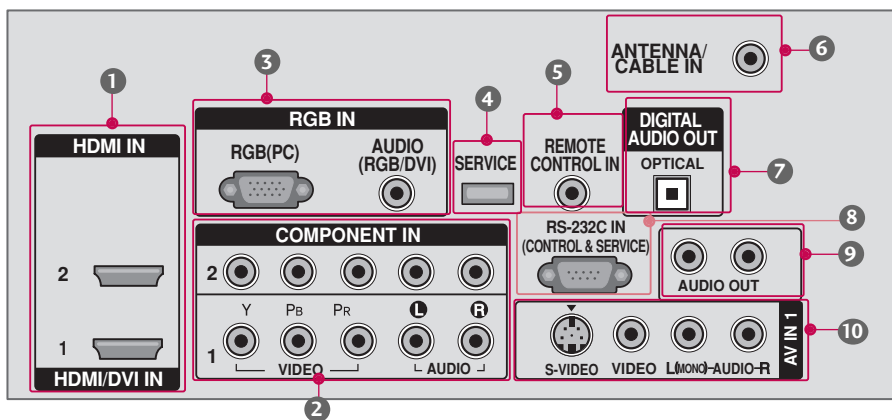
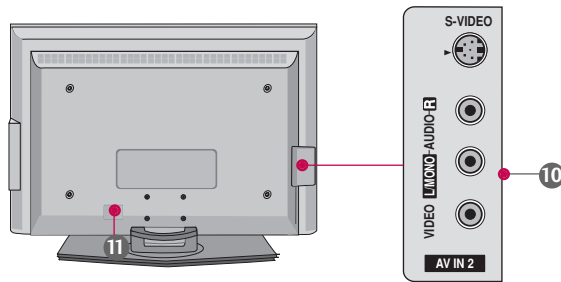

- ① **HDMI/DVI IN 1, HDMI IN 2**
Connect a HDMI (DVI) connection to either input.
- ② **COMPONENT IN**
Connect a component video/audio device to these jacks.
- ③ **RGB (PC)**
Connect the output from a PC.
AUDIO (RGB/DVI)
Connect the audio from a PC or DTV.
- ④ **SERVICE**
- ⑤ **Remote Control Port**
Connect a wired remote control.
- ⑥ **ANTENNA/CABLE IN**
Connect over-the air signals to this jack.
Connect cable signals to this jack.
- ⑦ **DIGITAL AUDIO OUT**
Connect digital audio from various types of equipment.
Note: In standby mode, these ports do not work.
- ⑧ **RS-232C IN (CONTROL & SERVICE) PORT**
For external control devices.
- ⑨ **AUDIO OUT**
Connect analog audio to various types of equipment.
- ⑩ **AV (Audio/Video) IN**
Connect audio/video output from an external device to these jacks.
S-VIDEO
Connect S-Video out from an S-VIDEO device.
- Ⓜ **Power Cord Socket**
For operation with AC power.
Caution: Never attempt to operate the TV on DC power.

PREPARATION

STAND INSTALLATION

■ Here shown may be somewhat different from your TV.

32/42LC7D only

- 1 Carefully place the product screen side down on a cushioned surface that will protect product and screen from damage.

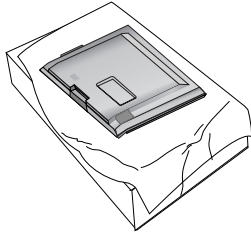

- 2 Assemble the product stand with the product as shown.

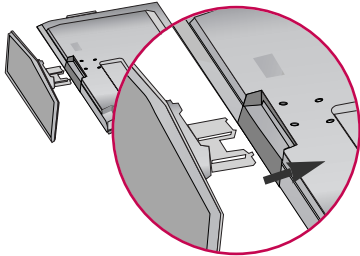

- 3 Securely install the 4 bolts provided.

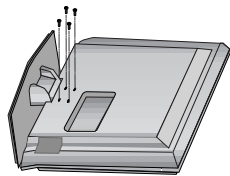

42PC3DB only

- 1 Place the set with the screen facing down on a cushion or soft cloth as shown. Before unfolding the stand, please make sure two locks (A) on the bottom of the stand push outward.

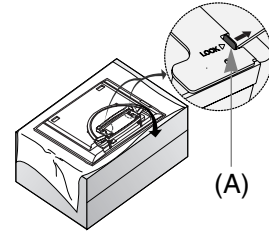

- 2 Pull the stand out as shown. After unfolding the stand, please insert and tighten the screws (provided as parts of the product) in the holes (B) on the bottom of the stand.

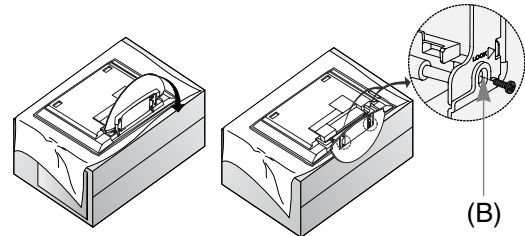

- 3 When connecting cables to the set, Do not disengage the lock (C). This may cause the set to fall, causing serious bodily injury and serious damage to the set.

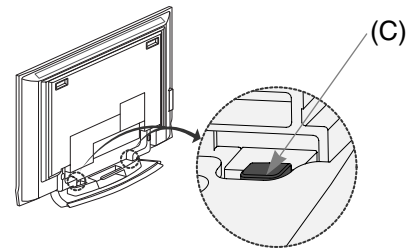

* Image shown here may be slightly different from your set.

When closing the stand for storage

- First remove the screws in the holes (B) on the bottom of the stand. And then pull two Hooks (D) of the stand bottom and fold the stand into the back of the set.
- After folding, push the two Locks (A) of the stand bottom outward.

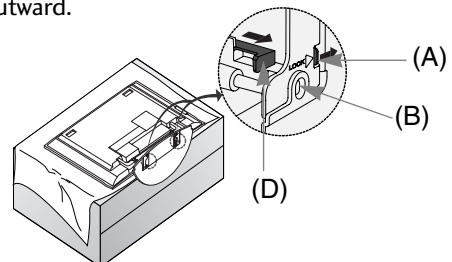

VESA WALL MOUNTING

This product accepts a VESA-compliant mounting interface pad. (optional)
 There 4 threaded holes are available for attaching the bracket.

Plasma TV Model

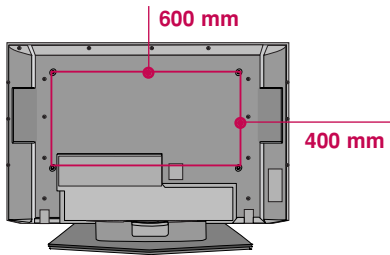

LCD TV Model

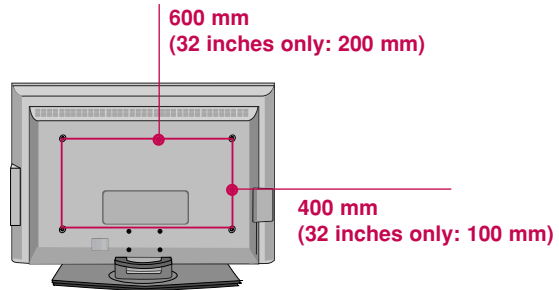

NOTE

- ▶ Screw length needed depends on the wall mount used. For further information, refer to the VESA Wall Mounting Instruction Guide.

DESKTOP PEDESTAL INSTALLATION

For proper ventilation, allow a clearance of 4 inches on all four sides from the wall.

Plasma TV Model

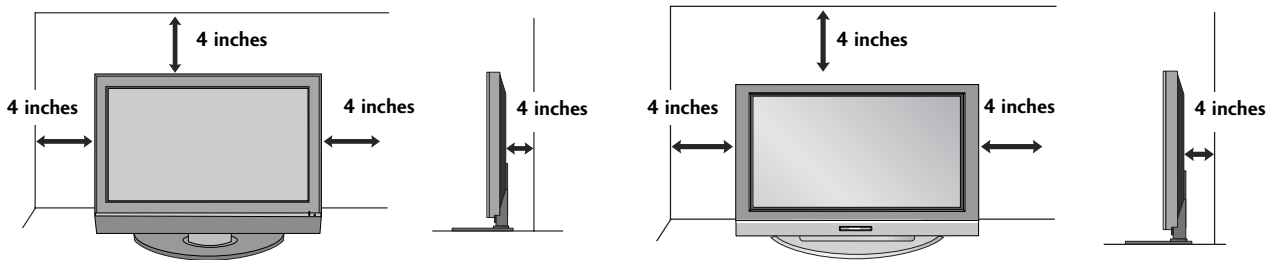

LCD TV Model

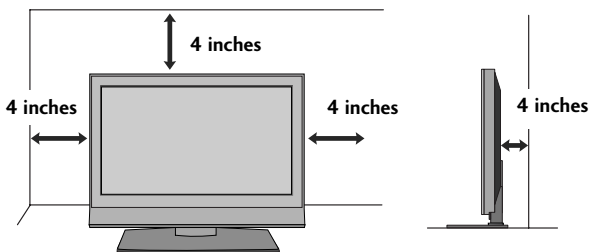

CAUTION ▶ Ensure adequate ventilation by following the clearance recommendations.

PREPARATION

BACK COVER FOR WIRE ARRANGEMENT

■ Here shown may be somewhat different from your TV.

Plasma TV Model

42/50LC5D only

- 1 Hold the **CABLE MANAGEMENT** with both hands and pull it backward as shown.

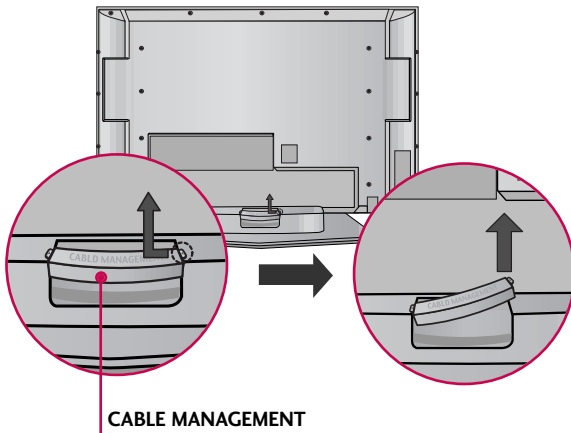

- 2 Connect the cables as necessary.
To connect an additional equipment, see the **EXTERNAL EQUIPMENT SETUP** section.

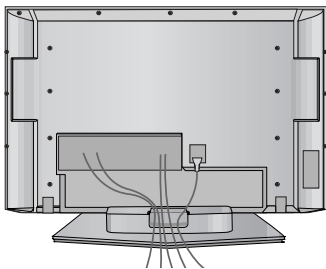

- 3 Install the **CABLE MANAGEMENT** as shown.

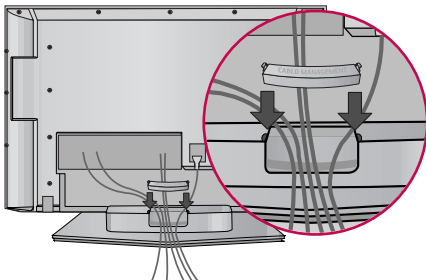

50PC3DB only

- 1 Hold the **CABLE MANAGEMENT** with both hands and pull it backward as shown.

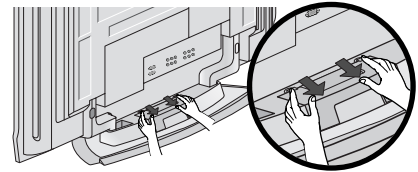

- 2 Connect the cables as necessary.
To connect an additional equipment, see the **EXTERNAL EQUIPMENT SETUP** section.

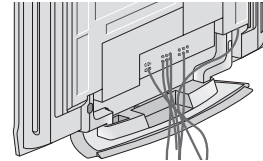

- 3 Install the **CABLE MANAGEMENT** as shown.

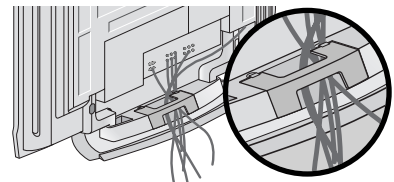

42PC3DB only

Arrange the cables as shown.

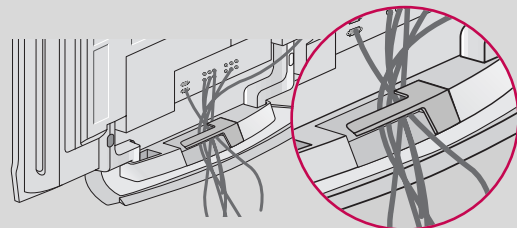

LCD TV Model

- 1 Connect the cables as necessary.
To connect an additional equipment, see the **EXTERNAL EQUIPMENT SETUP** section.

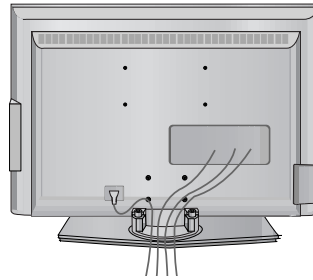

- 2 Install the **CABLE MANAGEMENT** as shown.

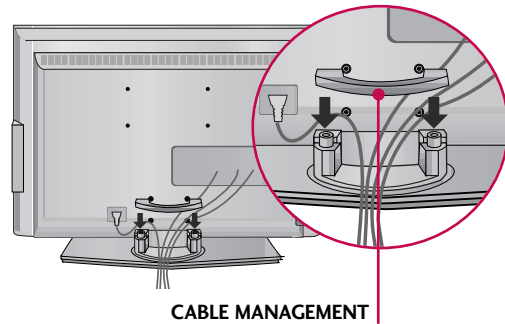

- 3 Bundle the cables using the supplied **TWISTER HOLDER**.
(This feature is not available for all models.)

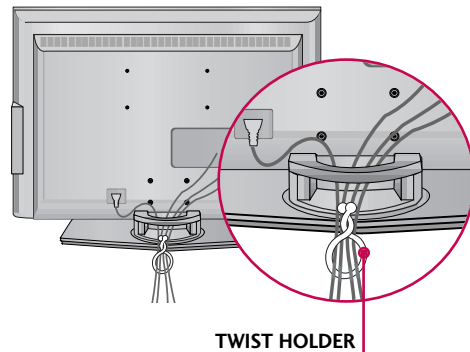

! NOTE

- ▶ Do not hold the **CABLE MANAGEMENT** when moving the product.
- If the product is dropped, you may be injured or the product may be broken.

How to remove the **CABLE MANAGEMENT**

- ▶ Hold the **CABLE MANAGEMENT** with both hands and pull it backward.

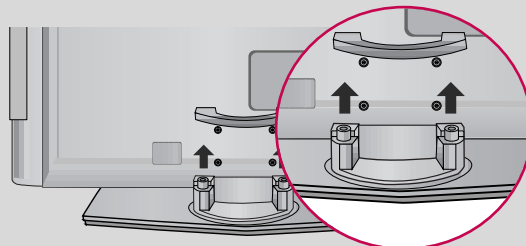

PREPARATION

ATTACHING THE TV TO A WALL

- This feature is not available for all models.
- Here shown may be somewhat different from your TV.

We recommend that you set up the TV close to a wall so it cannot fall over if pushed backwards. Additionally, we recommend that the TV be attached to a wall so it cannot be pulled in a forward direction, potentially causing injury or damaging the product.

Caution: Please make sure that children don't climb on or hang from the TV.

Plasma TV Model

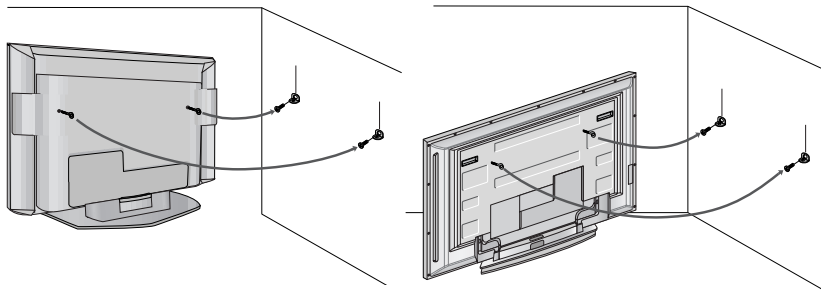

LCD TV Model

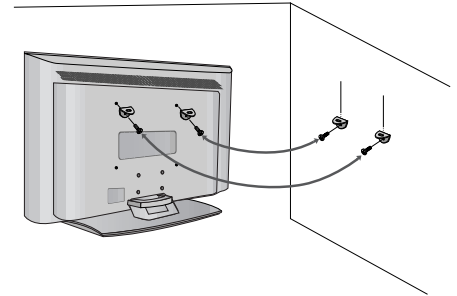

- Insert the eye-bolts (or TV brackets and bolts) to tighten the product to the wall as shown in the picture.
 - * If your product has the bolts in the eye-bolts position before inserting the eye-bolts, loosen the bolts.
- Secure the wall brackets with the bolts (not provided as parts of the product, must purchase separately) to the wall. Match the height of the bracket that is mounted on the wall to the holes in the product.
- Ensure the eye-bolts or brackets are tightened securely.

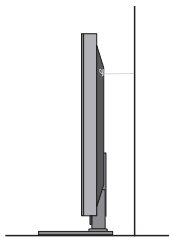

- Use a sturdy rope (not provided as parts of the product, must purchase separately) to tie the product. It is safer to tie the rope so it becomes horizontal between the wall and the product.

ANTENNA OR CABLE CONNECTION

▪ Here shown may be somewhat different from your TV.

1. Antenna (Analog or Digital)

Wall Antenna Socket or Outdoor Antenna without a Cable Box Connections.

For optimum picture quality, adjust antenna direction if needed.

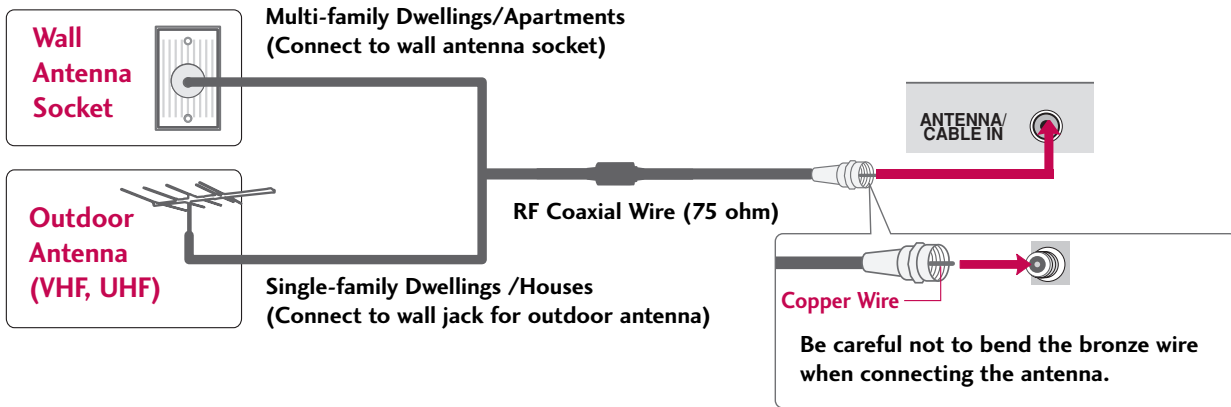

2. Cable

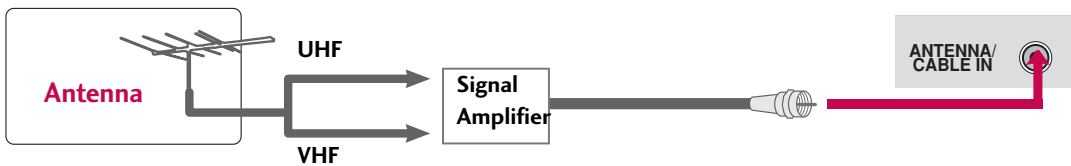
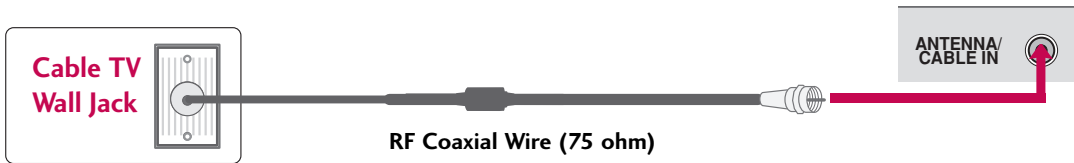

- To improve the picture quality in a poor signal area, please purchase a signal amplifier and install properly.
- If the antenna needs to be split for two TV's, install a 2-Way Signal Splitter.
- If the antenna is not installed properly, contact your dealer for assistance.

NOTE ▶ The TV will let you know when the analog, cable, and digital channel scans are complete.

EXTERNAL EQUIPMENT SETUP

- To prevent the equipment damage, never plug in any power cords until you have finished connecting all equipment.
- This part of EXTERNAL EQUIPMENT SETUP mainly use picture for LCD TV model.

HD RECEIVER SETUP

This TV can receive Digital Over-the-air/Cable signals without an external digital set-top box. However, if you do receive digital signals from a digital set-top box or other digital external device, refer to the figure as shown below.

When connecting Component cable

1. How to connect

- 1 Connect the video outputs (Y, PB, PR) of the digital set top box to the **COMPONENT IN VIDEO 1** jacks on the set. Match the jack colors (Y = green, PB = blue, and PR = red).
- 2 Connect the audio output of the digital set-top box to the **COMPONENT IN AUDIO 1** jacks on the set.

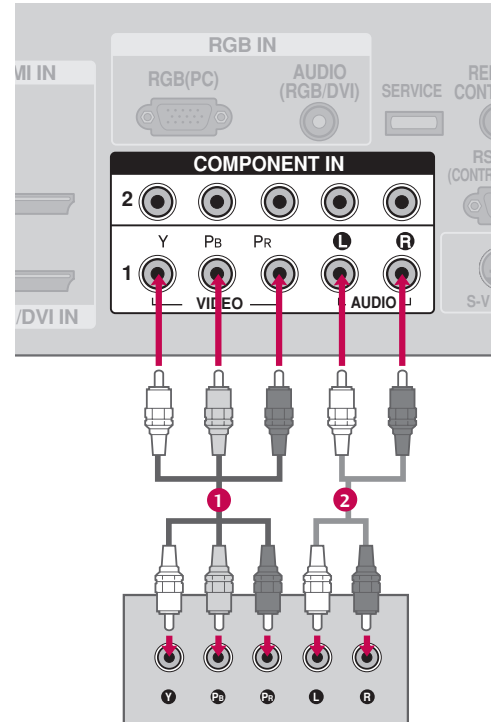

2. How to use

- Turn on the digital set-top box.
(Refer to the owner's manual for the digital set-top box. operation)
- Select **Component 1** input source by using the **INPUT** button on the remote control.
- If connected to **COMPONENT IN2** input, select **Component 2** input source.

Signal	Component 1/2	HDMI1/2
480i	Yes	No
480p	Yes	Yes
720p	Yes	Yes
1080i	Yes	Yes
1080p	Yes	Yes

Y, CB/PB, CR/PR

Resolution	Horizontal Frequency(KHz)	Vertical Frequency(Hz)
720x480i	15.73	59.94
	15.73	60.00
720x480p	31.47	59.94
	31.50	60.00
1280x720p	44.96	59.94
	45.00	60.00
1920x1080i	33.72	59.94
	33.75	60.00
1920x1080p	26.97	23.976
	27.00	24.00
	33.71	29.97
	33.75	30.00
	67.432	59.94
	67.50	60.00

When connecting HDMI cable

1. How to connect

- 1 Connect the digital set-top box to **HDMI/DVI IN 1** or **HDMI IN 2** jack on the set.
- 2 No separated audio connection is necessary. HDMI supports both audio and video.

2. How to use

- Turn on the digital set-top box.
(Refer to the owner's manual for the digital set-top box.)
- Select **HDMI1** or **HDMI2** input source by using the **INPUT** button on the remote control.

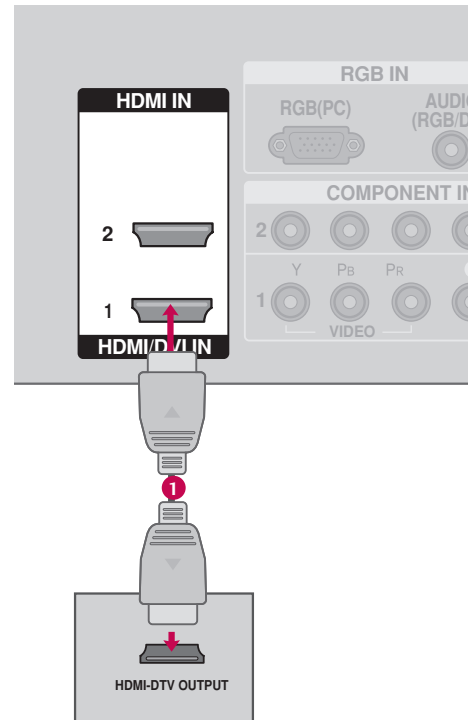

HDMI1/DVI-DTV, HDMI2-DTV mode

Resolution	Horizontal Frequency(KHz)	Vertical Frequency(Hz)
720x480p	31.47	59.94
	31.50	60.00
1280x720p	44.96	59.94
	45.00	60.00
1920x1080i	33.72	59.94
	33.75	60.00
1920x1080p	26.97	23.976
	27.00	24.00
	33.71	29.97
	33.75	30.00
	67.432	59.939
	67.50	60.00

EXTERNAL EQUIPMENT SETUP

When connecting HDMI to DVI cable

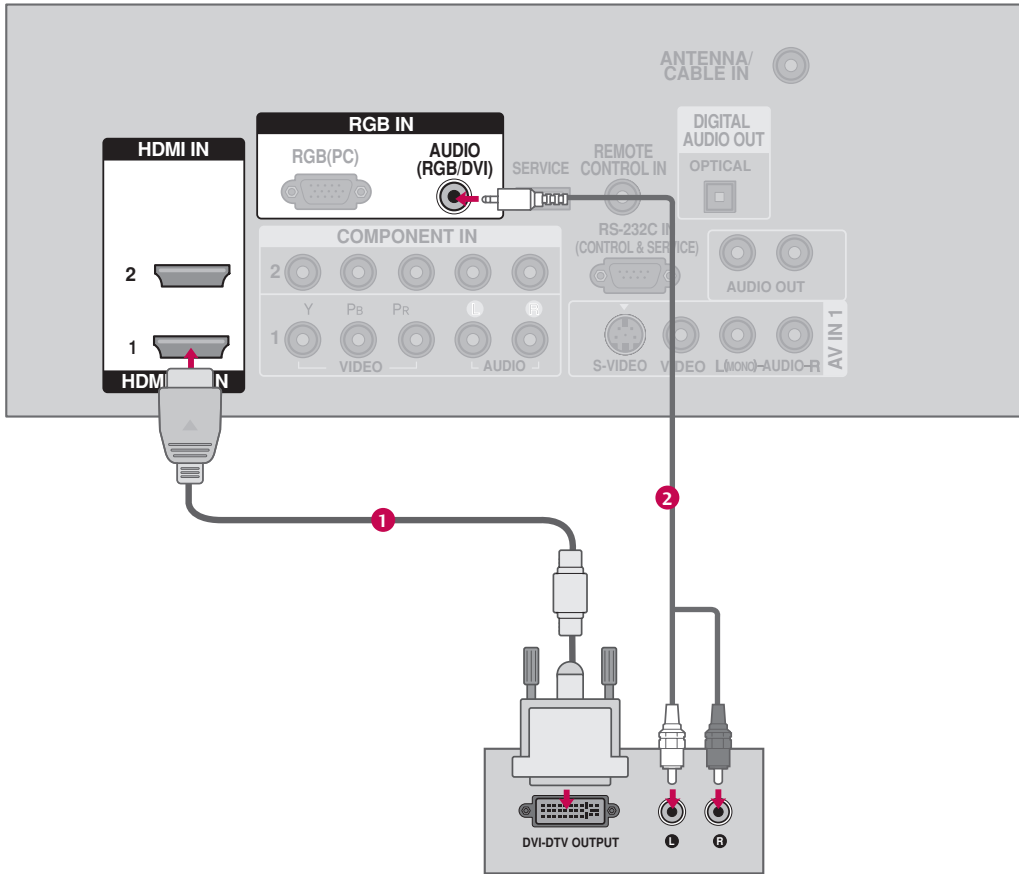

1. How to connect

- 1 Connect the DVI output of the digital set-top box to the **HDMI/DVI IN 1** jack on the set.
- 2 Connect the audio output of the digital set-top box to the **AUDIO (RGB/DVI)** jack on the set.

2. How to use

- Turn on the digital set-top box. (Refer to the owner's manual for the digital set-top box.)
- Select **HDMI1** input source by using the **INPUT** button on the remote control.

DVD SETUP

When connecting Component cable

1. How to connect

- 1 Connect the video outputs (Y, PB, PR) of the DVD to the **COMPONENT IN VIDEO1** jacks on the set.
Match the jack colors
(Y = green, PB = blue, and PR = red).
- 2 Connect the audio outputs of the DVD to the **COMPONENT IN AUDIO1** jacks on the set.

2. How to use

- Turn on the DVD player, insert a DVD.
- Select **Component 1** input source by using the **INPUT** button on the remote control.
- If connected to **COMPONENT IN 2** input, select **Component 2** input source.
- Refer to the DVD player's manual for operating instructions.

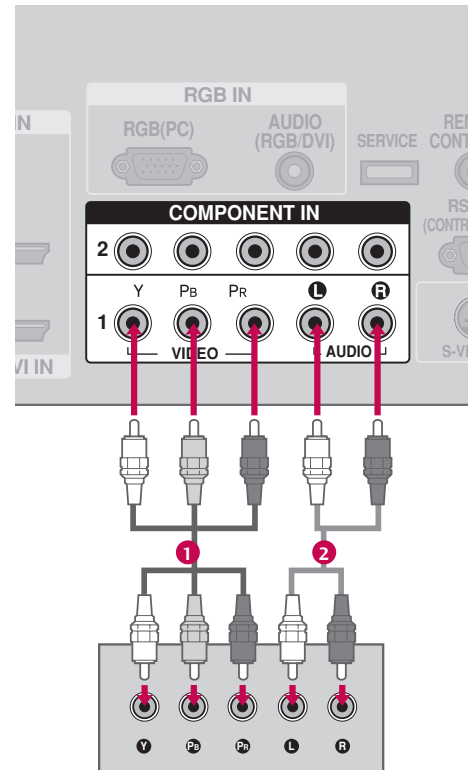

Component Input ports

To get better picture quality, connect a DVD player to the component input ports as shown below.

Component ports on the TV	Y	P _B	P _R
Video output ports on DVD player	Y	P _B	P _R
	Y	B-Y	R-Y
	Y	Cb	Cr
	Y	Pb	Pr

EXTERNAL EQUIPMENT SETUP

When connecting with an S-Video cable

1. How to connect

- 1 Connect the S-VIDEO output of the DVD to the S-VIDEO input on the set.
- 2 Connect the audio outputs of the DVD to the AUDIO input jacks on the set.

2. How to use

- Turn on the DVD player, insert a DVD.
- Select **AV1** input source by using the **INPUT** button on the remote control.
- If connected to **AV IN2**, select **AV2** input source.
- Refer to the DVD player's manual for operating instructions.

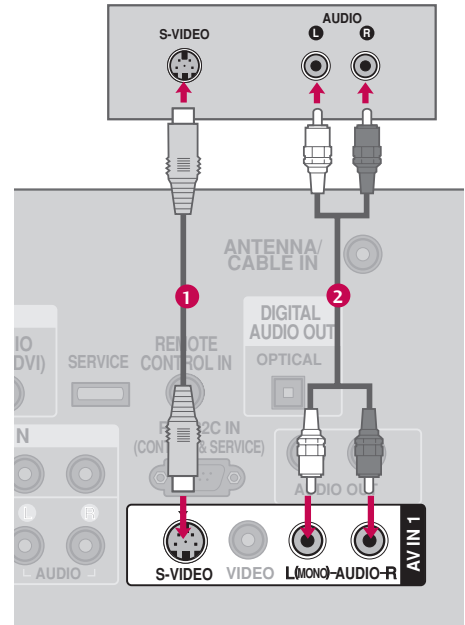

When connecting HDMI cable

1. How to connect

- 1 Connect the HDMI output of the DVD to the HDMI/DVI IN 1 or HDMI IN 2 jack on the set.
- 2 No separated audio connection is necessary. HDMI supports both audio and video.

2. How to use

- Select **HDMI1** or **HDMI2** input source by using the **INPUT** button on the remote control.
- Refer to the DVD player's manual for operating instructions.

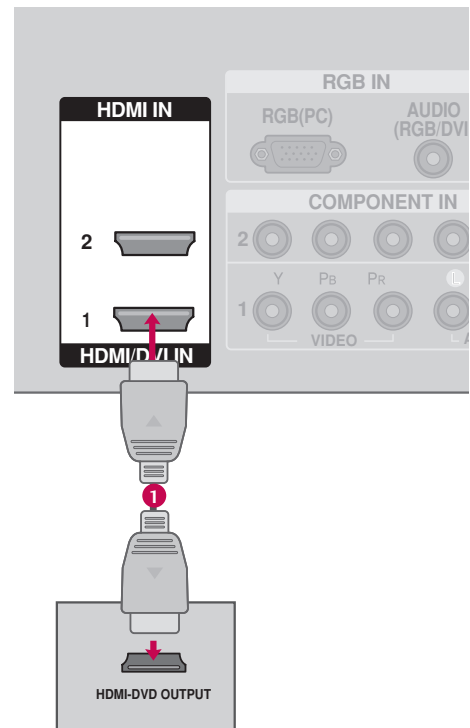

VCR SETUP

- To avoid picture noise (interference), leave an adequate distance between the VCR and TV.
- Use the ISM feature in the Option menu to avoid having a fixed image remain on the screen for a long period of time (Only Plasma TV model). If the 4:3 picture format is used; the fixed images on the sides of the screen may remain visible on the screen. This phenomenon is common to all manufactures and in consequence the manufactures warranty does not cover the product bearing this phenomenon.

When connecting with an antenna

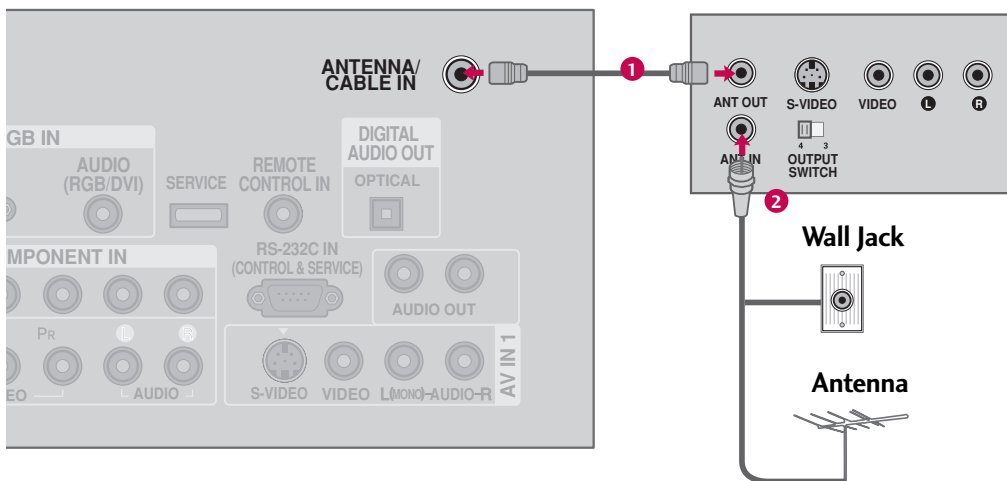

1. How to connect

- 1 Connect the RF antenna out socket of the VCR to the **ANTENNA/CABLE IN** socket on the set.
- 2 Connect the antenna cable to the RF antenna in socket of the VCR.

2. How to use

- Set VCR output switch to 3 or 4 and then tune TV to the same channel number.
- Insert a video tape into the VCR and press PLAY on the VCR. (Refer to the VCR owner's manual.)

EXTERNAL EQUIPMENT SETUP

When connecting with a RCA cable

1. How to connect

- 1 Connect the **AUDIO/VIDEO** jacks between TV and VCR. Match the jack colors (Video = yellow, Audio Left = white, and Audio Right = red)

2. How to use

- Insert a video tape into the VCR and press PLAY on the VCR. (Refer to the VCR owner's manual.)
- Select **AV1** input source by using the **INPUT** button on the remote control.
- If connected to **AV IN2**, select **AV2** input source.

NOTE ▶ If you have a mono VCR, connect the audio cable from the VCR to the **AUDIO L/MONO** jack of the set.

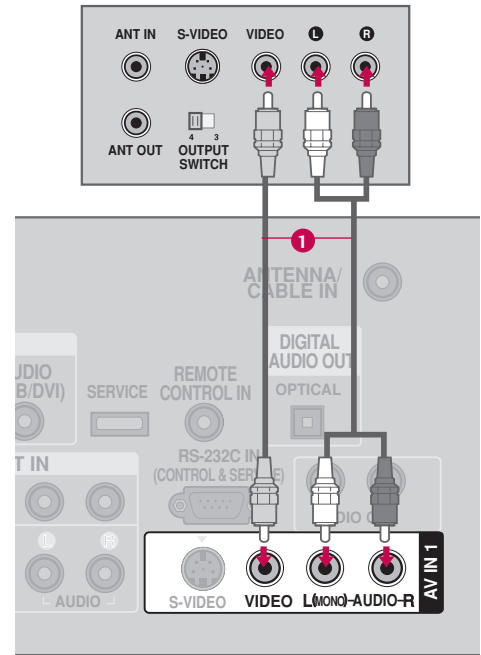

When connecting with an S-Video cable

1. How to connect

- 1 Connect the S-VIDEO output of the VCR to the **S-VIDEO** input on the set.
- 2 Connect the audio outputs of the VCR to the **AUDIO** input jacks on the set.

2. How to use

- Insert a video tape into the VCR and press PLAY on the VCR. (Refer to the VCR owner's manual.)
- Select **AV1** input source by using the **INPUT** button on the remote control.
- If connected to **AV IN2**, select **AV2** input source.

NOTE
▶ The picture quality is improved: compared to normal composite (RCA cable) input.

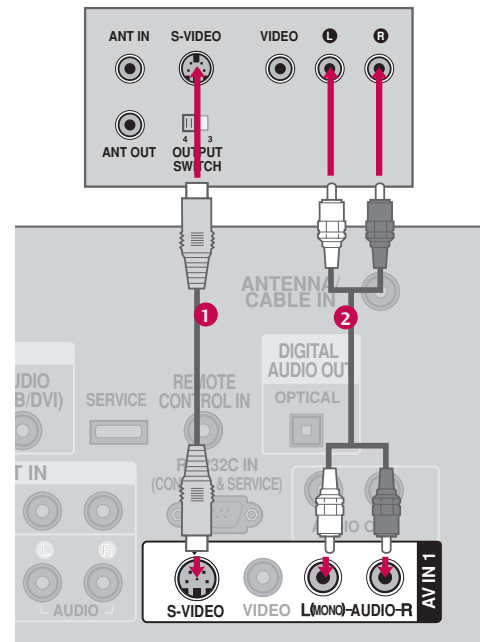

CAUTION

▶ Do not connect to both Video and S-Video at the same time. In the event that you connect both Video and the S-Video cables, only the S-Video will work.

OTHER A/V SOURCE SETUP

1. How to connect

- 1 Connect the **AUDIO/VIDEO** jacks between TV and external equipment. Match the jack colors. (Video = yellow, Audio Left = white, and Audio Right = red)

2. How to use

- Select **AV2** input source by using the **INPUT** button on the remote control.
- If connected to **AV IN1** input, select **AV1** input source.
- Operate the corresponding external equipment.

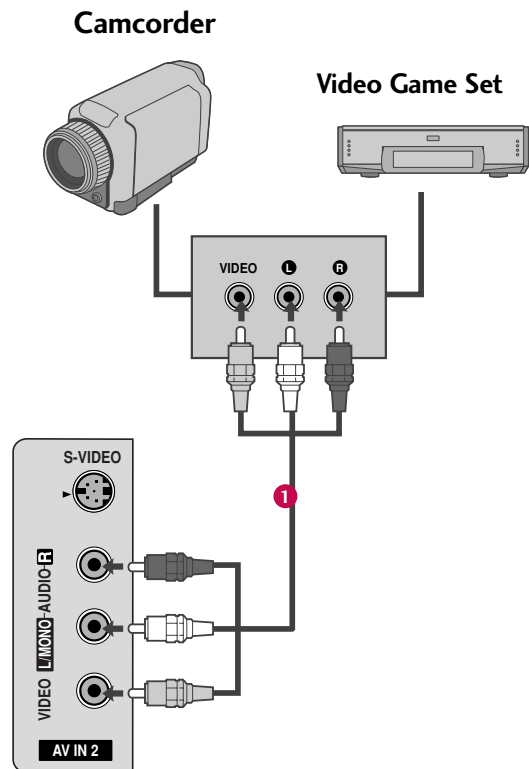

EXTERNAL EQUIPMENT SETUP

PC SETUP

This TV provides Plug and Play capability, meaning that the PC adjusts automatically to the TV's settings.

When connecting D-sub 15 pin cable

1. How to connect

- 1 Connect the RGB output of the PC to the **RGB (PC)** jack on the set.
- 2 Connect the PC audio output to the **AUDIO (RGB/DVI)** jack on the set.

2. How to use

- Turn on the PC and the TV.
- Select **RGB-PC** input source by using the **INPUT** button on the remote control.

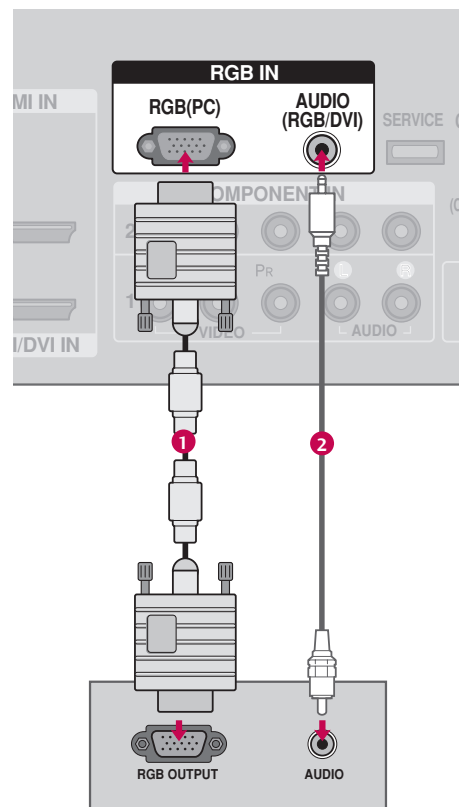

When connecting HDMI to DVI cable

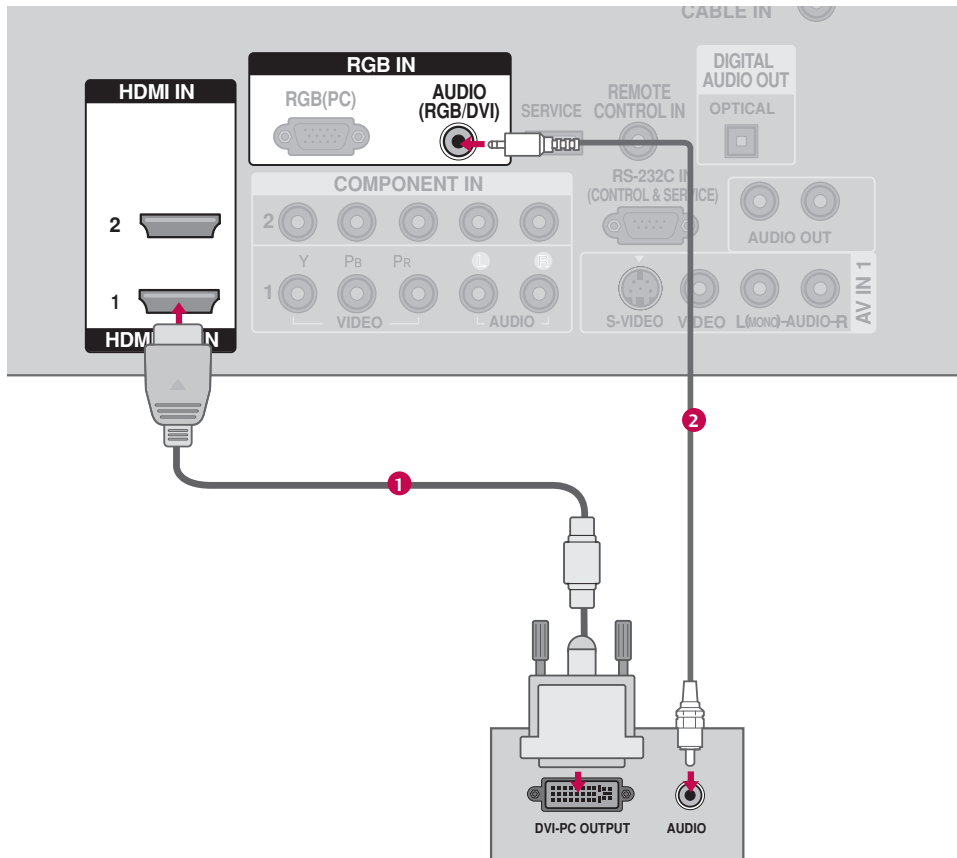

1. How to connect

- 1 Connect the DVI output of the PC to the **HDMI/DVI IN 1** jack on the set.
- 2 Connect the PC audio output to the **AUDIO (RGB/DVI)** jack on the set.

2. How to use

- Turn on the PC and the TV.
- Select **HDMI1** input source by using the **INPUT** button on the remote control.

EXTERNAL EQUIPMENT SETUP

! NOTES

- ▶ For LCD TV: To get the the best picture quality, adjust the PC graphics card to 1366x768.
- ▶ For Plasma TV TV: To get the the best picture quality, adjust the PC graphics card to 1360x768.
- ▶ Depending on the graphics card, DOS mode may not work if a HDMI to DVI Cable is in use.
- ▶ Check the image on your TV. There may be noise associated with the resolution, vertical pattern, contrast or brightness in PC mode. If noise is present, change the PC output to another resolution, change the refresh rate to another rate or adjust the brightness and contrast on the VIDEO menu until the picture is clear. If the refresh rate of the PC graphic card can not be changed, change the PC graphic card or consult the manufacturer of the PC graphic card.
- ▶ Avoid keeping a fixed image on the screen for a long period of time. The fixed image may become permanently imprinted on the screen.
- ▶ The synchronization input form for Horizontal and Vertical frequencies is separate.

Supported Display Specifications

RGB-PC, HDMI1/DVI-PC mode

Resolution	Horizontal Frequency(KHz)	Vertical Frequency(Hz)
640x350	31.469	70.08 ●
720x400	31.469	70.08 ●
640x480	31.469	59.94
800x600	37.879	60.31
1024x768	48.363	60.00
1280x768	47.776	59.87
1360x768	47.720	59.799
1366x768	47.130	59.65 ●

* RGB-PC mode only

* LCD TV only

! NOTE

- ▶ Depending on graphic card and signal status, there can be some shaking to find best picture in a little time.

Screen Setup for PC mode

Overview

When the RGB input of the set is connected to a PC Output, Select RGB-PC with using the **INPUT** button on the remote control.

When you change the resolution, select the proper resolution in present input to see the best picture appearance.

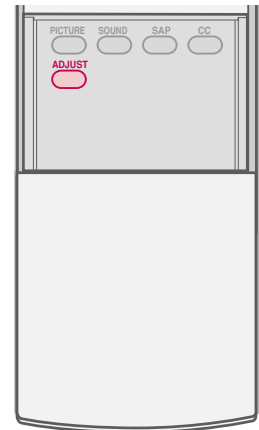

Adjustment for screen Resolution, Position, Size, and Phase

- 1 Press the **ADJUST** button and then use **▲** or **▼** button to select **Resolution**, **Position**, **Size**, or **Phase**.
- 2 Press the **ENTER** button and then use **▲ ▼ ◀ ▶** button to make appropriate adjustments.
 - The **Phase** adjustment range is **-16 ~ +16**.
 - The **Size** adjustment range is **-30 ~ +30**.
- 3 Press the **ENTER** button.

For Plasma TV

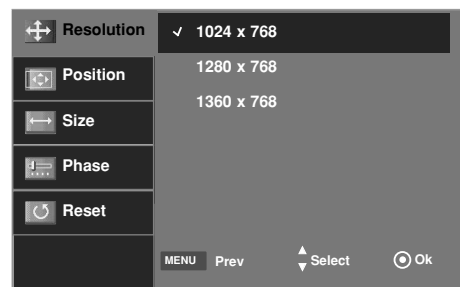

For LCD TV

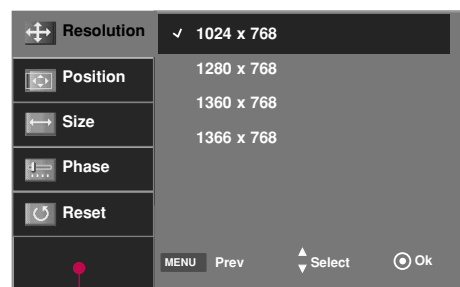

1 2 3

Resolution This function allows you select resolution of XGA/WXGA.

Position This function is to adjust picture to left/right and up/down as you prefer.

Size This function is to minimize any vertical bars or stripes visible on the screen background. And the horizontal screen size will also change.

Phase This function allows you to remove any horizontal noise and clear or sharpen the image of characters.

EXTERNAL EQUIPMENT SETUP

Initializing (Reset to original factory values)

To initialize the adjusted values.

- 1 Press the **ADJUST** button and then use **▲** or **▼** button to select **Reset**.
- 2 Press the **ENTER** button and then use **◀** or **▶** button to select **Yes**.
- 3 Press the **ENTER** button.

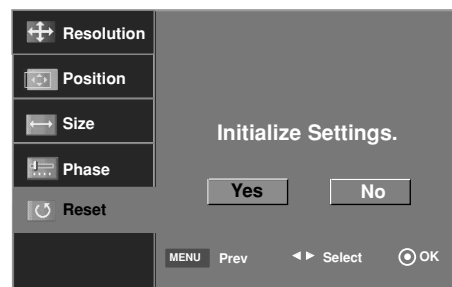

1 2 3

- You can also use the **PICTURE** menu to adjust **Screen**.

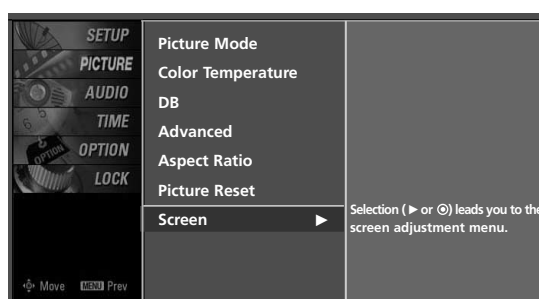
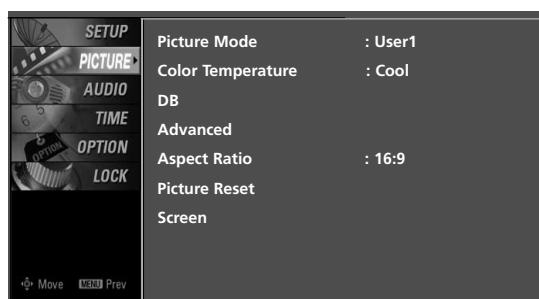

AUDIO OUT SETUP

Send the TV's audio to external audio equipment via the Audio Output port.

Analog

1. How to connect

- 1 Connect audio outputs to the TV's **AUDIO OUT** jacks.
- 2 Set the "TV Speaker option - Off" in the AUDIO menu. (▶ p.59). See the external audio equipment instruction manual for operation.

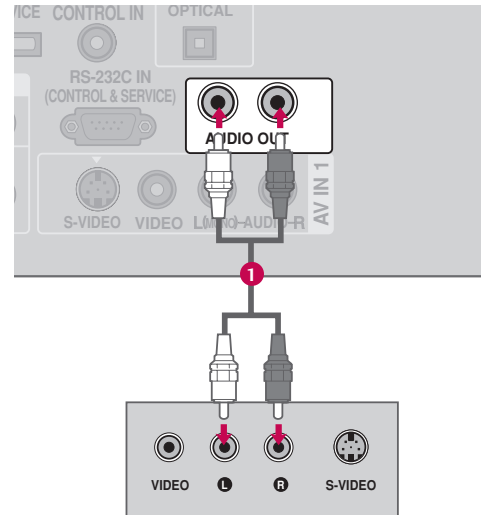

Digital

1. How to connect

- 1 Connect one end of the optical cable to the TV's **DIGITAL AUDIO OUT OPTICAL**.
- 2 Connect the other end of the optical cable to the digital audio input on the audio equipment.
- 3 Set the "TV Speaker option - Off" in the AUDIO menu. (▶ p.59). See the external audio equipment instruction manual for operation.

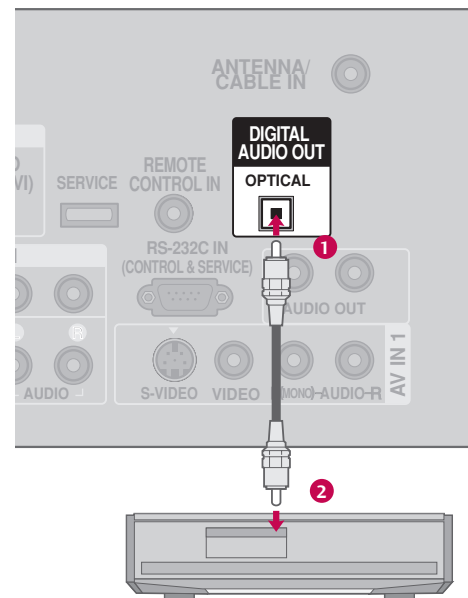

! NOTE

- ▶ When connecting with external audio equipments, such as amplifiers or speakers, please turn the TV speakers off. (▶ p.59)

! CAUTION

- ▶ Do not look into the optical output port. Looking at the laser beam may damage your vision.
- ▶ Block the SPDIF out (optical) about the contents with ACP(Audio Copy Protection) function.

WATCHING TV / CHANNEL CONTROL

REMOTE CONTROL FUNCTIONS

When using the remote control, aim it at the remote control sensor on the TV.

MODE Select the remote's operating mode. TV, DVD, VCR, AUDIO, CABLE, or STB.

VCR/DVD control buttons Control video cassette recorders or DVD players.

MENU Displays the main menu.

BRIGHT -/+ Adjust the brightness on screen.

THUMBSTICK (Up/Down/Left Right/ENTER) Navigate the on-screen menus and adjust the system settings to your preference.

EXIT Clear all on-screen displays and return to TV viewing from any menu.

TIMER Select the amount of time before your TV turns off automatically. ▶ p.70

RATIO Change the aspect ratio. ▶ p.44

SIMPLINK See a list of AV devices connected to TV. When you toggle this button, the SimpLink menu appears at the screen. ▶ p.41

VOLUME UP/DOWN Increase/decrease the sound level.

MUTE Switch the sound on or off. ▶ p.34

FAV Scroll through the programmed Favorite channels. ▶ p.38

CHANNEL UP/DOWN Select available channels.

NUMBER button

— (DASH) Used to enter a program number for multiple program channels such as 2-1, 2-2, etc.

BACK Tune to the last channel viewed.

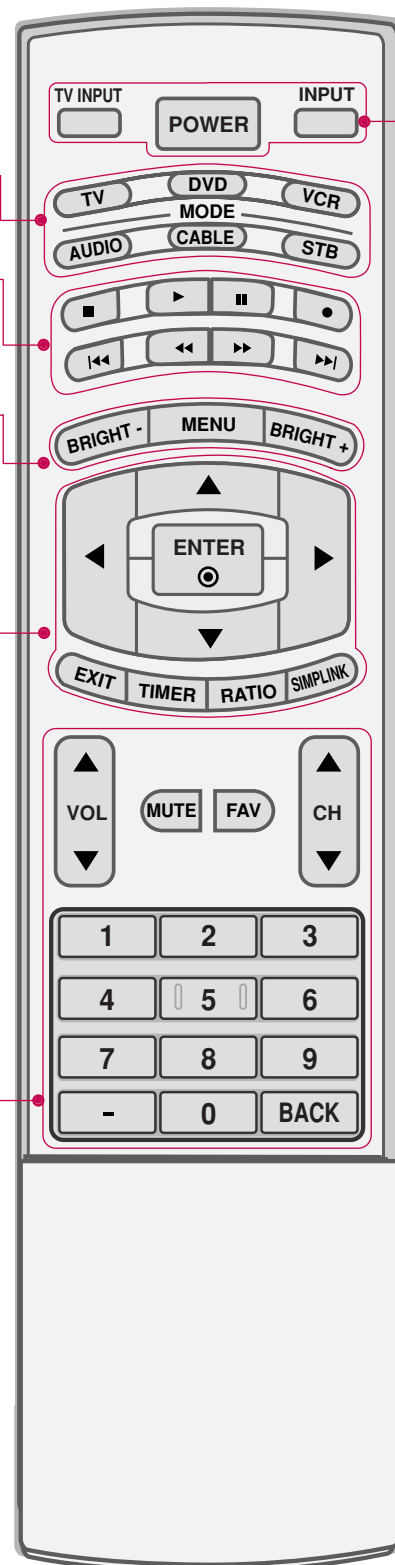

POWER Turns your TV or any other programmed equipment on or off, depending on the mode.

TV INPUT In AV 1-2, Component 1-2, RGB-PC, HDMI1, and HDMI2 input sources, screen returns to the last TV channel.

INPUT External input modes rotate in regular sequence: Antenna, Cable, AV1-2, Component 1-2, RGB-PC, HDMI1, and HDMI2.
(AV 1-2, Component 1-2, RGB-PC, HDMI1, and HDMI2 input sources are linked automatically, only if a device is connected.)

Inside the Sliding Cover

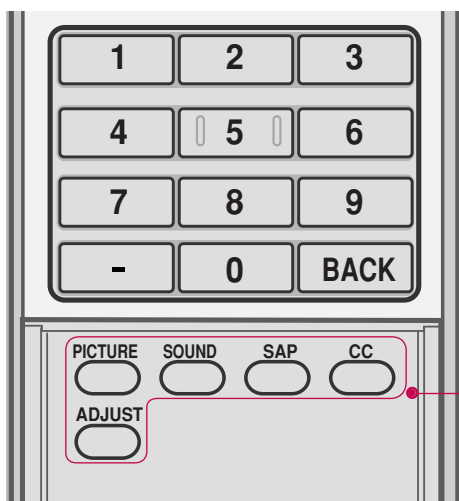

PICTURE Selects the factory preset picture depend on the viewing environment. ► p.45

SOUND Selects the factory preset sound for type of program. ► p.56

SAP •Analog mode: Selects MTS sound (Mono, Stereo, or a SAP) ► p.60
•DTV mode: Changes the audio language.

CC Select a closed caption. ► p.63

ADJUST Adjust the screen resolution, position, size and phase. ► p.29-30

Installing Batteries

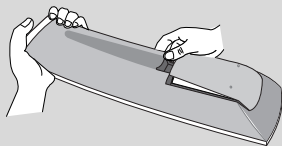

- Open the battery compartment cover on the back side and install the batteries matching correct polarity (+ with +, - with -).
- Install two 1.5V AA batteries. Don't mix old or used batteries with new ones.
- Close cover.

Remote control effective range

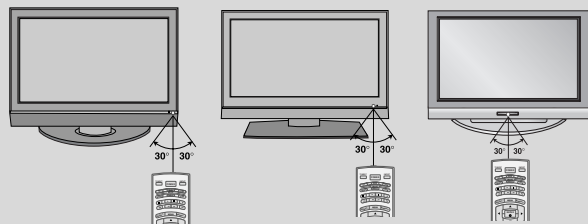

- Use a remote control up to 7 meters distance and 30 degree (left/right) within the receiving unit scope.
- Dispose of used batteries in a recycle bin to preserve environment.

WATCHING TV / CHANNEL CONTROL

TURNING ON TV

- 1 First, connect power cord correctly.
At this moment, the TV switches to standby mode.
 - In standby mode to turn TV on, press the ϕ /I , **INPUT**, **CH** (\blacktriangle or \blacktriangledown) button on the TV or press the **POWER**, **INPUT**, **TV INPUT**, **CH** (\blacktriangle or \blacktriangledown), **Number (0~9)** button on the remote control.
- 2 Select the viewing source by using the **TV INPUT**, **INPUT** button on the remote control.
 - This TV is programmed to remember which power state it was last set to, even if the power cord is out.
- 3 When finished using the TV, press the **POWER** button on the remote control. The TV reverts to standby mode.

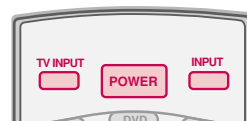

! NOTE

- ▶ If you intend to be away on vacation, disconnect the power plug from the wall power outlet.

CHANNEL SELECTION

- 1 Press the **CH** (\blacktriangle or \blacktriangledown) or **NUMBER** buttons to select a channel number.



VOLUME ADJUSTMENT

Adjust the volume to suit your personal preference.

- 1 Press the **VOL** (\blacktriangle or \blacktriangledown) button to adjust the volume.
- 2 If you want to switch the sound off, press the **MUTE** button.
- 3 You can cancel the Mute function by pressing the **MUTE** or **VOL** (\blacktriangle or \blacktriangledown) button.

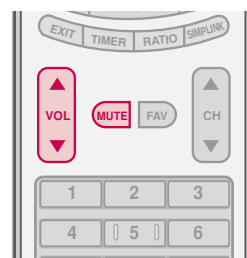

ON-SCREEN MENUS SELECTION

Your TV's OSD (On Screen Display) may differ slightly from what is shown in this manual.

- 1 Press the **MENU** button and then use **▲** or **▼** button to select the each menu.
- 2 Press the **▶** button and then use **▲ ▼ ◀ ▶** button to display the available menus.

SETUP

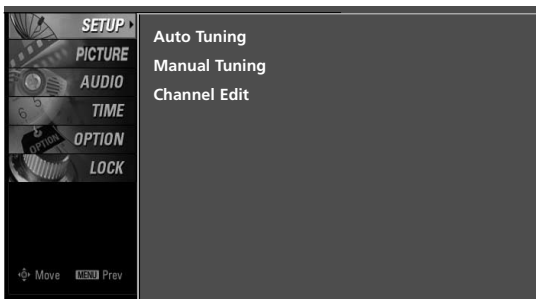

PICTURE

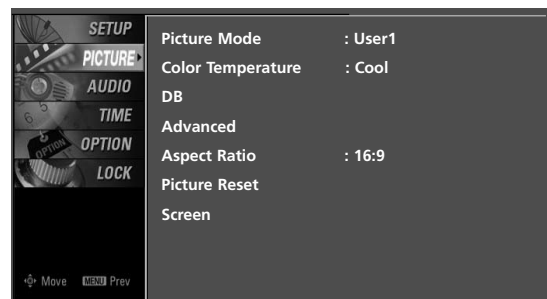

LOCK

For USA

For Canada

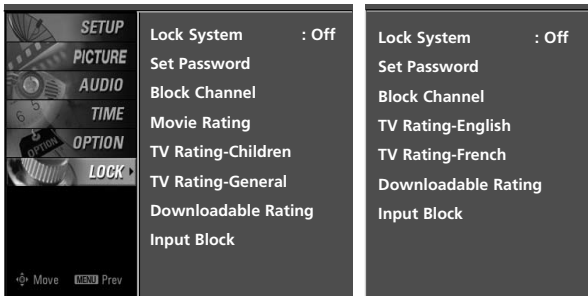

AUDIO

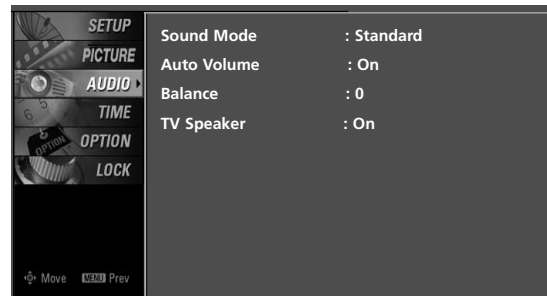

OPTION

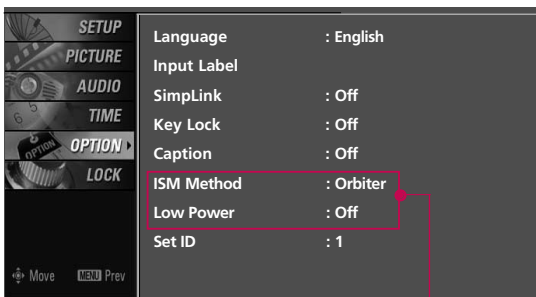

TIME

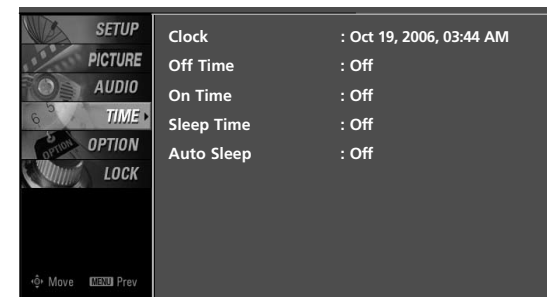

Only Plasma TV model

WATCHING TV / CHANNEL CONTROL

CHANNEL SETUP

Auto Scan (Auto Tuning)

Automatically finds all channels available through antenna or cable inputs, and stores them in memory on the channel list.

Run Auto Tuning again after any Antenna/Cable connection changes.

A password is required to gain access to Auto Tuning menu if the Lock System is turned on.

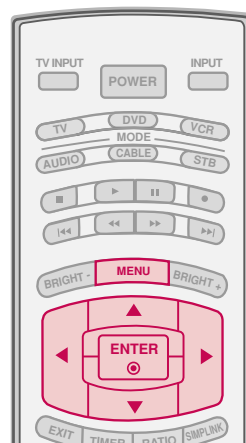

1 Press the **MENU** button and then use **▲** or **▼** button to select the **SETUP** menu.

2 Press the **▶** button and then use **▲** or **▼** button to select **Auto Tuning**.

3 Press the **ENTER** button to begin the channel search. Allow **Auto Tuning** to complete the channel search cycle for **ANTENNA** and **CABLE**.

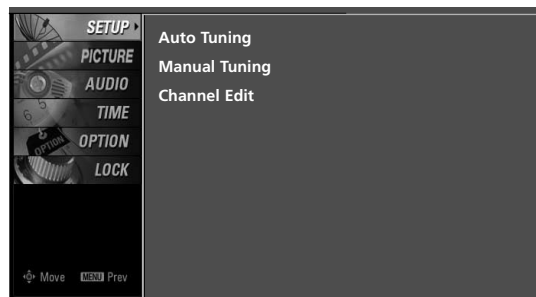

1

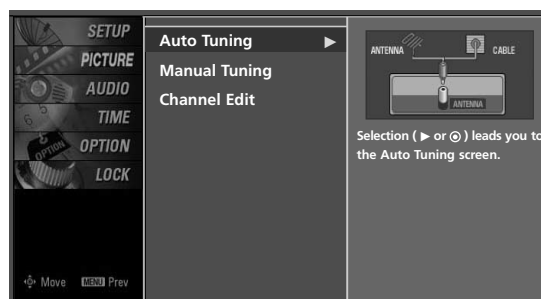

2

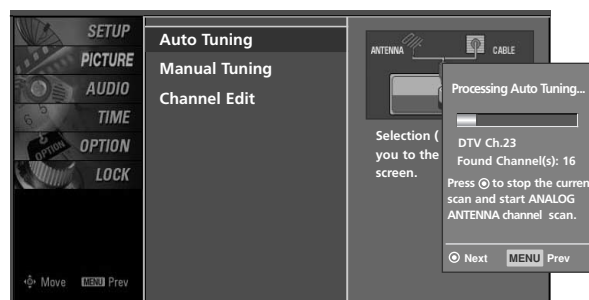

3

NOTE



- DTV (Digital DTV antenna)
- TV (Analog TV antenna)
- CADTV (Digital CADTV cable)
- CATV (Analog CATV cable)

Add/Delete Channel (Manual Tuning)

A password is required to gain access to Manual Tuning menu if the Lock System is turned on.

If selecting DTV or CADTV input signal, you can view the on-screen signal strength monitor to see the quality of the signal being received.

1 Press the **MENU** button and then use **▲** or **▼** button to select the **SETUP** menu.

2 Press the **▶** button and then use **▲** or **▼** button to select **Manual Tuning**.

3 Press the **▶** button and then use **▲** or **▼** button to select **TV, DTV, CATV, and CADTV**.

4 Press the **▶** button and then use **▲** or **▼** button to select channel you want to add or delete.

5 Press the **ENTER** button to add or delete the channel.

6 Press **EXIT** button to return to TV viewing or press **MENU** button to return to the previous menu.

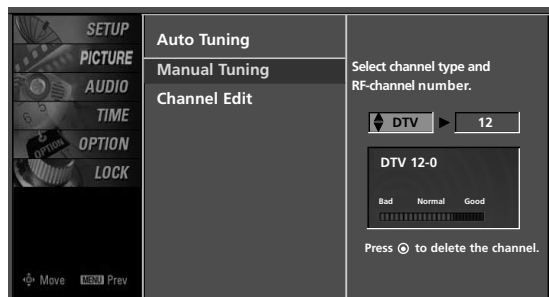
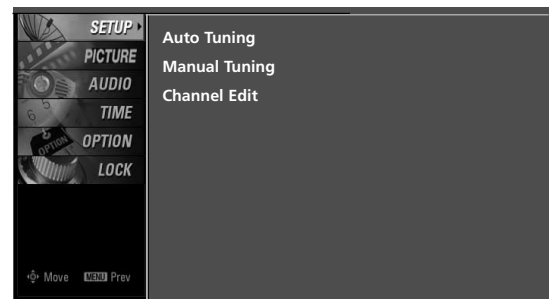
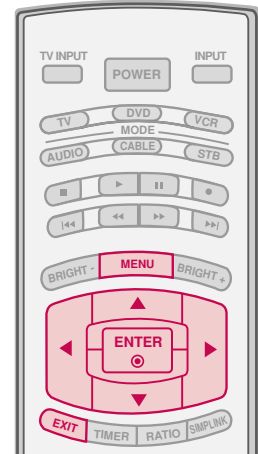

3 4 5

WATCHING TV / CHANNEL CONTROL

Channel Editing

From the default channel list created from the Auto Tuning channel search, you can create two different types of channel lists in memory: “custom list” and “favorite channel list”.

A custom list can be created by toggling each channel on or off with **ENTER** button. The channels in the Custom List are displayed in black and the channels deleted from the Custom List are displayed in gray. Once a channel is highlighted you can add or delete the channel by referring to the small window at the top-left corner of the screen.

You can create your own Favorite List. Use the **FAV** button on the remote control when a channel is highlighted and then add or delete the channel to/from your Favorite List.

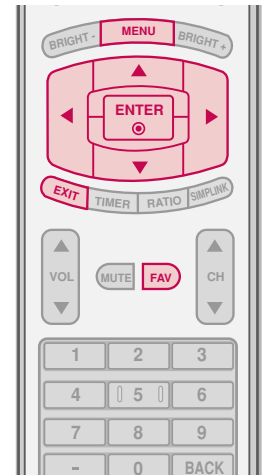

1 Press the **MENU** button and then use **▲** or **▼** button to select the **SETUP** menu.

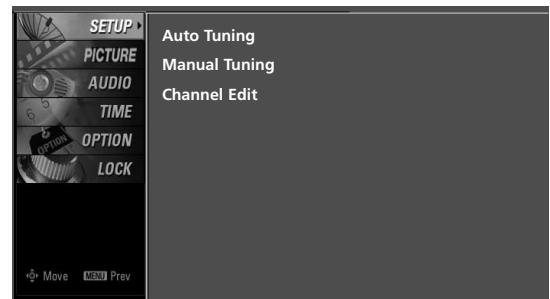

2 Press the **▶** button and then use **▲** or **▼** button to select **Channel Edit**.

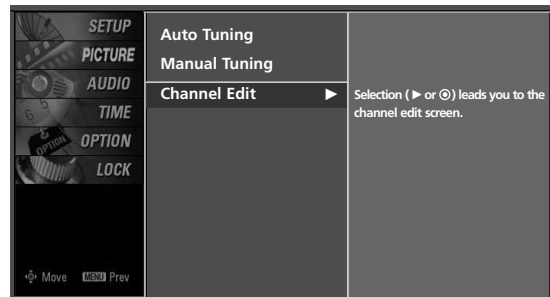

3 Press the **▶** button. You will now see a screen filled with channel numbers and a preview picture.

4 Use **▲▼◀▶** button to select a channel and then use the **ENTER** button to add or delete it. Press **FAV** button to add the channel to the Favorite List. The surfing icon will appear in front of that channel number.



5 Press **EXIT** button to return to TV viewing or press **MENU** button to return to the previous menu.

INPUT LIST

Press the **INPUT** button to display external device that is connected to the unit, on screen.

Press the **ENTER** button to change the input to the active external device. Use the **▲** or **▼** button to select the input source.

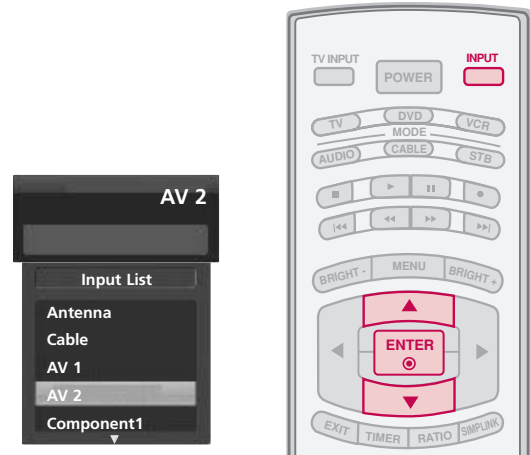

- 1** If all external input sources are connected:

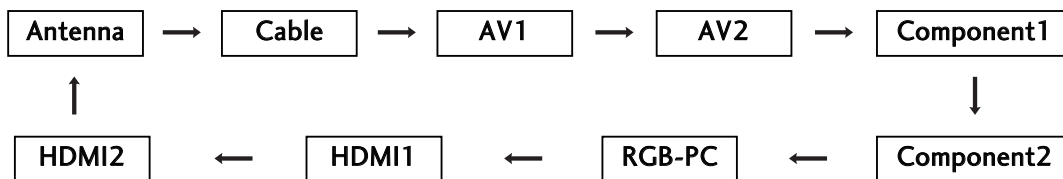

- 2** If no external input sources are not connected:



- 3** If there is any external input source connected:
(ex: When connected only to AV 2)

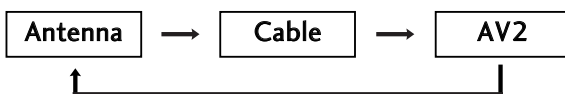

Antenna : Select it when watching the DTV/TV.

Cable: Select it when watching the CADTV/CATV.

AV 1-2 : Select it when watching the VCR or external equipment.



Component 1-2 : Select it when using the DVD or the Digital set-top box depend on connector.

RGB-PC: Select it when using PC depend on connector.

HDMI 1-2 : Select it when using DVD, PC or Digital set-top box depend on connector.

WATCHING TV / CHANNEL CONTROL



This operates only for the devices with the  SIMPLINK logo. Please check the  SIMPLINK logo.

This allows you to control and play other AV devices connected to the display through HDMI cable without additional cables and settings.

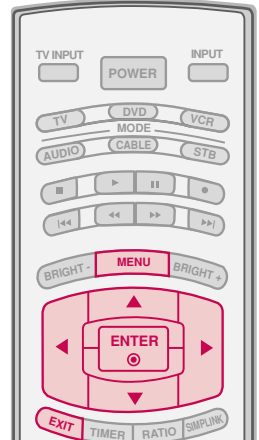

Simplink Preparations

1 Connect the HDMI/DVI IN 1 or HDMI IN 2 terminal of the TV to the rear terminal (HDMI output) of the Simplink device with the HDMI cable.
After connecting the HDMI jack for the home theater with simplink function in the above method, connect the DIGITAL AUDIO OUT OPTICAL on the back of the TV to the DIGITAL AUDIO IN terminal on the back of the simplink device with the Optical cable.

2 Press the **MENU** button and then use **▲** or **▼** button to select the **OPTION** menu.

3 Press the **▶** button and then use **▲** or **▼** button to select **Simplink**.

4 Press the **▶** button and then use **▲** or **▼** button to select **On**.

5 Press **EXIT** button to return to TV viewing or press **MENU** button to return to the previous menu.

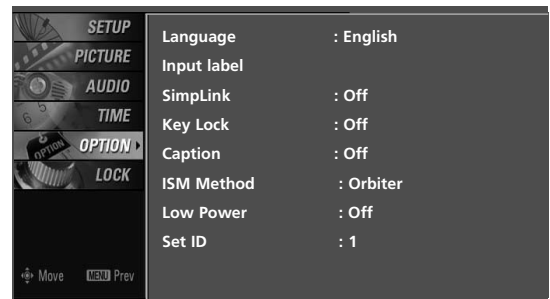

2

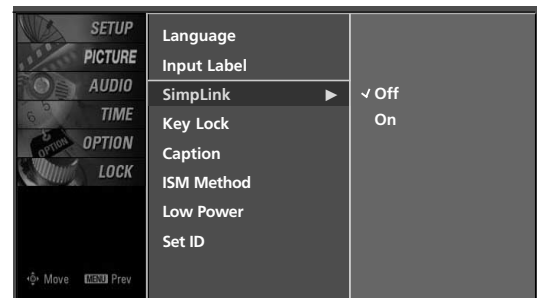











3 4

! NOTE

- ▶ When operating the external device with Simplink, press the TV button among the MODE button on the remote control.
- ▶ When you switch the Input source with the INPUT button on the remote control, you can stop the operation of device worked by Simplink.
- ▶ When you select or operate the media device with home theater function, the speaker automatically switches to home theater speaker (HT speaker).





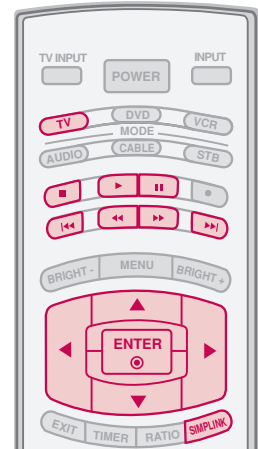









Simplink Functions

- **Direct Play:** After connecting AV devices to TV, you can directly control the devices and play media without additional settings.
- **Select AV device:** Enables you to select one of AV devices connected to TV and play it.
- **Disc playback:** Control connected AV devices by pressing the , , , , , , , , , , , **ENTER** buttons and buttons for play, stop, pause, fast reverse, fast forward, chapter skip.
- **Power off all devices:** When you power off TV, all connected devices are turned off. (This option only applied when the devices are stopped.)
- **Switch audio-out:** Offers an easy way to switch audio-out.



(A device, which is connected to TV through HDMI cable but does not support Simplink, does not provide this function)

Note: To operate SIMPLINK, the HDMI cable over 1.2 Version with *CEC function should be used. (*CEC: Consumer Electronics Control).

- 1 After selecting the **TV** button of the MODE on the remote control, press the **SIMPLINK** button.
- 2 Use , , ,  button to select the desired device and then press the **ENTER** button.
- 3 Control connected AV devices by pressing the , , , , , , , , , , , **ENTER** buttons.

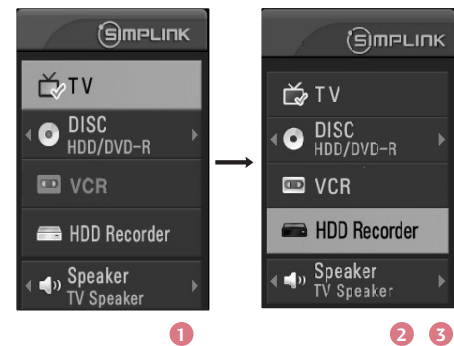

Simplink Menu

- 1 **TV viewing:** Switch to the previous TV channel regardless of the current mode.
- 2 **DISC playback:** Select and play discs. When multiple discs are conveniently displayed at the bottom of the screen.
- 3 **VCR playback:** Play and control the connected VCR.
- 4 **HDD Recordings playback:** Play and control recordings stored in HDD.
- 5 **Audio Out to HT speaker/Audio Out to TV:** Select HT speaker or TV speaker for Audio Out.

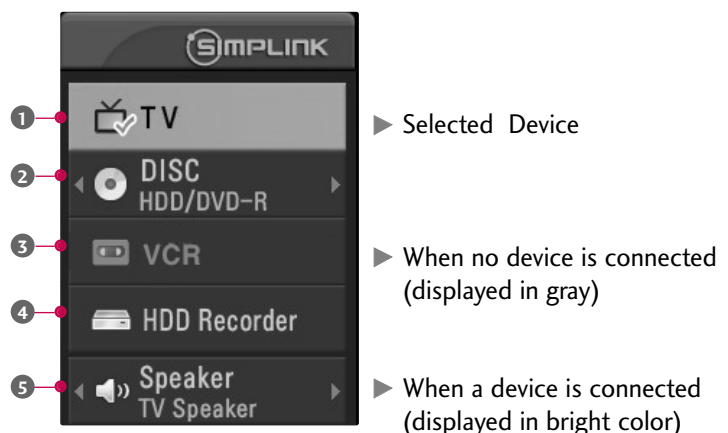

WATCHING TV / CHANNEL CONTROL

INPUT LABEL

Sets a label to each input source which is not in use when you press the **INPUT** button.

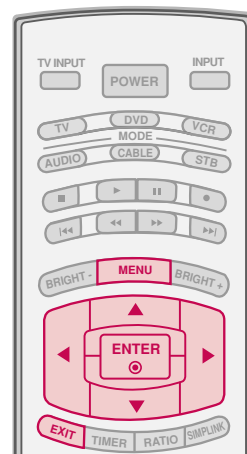

1 Press the **MENU** button and then use ▲ or ▼ button to select the **OPTION** menu.

2 Press the ► button and then use ▲ or ▼ button to select **Input Label**.

3 Press the ► button and then use ▲ or ▼ button to select the source: AV1, AV2, Component1, Component2, RGB-PC, HDMI1, or HDMI2.

4 Press the ◀ or ▶ button to select the label.

5 Press **EXIT** button to return to TV viewing or press **MENU** button to return to the previous menu.

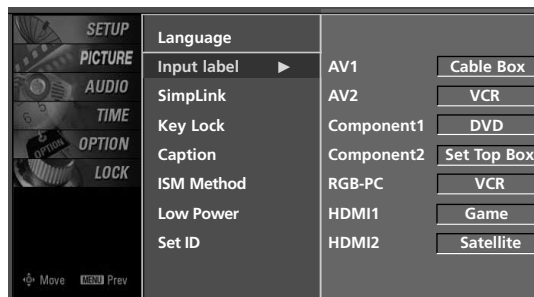
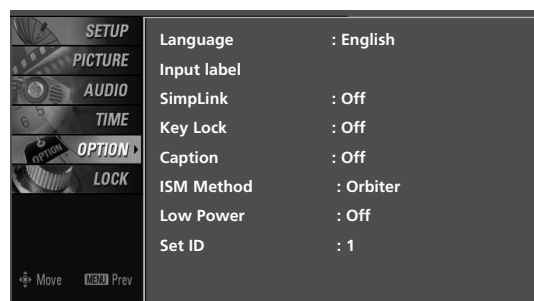

2 3 4

KEY LOCK

The TV can be set up so that it can only be used with the remote control.

This feature can be used to prevent unauthorized viewing by locking out the front panel controls.

This TV is programmed to remember which option it was last set to even if you turn the TV off.

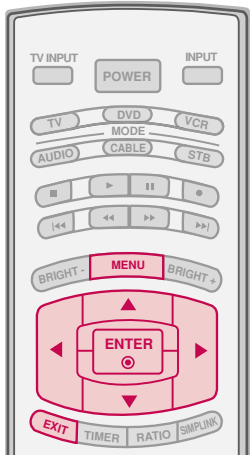

1 Press the **MENU** button and then use ▲ or ▼ button to select the **OPTION** menu.

2 Press the ► button and then use ▲ or ▼ button to select **Key Lock**

3 Press the ► button and then use ▲ or ▼ button to select **On** or **Off**.

4 Press **EXIT** button to return to TV viewing or press **MENU** button to return to the previous menu.

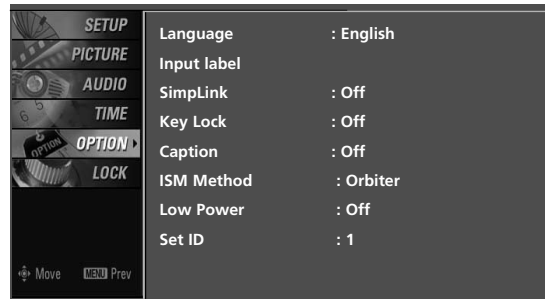

1

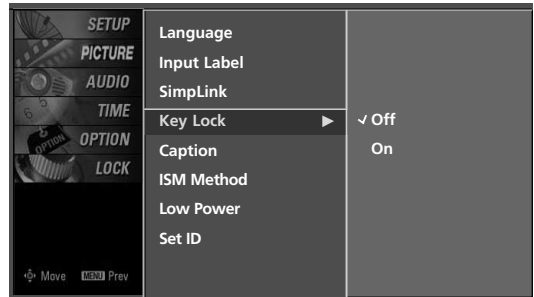

2 3

PICTURE CONTROL

PICTURE SIZE (ASPECT RATIO) CONTROL

This feature lets you choose the way an analog picture with a 4:3 aspect ratio is displayed on your TV. When you receive an analog picture with a 4:3 aspect ratio on your 16:9 TV, you need to specify how the picture is to be displayed.

- RGB-PC input source use 4:3 or 16:9 aspect ratio.

! NOTE

- ▶ If a fixed image is displayed on the screen for a long time, the image may become imprinted on the screen and remain visible. This phenomenon is common to all manufactures and in consequence the manufactures warranty does not cover the product bearing this phenomenon.

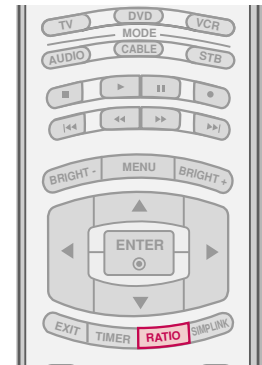

- 1 Press the **RATIO** button repeatedly to select the desired picture format.
 - You can also adjust **Aspect Ratio** in the **PICTURE** menu.

Set by program

Selects the proper picture proportion to match the source's image.

(4:3 → 4:3)



(16:9 → 16:9)



4:3

Choose 4:3 when you want to view a picture with an original 4:3 aspect ratio.

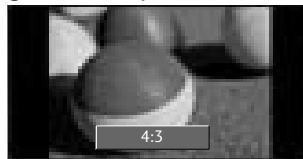

16:9

Adjust the picture horizontally, in a linear proportion to fill the entire screen.



Zoom 1

Choose Zoom 1 when you want to view the picture without any alteration. However, the top and bottom portions of the picture will be cropped.

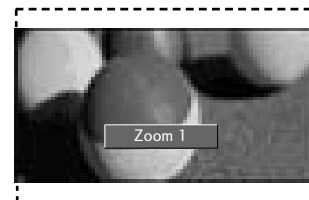

Zoom 2

Choose Zoom 2 when you want the picture to be altered, both vertically extended and cropped. The picture taking a halfway trade off between alteration and screen coverage.

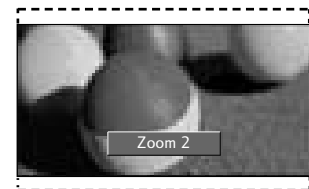

Just Scan

Following selection will lead to you view the picture of best quality without loss of original picture in high resolution image.

Notes: If there are noise in original picture, you can see the noise at the edge.

Just Scan operates only in DTV/CADTV (720p/1080i/1080p), HDMI-DTV, DVI-DTV input source.

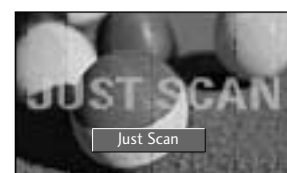

PRESET PICTURE SETTINGS

Picture Mode - Preset

Picture Mode adjusts the TV for the best picture appearance. Select the preset value in the Picture Mode menu based on the program category.

Dynamic, Standard, Mild Settings are preset for the optimum picture quality at the factory and are not adjustable.

In the **User1** and **User2** modes only, user can directly adjust the contrast, brightness, color, sharpness, tint, backlight.

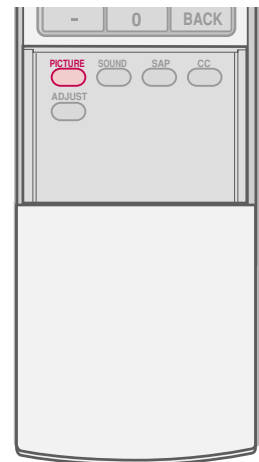

- 1 Press the **PICTURE** button repeatedly to select the picture appearance setup option as below :
Dynamic, Standard, Mild, User1 (your own settings), and **User2** (your own settings).

- 2 Press the **EXIT** button to save and return to TV viewing.

■ You can also use the **PICTURE** menu to adjust **Picture Mode**.



PICTURE CONTROL

Color Tone - Preset

Choose one of three automatic color adjustments. Set to warm to enhance hotter colors such as red, or set to cool to see less intense colors with more blue.

When selecting Picture Mode options (Dynamic, Standard and Mild), Color Temperature is automatically change.

When selecting Picture Mode options (User 1 and User 2), you can choose the Color Temperature.

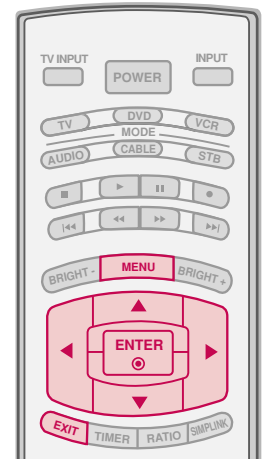

1 Press the **MENU** button and then use ▲ or ▼ button to select the **PICTURE** menu.

2 Press the ► button and then use ▲ or ▼ button to select **Color Temperature**.

3 Press the ► button and then use ▲ or ▼ button to select either **Cool, Medium, Warm** or **User**.

4 Press **EXIT** button to return to TV viewing or press **MENU** button to return to the previous menu.

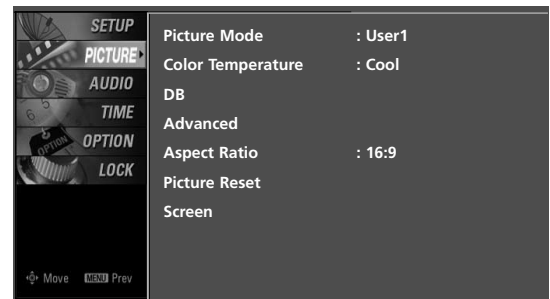

1

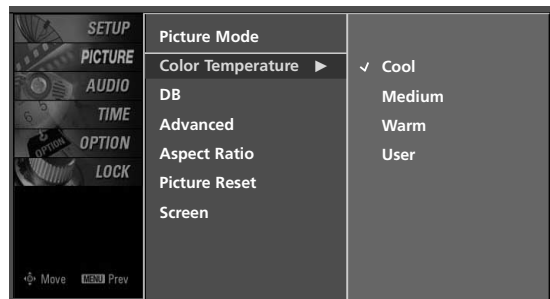

2 3

MANUAL PICTURE ADJUSTMENT

Picture Mode - User Mode

Adjust the picture appearance to suit your preference and viewing situations.

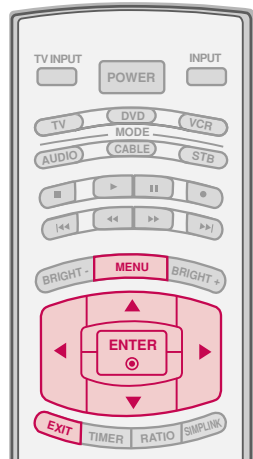

1 Press the **MENU** button and then use **▲** or **▼** button to select the **PICTURE** menu.

2 Press the **▶** button and then use **▲** or **▼** button to select **Picture Mode**.

3 Press the **▶** button and then use **▲** or **▼** button to select **User 1** or **User 2**.

4 Press the **▶** button and then use **▲** or **▼** button to select the desired picture option (**Contrast**, **Brightness**, **Color**, **Sharpness**, **Tint**, or **Back Light** (LCD TV only)).

- **Back Light** (LCD TV only)
To control the brightness of the screen, adjust the brightness of LCD panel.

5 Press the **▶** button and then use **◀** or **▶** button to make appropriate adjustments.

6 Press **EXIT** button to return to TV viewing or press **MENU** button to return to the previous menu.

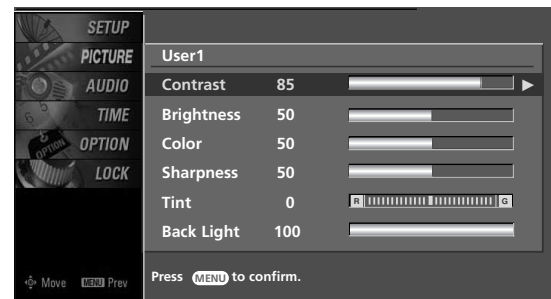
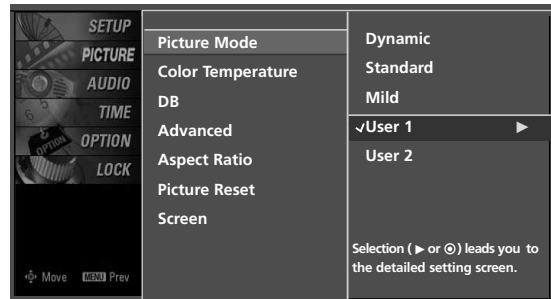
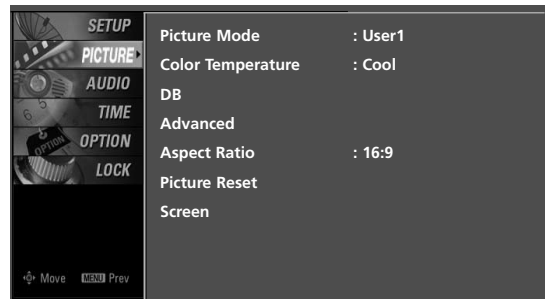

PICTURE CONTROL

Color Tone - User Mode

You can also adjust the detailed settings (Red, Green, Blue) by selecting the **Color Temperature-User** menu.

When selecting Picture Mode options (User 1 and User 2), you can choose the **Color Temperature**.

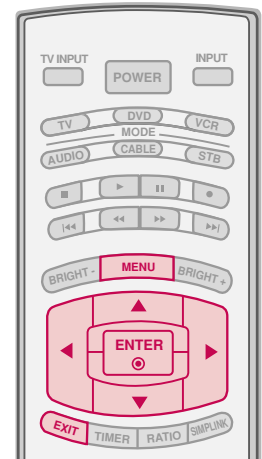

1 Press the **MENU** button and then use ▲ or ▼ button to select the **PICTURE** menu.

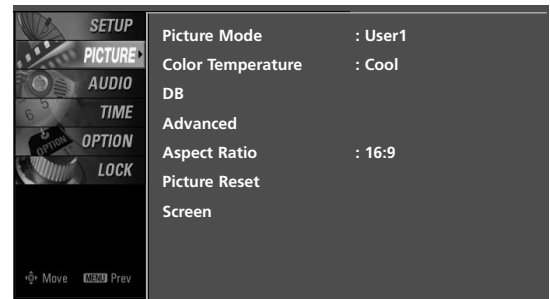

2 Press the ► button and then use ▲ or ▼ button to select **Color Temperature**.

3 Press the ► button and then use ▲ or ▼ button to select **User**.

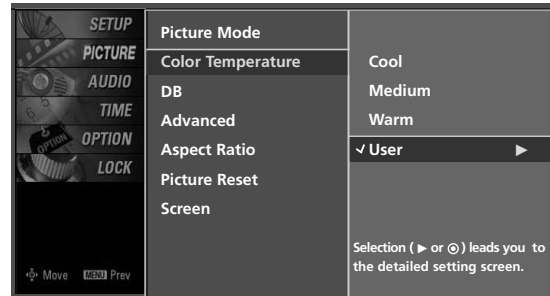

4 Press the ► button and then use ▲ or ▼ button to select **Red, Green, or Blue**.

5 Press the ► button and then use ◀ or ▶ button to make appropriate adjustments.

- The adjustment range of **Red, Green, or Blue** is -20~ +20.

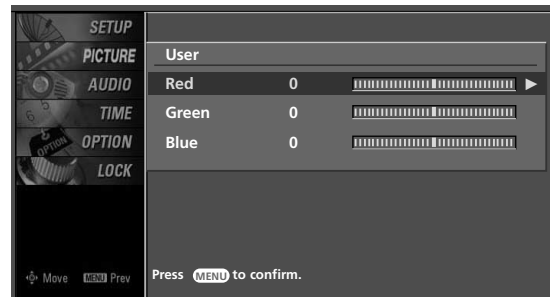

6 Press **EXIT** button to return to TV viewing or press **MENU** button to return to the previous menu.



DIGITAL BOOSTER

Digital Booster is Zenith's unique picture improving technology to display a real HD source through an advanced digital signal processing algorithm.

When selecting Picture Mode options (Dynamic, Standard, and Mild), Digital Booster is automatically changed to Auto.

When selecting Picture Mode options (User 1 and User 2), you can choose the Auto / Manual.

When selecting the Manual, you can adjust the DB Contrast, DB color and DB Noise.

It's not available to use this function in RGB-PC input source.

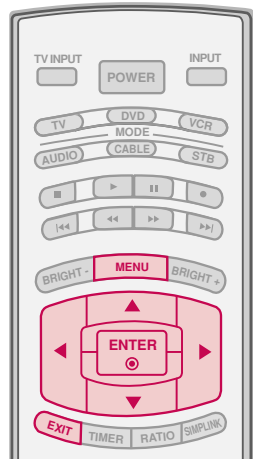

1 Press the **MENU** button and then use **▲** or **▼** button to select the **PICTURE** menu.

2 Press the **▶** button and then use **▲** or **▼** button to select **Digital Booster**.

3 Press the **▶** button and then use **◀** or **▶** button to select **Auto** or **Manual**.

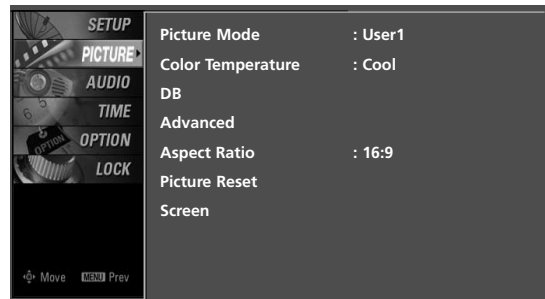

1

Selecting the Manual

1. Press the **▼** button and then use **▲** or **▼** button to select **DB Contrast**, **DB Color** or **DB Noise**.

- **DB Contrast:** Optimizing the contrast automatically according to the brightness of the reflection.
- **DB Color:** Adjusting the colors of the reflection automatically to reproduce as closely as possible to the natural colors.
- **DB Noise:** Removing the noise up to the point where it does not damage the original picture.

2. Use the **◀** or **▶** button to select **On** or **Off**.

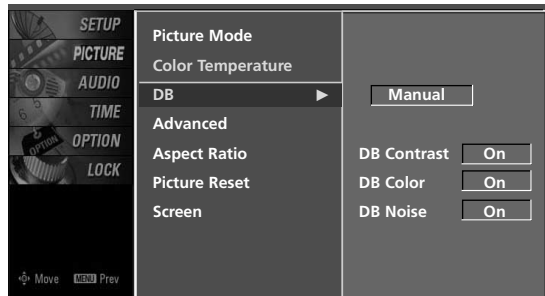

2 3

4 Press **EXIT** button to return to TV viewing or press **MENU** button to return to the previous menu.

PICTURE CONTROL

ADVANCED - CINEMA 3:2 PULL DOWN MODE

Set up the TV for the best picture appearance for viewing movies.

When you operate Cinema 3:2 Mode (3:2 Pull-Down Mode or Cinema Correction Mode), the TV will adjust 24 fps video from movies to 30 fps video for display.

This feature operates only in TV (Analog TV/CATV, Digital DTV/CADTV), AV1, AV2, Component 480i/1080i, and HDMI 1080i mode.

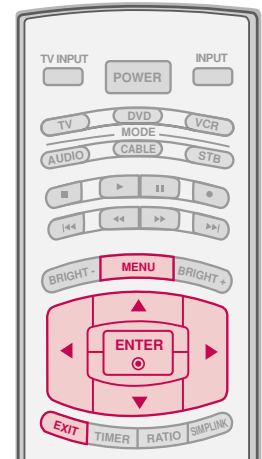

- 1 Press the **MENU** button and then use ▲ or ▼ button to select the **PICTURE** menu.
- 2 Press the ► button and then use ▲ or ▼ button to select **Advanced**.
- 3 Press the ► button and then use ▲ or ▼ button to select **Cinema 3:2 Mode**.
- 4 Use ◀ or ▶ button to select **On** or **Off**.
- 5 Press **EXIT** button to return to TV viewing or press **MENU** button to return to the previous menu.

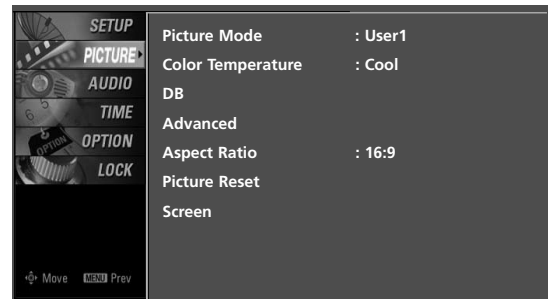

1

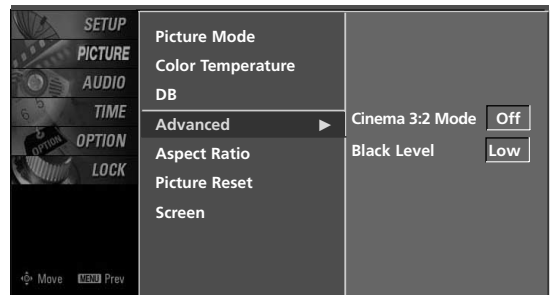

2 3 4

ADVANCED - BLACK (DARKNESS) LEVEL

Adjusting the contrast and the brightness of the screen using the black level of the screen.

This feature operates only in AV1, AV2, HDMI1, or HDMI2 mode.

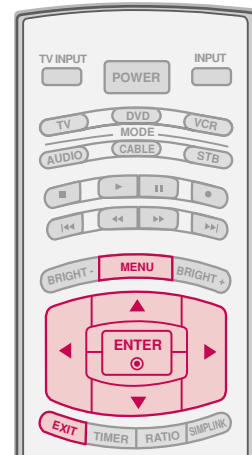

1 Press the **MENU** button and then use ▲ or ▼ button to select the **PICTURE** menu.

2 Press the ► button and then use ▲ or ▼ button to select **Advanced**.

3 Press the ► button and then use ▲ or ▼ button to select **Black level**.

4 Use ◀ or ▶ button to select **Low** or **High**.

- **Low**
The screen gets darker.
- **High**
The screen gets brighter.

5 Press **EXIT** button to return to TV viewing or press **MENU** button to return to the previous menu.

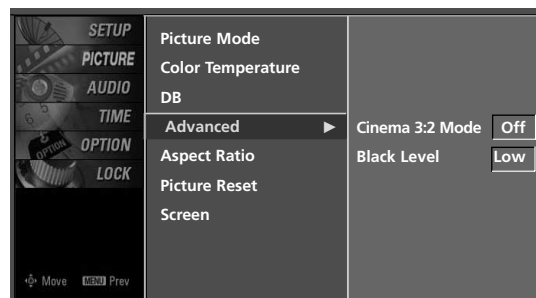
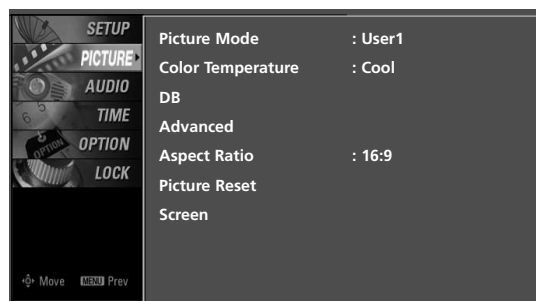

2 3 4

PICTURE CONTROL

PICTURE RESET

Use to quickly reset all the Picture menu options to their original factory preset values.

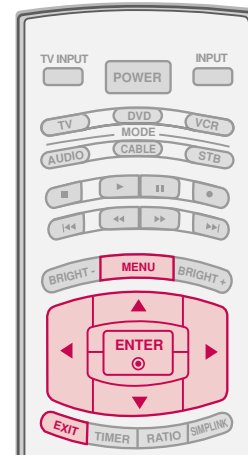

1 Press the **MENU** button and then use ▲ or ▼ button to select the **PICTURE** menu.

2 Press the ► button and then use ▲ or ▼ button to select **Picture Reset**

3 Press the ► button to reset the Picture menu options to original values.

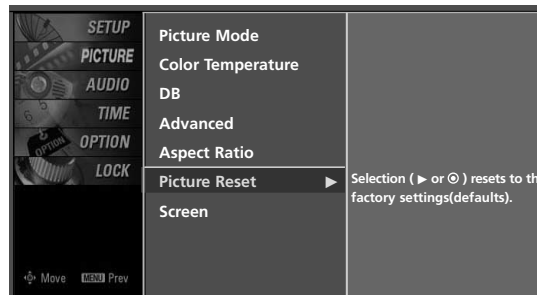
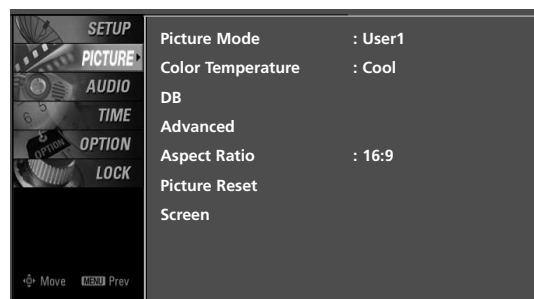

3

IMAGE STICKING MINIMIZATION (ISM) METHOD - Plasma TV only

A frozen still picture from a PC/video game displayed on the screen for prolonged periods will result in a ghost image. Use our unique method to minimize any fixed image on the screen.

- 1 Press the **MENU** button and then use ▲ or ▼ button to select the **OPTION** menu.
- 2 Press the ► button and then use ▲ or ▼ button to select **ISM Method**.
- 3 Press the ► button and then use ▲ or ▼ button to select either **Normal**, **Orbiter**, **Inversion**, or **White Wash**.

■ Normal

If image sticking is never a problem, ISM is not necessary - set to Normal.

■ Orbiter

Orbiter may help prevent ghost images. However, it is best not to allow any fixed image to remain on the screen. To avoid a ghost image on the screen, the image will move once per 2 minutes: Left → Right → Upside → Downside → Right → Left → Downside → Upside.

■ Inversion

Inversion will automatically invert the plasma display panel color every 30 minutes.

■ White Wash

White Wash removes ghost images from the screen.

Use sparingly. Watch the TV normally for a while before using this feature to see if the ghost image disappears on its own.

! NOTE

- ▶ An excessive ghosted image may be impossible to clear entirely with White Wash. To return to normal viewing, press the any button.

- 4 Press **EXIT** button to return to TV viewing or press **MENU** button to return to the previous menu.

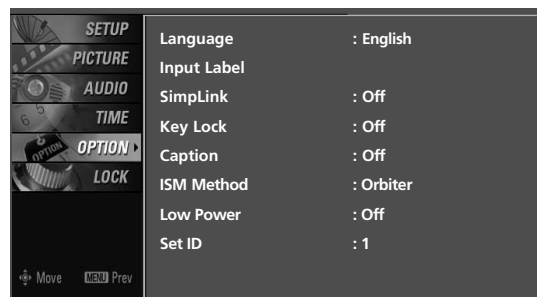
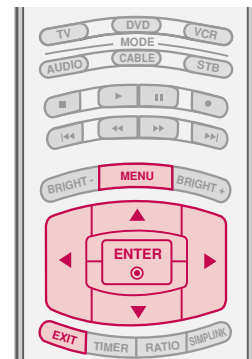

1

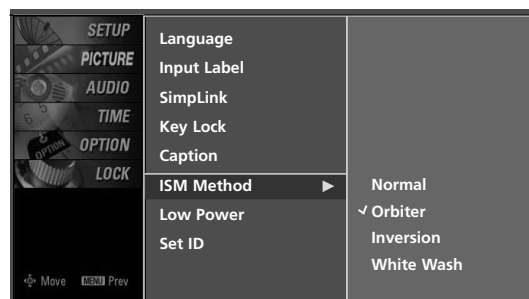

2 3

PICTURE CONTROL

LOW - POWER PICTURE MODE - Plasma TV only

Low power reduces the plasma display power consumption.

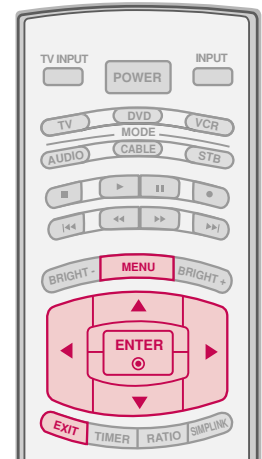

1 Press the **MENU** button and then use ▲ or ▼ button to select the **OPTION** menu.

2 Press the ► button and then use ▲ or ▼ button to select **Low Power**.

3 Press the ► button and then use ▲ or ▼ button to select **On** or **Off**.

- When you select **On**, the screen darkens.

4 Press **EXIT** button to return to TV viewing or press **MENU** button to return to the previous menu.

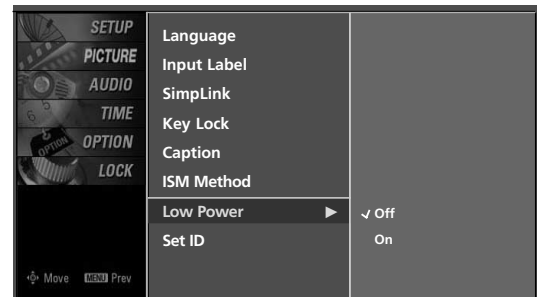
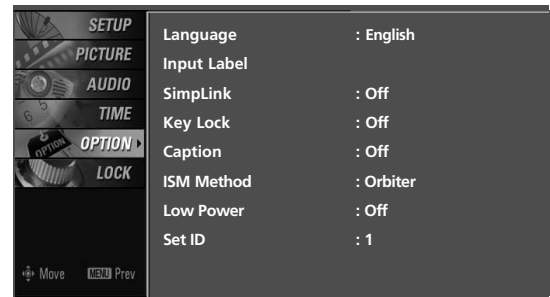

2 3

SOUND & LANGUAGE CONTROL

AUTO VOLUME LEVELLER (AUTO VOLUME)

Scans for changes in sound levels during commercials, then adjusts the sound to match the specified audio level.

Auto Volume makes sure that the volume level remains consistent whether you are watching a commercial or a regular TV program.

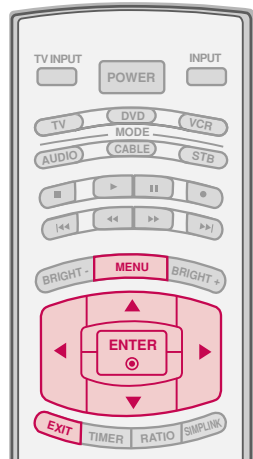

1 Press the **MENU** button and then use ▲ or ▼ button to select the **AUDIO** menu.

2 Press the ► button and then use ▲ or ▼ button to select **Auto Volume**.

3 Press the ► button and then use ▲ or ▼ button to select **On** or **Off**.

4 Press **EXIT** button to return to TV viewing or press **MENU** button to return to the previous menu.

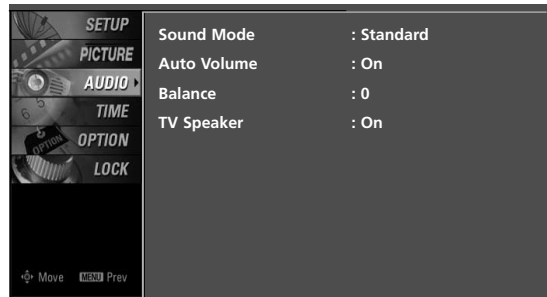

1

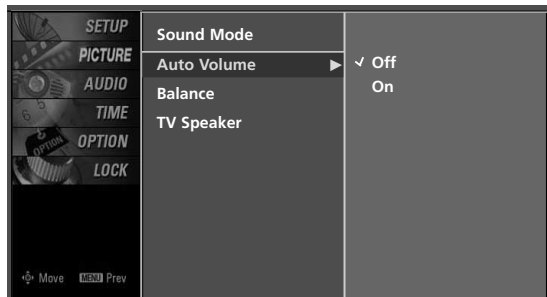

2 3

SOUND & LANGUAGE CONTROL

PRESET SOUND SETTINGS (SOUND MODE)

Sound Mode lets you enjoy the best sound without any special adjustment because the TV sets the appropriate sound options based on the program content.

Standard, Music, Movie, and Sports are preset for good sound quality at the factory and are not adjustable.

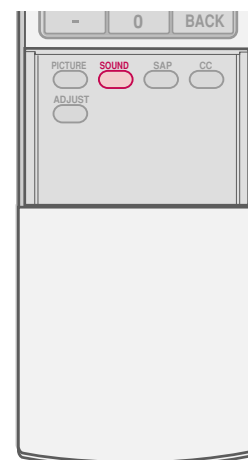

- 1 Press the **SOUND** button repeatedly to select the appropriate sound setup as below:
Standard, Music, Movie, Sports, and User (your own settings).

- 2 Press **EXIT** button to return to TV viewing.

■ You can also adjust **Sound Mode** in the **AUDIO** menu.



SOUND SETTING ADJUSTMENT - USER MODE

Adjust the sound to suit your taste and room situations.

1 Press the **MENU** button and then use ▲ or ▼ button to select the **AUDIO** menu.

2 Press the ► button and then use ▲ or ▼ button to select **Sound Mode**.

3 Press the ► button and then use ▲ or ▼ button to select **User**.

4 Press the ► button and then use ▲ or ▼ button to select the desired sound option (**Treble**, **Bass**, or **Front Surround**).

5 Press the ► button and then use ◀ or ▶ button to make appropriate adjustments.

Selecting the Front surround

Press the ► button and then use ◀ or ▶ button to select **Off**, **3D EchoSound System** or **SRS (Sound Retrieval System) TruSurround XT**.

6 Press **EXIT** button to return to TV viewing or press **MENU** button to return to the previous menu.

SRS TruSurround XT

Takes advantage of any multi-channel format without needing to add extra speakers or equipment. Dialog clarity, bass enrichment, and the addition of stereo audio enhancement produces an immersive sound experience from standard stereo material.

3D EchoSound System

Creates a stunning simulated stereo effect from any mono sound and a realistic three-dimensional sound with a very wide and deep sound stage.

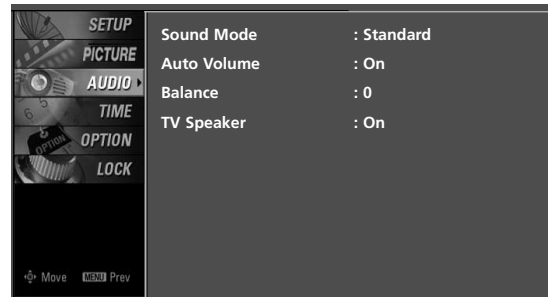

1

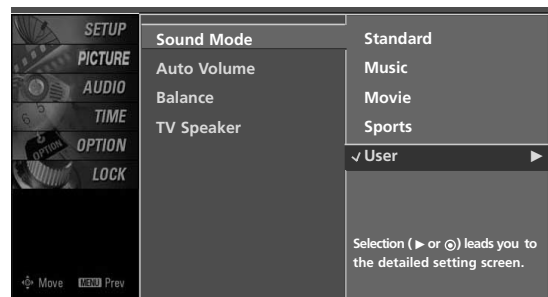

2 3



4

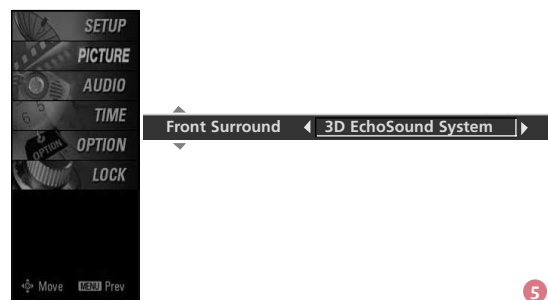

5

SOUND & LANGUAGE CONTROL

BALANCE

Adjust the left/right sound of speaker to suit your taste and room situations.

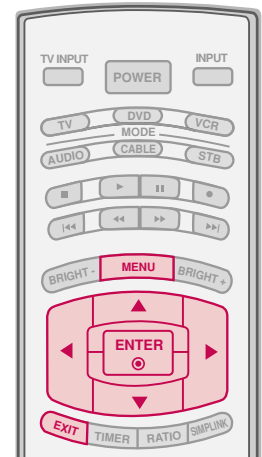

1 Press the **MENU** button and then use ▲ or ▼ button to select the **AUDIO** menu.

2 Press the ► button and then use ▲ or ▼ button to select **Balance**.

3 Press the ► button and then use ◀ or ▶ button to make appropriate adjustments.

4 Press **EXIT** button to return to TV viewing or press **MENU** button to return to the previous menu.

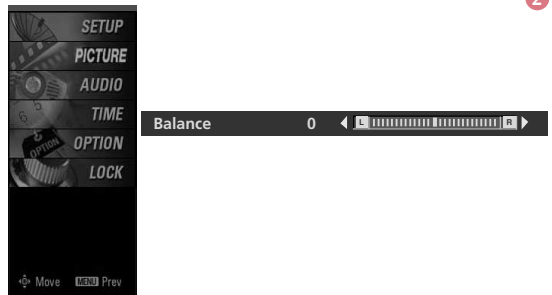
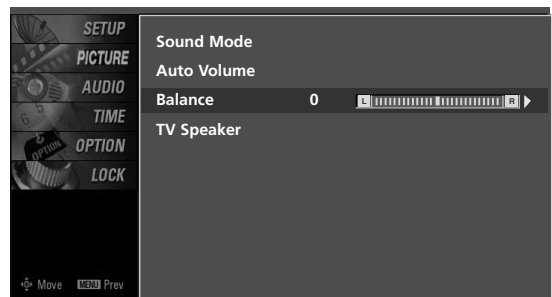
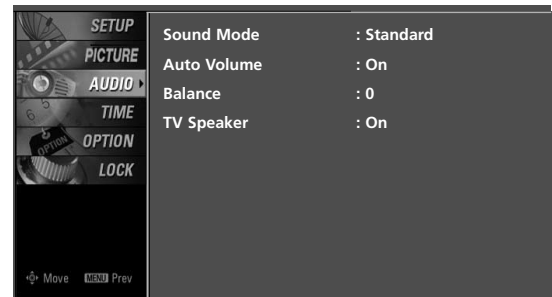

TV SPEAKERS ON/OFF SETUP

Turn the TV speakers off if using external audio equipment. Feature turns the TV Speakers option On or Off.

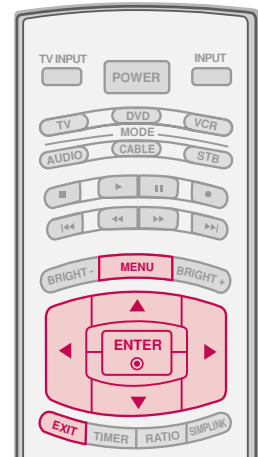

1 Press the **MENU** button and then use ▲ or ▼ button to select the **AUDIO** menu.

2 Press the ► button and then use ▲ or ▼ button to select **TV Speaker**.

3 Press the ► button and then use ▲ or ▼ button to select **On** or **Off**.

4 Press **EXIT** button to return to TV viewing or press **MENU** button to return to the previous menu.

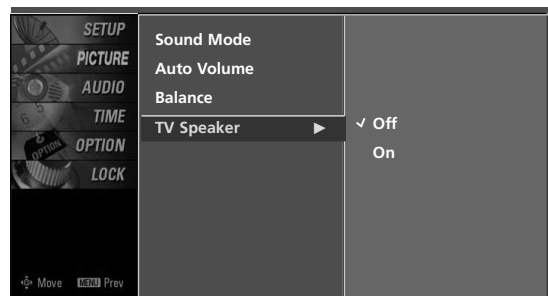
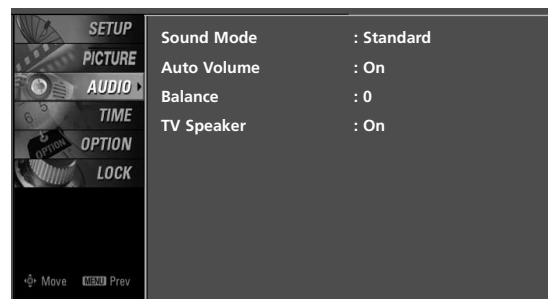

SOUND & LANGUAGE CONTROL

STEREO/SAP BROADCASTS SETUP

This TV can receive MTS stereo programs and any SAP (Secondary Audio Program) that accompanies the stereo program if the station transmits an additional sound signal as well as the original one and when you select Stereo or SAP on the remote control.

Mono sound is automatically received if the broadcast is only in Mono; even though Stereo or SAP has been selected.

Select Mono if you want to listen to the mono sound in remote areas during stereo/SAP broadcasting.

Stereo or SAP can be received in Analog channel.

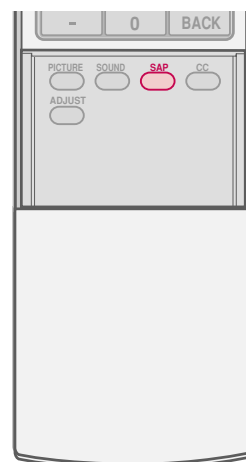

1 Use the **SAP** button to select your desired MTS mode in analog signal. Each time you press the **SAP** button, **Mono**, **Stereo**, or **SAP** appear in turn.

- If other languages available on the digital signal, select them with the **SAP** button.

2 Press **EXIT** button to save and return to TV viewing.

AUDIO LANGUAGE

Other languages may be available if a digital signal is provided by the broadcasting station.

This feature operates only in DTV/CADTV mode.

1 Press the **MENU** button and then use ▲ or ▼ button to select the **OPTION** menu.

2 Press the ► button and then use ▲ or ▼ button to select **Language**.

3 Press the ► button and then use ▲ or ▼ button to select **Audio**.

4 Use ◀ or ▶ button to select: **English, Spanish, or French**.

5 Press **EXIT** button to return to TV viewing or press **MENU** button to return to the previous menu.

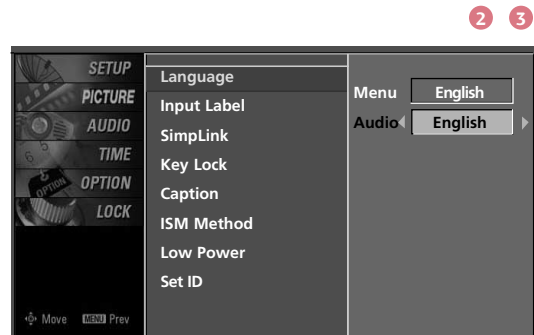
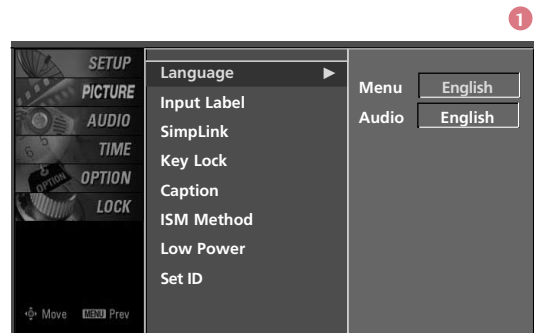
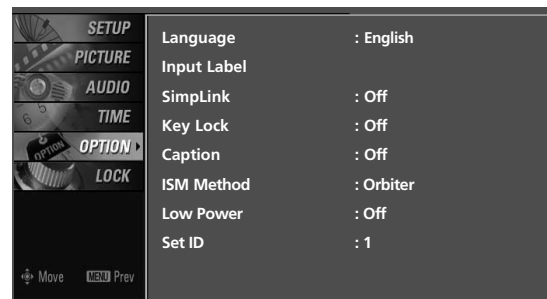
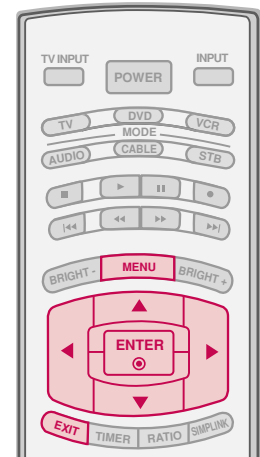

SOUND & LANGUAGE CONTROL

ON-SCREEN MENUS LANGUAGE SELECTION

The menus can be shown on the screen in the selected language. First select your language.

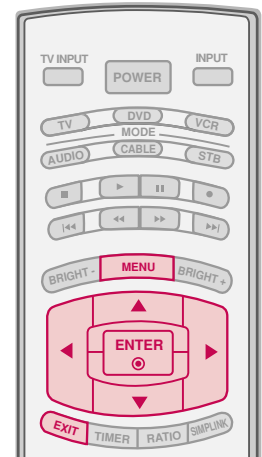

1 Press the **MENU** button and then use ▲ or ▼ button to select the **OPTION** menu.

2 Press the ► button and then use ▲ or ▼ button to select **Language**.

3 Press the ► button and then use ▲ or ▼ button to select **Menu**.

4 Use ◀ or ▶ button to select your desired language.
From this point on, the on-screen menus will be shown in the selected language.

5 Press **EXIT** button to return to TV viewing or press **MENU** button to return to the previous menu.

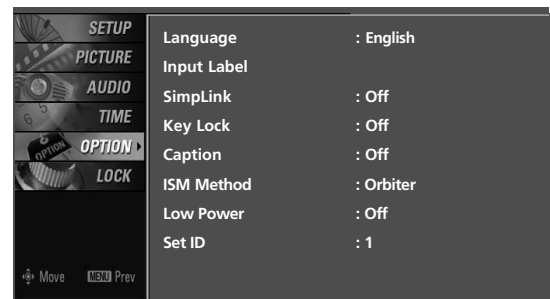

1

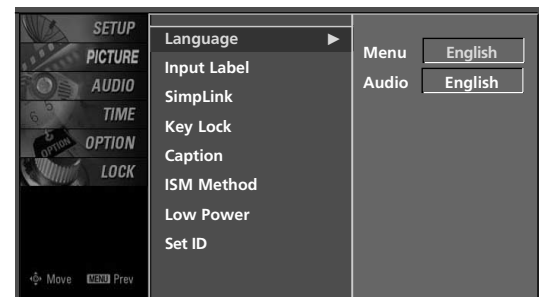

2 3

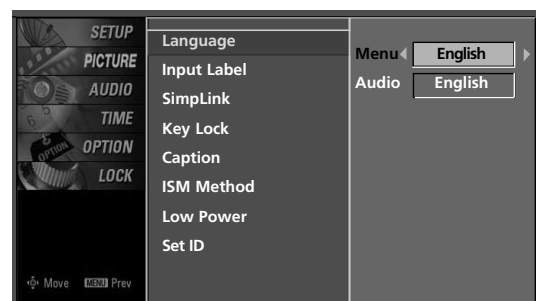

4

CAPTION MODE

Caption must be provided to help people with hearing loss watch TV.

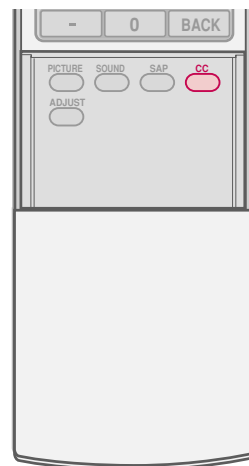

- 1 Use the **CC** button to select Caption **On** or **Off**.
 - When selecting **Off**, Sub-menus for Analog, DTV, and Digital Option become disabled.

- 2 Press **EXIT** to save and return to TV viewing.

- You can also adjust **Caption** in the **OPTION** menu.

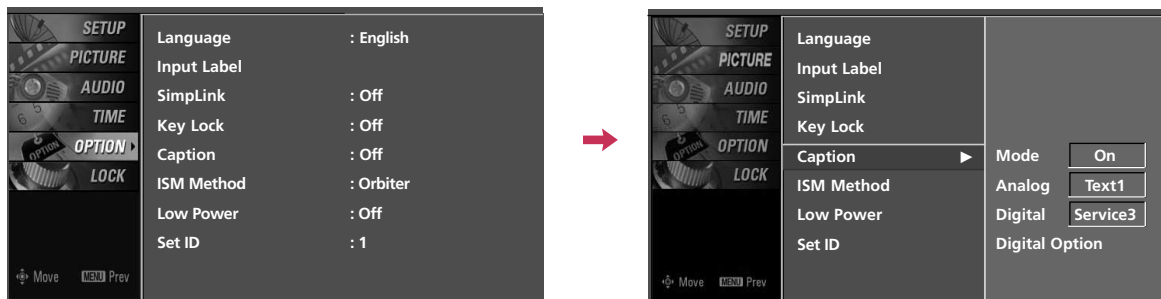

SOUND & LANGUAGE CONTROL

Analog Broadcasting System Captions

Select a caption mode for displaying captioning information if provided on a program. Analog caption displays information at any position on the screen and is usually the program's dialog.

Caption/Text, if provided by the broadcaster, would be available for both digital and analog channels on the Antenna/Cable.

This TV is programmed to memorize the caption/text mode which was last set when you turn the power off.

This function is only available when **Caption Mode** is set **On**.

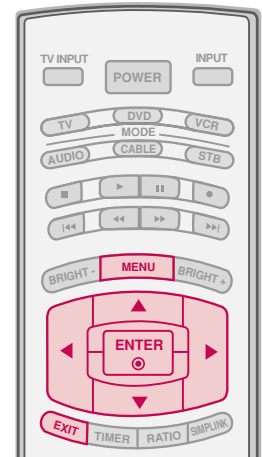

1 Press the **MENU** button and then use ▲ or ▼ button to select the **OPTION** menu.

2 Press the ► button and then use ▲ or ▼ button to select **Caption**.

3 Press the ► button and then use ▲ or ▼ button to select **Analog**.

4 Use ◀ or ▶ button to select **CC1, CC2, CC3, CC4, Text1, Text2, Text3** or **Text4**

■ CAPTION

The term for the words that scroll across the bottom of the TV screen; usually the audio portion of the program provided for the hearing impaired.

■ TEXT

The term for the words that appear in a large black frame and almost cover the entire screen; usually messages provided by the broadcaster.

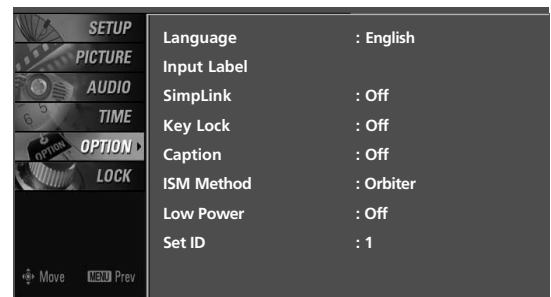

1

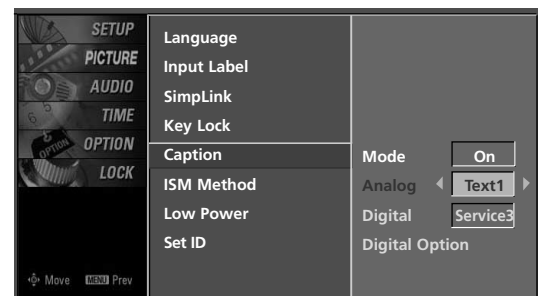

2 3 4

5 Press **EXIT** button to return to TV viewing or press **MENU** button to return to the previous menu.

Digital Broadcasting System Captions

Choose the language you want the DTV/CADTV Captions to appear in.

Other Languages can be chosen for digital sources only if they are included on the program.

This function is only available when **Caption Mode** is set **On**.

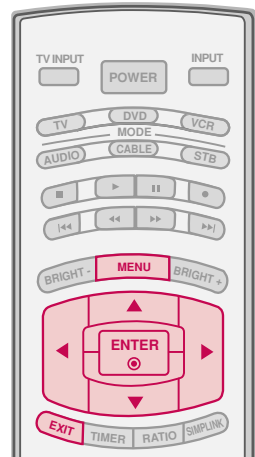

1 Press the **MENU** button and then use ▲ or ▼ button to select the **OPTION** menu.

2 Press the ► button and then use ▲ or ▼ button to select **Caption**.

3 Press the ► button and then use ▲ or ▼ button to select **Digital**.

4 Use ◀ or ▶ button to select **Service1 ~ Service6**.

5 Press **EXIT** button to return to TV viewing or press **MENU** button to return to the previous menu.

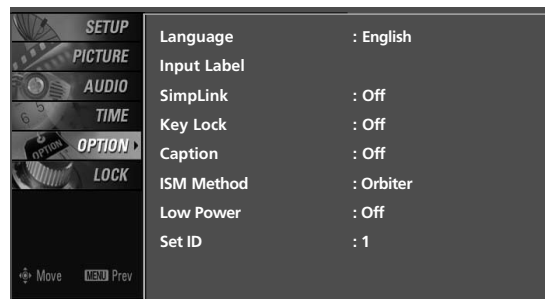

1

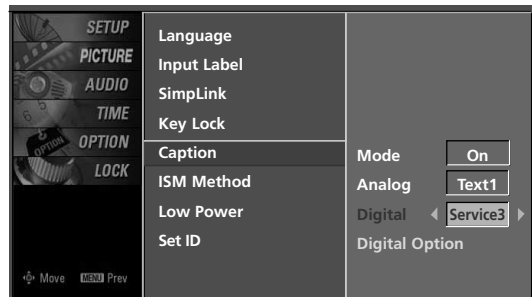

2 3 4

SOUND & LANGUAGE CONTROL

Caption Option

Customize the DTV/CADTV captions that appear on your screen.

This function is only available when **Caption Mode** is set **On**.

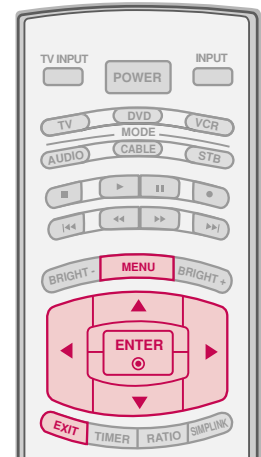

1 Press the **MENU** button and then use **▲** or **▼** button to select the **OPTION** menu.

2 Press the **▶** button and then use **▲** or **▼** button to select **Caption**.

3 Press the **▶** button and then use **▲** or **▼** button to select **Digital Option**.

4 Press the **▶** button and then use **◀** or **▶** button to select **Custom**.

5 Use **▲** or **▼** button to customize the **Style, Font, etc.**, to your preference.

A preview icon is provided at the bottom of the screen, use it to see the caption language.

- **Size:** Set the word size.
- **Font:** Select a typeface for the text.
- **Text Color:** Choose a color for the text.
- **Text Opacity:** Specify the opacity for the text color.
- **Bg (Background) Color:** Select a background color.
- **Bg (Background) Opacity:** Select the opacity for the background color.
- **Edge Type:** Select an edge type.
- **Edge Color:** Select a color for the edges.

6 Press **EXIT** button to return to TV viewing or press **MENU** button to return to the previous menu.

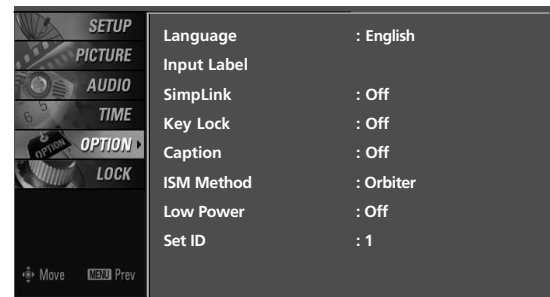

1

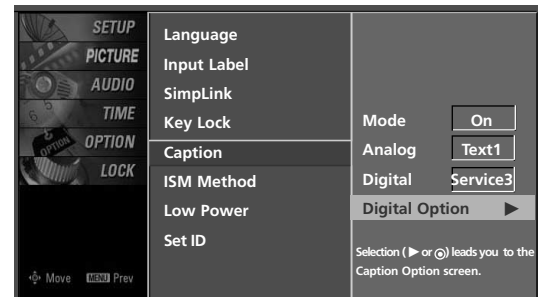

2 3

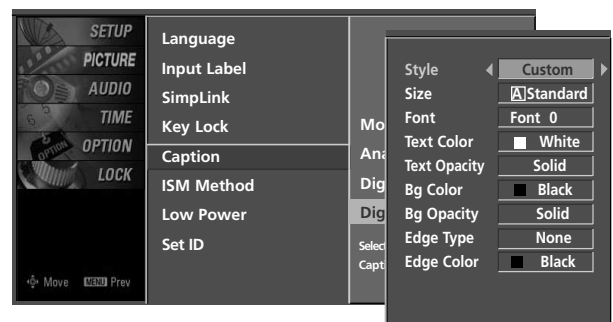

4 5

TIME SETTING

CLOCK SETTING

Auto Clock Setup

The time is set automatically from a digital channel signal. The digital channel signal includes information for the current time provided by the broadcasting station. Set the clock manually if the current time is set incorrectly by the auto clock function.

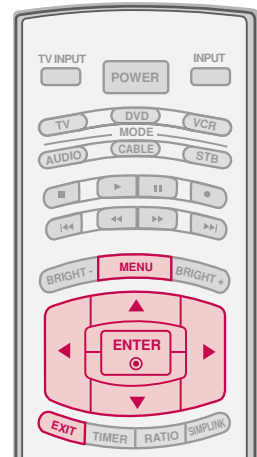

1 Press the **MENU** button and then use ▲ or ▼ button to select the **TIME** menu.

2 Press the ► button and then use ▲ or ▼ button to select **Clock**.

3 Press the ► button and then use ▲ or ▼ button to select **Auto**.

4 Press the ► button and then use ▲ or ▼ button to select your viewing area time zone:
U.S.A: **Eastern, Central, Mountain, Pacific, Alaska** or **Hawaii**.
Canada: **Eastern, Central, Mountain, Pacific, New F.land** or **Atlantic**.

5 Press the ► button and then use ▲ or ▼ button to select **Auto, Off, On**, depending on whether or not your viewing area observes Daylight Saving time.

6 Press **EXIT** button to return to TV viewing or press **MENU** button to return to the previous menu.



1

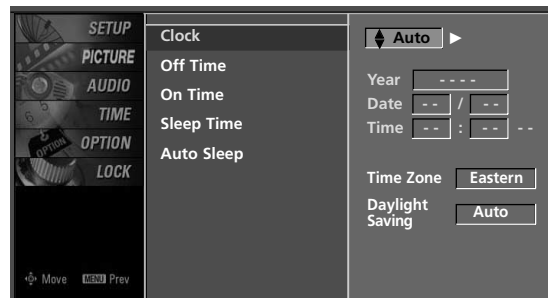

2 3

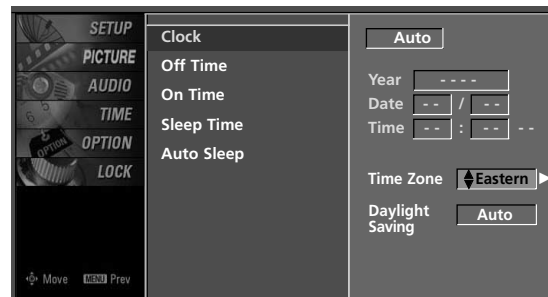

4 5

Manual Clock Setup

If the current time setting is wrong, reset the clock manually.

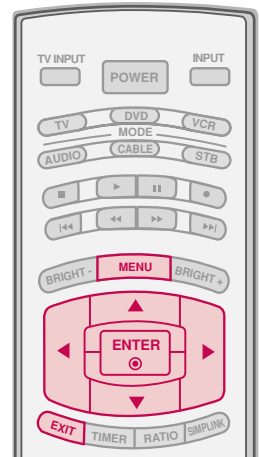

1 Press the **MENU** button and then use ▲ or ▼ button to select the **TIME** menu.

2 Press the ► button and then use ▲ or ▼ button to select **Clock**.

3 Press the ► button and then use ▲ or ▼ button to select **Manual**.

4 Press the ► button and then use ◀ or ▶ button to select either the year, date, or time option. Once selected, use the ▲ or ▼ button to set the year, date, and time options.

5 Press **EXIT** button to return to TV viewing or press **MENU** button to return to the previous menu.

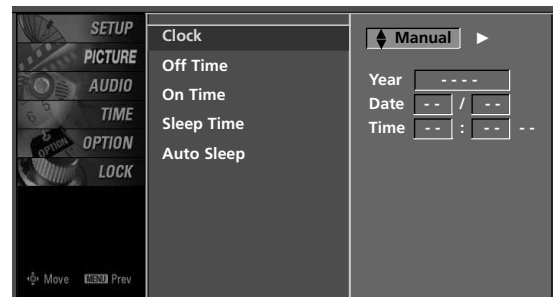

3

AUTO ON/OFF TIMER SETTING

This function operates only if the current time has been set. The **Off Time** function overrides the **On Time** function if they are both set to the same time.

The TV must be in standby mode for the **On Time** to work. If you do not press any button within 2 hours after the TV turns on with the **On Time** function, the TV will automatically revert to standby mode.

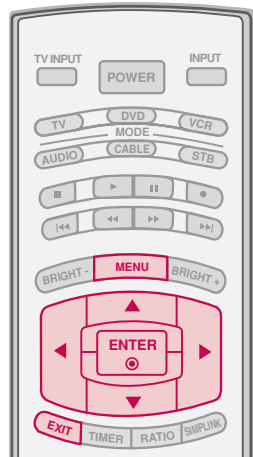

1 Press the **MENU** button and then use ▲ or ▼ button to select the **TIME** menu.

2 Press the ► button and then use ▲ or ▼ button to select **Off Time** or **On Time**.

3 Press the ► button and then use ▲ or ▼ button to select **On**.
 ■ To cancel the **On/Off time** function, select **Off**.

4 Press the ► button and then use ▲ or ▼ button to the hour.

5 Press the ► button and then use ▲ or ▼ button to the minutes.

6 Only On Time
 Press the ► button and then use ▲ or ▼ button to select the channel at turn-on.

Press the ► button and then use ▲ or ▼ button to the sound level at turn-on.

7 Press **EXIT** button to return to TV viewing or press **MENU** button to return to the previous menu.



1

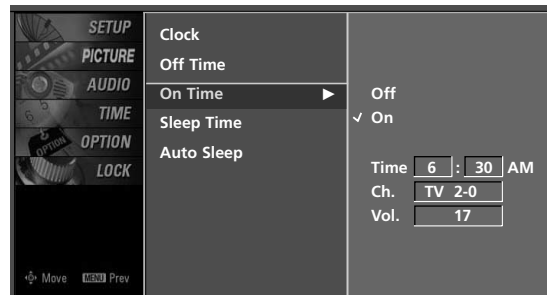

2 3 4 5 6

TIME SETTING

SLEEP TIME SETTING

The Sleep Time turns the TV off at the preset time.
Note that this setting is cleared when the TV is turned off.

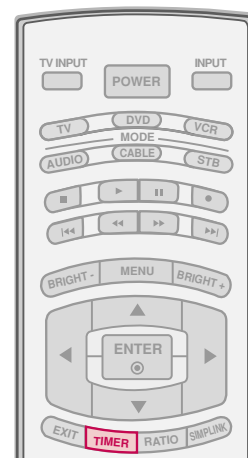

1 Press the **TIMER** button repeatedly to select the number of minutes. First the **Off** option appears on the screen, followed by the following sleep time options: 10, 20, 30, 60, 90, 120, 180, and 240 minutes.

2 When the number of minutes you want is displayed on the screen, press the **ENTER** button. The timer begins to count down from the number of minutes selected.

3 To check the remaining minutes before the TV turns off, press the **TIMER** button once.

4 To cancel the Sleep Time, press the **TIMER** button repeatedly to select **Off**.

■ You can also set up the **Sleep Time** in the **TIME** menu.

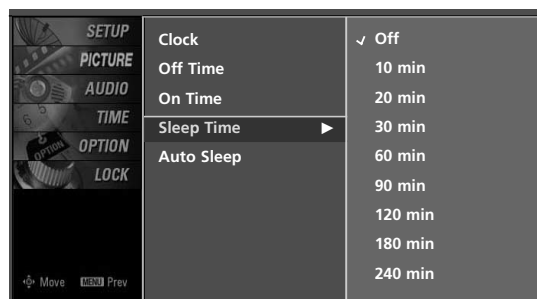

AUTO SHUT-OFF SETTING

TV will be automatically turned off, in case of no signal for 10 minutes.

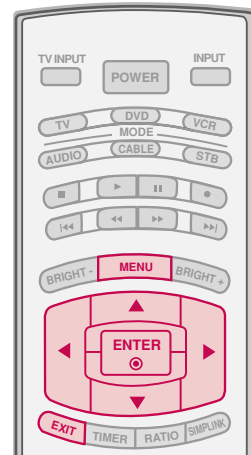

1 Press the **MENU** button and then use ▲ or ▼ button to select the **TIME** menu.

2 Press the ► button and then use ▲ or ▼ button to select **Auto Sleep**.

3 Press the ► button and then use ▲ or ▼ button to select **On** or **Off**.

4 Press **EXIT** button to return to TV viewing or press **MENU** button to return to the previous menu.



1

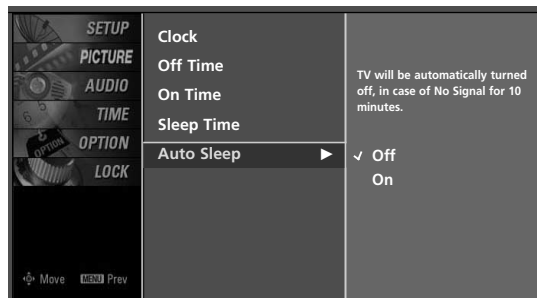

2 3

PARENTAL CONTROL / RATINGS

Parental Control can be used to block specific channels, ratings and other viewing sources.

The Parental Control Function (V-Chip) is used to block program viewing based on the ratings sent by the broadcasting station. The default setting is to allow all programs to be viewed. Viewing can be blocked by choosing the type of the program and the categories. It is also possible to block all program viewing for a time period. To use this function, the following must be done:

1. Set ratings and categories to be blocked.
2. Specify a password
3. Enable the lock

V-Chip rating and categories

Rating guidelines are provided by broadcasting stations. Most television programs and television movies can be blocked by TV Rating and/or Individual Categories. Movies that have been shown at the theaters or direct-to-video movies use the Movie Rating System (MPAA) only.

Ratings for Television programs including made-for-TV movies:

- TV-G (General audience)
- TV-PG (Parental guidance suggested)
- TV-14 (Parents strongly cautioned)
- TV-MA (Mature audience only)
- TV-Y (All children)
- TV-Y7 (Children 7 years older)

SET PASSWORD & LOCK SYSTEM

Setting up Your Password

Set up blocking schemes to block specific channels, ratings, and external viewing sources.

A password is required to gain access to this menu.

1 Press the **MENU** button and then use the **▲** or **▼** button to select the **LOCK** menu. Then, press the **▶** button.

- Enter the password as requested.
- The TV is set up with the initial password "0-0-0-0".

For USA

For Canada

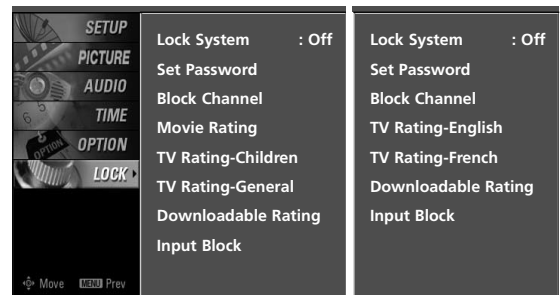

Set Password

Change the password by inputting a new password twice.

- 1 After inputting the password, use the ▲ or ▼ button to choose **Set password**.
- 2 Press the ► button and then choose any 4 digits for your new password.
As soon as the 4 digits are entered, re-enter the same 4 digits on the **Confirm**.
Then your changed password has been memorized.
- 3 Press **EXIT** button to return to TV viewing or press **MENU** button to return to the previous menu.

For USA

For Canada

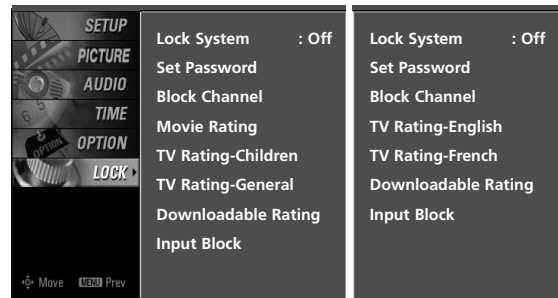

1

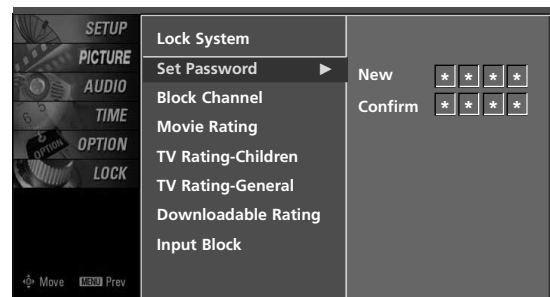

2

Lock System

Enables or disables the blocking scheme you set up previously.

- 1 After inputting the password, use the ▲ or ▼ button to choose **Lock System**.
- 2 Press the ► button and then use the ▲ or ▼ button to select **On** or **Off**.
 - When you select **On**, the Lock System is enable.
- 3 Press **EXIT** button to return to TV viewing or press **MENU** button to return to the previous menu.

For USA

For Canada

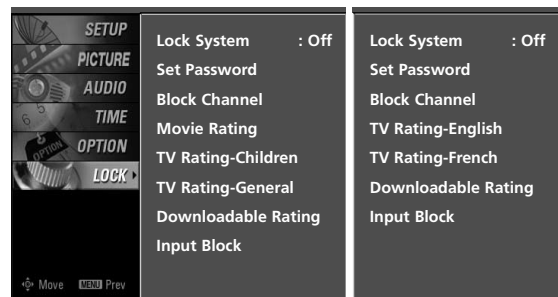

1

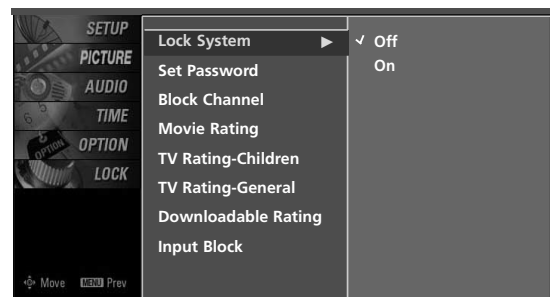

2

PARENTAL CONTROL /RATINGS

CHANNEL BLOCKING

Blocks any channels that you do not want to watch or that you do not want your children to watch.

- 1 After inputting the password, use the ▲ or ▼ button to choose **Block Channel**.
- 2 Press the ► button. You will now see a screen filled with channel numbers and a preview picture.
- 3 Use ▲ ▼ ◀ ▶ button to select a channel and then use the **ENTER** button to block or unblock it.
- 4 Press **EXIT** button to return to TV viewing or press **MENU** button to return to the previous menu.

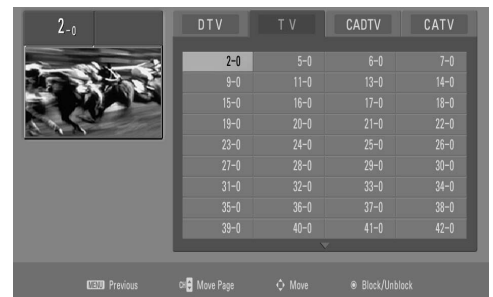
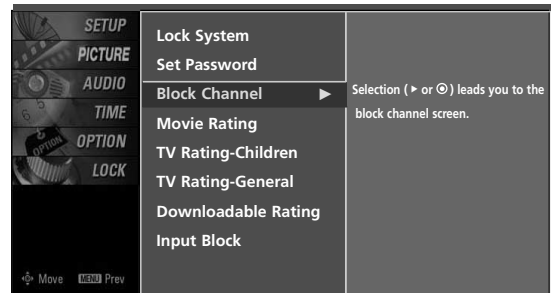

1
2 3

EXTERNAL INPUT BLOCKING

Enables you to select a source to block from the external source devices you have hooked up.

- 1 After inputting the password, use the ▲ or ▼ button to choose **Input Block**.
- 2 Press the ► button and then use the ▲ or ▼ button to select a source.
- 3 Use the ◀ or ▶ button to select **On** or **Off** on the each source.
- 4 Press **EXIT** button to return to TV viewing or press **MENU** button to return to the previous menu.

For USA

For Canada

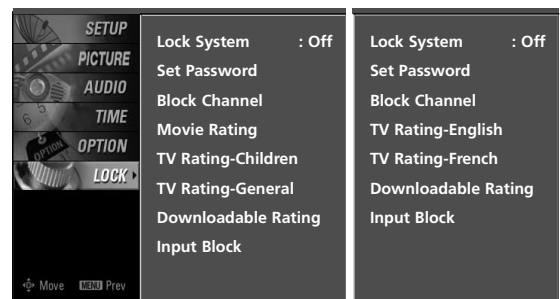

1
2 3

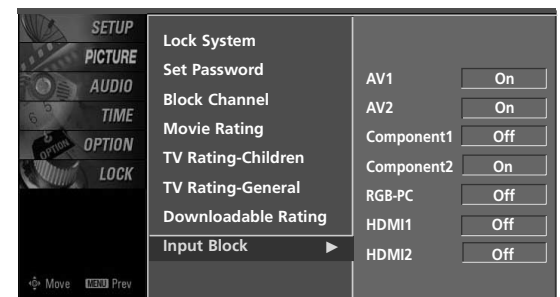

MOVIE & TV RATING

Movie Rating (MPAA) - for USA only

Blocks movies according to the movie ratings limits specified, so children cannot view certain movies. You can set the ratings limit by blocking out all the movies with the ratings above a specified level. Keep in mind that the movie ratings limit only applies to movies shown on TV, not TV programs, such as soap operas.

1 After inputting the password, use the ▲ or ▼ button to choose **Movie Rating**.

2 Press the ► button and then use the ▲ or ▼ button to select **G, PG, PG-13, R, NC-17** or **X**.

- G (General audience)
- PG (Parental guidance suggested)
- PG-13 (Parents strongly cautioned)
- R (Restricted)
- NC-17 (No one 17 and under admitted)
- X (Adult only)
- Blocking Off (Permits all programs)

► If you set PG-13: G and PG movies will be available, PG-13, R, NC-17 and X will be blocked.

3 Press **EXIT** button to return to TV viewing or press **MENU** button to return to the previous menu.

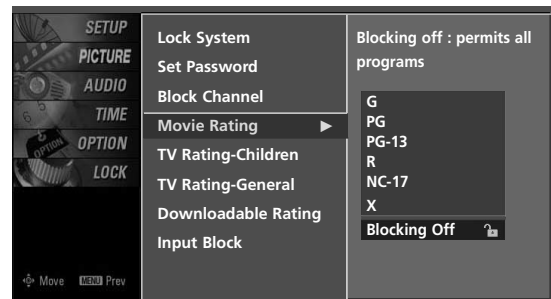
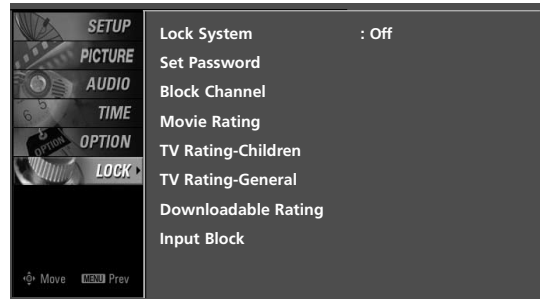

Downloadable Rating

1 After inputting the password, use the ▲ or ▼ button to choose **Downloadable Rating**.

2 Press the ► button and then use the ▲ or ▼ button to select **Dim0, Dim1, Dim2,** or **Dim3**.

3 Press the ► button and then use the ▲ or ▼ button to select **D1L1, D1L2,** or **D1L3**.

4 Press **EXIT** button to return to TV viewing or press **MENU** button to return to the previous menu.

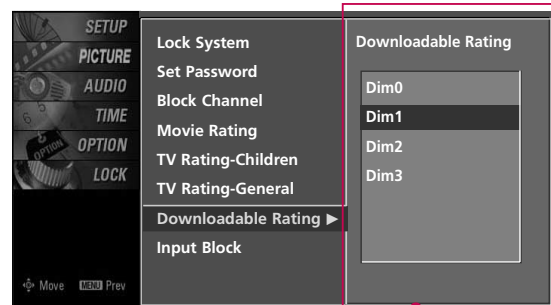
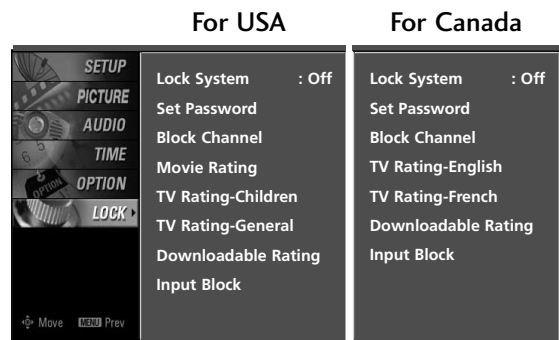

! NOTE

- This function may become available in the future and will be available only for digital channel signal.
- This function operates only when TV has received Region5 Rating data.

► Based on rating table, your TV's OSD (On Screen Display) may differ slightly from what is shown in this manual.

PARENTAL CONTROL /RATINGS

TV Rating Children - for USA only

Prevents children from watching certain children's TV programs, according to the ratings limit set. The children rating does not apply to other TV programs. Unless you block certain TV programs intended for mature audiences in the TV Rating - sub menu, your children can view those programs.

- 1 After inputting the password, use the ▲ or ▼ button to choose **TV Rating-Children**.
- 2 Press the ► button and then use the ▲ or ▼ button to select **Age**, or **Fantasy Violence**.
Press the ► button and then use the ▲ or ▼ button to select block options.
 - Age(applies to TV-Y, TV-Y7)
 - Fantasy Violence(applies to TV-Y7)
- 3 Press **EXIT** button to return to TV viewing or press **MENU** button to return to the previous menu.

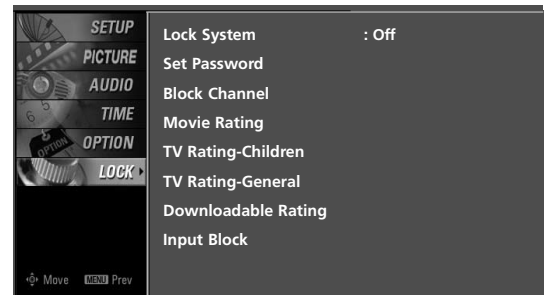

1

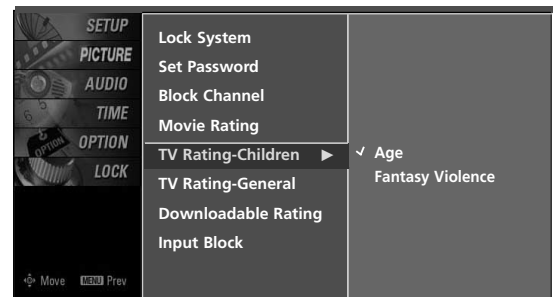

2

TV Rating General - for USA only

Based on the ratings, blocks certain TV programs that you and your family do not want to view.

- 1 After inputting the password, use the ▲ or ▼ button to choose **TV Rating-General**.
- 2 Press the ► button and then use the ▲ or ▼ button to select **Age**, **Dialogue**, **Language**, **Sex** or **Violence**.
Press the ► button and then use the ▲ or ▼ button to select block options.
 - Age(applies to TV-G,TV-PG,TV-14,TV-MA)
 - Dialogue-sexual dialogue (applies to TV-PG,TV-14)
 - Language-adult language (applies to TV-PG,TV-14,TV-MA)
 - Sex-sexual situations (applies to TV-PG,TV-14,TV-MA)
 - Violence (applies to TV-PG,TV-14,TV-MA)
- 3 Press **EXIT** button to return to TV viewing or press **MENU** button to return to the previous menu.

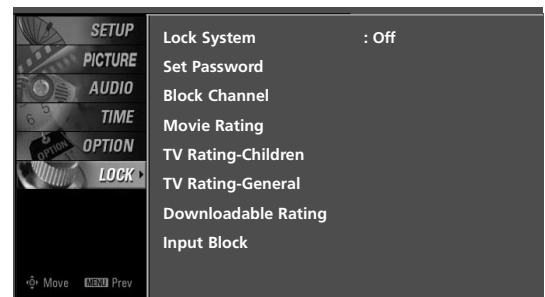

1

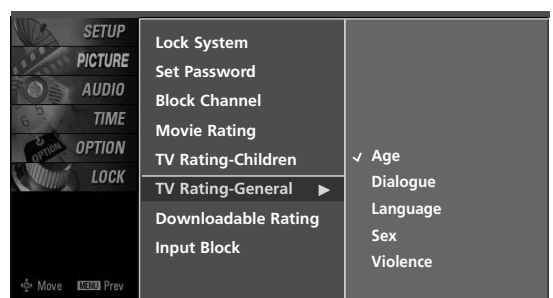

2

TV Rating English - for CANADA only

Selecting canadian english language rating system.

- 1 After inputting the password, use the ▲ or ▼ button to choose **TV Rating-English**.
- 2 Press the ► button and then use the ▲ or ▼ button to select **E, C, C8+, G, PG, 14+, 18+, or Blocking Off**.
 - E (Exempt)
 - C (Children)
 - C8+ (Children eight years and older)
 - G (General programming, suitable for all audiences)
 - PG (Parental Guidance)
 - 14+ (Viewers 14 years and older)
 - 18+ (Adult programming)
 - Blocking Off (Permits all programs)

- 3 Press **EXIT** button to return to TV viewing or press **MENU** button to return to the previous menu.

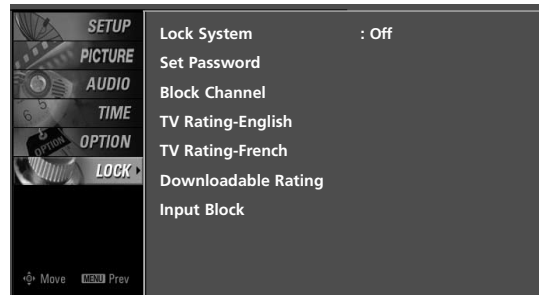

1

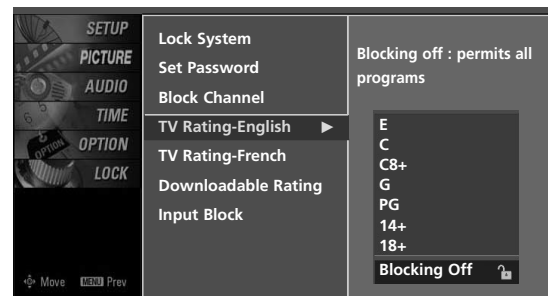

2

TV Rating French - for CANADA only

Selecting canadian french language rating system.

- 1 After inputting the password, use the ▲ or ▼ button to choose **TV Rating-French**.
- 2 Press the ► button and then use the ▲ or ▼ button to select **E, G, 8ans+, 13ans+, 16ans+, 18ans+, or Blocking off**.
 - E(Exempt)
 - G(General)
 - 8ans+ (General-Not convenient for little children)
 - 13ans+ (Not convenient for children of 13 years and younger)
 - 16ans+ (Not convenient for children of 16 years and younger)
 - 18ans+ (This programs is only for adults)
 - Blocking off (Permits all programs)

- 3 Press **EXIT** button to return to TV viewing or press **MENU** button to return to the previous menu.

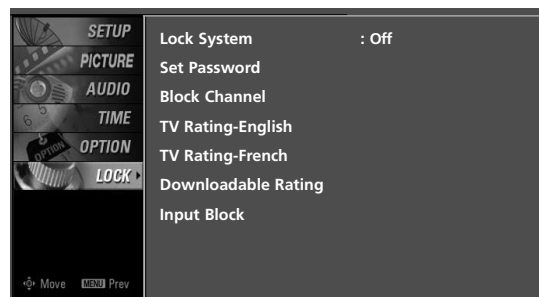

1

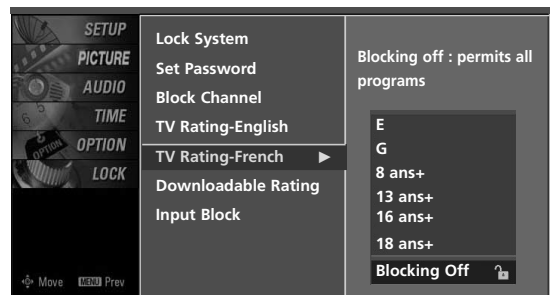

2

APPENDIX

TROUBLESHOOTING

The operation does not work normally.	
The remote control doesn't work	<ul style="list-style-type: none">■ Check to see if there is any object between the product and the remote control causing obstruction. Ensure you are pointing the remote control directly at the TV.■ Ensure that the batteries are installed with correct polarity (+ to +, - to -).■ Ensure that the correct remote operating mode is set: TV, VCR etc.■ Install new batteries.
Power is suddenly turned off	<ul style="list-style-type: none">■ Is the sleep timer set?■ Check the power control settings. Power interrupted.■ No broadcast on station tuned with Auto off activated.

The video function does not work.	
No picture & No sound	<ul style="list-style-type: none">■ Check whether the product is turned on.■ Try another channel. The problem may be with the broadcast.■ Is the power cord inserted into wall power outlet?■ Check your antenna direction and/or location.■ Test the wall power outlet, plug another product's power cord into the outlet where the product's power cord was plugged in.
Picture appears slowly after switching on	<ul style="list-style-type: none">■ This is normal, the image is muted during the product startup process. Please contact your service center, if the picture has not appeared after five minutes.
No or poor color or poor picture	<ul style="list-style-type: none">■ Adjust Color in menu option.■ Keep a sufficient distance between the product and the VCR.■ Try another channel. The problem may be with the broadcast.■ Are the video cables installed properly?■ Activate any function to restore the brightness of the picture.
Horizontal/vertical bars or picture shaking	<ul style="list-style-type: none">■ Check for local interference such as an electrical appliance or power tool.
Poor reception on some channels	<ul style="list-style-type: none">■ Station or cable product experiencing problems, tune to another station.■ Station signal is weak, reorient antenna to receive weaker station.■ Check for sources of possible interference.
Lines or streaks in pictures	<ul style="list-style-type: none">■ Check antenna (Change the direction of the antenna).

The audio function does not work.

Picture OK & No sound	<ul style="list-style-type: none">■ Press the VOL or VOLUME button.■ Sound muted? Press MUTE button.■ Try another channel. The problem may be with the broadcast.■ Are the audio cables installed properly?
No output from one of the speakers	<ul style="list-style-type: none">■ Adjust Balance in menu option.
Unusual sound from inside the product	<ul style="list-style-type: none">■ A change in ambient humidity or temperature may result in an unusual noise when the product is turned on or off and does not indicate a fault with the product.

There is a problem in PC mode. (Only PC mode applied)

The signal is out of range	<ul style="list-style-type: none">■ Adjust resolution, horizontal frequency, or vertical frequency.■ Check the input source.
Vertical bar or stripe on background & Horizontal Noise & Incorrect position	<ul style="list-style-type: none">■ Work the Auto configure or adjust clock, phase, or H/V position. (Option)
Screen color is unstable or single color	<ul style="list-style-type: none">■ Check the signal cable.■ Reinstall the PC video card.

APPENDIX

MAINTENANCE

Early malfunctions can be prevented. Careful and regular cleaning can extend the amount of time you can enjoy your new TV.

Caution: Be sure to turn the power off and unplug the power cord before you begin any cleaning.

Cleaning the Screen

- 1 Here's a great way to keep the dust off your screen for a while. Wet a soft cloth in a mixture of lukewarm water and a little fabric softener or dish washing detergent. Wring the cloth until it's almost dry, and then use it to wipe the screen.
- 2 Make sure the excess water is off the screen, and then let it air-dry before you turn on your TV.

Cleaning the Cabinet

- To remove dirt or dust, wipe the cabinet with a soft, dry, lint-free cloth.
- Please be sure not to use a wet cloth.

Extended Absence

CAUTION

- ▶ If you expect to leave your TV dormant for a long time (such as a vacation), it's a good idea to unplug the power cord to protect against possible damage from lightning or power surges.

PRODUCT SPECIFICATIONS

■ The specifications shown above may be changed without prior notice for quality improvement.

MODELS		42PC3DB (42PC3DB-UL) 42PC5D (42PC5D-UL)	50PC3DB (50PC3DB-UL) 50PC5D (50PC5D-UL)
Dimensions (Width x Height x Depth)	Including stand	41.3 x 30.2 x 12.2 inches 1048.0 x 766.0 x 310.0 mm	48.9 x 34.9 x 14.6 inches 1242.0 x 887.6 x 370.0 mm
	Excluding stand	41.3 x 28.1 x 3.3 inches 1048.0 x 713.0 x 83.5 mm	48.9 x 32.6 x 3.5 inches 1242.0 x 827.2 x 88.0 mm
Weight	including stand	61.7 pounds / 28.0 kg	86.6 pounds / 39.3 kg
	excluding stand	54.2 pounds / 24.6 kg	76.3 pounds / 34.6 kg
Power requirement Television System Program Coverage External Antenna Impedance		AC100-240V ~ 50/60Hz NTSC-M, ATSC, 64 & 256 QAM VHF 2-13, UHF 14-69, CATV 1-135, DTV 2-69, CADTV 1-135 75 ohm	
Environment condition	Operating Temperature Operating Humidity	32 ~ 104°F (0 ~ 40°C) Less than 80%	
	Storage Temperature Storage Humidity	-4 ~ 140°F (-20 ~ 60°C) Less than 85%	

APPENDIX

MODELS		32LC7D (32LC7D-UK) 32LC7DC (32LC7DC-UK)	37LC7D (37LC7D-UK)	42LC7D (42LC7D-UK)
Dimensions (Width x Height x Depth)	Including stand	31.8 x 23.9x 9.8 inches 806.6 x 606.5 x 249.0mm	36.5 x 27.3 x 11.0 inches 927.0 x 692.8 x 280.5 mm	40.7 x 29.5 x 11.3 inches 1033.4 x 750.0 x 287.6 mm
	Excluding stand	31.8 x 21.7 x 3.1 inches 806.6 x 552.3 x 79.0 mm	36.5 x 24.8 x 3.5 inches 927.0 x 630.0 x 88.0 mm	40.7 x 27.0x 3.5 inches 1033.4 x 686.8 x 88.5 mm
Weight	including stand	30.2 pounds / 13.7 kg	44.1 pounds / 20.0 kg	54.9 pounds / 24.9 kg
	excluding stand	24.7 pounds / 11.2 kg	35.3 pounds / 16.0 kg	45.0 pounds / 20.4 kg
Power requirement Television System Program Coverage External Antenna Impedance		AC100-240V ~ 50/60Hz NTSC-M, ATSC, 64 & 256 QAM VHF 2-13, UHF 14-69, CATV 1-135, DTV 2-69, CADTV 1-135 75 ohm		
Environment condition	Operating Temperature Operating Humidity	32 ~ 104°F (0 ~ 40°C) Less than 80%		
	Storage Temperature Storage Humidity	-4 ~ 140°F (-20 ~ 60°C) Less than 85%		

PROGRAMMING THE REMOTE CONTROL

The provided universal remote control can be programmed to operate most remote-controllable devices. Note that the remote may not control all models of other brands.

Programming a code into a remote mode

- 1** To find out whether your remote control can operate each device without programming, turn on the device (such as a VCR) and press the corresponding mode button on the remote. After that, press the **POWER** button. If the device is turned off and it responds properly the remote control need not be programmed. If not, the remote should be programmed to operate the device. The programming procedures are explained below.
- 2** Press the **MENU** and **MUTE** button continuously at the same time for two seconds; the currently selected device button is illuminated. If you don't press any button for 20 seconds, the light on the mode button will be turned off. In that case, you have to repeat from step 2.
- 3** Enter the appropriate code from the code table on the following pages. When pressing the button, the light blinks at a time. If the device turned off, the programming is successful.
- 4** Press the **MENU** button to store the code. After blinking twice, this code is stored.
- 5** Test the remote control functions to see if the device responds properly. If not, steps 2-5.

APPENDIX

Remote Control Code

VCR

Brand	Codes	Brand	Codes	Brand	Codes
AIWA	034	MAGNAVOX	031 033 034 041	SAMSUNG	032 040 102 104
AKAI	016 043 046 124		067 068		105 107 109 112
	125 146	MARANTZ	012 031 033 067		113 115 120 122
AMPRO	072		069		125
ANAM	031 033 103	MARTA	101	SANSUI	022 043 048 135
AUDIO DYNAMICS	012 023 039 043	MATSUI	027 030	SANYO	003 007 010 014
BROKSONIC	035 037 129	MEI	031 033		102 134
CANON	028 031 033	MEMOREX	003 010 014 031	SCOTT	017 037 112 129
CAPEHART	108		033 034 053 072		131
CRAIG	003 040 135		101 102 134 139	SEARS	003 008 009 010
CURTIS MATHES	031 033 041	MGA	045 046 059		013 014 017 020
DAEWOO	005 007 010 064	MINOLTA	013 020		031 042 073 081
	065 108 110 111	MITSUBISHI	013 020 045 046		101
	112 116 117 119		049 051 059 061	SHARP	031 054 149
DAYTRON	108		151	SHINTOM	024
DBX	012 023 039 043	MTC	034 040	SONY	003 009 031 052
DYNATECH	034 053	MULTITECH	024 034		056 057 058 076
ELECTROHOME	059	NEC	012 023 039 043		077 078 149
EMERSON	006 017 025 027		048	SOUNDESIGN	034
	029 031 034 035	NORDMENDE	043	STS	013
	036 037 046 101	OPTONICA	053 054	SYLVANIA	031 033 034 059
	129 131 138 153	PANASONIC	066 070 074 083		067
FISHER	003 008 009 010		133 140 145	SYMPHONIC	034
FUNAI	034			TANDY	010 034
GE	031 033 063 072	PENTAX	013 020 031 033	TATUNG	039 043
	107 109 144 147		063	TEAC	034 039 043
GO VIDEO	132 136	PHILCO	031 034 067	TECHNICS	031 033 070
HARMAN KARDON	012 045	PHILIPS	031 033 034 054	TEKNIKA	019 031 033 034
HITACHI	004 018 026 034		067 071 101		101
	043 063 137 150	PILOT	101	THOMAS	034
INSTANTREPLAY	031 033	PIONEER	013 021 048	TMK	006
JCL	031 033	PORTLAND	108	TOSHIBA	008 013 042 047
JCPENNY	012 013 015 033	PULSAR	072		059 082 112 131
	040 066 101	QUARTZ	011 014	TOTEVISION	040 101
JENSEN	043	QUASAR	033 066 075 145	UNITECH	040
JVC	012 031 033 043	RCA	013 020 033 034	VECTOR RESEARCH	012
	048 050 055 060		040 041 062 063	VICTOR	048
	130 150 152		107 109 140 144	VIDEO CONCEPTS	012 034 046
KENWOOD	014 034 039 043		145 147	VIDEOSONIC	040
	047 048	REALISTIC	003 008 010 014	WARDS	003 013 017 024
LG (GOLDSTAR)	001 012 013 020		031 033 034 040		031 033 034 040
	101 106 114 123		053 054 101		053 054 131
LLOYD	034	RICO	058	YAMAHA	012 034 039 043
LXI	003 009 013 014	RUNCO	148	ZENITH	034 048 056
	017 034 101 106	SALORA	014		058 072 080 101
MAGIN	040				

Cable Box

Brand	Codes	Brand	Codes	Brand	Codes
ABC	003 004 039 042 046 052 053	LG (GOLDSTAR)	074 001 106 101 005	REMBRANT	025
AJIN	112	M-NET	037	SAMSUNG	102 107 030 068
ANTRONIK	014	MACOM	033	SCIENTIFIC ATLANTA	003 011 041 042 043 045 046
ARCHER	005 007 014 024	MAGNAVOX	010 012 064 079	SHERITECH	022
CABLE STAR	026	MEMOREX	100	SIGNAL	030
CENTURION	092	MOVIE TIME	028 032	SIGNATURE	052
CENTURY	007	NSC	015 028 038 071 073	SL MARX	030
CITIZEN	007	OAK	016 031 037 053	SPRUCER	047 078
COLOUR VOICE	065 090	PANASONIC	044 047	STARCOM	002 004 008 009
COMBANO	080 081	PARAGON	100	STARGATE	008 030
COMTRONICS	019 030	PHILIPS	006 012 013 020 065 085 090	TADIRAN	030
DIAMOND	023	PIONEER	034 051 052 063 076	TAEKWANG	110
EAGLE	020 030 040	POST NEWS WEEK	016	TAIHAN	105
EASTERN	057 062 066	PRUCER	059	TANDY	017
ELECTRICORD	032	PTS	011 048 071 072 073 074	TEXSCAN	029
GE	072	PULSAR	100	TOCOM	039 040 056
GEMINI	008 022 025 054	RCA	047	TOSHIBA	100
GI	052 074	REGAL	049 050	UNIKA	007 014 024
GOLDEN CHANNEL	030	REGENCY	057	UNITED CABLE	004 053
HAMLIN	049 050 055			UNIVERSAL	005 007 014 024 026 027 032 035
HITACHI	052 055			VIEWSTAR	012 015 018 086 087 088 089
HOSPITALITY	070 077			ZENITH	100 114 060 093
JERROLD	002 003 004 008 009 010 052 069				

HDSTB

Brand	Codes	Brand	Codes	Brand	Codes
ALPHASTAR DSR	123	HOUSTON TRACKER	033 037 039 051	PROSAT	072
AMPLICA	050	HUGHES	057 104	RCA	066 106
BIRDVIEW	051 126 129	JANIEL	060 147	REALISTIC	043 074
CHANNEL MASTER	013 014 015 018 036 055	JERROLD	061	SAMSUNG	123
CHAPARRAL	008 009 012 077	KATHREIN	108	SATELLITE SERVICE CO	028 035 047 057 085
CITOH	054	LEGEND	057	SCIENTIFIC ATLANTA	032 138
CURTIS MATHES	050 145	LG	001	SONY	103
DRAKE	005 006 007 010 011 052 112 116 141	LUTRON	132	STARCAST	041
DX ANTENNA	024 046 056 076	LUXOR	062 144	SUPER GUIDE	020 124 125
ECHOSTAR	038 040 057 058 093 094 095 096 097 098 099 100 122	MACOM	010 059 063 064 065	TEECOM	023 026 075 087 088 090 107 130 137
ELECTRO HOME	089	MEMOREX	057	TOSHIBA	002 127
EUROPLUS	114	NEXTWAVE	028 124 125	UNIDEN	016 025 042 043 044 045 048 049 078 079 080 086 101 135 136
FUJITSU	017 021 022 027 133 134	NORSAT	069 070	VIEWSTAR	115
GENERAL INSTRUMENT	003 004 016 029 031 059 101	PACE SKY SATELLITE	143	WINEGARD	128 146
HITACHI	139 140	PANASONIC	060 142	ZENITH	081 082 083 084 091 120
		PANSAT	121		
		PERSONAL CABLE	117		
		PHILIPS	071		
		PICO	105		
		PRESIDENT	019 102		
		PRIMESTAR	030 110 111		

APPENDIX

Audio

Brand	Codes	Brand	Codes	Brand	Codes
AIWA	014 028 070 096 125 129 139 229 230		157 158 159 160 189 207 222 224 225 226 227 243 247	RCX	092
AKAI	163			REALISTIC	103 106
ANAM	003 014 017 023 059 106 189 216 217 235 236	LOTTE	014 016 036 098 100 172 173 174 175 176 177 178 179 180 181 183 201 202 208 213 214 219 223 232 238 240	SAMSUNG	124 145 146 182 193 194 195 203 204 244 245 246
BURMECTER	252			SANSUI	011 135 138 144
CARVER	086			SANYO	019 083 234
CLARION	199			SCOTT	106 186
DAEWOO	027 053 060 084 102 148 198 221	LXI	103	SHARP	031 032 051 052 072 082 117 119 156 184 199 200 206 209
DENON	015 075 130 143	MAGNAVOX	111	SHERWOOD	005 006 158
FANTASIA	071	MARANTZ	002 018 020 025 034 041 081 090 097 112	SONY	044 045 109 114 118 126 248 249
FINEARTS	022			TAEKWANG	012 020 073 074 076 077 105 161 162 163 164 165 166 167 168 169 205 231 233 242
FISHER	089 099	MCINTOSH	049		
LG(GOLDSTAR)	001 021 024 029 087 107 108 110 190 191 192 210 211 212 239	MCS	104		
		MEMOREX	107		
		NAD	046		
HAITAI	034 035 188 222	ONKYO	013 040 041 047 048 056 057 132 133 140	TEAC	010 085 106 136 185 187 237
HARMAN/KARDON	068			TECHNICS	101 113 128 134 147 218
JVC	004 013 141	OPTIMUS	158	TOSHIBA	137
KEC	185 186 187	PANASONIC	007 033 064 113 142 220 241 251	THE	061
KOHEL	030	PENNEY	104	VICTOR	088 131
NAD	045 046	PHILIPS	026 112 143	WARDS	089
KENWOOD	038 050 067 089 170 171 197 206 215 222	PIONEER	039 042 043 063 065 091 093 094 115 123 127 250	YAMAHA	054 055 066 092 199
INKEL	037 058 062 069 078 079 095 121 122 149 150 151 152 153 154 155	QUASAR	113		
		RCA	080		

DVD

Brand	Codes	Brand	Codes	Brand	Codes
APEX DIGITAL	022	MITSUBISHI	002	RCA	005 006
DENON	020 014	NAD	023	SAMSUNG	011 015
GE	005 006	ONKYO	008 017	SONY	007
HARMAN KARDON	027	PANASONIC	003 009	THOMPSON	005 006
JVC	012	PHILIPS	013	TOSHIBA	019 008
LG	001 010 016 025	PIONEER	004 026	YAMAHA	009 018
MAGNAVOX	013	PROCEED	021	ZENITH	010 016 025
MARANTZ	024	PROSCAN	005 006		

IR CODES

1. How to Connect

- Connect your wired remote control to the Remote Control port on the TV.

2. Remote Control IR Codes

Output waveform

Single pulse, modulated with 37.917KHz signal at 455KHz

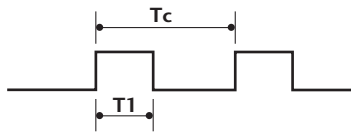

Carrier frequency
 $FCAR = 1/Tc = fOSC/12$
 Duty ratio = $T1/Tc = 1/3$

Configuration of frame

1st frame

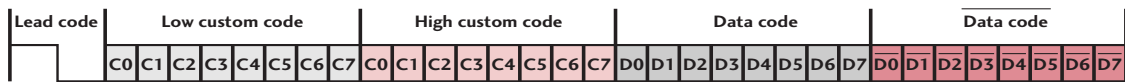

Repeat frame

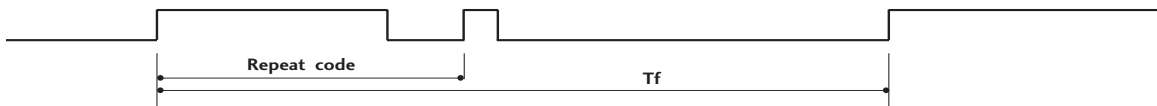

Lead code

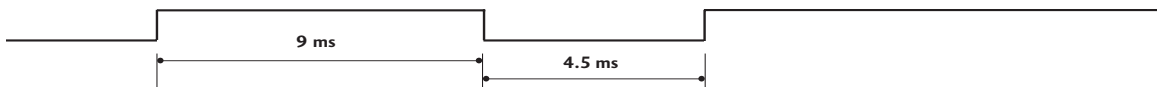

Repeat code

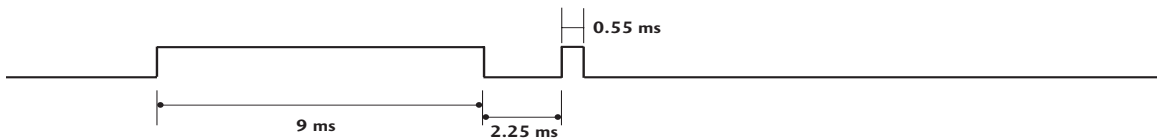

Bit description

Bit "0"

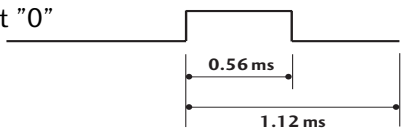

Bit "1"

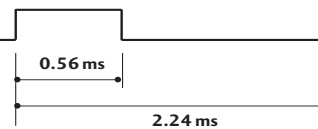

Frame interval: Tf

The waveform is transmitted as long as a key is depressed.

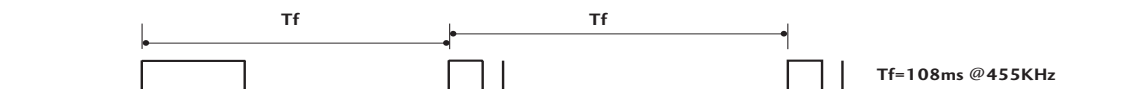

APPENDIX

Code (Hexa)	Function	Note	Code (Hexa)	Function	Note
0F	TV INPUT	Remote control Button	BF	COMPONENT1	Discrete IR Code
0B	INPUT	Remote control Button			(Component1 Input Selection)
08	POWER	Remote control Button (Power On/Off)	D4	COMPONENT2	Discrete IR Code
79	RATIO	Remote control Button			(Component2 Input Selection)
0E	TIMER	Remote control Button	D5	RGB-PC	Discrete IR Code
10-19	Number Key 0-9	Remote control Button			(RGB-PC Input Selection)
4C	- (Dash)	Remote control Button	CE	HDMI1	Discrete IR Code
1A	BACK	Remote control Button			(HDMI1 Input Selection)
09	MUTE	Remote control Button	CC	HDMI2	Discrete IR Code
02	VOL ▲	Remote control Button			(HDMI2 Input Selection)
03	VOL ▼	Remote control Button	76	Ratio 4:3	Discrete IR Code
00	CH ▲	Remote control Button			(Only 4:3 Mode)
01	CH ▼	Remote control Button	77	Ratio 16:9	Discrete IR Code
1E	FAV	Remote control Button			(Only 16:9 Mode)
7E	SIMPLINK	Remote control Button	AF	Ratio Zoom	Discrete IR Code
39	CC	Remote control Button			(Only Zoom1 Mode)
40	▲	Remote control Button			
41	▼	Remote control Button			
07	◀	Remote control Button			
06	▶	Remote control Button			
44	ENTER	Remote control Button			
43	MENU	Remote control Button			
52	SOUND	Remote control Button			
4D	PICTURE	Remote control Button			
5B	EXIT	Remote control Button			
0A	SAP	Remote control Button			
CB	ADJUST	Remote control Button			
E1	BRIGHT -	Remote control Button			
E0	BRIGHT +	Remote control Button			
D6	TV	Discrete IR Code			
		(TV Input Selection)			
C4	POWER ON	Discrete IR Code			
		(Only Power On)			
C5	POWER OFF	Discrete IR Code			
		(Only Power Off)			
5A	AV1	Discrete IR Code			
		(AV1 Input Selection)			
D0	AV2	Discrete IR Code			
		(AV2 Input Selection)			

EXTERNAL CONTROL THROUGH RS-232C

The RS-232C port allows you connect the RS-232C input jack to an external control device (such as a computer or an A/V control system) to control the TV's functions externally.

- Note: RS-232C on this unit is intended to be used with third party RS-232 control hardware and software. The instructions below are provided to help with programming software or to test functionality using telenet software.

RS-232C Setup

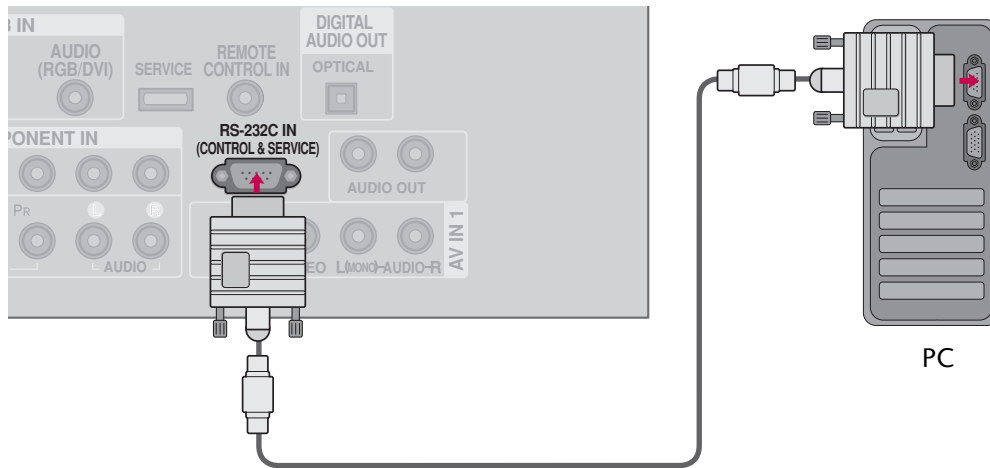

Type of Connector; D-Sub 9-Pin Male

No.	Pin Name
1	No connection
2	RXD (Receive data)
3	TXD (Transmit data)
4	DTR (DTE side ready)
5	GND
6	DSR (DCE side ready)
7	RTS (Ready to send)
8	CTS (Clear to send)
9	No Connection

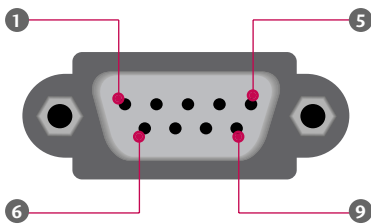

APPENDIX

RS-232C Configurations

Either cable below can be used.

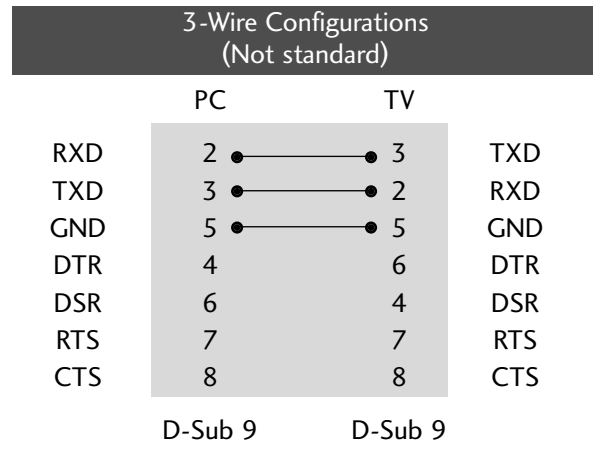
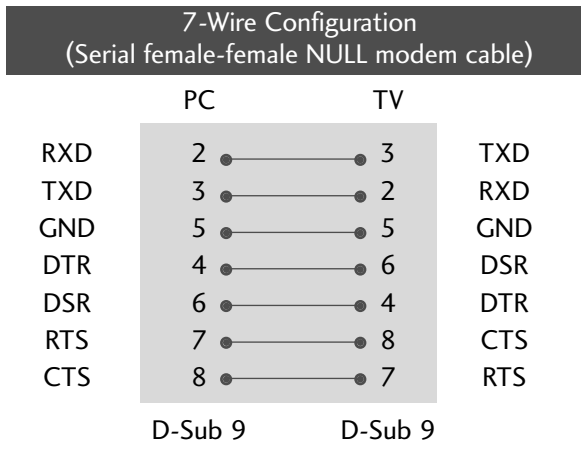

Set ID

Use this function to specify a TV ID number.
Refer to 'Real Data Mapping'. ▶ p.93.

- 1 Press the **MENU** button and then use ▲ or ▼ button to select the **OPTION** menu.
- 2 Press the ► button and then use ▲ or ▼ button to select **Set ID**.
- 3 Press the ► button and then use ▲ or ▼ button to adjust **Set ID** to choose the desired TV ID number. The adjustment range of Set ID is 1~99.
- 4 Press **EXIT** button to return to TV viewing or press **MENU** button to return to the previous menu.

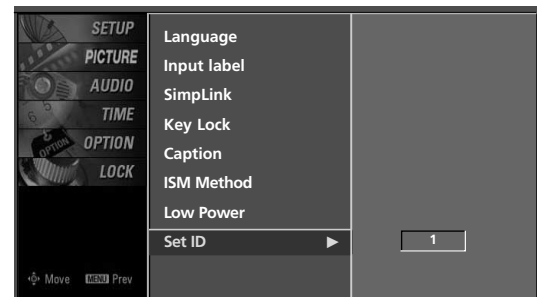
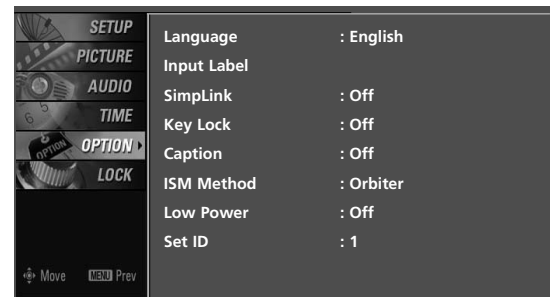
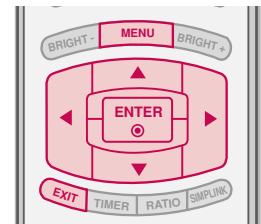

Communication Parameters

- Baud rate: 9600 bps (UART)
- Data length: 8 bits
- Parity: None
- Stop bit: 1 bit
- Communication code: ASCII code
- Use a crossed (reverse) cable.

NOTE ▶ This product has command echo back in the RS-232C Command.

Command Reference List

	COMMAND1	COMMAND2	DATA (Hexadecimal)		COMMAND1	COMMAND2	DATA (Hexadecimal)
01. Power	k	a	0 ~ 1	15. Treble	k	r	0 ~ 64
02. Input Select	k	b	(▶ p.92)	16. Bass	k	s	0 ~ 64
03. Input Select	x	b	(▶ p.92)	17. Balance	k	t	0 ~ 64
04. Aspect Ratio	k	c	(▶ p.92)	18. Color Temperature	k	u	0 ~ 3
05. Screen Mute	k	d	0 ~ 1	19. Red Adjustment	k	v	0 ~ C8
06. Volume Mute	k	e	0 ~ 1	20. Green Adjustment	k	w	0 ~ C8
07. Volume Control	k	f	0 ~ 64	21. Blue Adjustment	k	\$	0 ~ C8
08. Contrast	k	g	0 ~ 64	22. ISM Method	j	p	(▶ p.94)
09. Brightness	k	h	0 ~ 64	23. Low Power	j	q	0 ~ 1
10. Color	k	i	0 ~ 64	25. Channel Add/Del	m	b	0 ~ 1
11. Tint	k	j	0 ~ 64	26. Key	m	c	(▶ p.95)
12. Sharpness	k	k	0 ~ 64	27. Back Light	m	g	0 ~ 64
13. OSD Select	k	l	0 ~ 1	LCD TV Model Only			
14. Remote Control Lock Mode	k	m	0 ~ 1	Plasma TV Model Only			

	COMMAND1	COMMAND2	DATA0 (Hexadecimal)	DATA1 (Hexadecimal)	DATA2 (Hexadecimal)	DATA3 (Hexadecimal)	DATA4 (Hexadecimal)	DATA5 (Hexadecimal)
24. Channel Tuning	m	a	physical program high	major program low	major low	minor high	minor low	attribute

Transmission / Receiving Protocol

Transmission

[Command1][Command2][][Set ID][][Data][Cr]

[Command 1]: First command to control the set.(j, k, m or x)

[Command 2]: Second command to control the set.

[Set ID] : You can adjust the set ID to choose desired TV ID number in Setup menu. Adjustment range is 1 ~ 99. When selecting Set ID '0', every connected the TV is controlled. Set ID is indicated as decimal (1 ~ 99) on menu and as Hexa decimal (0x0 ~ 0x63) on transmission /receiving protocol.

[DATA]: To transmit the command data.

Transmit the 'FF' data to read status of command.

[Cr]: Carriage Return

ASCII code '0x0D'

[]: ASCII code 'space (0x20)'

* In this model, TV will not send the status during the standby mode.

OK Acknowledgement

[Command2][][Set ID][][OK][Data][x]

The TV transmits ACK (acknowledgement) based on this format when receiving normal data. At this time, if the data is data read mode, it indicates present status data. If the data is data write mode, it returns the data of the PC computer.

* In this model, TV will not send the status during the standby mode.

* Data Format

[Command 2]: Use as command.

[Set ID]: Use the small character, if set ID is 10, it will send the '0', 'a'.

[DATA]: Use the small character, if data is 0 x ab, it will send the 'a', 'b'.

[OK]: Use the large character.

Error Acknowledgement

[Command2][][Set ID][][NG][Data][x]

The TV transmits ACK (acknowledgement) based on this format when receiving abnormal data from non-viable functions or communication errors.

Data1: Illegal Code

Data2: Not supported function

Data3: Wait more time

* In this model, TV will not send the status during the standby mode.

* Data Format

[Command 2]: Use as command.

[Set ID]: Use the small character, if set ID is 10, it will send the '0', 'a'.

[DATA]: Use the small character, if data is 0 x ab, it will send the 'a', 'b'.

[NG]: Use the large character

01. Power (Command: k a)

To control Power On/Off of the TV.

Transmission [k][a][][Set ID][][Data][Cr]

Data 0: Power Off Data 1: Power On

Acknowledgement [a][][Set ID][][OK/NG][Data][x]

* In a like manner, if other functions transmit 'FF' data based on this format, Acknowledgement data feedback presents status about each function.

* Note: In this model, TV will send the Acknowledge after power on processing completion.

There might be a time delay between command and acknowledge.

02. Input Select (Command: k b) (Main Picture Input)

To select input source for the TV.

Transmission [k][b][][Set ID][][Data][Cr]

Data 0: DTV Data 1: Analog
 Data 2: AV1 Data 3: AV2
 Data 4: Component 1 Data 5: Component 2
 Data 7: RGB-PC Data 8: HDMI1
 Data 9: HDMI2

Acknowledgement [b][][Set ID][][OK/NG][Data][x]

* If you select input source, we recommend "command x b".

03. Input Select (Command: x b)

To select input source for TV.

Transmission [x][b][][Set ID][][Data][Cr]

Data 00: DTV (Antenna) Data 01: DTV (Cable)
 Data 10: Analog (Antenna) Data 11: Analog (Cable)
 Data 20: AV1 Data 21: AV2
 Data 40: Component 1 Data 41: Component 2
 Data 60: RGB-PC Data 90: HDMI1
 Data 91: HDMI2

Acknowledgement [b][][Set ID][][OK/NG][Data][x]

04. Aspect Ratio (Command: k c)

To adjust the screen format.

You can also adjust the screen format using the RATIO button on remote control or in the Picture menu.

Transmission [k][c][][Set ID][][Data][Cr]

Data 1: 4:3 5: Zoom 2
 2: 16:9 6: Set by program
 4: Zoom 1 9: Just scan
 ⋮
 Reserved

Acknowledgement [c][][Set ID][][OK/NG][Data][x]

05. Screen Mute (Command: k d)

To select screen mute on/off.

Transmission [k][d][][Set ID][][Data][Cr]

Data 0: Screen mute off (Picture on)

Data 1: Screen mute on (Picture off)

Acknowledgement [d][][Set ID][][OK/NG][Data][x]

06. Volume Mute (Command: k e)

To control volume mute on/off.

You can also adjust mute using the MUTE button on remote control.

Transmission [k][e][][Set ID][][Data][Cr]

Data 0: Volume mute on (Volume off)

Data 1: Volume mute off (Volume on)

Acknowledgement [e][][Set ID][][OK/NG][Data][x]

07. Volume Control (Command: k f)

To adjust volume.

You can also adjust volume with the volume buttons on remote control.

Transmission [k][f][][Set ID][][Data][Cr]

Data Min: 0 ~ Max: 64 (*transmit by Hexadecimal code)

*Refer to 'Real data mapping 1'. See page 93.

Acknowledgement [f][][Set ID][][OK/NG][Data][x]

08. Contrast (Command: k g)

To adjust screen contrast.

You can also adjust contrast in the Picture menu.

Transmission [k][g][][Set ID][][Data][Cr]

Data Min: 0 ~ Max: 64 (*transmit by Hexadecimal code)

*Refer to 'Real data mapping 1'. See page 93.

Acknowledgement [g][][Set ID][][OK/NG][Data][x]

09. Brightness (Command: k h)

To adjust screen brightness.

You can also adjust brightness in the Picture menu.

Transmission [k][h][][Set ID][][Data][Cr]

Data Min: 0 ~ Max: 64 (*transmit by Hexadecimal code)

*Refer to 'Real data mapping 1'. See page 93.

Acknowledgement [h][][Set ID][][OK/NG][Data][x]

10. Color (Command: k i)

To adjust screen color.

You can also adjust color in the Picture menu.

Transmission [k][i][][Set ID][][Data][Cr]

Data Min: 0 ~ Max: 64 (*transmit by Hexadecimal code)

*Refer to 'Real data mapping 1' as shown below.

Acknowledgement [i][][Set ID][][OK/NG][Data][x]

11. Tint (Command: k j)

To adjust screen tint.

You can also adjust tint in the Picture menu.

Transmission [k][j][][Set ID][][Data][Cr]

Data Red: 0 ~ Green: 64 (*transmit by Hexadecimal code)

*Refer to 'Real data mapping 1' as shown below.

Acknowledgement [j][][Set ID][][OK/NG][Data][x]

12. Sharpness (Command: k k)

To adjust screen sharpness.

You can also adjust sharpness in the Picture menu.

Transmission [k][k][][Set ID][][Data][Cr]

Data Min: 0 ~ Max: 64 (*transmit by Hexadecimal code)

*Refer to 'Real data mapping 1' as shown below.

Acknowledgement [k][][Set ID][][OK/NG][Data][x]

13. OSD Select (Command: k l)

To select OSD (On Screen Display) on/off.

Transmission [k][l][][Set ID][][Data][Cr]

Data 0: OSD off Data 1: OSD on

Acknowledgement [l][][Set ID][][OK/NG][Data][x]

14. Remote Control Lock Mode (Command: k m)

To lock the remote control and the front panel controls on the set.

Transmission [k][m][][Set ID][][Data][Cr]

Data 0: Lock off Data 1: Lock on

Acknowledgement [m][][Set ID][][OK/NG][Data][x]

If you're not using the remote control and front panel controls on the TV, use this mode. When main power is on/off, remote control lock is released.

15. Treble (Command: k r)

To adjust treble.

You can also adjust treble in the Audio menu.

Transmission [k][r][][Set ID][][Data][Cr]

Data Min: 0 ~ Max: 64 (*transmit by Hexadecimal code)

*Refer to 'Real data mapping 1' as shown.

Acknowledgement [r][][Set ID][][OK/NG][Data][x]

16. Bass (Command: k s)

To adjust bass.

You can also adjust bass in the Audio menu.

Transmission [k][s][][Set ID][][Data][Cr]

Data Min: 0 ~ Max: 64 (*transmit by Hexadecimal code)

*Refer to 'Real data mapping 1' as shown below.

Acknowledgement [s][][Set ID][][OK/NG][Data][x]

17. Balance (Command: k t)

To adjust balance.

You can also adjust balance in the Audio menu.

Transmission [k][t][][Set ID][][Data][Cr]

Data Min: 0 ~ Max: 64 (*transmit by Hexadecimal code)

*Refer to 'Real data mapping 1' as shown below.

Acknowledgement [t][][Set ID][][OK/NG][Data][x]

18. Color Temperature (Command: k u)

To adjust color temperature.

You can also adjust color temperature in the Picture menu.

Transmission [k][u][][Set ID][][Data][Cr]

Data 0: Medium 1: Cool 2: Warm 3: User

Acknowledgement [u][][Set ID][][OK/NG][Data][x]

19. Red Adjustment (Command: k v)

To adjust red in color temperature

Transmission [k][v][][Set ID][][Data][Cr]

Data Min: 0 ~ Max: C8

*Refer to 'Real data mapping 2' as shown below.

Acknowledgement [v][][Set ID][][OK/NG][Data][x]

20. Green Adjustment (Command: k w)

To adjust green in color temperature.

Transmission [k][w][][Set ID][][Data][Cr]

Data Min: 0 ~ Max: C8

*Refer to 'Real data mapping 2' as shown below.

Acknowledgement [w][][Set ID][][OK/NG][Data][x]

*Real data mapping 1	*Real data mapping 2
0: Step 0	0: -20
⋮	5: -19
A: Step 10 (SET ID 10)	A: -18
⋮	⋮
F: Step 15 (SET ID 15)	5F: -1
⋮	64: 0
10: Step 16 (SET ID 16)	69: +1
⋮	⋮
63: Step 99 (SET ID 99)	⋮
⋮	C3: +19
64: Step 100	C8: +20

21. Blue Adjustment (Command: k \$)

To adjust blue in color temperature.

Transmission [k][\$][][Set ID][][Data][Cr]

Data Min: 0 ~ Max: C8

*Refer to 'Real data mapping 2'. See page 93.

Acknowledgement [\$][][Set ID][][OK/NG][Data][x]

22. ISM Method (Command: j p)

(Only Plasma TV model)

To avoid having a fixed image remain on screen.

Transmission [j][p][][Set ID][][Data][Cr]

Data 1: Inversion 2: Orbiter

4: White Wash 8: Normal

Acknowledgement [p][][Set ID][][OK/NG][Data][x]

23. Low Power (Command: j q)

(Only Plasma TV model)

To control the low power function on/off.

Transmission [j][q][][Set ID][][Data][Cr]

Data 0: Low Power off

1: Low Power on

Acknowledgement [q][][Set ID][][OK/NG][Data][x]

24. Channel Tuning (Command: m a)

To tune channel to following physical/major/minor number.

Transmission [m][a][][Set ID][][Data0][][Data1][][Data2][][Data3][][Data4][][Data5][Cr]

Digital channels have a Physical, Major, and Minor channel number. The Physical number is the actual digital channel number, the Major is the number that the channel should be mapped to, and the Minor is the sub-channel. Since the ATSC tuner automatically maps the channel to the Major number, the Physical number is not required when sending a command.

Data 0: Physical Channel Number

NTSC air: 02~45, NTSC cable: 01, 0E~7D

ATSC air: 01~45, ATSC cable: 01~87

Data1 & 2: Major Channel Number

Data1: High byte Data2: Low byte

Two bytes are available for the Major and Minor, normally only the second byte is used.

Data3 & 4: Minor Channel Number

Not needed for NTSC.

Data5:

7	Main/Sub Picture	6	Two/One Part Channel	5	Using Physical Channel	4	Reserved	3	2	1	0	Step
0	Main	0	Two	0	Use	x		0	0	0	0	NTSC Air
1	Sub	1	One	1	No Use	x		0	0	0	1	NTSC Cable
						x		0	0	1	0	ATSC Air
						x		0	0	1	1	ATSC Cable_std
						x		0	1	0	0	ATSC Cable_hrc
						x		0	1	0	1	ATSC Cable_irc
						x		0	1	1	0	ATSC cable_auto
						x		0	1	1	1	Reserved
						x		x	x	x	x	...
						x		1	1	1	1	Reserved

The table above lists the binary code which must be converted to Hexadecimal before sending. For example: The binary code to tune the sub source to an NTSC cable channel is "1000 0001", which translates to "81" in Hex.

- * 7th bit: For which source do you want to change the channel.
- * 6th bit: Use a two part or one part channel. Most cases just use 0 since it's ignored when using NTSC.
- * 5th bit: Use 0 with NTSC since it can only use the physical channel number. Normally use 1 for ATSC since most times it doesn't matter what the physical number is.
- * 4th bit: Set to 0.
- * 3-0 bits: Choose signal type.

* Tune Command Examples:

1. Tune to the analog (NTSC) cable channel 35.

Data 0 = Physical of 35 = 23
 Data 1 & 2 = No Major = 00 00
 Data 3 & 4 = No Minor = 00 00
 Data 5 = 0000 0001 in binary = 01
 Total = ma 00 23 00 00 00 01

2. Tune to the digital (ATSC) local channel 30-3.

Data 0 = Don't know Physical = 00
 Data 1 & 2 = Major is 30 = 00 1E
 Data 3 & 4 = Minor is 3 = 00 03
 Data 5 = 0010 0010 in binary = 22
 Total = ma 00 00 00 1E 00 03 22

```
Acknowledgement[a][ ][Set ID][ ][OK][Data0][Data1]
[Data2][Data3][Data4][x][a][ ][Set ID]
[ ][NG][Data0][x]
```

25. Channel Add/Del (Command: m b)

To add and delete the channels

```
Transmission [m][b][ ][Set ID][ ][Data][Cr]
```

Data 0: Channel Delete Data 1: Channel Add

```
Acknowledgement [b][ ][Set ID][ ][OK/NG][Data][x]
```

26. Key (Command: m c)

To send IR remote key code.

```
Transmission [m][c][ ][Set ID][ ][Data][Cr]
```

Data Key code: Refer to page 88.

```
Acknowledgement [c][ ][Set ID][ ][OK/NG][Data][x]
```

27. Back Light (Command: m g)

(Only LCD TV model)

To adjust screen back light.

```
Transmission [m][g][ ][Set ID][ ][Data][Cr]
```

Data Min: 0 ~ Max: 64 (*transmit by Hexadecimal code)

*Refer to 'Real data mapping 1'. See page 93.

```
Acknowledgement [g][ ][Set ID][ ][OK/NG][Data][x]
```

OPEN SOURCE LICENSE

GNU GENERAL PUBLIC LICENSE

Version 2, June 1991

Copyright (C) 1989, 1991 Free Software Foundation, Inc., 51 Franklin Street, Fifth Floor, Boston, MA 02110-1301 USA

Everyone is permitted to copy and distribute verbatim copies of this license document, but changing it is not allowed.

Preamble

The licenses for most software are designed to take away your freedom to share and change it. By contrast, the GNU General Public License is intended to guarantee your freedom to share and change free software - to make sure the software is free for all its users. This General Public License applies to most of the Free Software Foundation's software and to any other program whose authors commit to using it. (Some other free software foundation software is covered by the GNU Lesser General Public License instead.) You can apply it to your programs, too.

When we speak of free software, we are referring to freedom, not price. Our General Public Licenses are designed to make sure that you have the freedom to distribute copies of free software (and charge for this service if you wish), that you receive source code or can get it if you want it, that you can change the software or use pieces of it in new free programs; and that you know you can do these things.

To protect your rights, we need to make restrictions that forbid anyone to deny you these rights or to ask you to surrender the rights. These restrictions translate to certain responsibilities for you if you distribute copies of the software, or if you modify it.

For example, if you distribute copies of such a program, whether gratis or for a fee, you must give the recipients all the rights that you have. You must make sure that they, too, receive or can get the source code. And you must show them these terms so they know their rights.

We protect your rights with two steps: (1) copyright the software, and (2) offer you this license which gives you legal permission to copy, distribute and/or modify the software.

Also, for each author's protection and ours, we want to make certain that everyone understands that there is no warranty for this free software. If the software is modified by someone else and passed on, we want its recipients to know that what they have is not the original, so that any problems introduced by others will not reflect on the original authors' reputations.

Finally, any free program is threatened constantly by software patents. We wish to avoid the danger that redistributors of a free program will individually obtain patent licenses, in effect making

the program proprietary. To prevent this, we have made it clear that any patent must be licensed for everyone's free use or not licensed at all.

The precise terms and conditions for copying, distribution and modification follow.

GNU GENERAL PUBLIC LICENSE

TERMS AND CONDITIONS FOR COPYING, DISTRIBUTION AND MODIFICATION

0. This license applies to any program or other work which contains a notice placed by the copyright holder saying it may be distributed under the terms of this General Public License. The "Program", below, refers to any such program or work, and a "work based on the Program" means either the Program or any derivative work under copyright law: that is to say, a work containing the Program or a portion of it, either verbatim or with modifications and/or translated into another language. (Hereinafter, translation is included without limitation in the term "modification".) Each licensee is addressed as "you".

Activities other than copying, distribution and modification are not covered by this license; they are outside its scope. The act of running the Program is not restricted, and the output from the program is covered only if its contents constitute a work based on the program (independent of having been made by running the program). Whether that is true depends on what the program does.

1. You may copy and distribute verbatim copies of the program's source code as you receive it, in any medium, provided that you conspicuously and appropriately publish on each copy an appropriate copyright notice and disclaimer of warranty; keep intact all the notices that refer to this license and to the absence of any warranty; and give any other recipients of the program a copy of this license along with the Program.

You may charge a fee for the physical act of transferring a copy, and you may at your option offer warranty protection in exchange for a fee.

2. You may modify your copy or copies of the program or any portion of it, thus forming a work based on the Program, and copy and distribute such modifications or work under the terms of section 1 above, provided that you also meet all of these conditions:

a) You must cause the modified files to carry prominent notices stating that you changed the files and the date of any change.

- b) You must cause any work that you distribute or publish, that in whole or in part contains or is derived from the Program or any part thereof, to be licensed as a whole at no charge to all third parties under the terms of this license.
- c) If the modified program normally reads commands interactively when run, you must cause it, when started running for such interactive use in the most ordinary way, to print or display an announcement including an appropriate copyright notice and a notice that there is no warranty (or else, saying that you provide a warranty) and that users may redistribute the program under these conditions, and telling the user how to view a copy of this license. (Exception: if the Program itself is interactive but does not normally print such an announcement, your work based on the Program is not required to print an announcement.)

These requirements apply to the modified work as a whole. If identifiable sections of that work are not derived from the Program, and can be reasonably considered independent and separate works in themselves, then this license, and its terms, do not apply to those sections when you distribute them as separate works. But when you distribute the same sections as part of a whole which is a work based on the Program, the distribution of the whole must be on the terms of this license, whose permissions for other licensees extend to the entire whole, and thus to each and every part regardless of who wrote it.

Thus, it is not the intent of this section to claim rights or contest your rights to work written entirely by you; rather, the intent is to exercise the right to control the distribution of derivative or collective works based on the program.

In addition, mere aggregation of another work not based on the program with the Program (or with a work based on the program) on a volume of a storage or distribution medium does not bring the other work under the scope of this license.

- 3. You may copy and distribute the program (or a work based on it, under section 2) in object code or executable form under the terms of sections 1 and 2 above provided that you also do one of the following:
 - a) Accompany it with the complete corresponding machine-readable source code, which must be distributed under the terms of sections 1 and 2 above on a medium customarily used for software interchange; or
 - b) Accompany it with a written offer, valid for at least three years, to give any third party, for a charge no more than your cost of physically performing source distribution, a complete machine-readable copy of the corresponding source code, to be distributed under the terms of sections 1 and 2 above on a medium customarily used for software interchange; or,

- c) Accompany it with the information you received as to the offer to distribute corresponding source code. (This alternative is allowed only for noncommercial distribution and only if you received the program in object code or executable form with such an offer, in accord with Subsection b above.)

The source code for a work means the preferred form of the work for making modifications to it. For an executable work, complete source code means all the source code for all modules it contains, plus any associated interface definition files, plus the scripts used to control compilation and installation of the executable. However, as a special exception, the source code distributed need not include anything that is normally distributed (in either source or binary form) with the major components (compiler, kernel, and so on) of the operating system on which the executable runs, unless that component itself accompanies the executable.

If distribution of executable or object code is made by offering access to copy from a designated place, then offering equivalent access to copy the source code from the same place counts as distribution of the source code, even though third parties are not compelled to copy the source along with the object code.

- 4. You may not copy, modify, sublicense, or distribute the Program except as expressly provided under this license. Any attempt otherwise to copy, modify, sublicense or distribute the Program is void, and will automatically terminate your rights under this license. However, parties who have received copies, or rights, from you under this license will not have their licenses terminated so long as such parties remain in full compliance.
- 5. You are not required to accept this license, since you have not signed it. However, nothing else grants you permission to modify or distribute the Program or its derivative works. These actions are prohibited by law if you do not accept this license. Therefore, by modifying or distributing the program (or any work based on the program), you indicate your acceptance of this license to do so, and all its terms and conditions for copying, distributing or modifying the program or works based on it.
- 6. Each time you redistribute the program (or any work based on the Program), the recipient automatically receives a license from the original licensor to copy, distribute or modify the Program subject to these terms and conditions. You may not impose any further restrictions on the recipients' exercise of the rights granted herein. You are not responsible for enforcing compliance by third parties to this license.

7. If, as a consequence of a court judgment or allegation of patent infringement or for any other reason (not limited to patent issues), conditions are imposed on you (whether by court order, agreement or otherwise) that contradict the conditions of this license, they do not excuse you from the conditions of this license. If you cannot distribute so as to satisfy simultaneously your obligations under this license and any other pertinent obligations, then as a consequence you may not distribute the program at all. For example, if a patent license would not permit royalty-free redistribution of the program by all those who receive copies directly or indirectly through you, then the only way you could satisfy both it and this license would be to refrain entirely from distribution of the program.

If any portion of this section is held invalid or unenforceable under any particular circumstance, the balance of the section is intended to apply and the section as a whole is intended to apply in other circumstances.

It is not the purpose of this section to induce you to infringe any patents or other property right claims or to contest validity of any such claims; this section has the sole purpose of protecting the integrity of the free software distribution system, which is implemented by public license practices. Many people have made generous contributions to the wide range of software distributed through that system in reliance on consistent application of that system; it is up to the author/donor to decide if he or she is willing to distribute software through any other system and a licensee cannot impose that choice.

This section is intended to make thoroughly clear what is believed to be a consequence of the rest of this license.

8. If the distribution and/or use of the program is restricted in certain countries either by patents or by copyrighted interfaces, the original copyright holder who places the program under this license may add an explicit geographical distribution limitation excluding those countries, so that distribution is permitted only in or among countries not thus excluded. In such case, this license incorporates the limitation as if written in the body of this license.
9. The Free Software Foundation may publish revised and/or new versions of the General Public License from time to time. Such new versions will be similar in spirit to the present version, but may differ in detail to address new problems or concerns.

Each version is given a distinguishing version number. If the program specifies a version number of this license which applies to it and "any later version", you have the option of following the terms and conditions either of that version or of

any later version published by the Free Software Foundation. If the program does not specify a version number of this license, you may choose any version ever published by the Free Software Foundation.

10. If you wish to incorporate parts of the program into other free programs whose distribution conditions are different, write to the author to ask for permission. For software which is copyrighted by the Free Software Foundation, write to the Free Software Foundation; we sometimes make exceptions for this. Our decision will be guided by the two goals of preserving the free status of all derivatives of our free software and of promoting the sharing and reuse of software generally.

NO WARRANTY

11. BECAUSE THE PROGRAM IS LICENSED FREE OF CHARGE, THERE IS NO WARRANTY FOR THE PROGRAM, TO THE EXTENT PERMITTED BY APPLICABLE LAW. EXCEPT WHEN OTHERWISE STATED IN WRITING THE COPYRIGHT HOLDERS AND/OR OTHER PARTIES PROVIDE THE PROGRAM "AS IS" WITHOUT WARRANTY OF ANY KIND, EITHER EXPRESSED OR IMPLIED, INCLUDING, BUT NOT LIMITED TO, THE IMPLIED WARRANTIES OF MERCHANTABILITY AND FITNESS FOR A PARTICULAR PURPOSE. THE ENTIRE RISK AS TO THE QUALITY AND PERFORMANCE OF THE PROGRAM IS WITH YOU. SHOULD THE PROGRAM PROVE DEFECTIVE, YOU ASSUME THE COST OF ALL NECESSARY SERVICING, REPAIR OR CORRECTION.
12. IN NO EVENT UNLESS REQUIRED BY APPLICABLE LAW OR AGREED TO IN WRITING WILL ANY COPYRIGHT HOLDER, OR ANY OTHER PARTY WHO MAY MODIFY AND/OR REDISTRIBUTE THE PROGRAM AS PERMITTED ABOVE, BE LIABLE TO YOU FOR DAMAGES, INCLUDING ANY GENERAL, SPECIAL, INCIDENTAL OR CONSEQUENTIAL DAMAGES ARISING OUT OF THE USE OR INABILITY TO USE THE PROGRAM (INCLUDING BUT NOT LIMITED TO LOSS OF DATA OR DATA BEING RENDERED INACCURATE OR LOSSES SUSTAINED BY YOU OR THIRD PARTIES OR A FAILURE OF THE PROGRAM TO OPERATE WITH ANY OTHER PROGRAMS), EVEN IF SUCH HOLDER OR OTHER PARTY HAS BEEN ADVISED OF THE POSSIBILITY OF SUCH DAMAGES.

END OF TERMS AND CONDITIONS

How to apply these terms to your new programs

If you develop a new program, and you want it to be of the greatest possible use to the public, the best way to achieve this is to make it free software which everyone can redistribute and change under these terms.

To do so, attach the following notices to the program. It is safest to attach them to the start of each source file to most effectively convey the exclusion of warranty; and each file should have at least the "copyright" line and a pointer to where the full notice is found.

one line to give the program's name and a brief idea of what it does.

Copyright (C) <year> <name of author>

This program is free software; you can redistribute it and/or modify it under the terms of the GNU General Public License as published by the Free Software Foundation; either version 2 of the license, or (at your option) any later version.

This program is distributed in the hope that it will be useful, but WITHOUT ANY WARRANTY; without even the implied warranty of MERCHANTABILITY or FITNESS FOR A PARTICULAR PURPOSE. See the GNU General Public License for more details.

You should have received a copy of the GNU General Public License along with this program; if not, write to the Free Software Foundation, Inc., 51 Franklin Street, Fifth Floor, Boston, MA 02110-1301 USA.

Also add information on how to contact you by electronic and paper mail.

If the program is interactive, make it output a short notice like this when it starts in an interactive mode:

Gnomovision version 69, Copyright (C) year name of author
Gnomovision comes with ABSOLUTELY NO WARRANTY; for details type 'show w'. This is free software, and you are welcome to redistribute it under certain conditions; type 'show c' for details.

The hypothetical commands 'show w' and 'show c' should show the appropriate parts of the General Public License. Of course, the commands you use may be called something other than 'show w' and 'show c'; they could even be mouse-clicks or menu items-whatever suits your program.

You should also get your employer (if you work as a programmer) or your school, if any, to sign a "copyright disclaimer" for the program, if necessary. Here is a sample; alter the names:

Yoyodyne, Inc., hereby disclaims all copyright interest in the program 'Gnomovision' (which makes passes at compilers) written by James Hacker.

signature of Ty Coon, 1 April 1989
Ty Coon, President of Vice

This General Public License does not permit incorporating your program into proprietary programs. If your program is a subroutine library, you may consider it more useful to permit linking proprietary applications with the library. If this is what you want to do, use the GNU Lesser General Public License instead of this license.

GNU LESSER GENERAL PUBLIC LICENSE

Version 2.1, February 1999

Copyright (C) 1991, 1999 Free Software Foundation, Inc. 51 Franklin Street, Fifth Floor, Boston, MA 02110-1301 USA
Everyone is permitted to copy and distribute verbatim copies of this license document, but changing it is not allowed.

[This is the first released version of the Lesser GPL. It also counts as the successor of the GNU Library Public License, version 2, hence the version number 2.1.]

Preamble

The licenses for most software are designed to take away your freedom to share and change it. By contrast, the GNU General Public Licenses are intended to guarantee your freedom to share and change free software - to make sure the software is free for all its users.

This license, the Lesser General Public License, applies to some specially designated software packages - typically libraries - of the Free Software Foundation and other authors who decide to use it. You can use it too, but we suggest you first think carefully about whether this license or the ordinary General Public License is the better strategy to use in any particular case, based on the explanations below.

When we speak of free software, we are referring to freedom of use, not price. Our General Public Licenses are designed to make sure that you have the freedom to distribute copies of free software (and charge for this service if you wish); that you receive source code or can get it if you want it; that you can change the software and use pieces of it in new free programs; and that you are informed that you can do these things.

To protect your rights, we need to make restrictions that forbid distributors to deny you these rights or to ask you to surrender these rights. These restrictions translate to certain responsibilities for you if you distribute copies of the library or if you modify it.

For example, if you distribute copies of the library, whether gratis or for a fee, you must give the recipients all the rights that we gave you. You must make sure that they, too, receive or can get the source code. If you link other code with the library, you must provide complete object files to the recipients, so that they can relink them with the library after making changes to the library and recompiling it. And you must show them these terms so they know their rights.

We protect your rights with a two-step method: (1) we copyright the library, and (2) we offer you this license, which gives you legal permission to copy, distribute and/or modify the library.

To protect each distributor, we want to make it very clear that there is no warranty for the free library. Also, if the library is modified by someone else and passed on, the recipients should know that what they have is not the original version, so that the original author's reputation will not be affected by problems that might be introduced by others.

Finally, software patents pose a constant threat to the existence of any free program. We wish to make sure that a company cannot effectively restrict the users of a free program by obtaining a restrictive license from a patent holder. Therefore, we insist that any patent license obtained for a version of the library must be consistent with the full freedom of use specified in this license.

Most GNU software, including some libraries, is covered by the ordinary GNU General Public License. This license, the GNU Lesser General Public License, applies to certain designated libraries, and is quite different from the ordinary General Public License. We use this license for certain libraries in order to permit linking those libraries into non-free programs.

When a program is linked with a library, whether statically or using a shared library, the combination of the two is legally speaking a combined work, a derivative of the original library. The ordinary General Public License therefore permits such linking only if the entire combination fits its criteria of freedom. The Lesser General Public License permits more lax criteria for linking other code with the library.

We call this license the "Lesser" General Public License because it does less to protect the user's freedom than the ordinary General Public License. It also provides other free software developers less of an advantage over competing non-free programs. These disadvantages are the reason we use the ordinary General Public License for many libraries. However, the Lesser license provides advantages in certain special circumstances.

For example, on rare occasions, there may be a special need to encourage the widest possible use of a certain library, so that it becomes a de-facto standard. To achieve this, non-free programs must be allowed to use the library. A more frequent case is that a free library does the same job as widely used non-free libraries. In this case, there is little to gain by limiting the free library to free software only, so we use the Lesser General Public License.

In other cases, permission to use a particular library in non-free programs enables a greater number of people to use a large body of free software. For example, permission to use the GNU C Library in non-free programs enables many more people to use the whole GNU operating system, as well as its variant, the GNU/Linux operating system.

Although the Lesser General Public License is Less protective of the users' freedom, it does ensure that the user of a program that is linked with the Library has the freedom and the wherewithal to run that program using a modified version of the Library.

The precise terms and conditions for copying, distribution and modification follow. Pay close attention to the difference between a "work based on the library" and a "work that uses the library". The former contains code derived from the library, whereas the latter must be combined with the library in order to run.

GNU LESSER GENERAL PUBLIC LICENSE TERMS AND CONDITIONS FOR COPYING, DISTRIBUTION AND MODIFICATION

0. This license agreement applies to any software library or other program which contains a notice placed by the copyright holder or other authorized party saying it may be distributed under the terms of this Lesser General Public License (also called "this license"). Each license is addressed as "you".

A "library" means a collection of software functions and/or data prepared so as to be conveniently linked with application programs (which use some of those functions and data) to form executables.

The "Library", below, refers to any such software library or work which has been distributed under these terms. A "work based on the Library" means either the Library or any derivative work under copyright law: that is to say, a work containing the library or a portion of it, either verbatim or with modifications and/or translated straightforwardly into another language. (Hereinafter, translation is included without limitation in the term "modification".)

"Source code" for a work means the preferred form of the work for making modifications to it. For a library, complete source code means all the source code for all modules it contains, plus any associated interface definition files, plus the scripts used to control compilation and installation of the library.

Activities other than copying, distribution and modification are not covered by this license; they are outside its scope. The act of running a program using the Library is not restricted, and output from such a program is covered only if its contents constitute a work based on the library (independent of the use of the Library in a tool for writing it). Whether that is true depends on what the library does and what the program that uses the library does.

1. You may copy and distribute verbatim copies of the library's complete source code as you receive it, in any medium, provided that you conspicuously and appropriately publish on

each copy an appropriate copyright notice and disclaimer of warranty; keep intact all the notices that refer to this license and to the absence of any warranty; and distribute a copy of this license along with the Library.

You may charge a fee for the physical act of transferring a copy, and you may at your option offer warranty protection in exchange for a fee.

2. You may modify your copy or copies of the Library or any portion of it, thus forming a work based on the Library, and copy and distribute such modifications or work under the terms of section 1 above, provided that you also meet all of these conditions:

- a) The modified work must itself be a software library.
- b) You must cause the files modified to carry prominent notices stating that you changed the files and the date of any change.
- c) You must cause the whole of the work to be licensed at no charge to all third parties under the terms of this license.
- d) If a facility in the modified Library refers to a function or a table of data to be supplied by an application program that uses the facility, other than as an argument passed when the facility is invoked, then you must make a good faith effort to ensure that, in the event an application does not supply such function or table, the facility still operates, and performs whatever part of its purpose remains meaningful.

(For example, a function in a library to compute square roots has a purpose that is entirely well-defined independent of the application. Therefore, Subsection 2d requires that any application-supplied function or table used by this function must be optional: if the application does not supply it, the square root function must still compute square roots.)

These requirements apply to the modified work as a whole. If identifiable sections of that work are not derived from the library, and can be reasonably considered independent and separate works in themselves, then this license, and its terms, do not apply to those sections when you distribute them as separate works. But when you distribute the same sections as part of a whole which is a work based on the library, the distribution of the whole must be on the terms of this license, whose permissions for other licenses extend to the entire whole, and thus to each and every part regardless of who wrote it.

Thus, it is not the intent of this section to claim rights or contest your rights to work written entirely by you; rather, the intent is to exercise the right to control the distribution of derivative or collective works based on the library.

In addition, mere aggregation of another work not based on the library with the library (or with a work based on the library) on a volume of a storage or distribution medium does not bring the other work under the scope of this license.

3. You may opt to apply the terms of the ordinary GNU General Public License instead of this License to a given copy of the Library. To do this, you must alter all the notices that refer to this License, so that they refer to the ordinary GNU General Public License, version 2, instead of to this License. (If a newer version than version 2 of the ordinary GNU General Public License has appeared, then you can specify that version instead if you wish.) Do not make any other change in these notices.

Once this change is made in a given copy, it is irreversible for that copy, so the ordinary GNU General Public License applies to all subsequent copies and derivative works made from that copy.

This option is useful when you wish to copy part of the code of the library into a program that is not a library.

4. You may copy and distribute the library (or a portion or derivative of it, under Section 2) in object code or executable form under the terms of Sections 1 and 2 above provided that you accompany it with the complete corresponding machine-readable source code, which must be distributed under the terms of sections 1 and 2 above on a medium customarily used for software interchange.

If distribution of object code is made by offering access to copy from a designated place, then offering equivalent access to copy the source code from the same place satisfies the requirement to distribute the source code, even though third parties are not compelled to copy the source along with the object code.

5. A program that contains no derivative of any portion of the Library, but is designed to work with the Library by being compiled or linked with it, is called a “work that uses the Library”. Such a work, in isolation, is not a derivative work of the Library, and therefore falls outside the scope of this license.

However, linking a “work that uses the library” with the Library creates an executable that is a derivative of the Library (because it contains portions of the library), rather than a “work that uses the library”. The executable is therefore covered by this license. Section 6 states terms for distribution of such executable.

When a “work that uses the library” uses material from a header file that is part of the library, the object code for the work may be a derivative work of the library even though the source code is not.

Whether this is true is especially significant if the work can be linked without the library, or if the work is itself a library. The threshold for this to be true is not precisely defined by law.

If such an object file uses only numerical parameters, data structure layouts and accessories, and small macros and small inline functions (ten lines or less in length), then the use of

the object file is unrestricted, regardless of whether it is legally a derivative work. (Executable containing this object code plus portions of the library will still fall under Section 6.)

Otherwise, if the work is a derivative of the library, you may distribute the object code for the work under the terms of Section 6. Any executable containing that work also fall under Section 6, whether or not they are linked directly with the library itself.

6. As an exception to the sections above, you may also combine or link a “work that uses the library” with the library to produce a work containing portions of the library, and distribute that work under terms of your choice, provided that the terms permit modification of the work for the customer’s own use and reverse engineering for debugging such modifications.

You must give prominent notice with each copy of the work that the library is used in it and that the Library and its use are covered by this license. You must supply a copy of this license. If the work during execution displays copyright notices, you must include the copyright notice for the library among them, as well as a reference directing the user to the copy of this license. Also, you must do one of these things:

- a) Accompany the work with the complete corresponding machine-readable source code for the library including whatever changes were used in the work (which must be distributed under Sections 1 and 2 above); and, if the work is an executable linked with the Library, with the complete machine-readable “work that uses the Library”, as object code and/or source code, so that the user can modify the library and then relink to produce a modified executable containing the modified library. (It is understood that the user who changes the contents of definitions files in the library will not necessarily be able to recompile the application to use the modified definitions.)
- b) Use a suitable shared library mechanism for linking with the library. A suitable mechanism is one that (1) uses at run time a copy of the library already present on the user’s computer system, rather than copying library functions into the executable, and (2) will operate properly with a modified version of the library, if the user installs one, as long as the modified version is interface-compatible with the version that the work was made with.
- c) Accompany the work with a written offer, valid for at least three years, to give the same user the materials specified in Subsection 6, above, for a charge no more than the cost of performing this distribution.
- d) If distribution of the work is made by offering access to copy from a designated place, offer equivalent access to copy the above specified materials from the same place.
- e) Verify that the user has already received a copy of these materials or that you have already sent this user a copy.

For an executable, the required form of the “work that uses the library” must include any data and utility programs needed for reproducing the executable from it. However, as a special exception, the materials to be distributed need not include anything that is normally distributed (in either source or binary form) with the major components (compiler, kernel, and so on) of the operating system on which the executable runs, unless that component itself accompanies the executable.

It may happen that this requirement contradicts the license restrictions of other proprietary libraries that do not normally accompany the operating system. Such a contradiction means you cannot use both them and the library together in an executable that you distribute.

7. You may place library facilities that are a work based on the library side-by-side in a single library together with other library facilities not covered by this license, and distribute such a combined library, provided that the separate distribution of the work based on the Library and of the other library facilities is otherwise permitted, and provided that you do these two things:
 - a) Accompany the combined library with a copy of the same work based on the Library, uncombined with any other library facilities. This must be distributed under the terms of the sections above.
 - b) Give prominent notice with the combined library of the fact that part of it is a work based on the library, and explaining where to find the accompanying uncombined form of the same work.
8. You may not copy, modify, sublicense, link with, or distribute the library except as expressly provided under this license. Any attempt otherwise to copy, modify, sublicense, link with, or distribute the library is void, and will automatically terminate your rights under this license. However, parties who have received copies, or rights, from you under this license will not have their licenses terminated so long as such parties remain in full compliance.
9. You are not required to accept this license, since you have not signed it. However, nothing else grants you permission to modify or distribute the library or its derivative works. These actions are prohibited by law if you do not accept this license. Therefore, by modifying or distributing the library (or any work based on the library), you indicate your acceptance of this license to do so, and all its terms and conditions for copying, distributing or modifying the library or works based on it.
10. Each time you redistribute the library (or any work based on the Library), the recipient automatically receives a license from the original licensor to copy, distribute, link with or modify the library subject to these terms and conditions. You may not impose any further restrictions on the recipients’ exercise

of the rights granted herein.

You are not responsible for enforcing compliance by third parties with this license.

11. If, as a consequence of a court judgment or allegation of patent infringement or for any other reason (not limited to patent issues), conditions are imposed on you (whether by court order, agreement or otherwise) that contradict the conditions of this license, they do not excuse you from the conditions of this license. If you cannot distribute so as to satisfy simultaneously your obligations under this license and any other pertinent obligations, then as a consequence you may not distribute the library at all. For example, if a patent license would not permit royalty-free redistribution of the library by all those who receive copies directly or indirectly through you, then the only way you could satisfy both it and this license would be to refrain entirely from distribution of the library.

If any portion of this section is held invalid or unenforceable under any particular circumstance, the balance of the section is intended to apply, and the section as a whole is intended to apply in other circumstances.

It is not the purpose of this section to induce you to infringe any patents or other property right claims or to contest validity of any such claims; this section has the sole purpose of protecting the integrity of the free software distribution system which is implemented by public license practices. Many people have made generous contributions to the wide range of software distributed through that system in reliance on consistent application of that system; it is up to the author/donor to decide if he or she is willing to distribute software through any other system and a license cannot impose that choice.

This section is intended to make thoroughly clear what is believed to be a consequence of the rest of this license.

12. If the distribution and/or use of the library is restricted in certain countries either by patents or by copyrighted interfaces, the original copyright holder who places the library under this license may add an explicit geographical distribution limitation excluding those countries, so that distribution is permitted only in or among countries not thus excluded. In such case, this license incorporates the limitation as if written in the body of this license.
13. The Free Software Foundation may publish revised and/or new versions of the Lesser General Public License from time to time. Such new versions will be similar in spirit to the present version, but may differ in detail to address new problems or concerns.
Each version is given a distinguishing version number. If the library specifies a version number of this license which applies to it and “any later version”, you have the option of following the terms and conditions either of that version or of any later version published by the Free Software Foundation.

APPENDIX

If the library does not specify a license version number, you may choose any version ever published by the Free Software Foundation.

14. If you wish to incorporate parts of the library into other free programs whose distribution conditions are incompatible with these, write to the author to ask for permission. For software which is copyrighted by the Free Software Foundation, write to the Free Software Foundation; we sometimes make exceptions for this. Our decision will be guided by the two goals of preserving the free status of all derivatives of our free software and of promoting the sharing and reuse of software generally.

NO WARRANTY

15. BECAUSE THE LIBRARY IS LICENSED FREE OF CHARGE, THERE IS NO WARRANTY FOR THE LIBRARY, TO THE EXTENT PERMITTED BY APPLICABLE LAW. EXCEPT WHEN OTHERWISE STATED IN WRITING THE COPYRIGHT HOLDERS AND/OR OTHER PARTIES PROVIDE THE LIBRARY "AS IS" WITHOUT WARRANTY OF ANY KIND, EITHER EXPRESSED OR IMPLIED, INCLUDING, BUT NOT LIMITED TO, THE IMPLIED WARRANTIES OF MERCHANTABILITY AND FITNESS FOR A PARTICULAR PURPOSE. THE ENTIRE RISK AS TO THE QUALITY AND PERFORMANCE OF THE LIBRARY IS WITH YOU. SHOULD THE LIBRARY PROVE DEFECTIVE, YOU ASSUME THE COST OF ALL NECESSARY SERVICING, REPAIR OR CORRECTION.

16. IN NO EVENT UNLESS REQUIRED BY APPLICABLE LAW OR AGREED TO IN WRITING WILL ANY COPYRIGHT HOLDER, OR ANY OTHER PARTY WHO MAY MODIFY AND/OR REDISTRIBUTE THE LIBRARY AS PERMITTED ABOVE, BE LIABLE TO YOU FOR DAMAGES, INCLUDING ANY GENERAL, SPECIAL, INCIDENTAL OR CONSEQUENTIAL DAMAGES ARISING OUT OF THE USE OR INABILITY TO USE THE LIBRARY (INCLUDING BUT NOT LIMITED TO LOSS OF DATA OR DATA BEING RENDERED INACCURATE OR LOSSES SUSTAINED BY YOU OR THIRD PARTIES OR A FAILURE OF THE LIBRARY TO OPERATE WITH ANY OTHER SOFTWARE), EVEN IF SUCH HOLDER OR OTHER PARTY HAS BEEN ADVISED OF THE POSSIBILITY OF SUCH DAMAGES.

END OF TERMS AND CONDITIONS

How to apply these terms to your new libraries

If you develop a new library, and you want it to be of the greatest possible use to the public, we recommend making it free software that everyone can redistribute and change. You can do so by permitting redistribution under these terms (or, alternatively, under the terms of the ordinary General Public License).

To apply these terms, attach the following notices to the library. It is safest to attach them to the start of each source file to most effectively convey the exclusion of warranty; and each file should have at least the "copyright" line and a pointer to where the full notice is found.

one line to give the library's name and a brief idea of what it does.
Copyright (C) <year> <name of author>

This library is free software; you can redistribute it and/or modify it under the terms of the GNU Lesser General Public License as published by the Free Software Foundation; either version 2.1 of the license, or (at your option) any later version.

This library is distributed in the hope that it will be useful, but WITHOUT ANY WARRANTY; without even the implied warranty of MERCHANTABILITY or FITNESS FOR A PARTICULAR PURPOSE. See the GNU Lesser General Public License for more details.

You should have received a copy of the GNU Lesser General Public License along with this library; if not, write to the Free Software Foundation, Inc., 51 Franklin Street, Fifth Floor, Boston, MA 02110-1301 USA

Also add information on how to contact you by electronic and paper mail.

You should also get your employer (if you work as a programmer) or your school, if any, to sign a "copyright disclaimer" for the library, if necessary. Here is a sample; alter the names:

Yoyodyne, Inc., hereby disclaims all copyright interest in the library 'Frob' (a library for tweaking knobs) written by James Random Hacker.

signature of Ty Coon, 1 April 1990
Ty Coon, President of Vice

MOZILLA PUBLIC LICENSE

Version 1.1

1. Definitions.

1.0.1. “Commercial use” means distribution or otherwise making the covered code available to a third party.

1.1. “Contributor” means each entity that creates or contributes to the creation of modifications.

1.2. “Contributor version” means the combination of the original code, prior modifications used by a contributor, and the modifications made by that particular contributor.

1.3. “Covered code” means the original code or modifications or the combination of the original code and modifications, in each case including portions thereof.

1.4. “Electronic distribution mechanism” means a mechanism generally accepted in the software development community for the electronic transfer of data.

1.5. “Executable” means covered code in any form other than source code.

1.6. “Initial developer” means the individual or entity identified as the initial Developer in the Source Code notice required by exhibit A.

1.7. “Larger work” means a work which combines covered code or portions thereof with code not governed by the terms of this License.

1.8. “License” means this document.

1.8.1. “Licensable” means having the right to grant, to the maximum extent possible, whether at the time of the initial grant or subsequently acquired, any and all of the rights conveyed herein.

1.9. “Modifications” means any addition to or deletion from the substance or structure of either the original code or any previous modifications. When covered code is released as a series of files, a modification is:

A. Any addition to or deletion from the contents of a file containing original code or previous modifications.

B. Any new file that contains any part of the original code or previous modifications.

1.10. “Original code” means source code of computer software

code which is described in the source code notice required by exhibit as original code, and which, at the time of its release under this license is not already covered code governed by this license.

1.10.1. “Patent claims” means any patent claim(s), now owned or hereafter acquired, including without limitation, method, process, and apparatus claims, in any patent licensable by grantor.

1.11. “Source code” means the preferred form of the covered code for making modifications to it, including all modules it contains, plus any associated interface definition files, scripts used to control compilation and installation of an executable, or source code differential comparisons against either the original code or another well known, available covered code of the contributor’s choice. The source code can be in a compressed or archival form, provided the appropriate decompression or de-archiving software is widely available for no charge.

1.12. “You” (or “Your”) means an individual or a legal entity exercising rights under, and complying with all of the terms of, this license or a future version of this license issued under section 6.1.

For legal entities, “You” includes any entity which controls, is controlled by, or is under common control with You. For purposes of this definition, “control” means (a) the power, direct or indirect, to cause the direction or management of such entity, whether by contract or otherwise, or (b) ownership of more than fifty percent (50%) of the outstanding shares or beneficial ownership of such entity.

2. Source Code License.

2.1. The initial developer grant.
The initial developer hereby grants You a world-wide, royalty-free, non-exclusive license, subject to third party intellectual property claims:

- a) under intellectual property rights (other than patent or trademark) licensable by initial developer to use, reproduce, modify, display, perform, sublicense and distribute the original code (or portions thereof) with or without modifications, and/or as part of a larger work; and
- (b) under patents claims infringed by the making, using or selling of original code, to make, have made, use, practice, sell, and offer for sale, and/or otherwise dispose of the original code (or portions thereof).

- (c) the licenses granted in this section 2.1 (a) and (b) are effective on the date Initial developer first distributes original code under the terms of this license.
- (d) Notwithstanding section 2.1 (b) above, no patent license is granted: 1) for code that You delete from the original Code; 2) separate from the original code; or 3) for infringements caused by: i) the modification of the original code or ii) the combination of the original code with other software or devices.

2.2. Contributor Grant.

Subject to third party intellectual property claims, each contributor hereby grants You a world-wide, royalty-free, non-exclusive license

- (a) under intellectual property rights (other than patent or trademark) licensable by contributor, to use, reproduce, modify, display, perform, sublicense and distribute the modifications created by such contributor (or portions thereof) either on an unmodified basis, with other modifications, as covered code and/or as part of a larger work; and
- (b) under patent claims infringed by the making, using, or selling of modifications made by that contributor either alone and/or in combination with its contributor version (or portions of such combination), to make, use, sell, offer for sale, have made, and/or otherwise dispose of: 1) modifications made by that contributor (or portions thereof); and 2) the combination of modifications made by that contributor with its contributor version (or portions of such combination).
- (c) the licenses granted in sections 2.2 (a) and 2.2 (b) are effective on the date contributor first makes commercial use of the covered code.
- (d) Notwithstanding section 2.2 (b) above, no patent license is granted: 1) for any code that contributor has deleted from the contributor version; 2) separate from the contributor version; 3) for infringements caused by: i) third party modifications of contributor version or ii) the combination of modifications made by that contributor with other software (except as part of the contributor version) or other devices; or 4) under patent claims infringed by covered code in the absence of modifications made by that contributor.

3. Distribution Obligations.

3.1. Application of license.

The modifications which You create or to which you contribute are governed by the terms of this license, including without limitation section 2.2. The source code version of covered code may be distributed only under the terms of this license or a future version of this license released under section 6.1, and you must include a copy of this license with every copy of the source code you distribute.

You may not offer or impose any terms on any source code version that alters or restricts the applicable version of this license or the recipients' rights hereunder. However, you may include an additional document offering the additional rights described in section 3.5.

3.2. Availability of source code.

Any modification which you create or to which you contribute must be made available in source code form under the terms of this license either on the same media as an executable version or via an accepted electronic distribution mechanism to anyone to whom you made an executable version available; and if made available via electronic distribution mechanism, must remain available for at least twelve (12) months after the date it initially became available, or at least six (6) months after a subsequent version of that particular modification has been made available to such recipients. You are responsible for ensuring that the source code version remains available even if the electronic distribution mechanism is maintained by a third party.

3.3. Description of modifications.

You must cause all covered code to which you contribute to contain a file documenting the changes You made to create that covered code and the date of any change. You must include a prominent statement that the modification is derived, directly or indirectly, from original code provided by the initial developer and including the name of the initial developer in (a) the source code, and (b) in any notice in an executable version or related documentation in which you describe the origin or ownership of the covered code.

3.4. Intellectual property matters

(a) Third party claims.

If contributor has knowledge that a license under a third party's intellectual property rights is required to exercise the rights granted by such contributor under sections 2.1 or 2.2, contributor must include a text file with the source code distribution titled "LEGAL" which describes the claim and the party making the claim in sufficient detail that a recipient will know whom to contact. If contributor obtains such knowledge after the modification is made available as described in section 3.2, contributor shall promptly modify the LEGAL file in all copies contributor makes available thereafter and shall take other steps (such as notifying appropriate mailing lists or newsgroups) reasonably calculated to inform those who received the covered code that new knowledge has been obtained.

(b) Contributor APIs.

If contributor's modifications include an application programming interface and contributor has knowledge of patent licenses which are reasonably necessary to implement that API, contributor must also include this information in the LEGAL file.

(c) Representations.

contributor represents that, except as disclosed pursuant to section 3.4(a) above, contributor believes that contributor's modifications are contributor's original creation(s) and/or contributor has sufficient rights to grant the rights conveyed by this license.

3.5. Required notices.

You must duplicate the notice in exhibit A in each file of the source code. If it is not possible to put such notice in a particular source code file due to its structure, then You must include such notice in a location (such as a relevant directory) where a user would be likely to look for such a notice. If You created one or more modification(s), you may add your name as a contributor to the notice described in exhibit A. you must also duplicate this license in any documentation for the source code where You describe recipients' rights or ownership rights relating to covered code. You may choose to offer, and to charge a fee for, warranty, support, indemnity or liability obligations to one or more recipients of covered code. However, you may do so only on your own behalf, and not on behalf of the Initial developer or any contributor. You must make it absolutely clear than any such warranty, support, indemnity or liability obligation is offered by you alone, and You hereby agree to indemnify the Initial developer and every contributor for any liability incurred by the Initial developer or such contributor as a result of warranty, support, indemnity or liability terms you offer.

3.6. Distribution of executable versions.

You may distribute covered code in executable form only if the requirements of section 3.1-3.5 have been met for that covered code, and if you include a notice stating that the source code version of the covered code is available under the terms of this license, including a description of how and where you have fulfilled the obligations of section 3.2. The notice must be conspicuously included in any notice in an executable version, related documentation or collateral in which you describe recipients' rights relating to the covered code. You may distribute the executable version of covered code or ownership rights under a license of your choice, which may contain terms different from this license, provided that you are in compliance with the terms of this license and that the license for the executable version does not attempt to limit or alter the recipient's rights in the source code version from the rights set forth in this license. If you distribute the executable version under a different license you must make it absolutely clear that any terms which differ from this license are offered by you alone, not by the Initial developer or any contributor. You hereby agree to indemnify the initial developer and every contributor for any liability incurred by the initial developer or such contributor as a result of any such terms You offer.

3.7. Larger works.

You may create a larger work by combining covered code with other code not governed by the terms of this license and distribute the larger work as a single product. In such a case, you must make sure the requirements of this license are fulfilled for the covered code.

4. Inability to comply due to statute or regulation.

If it is impossible for you to comply with any of the terms of this license with respect to some or all of the covered code due to statute, judicial order, or regulation then you must: (a) comply with the terms of this license to the maximum extent possible; and (b) describe the limitations and the code they affect. Such description must be included in the LEGAL file described in section 3.4 and must be included with all distributions of the source code. Except to the extent prohibited by statute or regulation, such description must be sufficiently detailed for a recipient of ordinary skill to be able to understand it.

5. Application of this license.

This license applies to code to which the initial developer has attached the notice in exhibit A and to related covered code.

6. Versions of the license.

6.1. New versions.

Netscape communications corporation ("Netscape") may publish revised and/or new versions of the license from time to time. Each version will be given a distinguishing version number.

6.2. Effect of new versions.

Once covered code has been published under a particular version of the license, you may always continue to use it under the terms of that version. You may also choose to use such covered code under the terms of any subsequent version of the license published by netscape. No one other than netscape has the right to modify the terms applicable to covered code created under this license.

6.3. Derivative works.

If You create or use a modified version of this license (which you may only do in order to apply it to code which is not already covered code governed by this license), You must (a) rename Your license so that the phrases "Mozilla", "MOZILLAPL", "MOZPL", "Netscape", "MPL", "NPL" or any confusingly similar phrase do not appear in your license (except to note that your license differs from this license) and (b) otherwise make it clear that Your version of the license contains terms which differ from the Mozilla Public license and netscape Public License. (Filling in the name of the initial developer, original code or contributor in the notice described in exhibit A shall not of themselves be deemed to be modifications of this license.)

7. DISCLAIMER OF WARRANTY.

COVERED CODE IS PROVIDED UNDER THIS LICENSE ON AN "AS IS" BASIS, WITHOUT WARRANTY OF ANY KIND, EITHER EXPRESSED OR IMPLIED, INCLUDING, WITHOUT LIMITATION, WARRANTIES THAT THE COVERED CODE IS FREE OF DEFECTS, MERCHANTABILITY, FIT FOR A PARTICULAR PURPOSE OR NON-INFRINGEMENT. THE ENTIRE RISK AS TO THE QUALITY AND PERFORMANCE OF THE COVERED CODE IS WITH YOU. SHOULD ANY COVERED CODE PROVE DEFECTIVE IN ANY RESPECT, YOU (NOT THE INITIAL DEVELOPER OR ANY OTHER CONTRIBUTOR) ASSUME THE COST OF ANY NECESSARY SERVICING, REPAIR OR CORRECTION. THIS DISCLAIMER OF WARRANTY CONSTITUTES AN ESSENTIAL PART OF THIS LICENSE. NO USE OF ANY COVERED CODE IS AUTHORIZED HEREUNDER EXCEPT UNDER THIS DISCLAIMER.

8. TERMINATION.

- 8.1. This license and the rights granted hereunder will terminate automatically if you fail to comply with terms herein and fail to cure such breach within 30 days of becoming aware of the breach. All sublicenses to the covered code which are properly granted shall survive any termination of this license. Provisions which, by their nature, must remain in effect beyond the termination of this license shall survive.
- 8.2. If you initiate litigation by asserting a patent infringement claim (excluding declaratory judgment actions) against initial developer or a contributor (the initial developer or contributor against whom you file such action is referred to as "Participant") alleging that:

- (a) such participant's contributor version directly or indirectly infringes any patent, then any and all rights granted by such participant to you under sections 2.1 and/or 2.2 of this license shall, upon 60 days notice from Participant terminate prospectively, unless if within 60 days after receipt of notice you either: (i) agree in writing to pay participant a mutually agreeable reasonable royalty for your past and future use of modifications made by such participant, or (ii) withdraw your litigation claim with respect to the contributor version against such participant. If within 60 days of notice, a reasonable royalty and payment arrangement are not mutually agreed upon in writing by the parties or the litigation claim is not withdrawn, the rights granted by participant to you under sections 2.1 and/or 2.2 automatically terminate at the expiration of the 60 day notice period specified above.
- (b) any software, hardware, or device, other than such participant's contributor Version, directly or indirectly infringes any patent, then any rights granted to You by

such participant under sections 2.1 (b) and 2.2(b) are revoked effective as of the date you first made, used, sold, distributed, or had made, modifications made by that participant.

- 8.3. If you assert a patent infringement claim against participant alleging that such participant's contributor version directly or indirectly infringes any patent where such claim is resolved (such as by license or settlement) prior to the initiation of patent infringement litigation, then the reasonable value of the licenses granted by such participant under sections 2.1 or 2.2 shall be taken into account in determining the amount or value of any payment or license.
- 8.4. In the event of termination under sections 8.1 or 8.2 above, all end user license agreements (excluding distributors and resellers) which have been validly granted by you or any distributor hereunder prior to termination shall survive termination.

9. LIMITATION OF LIABILITY.

UNDER NO CIRCUMSTANCES AND UNDER NO LEGAL THEORY, WHETHER TORT (INCLUDING NEGLIGENCE), CONTRACT, OR OTHERWISE, SHALL YOU, THE INITIAL DEVELOPER, ANY OTHER CONTRIBUTOR, OR ANY DISTRIBUTOR OF COVERED CODE, OR ANY SUPPLIER OF ANY OF SUCH PARTIES, BE LIABLE TO ANY PERSON FOR ANY INDIRECT, SPECIAL, INCIDENTAL, OR CONSEQUENTIAL DAMAGES OF ANY CHARACTER INCLUDING, WITHOUT LIMITATION, DAMAGES FOR LOSS OF GOODWILL, WORK STOPPAGE, COMPUTER FAILURE OR MALFUNCTION, OR ANY AND ALL OTHER COMMERCIAL DAMAGES OR LOSSES, EVEN IF SUCH PARTY SHALL HAVE BEEN INFORMED OF THE POSSIBILITY OF SUCH DAMAGES. THIS LIMITATION OF LIABILITY SHALL NOT APPLY TO LIABILITY FOR DEATH OR PERSONAL INJURY RESULTING FROM SUCH PARTY'S NEGLIGENCE TO THE EXTENT APPLICABLE LAW PROHIBITS SUCH LIMITATION. SOME JURISDICTIONS DO NOT ALLOW THE EXCLUSION OR LIMITATION OF INCIDENTAL OR CONSEQUENTIAL DAMAGES, SO THIS EXCLUSION AND LIMITATION MAY NOT APPLY TO YOU.

10. U.S. GOVERNMENT END USERS.

The covered code is a "commercial item," as that term is defined in 48 C.F.R. 2.101 (Oct. 1995), consisting of "commercial computer software" and "commercial computer software documentation," as such terms are used in 48 C.F.R. 12.212 (Sept. 1995). Consistent with 48 C.F.R. 12.212 and 48 C.F.R. 227.7202-1 through 227.7202-4 (June 1995), all U.S. Government end users acquire covered code with only those rights set forth herein.

11. MISCELLANEOUS.

This license represents the complete agreement concerning subject matter hereof. If any provision of this license is held to be unenforceable, such provision shall be reformed only to the extent necessary to make it enforceable. This License shall be governed by California law provisions (except to the extent applicable law, if any, provides otherwise), excluding its conflict-of-law provisions. With respect to disputes in which at least one party is a citizen of, or an entity chartered or registered to do business in the united states of america, any litigation relating to this License shall be subject to the jurisdiction of the federal courts of the northern district of california, with venue lying in santa clara county, california, with the losing party responsible for costs, including without limitation, court costs and reasonable attorneys' fees and expenses. The application of the united nations convention on contracts for the International sale of goods is expressly excluded. Any law or regulation which provides that the language of a contract shall be construed against the drafter shall not apply to this license.

12. RESPONSIBILITY FOR CLAIMS.

As between initial developer and the contributors, each party is responsible for claims and damages arising, directly or indirectly, out of its utilization of rights under this license and you agree to work with initial developer and contributors to distribute such responsibility on an equitable basis. Nothing herein is intended or shall be deemed to constitute any admission of liability.

13. MULTIPLE-LICENSED CODE.

Initial developer may designate portions of the covered code as "Multiple-Licensed". "Multiple-Licensed" means that the initial developer permits you to utilize portions of the covered code under your choice of the NPL or the alternative licenses, if any, specified by the initial developer in the file described in exhibit A.

EXHIBIT A -Mozilla Public License.

The contents of this file are subject to the Mozilla Public License Version 1.1 (the "license"); you may not use this file except in compliance with the License. You may obtain a copy of the license at <http://www.mozilla.org/MPL/>

Software distributed under the license is distributed on an "AS IS" basis, WITHOUT WARRANTY OF ANY KIND, either express or implied. See the license for the specific language governing rights and limitations under the License.

The Original Code is _____.

The Initial Developer of the Original Code is _____.

Portions created by _____ are Copyright (C) _____. All Rights Reserved.

Contributor(s): _____.

Alternatively, the contents of this file may be used under the terms of the _____ license (the "[] License"), in which case the provisions of [] license are applicable instead of those above. If you wish to allow use of your version of this file only under the terms of the [] license and not to allow others to use your version of this file under the MPL, indicate your decision by deleting the provisions above and replace them with the notice and other provisions required by the [] license. If you do not delete the provisions above, a recipient may use your version of this file under either the MPL or the [] license."

NOTE: The text of this exhibit A may differ slightly from the text of the notices in the source code files of the original code. You should use the text of this exhibit A rather than the text found in the original code/source code for Your modifications.

LG Electronics Inc.