

QUICK MENU

Your TV's OSD (On Screen Display) may differ slightly from what is shown in this manual.

Q.Menu (Quick Menu) is a menu of features which users might use frequently.

- **Aspect Ratio:** Selects your desired picture format.
- **Power Saving** (Plasma TV Only): Adjusts screen brightness to reduce the power consumption of the TV.
- **Backlight** (LCD TV Only): Adjust the brightness of LCD panel to control the brightness of the screen.
- **Clear Voice:** By differentiating the human sound range from others, it helps make human voices sound better.
- **Picture Mode:** Selects the factory preset picture depend on the viewing environment.
- **Sound Mode:** Selects the factory preset sound for type of program.
- **Caption:** Select on or off.
- **Multi Audio** or **SAP:** Selects MTS sound (Analog signal) or changes the audio language (Digital signal).
- **Sleep Timer:** Select the amount of time before your TV turns off automatically.
- **Del/Add/Fav:** Select channel you want to add/delete or add the channel to the Favorite List.
- **USB Eject:** Select "USB Eject" in order to eject USB device.

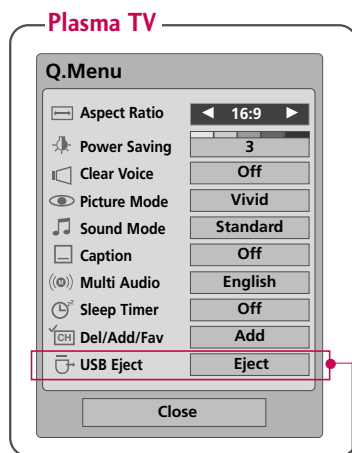

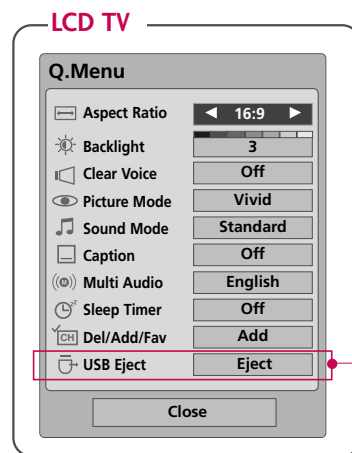

Only for 50/60PG60F



Only for 32/37/42/47/52LG50/60/70

1   Display each menu.

2  Make appropriate adjustments.

3  Return to TV viewing

WATCHING TV /CHANNEL CONTROL

INITIAL SETTING - LCD TV Only

This Function guides the user to easily set the essential items for viewing the TV for the first time when purchasing the TV. It will be displayed on the screen when turning the TV on for the first time. It can also be activated from the user menus.

- **In-Store Mode:** Picture mode is set to "Vivid". Customers can adjust the "Picture Mode" manually while inspecting the TV, but the TV will automatically return to **Vivid** preset after 5 minutes.
- **Home Mode:** Picture mode is set to "Vivid" and user can change it to whatever they wish.



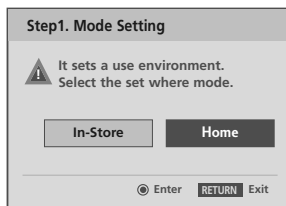

Step1. Mode setting



- 1  Select **Home** Mode.
- 2 



Step2. Time setting

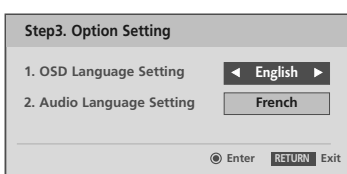

- 1  Select **Auto** or **Manual**.
- 2   Select desired time option.
- 3 

Step3. Option setting



- 1  Select **OSD Language Setting** or **Audio Language Setting**.
- 2  Select your desired language.
- 3 

Step4. Auto Tuning

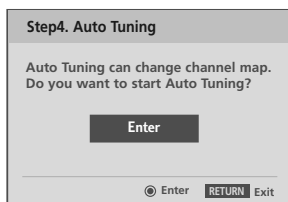



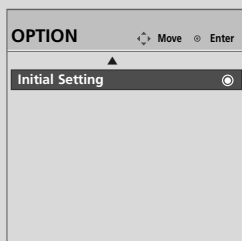

- 1  Start **Auto Tuning**.

NOTE

- You can also adjust **Initial Setting** in the **OPTION** menu.



- 1   Select **OPTION**.
- 2   Select **Initial Setting**.
- 3 

WATCHING TV /CHANNEL CONTROL

ON-SCREEN MENUS SELECTION

Your TV's OSD (On Screen Display) may differ slightly from that shown in this manual.

* Only 32/37/42/47/52LG50/60/70, 50/60PG30/60

WATCHING TV / CHANNEL CONTROL

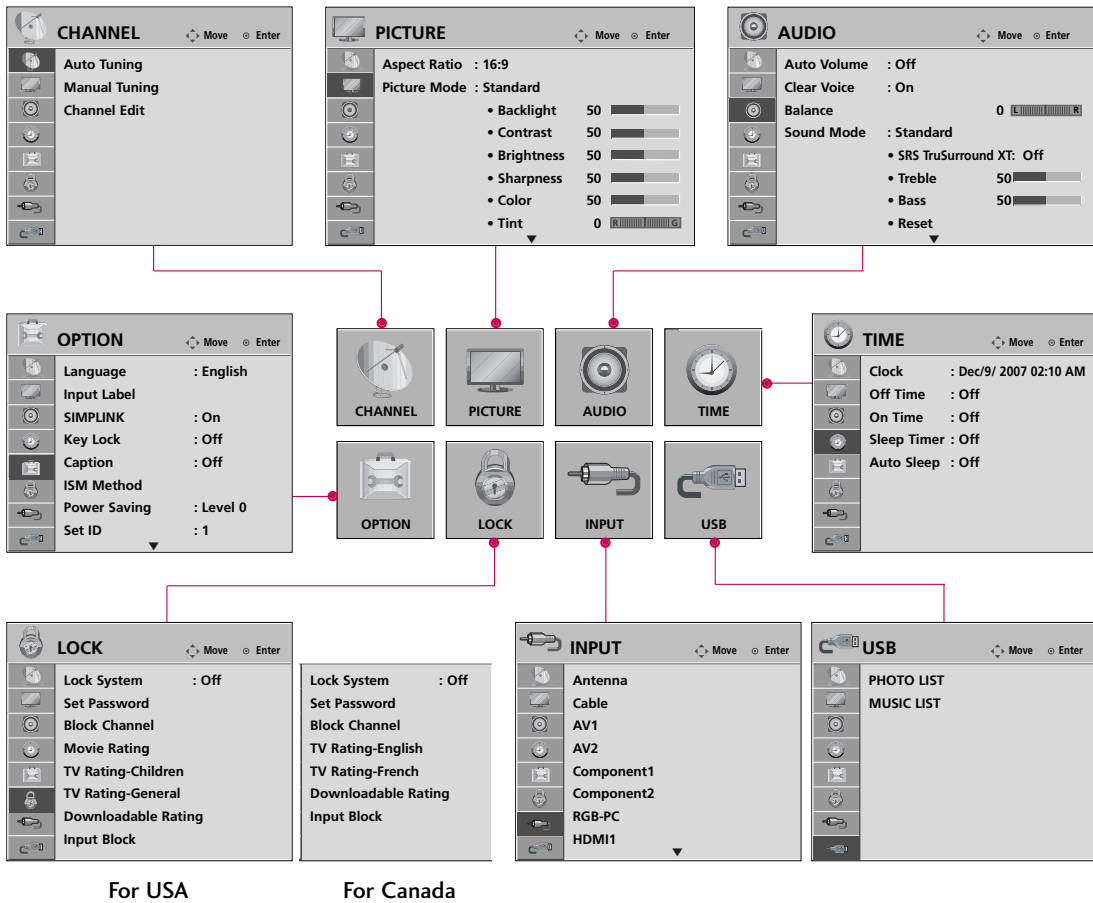

- 1 Display each menu.
- 2 Select a menu item.
- 3 Enter to the pop up menu.
- 4 Return to TV viewing

NOTE

- ▶ ISM Method, Power Saving: Only Plasma TV.
- ▶ Backlight, Power Indicator, TruMotion Demo: Only LCD TV. (But, TruMotion Demo: Only for 32/37/42/47/52LG60/70)

Only 32/37/42LG30

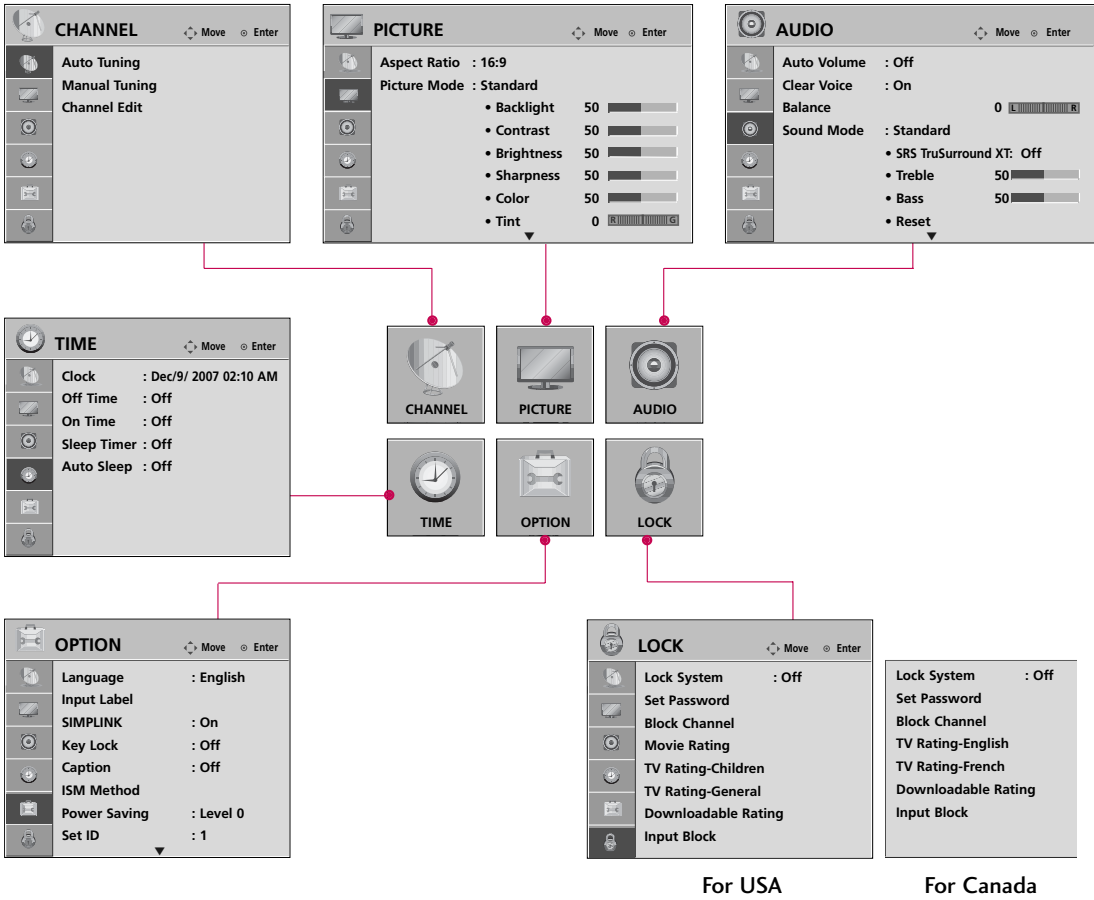

- 1 Display each menu.
- 2 Select a menu item.
- 3 Enter to the pop up menu.
- 4 Return to TV viewing

NOTE

- ▶ ISM Method, Power Saving: Only Plasma TV.
- ▶ Backlight: Only LCD TV.

WATCHING TV /CHANNEL CONTROL

CHANNEL SETUP







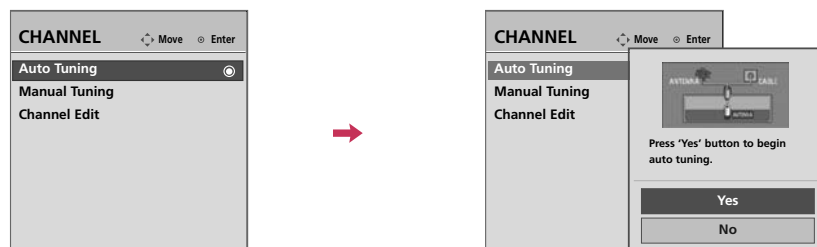

Auto Scan (Auto Tuning)

Automatically finds all channels available through antenna or cable inputs, and stores them in memory on the channel list.

Run Auto Tuning again after any Antenna/Cable connection changes.

WATCHING TV / CHANNEL CONTROL



-   Select **CHANNEL**.
-   Select **Auto Tuning**.
-   Select **Yes**.
-  Run **Auto tuning**.
-  Return to the previous menu.
-  Return to TV viewing

■ A password is required to gain access to Auto Tuning menu if the Lock System is turned on.



Add/Delete Channel (Manual Tuning)

If selecting DTV or CADTV input signal, you can view the on-screen signal strength monitor to see the quality of the signal being received.

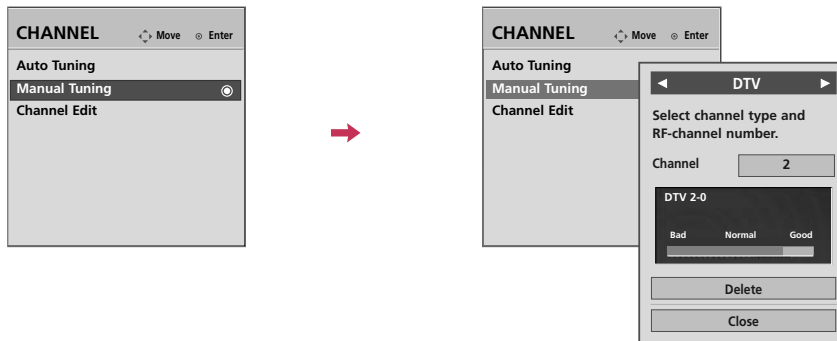

- 1 Select **CHANNEL**.
- 2 Select **Manual Tuning**.
- 3 Select **DTV, TV, CADTV, or CATV**.
- 4 Select channel you want to add or delete.
- 5 Select **Add or Delete**.
- 6 Return to the previous menu.
- Return to TV viewing

■ A password is required to gain access to Manual Tuning menu if the Lock System is turned on.

WATCHING TV / CHANNEL CONTROL

CHANNEL SETUP

Channel Editing

From the default channel list created from the Auto Tuning channel search, you can create two different types of channel lists in memory: “custom list” and “favorite channel list”.

A custom list can be created by toggling each channel on or off with **ENTER** button. The channels in the Custom List are displayed in black and the channels deleted from the Custom List are displayed in gray.

Once a channel is highlighted you can add or delete the channel by referring to the small window at the top-right corner of the screen.

WATCHING TV / CHANNEL CONTROL

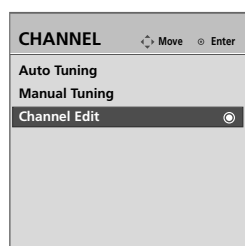

-   Select **CHANNEL**.
-   Select **Channel Edit**.
-   Select a channel.
-  Select channel you want to add or delete.
-  Return to the previous menu.
-  Return to TV viewing

INPUT LIST

Only these input signals which are connected to a TV can be activated and selected.

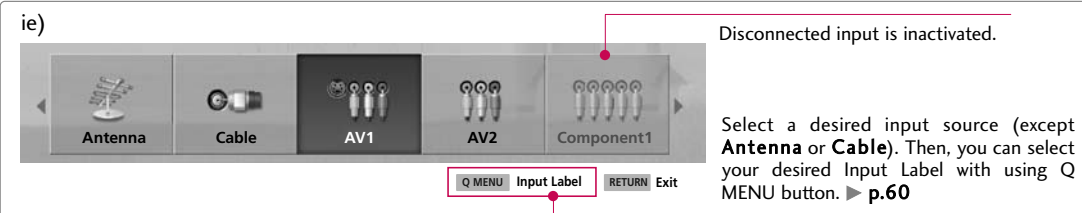
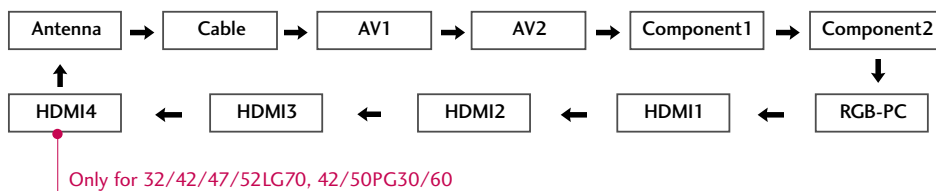

- You can also select the desired input source in the **INPUT** menu (Only for 32/37/42/47/52LG50/60/70, 50/60PG60).

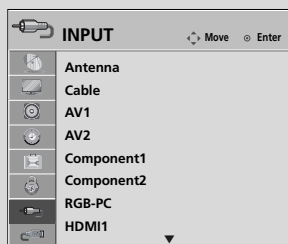

- **Antenna:** Select it to watch over-the-air broadcasts.
- **Cable:** Select it to watch cable and digital cable.
- **AV 1-2:** Select them to watch a VCR or other external equipment.
- **Component 1-2:** Select them to watch DVD or a Digital set-top box.
- **RGB-PC:** Select it to view PC input.
- **HDMI1-4:** Select them to watch high definition devices.

WATCHING TV / CHANNEL CONTROL

INPUT LABEL

You can set a label for each input source when it's not in use.

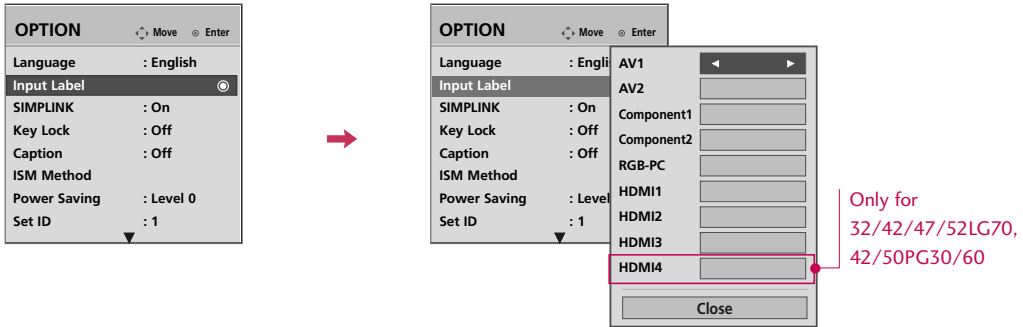

WATCHING TV / CHANNEL CONTROL

With using OPTION menu

- 1 Select **OPTION**.
- 2 Select **Input Label**.
- 3 Select the source.
- 4 Select the label.
- 5 Return to the previous menu.
- Return to TV viewing.

With using INPUT button

- 1 Select the source.
- 2 Select the label.
- 3 Return to the previous menu.
- Return to TV viewing.

- When new external device is connected, this popup menu is displayed automatically. If selecting **Yes**, you can select input source that you want to appreciate.
- But, when selecting "**SIMPLINK - On**" in HDMI mode, this popup menu is may not displayed.

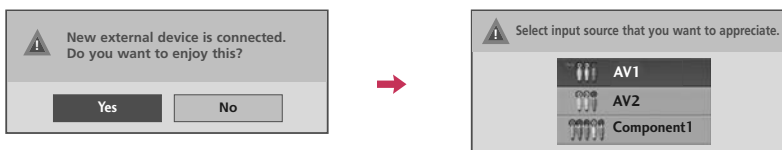

AV MODE

You can select the optimal images and sounds when connecting AV devices to external input.

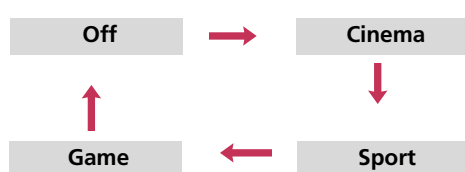

Press the **AV MODE** button repeatedly to select the desired source.



- If you select “**Cinema**” in AV mode, **Cinema** will be selected both for “**PICTURE** menu - Picture Mode” and “**AUDIO** menu - Sound Mode” respectively.
- If you select “**Off**” in AV mode, the picture and image which you initially set will be selected.

WATCHING TV / CHANNEL CONTROL









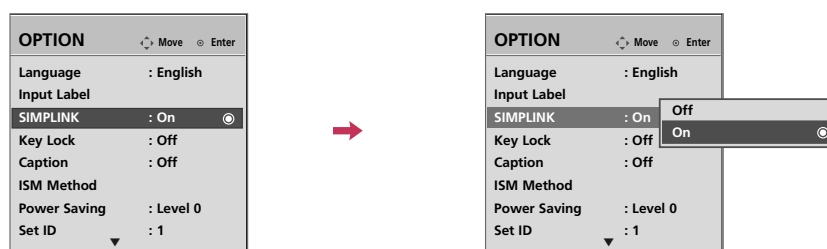

This function operates only with devices with the SIMPLINK logo.

This allows you to control and play other AV devices connected with HDMI cable without additional cables and settings.

To start using SIMPLINK, turn it on in the user menus.



- 1   Select **OPTION**.
- 2   Select **SIMPLINK**.
- 3   Select **On** or **Off**.
- 4  Return to the previous menu.
-  Return to TV viewing

! NOTE

- ▶ Connect the HDMI/DVI IN or HDMI IN terminal of the TV to the rear terminal (HDMI terminal) of the SIMPLINK device with the HDMI cable.
- ▶ When you switch the Input source with the INPUT button on the remote control, the SIMPLINK device will stop.
- ▶ When you select a device with home theater functionality, the sound output automatically switches to the home theater speakers.
- ▶ If a connected SIMPLINK home theater system doesn't play the audio from the TV, connect the DIGITAL AUDIO OUT terminal on the back of the TV to the DIGITAL AUDIO IN terminal on the back of the SIMPLINK device with an OPTICAL cable.

SIMPLINK Functions

- **Direct Play:** After connecting AV devices to the TV, you can directly control the devices and play media without additional settings.
- **Select AV device:** Enables you to select one of the AV devices connected to TV.
- **Disc playback:** Control connected AV devices by pressing the $\wedge \vee < >$, ENTER, \blacktriangleright , \blacksquare , \blacksquare , \blacktriangleleft and \blacktriangleright buttons.
- **Power off all devices:** When you power off the TV, all connected devices are turned off.
- **Switch audio-out:** Offers an easy way to switch audio-out.
- **Sync Power on:** When you play the connected AV device, TV will automatically turn on.

(A device, which is connected to the TV through a HDMI cable but does not support SIMPLINK, does not provide this function)

Note: To operate SIMPLINK, an HDMI cable over Version 1.2 with *CEC function should be used. (*CEC: Consumer Electronics Control).

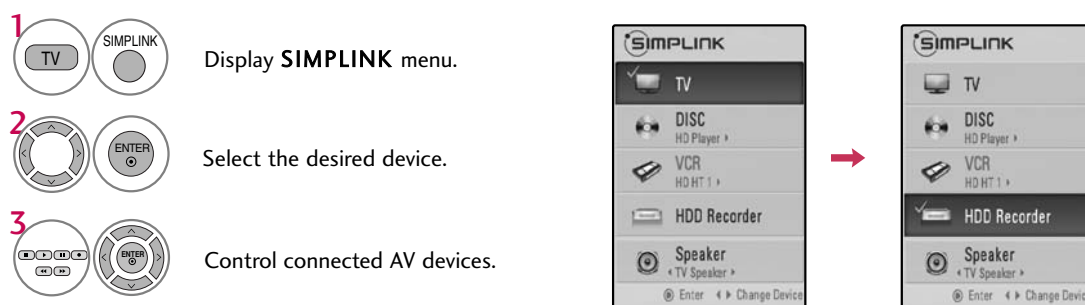

SIMPLINK Menu

- 1 **TV viewing:** Switch to the previous TV channel regardless of the current mode.
- 2 **DISC playback:** Select and play discs. When multiple discs are available, the titles of discs are conveniently displayed at the bottom of the screen.
- 3 **VCR playback:** Control the connected VCR.
- 4 **HDD Recordings playback:** Control recordings stored in HDD.
- 5 **Audio Out to Home Theater speaker/Audio Out to TV:** Select Home Theater speaker or TV speaker for Audio Out.

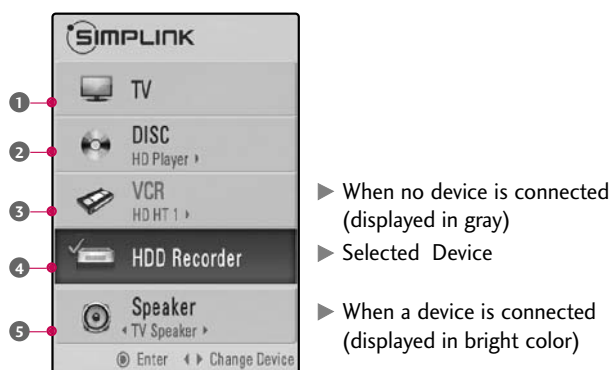

USB

- This feature is only for 32/37/42/47/52LG50/60/70, 50/60PG60.

ENTRY MODES

When you connect a USB device, this screen is displayed automatically.
In USB device, you can not add a new folder or delete the existing folder.

- 1 Connect the USB device to the **USB IN** jacks on the side of TV.

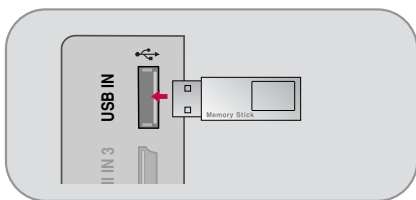

- 2 Select **PHOTO LIST** or **MUSIC LIST**

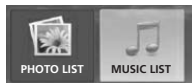

- 3



- It doesn't support USB HDD
- This TV supports JPG and MP3.

When removing the USB device

Select the **USB Eject** menu before removing the USB device.

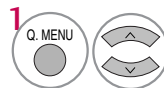

Select **USB Eject**.



Precautions when using the USB device

- ▶ Only a USB storage device is recognizable.
- ▶ If the USB storage device is connected through a USB hub, the device is not recognizable.
- ▶ A USB storage device using an automatic recognition program may not be recognized.
- ▶ A USB storage device which uses its own driver may not be recognized.
- ▶ In case of a card reader, up to four memory cards are concurrently recognizable.
- ▶ The recognition speed of a USB storage device may depend on each device.
- ▶ Please do not turn off the TV or unplug the USB device when the connected USB storage device is working. When such device is suddenly separated or unplugged, the stored files or the USB storage device may be damaged.
- ▶ Please do not connect the USB storage device which was artificially maneuvered on the PC. The device may cause the product to malfunction or fail to be played. Never forget to use only a USB storage device which has normal music files or image files.
- ▶ Please use only a USB storage device which was formatted as a FAT or NTFS file system provided with the Windows operating system. In case of a storage device formatted as a different utility program which is not supported by Windows, it may not be recognized.
- ▶ Please connect power to a USB storage device which requires an external power supply. If not, the device may not be recognized.
- ▶ Please connect a USB storage device with cable is offered by USB maker. If connected with cable is not offered by USB maker or an excessively long cable, the device may not be recognized.
- ▶ Some USB storage devices may not be supported or operated smoothly.
- ▶ If the name of a folder or file is too long, it will not be displayed or recognized.
- ▶ Please backup important files because data on USB device may be damaged. Data management is consumer's responsibility and as a result, the manufacturer does not cover data damage.

PHOTO LIST

You can view .JPG files from USB storage devices.



The On Screen Display on your model may be slightly different.

Supported photo file: *.JPG

- You can play JPG files only.
- Only baseline scan is supported among JPG.



Screen Components

1

Select **USB**.

2

Select **PHOTO LIST**.

- ① Moves to upper level file
- ② Preview: Display the thumbnail/folder name of the photo in the selected folder
- ③ Current page/Total pages
- ④ Total number of marked photos
- ⑤ Usable USB memory
- ⑥ Corresponding buttons on the remote control

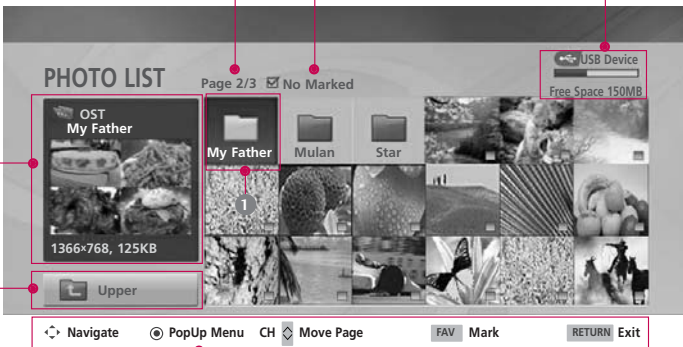

The screenshot shows a 'PHOTO LIST' interface. At the top, it says 'Page 2/3' and 'No Marked'. A 'USB Device' status bar shows 'Free Space 150MB'. The main area displays a grid of photo thumbnails. One thumbnail is highlighted with a red box and labeled '1'. A folder named 'Upper' is visible at the bottom left of the grid. At the bottom of the screen, there is a navigation bar with buttons: 'Navigate', 'PopUp Menu', 'CH', 'Move Page', 'FAV Mark', and 'RETURN Exit'. A red box highlights these buttons, with a callout '6' pointing to it.

USB

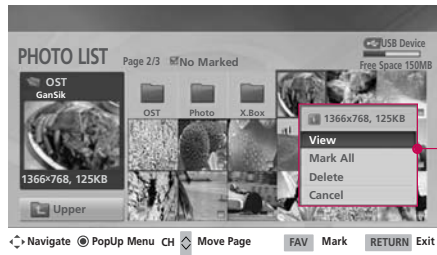
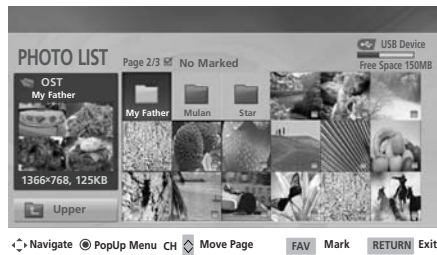
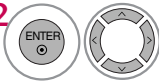

Photo Selection and Popup Menu

USB



When you select a file (not folder), this PopUp menu is displayed.

- ▶ **View:** Display the selected item.
- ▶ **Mark All:** Mark all photos on the screen.
- ▶ **Unmark All:** Deselect all marked photos.
- ▶ **Delete:** Delete the selected photo item.
- ▶ **Cancel:** Close the pop-up menu.

-  Select the target folder or drive.
-  Select the desired photos.
-  Show the Popup menu.
-  Select the desired Popup menu.





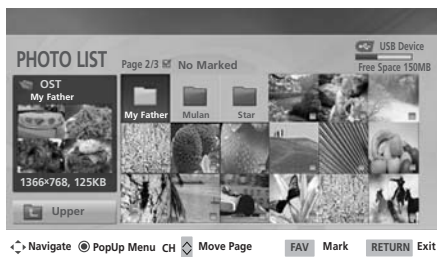

- Use the **CH** ^ v button to navigation in the photo page.
- Use the **FAV** button to mark or unmark a photo. When one or more photos are marked, you can view individual photos or a slide show of the marked photos. If no photos are marked, you can view all photos individually or all photos in the folder in a slide show.

Full Screen Menu

You can change the Photo List view so that it fills the screen. More operations are available in full screen mode.



The aspect ratio of a photo may change the size of the photo displayed on the screen in full size.

- 1  Select the target folder or drive.
- 2   Select the desired photos.
- 3  Show the PopUp menu.
- 4  Select **View**.
- 5  The selected photo is displayed in full size.

- Use the CH  button to navigation in the photo page.

USB

USB

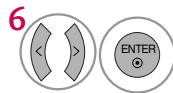

Select the **Sideshow**, **BGM**, **Rotate**, **Delete**, **Option**, or **Hide**.

- Use < > button to select the previous or next photo.
- Use ^ v < > button to select and control the menu on the full-sized screen.

- ▶ **Sideshow:** Selected photos are displayed during the slide show. If no photo is selected, all photos in the current folder are displayed during slide show.
 - Set the time interval of the slide show in **Option**.
 - A slide show continues for a maximum of 4 hours. After 4 hours, the slide show will end and go to TV mode or external input mode.
- ▶ **BGM:** Listen to music while viewing photos in full size.
 - Set the BGM device and album in **Option**.
- ▶ **Rotate:** Rotate photos.
 - Rotates the photo 90°, 180°, 270°, 360° clockwise.
- ▶ **Delete:** Delete photos.
- ▶ **Option:** Set values for **Slide Speed** and **Music Folder**.
 - Use < > button and **ENTER** button to set values. Then go to **Enter** and press **ENTER** to save the settings.
 - You cannot change **Music Folder** while BGM is playing.
- ▶ **Hide :** Hide the menu on the full-sized screen.
 - To see the menu again on the full-sized screen, press **ENTER** button to display.

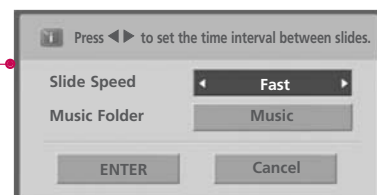

NOTE

- ▶ This TV will not be able to decode most JPEG images saved using the Progressive option.

MUSIC LIST

You can use the Music List menu to play MP3 files from a USB storage device.
 This TV cannot play back copy-protected files.
 The On Screen Display on your model may be slightly different.



Supported music file: *.MP3
 Bit rate range 40Kbps ~ 320Kbps
 •Sampling rate (Sampling Frequency)
 MPEG1 : 32000, 44100, 48000Hz
 MPEG2 : 16000, 24000, 22050Hz
 MPEG2.5 : 16 ~ 48KHz



USB



Screen Components

1

Select **USB**.

2

Select **MUSIC LIST**.

- ① Moves to upper level file
- ② Preview: If any album jacket for the file exists, this jacket is displayed.
- ③ Current page/Total pages
- ④ Total number of marked musics
- ⑤ Usable USB memory
- ⑥ Corresponding buttons on the remote control

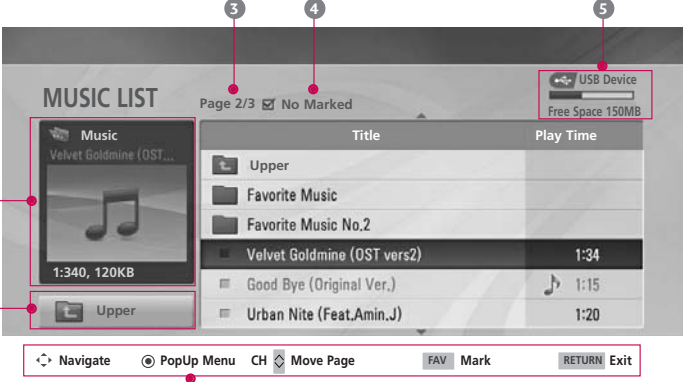

The screenshot shows the 'MUSIC LIST' interface. At the top, it displays 'Page 2/3' and 'No Marked'. A 'USB Device' status bar shows 'Free Space 150MB'. The main content area is a table with columns for 'Title' and 'Play Time'. The first row is 'Upper' with a folder icon. The second row is 'Favorite Music' with a folder icon. The third row is 'Favorite Music No.2' with a folder icon. The fourth row is 'Velvet Goldmine (OST vers2)' with a play button icon and a play time of 1:34. The fifth row is 'Good Bye (Original Ver.)' with a play button icon and a play time of 1:15. The sixth row is 'Urban Nite (Feat.Amin.J)' with a play button icon and a play time of 1:20. A preview window on the left shows a music note icon and the text '1:340, 120KB'. At the bottom, a navigation bar contains buttons for 'Navigate', 'PopUp Menu', 'CH', 'Move Page', 'FAV', 'Mark', and 'RETURN Exit'.





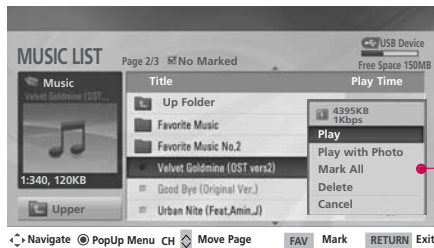
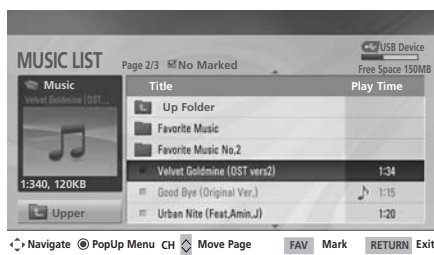

Music Selection and Popup Menu

As shown, up to 6 music titles are listed per page.

USB



- ▶ **Play (During stop):** Play the selected music. Once a song finishes playing, the next selected one will be played. When there are no selected musics to play, the next one in the current folder will be played. If you go to a different folder and press the **ENTER** button, the current music in playback will stop.
- ▶ **Play Marked:** Play the selected musics. Once a music finishes playing, the next selected one will be played automatically.
- ▶ **Stop Play (During playback):** Stop the playing musics.
- ▶ **Play with Photo:** Start playing the selected musics and then move to the Photo List.
- ▶ **Mark All:** Mark all musics in the folder.
- ▶ **Unmark All:** Deselect all marked music.
- ▶ **Delete:** Delete the selected music.
- ▶ **Cancel:** Close the pop-up menu.







- 1  Select the target folder or drive.
- 2   Select the desired musics.
- 3  Show the Popup menu.
- 4   Select the desired Popup menu.
- 5  Return to TV viewing

- Use the **CH** ^ v button to navigation in the music page.
- Use **FAV** button to mark or unmark a music file. If no music is marked, all the music in the folder will be played in sequence. When one or more music files are marked, the marked music files will be played in sequence. If you want to listen to only one song repeatedly, just mark that one file and play.

- The play information box (as shown below) will automatically move across the screen when there is no user input to prevent a fixed image remaining on the screen for an extended period of time.



! NOTE

- ▶ When music is playing,  is displayed in front of the music play time.
- ▶ A damaged or corrupted music file that does not play displays 00:00 as the play time.
- ▶ Music files with copy-protection will not play.
- ▶ Press **ENTER**, , **RETURN** button to stop the screen saver.
- ▶ The **PLAY** () , **Pause** () ,  ,  ,  buttons on the remote control are also available in this mode.
- ▶ This TV cannot play music files of less than 16 Kbytes.

PICTURE CONTROL

PICTURE SIZE (ASPECT RATIO) CONTROL

This feature lets you choose the way an analog picture with a 4:3 aspect ratio is displayed on your TV.







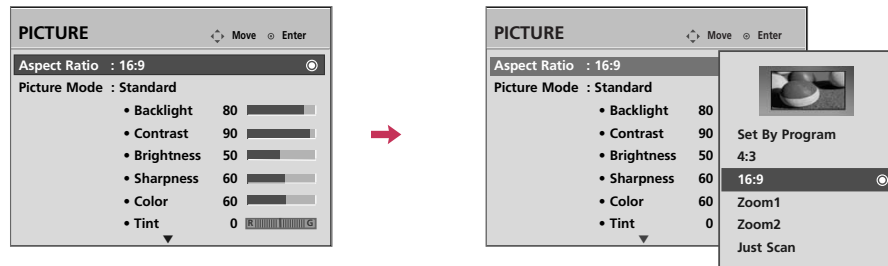

- RGB-PC input source use 4:3 or 16:9 aspect ratio.

NOTE

- ▶ If a fixed image is displayed on the screen for a long time, the image could become imprinted on the screen and remain visible.
This phenomenon is common to all manufacturers and is not covered by warranty. Although, after watching video that did not fill the screen, any after-image from the black bars will normally dissipate after a few minutes.

PICTURE CONTROL



1.   Select **PICTURE**.
 2.   Select **Aspect Ratio**.
 3.   Select the desired picture format.
 4.  Return to the previous menu.
-  Return to TV viewing.

- You can also adjust **Aspect Ratio** in the **Q-Menu**.

Set by program

Selects the proper picture proportion to match the source's image.

(4:3 → 4:3)



(16:9 → 16:9)



4:3

Choose 4:3 when you want to view a picture with an original 4:3 aspect ratio.



16:9

Adjust the picture horizontally, in a linear proportion to fill the entire screen.



Zoom 1

Choose Zoom 1 when you want to view the picture without any alteration. However, the top and bottom portions of the picture will be cropped.

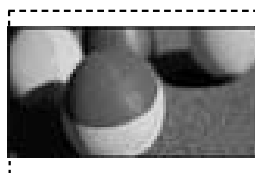

Zoom 2

Choose Zoom 2 when you want the picture to be altered, both vertically extended and cropped. The picture taking a halfway trade off between alteration and screen coverage.

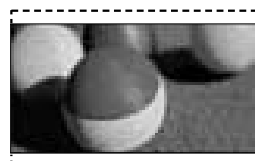

Just Scan

Following selection will lead to you view the picture of best quality without loss of original picture in high resolution image.

Notes: If there are noise in original picture, you can see the noise at the edge.

Just Scan operates only in DTV/CADTV/Component/HDMI-DTV/DVI-DTV (720p/1080i/1080p) input source.



PICTURE CONTROL







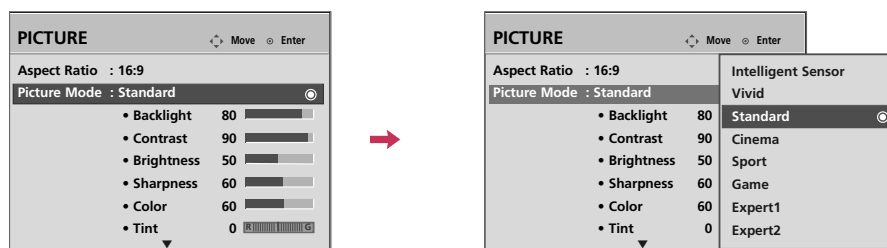

PRESET PICTURE SETTINGS

Picture Mode - Preset

There are factory presets for picture settings available in the user menus. You can use a preset, change each setting manually, or use the Intelligent Sensor.



PICTURE CONTROL

- 1   Select **PICTURE**.
- 2   Select **Picture Mode**.
- 3   Select **Intelligent Sensor** (Only 32/37/42/47/52LG50/60/70), **Vivid**, **Standard**, **Cinema**, **Sport**, or **Game**.
- 4  Return to the previous menu.
-  Return to TV viewing.









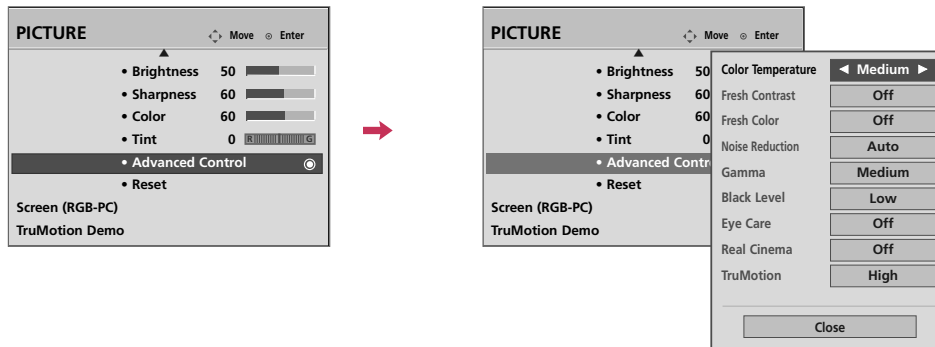

- **Intelligent Sensor, Vivid, Standard, Cinema, Sport, and Game** Settings are preset for the optimum picture quality at the factory and are not adjustable.
- When selecting **Intelligent Sensor** (Only 32/37/42/47/52LG50/60/70), the most suitable picture is automatically adjusted according to the surrounding conditions.
- You can also adjust **Picture Mode** in the **Q. Menu**.

Color Tone - Preset

Choose one of three automatic color adjustments. Set to warm to enhance hotter colors such as red, or set to cool to see less intense colors with more blue.

To initialize values (reset to default settings), select the Cool option.



- 1   Select **PICTURE**.
- 2   Select **Advanced Control**.
- 3   Select **Color Temperature**.
- 4   Select **Cool, Medium, or Warm**.
- 5  Return to the previous menu.
-  Return to TV viewing.

PICTURE CONTROL







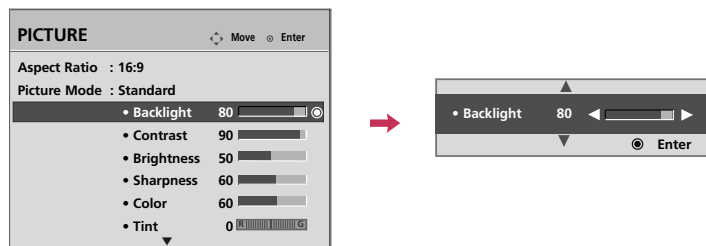





MANUAL PICTURE ADJUSTMENT

Picture Mode - User Mode

Adjust the picture appearance to suit your preference and viewing situations. This feature is disabled in "Picture Mode-Intelligent Sensor".











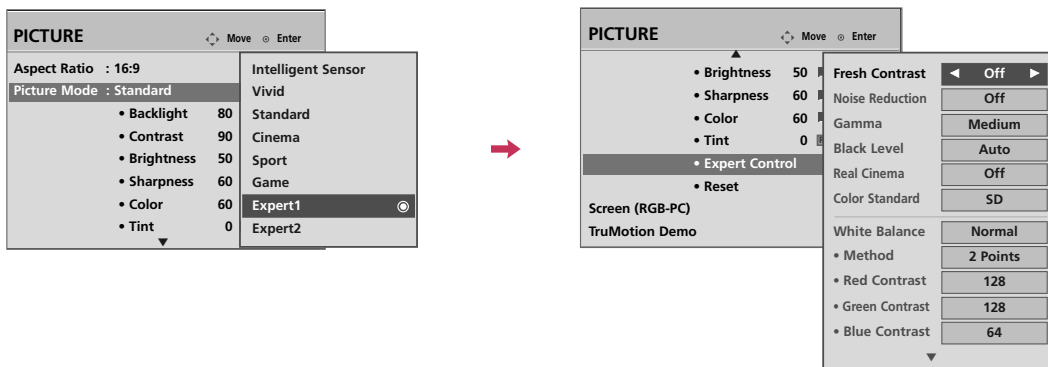





PICTURE CONTROL

-   Select **PICTURE**.
-   Select **Picture Mode**.
-   Select **Vivid, Standard, Cinema, Sport, or Game**.
-   Select **Backlight (Only LCD TV), Contrast, Brightness, Sharpness, Color, or Tint**.
-   Make appropriate adjustments.
-  Return to the previous menu.
-  Return to TV viewing.

Picture Mode - Expert Control

By segmenting categories, **Expert1** and **Expert2** provide more categories which users can set as they see fit, offering the optimal picture quality for users.



- 1   Select **PICTURE**.
- 2   Select **Picture Mode**.
- 3   Select **Expert1** or **Expert2**.
- 4   Select **Expert Control**.
- 5   Select your desired menu option.
- 6  Make appropriate adjustments.
- 7  Return to the previous menu.
-  Return to TV viewing.

PICTURE CONTROL

PICTURE IMPROVEMENT TECHNOLOGY

Fresh Contrast: Optimizes the contrast automatically according to the brightness of the reflection.







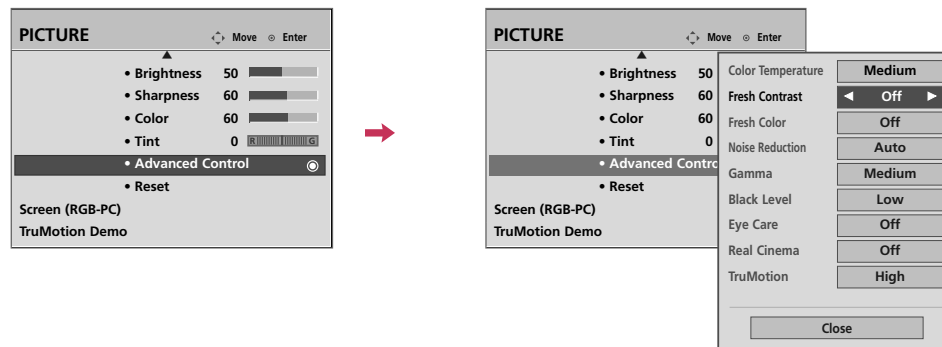



Fresh Color: Adjusts the color of the reflection automatically to reproduce as close as possible natural colors.

Noise Reduction: Removes interference up to the point where it does not damage the original picture.

Gamma: High gamma values display whitish images and low gamma values display high contrast images.











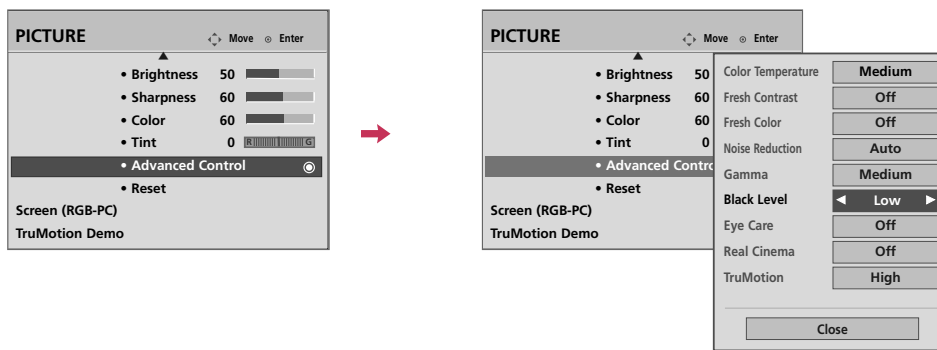

PICTURE CONTROL

-   Select **PICTURE**.
-   Select **Advanced Control**.
-   Select **Fresh Contrast, Fresh Color, Noise Reduction, or Gamma**.
-   Select your desired options.
-  Return to the previous menu.
-  Return to TV viewing.

ADVANCED CONTROL - BLACK (DARKNESS) LEVEL

Adjusting the contrast and the brightness of the screen using the black level of the screen.
This feature is disable in DTV and PC mode.



- 1   Select **PICTURE**.
- 2   Select **Advanced Control**.
- 3   Select **Black Level**.
- 4   Select **Low** or **High**.
- 5  Return to the previous menu.
-  Return to TV viewing.

- **Low:** The reflection of the screen gets darker.
- **High:** The reflection of the screen gets brighter.
- **Auto:** Realizing the black level of the screen and set it to High or Low automatically.

PICTURE CONTROL







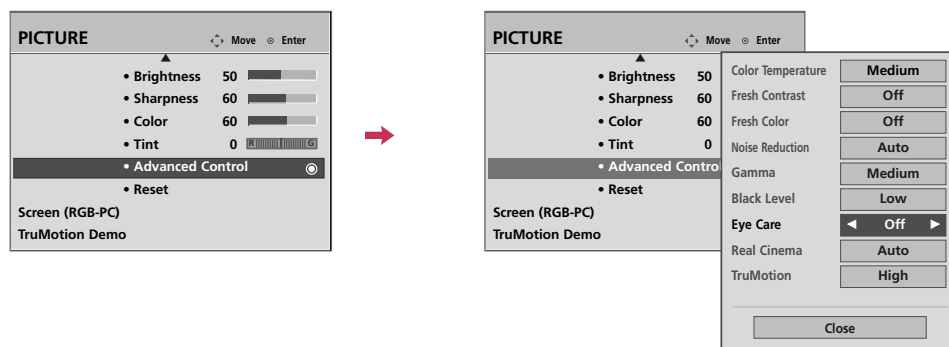



ADVANCED CONTROL - EYE CARE - LCD TV Only

Dims extremely bright pictures.

This feature is disabled in "Picture Mode-Vivid, Cinema".



PICTURE CONTROL

-   Select **PICTURE**.
-   Select **Advanced Control**.
-   Select **Eye Care**.
-   Select **On** or **Off**.
-  Return to the previous menu.
-  Return to TV viewing.

ADVANCED CONTROL - REAL CINEMA / FILM MODE







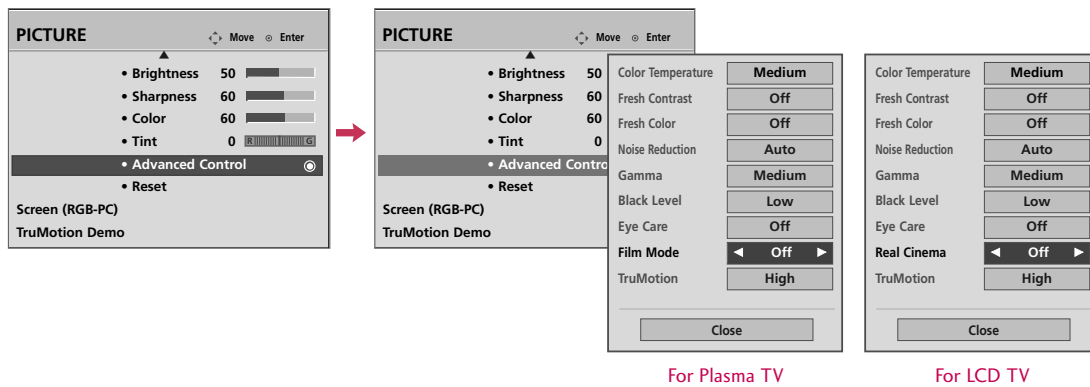



Set up the TV for the best picture appearance for viewing movies.

When you operate Real Cinema/Film Mode (3:2 Pull-Down Mode or Cinema Correction Mode), the TV will adjust 24 fps video from movies to 30 fps video for display.

This feature operates only in TV (Analog TV/CATV, Digital DTV/CADTV), AV1, AV2, Component 480i/1080i, and HDMI 1080i mode.



PICTURE CONTROL

- 1   Select **PICTURE**.
 - 2   Select **Advanced Control**.
 - 3   Select **Real Cinema** or **Film Mode**.
 - 4   Select **On** or **Off**.
 - 5  Return to the previous menu.
-  Return to TV viewing.

PICTURE CONTROL

ADVANCED CONTROL - TRUMOTION - Only 32/37/42/47/52LG60/70







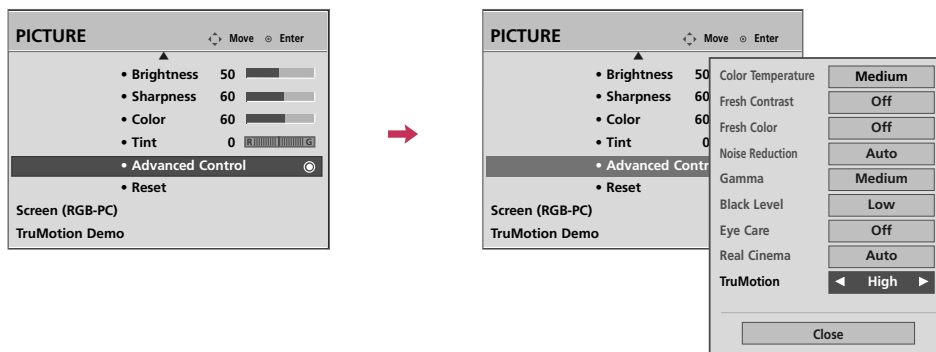



TruMotion provides even better quality for movies than 3:2 Pull-Down conversions.

TruMotion means the panel supports faster frame rates that normal panels which makes for smoother motion in video. TruMotion LCD models support 120Hz instead of 60Hz. This means twice the information on the screen in the same amount of time and easier film conversions (120 is equally divisible by 24, so no interpretations or double frames are needed).

TruMotion works with all inputs except PC mode.



PICTURE CONTROL





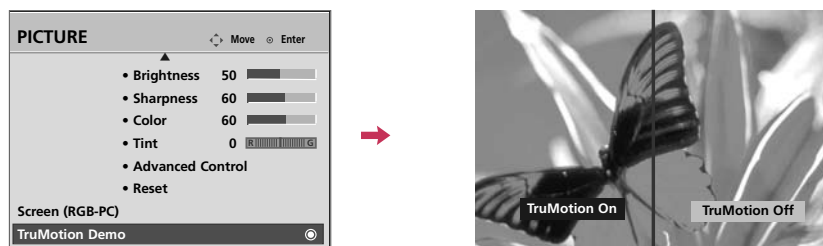

- 1   Select **PICTURE**.
- 2   Select **Advanced Control**.
- 3   Select **TruMotion**.
- 4   Select **Off, Low, or High**.
- 5  Return to the previous menu.
-  Return to TV viewing.

- **High:** Provides smoother picture movement.
- **Low:** Provides smooth picture movement. Use this setting for standard use.
- **Off:** Use this setting when “High” and “Low” setting result in noise.
- If you enable “TruMotion”, noise may appear on the screen. If this occurs, set “TruMotion” to “Off”.

TRUMOTION DEMO - Only 32/37/42/47/52LG60/70

Use this feature to see the difference TruMotion makes.
TruMotion works with all inputs except PC mode.



- 1   Select **PICTURE**.
- 2   Select **TruMotion Demo**.
- 3   Select **TruMotion On** or **Off**.
- 4  Stop **TruMotion**.





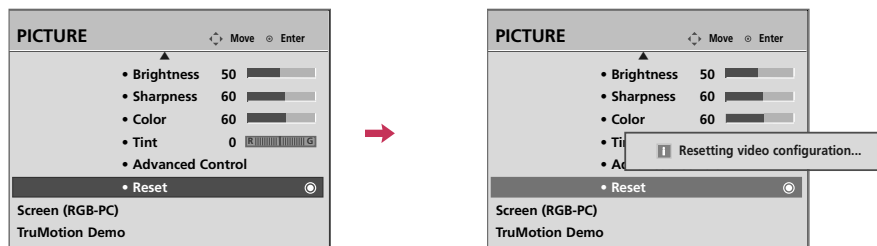

PICTURE CONTROL

PICTURE RESET

Settings of the selected picture modes return to the default factory settings.











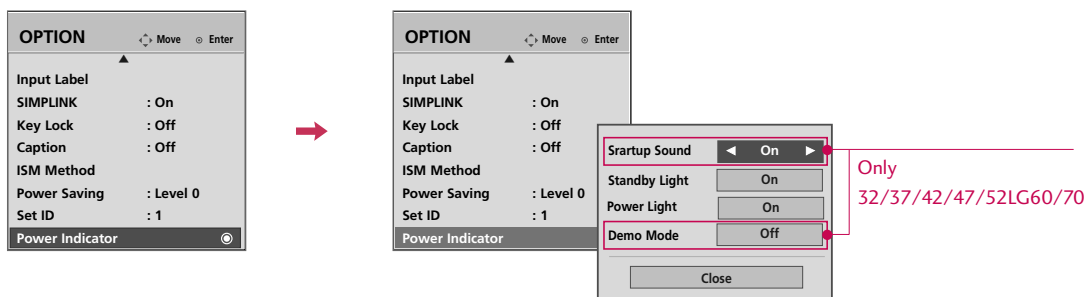

PICTURE CONTROL

-   Select **PICTURE**.
-   Select **Reset**.
-  Initialize the adjusted value.
-  Return to TV viewing.

POWER INDICATOR

It helps you adjust the brightness of moving LED and sound when power is turned on.



- 1   Select **OPTION**.
- 2   Select **Power Indicator**.
- 3   Select **Startup Sound, Standby Light, Power Light or Demo Mode**.
- 4  Select your desired options.
- 5  Return to the previous menu.
-  Return to TV viewing.

- **Startup Sound:** If you select "On", there will be a start up sound.
- **Standby Light, Power Light:**
Off: Power/Standby indicator will turn off.
On: Power/Standby indicator will turn on.
- **Demo Mode:** It shows how power on/off lighting works.
Red LED gradually fades into White LED and White LED gradually fades into Red LED.







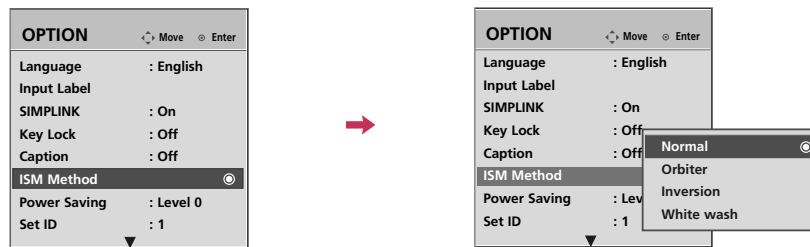

PICTURE CONTROL

IMAGE STICKING MINIMIZATION (ISM) METHOD - Plasma TV Only

A frozen still picture from a PC/video game displayed on the screen for prolonged periods can result in a ghost image. You can use Orbiter to help prevent image sticking. The other two functions are for removing a ghost image.



PICTURE CONTROL

- 1   Select **OPTION**.
- 2   Select **ISM Method**.
- 3   Select **Normal, Orbiter, Inversion** or **White wash**.
- 4  Return to the previous menu.
-  Return to TV viewing.

- **Normal:** If image sticking is never a problem, ISM is not necessary - set to Normal.
- **Orbiter:** Orbiter may help prevent ghost images. However, it is best not to allow any fixed image to remain on the screen. To avoid a ghost image on the screen, the image will move every 2 minutes.
- **Inversion:** Inversion will automatically invert the plasma display panel color every 30 minutes.
- **White Wash:** White Wash removes ghost images from the screen. Use sparingly. Watch the TV normally for a while before using this feature to see if the ghost image disappears on its own.







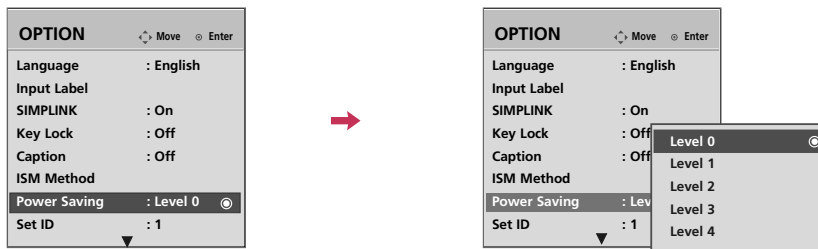

! NOTE

- ▶ An excessive ghosted image may be impossible to clear entirely with White Wash. To return to normal viewing, press the any button.

POWER SAVING PICTURE MODE - Plasma TV Only

Low power reduces the plasma display's power consumption.



- 1   Select **OPTION**.
- 2   Select **Power Saving**.
- 3   Select **Level 0, Level 1, Level 2, Level 3, or Level 4**.
- 4  Return to the previous menu.
-  Return to TV viewing.







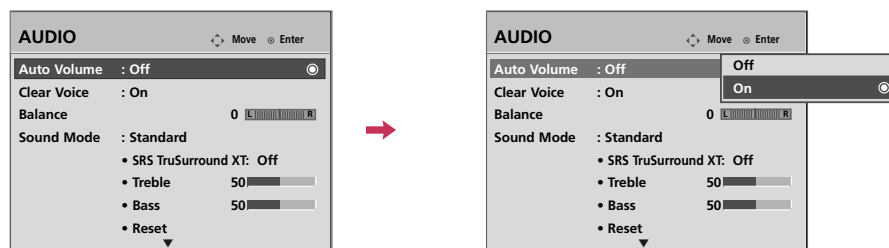

- Level 0 is the brightest.
- You can also adjust **Power Saving** in the **Q. Menu**.

SOUND & LANGUAGE CONTROL

AUTO VOLUME LEVELER (AUTO VOLUME)

Auto Volume makes sure that the volume level remains consistent whether you are watching a commercial or a regular TV program.









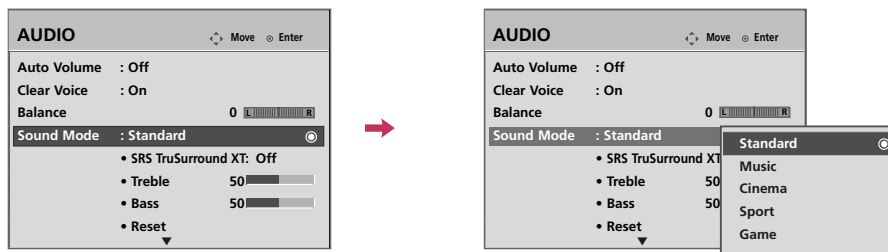

-   Select **AUDIO**.
-   Select **Auto Volume**.
-   Select **On** or **Off**.
-  Return to the previous menu.
-  Return to TV viewing.

PRESET SOUND SETTINGS (SOUND MODE)

Sound Mode lets you enjoy the best sound without any special adjustment as the TV sets the appropriate sound options based on the program content.

Standard, Music, Cinema, Sport, and Game are preset for optimum sound quality at the factory and are not adjustable.









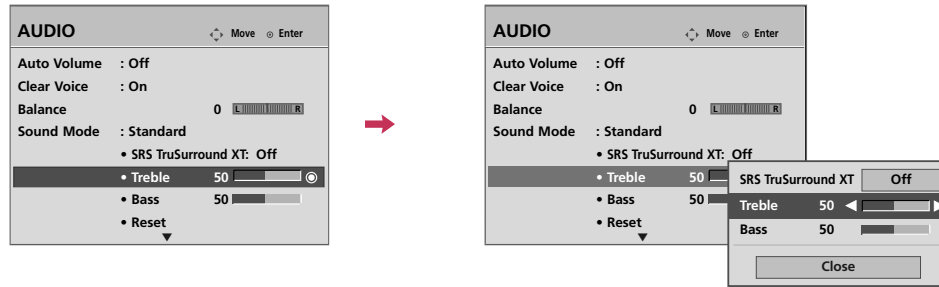

-   Select **AUDIO**.
-   Select **Sound Mode**.
-   Select **Standard, Music, Cinema, Sport, or Game**.
-  Return to the previous menu.
-  Return to TV viewing.



■ You can also adjust **Sound Mode** in the **Q. Menu**.

SOUND SETTING ADJUSTMENT - USER MODE









Adjust the sound to suit your taste and room situations.



- 1   Select **AUDIO**.
- 2   Select **Sound Mode**.
- 3   Select **Standard, Music, Cinema, Sport, or Game**.
- 4   Select **Treble or Bass**.

- 5  Make appropriate adjustments.
- 6  Return to the previous menu.
-  Return to TV viewing.

SRS TRUSURROUND XT







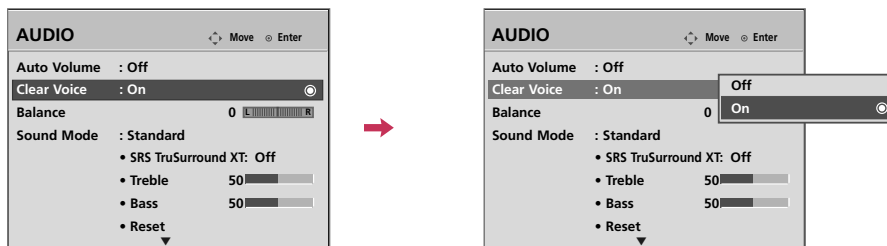

- 1   Select **AUDIO**.
- 2   Select **SRS TruSurround XT**
- 3   Select **On or Off**.
- 4  Return to the previous menu.
-  Return to TV viewing.

■ **SRS TruSurround XT:** Takes advantage of any multi-channel format without needing to add extra speakers or equipment. Dialog clarity, bass enrichment, and the addition of stereo audio enhancement produces an immersive sound experience from standard stereo material.

CLEAR VOICE

By differentiating the human sound range from others, it improves the sound quality of voices.



- 1   Select **AUDIO**.
- 2   Select **Clear Voice**.
- 3   Select **On** or **Off**.
- 4  Return to the previous menu.
-  Return to TV viewing.

- If you select “**Clear Voice-On**”, **SRS TruSurround XT** feature will not work.
- You can also adjust **Clear Voice** in the **Q-Menu**.







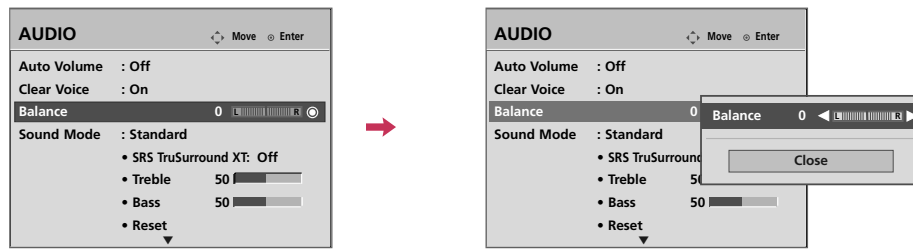

SOUND & LANGUAGE CONTROL

BALANCE

Adjust the left/right sound of speaker to suit your taste and room situations.









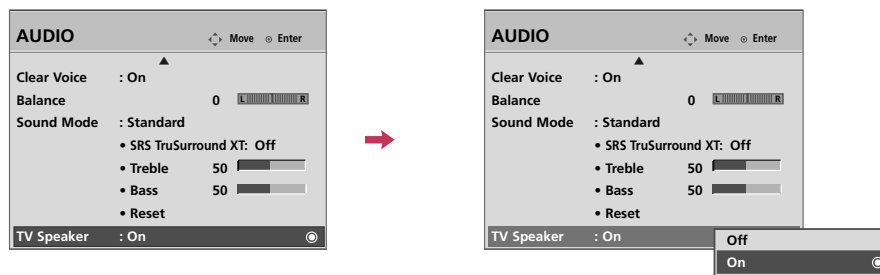

SOUND & LANGUAGE CONTROL

-   Select **AUDIO**.
-   Select **Balance**.
-   Make appropriate adjustments.
-  Return to the previous menu.
-  Return to TV viewing.

TV SPEAKERS ON/OFF SETUP

Turn the TV speakers off if using external audio equipment.







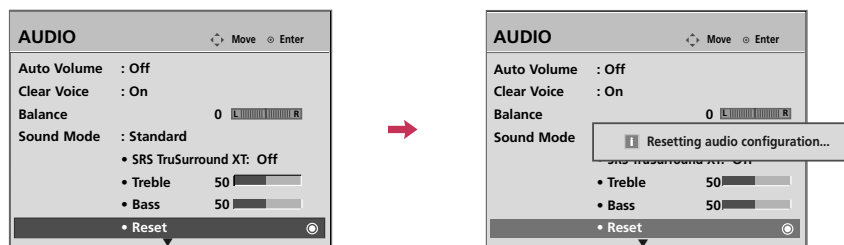

-   Select **AUDIO**.
-   Select **TV Speaker**.
-   Select **On** or **Off**.
-  Return to the previous menu.
-  Return to TV viewing.

SOUND & LANGUAGE CONTROL

AUDIO RESET

Settings of the selected Sound Mode return to the default factory settings.



- 1   Select **AUDIO**.
- 2   Select **Reset**.
- 3  Initialize the adjusted value.
- 4  Return to TV viewing.

STEREO/SAP BROADCAST SETUP

For Analog only: This TV can receive MTS stereo programs and any SAP (Secondary Audio Program) that accompanies the stereo program if the station transmits an additional sound signal. Mono sound is automatically used if the broadcast is only in Mono.



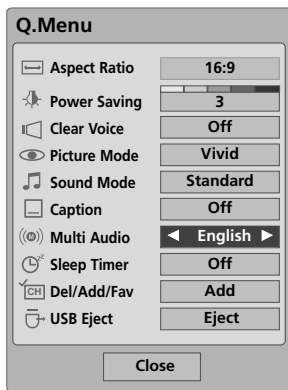

Plasma TV

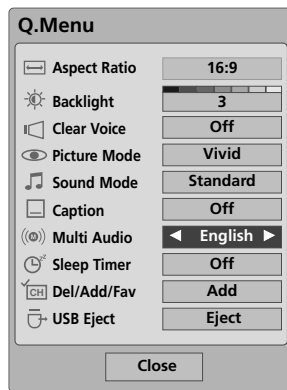





LCD TV



Analog TV

- 1   Select **SAP**.
- 2  Select **Mono, Stereo, or SAP**.
- 3  Return to TV viewing.

Digital TV

- 1   Select **Multi Audio**.
- 2  Select other languages.
- 3  Return to TV viewing.

SOUND & LANGUAGE CONTROL

AUDIO LANGUAGE

Other languages may be available if a digital signal is provided by the broadcasting station.
This feature operates only in DTV/CADTV mode.

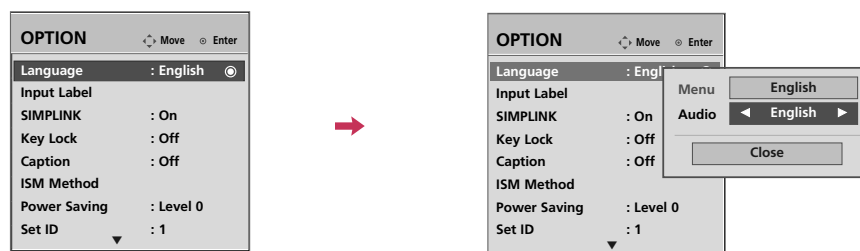







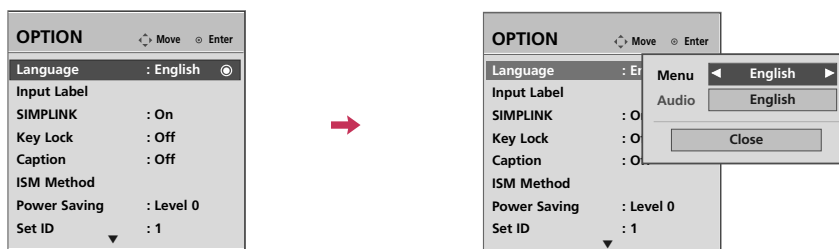

-   Select **OPTION**.
-   Select **Language**.
-   Select **Audio**.
-  Select your desired language:
English, Spanish, or French
-  Return to the previous menu.
-  Return to TV viewing.

ON-SCREEN MENUS LANGUAGE SELECTION

The menus can be shown on the screen in the selected language.



- 1   Select **OPTION**.
- 2   Select **Language**.
- 3   Select **Menu**.
- 4  Select your desired language.
From this point on, the on-screen menus will be shown in the selected language.
- 5  Return to the previous menu.
-  Return to TV viewing.

SOUND & LANGUAGE CONTROL

CAPTION MODE

Analog Broadcasting System Captions

Caption must be provided to help people with hearing loss watch TV. Select a caption mode for displaying captioning information if provided on a program. Analog caption displays information at any position on the screen and is usually the program's dialog. Caption/Text, if provided by the broadcaster, would be available for both digital and analog channels on the Antenna/Cable. This TV is programmed to memorize the caption/text mode which was last set when you turned the power off. This function is only available when **Caption Mode** is set **On**.

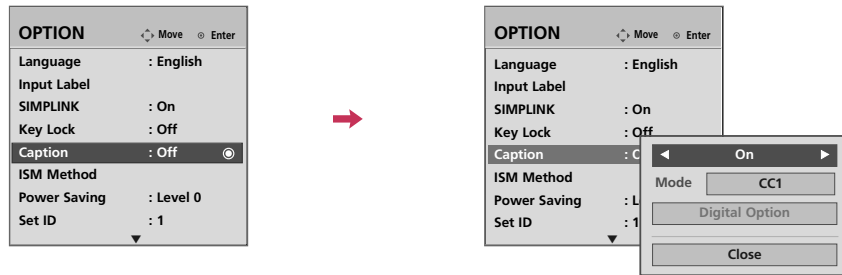

SOUND & LANGUAGE CONTROL

- 1 Select **OPTION**.
 - 2 Select **Caption**.
 - 3 Select **On**.
 - 4 Select **CC1-4** or **Text1-4**.
 - 5 Return to the previous menu.
- Return to TV viewing.

- When selecting **Off**, Sub-menus for Analog, DTV, and Digital Option become disabled.
- **CAPTION**
The term for the words that scroll across the bottom of the TV screen; usually the audio portion of the program provided for the hearing impaired.
- **TEXT**
The term for the words that appear in a large black frame and almost cover the entire screen; usually messages provided by the broadcaster.









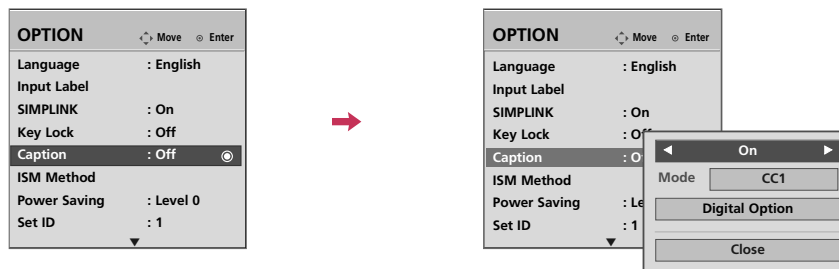

Digital Broadcasting System Captions

Choose the language you want the DTV/CADTV Captions to appear in.

Other Languages can be chosen for digital sources only if they are included on the program.

This function is only available when **Caption Mode** is set **On**.



- 1   Select **OPTION**.
- 2   Select **Caption**.
- 3   Select **On**.
- 4   Select **CC1-4, Text1-4, or Service1 - 6**.
- 5  Return to the previous menu.
-  Return to TV viewing.







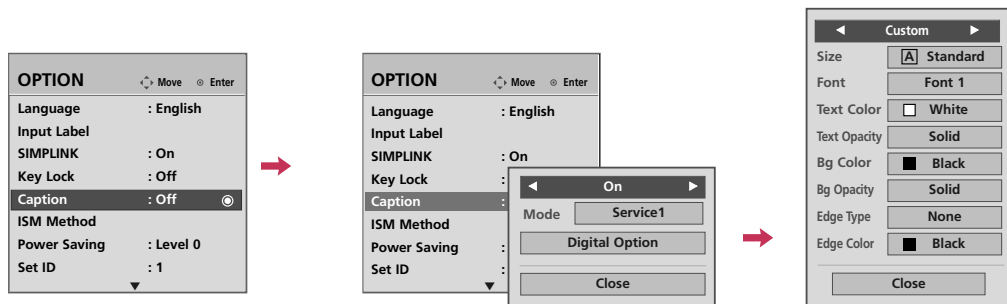







SOUND & LANGUAGE CONTROL

Caption Option

Customize the DTV/CADTV captions that appear on your screen.
This function is only available when **Caption Mode** is set **On**.



SOUND & LANGUAGE CONTROL

- 1   Select **OPTION**.
- 2   Select **Caption**
- 3   Select **On**.
- 4   Select **Digital Option**.
- 5   Select **Custom**.
- 6   Customize the **Style, Font**, etc., to your preference. A preview icon is provided at the bottom of the screen, use it to see the caption language.
- 7  Return to the previous menu.
-  Return to TV viewing.

- **Size:** Set the word size.
- **Font:** Select a typeface for the text.
- **Text Color:** Choose a color for the text.
- **Text Opacity:** Specify the opacity for the text color.
- **Bg (Background) Color:** Select a background color.
- **Bg (Background) Opacity:** Select the opacity for the background color.
- **Edge Type:** Select an edge type.
- **Edge Color:** Select a color for the edges.

TIME SETTING

CLOCK SETTING









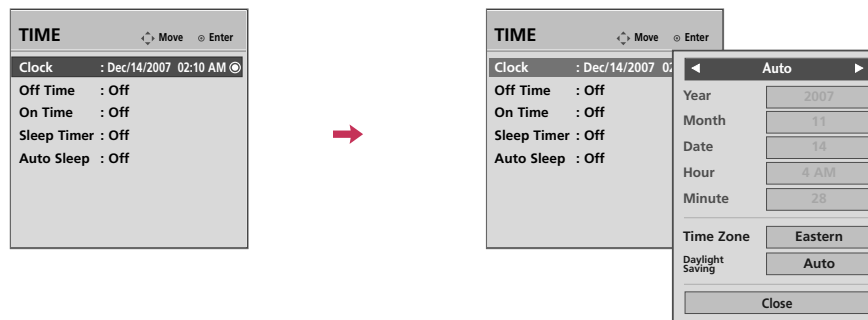



Auto Clock Setup

The time is set automatically from a digital channel signal.

The digital channel signal includes information for the current time provided by the broadcasting station.

Set the clock manually if the current time is set incorrectly by the auto clock function.









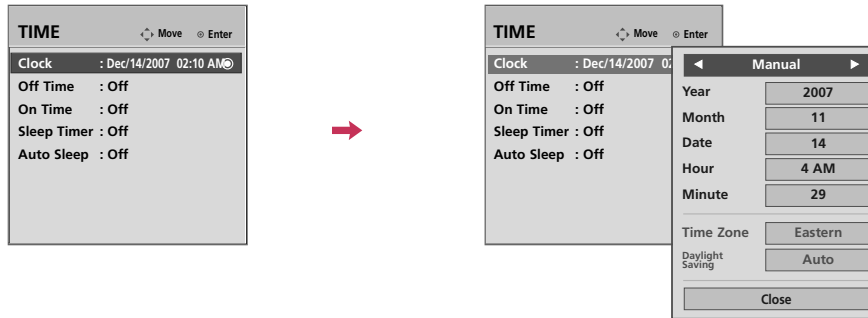



- 1   Select **TIME**.
- 2   Select **Clock**.
- 3   Select **Auto**.
- 4   Select your viewing area time zone.
 - U.S.A: **Eastern, Central, Mountain, Pacific, Alaska, or Hawaii.**
 - Canada: **Eastern, Central, Mountain, Pacific, New F.land, or Atlantic.**
- 5   Select **Auto, Off, or On** (depending on whether or not your viewing area observes Daylight Saving time).
- 6  Return to the previous menu.
-  Return to TV viewing.

Manual Clock Setup

If the current time setting is wrong, reset the clock manually.



-   Select **TIME**.
-   Select **Clock**.
-   Select **Manual**.
-  Select the Year, Month, Date, Hour, or Minutes option.
-  Set the Year, Month, Date, Hour, or Minutes option.
-  Return to the previous menu.
-  Return to TV viewing.

AUTO ON/OFF TIME SETTING

This function operates only if the current time has been set.

The **Off Time** function overrides the **On Time** function if they are both set to the same time.

The TV must be in standby mode for the **On Time** to work.

If you do not press any button within 2 hours after the TV turns on with the **On Time** function, the TV will automatically revert to standby mode.

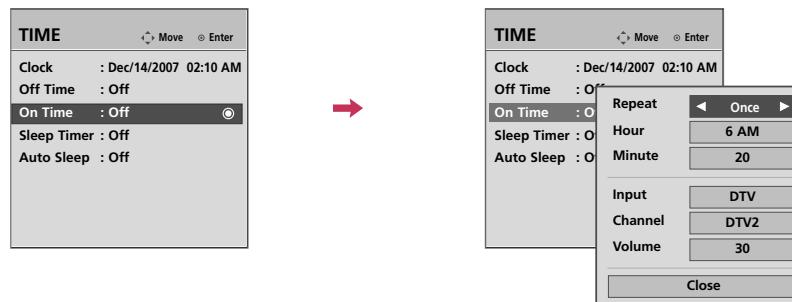

- 1 Select **TIME**.
- 2 Select **Off time** or **On time**.
- 3 Select **Repeat**.
- 4 Select **Once, Everyday, Mon~Fri, Mon~Sat, Weekend, or Sunday**.
- 5 Select and set **Hour** or **Minute**.
- 6 Return to the previous menu.
- Return to TV viewing.







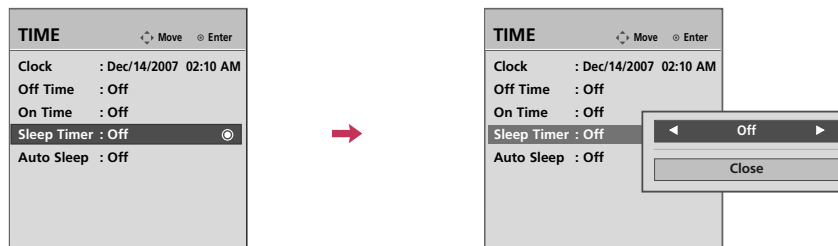

- To cancel **On/Off Time** function, select **Off**.
- Only for On Time function

- 1 Select **Input**.
- 2 Select **TV, AV1-2, Component1-2, RGB-PC, or HDMI1-4**.
- 3 When Selecting **TV**: set the channel at turn-on.
- 4 Adjust to sound level at turn-on.

SLEEP TIMER SETTING

The Sleep Time turns the TV off at the preset time.
Note that this setting is cleared when the TV is turned off.









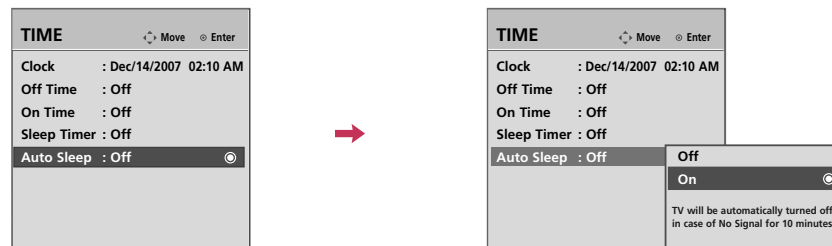

-   Select **TIME**.
-   Select **Sleep Timer**.
-   Select **10, 20, 30, 60, 90, 120, 180, or 240** minutes.
-  Return to the previous menu.
-  Return to TV viewing.

■ You can also adjust **Sleep Timer** in the **Q-Menu**.

AUTO SHUT-OFF SETTING

TV will be automatically turned off, in case of no signal for 10 minutes.



- 1   Select **TIME**.
- 2   Select **Auto Sleep**.
- 3   Select **On** or **Off**.
- 4  Return to the previous menu.
-  Return to TV viewing.

PARENTAL CONTROL / RATINGS

Parental Control can be used to block specific channels, ratings and other viewing sources.

The Parental Control Function (V-Chip) is used to block program viewing based on the ratings sent by the broadcasting station. The default setting is to allow all programs to be viewed. Viewing can be blocked by choosing the type of the program and the categories. It is also possible to block all program viewing for a time period. To use this function, the following must be done :

1. Set ratings and categories to be blocked.
2. Specify a password
3. Enable the lock

V-Chip rating and categories

Rating guidelines are provided by broadcasting stations. Most television programs and television movies can be blocked by TV Rating and/or Individual Categories. Movies that have been shown at the theaters or direct-to-video movies use the Movie Rating System (MPAA) only.

Ratings for Television programs including made-for-TV movies :





- TV-G (General audience)
- TV-PG (Parental guidance suggested)
- TV-14 (Parents strongly cautioned)
- TV-MA (Mature audience only)
- TV-Y (All children)
- TV-Y7 (Children 7 years older)

SET PASSWORD & LOCK SYSTEM

Setting up Your Password

Set up blocking schemes to block specific channels, ratings, and external viewing sources. A password is required to gain access to this menu.







1.    Select **LOCK**.
2.  Input the password.

- Enter the password as requested.
- The TV is set up with the initial password "0-0-0-0".

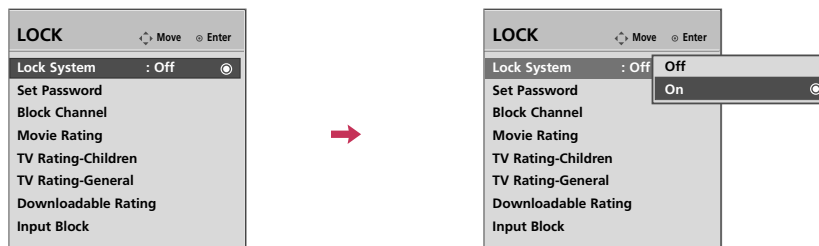
Lock System

Enables or disables the blocking scheme you set up previously.





1    Select **LOCK**.

2  Input the password.

3  Select **Lock System**.

4   Select **On** or **Off**.

5  Return to the previous menu.

 Return to TV viewing.



- When you select **On**, the Lock System is enable.

PARENTAL CONTROL / RATINGS

Set Password

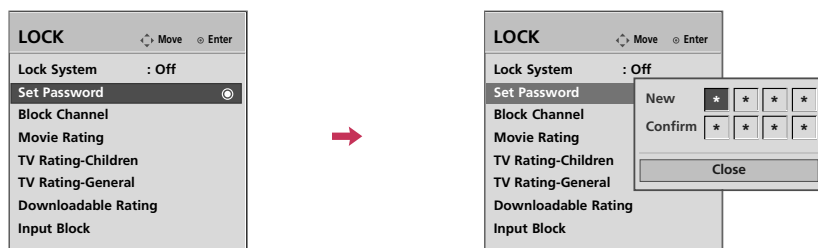

Change the password by inputting a new password twice.





1    Select **LOCK**.

2  Input the password.

3  Select **Set password**.

4   Choose any 4 digits for your new password.
As soon as the 4 digits are entered, re-enter the same 4 digits on the **Confirm**.









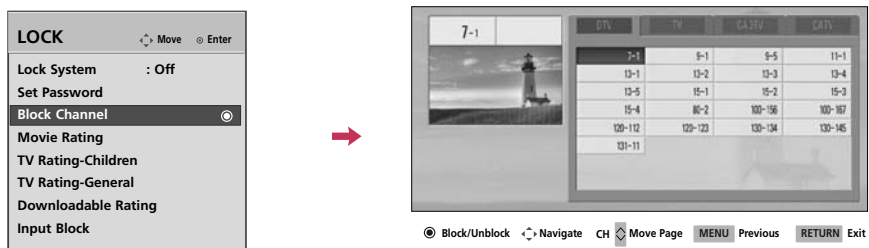

5  Return to the previous menu.

 Return to TV viewing.

CHANNEL BLOCKING

Blocks any channels that you do not want to watch or that you do not want your children to watch.



- 1    Select **LOCK**.
- 2  Input the password.
- 3  Select **Block Channel**.
- 4   Select a channel to block or unblock.
- 5  Block or unblock a channel.
- 6  Return to the previous menu.
-  Return to TV viewing.







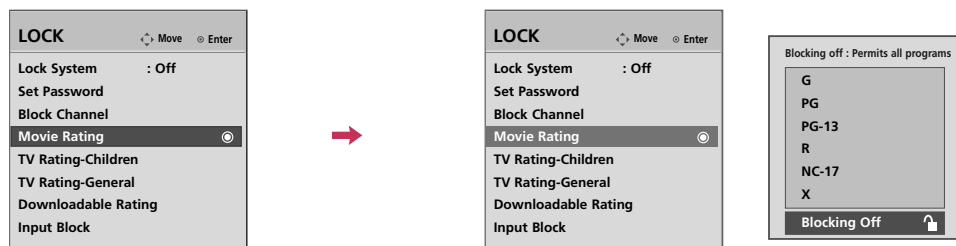

PARENTAL CONTROL / RATINGS

MOVIE & TV RATING

Movie Rating (MPAA) - For USA only

Blocks movies according to the movie ratings limits specified, so children cannot view certain movies. You can set the ratings limit by blocking out all the movies with the ratings above a specified level. Keep in mind that the movie ratings limit only applies to movies shown on TV, not TV programs, such as soap operas.







- 1    Select **LOCK**.
- 2  Input the password.
- 3  Select **Movie Rating**.
- 4   Select **G, PG, PG-13, R, NC-17** or **X**.
- 5  Return to the previous menu.
-  Return to TV viewing.

- G (General audience)
- PG (Parental guidance suggested)
- PG-13 (Parents strongly cautioned)
- R (Restricted)
- NC-17 (No one 17 and under admitted)
- X (Adult only)
- Blocking Off (Permits all programs)
- ▶ If you set PG-13: G and PG movies will be available, PG-13, R, NC-17 and X will be blocked.

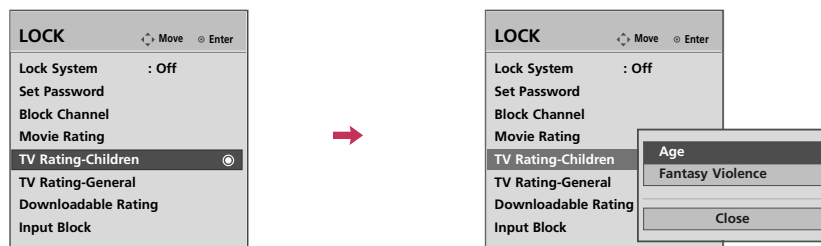
TV Rating Children - For USA only

Prevents children from watching certain children's TV programs, according to the ratings limit set. The children rating does not apply to other TV programs. Unless you block certain TV programs intended for mature audiences in the TV Rating - sub menu, your children can view those programs.



1    Select **LOCK**.

2  Input the password.

3  Select **TV Rating-Children**.

4   Select **Age** or **Fantasy Violence**.

5   Select block options.

6  Return to the previous menu.

 Return to TV viewing.



- Age (applies to TV-Y, TV-Y7)
- Fantasy Violence (applies to TV-Y7)

PARENTAL CONTROL / RATINGS

TV Rating General - For USA only

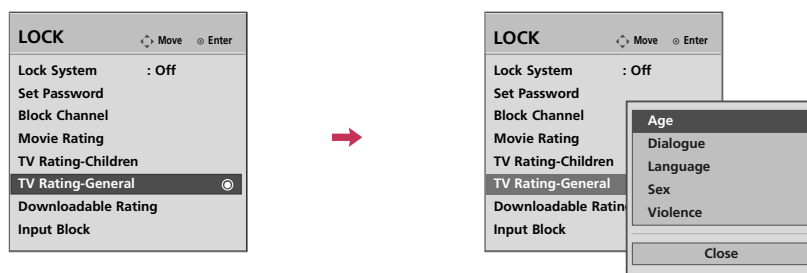
Based on the ratings, blocks certain TV programs that you and your family do not want to view.



1    Select **LOCK**.

2  Input the password.

3  Select **TV Rating-General**.

4   Select **Age, Dialogue, Language, Sex or Violence**.

5   Select block options.

6  Return to the previous menu.

 Return to TV viewing.

- Age (applies to TV-G,TV-PG,TV-14,TV-MA).
- Dialogue-sexual dialogue (applies to TV-PG,TV-14).
- Language-adult language (applies to TV-PG, TV-14, TV-MA).
- Sex-sexual situations (applies to TV-PG, TV-14, TV-MA).
- Violence (applies to TV-PG, TV-14, TV-MA).

TV Rating English - For CANADA only

Selecting canadian english language rating system.

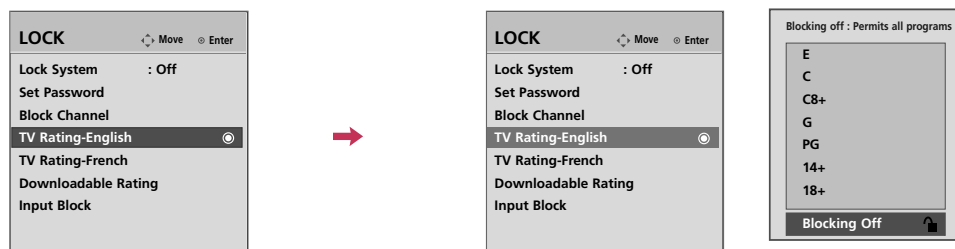

1 Select **LOCK**.

2 Input the password.

3 Select **TV Rating-English**.

4 Select **E, C, C8+, G, PG, 14+, 18+, or Blocking Off**.

5 Return to the previous menu.

Return to TV viewing.



- E (Exempt)
- C (Children)
- C8+ (Children eight years and older)
- G (General programming, suitable for all audiences)
- PG (Parental Guidance)
- 14+ (Viewers 14 years and older)
- 18+ (Adult programming)
- Blocking Off (Permits all programs)

PARENTAL CONTROL / RATINGS

TV Rating French - For CANADA only

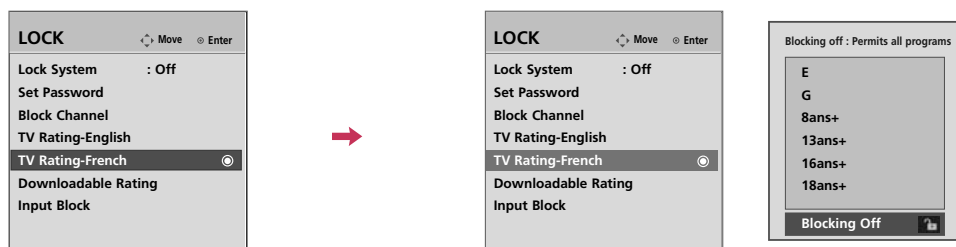

Selecting canadian french language rating system.





1    Select **LOCK**.

2  Input the password.

3  Select **TV Rating-French**.

4   Select **E, G, 8ans+, 13ans+, 16ans+, 18ans+, or Blocking off**.

5  Return to the previous menu.









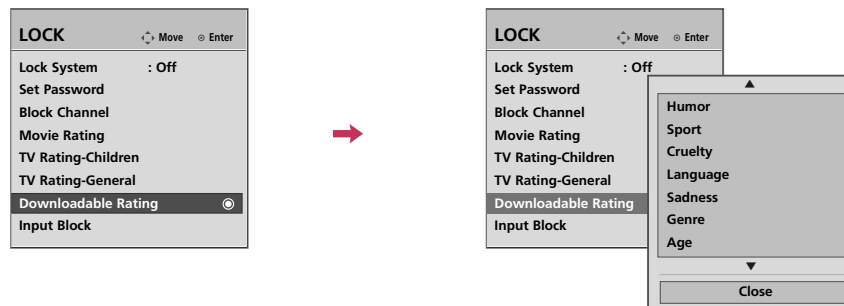



 Return to TV viewing.

- E (Exempt)
- G (General)
- 8ans+ (General-Not convenient for little children)
- 13ans+ (Not convenient for children of 13 years and younger)
- 16ans+ (Not convenient for children of 16 years and younger)
- 18ans+ (This programs is only for adults)
- Blocking off (Permits all programs)

DOWNLOADABLE RATING

This function may become available in the future and will be available only for digital channels.
This function operates only when TV has received Region5 Rating data.



- 1    Select **LOCK**.
- 2  Input the password.
- 3  Select **Downloadable Rating**.
- 4   Select desired **Downloadable Rating** option.
- 5   Select desired **Humor, Sport, Cruelty, Language, Sadness, Genre, Age, or Movie** option.
- 6   Select block options.
- 7  Return to the previous menu.
-  Return to TV viewing.









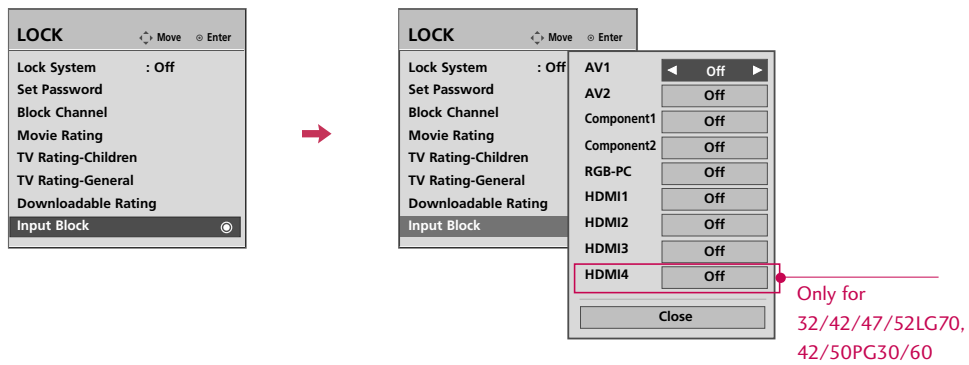

■ Based on rating table, your TV's OSD (On Screen Display) may differ slightly from what is shown in this manual.

PARENTAL CONTROL / RATINGS

EXTERNAL INPUT BLOCKING

Enables you to block an input.









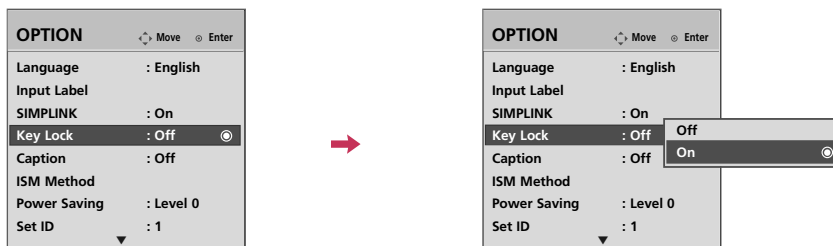

-    Select **LOCK**.
-  Input the password.
-  Select **Input Block**.
-   Select input source.
-  Select **On** or **Off**.
-  Return to the previous menu.
-  Return to TV viewing.

KEY LOCK

The TV can be set up so that it can only be used with the remote control.
 This feature can be used to prevent unauthorized viewing by locking out the front panel controls.
 This TV is programmed to remember which option it was last set to even if you turn the TV off.



- 1   Select **OPTION**.
- 2   Select **Key Lock**.
- 3   Select **On** or **Off**.
- 4  Return to the previous menu.
-  Return to TV viewing.

- In **Key Lock 'On'**, if the TV is turned off, press the \odot / I, INPUT, CH \wedge \vee button on the TV or POWER, INPUT, CH \wedge \vee or NUMBER buttons on the remote control.
- With the **Key Lock On**, the display '**Key Lock On**' appears on the screen if any button on the front panel is pressed while viewing the TV.

APPENDIX

TROUBLESHOOTING

The operation does not work normally.	
The remote control doesn't work	<ul style="list-style-type: none"> Check to see if there is any object between the product and the remote control causing obstruction. Ensure you are pointing the remote control directly at the TV. Ensure that the batteries are installed with correct polarity (+ to +, - to -). Ensure that the correct remote operating mode is set: TV, VCR etc. Install new batteries.
Power is suddenly turned off	<ul style="list-style-type: none"> Is the sleep timer set? Check the power control settings. Power interrupted. No broadcast on station tuned with Auto-off activated.

The video function does not work.	
No picture & No sound	<ul style="list-style-type: none"> Check whether the product is turned on. Try another channel. The problem may be with the broadcast. Is the power cord inserted into wall power outlet? Check your antenna direction and/or location. Test the wall power outlet, plug another product's power cord into the outlet where the product's power cord was plugged in.
Picture appears slowly after switching on	<ul style="list-style-type: none"> This is normal, the image is muted during the product startup process. Please contact your service center, if the picture has not appeared after five minutes.
No or poor color or poor picture	<ul style="list-style-type: none"> Adjust Color in menu option. Keep a sufficient distance between the product and the VCR. Try another channel. The problem may be with the broadcast. Are the video cables installed properly? Activate any function to restore the brightness of the picture.
Horizontal/vertical bars or picture shaking	<ul style="list-style-type: none"> Check for local interference such as an electrical appliance or power tool.
Poor reception on some channels	<ul style="list-style-type: none"> Station or cable product experiencing problems, tune to another station. Station signal is weak, reorient antenna to receive weaker station. Check for sources of possible interference.
Lines or streaks in pictures	<ul style="list-style-type: none"> Check antenna (Change the direction of the antenna).

The audio function does not work.	
Picture OK & No sound	<ul style="list-style-type: none"> ■ Press the VOL or VOLUME button. ■ Sound muted? Press MUTE button. ■ Try another channel. The problem may be with the broadcast. ■ Are the audio cables installed properly?
No output from one of the speakers	<ul style="list-style-type: none"> ■ Adjust Balance in menu option.
Unusual sound from inside the product	<ul style="list-style-type: none"> ■ A change in ambient humidity or temperature may result in an unusual noise when the product is turned on or off and does not indicate a fault with the product.

There is a problem in PC mode. (Only PC mode applied)	
The signal is out of range	<ul style="list-style-type: none"> ■ Adjust resolution, horizontal frequency, or vertical frequency. ■ Check the input source.
Vertical bar or stripe on background & Horizontal Noise & Incorrect position	<ul style="list-style-type: none"> ■ Work the Auto configure or adjust clock, phase, or H/V position. (Option)
Screen color is unstable or single color	<ul style="list-style-type: none"> ■ Check the signal cable. ■ Reinstall the PC video card.



MAINTENANCE

Early malfunctions can be prevented. Careful and regular cleaning can extend the amount of time you can enjoy your new TV.

Caution: Be sure to turn the power off and unplug the power cord before you begin any cleaning.

Cleaning the Screen

- 1 Here's a great way to keep the dust off your screen for a while. Wet a soft cloth in a mixture of lukewarm water and a little fabric softener or dish washing detergent. Wring the cloth until it's almost dry, and then use it to wipe the screen.
- 2 Make sure the excess water is off the screen, and then let it air-dry before you turn on your TV.

Cleaning the Cabinet

- To remove dirt or dust, wipe the cabinet with a soft, dry, lint-free cloth.
- Please be sure not to use a wet cloth.

Extended Absence

CAUTION

- ▶ If you expect to leave your TV dormant for a long time (such as a vacation), it's a good idea to unplug the power cord to protect against possible damage from lightning or power surges.

PRODUCT SPECIFICATIONS

MODELS		32LG30 (32LG30-UA)	37LG30 (37LG30-UA)	42LG30 (42LG30-UA)
Dimensions (Width x Height x Depth)	With stand	31.6 x 23.8 x 8.9 inches 801.8 x 604.2 x 227.3 mm	36.2 x 26.9 x 11.6 inches 919.6 x 682.3 x 293.8 mm	40.7 x 29.2 x 11.6 inches 1032.8 x 742.3 x 293.8 mm
	Without stand	31.6 x 21.4 x 4.0 inches 801.8 x 544.1 x 101.0 mm	36.2 x 24.0 x 4.5 inches 919.6 x 610.3 x 114.3 mm	40.7 x 26.4 x 4.5 inches 1032.8 x 670.1 x 115.1 mm
Weight	With stand	29.5 pounds / 13.4 kg	41.4 pounds / 18.8 kg	52.0 pounds / 23.6 kg
	Without stand	26.0 pounds / 11.8 kg	35.7 pounds / 16.2 kg	46.3 pounds / 21.0 kg
MODELS		37LG50 (37LG50-UA)	42LG50 (42LG50-UA)	
Dimensions (Width x Height x Depth)	With stand	36.9 x 27.0 x 11.6 inches 936.4 x 684.4 x 293.8 mm	36.9 x 27.0 x 11.6 inches 936.4 x 684.4 x 293.8 mm	
	Without stand	36.9 x 24.1 x 3.5 inches 936.4 x 612.8 x 88.0 mm	36.9 x 24.1 x 3.5 inches 936.4 x 612.8 x 88.0 mm	
Weight	With stand	40.3 pounds / 18.3 kg	40.3 pounds / 18.3 kg	
	Without stand	34.4 pounds / 15.6 kg	34.4 pounds / 15.6 kg	
MODELS		47LG50 (47LG50-UA)	52LG50 (52LG50-UA)	
Dimensions (Width x Height x Depth)	With stand	45.4 x 31.8 x 12.8 inches 1153.7 x 807.2 x 326.0 mm	50.9 x 35.1 x 13.5 inches 1291.7 x 892.2 x 342.9 mm	
	Without stand	45.4 x 29.0 x 4.1 inches 1153.7 x 734.5 x 103.0 mm	50.9 x 32.2 x 4.5 inches 1291.7 x 817.0 x 115.3 mm	
Weight	With stand	85.1 pounds / 38.6 kg	87.1 pounds / 39.5 kg	
	Without stand	77.0 pounds / 34.9 kg	77.0 pounds / 34.9 kg	
Power requirement Television System Program Coverage External Antenna Impedance		AC100-240V ~ 50/60Hz NTSC-M, ATSC, 64 & 256 QAM VHF 2-13, UHF 14-69, CATV 1-135, DTV 2-69, CADTV 1-135 75 ohm		
Environment condition	Operating Temperature Operating Humidity	32 ~ 104°F (0 ~ 40°C) Less than 80%		
	Storage Temperature Storage Humidity	-4 ~ 140°F (-20 ~ 60°C) Less than 85%		

■ The specifications shown above may be changed without prior notice for quality improvement.

APPENDIX

MODELS		32LG60 (32LG60-UA)	37LG60 (37LG60-UA)	42LG60 (42LG60-UA)
Dimensions (Width x Height x Depth)	With stand	31.8 x 23.9x 9.8 inches 806.6 x 606.5 x 249.0mm	36.5 x 27.3 x 11.0 inches 927.0 x 692.8 x 280.5 mm	40.7 x 29.5 x 11.3 inches 1033.4 x 750.0 x 287.6 mm
	Without stand	31.8 x 21.7 x 3.1 inches 806.6 x 552.3 x 79.0 mm	36.5 x 24.8 x 3.5 inches 927.0 x 630.0 x 88.0 mm	40.7 x 27.0x 3.5 inches 1033.4 x 686.8 x 88.5 mm
Weight	With stand	30.2 pounds / 13.7 kg	44.1 pounds / 20.0 kg	54.9 pounds / 24.9 kg
	Without stand	24.7 pounds / 11.2 kg	35.3 pounds / 16.0 kg	45.0 pounds / 20.4 kg
MODELS		47LG60 (47LG60-UA)	52LG60 (52LG60-UA)	
Dimensions (Width x Height x Depth)	With stand	45.4 x 31.8 x 12.8 inches 1153.7 x 807.2 x 326.0 mm	50.9 x 35.1 x 13.5 inches 1291.7 x 892.2 x 342.9 mm	
	Without stand	45.4 x 29.0 x 4.1 inches 1153.7 x 734.5 x 103.0 mm	50.9 x 32.2 x 4.5 inches 1291.7 x 817.0 x 115.3 mm	
Weight	With stand	85.1 pounds / 38.6 kg	87.1 pounds / 39.5 kg	
	Without stand	77.0 pounds / 34.9 kg	77.0 pounds / 34.9 kg	
MODELS		32LG70 (32LG70-UA)	42LG70 (42LG70-UA)	
Dimensions (Width x Height x Depth)	With stand	31.8 x 23.9x 9.8 inches 806.6 x 606.5 x 249.0mm	40.7 x 29.5 x 11.3 inches 1033.4 x 750.0 x 287.6 mm	
	Without stand	31.8 x 21.7 x 3.1 inches 806.6 x 552.3 x 79.0 mm	40.7 x 27.0x 3.5 inches 1033.4 x 686.8 x 88.5 mm	
Weight	With stand	30.2 pounds / 13.7 kg	54.9 pounds / 24.9 kg	
	Without stand	24.7 pounds / 11.2 kg	45.0 pounds / 20.4 kg	
MODELS		47LG70 (47LG70-UA)	52LG70 (52LG70-UA)	
Dimensions (Width x Height x Depth)	With stand	45.4 x 31.8 x 12.8 inches 1153.7 x 807.2 x 326.0 mm	50.9 x 35.1 x 13.5 inches 1291.7 x 892.2 x 342.9 mm	
	Without stand	45.4 x 29.0 x 4.1 inches 1153.7 x 734.5 x 103.0 mm	50.9 x 32.2 x 4.5 inches 1291.7 x 817.0 x 115.3 mm	
Weight	With stand	85.1 pounds / 38.6 kg	87.1 pounds / 39.5 kg	
	Without stand	77.0 pounds / 34.9 kg	77.0 pounds / 34.9 kg	
Power requirement Television System Program Coverage External Antenna Impedance		AC100-240V ~ 50/60Hz NTSC-M, ATSC, 64 & 256 QAM VHF 2-13, UHF 14-69, CATV 1-135, DTV 2-69, CADTV 1-135 75 ohm		
Environment condition	Operating Temperature Operating Humidity	32 ~ 104°F (0 ~ 40°C) Less than 80%		
	Storage Temperature Storage Humidity	-4 ~ 140°F (-20 ~ 60°C) Less than 85%		

■ The specifications shown above may be changed without prior notice for quality improvement.

MODELS		42PG20 (42PG20-UA) 42PG20C (42PG20C-UA)	50PG20 (50PG20-UA) 50PG20C (50PG20C-UA)
Dimensions (Width x Height x Depth)	With stand	41.3 x 30.2 x 12.2 inches 1048.0 x 766.0 x 310.0 mm	48.9 x 34.9 x 14.6 inches 1242.0 x 887.6 x 370.0 mm
	Without stand	41.3 x 28.1 x 3.3 inches 1048.0 x 713.0 x 83.5 mm	48.9 x 32.6 x 3.5 inches 1242.0 x 827.2 x 88.0 mm
Weight	With stand	61.7 pounds / 28.0 kg	86.6 pounds / 39.3 kg
	Without stand	54.2 pounds / 24.6 kg	76.3 pounds / 34.6 kg
MODELS		50PG30 (50PG30F-UA)	60PG30 (60PG30F-UA)
Dimensions (Width x Height x Depth)	With stand	48.9 x 34.9 x 14.6 inches 1242.0 x 887.6 x 370.0 mm	57.3 x 38.8 x 16.3 inches 1455.0 x 985.0 x 414.0 mm
	Without stand	48.9 x 32.6 x 3.5 inches 1242.0 x 827.2 x 88.0 mm	57.3 x 38.5 x 15.8 inches 1455.0 x 914.8 x 82.8 mm
Weight	With stand	86.6 pounds / 39.3 kg	137.6 pounds / 62.4 kg
	Without stand	76.3 pounds / 34.6 kg	127.8 pounds / 58.0 kg
MODELS		50PG60 (50PG60F-UA)	60PG60 (60PG60F-UA)
Dimensions (Width x Height x Depth)	With stand	48.9 x 34.9 x 14.6 inches 1242.0 x 887.6 x 370.0 mm	57.3 x 38.8 x 16.3 inches 1455.0 x 985.0 x 414.0 mm
	Without stand	48.9 x 32.6 x 3.5 inches 1242.0 x 827.2 x 88.0 mm	57.3 x 38.5 x 15.8 inches 1455.0 x 914.8 x 82.8 mm
Weight	With stand	86.6 pounds / 39.3 kg	137.6 pounds / 62.4 kg
	Without stand	76.3 pounds / 34.6 kg	127.8 pounds / 58.0 kg
Power requirement Television System Program Coverage External Antenna Impedance		AC100-240V ~ 50/60Hz NTSC-M, ATSC, 64 & 256 QAM VHF 2-13, UHF 14-69, CATV 1-135, DTV 2-69, CADTV 1-135 75 ohm	
Environment condition	Operating Temperature Operating Humidity	32 ~ 104°F (0 ~ 40°C) Less than 80%	
	Storage Temperature Storage Humidity	-4 ~ 140°F (-20 ~ 60°C) Less than 85%	

■ The specifications shown above may be changed without prior notice for quality improvement.

APPENDIX

PROGRAMMING THE REMOTE CONTROL

The provided universal remote control can be programmed to operate most remote-controllable devices. Note that the remote may not control all models of other brands.

Programming a code into a remote mode

- 1** Testing your remote control.
To find out whether your remote control can operate other components without programming, turn on a component such as a STB and press the corresponding mode button (such as **STB**) on the remote control, while pointing at the component. Test the **POWER** and **CH** ^ ∨ buttons to see if the component responds correctly. If the component does not operate correctly, the remote control requires programming to operate the device.
- 2** Turn on the component to be programmed, then press the corresponding mode button (such as **STB**) on the remote control. The remote control button of the desired device is illuminated.
- 3** Press the **MENU** and **MUTE** buttons simultaneously, and the remote control is ready to be programmed with the code.
- 4** Enter a code number using the number buttons on the remote control. Programming code numbers for the corresponding component can be found on the following pages. If the code is correct, the device will turn off.
- 5** Press the **MENU** button to store the code.
- 6** Test the remote control functions to see if the component responds correctly. If not, repeat from step 2.

VCR

Brand	Codes	Brand	Codes	Brand	Codes
AIWA	034	MAGNAVOX	031 033 034 041	SAMSUNG	032 040 102 104
AKAI	016 043 046 124		067 068		105 107 109 112
		MARANTZ	012 031 033 067		113 115 120 122
AMPRO	072		069		125
ANAM	031 033 103	MARTA	101	SANSUI	022 043 048 135
AUDIO DYNAMICS	012 023 039 043	MATSUI	027 030	SANYO	003 007 010 014
BROKSONIC	035 037 129	MEI	031 033		102 134
CANON	028 031 033	MEMOREX	003 010 014 031	SCOTT	017 037 112 129
CAPEHART	108		033 034 053 072		131
CRAIG	003 040 135		101 102 134 139	SEARS	003 008 009 010
CURTIS MATHES	031 033 041	MGA	045 046 059		013 014 017 020
DAEWOO	005 007 010 064	MINOLTA	013 020		031 042 073 081
	065 108 110 111	MITSUBISHI	013 020 045 046		101
	112 116 117 119		049 051 059 061	SHARP	031 054 149
DAYTRON	108		151	SHINTOM	024
DBX	012 023 039 043	MTC	034 040	SONY	003 009 031 052
DYNATECH	034 053	MULTITECH	024 034		056 057 058 076
ELECTROHOME	059	NEC	012 023 039 043		077 078 149
EMERSON	006 017 025 027		048	SOUNDESIGN	034
	029 031 034 035	NORDMENDE	043	STS	013
	036 037 046 101	OPTONICA	053 054	SYLVANIA	031 033 034 059
	129 131 138 153	PANASONIC	066 070 074 083		067
FISHER	003 008 009 010		133 140 145	SYMPHONIC	034
FUNAI	034			TANDY	010 034
GE	031 033 063 072	PENTAX	013 020 031 033	TATUNG	039 043
	107 109 144 147		063	TEAC	034 039 043
GO VIDEO	132 136	PHILCO	031 034 067	TECHNICS	031 033 070
HARMAN KARDON	012 045	PHILIPS	031 033 034 054	TEKNIKA	019 031 033 034
HITACHI	004 018 026 034		067 071 101		101
	043 063 137 150	PILOT	101	THOMAS	034
INSTANTREPLAY	031 033	PIONEER	013 021 048	TMK	006
JCL	031 033	PORTLAND	108	TOSHIBA	008 013 042 047
JCPENNY	012 013 015 033	PULSAR	072		059 082 112 131
	040 066 101	QUARTZ	011 014	TOTEVISION	040 101
JENSEN	043	QUASAR	033 066 075 145	UNITECH	040
JVC	012 031 033 043	RCA	013 020 033 034	VECTOR RESEARCH	012
	048 050 055 060		040 041 062 063	VICTOR	048
	130 150 152		107 109 140 144	VIDEO CONCEPTS	012 034 046
KENWOOD	014 034 039 043		145 147	VIDEOSONIC	040
	047 048	REALISTIC	003 008 010 014	WARDS	003 013 017 024
LG (GOLDSTAR)	001 012 013 020		031 033 034 040		031 033 034 040
	101 106 114 123		053 054 101		053 054 131
LLOYD	034	RICO	058	YAMAHA	012 034 039 043
LXI	003 009 013 014	RUNCO	148	ZENITH	034 048 056
	017 034 101 106	SALORA	014		058 072 080 101
MAGIN	040				

APPENDIX

Remote Control Code

HDSTB

Brand	Codes	Brand	Codes	Brand	Codes
ALPHASTAR DSR	123	HOUSTON TRACKER	033 037 039 051	PROSAT	072
AMPLICA	050		057 104	RCA	066 106
BIRDVIEW	051 126 129	HUGHES	068	REALISTIC	043 074
CHANNEL MASTER	013 014 015 018	JANIEL	060 147	SAMSUNG	123
	036 055	JERROLD	061	SATELLITE SERVICE CO	028 035 047 057
CHAPARRAL	008 009 012 077	KATHREIN	108		085
CITOH	054	LEGEND	057	SCIENTIFIC ATLANTA	032 138
CURTIS MATHES	050 145	LG	001	SONY	103
DRAKE	005 006 007 010	LUTRON	132	STARCAST	041
	011 052 112 116	LUXOR	062 144	SUPER GUIDE	020 124 125
	141	MACOM	010 059 063 064	TEECOM	023 026 075 087
DX ANTENNA	024 046 056 076		065		088 090 107 130
ECHOSTAR	038 040 057 058	MEMOREX	057	TOSHIBA	002 127
	093 094 095 096	NEXTWAVE	028 124 125	UNIDEN	016 025 042 043
	097 098 099 100	NORSAT	069 070		044 045 048 049
	122	PACE SKY SATELLITE	143		078 079 080 086
ELECTRO HOME	089	PANASONIC	060 142		101 135 136
EUROPLUS	114	PANSAT	121	VIEWSTAR	115
FUJITSU	017 021 022 027	PERSONAL CABLE	117	WINEGARD	128 146
	133 134	PHILIPS	071	ZENITH	081 082 083 084
GENERAL INSTRUMENT	003 004 016 029	PICO	105		091 120
	031 059 101	PRESIDENT	019 102		
HITACHI	139 140	PRIMESTAR	030 110 111		

DVD

Brand	Codes	Brand	Codes	Brand	Codes
APEX DIGITAL	022	MITSUBISHI	002	RCA	005 006
DENON	020 014	NAD	023	SAMSUNG	011 015
GE	005 006	ONKYO	008 017	SONY	007
HARMAN KARDON	027	PANASONIC	003 009	THOMPSON	005 006
JVC	012	PHILIPS	013	TOSHIBA	019 008
LG	001 010 016 025	PIONEER	004 026	YAMAHA	009 018
MAGNAVOX	013	PROCEED	021	ZENITH	010 016 025
MARANTZ	024	PROSCAN	005 006		

IR CODES

1. How to Connect

- Connect your wired remote control to the Remote Control port on the TV.

2. Remote Control IR Codes

■ Output waveform

Single pulse, modulated with 37.917KHz signal at 455KHz

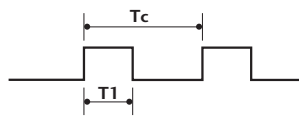

Carrier frequency
 $FCAR = 1/TC = fOSC/12$
 Duty ratio = $T1/TC = 1/3$

■ Configuration of frame

1st frame

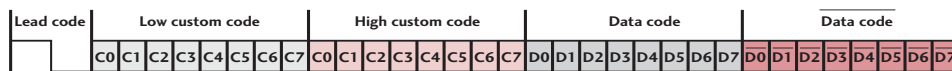

Repeat frame

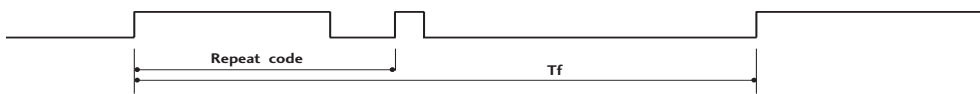

■ Lead code

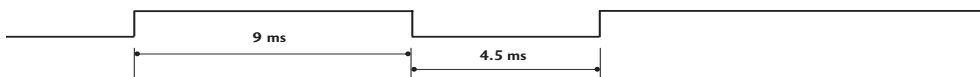

■ Repeat code

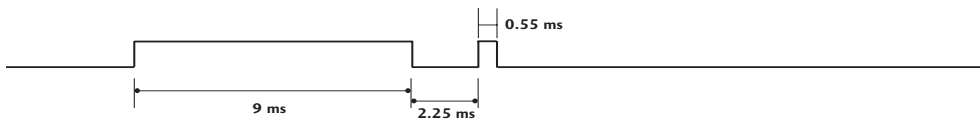

■ Bit description

Bit "0"

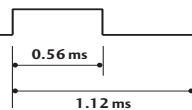

Bit "1"

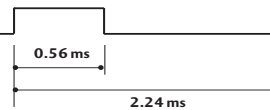

■ Frame interval: Tf

The waveform is transmitted as long as a key is depressed.



APPENDIX

Code (Hexa)	Function	Note
08	POWER	Remote control Button (Power On/Off)
45	Q.MENU	Remote control Button
43	MENU	Remote control Button
0B	INPUT	Remote control Button
10-19	Number Key 0-9	Remote control Button
4C	- (Dash)	Remote control Button
1A	FLASHBK	Remote control Button
09	MUTE	Remote control Button
02	VOL +	Remote control Button
03	VOL -	Remote control Button
00	CH ^	Remote control Button
01	CH v	Remote control Button
1E	FAV	Remote control Button
40	^	Remote control Button
41	v	Remote control Button
07	<	Remote control Button
06	>	Remote control Button
44	ENTER	Remote control Button
5B	RETURN	Remote control Button
7E	SIMPLINK	Remote control Button
30	AV MODE	Remote control Button
B0	PLAY	Remote control Button
BA	PAUSE	Remote control Button
B1	STOP	Remote control Button
BD	REC	Remote control Button
8F	REW	Remote control Button
8E	FF	Remote control Button

EXTERNAL CONTROL THROUGH RS-232C

The RS-232C port allows you connect the RS-232C input jack to an external control device (such as a computer or an A/V control system) to control the TV's functions externally.

- Note: RS-232C on this unit is intended to be used with third party RS-232C control hardware and software. The instructions below are provided to help with programming software or to test functionality using telenet software.

RS-232C Setup

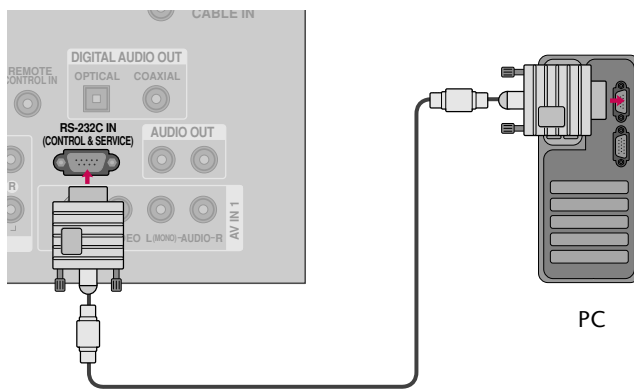

Type of Connector; D-Sub 9-Pin Male

No.	Pin Name
1	No connection
2	RXD (Receive data)
3	TXD (Transmit data)
4	DTR (DTE side ready)
5	GND
6	DSR (DCE side ready)
7	RTS (Ready to send)
8	CTS (Clear to send)
9	No Connection

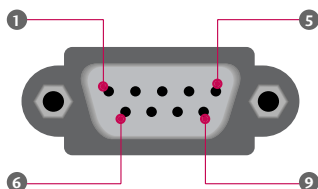

Communication Parameters

- Baud rate : 9600 bps (UART)
- Data length : 8 bits
- Parity : None
- Stop bit : 1 bit
- Communication code : ASCII code
- Use a crossed (reverse) cable.

NOTE

- ▶ This product has command echo back in the RS-232C Command.

APPENDIX

RS-232C Configurations

Either cable below can be used.

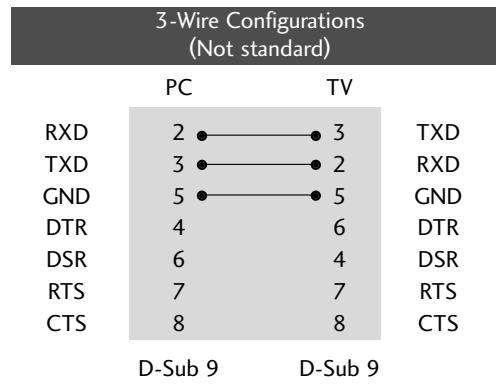
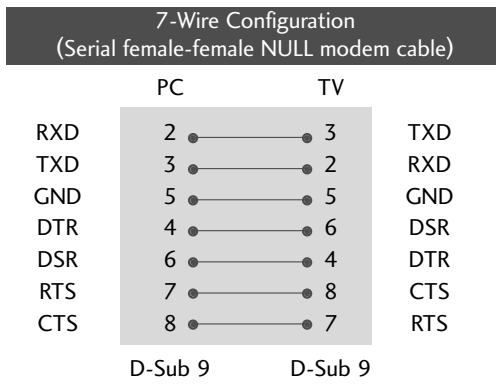







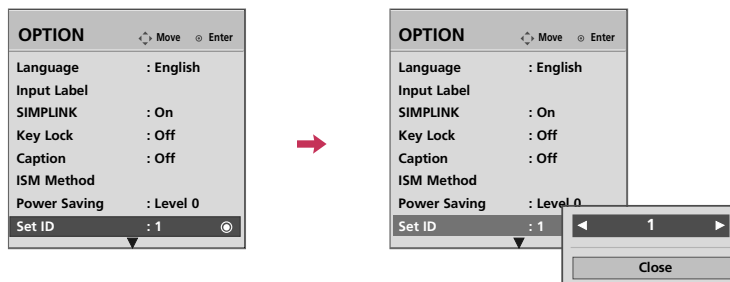

Set ID

Use this function to specify a TV ID number.

Refer to 'Real Data Mapping1'. ▶ p.133.



APPENDIX

- 1   Select **OPTION**.
- 2   Select **Set ID**.
- 3   Choose the desired TV ID number.
The adjustment range of Set ID is 1~99.
- 4  Return to the previous menu.
-  Return to TV viewing.

Command Reference List

	COMMAND1	COMMAND2	DATA (Hexadecimal)		COMMAND1	COMMAND2	DATA (Hexadecimal)
01. Power	k	a	00 ~ 01	15. Treble	k	r	00 ~ 64
02. Input Select	k	b	(▶ p.132)	16. Bass	k	s	00 ~ 64
03. Input Select	x	b	(▶ p.132)	17. Balance	k	t	00 ~ 64
04. Aspect Ratio	k	c	(▶ p.132)	18. Color Temperature	k	u	00 ~ 03
05. Screen Mute	k	d	00 ~ 01	19. ISM Method	j	p	(▶ p.134)
06. Volume Mute	k	e	00 ~ 01	20. Power Saving	j	q	00 ~ 01
07. Volume Control	k	f	00 ~ 64	21. Auto Configuration	j	u	(▶ p.134)
08. Contrast	k	g	00 ~ 64	23. Channel Add/Del	m	b	00 ~ 01
09. Brightness	k	h	00 ~ 64	24. Key	m	c	(▶ p.135)
10. Color	k	i	00 ~ 64	25. Backlight	m	g	00 ~ 64
11. Tint	k	j	00 ~ 64				
12. Sharpness	k	k	00 ~ 64				
13. OSD Select	k	l	00 ~ 01				
14. Remote Control Lock Mode	k	m	00 ~ 01				

Only Plasma TV Model

Only LCD TV Model

	COMMAND1	COMMAND2	DATA00 (Hexadecimal)	DATA01 (Hexadecimal)	DATA02 (Hexadecimal)	DATA03 (Hexadecimal)	DATA04 (Hexadecimal)	DATA05 (Hexadecimal)
22. Channel Tuning	m	a	physical program high	major program low	major low	minor high	minor low	attribute

Transmission / Receiving Protocol

Transmission

[Command1][Command2][][Set ID][][Data][Cr]

[Command 1] : First command to control the set.(j, k, m or x)
 [Command 2] : Second command to control the set.
 [Set ID] : You can adjust the set ID to choose desired TV ID number in Setup menu. Adjustment range is 1 ~ 99. When selecting Set ID '0', every connected the TV is controlled. Set ID is indicated as decimal (1 ~ 99) on menu and as Hexa decimal (0x0~0x63) on transmission /receiving protocol.
 [DATA] : To transmit the command data.
 Transmit the 'FF' data to read status of command.
 [Cr] : Carriage Return
 ASCII code '0x0D'
 [] : ASCII code 'space (0x20)'
 * In this model, TV will not send the status during the standby mode.

OK Acknowledgement

[Command2][][Set ID][][OK][Data][x]

The TV transmits ACK (acknowledgement) based on this format when receiving normal data. At this time, if the data is data read mode, it indicates present status data. If the data is data write mode, it returns the data of the PC computer.

* In this model, TV will not send the status during the standby mode.
 * Data Format
 [Command 2] : Use as command.
 [Set ID] : Use the small character, if set ID is 10, it will send the '0', 'a'.
 [DATA] : Use the small character, if data is 0 x ab, it will send the 'a', 'b'.
 [OK] : Use the large character.

Error Acknowledgement

[Command2][][Set ID][][NG][Data][x]

The TV transmits ACK (acknowledgement) based on this format when receiving abnormal data from non-viable functions or communication errors.
 Data1: Illegal Code
 Data2: Not supported function
 Data3: Wait more time
 * In this model, TV will not send the status during the standby mode.
 * Data Format
 [Command 2] : Use as command.
 [Set ID] : Use the small character, if set ID is 10, it will send the '0', 'a'.
 [DATA] : Use the small character, if data is 0 x ab, it will send the 'a', 'b'.
 [NG] : Use the large character

APPENDIX

01. Power (Command: k a)

To control Power On/Off of the TV.

Transmission [k][a][][Set ID][][Data][Cr]

Data 00: Power Off Data 01: Power On

Acknowledgement [a][][Set ID][][OK/NG][Data][x]

* In a like manner, if other functions transmit 'FF' data based on this format, Acknowledgement data feedback presents status about each function.

* Note: In this model, TV will send the Acknowledge after power on processing completion.

There might be a time delay between command and acknowledge.

02. Input Select (Command: k b)

To select input source for the TV.

Transmission [k][b][][Set ID][][Data][Cr]

Data 00: DTV Data 01: Analog

Data 02: AV1 Data 03: AV2

Data 04: Component 1 Data 05: Component 2

Data 07: RGB-PC Data 08: HDMI1

Data 09: HDMI2

Acknowledgement [b][][Set ID][][OK/NG][Data][x]

* You can select HDMI3 using "command x b".

* If you select input source, we recommend "command x b".

03. Input Select (Command: x b)

To select input source for TV.

Transmission [x][b][][Set ID][][Data][Cr]

Data 00: DTV (Antenna) Data 01: DTV (Cable)

Data 10: Analog (Antenna) Data 11: Analog (Cable)

Data 20: AV1 Data 21: AV2

Data 40: Component 1 Data 41: Component 2

Data 60: RGB-PC Data 90: HDMI1

Data 91: HDMI2 Data 92: HDMI3

Acknowledgement [b][][Set ID][][OK/NG][Data][x]

04. Aspect Ratio (Command: k c)

To adjust the screen format.

Transmission [k][c][][Set ID][][Data][Cr]

Data 01: 4:3 05: Zoom 2

02: 16:9 06: Set by program

04: Zoom 1 09: Just scan

⋮

Reserved

Acknowledgement [c][][Set ID][][OK/NG][Data][x]

05. Screen Mute (Command: k d)

To select screen mute on/off.

Transmission [k][d][][Set ID][][Data][Cr]

Data 00: Screen mute off (Picture on)

Data 01: Screen mute on (Picture off)

Acknowledgement [d][][Set ID][][OK/NG][Data][x]

06. Volume Mute (Command: k e)

To control volume mute on/off.

You can also adjust mute using the MUTE button on remote control.

Transmission [k][e][][Set ID][][Data][Cr]

Data 00: Volume mute on (Volume off)

Data 01: Volume mute off (Volume on)

Acknowledgement [e][][Set ID][][OK/NG][Data][x]

07. Volume Control (Command: k f)

To adjust volume.

You can also adjust volume with the volume buttons on remote control.

Transmission [k][f][][Set ID][][Data][Cr]

Data Min: 00 ~ Max: 64 (*transmit by Hexadecimal code)

*Refer to 'Real data mapping 1'. See page 133.

Acknowledgement [f][][Set ID][][OK/NG][Data][x]

08. Contrast (Command: k g)

To adjust screen contrast.

You can also adjust contrast in the PICTURE menu.

Transmission [k][g][][Set ID][][Data][Cr]

Data Min: 00 ~ Max: 64 (*transmit by Hexadecimal code)

*Refer to 'Real data mapping 1'. See page 133.

Acknowledgement [g][][Set ID][][OK/NG][Data][x]

09. Brightness (Command: k h)

To adjust screen brightness.

You can also adjust brightness in the PICTURE menu.

Transmission [k][h][][Set ID][][Data][Cr]

Data Min: 00 ~ Max: 64 (*transmit by Hexadecimal code)

*Refer to 'Real data mapping 1'. See page 133.

Acknowledgement [h][][Set ID][][OK/NG][Data][x]

10. Color (Command: k i)

To adjust screen color.

You can also adjust color in the PICTURE menu.

Transmission [k][i][][Set ID][][Data][Cr]

Data Min: 00 ~ Max: 64 (*transmit by Hexadecimal code)

*Refer to 'Real data mapping 1' as shown below.

Acknowledgement [i][][Set ID][][OK/NG][Data][x]

11. Tint (Command: k j)

To adjust screen tint.

You can also adjust tint in the PICTURE menu.

Transmission [k][j][][Set ID][][Data][Cr]

Data Red: 00 ~ Green: 64 (*transmit by Hexadecimal code)

*Refer to 'Real data mapping 1' as shown below.

Acknowledgement [j][][Set ID][][OK/NG][Data][x]

12. Sharpness (Command: k k)

To adjust screen sharpness.

You can also adjust sharpness in the PICTURE menu.

Transmission [k][k][][Set ID][][Data][Cr]

Data Min: 00 ~ Max: 64 (*transmit by Hexadecimal code)

*Refer to 'Real data mapping 1' as shown below.

Acknowledgement [k][][Set ID][][OK/NG][Data][x]

13. OSD Select (Command: k l)

To select OSD (On Screen Display) on/off.

Transmission [k][l][][Set ID][][Data][Cr]

Data 00: OSD off Data 01: OSD on

Acknowledgement [l][][Set ID][][OK/NG][Data][x]

14. Remote Control Lock Mode (Command: k m)

To lock the remote control and the front panel controls on the set.

Transmission [k][m][][Set ID][][Data][Cr]

Data 00: Lock off Data 01: Lock on

Acknowledgement [m][][Set ID][][OK/NG][Data][x]

If you're not using the remote control and front panel controls on the TV, use this mode. When main power is on/off, remote control lock is released.

15. Treble (Command: k r)

To adjust treble.

You can also adjust treble in the AUDIO menu.

Transmission [k][r][][Set ID][][Data][Cr]

Data Min: 00 ~ Max: 64 (*transmit by Hexadecimal code)

*Refer to 'Real data mapping 1' as shown.

Acknowledgement [r][][Set ID][][OK/NG][Data][x]

16. Bass (Command: k s)

To adjust bass.

You can also adjust bass in the AUDIO menu.

Transmission [k][s][][Set ID][][Data][Cr]

Data Min: 00 ~ Max: 64 (*transmit by Hexadecimal code)

*Refer to 'Real data mapping 1' as shown below.

Acknowledgement [s][][Set ID][][OK/NG][Data][x]

17. Balance (Command: k t)

To adjust balance.

You can also adjust balance in the AUDIO menu.

Transmission [k][t][][Set ID][][Data][Cr]

Data Min: 00 ~ Max: 64 (*transmit by Hexadecimal code)

*Refer to 'Real data mapping 1' as shown below.

Acknowledgement [t][][Set ID][][OK/NG][Data][x]

18. Color Temperature (Command: k u)

To adjust color temperature.

You can also adjust color temperature in the PICTURE menu.

Transmission [k][u][][Set ID][][Data][Cr]

Data 00: Medium 01: Cool 02: Warm ~~03: User~~

Acknowledgement [u][][Set ID][][OK/NG][Data][x]

*Real data mapping 1

- 0 : Step 0
- ⋮
- A : Step 10 (SET ID 10)
- ⋮
- F : Step 15 (SET ID 15)
- 10 : Step 16 (SET ID 16)
- ⋮
- 63 : Step 99 (SET ID 99)
- 64 : Step 100

*Real data mapping 2

- 0 : -20
- 5 : -19
- ⋮
- A : -18
- ⋮
- 5F : -1
- 64 : 0
- 69 : +1
- ⋮
- C3 : +19
- C8 : +20

APPENDIX

19. ISM Method (Command: j p)

(Only Plasma TV model)

To avoid having a fixed image remain on screen.

Transmission [j][p][][Set ID][][Data][Cr]

Data 01: Inversion 02: Orbiter
04: White Wash 08: Normal

Acknowledgement [p][][Set ID][][OK/NG][Data][x]

20. Power saving (Command: j q)

(Only Plasma TV model)

To control the low power function on/off.

Transmission [j][q][][Set ID][][Data][Cr]

Data 00: Low Power off
01: Low Power on

Acknowledgement [q][][Set ID][][OK/NG][Data][x]

21. Auto Configuration (Command: j u)

To adjust picture position and minimize image shaking automatically. Auto configuration only works in RGB-PC mode.

Transmission [j][u][][Set ID][][Data][Cr]

Data 1: To set

Acknowledgement [u][][Set ID][][OK/NG][Data][x]

22. Channel Tuning (Command: m a)

To tune channel to following physical/major/minor number.

Transmission [m][a][][Set ID][][Data00][][Data01][][Data02][][Data03][][Data04][][Data05][Cr]

Digital channels have a Physical, Major, and Minor channel number. The Physical number is the actual digital channel number, the Major is the number that the channel should be mapped to, and the Minor is the sub-channel. Since the ATSC tuner automatically maps the channel to the Major number, the Physical number is not required when sending a command.

Data 00: Physical Channel Number

NTSC air: 02~45, NTSC cable: 01, 0E~7D

ATSC air: 01~45, ATSC cable: 01~87

Data 01 & 02: Major Channel Number

Data 01: High byte Data 02: Low byte

Two bytes are available for the Major and Minor, normally only the second byte is used.

Data 03 & 04: Minor Channel Number

Not needed for NTSC.

Data5:

7	Main/Sub Picture	6	Two/One Part Channel	5	Using Physical Channel	4	Reserved	3	2	1	0	Step
0	Main	0	Two	0	Use	x		0	0	0	0	NTSC Air
1	Sub	1	One	1	No Use	x		0	0	0	1	NTSC Cable
						x		0	0	1	0	ATSC Air
						x		0	0	1	1	ATSC Cable_std
						x		0	1	0	0	ATSC Cable_hrc
						x		0	1	0	1	ATSC Cable_irc
						x		0	1	1	0	ATSC cable_auto
						x		0	1	1	1	Reserved
						x	x	x	x	x	x	...
						x	1	1	1	1	1	Reserved

The table above lists the binary code which must be converted to Hexadecimal before sending. For example: The binary code to tune the sub source to an NTSC cable channel is "1000 0001", which translates to "81" in Hex.

- * 7th bit : For which source do you want to change the channel.
- * 6th bit: Use a two part or one part channel. Most cases just use 0 since it's ignored when using NTSC.
- * 5th bit: Use 0 with NTSC since it can only use the physical channel number. Normally use 1 for ATSC since most times it doesn't matter what the physical number is.
- * 4th bit: Set to 0.
- * 3-0 bits: Choose signal type.

* Tune Command Examples:

1. Tune to the analog (NTSC) cable channel 35.

Data 00 = Physical of 35 = 23
 Data 01 & 02 = No Major = 00 00
 Data 03 & 04 = No Minor = 00 00
 Data 05 = 0000 0001 in binary = 01
 Total = ma 00 23 00 00 00 00 01

2. Tune to the digital (ATSC) local channel 30-3.

Data 00 = Don't know Physical = 00
 Data 01 & 02 = Major is 30 = 00 1E
 Data 03 & 04 = Minor is 3 = 00 03
 Data 05 = 0010 0010 in binary = 22
 Total = ma 00 00 00 1E 00 03 22

```
Acknowledgement[a][ ][Set ID][ ][OK][Data00][Data01][Data02][Data03][Data04][x][a][ ][Set ID][ ][NG][Data00][x]
```

23. Channel Add/Del (Command: m b)

To add and delete the channels

Transmission [m][b][][Set ID][][Data][Cr]

Data 00: Channel Delete Data 01: Channel Add

Acknowledgement [b][][Set ID][][OK/NG][Data][x]

24. Key (Command: m c)

To send IR remote key code.

Transmission [m][c][][Set ID][][Data][Cr]

Data Key code: Refer to page 128.

Acknowledgement [c][][Set ID][][OK/NG][Data][x]

25. Backlight (Command: m g)

(Only LCD TV model)

To adjust screen backlight.

Transmission [m][g][][Set ID][][Data][Cr]

Data Min:00 ~ Max:64 (*transmit by Hexadecimal code)

*Refer to 'Real data mapping 1': See page 133.

Acknowledgement [g][][Set ID][][OK/NG][Data][x]

APPENDIX

OPEN SOURCE LICENSE

GNU GENERAL PUBLIC LICENSE

Version 2, June 1991

Copyright (C) 1989, 1991 Free Software Foundation, Inc., 51 Franklin Street, Fifth Floor, Boston, MA 02110-1301 USA

Everyone is permitted to copy and distribute verbatim copies of this license document, but changing it is not allowed.

Preamble

The licenses for most software are designed to take away your freedom to share and change it. By contrast, the GNU General Public License is intended to guarantee your freedom to share and change free software - to make sure the software is free for all its users. This General Public License applies to most of the Free Software Foundation's software and to any other program whose authors commit to using it. (Some other free software foundation software is covered by the GNU Lesser General Public License instead.) You can apply it to your programs, too.

When we speak of free software, we are referring to freedom, not price. Our General Public Licenses are designed to make sure that you have the freedom to distribute copies of free software (and charge for this service if you wish), that you receive source code or can get it if you want it, that you can change the software or use pieces of it in new free programs; and that you know you can do these things.

To protect your rights, we need to make restrictions that forbid anyone to deny you these rights or to ask you to surrender the rights. These restrictions translate to certain responsibilities for you if you distribute copies of the software, or if you modify it.

For example, if you distribute copies of such a program, whether gratis or for a fee, you must give the recipients all the rights that you have. You must make sure that they, too, receive or can get the source code. And you must show them these terms so they know their rights.

We protect your rights with two steps: (1) copyright the software, and (2) offer you this license which gives you legal permission to copy, distribute and/or modify the software.

Also, for each author's protection and ours, we want to make certain that everyone understands that there is no warranty for this free software. If the software is modified by someone else and passed on, we want its recipients to know that what they have is not the original, so that any problems introduced by others will not reflect on the original authors' reputations.

Finally, any free program is threatened constantly by software patents. We wish to avoid the danger that redistributors of a free program will individually obtain patent licenses, in effect making

the program proprietary. To prevent this, we have made it clear that any patent must be licensed for everyone's free use or not licensed at all.

The precise terms and conditions for copying, distribution and modification follow.

GNU GENERAL PUBLIC LICENSE TERMS AND CONDITIONS FOR COPYING, DISTRIBUTION AND MODIFICATION

0. This license applies to any program or other work which contains a notice placed by the copyright holder saying it may be distributed under the terms of this General Public License. The "Program", below, refers to any such program or work, and a "work based on the Program" means either the Program or any derivative work under copyright law: that is to say, a work containing the Program or a portion of it, either verbatim or with modifications and/or translated into another language. (Hereinafter, translation is included without limitation in the term "modification".) Each licensee is addressed as "you".

Activities other than copying, distribution and modification are not covered by this license; they are outside its scope. The act of running the Program is not restricted, and the output from the program is covered only if its contents constitute a work based on the program (independent of having been made by running the program). Whether that is true depends on what the program does.

1. You may copy and distribute verbatim copies of the program's source code as you receive it, in any medium, provided that you conspicuously and appropriately publish on each copy an appropriate copyright notice and disclaimer of warranty; keep intact all the notices that refer to this license and to the absence of any warranty; and give any other recipients of the program a copy of this license along with the program.

You may charge a fee for the physical act of transferring a copy, and you may at your option offer warranty protection in exchange for a fee.

2. You may modify your copy or copies of the program or any portion of it, thus forming a work based on the Program, and copy and distribute such modifications or work under the terms of section 1 above, provided that you also meet all of these conditions:

a) You must cause the modified files to carry prominent notices stating that you changed the files and the date of any change.

- b) You must cause any work that you distribute or publish, that in whole or in part contains or is derived from the Program or any part thereof, to be licensed as a whole at no charge to all third parties under the terms of this license.
- c) If the modified program normally reads commands interactively when run, you must cause it, when started running for such interactive use in the most ordinary way, to print or display an announcement including an appropriate copyright notice and a notice that there is no warranty (or else, saying that you provide a warranty) and that users may redistribute the program under these conditions, and telling the user how to view a copy of this license. (Exception: if the Program itself is interactive but does not normally print such an announcement, your work based on the Program is not required to print an announcement.)

These requirements apply to the modified work as a whole. If identifiable sections of that work are not derived from the Program, and can be reasonably considered independent and separate works in themselves, then this license, and its terms, do not apply to those sections when you distribute them as separate works. But when you distribute the same sections as part of a whole which is a work based on the Program, the distribution of the whole must be on the terms of this license, whose permissions for other licensees extend to the entire whole, and thus to each and every part regardless of who wrote it.

Thus, it is not the intent of this section to claim rights or contest your rights to work written entirely by you; rather, the intent is to exercise the right to control the distribution of derivative or collective works based on the program.

In addition, mere aggregation of another work not based on the program with the Program (or with a work based on the program) on a volume of a storage or distribution medium does not bring the other work under the scope of this license.

- 3. You may copy and distribute the program (or a work based on it, under section 2) in object code or executable form under the terms of sections 1 and 2 above provided that you also do one of the following:
 - a) Accompany it with the complete corresponding machine-readable source code, which must be distributed under the terms of sections 1 and 2 above on a medium customarily used for software interchange; or,
 - b) Accompany it with a written offer, valid for at least three years, to give any third party, for a charge no more than your cost of physically performing source distribution, a complete machine-readable copy of the corresponding source code, to be distributed under the terms of sections 1 and 2 above on a medium customarily used for software interchange; or,

- c) Accompany it with the information you received as to the offer to distribute corresponding source code. (This alternative is allowed only for noncommercial distribution and only if you received the program in object code or executable form with such an offer, in accord with Subsection b above.)

The source code for a work means the preferred form of the work for making modifications to it. For an executable work, complete source code means all the source code for all modules it contains, plus any associated interface definition files, plus the scripts used to control compilation and installation of the executable. However, as a special exception, the source code distributed need not include anything that is normally distributed (in either source or binary form) with the major components (compiler, kernel, and so on) of the operating system on which the executable runs, unless that component itself accompanies the executable.

If distribution of executable or object code is made by offering access to copy from a designated place, then offering equivalent access to copy the source code from the same place counts as distribution of the source code, even though third parties are not compelled to copy the source along with the object code.

- 4. You may not copy, modify, sublicense, or distribute the Program except as expressly provided under this license. Any attempt otherwise to copy, modify, sublicense or distribute the Program is void, and will automatically terminate your rights under this license. However, parties who have received copies, or rights, from you under this license will not have their licenses terminated so long as such parties remain in full compliance.
- 5. You are not required to accept this license, since you have not signed it. However, nothing else grants you permission to modify or distribute the Program or its derivative works. These actions are prohibited by law if you do not accept this license. Therefore, by modifying or distributing the program (or any work based on the program), you indicate your acceptance of this license to do so, and all its terms and conditions for copying, distributing or modifying the program or works based on it.
- 6. Each time you redistribute the program (or any work based on the Program), the recipient automatically receives a license from the original licensor to copy, distribute or modify the Program subject to these terms and conditions. You may not impose any further restrictions on the recipients' exercise of the rights granted herein. You are not responsible for enforcing compliance by third parties to this license.



APPENDIX

7. If, as a consequence of a court judgment or allegation of patent infringement or for any other reason (not limited to patent issues), conditions are imposed on you (whether by court order, agreement or otherwise) that contradict the conditions of this license, they do not excuse you from the conditions of this license. If you cannot distribute so as to satisfy simultaneously your obligations under this license and any other pertinent obligations, then as a consequence you may not distribute the program at all. For example, if a patent license would not permit royalty-free redistribution of the program by all those who receive copies directly or indirectly through you, then the only way you could satisfy both it and this license would be to refrain entirely from distribution of the program.

If any portion of this section is held invalid or unenforceable under any particular circumstance, the balance of the section is intended to apply and the section as a whole is intended to apply in other circumstances.

It is not the purpose of this section to induce you to infringe any patents or other property right claims or to contest validity of any such claims; this section has the sole purpose of protecting the integrity of the free software distribution system, which is implemented by public license practices. Many people have made generous contributions to the wide range of software distributed through that system in reliance on consistent application of that system; it is up to the author/donor to decide if he or she is willing to distribute software through any other system and a licensee cannot impose that choice.

This section is intended to make thoroughly clear what is believed to be a consequence of the rest of this license.

8. If the distribution and/or use of the program is restricted in certain countries either by patents or by copyrighted interfaces, the original copyright holder who places the program under this license may add an explicit geographical distribution limitation excluding those countries, so that distribution is permitted only in or among countries not thus excluded. In such case, this license incorporates the limitation as if written in the body of this license.
9. The Free Software Foundation may publish revised and/or new versions of the General Public License from time to time. Such new versions will be similar in spirit to the present version, but may differ in detail to address new problems or concerns.

Each version is given a distinguishing version number. If the program specifies a version number of this license which applies to it and "any later version", you have the option of following the terms and conditions either of that version or of

any later version published by the Free Software Foundation. If the program does not specify a version number of this license, you may choose any version ever published by the Free Software Foundation.

10. If you wish to incorporate parts of the program into other free programs whose distribution conditions are different, write to the author to ask for permission. For software which is copyrighted by the Free Software Foundation, write to the Free Software Foundation; we sometimes make exceptions for this. Our decision will be guided by the two goals of preserving the free status of all derivatives of our free software and of promoting the sharing and reuse of software generally.

NO WARRANTY

11. BECAUSE THE PROGRAM IS LICENSED FREE OF CHARGE, THERE IS NO WARRANTY FOR THE PROGRAM, TO THE EXTENT PERMITTED BY APPLICABLE LAW. EXCEPT WHEN OTHERWISE STATED IN WRITING THE COPYRIGHT HOLDERS AND/OR OTHER PARTIES PROVIDE THE PROGRAM "AS IS" WITHOUT WARRANTY OF ANY KIND, EITHER EXPRESSED OR IMPLIED, INCLUDING, BUT NOT LIMITED TO, THE IMPLIED WARRANTIES OF MERCHANTABILITY AND FITNESS FOR A PARTICULAR PURPOSE. THE ENTIRE RISK AS TO THE QUALITY AND PERFORMANCE OF THE PROGRAM IS WITH YOU. SHOULD THE PROGRAM PROVE DEFECTIVE, YOU ASSUME THE COST OF ALL NECESSARY SERVICING, REPAIR OR CORRECTION.

12. IN NO EVENT UNLESS REQUIRED BY APPLICABLE LAW OR AGREED TO IN WRITING WILL ANY COPYRIGHT HOLDER, OR ANY OTHER PARTY WHO MAY MODIFY AND/OR REDISTRIBUTE THE PROGRAM AS PERMITTED ABOVE, BE LIABLE TO YOU FOR DAMAGES, INCLUDING ANY GENERAL, SPECIAL, INCIDENTAL OR CONSEQUENTIAL DAMAGES ARISING OUT OF THE USE OR INABILITY TO USE THE PROGRAM (INCLUDING BUT NOT LIMITED TO LOSS OF DATA OR DATA BEING RENDERED INACCURATE OR LOSSES SUSTAINED BY YOU OR THIRD PARTIES OR A FAILURE OF THE PROGRAM TO OPERATE WITH ANY OTHER PROGRAMS), EVEN IF SUCH HOLDER OR OTHER PARTY HAS BEEN ADVISED OF THE POSSIBILITY OF SUCH DAMAGES.

END OF TERMS AND CONDITIONS

How to apply these terms to your new programs

If you develop a new program, and you want it to be of the greatest possible use to the public, the best way to achieve this is to make it free software which everyone can redistribute and change under these terms.

To do so, attach the following notices to the program. It is safest to attach them to the start of each source file to most effectively convey the exclusion of warranty; and each file should have at least the "copyright" line and a pointer to where the full notice is found.

one line to give the program's name and a brief idea of what it does.

Copyright (C) <year> <name of author>

This program is free software; you can redistribute it and/or modify it under the terms of the GNU General Public License as published by the Free Software Foundation; either version 2 of the license, or (at your option) any later version.

This program is distributed in the hope that it will be useful, but WITHOUT ANY WARRANTY; without even the implied warranty of MERCHANTABILITY or FITNESS FOR A PARTICULAR PURPOSE. See the GNU General Public License for more details.

You should have received a copy of the GNU General Public License along with this program; if not, write to the Free Software Foundation, Inc., 51 Franklin Street, Fifth Floor, Boston, MA 02110-1301 USA.

Also add information on how to contact you by electronic and paper mail.

If the program is interactive, make it output a short notice like this when it starts in an interactive mode:

Gnomovision version 69, Copyright (C) year name of author
Gnomovision comes with ABSOLUTELY NO WARRANTY; for details type 'show w'. This is free software, and you are welcome to redistribute it under certain conditions; type 'show c' for details.

The hypothetical commands 'show w' and 'show c' should show the appropriate parts of the General Public License. Of course, the commands you use may be called something other than 'show w' and 'show c'; they could even be mouse-clicks or menu items-whatever suits your program.

You should also get your employer (if you work as a programmer) or your school, if any, to sign a "copyright disclaimer" for the program, if necessary. Here is a sample; alter the names:

Yoyodyne, Inc., hereby disclaims all copyright interest in the program 'Gnomovision' (which makes passes at compilers) written by James Hacker.

signature of Ty Coon, 1 April 1989
Ty Coon, President of Vice

This General Public License does not permit incorporating your program into proprietary programs. If your program is a subroutine library, you may consider it more useful to permit linking proprietary applications with the library. If this is what you want to do, use the GNU Lesser General Public License instead of this license.

APPENDIX

GNU LESSER GENERAL PUBLIC LICENSE

Version 2.1, February 1999

Copyright (C) 1991, 1999 Free Software Foundation, Inc. 51 Franklin Street, Fifth Floor, Boston, MA 02110-1301 USA
Everyone is permitted to copy and distribute verbatim copies of this license document, but changing it is not allowed.

[This is the first released version of the Lesser GPL. It also counts as the successor of the GNU Library Public License, version 2, hence the version number 2.1.]

Preamble

The licenses for most software are designed to take away your freedom to share and change it. By contrast, the GNU General Public Licenses are intended to guarantee your freedom to share and change free software - to make sure the software is free for all its users.

This license, the Lesser General Public License, applies to some specially designated software packages - typically libraries - of the Free Software Foundation and other authors who decide to use it. You can use it too, but we suggest you first think carefully about whether this license or the ordinary General Public License is the better strategy to use in any particular case, based on the explanations below.

When we speak of free software, we are referring to freedom of use, not price. Our General Public Licenses are designed to make sure that you have the freedom to distribute copies of free software (and charge for this service if you wish); that you receive source code or can get it if you want it; that you can change the software and use pieces of it in new free programs; and that you are informed that you can do these things.

To protect your rights, we need to make restrictions that forbid distributors to deny you these rights or to ask you to surrender these rights. These restrictions translate to certain responsibilities for you if you distribute copies of the library or if you modify it.

For example, if you distribute copies of the library, whether gratis or for a fee, you must give the recipients all the rights that we gave you. You must make sure that they, too, receive or can get the source code. If you link other code with the library, you must provide complete object files to the recipients, so that they can relink them with the library after making changes to the library and recompiling it. And you must show them these terms so they know their rights.

We protect your rights with a two-step method: (1) we copyright the library, and (2) we offer you this license, which gives you legal permission to copy, distribute and/or modify the library.

To protect each distributor, we want to make it very clear that there is no warranty for the free library. Also, if the library is modified by someone else and passed on, the recipients should know that what they have is not the original version, so that the original author's reputation will not be affected by problems that might be introduced by others.

Finally, software patents pose a constant threat to the existence of any free program. We wish to make sure that a company cannot effectively restrict the users of a free program by obtaining a restrictive license from a patent holder. Therefore, we insist that any patent license obtained for a version of the library must be consistent with the full freedom of use specified in this license.

Most GNU software, including some libraries, is covered by the ordinary GNU General Public License. This license, the GNU Lesser General Public License, applies to certain designated libraries, and is quite different from the ordinary General Public License. We use this license for certain libraries in order to permit linking those libraries into non-free programs.

When a program is linked with a library, whether statically or using a shared library, the combination of the two is legally speaking a combined work, a derivative of the original library. The ordinary General Public License therefore permits such linking only if the entire combination fits its criteria of freedom. The Lesser General Public License permits more lax criteria for linking other code with the library.

We call this license the "Lesser" General Public License because it does less to protect the user's freedom than the ordinary General Public License. It also provides other free software developers less of an advantage over competing non-free programs. These disadvantages are the reason we use the ordinary General Public License for many libraries. However, the Lesser license provides advantages in certain special circumstances.

For example, on rare occasions, there may be a special need to encourage the widest possible use of a certain library, so that it becomes a de-facto standard. To achieve this, non-free programs must be allowed to use the library. A more frequent case is that a free library does the same job as widely used non-free libraries. In this case, there is little to gain by limiting the free library to free software only, so we use the Lesser General Public License.

In other cases, permission to use a particular library in non-free programs enables a greater number of people to use a large body of free software. For example, permission to use the GNU C Library in non-free programs enables many more people to use the whole GNU operating system, as well as its variant, the GNU/Linux operating system.

Although the Lesser General Public License is less protective of the users' freedom, it does ensure that the user of a program that is linked with the Library has the freedom and the wherewithal to run that program using a modified version of the Library.

The precise terms and conditions for copying, distribution and modification follow. Pay close attention to the difference between a "work based on the library" and a "work that uses the library". The former contains code derived from the library, whereas the latter must be combined with the library in order to run.

GNU LESSER GENERAL PUBLIC LICENSE TERMS AND CONDITIONS FOR COPYING, DISTRIBUTION AND MODIFICATION

0. This license agreement applies to any software library or other program which contains a notice placed by the copyright holder or other authorized party saying it may be distributed under the terms of this Lesser General Public License (also called "this license"). Each license is addressed as "you".

A "library" means a collection of software functions and/or data prepared so as to be conveniently linked with application programs (which use some of those functions and data) to form executables.

The "Library", below, refers to any such software library or work which has been distributed under these terms. A "work based on the Library" means either the Library or any derivative work under copyright law: that is to say, a work containing the library or a portion of it, either verbatim or with modifications and/or translated straightforwardly into another language. (Hereinafter, translation is included without limitation in the term "modification".)

"Source code" for a work means the preferred form of the work for making modifications to it. For a library, complete source code means all the source code for all modules it contains, plus any associated interface definition files, plus the scripts used to control compilation and installation of the library.

Activities other than copying, distribution and modification are not covered by this license; they are outside its scope. The act of running a program using the Library is not restricted, and output from such a program is covered only if its contents constitute a work based on the library (independent of the use of the Library in a tool for writing it). Whether that is true depends on what the library does and what the program that uses the library does.

1. You may copy and distribute verbatim copies of the library's complete source code as you receive it, in any medium, provided that you conspicuously and appropriately publish on

each copy an appropriate copyright notice and disclaimer of warranty; keep intact all the notices that refer to this license and to the absence of any warranty; and distribute a copy of this license along with the Library.

You may charge a fee for the physical act of transferring a copy, and you may at your option offer warranty protection in exchange for a fee.

2. You may modify your copy or copies of the Library or any portion of it, thus forming a work based on the Library, and copy and distribute such modifications or work under the terms of section 1 above, provided that you also meet all of these conditions:
 - a) The modified work must itself be a software library.
 - b) You must cause the files modified to carry prominent notices stating that you changed the files and the date of any change.
 - c) You must cause the whole of the work to be licensed at no charge to all third parties under the terms of this license.
 - d) If a facility in the modified Library refers to a function or a table of data to be supplied by an application program that uses the facility, other than as an argument passed when the facility is invoked, then you must make a good faith effort to ensure that, in the event an application does not supply such function or table, the facility still operates, and performs whatever part of its purpose remains meaningful.

(For example, a function in a library to compute square roots has a purpose that is entirely well-defined independent of the application. Therefore, Subsection 2d requires that any application-supplied function or table used by this function must be optional: if the application does not supply it, the square root function must still compute square roots.)

These requirements apply to the modified work as a whole. If identifiable sections of that work are not derived from the library, and can be reasonably considered independent and separate works in themselves, then this license, and its terms, do not apply to those sections when you distribute them as separate works. But when you distribute the same sections as part of a whole which is a work based on the library, the distribution of the whole must be on the terms of this license, whose permissions for other licenses extend to the entire whole, and thus to each and every part regardless of who wrote it.

Thus, it is not the intent of this section to claim rights or contest your rights to work written entirely by you; rather, the intent is to exercise the right to control the distribution of derivative or collective works based on the library.

In addition, mere aggregation of another work not based on the library with the library (or with a work based on the library) on a volume of a storage or distribution medium does not bring the other work under the scope of this license.

APPENDIX

3. You may opt to apply the terms of the ordinary GNU General Public License instead of this License to a given copy of the Library. To do this, you must alter all the notices that refer to this License, so that they refer to the ordinary GNU General Public License, version 2, instead of to this License. (If a newer version than version 2 of the ordinary GNU General Public License has appeared, then you can specify that version instead if you wish.) Do not make any other change in these notices.

Once this change is made in a given copy, it is irreversible for that copy, so the ordinary GNU General Public License applies to all subsequent copies and derivative works made from that copy.

This option is useful when you wish to copy part of the code of the library into a program that is not a library.

4. You may copy and distribute the library (or a portion or derivative of it, under Section 2) in object code or executable form under the terms of Sections 1 and 2 above provided that you accompany it with the complete corresponding machine-readable source code, which must be distributed under the terms of sections 1 and 2 above on a medium customarily used for software interchange.

If distribution of object code is made by offering access to copy from a designated place, then offering equivalent access to copy the source code from the same place satisfies the requirement to distribute the source code, even though third parties are not compelled to copy the source along with the object code.

5. A program that contains no derivative of any portion of the Library, but is designed to work with the Library by being compiled or linked with it, is called a “work that uses the Library”. Such a work, in isolation, is not a derivative work of the Library, and therefore falls outside the scope of this license.

However, linking a “work that uses the library” with the Library creates an executable that is a derivative of the Library (because it contains portions of the library), rather than a “work that uses the library”. The executable is therefore covered by this license. Section 6 states terms for distribution of such executable.

When a “work that uses the library” uses material from a header file that is part of the library, the object code for the work may be a derivative work of the library even though the source code is not.

Whether this is true is especially significant if the work can be linked without the library, or if the work is itself a library. The threshold for this to be true is not precisely defined by law.

If such an object file uses only numerical parameters, data structure layouts and accessories, and small macros and small inline functions (ten lines or less in length), then the use of

the object file is unrestricted, regardless of whether it is legally a derivative work. (Executable containing this object code plus portions of the library will still fall under Section 6.)

Otherwise, if the work is a derivative of the library, you may distribute the object code for the work under the terms of Section 6. Any executable containing that work also fall under Section 6, whether or not they are linked directly with the library itself.

6. As an exception to the sections above, you may also combine or link a “work that uses the library” with the library to produce a work containing portions of the library, and distribute that work under terms of your choice, provided that the terms permit modification of the work for the customer’s own use and reverse engineering for debugging such modifications.

You must give prominent notice with each copy of the work that the library is used in it and that the Library and its use are covered by this license. You must supply a copy of this license. If the work during execution displays copyright notices, you must include the copyright notice for the library among them, as well as a reference directing the user to the copy of this license. Also, you must do one of these things:

- a) Accompany the work with the complete corresponding machine-readable source code for the library including whatever changes were used in the work (which must be distributed under Sections 1 and 2 above); and, if the work is an executable linked with the Library, with the complete machine-readable “work that uses the Library”, as object code and/or source code, so that the user can modify the library and then relink to produce a modified executable containing the modified library. (It is understood that the user who changes the contents of definitions files in the library will not necessarily be able to recompile the application to use the modified definitions.)
- b) Use a suitable shared library mechanism for linking with the library. A suitable mechanism is one that (1) uses at run time a copy of the library already present on the user’s computer system, rather than copying library functions into the executable, and (2) will operate properly with a modified version of the library, if the user installs one, as long as the modified version is interface-compatible with the version that the work was made with.
- c) Accompany the work with a written offer, valid for at least three years, to give the same user the materials specified in Subsection 6, above, for a charge no more than the cost of performing this distribution.
- d) If distribution of the work is made by offering access to copy from a designated place, offer equivalent access to copy the above specified materials from the same place.
- e) Verify that the user has already received a copy of these materials or that you have already sent this user a copy.

For an executable, the required form of the “work that uses the library” must include any data and utility programs needed for reproducing the executable from it. However, as a special exception, the materials to be distributed need not include anything that is normally distributed (in either source or binary form) with the major components (compiler, kernel, and so on) of the operating system on which the executable runs, unless that component itself accompanies the executable.

It may happen that this requirement contradicts the license restrictions of other proprietary libraries that do not normally accompany the operating system. Such a contradiction means you cannot use both them and the library together in an executable that you distribute.

7. You may place library facilities that are a work based on the library side-by-side in a single library together with other library facilities not covered by this license, and distribute such a combined library, provided that the separate distribution of the work based on the Library and of the other library facilities is otherwise permitted, and provided that you do these two things:
 - a) Accompany the combined library with a copy of the same work based on the Library, uncombined with any other library facilities. This must be distributed under the terms of the sections above.
 - b) Give prominent notice with the combined library of the fact that part of it is a work based on the library, and explaining where to find the accompanying uncombined form of the same work.
8. You may not copy, modify, sublicense, link with, or distribute the library except as expressly provided under this license. Any attempt otherwise to copy, modify, sublicense, link with, or distribute the library is void, and will automatically terminate your rights under this license. However, parties who have received copies, or rights, from you under this license will not have their licenses terminated so long as such parties remain in full compliance.
9. You are not required to accept this license, since you have not signed it. However, nothing else grants you permission to modify or distribute the library or its derivative works. These actions are prohibited by law if you do not accept this license. Therefore, by modifying or distributing the library (or any work based on the library), you indicate your acceptance of this license to do so, and all its terms and conditions for copying, distributing or modifying the library or works based on it.
10. Each time you redistribute the library (or any work based on the Library), the recipient automatically receives a license from the original licensor to copy, distribute, link with or modify the library subject to these terms and conditions. You may not impose any further restrictions on the recipients’ exercise

of the rights granted herein.

You are not responsible for enforcing compliance by third parties with this license.

11. If, as a consequence of a court judgment or allegation of patent infringement or for any other reason (not limited to patent issues), conditions are imposed on you (whether by court order, agreement or otherwise) that contradict the conditions of this license, they do not excuse you from the conditions of this license. If you cannot distribute so as to satisfy simultaneously your obligations under this license and any other pertinent obligations, then as a consequence you may not distribute the library at all. For example, if a patent license would not permit royalty-free redistribution of the library by all those who receive copies directly or indirectly through you, then the only way you could satisfy both it and this license would be to refrain entirely from distribution of the library.

If any portion of this section is held invalid or unenforceable under any particular circumstance, the balance of the section is intended to apply, and the section as a whole is intended to apply in other circumstances.

It is not the purpose of this section to induce you to infringe any patents or other property right claims or to contest validity of any such claims; this section has the sole purpose of protecting the integrity of the free software distribution system which is implemented by public license practices. Many people have made generous contributions to the wide range of software distributed through that system in reliance on consistent application of that system; it is up to the author/donor to decide if he or she is willing to distribute software through any other system and a license cannot impose that choice.

This section is intended to make thoroughly clear what is believed to be a consequence of the rest of this license.

12. If the distribution and/or use of the library is restricted in certain countries either by patents or by copyrighted interfaces, the original copyright holder who places the library under this license may add an explicit geographical distribution limitation excluding those countries, so that distribution is permitted only in or among countries not thus excluded. In such case, this license incorporates the limitation as if written in the body of this license.
13. The Free Software Foundation may publish revised and/or new versions of the Lesser General Public License from time to time. Such new versions will be similar in spirit to the present version, but may differ in detail to address new problems or concerns. Each version is given a distinguishing version number. If the library specifies a version number of this license which applies to it and “any later version”, you have the option of following the terms and conditions either of that version or of any later version published by the Free Software Foundation.

APPENDIX

If the library does not specify a license version number, you may choose any version ever published by the Free Software Foundation.

14. If you wish to incorporate parts of the library into other free programs whose distribution conditions are incompatible with these, write to the author to ask for permission. For software which is copyrighted by the Free Software Foundation, write to the Free Software Foundation; we sometimes make exceptions for this. Our decision will be guided by the two goals of preserving the free status of all derivatives of our free software and of promoting the sharing and reuse of software generally.

NO WARRANTY

15. BECAUSE THE LIBRARY IS LICENSED FREE OF CHARGE, THERE IS NO WARRANTY FOR THE LIBRARY, TO THE EXTENT PERMITTED BY APPLICABLE LAW. EXCEPT WHEN OTHERWISE STATED IN WRITING THE COPYRIGHT HOLDERS AND/OR OTHER PARTIES PROVIDE THE LIBRARY "AS IS" WITHOUT WARRANTY OF ANY KIND, EITHER EXPRESSED OR IMPLIED, INCLUDING, BUT NOT LIMITED TO, THE IMPLIED WARRANTIES OF MERCHANTABILITY AND FITNESS FOR A PARTICULAR PURPOSE. THE ENTIRE RISK AS TO THE QUALITY AND PERFORMANCE OF THE LIBRARY IS WITH YOU. SHOULD THE LIBRARY PROVE DEFECTIVE, YOU ASSUME THE COST OF ALL NECESSARY SERVICING, REPAIR OR CORRECTION.

16. IN NO EVENT UNLESS REQUIRED BY APPLICABLE LAW OR AGREED TO IN WRITING WILL ANY COPYRIGHT HOLDER, OR ANY OTHER PARTY WHO MAY MODIFY AND/OR REDISTRIBUTE THE LIBRARY AS PERMITTED ABOVE, BE LIABLE TO YOU FOR DAMAGES, INCLUDING ANY GENERAL, SPECIAL, INCIDENTAL OR CONSEQUENTIAL DAMAGES ARISING OUT OF THE USE OR INABILITY TO USE THE LIBRARY (INCLUDING BUT NOT LIMITED TO LOSS OF DATA OR DATA BEING RENDERED INACCURATE OR LOSSES SUSTAINED BY YOU OR THIRD PARTIES OR A FAILURE OF THE LIBRARY TO OPERATE WITH ANY OTHER SOFTWARE), EVEN IF SUCH HOLDER OR OTHER PARTY HAS BEEN ADVISED OF THE POSSIBILITY OF SUCH DAMAGES.

END OF TERMS AND CONDITIONS

How to apply these terms to your new libraries

If you develop a new library, and you want it to be of the greatest possible use to the public, we recommend making it free software that everyone can redistribute and change. You can do so by permitting redistribution under these terms (or, alternatively, under the terms of the ordinary General Public License).

To apply these terms, attach the following notices to the library. It is safest to attach them to the start of each source file to most effectively convey the exclusion of warranty; and each file should have at least the "copyright" line and a pointer to where the full notice is found.

one line to give the library's name and a brief idea of what it does.
Copyright (C) <year> <name of author>

This library is free software; you can redistribute it and/or modify it under the terms of the GNU Lesser General Public License as published by the Free Software Foundation; either version 2.1 of the license, or (at your option) any later version.

This library is distributed in the hope that it will be useful, but WITHOUT ANY WARRANTY; without even the implied warranty of MERCHANTABILITY or FITNESS FOR A PARTICULAR PURPOSE. See the GNU Lesser General Public License for more details.

You should have received a copy of the GNU Lesser General Public License along with this library; if not, write to the Free Software Foundation, Inc., 51 Franklin Street, Fifth Floor, Boston, MA 02110-1301 USA

Also add information on how to contact you by electronic and paper mail.

You should also get your employer (if you work as a programmer) or your school, if any, to sign a "copyright disclaimer" for the library, if necessary. Here is a sample; alter the names:

Yoyodyne, Inc., hereby disclaims all copyright interest in the library 'Frob' (a library for tweaking knobs) written by James Random Hacker.

signature of Ty Coon, 1 April 1990
Ty Coon, President of Vice

MOZILLA PUBLIC LICENSE

Version 1.1

1. Definitions.

- 1.0.1. "Commercial use" means distribution or otherwise making the covered code available to a third party.
- 1.1. "Contributor" means each entity that creates or contributes to the creation of modifications.
- 1.2. "Contributor version" means the combination of the original code, prior modifications used by a contributor, and the modifications made by that particular contributor.
- 1.3. "Covered code" means the original code or modifications or the combination of the original code and modifications, in each case including portions thereof.
- 1.4. "Electronic distribution mechanism" means a mechanism generally accepted in the software development community for the electronic transfer of data.
- 1.5. "Executable" means covered code in any form other than source code.
- 1.6. "Initial developer" means the individual or entity identified as the initial Developer in the Source Code notice required by exhibit A.
- 1.7. "Larger work" means a work which combines covered code or portions thereof with code not governed by the terms of this License.
- 1.8. "License" means this document.
- 1.8.1. "Licensable" means having the right to grant, to the maximum extent possible, whether at the time of the initial grant or subsequently acquired, any and all of the rights conveyed herein.
- 1.9. "Modifications" means any addition to or deletion from the substance or structure of either the original code or any previous modifications. When covered code is released as a series of files, a modification is:
 - A. Any addition to or deletion from the contents of a file containing original code or previous modifications.
 - B. Any new file that contains any part of the original code or previous modifications.
- 1.10. "Original code" means source code of computer software

code which is described in the source code notice required by exhibit as original code, and which, at the time of its release under this license is not already covered code governed by this license.

- 1.10.1. "Patent claims" means any patent claim(s), now owned or hereafter acquired, including without limitation, method, process, and apparatus claims, in any patent licensable by grantor.
- 1.11. "Source code" means the preferred form of the covered code for making modifications to it, including all modules it contains, plus any associated interface definition files, scripts used to control compilation and installation of an executable, or source code differential comparisons against either the original code or another well known, available covered code of the contributor's choice. The source code can be in a compressed or archival form, provided the appropriate decompression or de-archiving software is widely available for no charge.
- 1.12. "You" (or "Your") means an individual or a legal entity exercising rights under, and complying with all of the terms of, this license or a future version of this license issued under section 6.1.
For legal entities, "You" includes any entity which controls, is controlled by, or is under common control with You. For purposes of this definition, "control" means (a) the power, direct or indirect, to cause the direction or management of such entity, whether by contract or otherwise, or (b) ownership of more than fifty percent (50%) of the outstanding shares or beneficial ownership of such entity.

2. Source Code License.

- 2.1. The initial developer grant.
The initial developer hereby grants You a world-wide, royalty-free, non-exclusive license, subject to third party intellectual property claims:
 - a) under intellectual property rights (other than patent or trademark) licensable by initial developer to use, reproduce, modify, display, perform, sublicense and distribute the original code (or portions thereof) with or without modifications, and/or as part of a larger work; and
 - (b) under patents claims infringed by the making, using or selling of original code, to make, have made, use, practice, sell, and offer for sale, and/or otherwise dispose of the original code (or portions thereof).



APPENDIX

- (c) the licenses granted in this section 2.1 (a) and (b) are effective on the date Initial developer first distributes original code under the terms of this license.
 - (d) Notwithstanding section 2.1 (b) above, no patent license is granted: 1) for code that You delete from the original Code; 2) separate from the original code; or 3) for infringements caused by: i) the modification of the original code or ii) the combination of the original code with other software or devices.
- 2.2. Contributor Grant.
- Subject to third party intellectual property claims, each contributor hereby grants You a world-wide, royalty-free, non-exclusive license
- (a) under intellectual property rights (other than patent or trademark) licensable by contributor, to use, reproduce, modify, display, perform, sublicense and distribute the modifications created by such contributor (or portions thereof) either on an unmodified basis, with other modifications, as covered code and/or as part of a larger work; and
 - (b) under patent claims infringed by the making, using, or selling of modifications made by that contributor either alone and/or in combination with its contributor version (or portions of such combination), to make, use, sell, offer for sale, have made, and/or otherwise dispose of: 1) modifications made by that contributor (or portions thereof); and 2) the combination of modifications made by that contributor with its contributor version (or portions of such combination).
 - (c) the licenses granted in sections 2.2(a) and 2.2(b) are effective on the date contributor first makes commercial use of the covered code.
 - (d) Notwithstanding section 2.2(b) above, no patent license is granted: 1) for any code that contributor has deleted from the contributor version; 2) separate from the contributor version; 3) for infringements caused by: i) third party modifications of contributor version or ii) the combination of modifications made by that contributor with other software (except as part of the contributor version) or other devices; or 4) under patent claims infringed by covered code in the absence of modifications made by that contributor.

3. Distribution Obligations.

3.1. Application of license.

The modifications which You create or to which you contribute are governed by the terms of this license, including without limitation section 2.2. The source code version of covered code may be distributed only under the terms of this license or a future version of this license released under section 6.1, and you must include a copy of this license with every copy of the source code you distribute.

You may not offer or impose any terms on any source code version that alters or restricts the applicable version of this license or the recipients' rights hereunder. However, you may include an additional document offering the additional rights described in section 3.5.

3.2. Availability of source code.

Any modification which you create or to which you contribute must be made available in source code form under the terms of this license either on the same media as an executable version or via an accepted electronic distribution mechanism to anyone to whom you made an executable version available; and if made available via electronic distribution mechanism, must remain available for at least twelve (12) months after the date it initially became available, or at least six (6) months after a subsequent version of that particular modification has been made available to such recipients. You are responsible for ensuring that the source code version remains available even if the electronic distribution mechanism is maintained by a third party.

3.3. Description of modifications.

You must cause all covered code to which you contribute to contain a file documenting the changes You made to create that covered code and the date of any change. You must include a prominent statement that the modification is derived, directly or indirectly, from original code provided by the initial developer and including the name of the initial developer in (a) the source code, and (b) in any notice in an executable version or related documentation in which you describe the origin or ownership of the covered code.

3.4. Intellectual property matters

(a) Third party claims.

If contributor has knowledge that a license under a third party's intellectual property rights is required to exercise the rights granted by such contributor under sections 2.1 or 2.2, contributor must include a text file with the source code distribution titled "LEGAL" which describes the claim and the party making the claim in sufficient detail that a recipient will know whom to contact. If contributor obtains such knowledge after the modification is made available as described in section 3.2, contributor shall promptly modify the LEGAL file in all copies contributor makes available thereafter and shall take other steps (such as notifying appropriate mailing lists or newsgroups) reasonably calculated to inform those who received the covered code that new knowledge has been obtained.

(b) Contributor APIs.

If contributor's modifications include an application programming interface and contributor has knowledge of patent licenses which are reasonably necessary to implement that API, contributor must also include this information in the LEGAL file.

(c) Representations.

contributor represents that, except as disclosed pursuant to section 3.4(a) above, contributor believes that contributor's modifications are contributor's original creation(s) and/or contributor has sufficient rights to grant the rights conveyed by this license.

3.5. Required notices.

You must duplicate the notice in exhibit A in each file of the source code. If it is not possible to put such notice in a particular source code file due to its structure, then You must include such notice in a location (such as a relevant directory) where a user would be likely to look for such a notice. If You created one or more modification(s), you may add your name as a contributor to the notice described in exhibit A. you must also duplicate this license in any documentation for the source code where You describe recipients' rights or ownership rights relating to covered code. You may choose to offer, and to charge a fee for, warranty, support, indemnity or liability obligations to one or more recipients of covered code. However, you may do so only on your own behalf, and not on behalf of the Initial developer or any contributor. You must make it absolutely clear than any such warranty, support, indemnity or liability obligation is offered by you alone, and You hereby agree to indemnify the Initial developer and every contributor for any liability incurred by the Initial developer or such contributor as a result of warranty, support, indemnity or liability terms you offer.

3.6. Distribution of executable versions.

You may distribute covered code in executable form only if the requirements of section 3.1-3.5 have been met for that covered code, and if you include a notice stating that the source code version of the covered code is available under the terms of this license, including a description of how and where you have fulfilled the obligations of section 3.2. The notice must be conspicuously included in any notice in an executable version, related documentation or collateral in which you describe recipients' rights relating to the covered code. You may distribute the executable version of covered code or ownership rights under a license of your choice, which may contain terms different from this license, provided that you are in compliance with the terms of this license and that the license for the executable version does not attempt to limit or alter the recipient's rights in the source code version from the rights set forth in this license. If you distribute the executable version under a different license you must make it absolutely clear that any terms which differ from this license are offered by you alone, not by the Initial developer or any contributor. You hereby agree to indemnify the initial developer and every contributor for any liability incurred by the initial developer or such contributor as a result of any such terms You offer.

3.7. Larger works.

You may create a larger work by combining covered code with other code not governed by the terms of this license and distribute the larger work as a single product. In such a case, you must make sure the requirements of this license are fulfilled for the covered code.

4. Inability to comply due to statute or regulation.

If it is impossible for you to comply with any of the terms of this license with respect to some or all of the covered code due to statute, judicial order, or regulation then you must: (a) comply with the terms of this license to the maximum extent possible; and (b) describe the limitations and the code they affect. Such description must be included in the LEGAL file described in section 3.4 and must be included with all distributions of the source code. Except to the extent prohibited by statute or regulation, such description must be sufficiently detailed for a recipient of ordinary skill to be able to understand it.

5. Application of this license.

This license applies to code to which the initial developer has attached the notice in exhibit A and to related covered code.

6. Versions of the license.

6.1. New versions.

Netscape communications corporation ("Netscape") may publish revised and/or new versions of the license from time to time. Each version will be given a distinguishing version number.

6.2. Effect of new versions.

Once covered code has been published under a particular version of the license, you may always continue to use it under the terms of that version. You may also choose to use such covered code under the terms of any subsequent version of the license published by netscape. No one other than netscape has the right to modify the terms applicable to covered code created under this license.

6.3. Derivative works.

If You create or use a modified version of this license (which you may only do in order to apply it to code which is not already covered code governed by this license), You must (a) rename Your license so that the phrases "Mozilla", "MOZILLAPL", "MOZPL", "Netscape", "MPL", "NPL" or any confusingly similar phrase do not appear in your license (except to note that your license differs from this license) and (b) otherwise make it clear that Your version of the license contains terms which differ from the Mozilla Public license and netscape Public License. (Filling in the name of the initial developer, original code or contributor in the notice described in exhibit A shall not of themselves be deemed to be modifications of this license.)

APPENDIX

7. DISCLAIMER OF WARRANTY.

COVERED CODE IS PROVIDED UNDER THIS LICENSE ON AN "AS IS" BASIS, WITHOUT WARRANTY OF ANY KIND, EITHER EXPRESSED OR IMPLIED, INCLUDING, WITHOUT LIMITATION, WARRANTIES THAT THE COVERED CODE IS FREE OF DEFECTS, MERCHANTABILITY, FIT FOR A PARTICULAR PURPOSE OR NON-INFRINGEMENT. THE ENTIRE RISK AS TO THE QUALITY AND PERFORMANCE OF THE COVERED CODE IS WITH YOU. SHOULD ANY COVERED CODE PROVE DEFECTIVE IN ANY RESPECT, YOU (NOT THE INITIAL DEVELOPER OR ANY OTHER CONTRIBUTOR) ASSUME THE COST OF ANY NECESSARY SERVICING, REPAIR OR CORRECTION. THIS DISCLAIMER OF WARRANTY CONSTITUTES AN ESSENTIAL PART OF THIS LICENSE. NO USE OF ANY COVERED CODE IS AUTHORIZED HEREUNDER EXCEPT UNDER THIS DISCLAIMER.

8. TERMINATION.

8.1. This license and the rights granted hereunder will terminate automatically if you fail to comply with terms herein and fail to cure such breach within 30 days of becoming aware of the breach. All sublicenses to the covered code which are properly granted shall survive any termination of this license. Provisions which, by their nature, must remain in effect beyond the termination of this license shall survive.

8.2. If you initiate litigation by asserting a patent infringement claim (excluding declaratory judgment actions) against initial developer or a contributor (the initial developer or contributor against whom you file such action is referred to as "Participant") alleging that:

- (a) such participant's contributor version directly or indirectly infringes any patent, then any and all rights granted by such participant to you under sections 2.1 and/or 2.2 of this license shall, upon 60 days notice from Participant terminate prospectively, unless if within 60 days after receipt of notice you either: (i) agree in writing to pay participant a mutually agreeable reasonable royalty for your past and future use of modifications made by such participant, or (ii) withdraw your litigation claim with respect to the contributor version against such participant. If within 60 days of notice, a reasonable royalty and payment arrangement are not mutually agreed upon in writing by the parties or the litigation claim is not withdrawn, the rights granted by participant to you under sections 2.1 and/or 2.2 automatically terminate at the expiration of the 60 day notice period specified above.
- (b) any software, hardware, or device, other than such participant's contributor Version, directly or indirectly infringes any patent, then any rights granted to You by

such participant under sections 2.1 (b) and 2.2(b) are revoked effective as of the date you first made, used, sold, distributed, or had made, modifications made by that participant.

8.3. If you assert a patent infringement claim against participant alleging that such participant's contributor version directly or indirectly infringes any patent where such claim is resolved (such as by license or settlement) prior to the initiation of patent infringement litigation, then the reasonable value of the licenses granted by such participant under sections 2.1 or 2.2 shall be taken into account in determining the amount or value of any payment or license.

8.4. In the event of termination under sections 8.1 or 8.2 above, all end user license agreements (excluding distributors and resellers) which have been validly granted by you or any distributor hereunder prior to termination shall survive termination.

9. LIMITATION OF LIABILITY.

UNDER NO CIRCUMSTANCES AND UNDER NO LEGAL THEORY, WHETHER TORT (INCLUDING NEGLIGENCE), CONTRACT, OR OTHERWISE, SHALL YOU, THE INITIAL DEVELOPER, ANY OTHER CONTRIBUTOR, OR ANY DISTRIBUTOR OF COVERED CODE, OR ANY SUPPLIER OF ANY OF SUCH PARTIES, BE LIABLE TO ANY PERSON FOR ANY INDIRECT, SPECIAL, INCIDENTAL, OR CONSEQUENTIAL DAMAGES OF ANY CHARACTER INCLUDING, WITHOUT LIMITATION, DAMAGES FOR LOSS OF GOODWILL, WORK STOPPAGE, COMPUTER FAILURE OR MALFUNCTION, OR ANY AND ALL OTHER COMMERCIAL DAMAGES OR LOSSES, EVEN IF SUCH PARTY SHALL HAVE BEEN INFORMED OF THE POSSIBILITY OF SUCH DAMAGES. THIS LIMITATION OF LIABILITY SHALL NOT APPLY TO LIABILITY FOR DEATH OR PERSONAL INJURY RESULTING FROM SUCH PARTY'S NEGLIGENCE TO THE EXTENT APPLICABLE LAW PROHIBITS SUCH LIMITATION. SOME JURISDICTIONS DO NOT ALLOW THE EXCLUSION OR LIMITATION OF INCIDENTAL OR CONSEQUENTIAL DAMAGES, SO THIS EXCLUSION AND LIMITATION MAY NOT APPLY TO YOU.

10. U.S. GOVERNMENT END USERS.

The covered code is a "commercial item," as that term is defined in 48 C.F.R. 2.101 (Oct. 1995), consisting of "commercial computer software" and "commercial computer software documentation," as such terms are used in 48 C.F.R. 12.212 (Sept. 1995). Consistent with 48 C.F.R. 12.212 and 48 C.F.R. 227.7202-1 through 227.7202-4 (June 1995), all U.S. Government end users acquire covered code with only those rights set forth herein.

11. MISCELLANEOUS.

This license represents the complete agreement concerning subject matter hereof. If any provision of this license is held to be unenforceable, such provision shall be reformed only to the extent necessary to make it enforceable. This License shall be governed by California law provisions (except to the extent applicable law, if any, provides otherwise), excluding its conflict-of-law provisions. With respect to disputes in which at least one party is a citizen of, or an entity chartered or registered to do business in the united states of america, any litigation relating to this License shall be subject to the jurisdiction of the federal courts of the northern district of california, with venue lying in santa clara county, california, with the losing party responsible for costs, including without limitation, court costs and reasonable attorneys' fees and expenses. The application of the united nations convention on contracts for the International sale of goods is expressly excluded. Any law or regulation which provides that the language of a contract shall be construed against the drafter shall not apply to this license.

12. RESPONSIBILITY FOR CLAIMS.

As between initial developer and the contributors, each party is responsible for claims and damages arising, directly or indirectly, out of its utilization of rights under this license and you agree to work with initial developer and contributors to distribute such responsibility on an equitable basis. Nothing herein is intended or shall be deemed to constitute any admission of liability.

13. MULTIPLE-LICENSED CODE.

Initial developer may designate portions of the covered code as "Multiple-Licensed". "Multiple-Licensed" means that the initial developer permits you to utilize portions of the covered code under your choice of the NPL or the alternative licenses, if any, specified by the initial developer in the file described in exhibit A.

EXHIBIT A -Mozilla Public License.

The contents of this file are subject to the Mozilla Public License Version 1.1 (the "license"); you may not use this file except in compliance with the License. You may obtain a copy of the license at <http://www.mozilla.org/MPL/>

Software distributed under the license is distributed on an "AS IS" basis, WITHOUT WARRANTY OF ANY KIND, either express or implied. See the license for the specific language governing rights and limitations under the License.

The Original Code is _____.

The Initial Developer of the Original Code is _____.

Portions created by _____ are Copyright (C) _____ . All Rights Reserved.

Contributor(s): _____.

Alternatively, the contents of this file may be used under the terms of the ____ license (the "[] License"), in which case the provisions of [] license are applicable instead of those above. If you wish to allow use of your version of this file only under the terms of the [] license and not to allow others to use your version of this file under the MPL, indicate your decision by deleting the provisions above and replace them with the notice and other provisions required by the [] license. If you do not delete the provisions above, a recipient may use your version of this file under either the MPL or the [] license."

NOTE: The text of this exhibit A may differ slightly from the text of the notices in the source code files of the original code. You should use the text of this exhibit A rather than the text found in the original code/source code for Your modifications.



LG Electronics Inc.

