



# PLASMA MONITOR

**MODELS: 42PM4M / 42PM4MA  
50PM4M / 50PM4MA  
60PM4M / 60PM4MA**

## OWNER'S MANUAL



Please read this manual carefully before operating your set.  
Retain it for future reference.  
Record model number and serial number of the set.  
See the label attached on the back cover and quote  
this information to your dealer  
when you require service.

**P/NO: MFL36274107 (0803-REV04)  
Printed in Korea**

# WARNING / CAUTION



**WARNING / CAUTION**  
RISK OF ELECTRIC SHOCK  
DO NOT OPEN



TO REDUCE THE RISK OF ELECTRIC SHOCK  
DO NOT REMOVE COVER (OR BACK). NO  
USER SERVICEABLE PARTS INSIDE. REFER TO  
QUALIFIED SERVICE PERSONNEL.



The lightning flash with arrowhead symbol, within an equilateral triangle, is intended to alert the user to the presence of uninsulated “dangerous voltage” within the product’s enclosure that may be of sufficient magnitude to constitute a risk of electric shock to persons.



The exclamation point within an equilateral triangle is intended to alert the user to the presence of important operating and maintenance (servicing) instructions in the literature accompanying the appliance.

## WARNING/CAUTION

TO REDUCE THE RISK OF FIRE AND ELECTRIC SHOCK, DO NOT EXPOSE THIS PRODUCT TO RAIN OR MOISTURE.

## NOTE TO CABLE/TV INSTALLER

This reminder is provided to call the CATV system installer’s attention to Article 820-40 of the National Electric Code (U.S.A.). The code provides guidelines for proper grounding and, in particular, specifies that the cable ground shall be connected to the grounding system of the building, as close to the point of the cable entry as practical.

## WARNING / CAUTION

To prevent fire or shock hazards, do not expose this product to rain or moisture.

## FCC NOTICE

### Class B digital device

This equipment has been tested and found to comply with the limits for a Class B digital device, pursuant to Part 15 of the FCC Rules. These limits are designed to provide reasonable protection against harmful interference in a residential installation. This equipment generates, uses and can radiate radio frequency energy and, if not installed and used in accordance with the instructions, may cause harmful interference to radio communications. However, there is no guarantee that interference will not occur in a particular installation. If this equipment does cause harmful interference to radio or television reception, which can be determined by turning the equipment off and on, the user is encouraged to try to correct the interference by one or more of the following measures:

- Reorient or relocate the receiving antenna.
- Increase the separation between the equipment and receiver.
- Connect the equipment to an outlet on a circuit different from that to which the receiver is connected.
- Consult the dealer or an experienced radio/TV technician for help.

**Any changes or modifications not expressly approved by the party responsible for compliance could void the user’s authority to operate the equipment.**

## CAUTION

Do not attempt to modify this product in any way without written authorization from LG Electronics. Unauthorized modification could void the user’s authority to operate this product

# Safety Instructions



## WARNING

**Do not place the set in direct sunlight or near heat sources such as electric or gas heaters, a stove and so on.**

- This may cause a fire.

**Do not use the set in a damp place such as a bathroom or any place where it is likely to get wet.**

- This may cause a fire or could give you an electric shock.

**Bend the antenna cable between the inside and the outside of the building to prevent rain from flowing in.**

- This may cause water damaged inside the set and could give you an electric shock.

**Earth wire should be connected.**

- If the earth wire is not connected, there is possibility of electric shock caused by the leakage current.
- If grounding methods are not possible, a separate circuit breaker should be employed and installed by a qualified electrician.
- Do not connect ground to telephone wires, lightning rods or a gas pipe.

**Do not place anything containing liquid on top of the set.**

- This may cause a fire or could give an electric shock.

**Do not insert any object into the air exhaust vents.**

- This may cause a fire or could give you an electric shock.

**Do not place heavy objects on the set.**

- This may cause serious injury to a child or adult.

**Do not use water while cleaning the set.**

- This may cause damage to the set or could give an electric shock.

**In case of smoke or a strange smell from the set, switch it off ,unplug it from the wall outlet and contact your dealer or service centre.**

- This may cause a fire or could give you an electric shock.

**Do not attempt to service the set yourself. Contact your dealer or service centre.**

- This may cause damage to the set or could give you an electric shock.

**During a lightning or thunder storm, unplug the set from the wall outlet and don't touch the antenna cable.**

- This may cause damage to the set or could give you an electric shock.

## WARNING/CAUTION

TO REDUCE THE RISK OF FIRE AND ELECTRIC SHOCK, DO NOT EXPOSE THIS PRODUCT TO RAIN OR MOISTURE.

\* Safety instructions have two kinds of information, and each meaning of it is as below.



**WARNING** The violation of this instruction may cause serious injuries and even death.



**NOTES** The violation of this instruction may cause light injuries or damage of the product.

Take care of danger that may happen under specific condition.

## NOTES

**Never touch the power plug with a wet hand.**

- This may cause an electric shock.

**Disconnect the unit from the mains power and remove all connections before moving the unit.**

**Do not place the set in a built-in installation such as a bookcase or rack.**

- Ventilation is required for the unit.

**When installing the set on a table, be careful not to place the edge of its stand.**

- This may cause the set to fall, causing serious injury to a child or adult, and serious damage to the set.

**Do not place an outside antenna in the vicinity of overhead power lines or other electric light or power circuits.**

- This may cause an electric shock.

**There should be enough distance between an outside antenna and power lines to keep the former from touching the latter even when the antenna falls.**

- This may cause an electric shock.

**Do not pull the cord but the plug when unplugging.**

- This may cause a fire.

**Ensure the power cord doesn't trail across any hot objects like a heater.**

- This may cause a fire or an electric shock.

**Do not plug when the power cord or the plug is damaged or the connecting part of the power outlet is loose.**

- This may cause a fire or an electric shock.

**Dispose of used batteries carefully to protect a child from eating them.**

- In case that someone eats them, take the person to see a doctor immediately..

**When moving the set assembled with speakers do not carry holding the speakers.**

- This may cause the set to fall, causing serious injury to a child or adult, and serious damage to the monitor.

**Unplug this product from the wall outlet before cleaning. Do not use liquid cleaners or aerosol cleaners.**

- This may cause damage to the set or could give an electric shock.

**Contact the service center once a year to clean the internal part of the set.**

- Accumulated dust can cause mechanical failure.

**The distance between eyes and the screen should be about 5 ~ 7 times as long as diagonal length of the screen.**

- If not, you may strain your eyes.

**Unplug the set from the wall outlet when it is left unattended and unused for long periods of time.**

- Accumulated dust may cause a fire or an electric shock from deterioration or electric leakage.

## Safety Instructions continued

### CAUTION concerning the Power Cord :

- Most appliances recommend they be connected to a dedicated circuit; that is, a single outlet circuit which powers only that appliance and has no additional outlets or branch circuits.

- This may cause a fire or an electric shock.

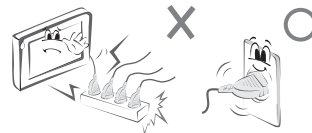

- Do not overload wall outlets. Overloaded wall outlets, loose or damaged wall outlets, extension cords, frayed power cords, or damaged or cracked wire insulation are dangerous. Any of these conditions could result in electric shock or fire. Periodically examine the cord of your appliance, and if its appearance indicates damage or deterioration, unplug it, discontinue use of the appliance, and have the cord replaced with an exact replacement part by an authorized service centre.
- Protect the power cord from physical or mechanical abuse, such as being twisted, kinked, pinched, closed in a door, or walked upon. Pay particular attention to plugs, wall outlets, and the point where the cord exits the appliance.
- Use a dedicated power cord. Do not modify or extend the power cord.
- Do not install, remove, or reinstall the unit by yourself (customer).  
For electrical work, contact the dealer, seller, a qualified electrician, or an Authorized Service Center. For installation, always contact the dealer or an Authorized Service Center.
- Do not use if the power cord or plug is damaged, or socket is loose. Use a dedicated outlet for this appliance.
- Do not over bend the power cord and do not place anything on the power cord. Do not install the monitor near any sharp edge to avoid wire damage.

### Outdoor Use Marking :

- WARNING - To Reduce The Risk Of Fire Or Electric Shock, Do Not Expose This Appliance To Rain Or Moisture.

### Wet Location Marking :

- Apparatus shall not be exposed to dripping or splashing and no objects filled with liquids, such as vases, shall be placed on the apparatus.

# Contents

Safety Instructions .....	2-4	Special Menu Options	
<b>Introduction</b>		Child Lock .....	25
Accessories .....	7	ISM (Image Sticking Minimization) Method .....	25
Controls and Connection Options .....	8-9	Tile mode .....	26-27
Remote Control Key Functions .....	10	Low Power .....	27
<b>Installation</b>		XD DEMO .....	28
Installation Instructions .....	11	Screen Menu Options	
External Equipment Connections .....	12-16	Auto Configure .....	29
When Connecting to your PC .....	12-13	Manual Configure .....	29
Watching RGB Outputs .....	13	Selecting XGA mode .....	30
When watching VCR / DVD .....	14	Setting the Picture Format .....	30
When watching HDTV/DVD(480p/576p/ 720p/1080i/480i/576i) .....	15	Initializing (Reset to original factory settings) ..	31
When watching HDMI/DVI/RGB from the VCR/DVD/Set-top Box (480p/576p/720p/1080i) .....	15	<b>External Control Device Setup</b> .....	32-37
Watching AV Outputs .....	16	<b>IR Code</b> .....	38-39
<b>Operation</b>		<b>Troubleshooting Checklist</b> .....	40
Turning on the Monitor .....	17	<b>Product Specifications</b> .....	41
Menu Language Selection .....	17		
Picture Menu Options			
PSM (Picture Status Memory) .....	18		
Manual Picture Control (user option) .....	18		
CSM (Colour Status Memory) .....	18		
Manual Colour Temperature Control .....	19		
XD .....	19		
Advanced - Cinema .....	20		
Advanced - Black level .....	20		
Reset .....	20		
Sound Menu Options			
SSM .....	21		
AVL (Auto Volume Leveler) .....	21		
Balance .....	22		
Speaker .....	22		
Timer Menu Options			
Clock Setup .....	23		
On/Off Time Setup .....	23		
Auto sleep .....	24		

After reading this manual, keep it handy for future reference.

# Introduction

## What is a Plasma Display Panel?

If voltage is applied to a gas within glass panels, ultraviolet rays are produced and fused with a fluorescent substance. At that instant, light is emitted. A Plasma Display is the next generation flat Display using this phenomenon.

## 160° - Wide angle range of vision

Your flat panel plasma screen offers an exceptionally broad viewing angle -- over 160 degrees. This means that the display is clear and visible to viewers anywhere in the room.

## Wide Screen

The screen of the Plasma Display is 42",50" or 60" so wide that your viewing experience is as if you are in a movie theater.

## Versatile

The light weight and thin size makes it easy to install your plasma display in a variety of locations where conventional TVs would not fit.

## The Plasma Monitor Manufacturing Process: Why minute colored dots may be present on the Plasma Monitor screen

The Plasma Display Panel which is the display device of this product is composed of 0.9 to 2.2 million cells. A few cell defects will normally occur in the Plasma Monitor manufacturing process. Several minute colored dots visible on the screen should be acceptable. This also occurs in other Plasma Monitor manufacturers' products and the tiny dots appearing does not mean that this Plasma Monitor is defective. Thus a few cell defects are not sufficient cause for the Plasma Monitor to be exchanged or returned. Our production technology is designed to minimize cell defects during the manufacture and operation of this product.

## Cooling Fan Noise

In the same way that a fan is used in a PC computer to keep the CPU (Central Processing Unit) cool, the Plasma Monitor is equipped with cooling fans to cool the Monitor and improve its reliability. Therefore, a certain level of noise could occur while the fans are operating and cooling the Plasma Monitor.

The fan noise doesn't have any negative effect on the Plasma Monitor's efficiency or reliability. The noise from these fans is normal during the operation of this product. We hope you understand that a certain level of noise from the cooling fans is acceptable and is not sufficient cause for the Plasma Monitor to be exchanged or returned.

### **WARNING**

TO REDUCE THE RISK OF FIRE AND ELECTRIC SHOCK, DO NOT EXPOSE THIS PRODUCT TO RAIN OR MOISTURE.

# Accessories

Ensure that the following accessories are included with your plasma display. If an accessory is missing, please contact the dealer where you purchased the product.

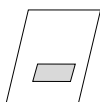

Owner's Manual

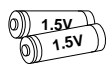

Batteries

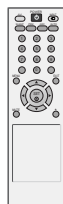

Remote Control



Power Cord

## Option Extras

- Optional extras can be changed or modified for quality improvement without any notification new optional extras can be added.
- Contract your dealer for buying these items.

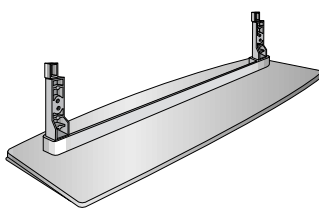

Desktop stand

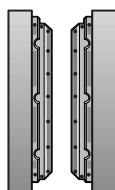

speaker

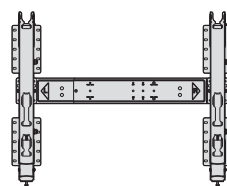

Tilt wall mounting bracket

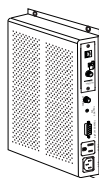

D-BOX



Video cables



Audio cables



# Controls

- Here shown may be somewhat different from your set.

## Front Panel Controls

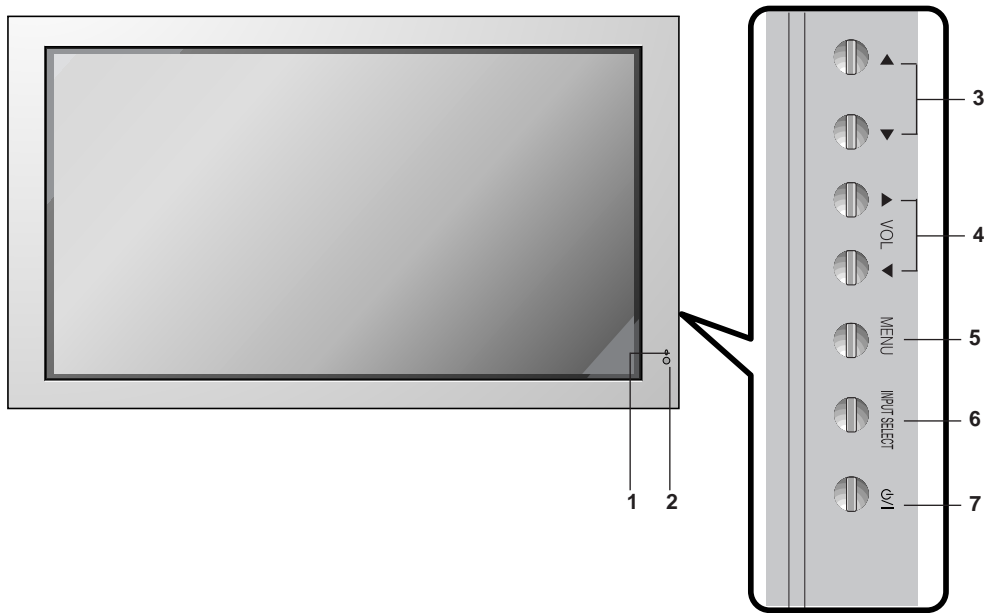

**1. Power Indicator**

Illuminates red in standby mode, Illuminates green when the Set is turned on.

**2. Remote Control Sensor**

**3. ◀, ▶ Buttons**

**4. VOLUME (▼, ▲) Buttons**

**5. MENU Button**

**6. INPUT SELECT Button**

**7. Main Power Button**

Switches the set on from standby or off to standby.

### 60PM4M

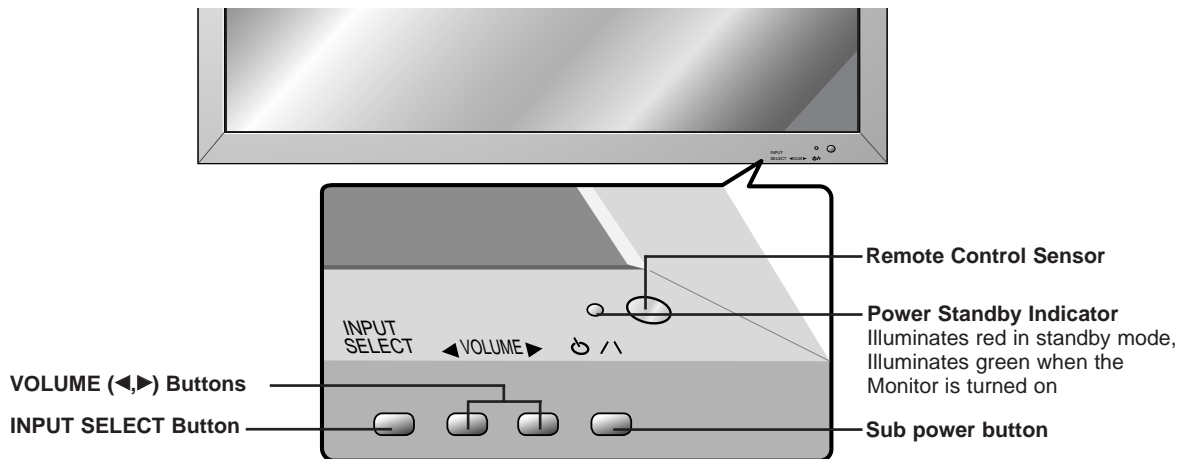

# Connection Options

- Here shown may be somewhat different from your set.

## Back Connection Panel

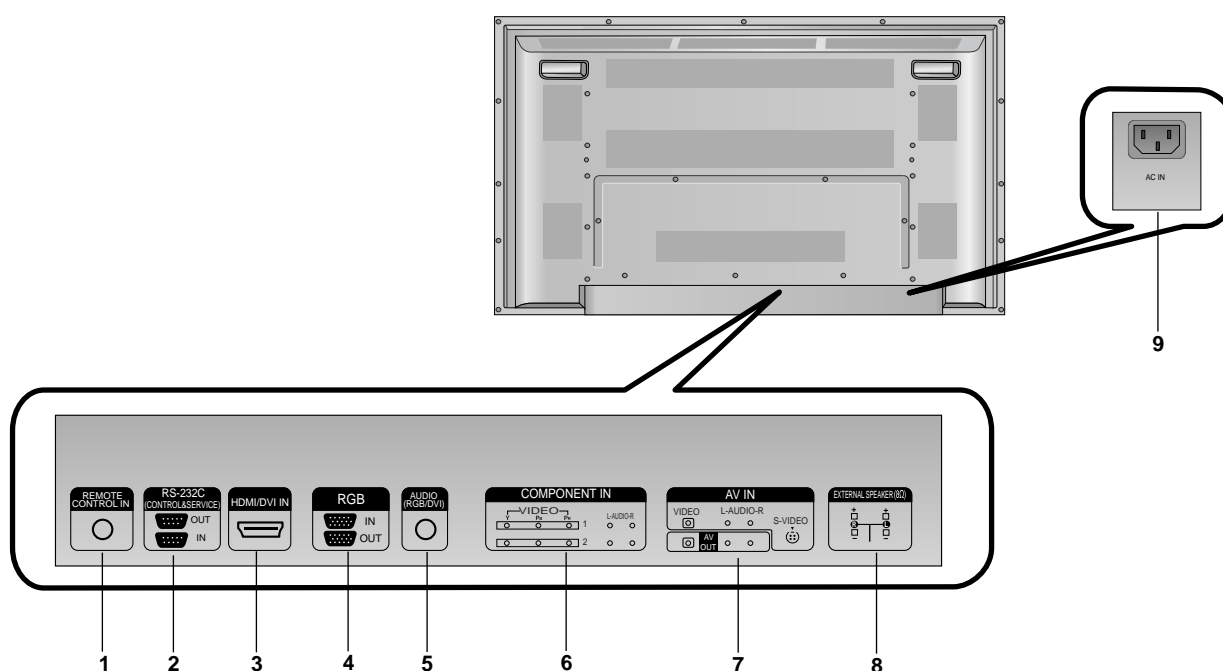

### 1. REMOTE CONTROL IN

### 2. RS-232C INPUT (CONTROL & SERVICE) PORT OUT

For control the another set, connect a RS-232C Cable from RS-232C out port to another set's RS-232C input port.

#### IN

Connect to the RS-232C port on a PC.

### 3. HDMI/DVI IN

Connect a HDMI signal to this jack. Or connect a DVI (Video) signal.

### 4. RGB INPUT

Connect the set output connector from a PC to the appropriate input port.

#### RGB OUTPUT

You can watch the RGB signal on another set, connect RGB OUTPUT to another set's PC input port.

### 5. AUDIO (RGB/DVI)

Connect a PC Phone Cable.

### 6. COMPONENT INPUT 1-2

Connect a component video/audio device to these jacks.

### 7. AV IN

Connect audio/video output from an external device to these jacks.

#### S-VIDEO

Connect S-Video out from an S-VIDEO device.

#### AV OUT

Connect a AV Cable from AV (CVBS) out port to another set's AV input port.

### 8. EXTERNAL SPEAKER (8 ohm output)

Connect to optional external speaker(s).

\* For further information, refer to 'Speaker & Speaker Stand' manual.

### 9. POWER CORD SOCKET

This set operates on an AC power. The voltage is indicated on the Specifications page. Never attempt to operate the set on DC power.

# Remote Control Key Functions

- When using the remote control, aim it at the remote control sensor on the monitor.
- Under certain conditions such as if the remote IR signal is interrupted, the remote control may not function. Press the key again as necessary.

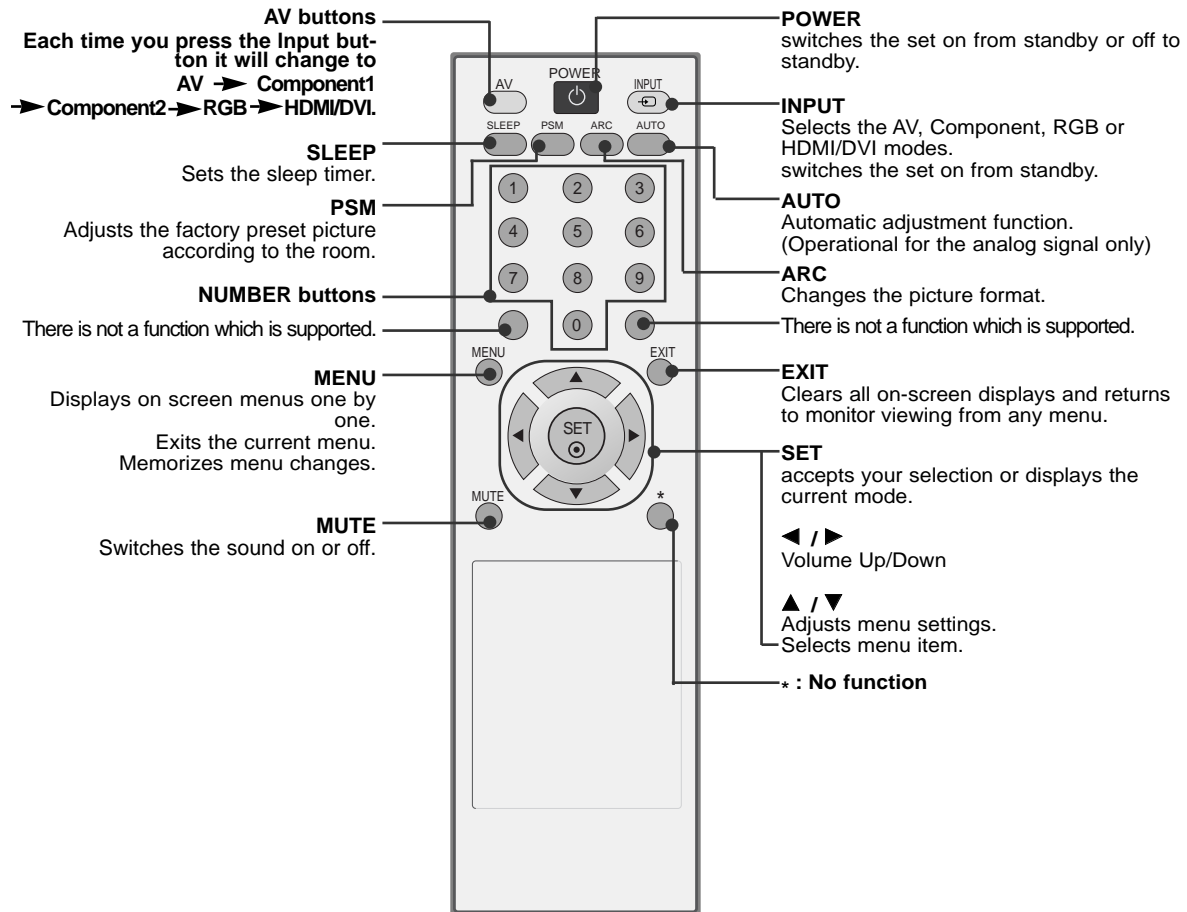

## Installing Batteries

- Open the battery compartment cover on the back side and install the batteries matching correct polarity (+ with +, - with -).
- Install two 1.5V AAA batteries. Don't mix old or used batteries with new ones. Replace cover.

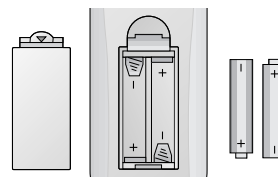

# Installation

## Installation Instructions

- Install this monitor only in a location where adequate ventilation is available.
- If set is installed vertically, it is on the control key toward down.

### GROUNDING

Ensure that you connect the grounding / earth wire to prevent possible electric shock. If grounding methods are not possible, have a qualified electrician install a separate circuit breaker. Do not try to ground the unit by connecting it to telephone wires, lightening rods, or gas pipes.

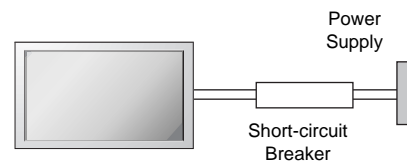

### Wall Mount Installation

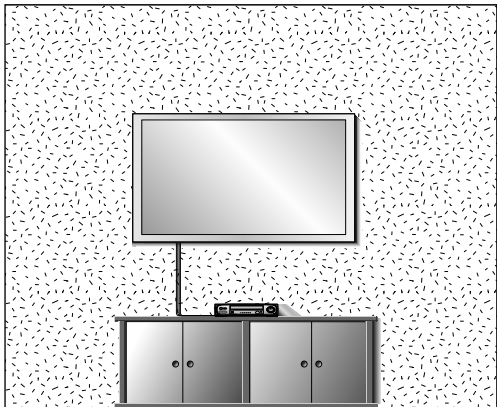

For proper ventilation, allow a clearance of 4" on each side and 4" from the wall. Detailed installation instructions are available from your dealer, see the optional Wall Mounting Bracket Installation and Setup Guide.

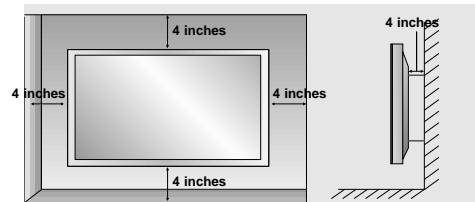

### Desktop Pedestal Installation

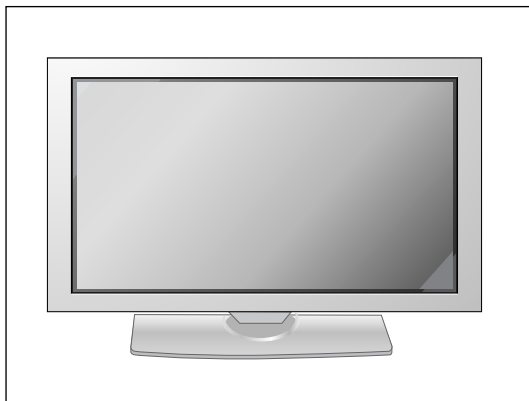

For proper ventilation, allow a clearance of 4" on each side and the top and 4" from the wall. Detailed installation instructions are included in the optional Desktop Stand Installation and Setup Guide available from your dealer.

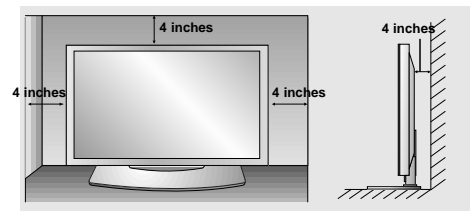

# External Equipment Connections

**NOTE:** Not all cables shown are included with the plasma display.

## When Connecting to your PC

1. First of all, see if the computer, product and the peripherals are turned off.  
Then, connect the signal input cable.

a. When connecting with the D-Sub signal input cable.

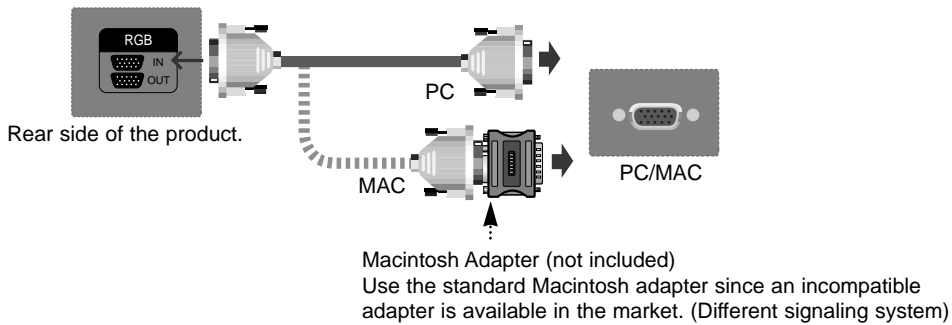

b. When connecting with the HDMI to DVI signal input cable (not included).

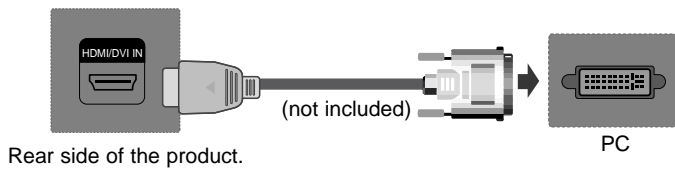

2. Connect the Audio cable.



3. Connect the power cord.

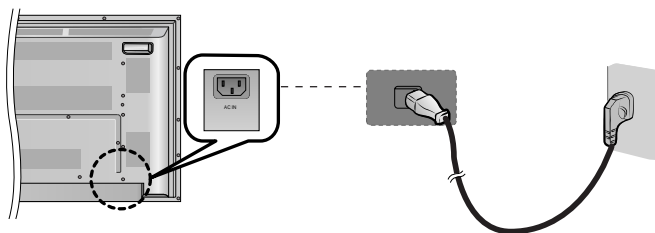

4. Turn on power by pressing the power button on the product.  
Turn on the PC.

5. Select an input signal.

Press the INPUT button on the remote control to select the input signal.

INPUT → ▲ / ▼ → SET

a. When connecting with a D-Sub signal input cable.

- Select RGB : 15-pin D-Sub analog signal.

b. When connecting with a HDMI to DVI signal input cable.

- Select HDMI/DVI : HDMI to DVI Digital signal.

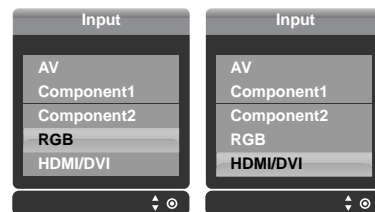

**NOTES:** • **How to connect to two computers.**

Connect the signal cables (HDMI to DVI and D-Sub) to each computer.

Press the INPUT button on the remote control to select the computer to use.

- Directly connect to a grounded power outlet on the wall or a power bar with a ground wire.

### Watching RGB Outputs

Use this function when displaying ANALOG RGB inputs of a PC to the other product.

- To use different products connected to each other Connect one end of the signal input cable(15-pin D-Sub Signal Cable) to the RGB OUT connector of product 1 and connect the other end to the RGB IN connector of other products.

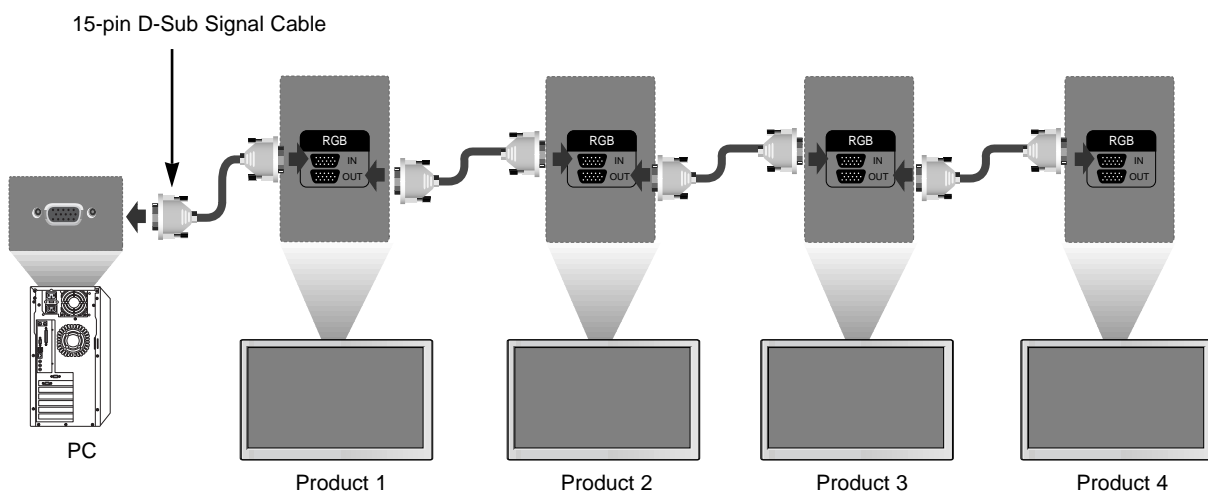

- NOTES:** • When multi-connecting in/out cascade format, cables to be less damaged are recommended.  
We recommend that you should use cable distributor.

When watching VCR / DVD

1. Connect the video cable as shown in the below figure and then connect the power cord.

a. When connecting with a BNC cable.

- Connect the input terminal with a proper colour match.

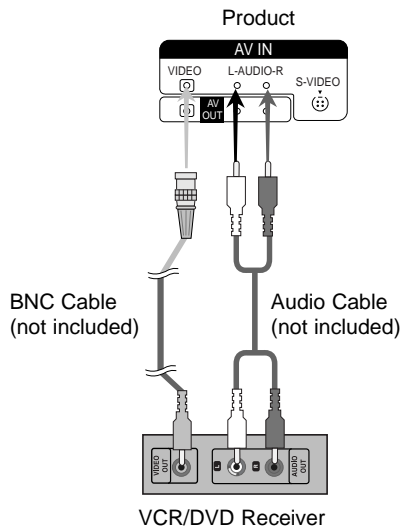

b. When connecting with a S-Video cable.

- Connect to the S-Video input terminal to watch high image quality movies.

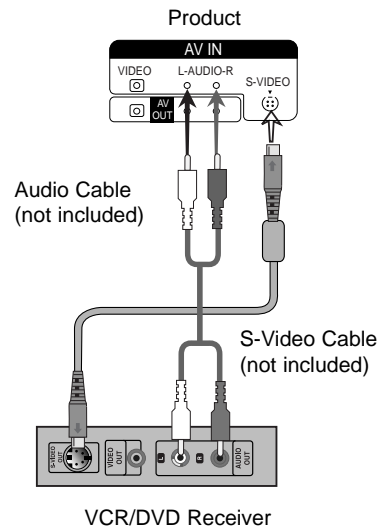

2. Select an input signal.

Press the INPUT button on the remote control to select the input signal.

INPUT → ▲ / ▼ → SET

- When connecting with an BNC cable.
  - Select AV.
- When connecting with an S-Video cable.
  - Select AV.

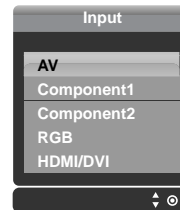

**NOTES:** • When the BNC cable is connected simultaneously with S-Video cable, S-Video cable is first.

When watching HDTV/DVD(480p/576p/720p/1080i/480i/576i)

1. Connect the video/audio cable as shown in the below figure and then, connect the power cord.
  - Connect the input terminal with a proper colour match.

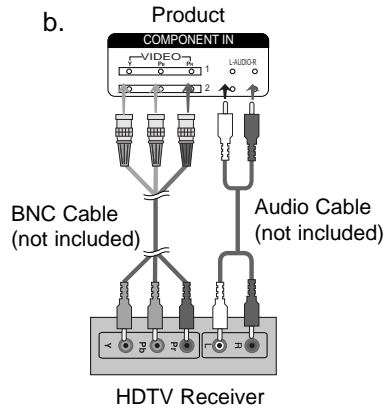
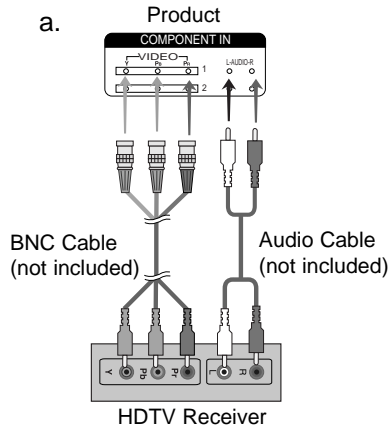

2. Select an input signal.

Press the INPUT button on the remote control to select the input signal.

INPUT → ▲ / ▼ → SET

- Select Component 1
- Select Component 2

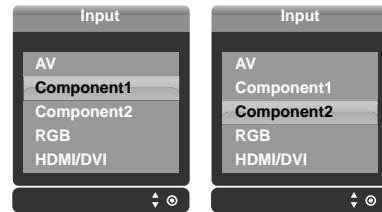

When watching HDMI/DVI/RGB from the VCR/DVD/Set-top Box (480p/576p/720p/1080i)

1. Connect the video/audio cable as shown in the below figure and then connect the power cord.

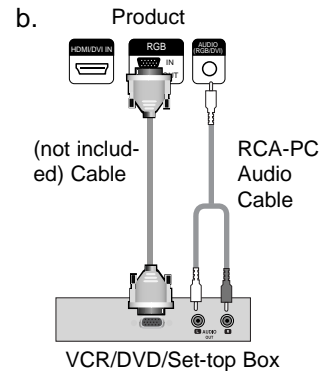
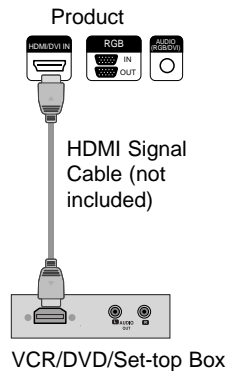
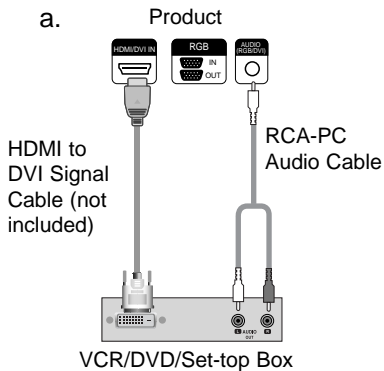

2. Select an input signal.

Press the INPUT button on the remote control to select the input signal.

INPUT → ▲ / ▼ → SET

- When connecting with a HDMI to DVI signal input cable.
  - Select HDMI/DVI
- When connecting with a D-Sub signal input cable.
  - Select RGB

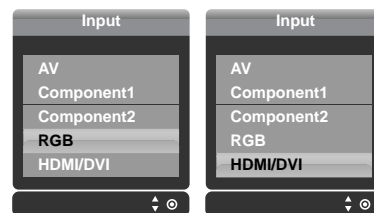



Watching AV Outputs

- When you set the input signal of the main screen as 'AV (CVBS)', you can transmit the signal that you're watching to the AV output terminal.

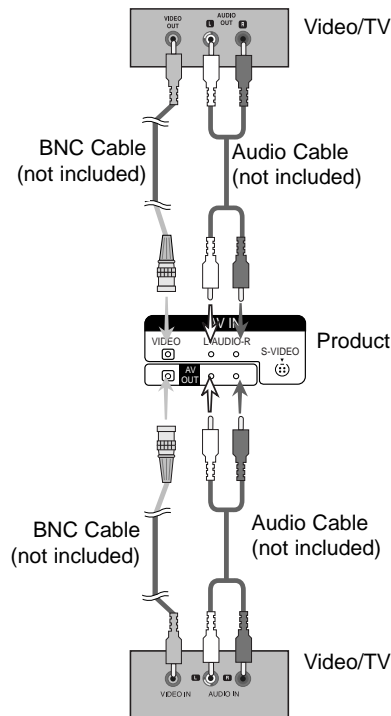

**NOTES:** • When multi-connecting in/out cascade format, cables to be less damaged are recommended. We recommend that you should use cable distributor.

PC Mode – Preset Mode

Resolution	Horizontal Frequency(kHz)	Vertical Frequency(Hz)
1. VGA 640 x 350	31.468	70.09
2. VGA 720 x 400	31.469	70.08
3. VGA 640 x 480	31.469	59.94
4. VESA 640 x 480	37.500	75.00
5. VESA 640 x 480	43.269	85.00
6. VESA 800 x 600	37.879	60.31
7. VESA 800 x 600	46.875	75.00
8. VESA 800 x 600	53.674	85.06
9. MAC 832 x 624	49.725	74.55
10. VESA1024 x 768	48.363	60.00
11. VESA1024 x 768	60.023	75.02
12. VESA1024 x 768	68.677	85.00
13. VESA1280 x 720	44.772	59.85
14. VESA1280 x 768	47.693	59.99
15. VESA1360 x 768	47.700	60.00
16. VESA1366 x 768	47.700	60.00
17. VESA1280 x 1024	63.981	60.02
18. VESA 1280 x 1024	79.980	75.02
19. VESA 1600 x 1200	75.000	60.00

**NOTES:** We recommend using 1360\*768, 60Hz (50PM4M) for the PC mode, they provide the best picture quality. (If the resolution of PC is over UXGA, there will be no picture on the set.)

RGB : Mode 1 ~ Mode 19  
HDMI/DVI : Mode 1 ~ Mode 17

DTV Mode

Signal	Component 1/2	RGB	HDMI
480i	O	X	X
576i	O	X	X
480p	O	O	O
576p	O	O	O
720p	O	O	O
1080i	O	O	O

# Operation

Your Monitor's OSD (On Screen Display) may differ slightly from what is shown in this manual.

## Turning on the Monitor

### Turning on the Monitor just after installation

1. Connect power cord correctly. At this moment, the Monitor is switched to standby mode.
2. Press the **INPUT** or  button on the Monitor or press the **POWER, INPUT** button on the remote control and then the Monitor will switch on.

## Menu Language Selection

- The menus can be shown on the screen in the selected language. First select your language.

1. Press the **MENU** button and then use **▲ / ▼** button to select the **SPECIAL** menu.
  2. Press the **▶** button and then use **▲ / ▼** button to select **Language**.
  3. Press the **▶** button and then use **▲ / ▼** button to select your desired language.  
From this point on, the on-screen menus will be shown in the language of your choice.
  4. Press the **EXIT** button to save the new settings.
- Press the **MENU** button to return to the previous menu.

# Picture Menu Options

- Readjust Picture menu settings for each following input source as preferred.

## PSM (Picture Status Memory)

- This function adjusts the set to the best picture appearance.
- When adjusting picture options (contrast, brightness, colour, sharpness and tint) manually, PSM is automatically changed to **User**.

1. Press the **PSM** button

- Each press of the **PSM** button changes the screen display as shown below.

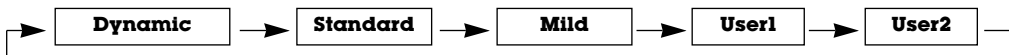

- You can also select **Dynamic, Standard, Mild** or **User1/2** in the PICTURE menu.
- Picture options **Dynamic, Standard** and **Mild** are preset and programmed for good picture quality at the factory and cannot be changed.

## Manual Picture Control (user option)

- You can adjust picture contrast, brightness, colour, sharpness, and tint to the levels you prefer.

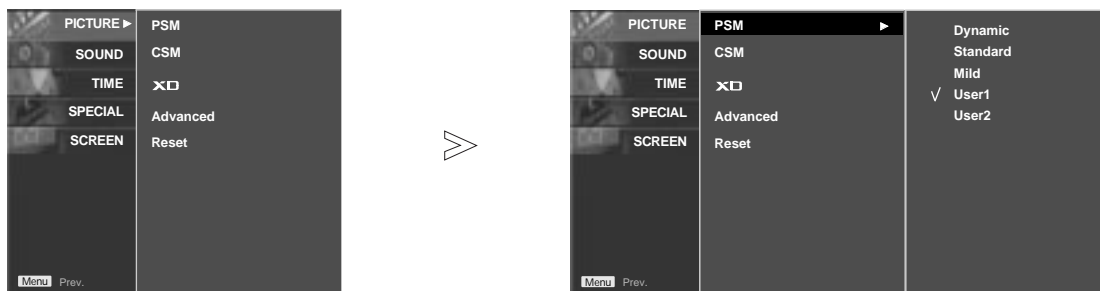

1. Press the **MENU** button and then use **▲ / ▼** button to select the **PICTURE** menu.
2. Press the **▶** button and then use **▲ / ▼** button to select **PSM**.
3. Press the **▶** button and then use **▲ / ▼** button to select **User1** or **User2**.
4. Press the **▶** button and then use **▲ / ▼** button to select the desired picture option (**Contrast, Brightness, Colour, Sharpness** or **Tint**).
5. Press the **▶** button and then use **◀ / ▶** button to make appropriate adjustments.
6. Press the **EXIT** button to save the new settings.

## CSM (Colour Status Memory)

- To initialize values (reset to default settings), select the **Cool** option.

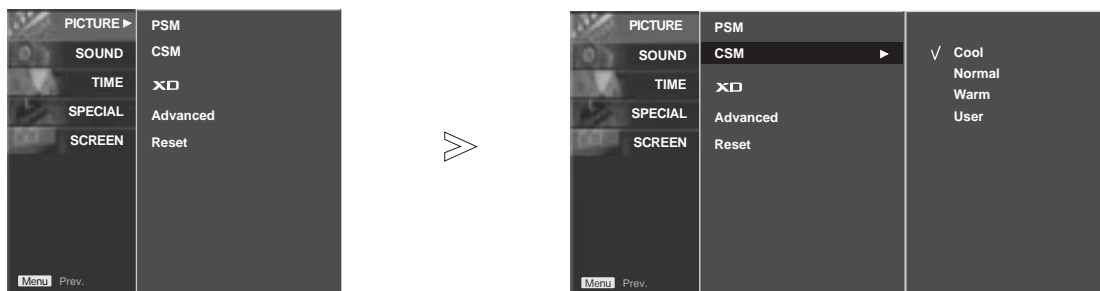

1. Press the **MENU** button and then use **▲ / ▼** button to select the **PICTURE** menu.
  2. Press the **▶** button and then use **▲ / ▼** button to select **CSM**.
  3. Press the **▶** button and then use **▲ / ▼** button to select the desired colour temperature.
  4. Press the **EXIT** button to save the new settings.
- Each press of **▲ / ▼** button changes the screen display as shown below.

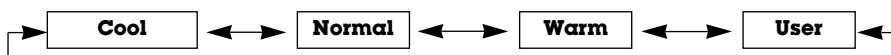

### Manual Colour Temperature Control (**CSM** set to user option)

- You can adjust red, green, or blue to any colour temperature you prefer.
- 1. Press the **MENU** button and then use **▲ / ▼** button to select the **PICTURE** menu.
- 2. Press the **▶** button and then use **▲ / ▼** button to select **CSM**.
- 3. Press the **▶** button and then use **▲ / ▼** button to select **User**.
- 4. Press the **▶** button and then use **▲ / ▼** button to select **Red, Green** or **Blue**.
- 5. Use the **◀ / ▶** button to make appropriate adjustments.
  - The adjustment range of **Red, Green** and **Blue** is -40 ~ +40.
- 6. Press the **EXIT** button to save the new settings.

### XD

- XD is LG electronic's unique picture improving technology to display a real HD source through an advanced digital signal processing algorithm.
- It's not available to use this function in PC[RGB/HDMI] mode.

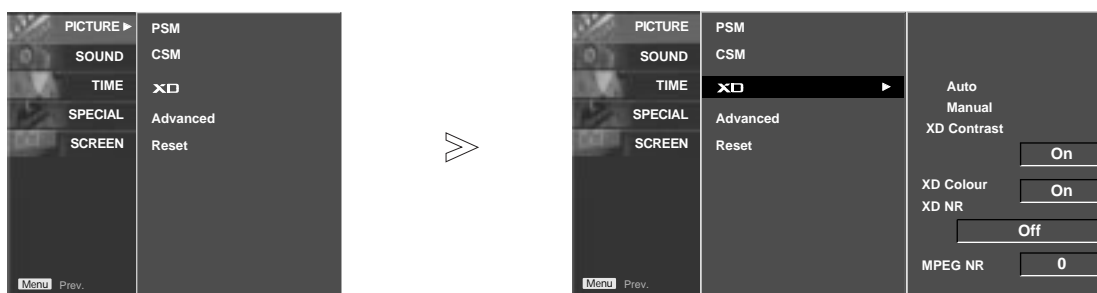

1. Press the **MENU** button and then use **▲ / ▼** button to select the **PICTURE** menu.
2. Press the **▶** button and then use **▲ / ▼** button to select **XD**.
3. Press the **▶** button and then use **▲ / ▼** button to select **Auto** or **Manual**.
4. Press the **EXIT** button to save the new settings.

\* Selecting the Manual

This menu is activated after selecting the **User1** or **User2** of **Picture Mode**.

1. Press the **▶** button and then **▲ / ▼** button to select **XD Contrast**, **XD Colour**, **XD NR** or **MPEG NR**.
2. Press the **▶** button and then **▲ / ▼** button to select **On** or **Off**.
3. Press the **EXIT** button to save the new settings.

- **XD Contrast** : Optimizing the contrast automatically according to the brightness of the reflection.
- **XD Colour** : Adjusting the colours of the reflection automatically to reproduce as closely as possible to the natural colours.
- **XD NR** : Removing the noise up to the point where it does not damage the original picture.
- **MPEG NR** : To reduce the picture noise which may appear on the screen during watching the Monitor.

# Picture Menu Options

## Advanced - Cinema

- Set up the monitor for the best picture appearance for viewing movies.
- This feature operates only in AV, S-Video and Component 480i/576i mode.

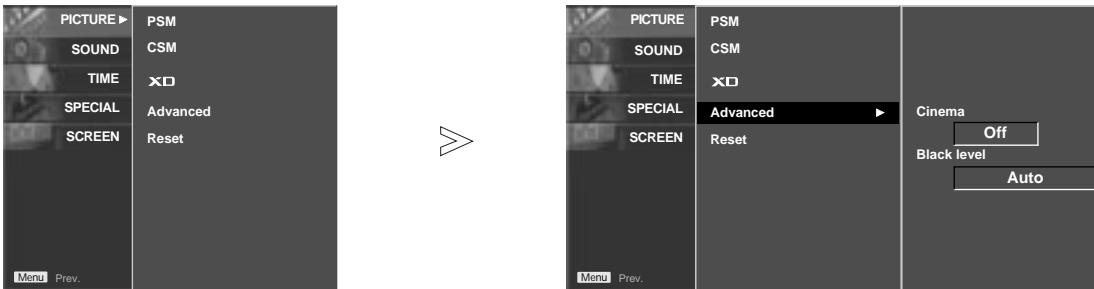

1. Press the **MENU** button and then use **▲ / ▼** button to select the **PICTURE** menu.
2. Press the **▶** button and then use **▲ / ▼** button to select **Advanced**.
3. Press the **▶** button and then use **▲ / ▼** button to select **Cinema**.
4. Press the **◀ / ▶** button to select **On** or **Off**.
5. Press the **EXIT** button to save the new settings.

## Advanced - Black level

- When you watch the movie, this function adjusts the set to the best picture appearance. Adjusting the contrast and the brightness of the screen using the black level of the screen.
- This function works in the following mode: AV (NTSC-M), S-Video (NTSC-M) or HDMI.

1. Press the **MENU** button and then use **▲ / ▼** button to select the **PICTURE** menu.
2. Press the **▶** button and then use **▲ / ▼** button to select **Advanced**.
3. Press the **▶** button and then use **▲ / ▼** button to select **Black level**.
4. Press the **◀ / ▶** button to select **Auto**, **Low** or **High**.
  - **Low** : The reflection of the screen gets darker.
  - **High** : The reflection of the screen gets brighter.
5. Press the **EXIT** button to save the new settings.

## Reset

This function operates in current mode.  
To initialize the adjusted value

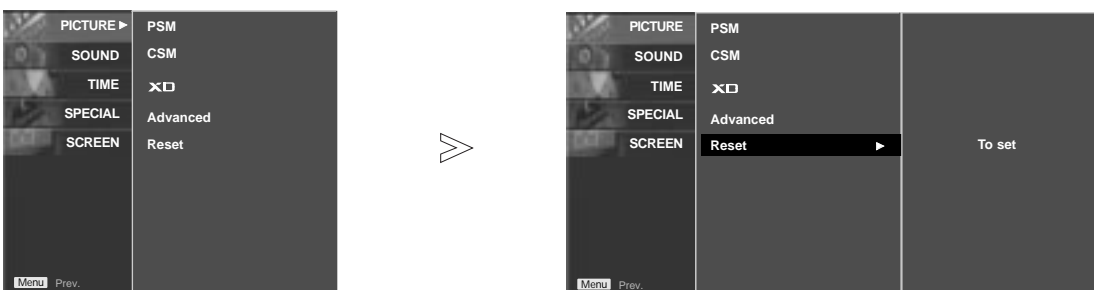

1. Press the **MENU** button and then **▲ / ▼** button to select the **PICTURE** menu.
2. Press the **▶** button and then **▲ / ▼** button to select **Reset**.
3. Press the **▶** button.

# Sound Menu Options

## SSM

- This function lets you enjoy the best sound without any special adjustment because the set automatically selects the appropriate sound option based on the program content.

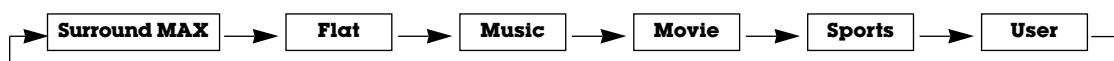
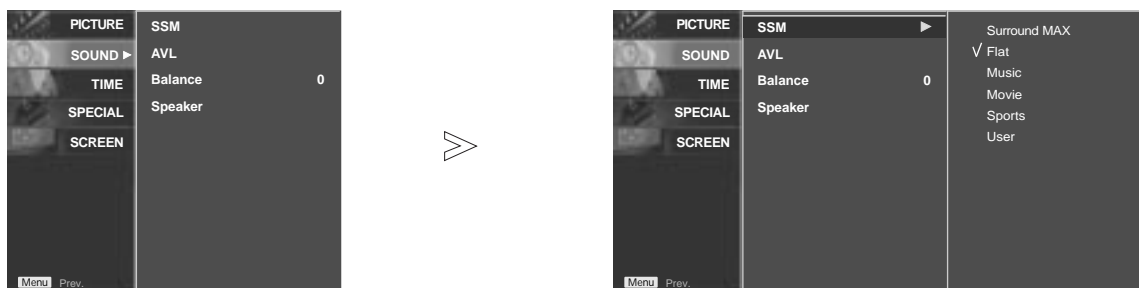

- You can also select **Surround MAX**, **Flat**, **Music**, **Movie**, **Sports** or **User** in the SOUND menu.
- The sound **Surround MAX**, **Flat**, **Music**, **Movie** and **Sports** are programmed for good sound reproduction at the factory and cannot be changed.

-  is a trademark of SRS Labs, Inc.
- TruSurround XT technology is incorporated under license from SRS Labs, Inc.

## AVL (Auto Volume Leveler)

- This feature maintains an equal volume level; even if you change channels.

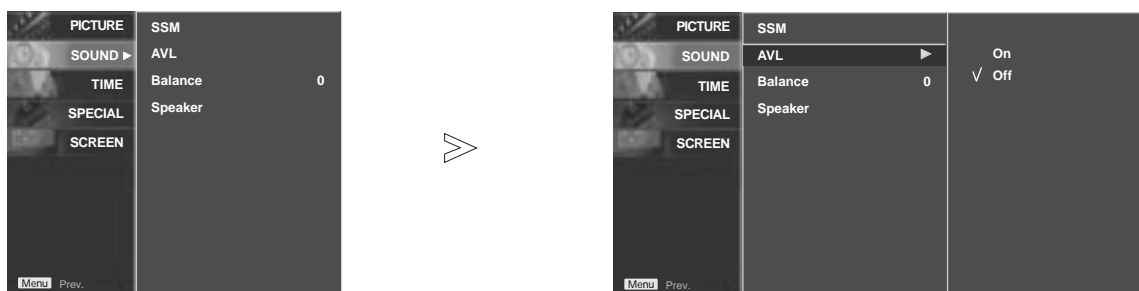

1. Press the **MENU** button and then use **▲ / ▼** button to select the **SOUND** menu.
2. Press the **▶** button and then use **▲ / ▼** button to select **AVL**.
3. Press the **▶** button and then use **▲ / ▼** button to select **On** or **Off**.
4. Press the **EXIT** button to save the new settings.

# Sound Menu Options

## Balance

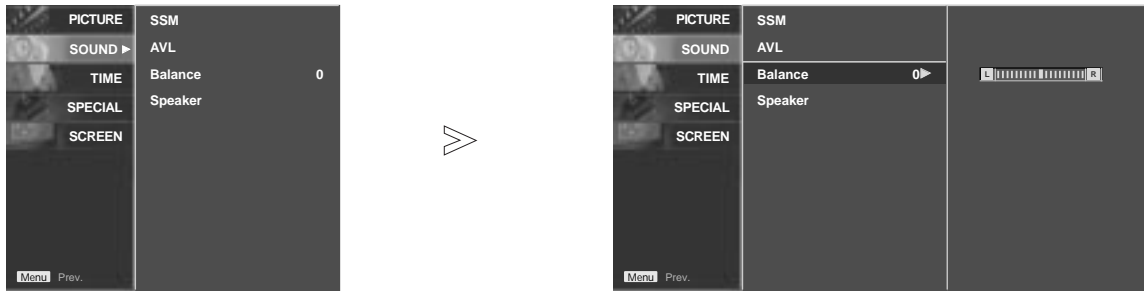

1. Press the **MENU** button and then use **▲ / ▼** button to select the **SOUND** menu.
2. Press the **▶** button and then use **▲ / ▼** button to select **Balance**.
3. Press the **▶** button and then use **◀ / ▶** button to make appropriate adjustments.
4. Press the **EXIT** button to save the new settings.

## Speaker

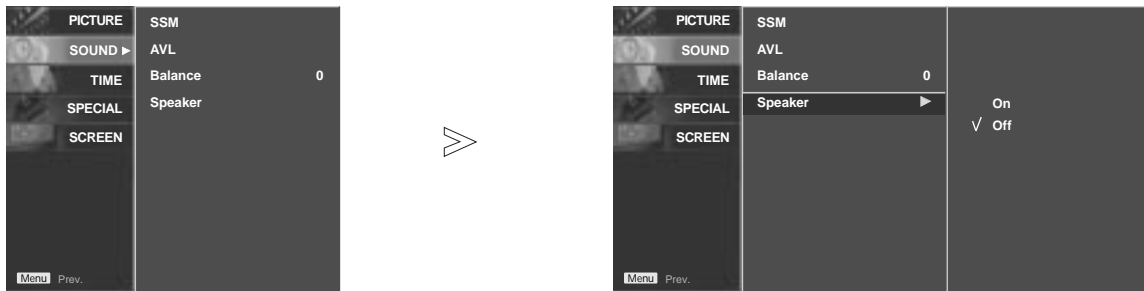

1. Press the **MENU** button and then use **▲ / ▼** button to select the **SOUND** menu.
2. Press the **▶** button and then use **▲ / ▼** button to select **Speaker**.
3. Press the **▶** button and then use **▲ / ▼** button to select **On** or **Off**.
4. Press the **EXIT** button to save the new settings.

# Timer Menu Options

## Clock Setup

- If current time setting is wrong, correct the clock setting.

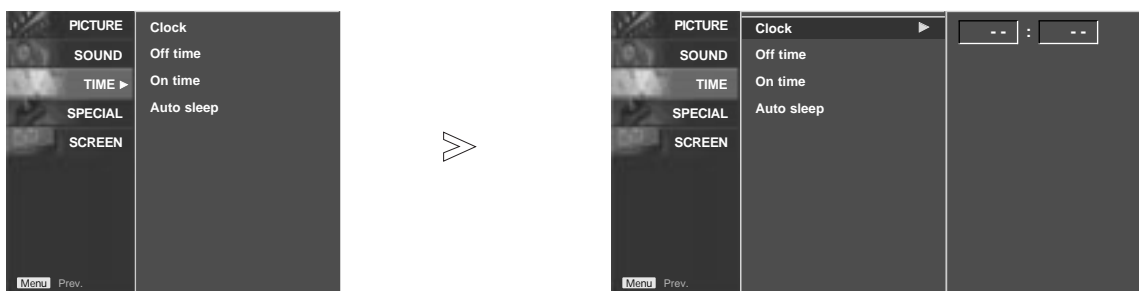

1. Press the **MENU** button and then use **▲ / ▼** button to select the **TIME** menu.
2. Press the **▶** button and then use **▲ / ▼** button to select **Clock**.
3. Press the **▶** button and then use **▲ / ▼** button to set the hour.
4. Press the **▶** button and then use **▲ / ▼** button to set the minutes.
5. Press the **EXIT** button to save the new settings.

## On/Off Time Setup

- Timer function operates only if current time has already been set.
- Off-Time function overrides On-Time function if they are set to the same time.
- If you do not press any button within 2 hours after the monitor turns on with the On Time function, the monitor will automatically revert to standby mode.

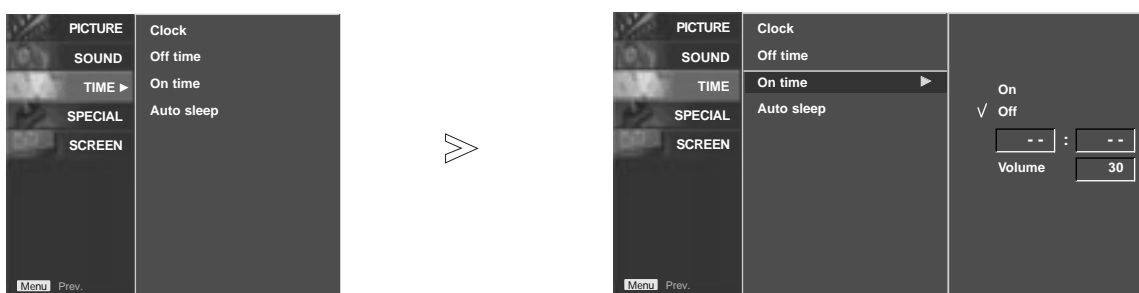

1. Press the **MENU** button and then use **▲ / ▼** button to select the **TIME** menu.
2. Press the **▶** button and then use **▲ / ▼** button to select **Off time** or **On time**.
3. Press the **▶** button and then use **▲ / ▼** button to select **On**.
  - To cancel **On/Off time** function, select **Off**.
4. Press the **▶** button and then use **▲ / ▼** button to set the hour.
5. Press the **▶** button and then use **▲ / ▼** button to set the minutes.
 

**For only On time function;** Press the **▶** button and then use **▲ / ▼** button to set volume level.
6. Press the **EXIT** button to save the new settings.



## Timer Menu Options

### Auto sleep

- If there is no input signal, the Monitor turns off automatically after 10 minutes.

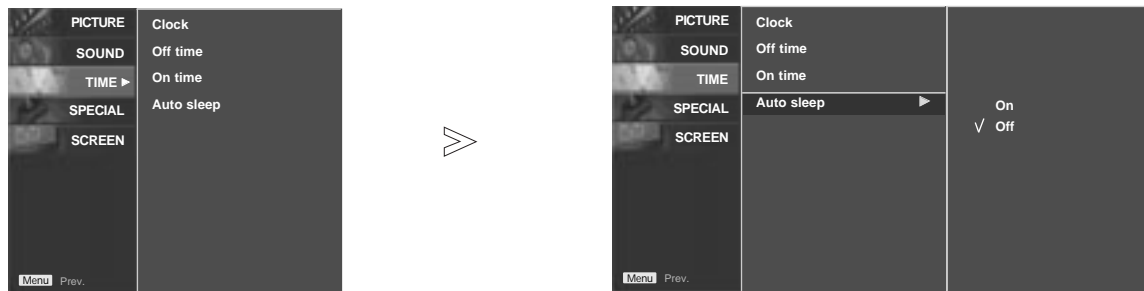

1. Press the **MENU** button and then use **▲ / ▼** button to select the **TIME** menu.
2. Press the **▶** button and then use **▲ / ▼** button to select **Auto sleep**.
3. Press the **▶** button and then use **▲ / ▼** button to select **On** or **Off**.
4. Press the **EXIT** button to save the new settings.

# Special Menu Options

## Child Lock

- The monitor can be set up so that it can only be used with the remote control.
- This feature can be used to prevent unauthorized viewing by disabling the front panel controls.
- This Monitor is programmed to remember which option it was last set to even if you turn the monitor off.

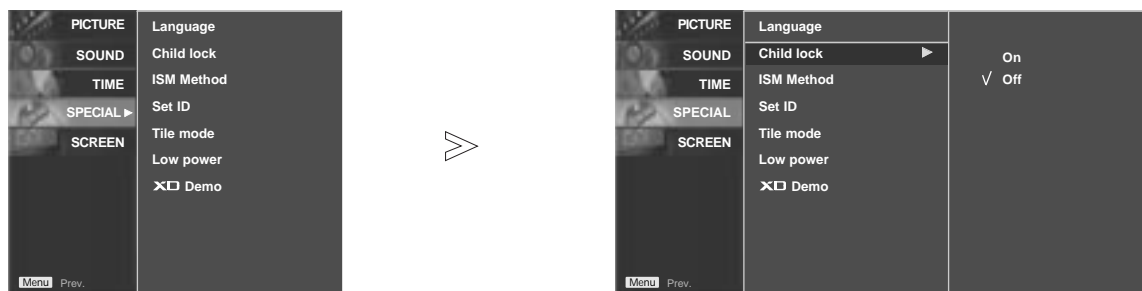

1. Press the **MENU** button and then use **▲ / ▼** button to select the **SPECIAL** menu.
2. Press the **▶** button and then use **▲ / ▼** button to select **Child lock**.
3. Press the **▶** button and then use **▲ / ▼** button to select **On** or **Off**.

- When you select **On**, the display '▲ Child lock On' appears on the screen if any button on the front panel is pressed.

4. Press the **EXIT** button to save the new settings.

-In setting **Child lock 'On'**, if the monitor is turned off with the remote control, press the **⏻ / I, INPUT SELECT** on the monitor or **POWER, INPUT** on the remote control to turn the monitor on.

## ISM (Image Sticking Minimization) Method

- A frozen still picture from a PC/video game displayed on the screen for prolonged periods will result in an ghost image remaining; even when you change the image. Avoid allowing a fixed or still image to remain on the Monitor's screen for a long period of time.

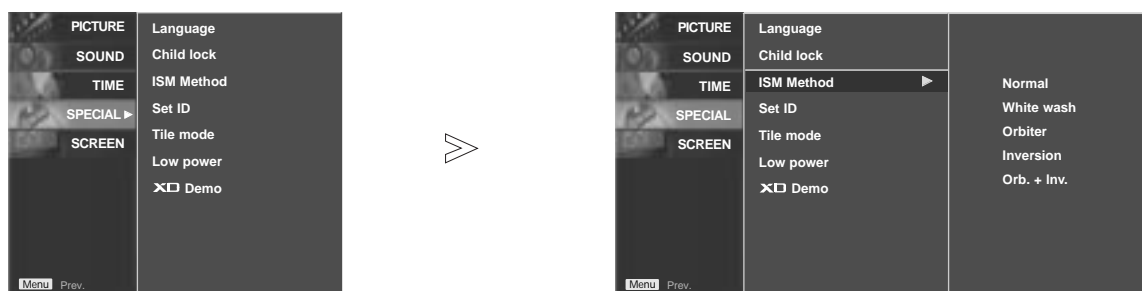

1. Press the **MENU** button and then use **▲ / ▼** button to select the **SPECIAL** menu.
2. Press the **▶** button and then use **▲ / ▼** button to select **ISM Method**.
3. Press the **▶** button and then use **▲ / ▼** button to select either **Normal**, **White wash**, **Orbiter**, **Inversion** or **Orb.+Inv.**

- **Normal**

If image sticking is never a problem, ISM is not necessary - set this to Normal.

- **White wash**

White Wash removes permanent images from the screen. Note: An excessive permanent image may be impossible to clear completely using White Wash. To return to normal viewing, press the any button.

- **Orbiter**

Orbiter may help prevent ghost images. However, it is best not to allow any fixed image to remain on the screen. To avoid a permanent image on the screen, the image will move every 2 minutes.

- **Inversion**

Inversion will automatically invert the plasma display panel colour every 30 minutes.

- **Orb. + Inv.**

This function inverts the panel color of the screen and may help prevent ghost images. The panel color is automatically inverted every 30 minutes and the screen will move every 2 minutes.

4. Press the **EXIT** button to save the new settings.

# Special Menu Options

## Tile mode

- **Tile Mode** Tile mode and choose Tile alignment and set the ID of the current product to set location.

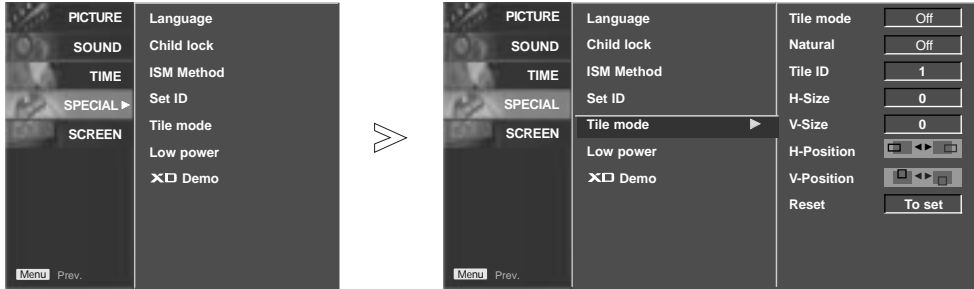

It is used to enlarge the screen and also used with several products to view screen.

- \* Only after pressing the SET button the adjustments made to the settings will be saved.
- Tile mode : row x column ( r = 1, 2, 3, 4 c = 1, 2, 3, 4)
- 4 x 4 available.
- Configuration of an integration screen is also available as well as configuration of One by one Display.



- Tile mode (product 1 ~ 4) : r(2) x c(2)



- Tile mode (product 1 ~ 9) : r(3) x c(3)

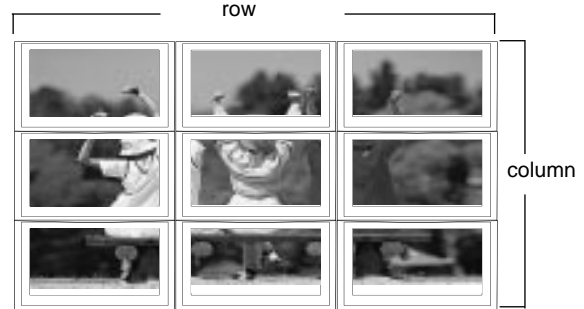

- Tile mode (product 1 ~16) : r(4) x c(4)

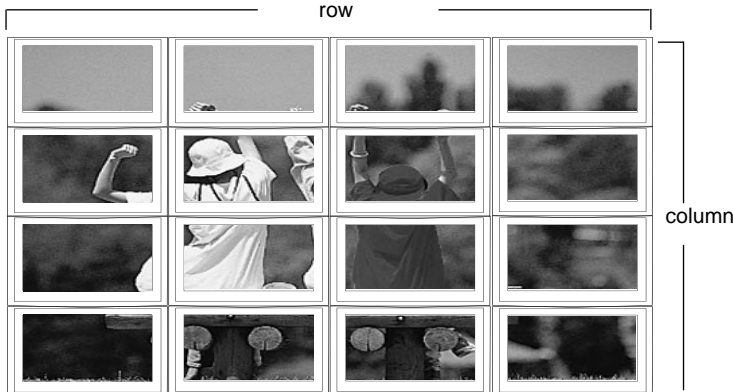

- Tile mode (product 1 ~ 2) : r(2) x c(1)

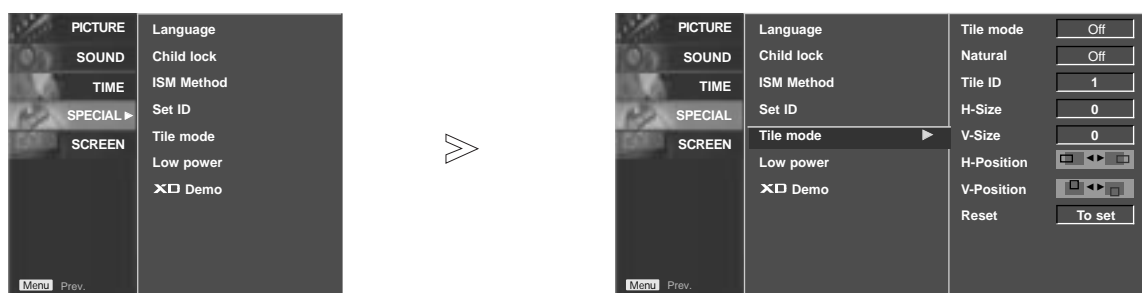
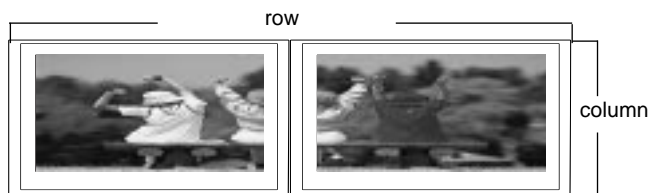

1. Press the **MENU** button and then use **▲ / ▼** button to select the **SPECIAL** menu.
  2. Press the **▶** button and then use **▲ / ▼** button to select **Tile mode**.
  3. Press the **▶** button and then **▲ / ▼** or **◀ / ▶** button to adjust the position.
  4. Press the **EXIT** button to save the new settings.
    - Natural The image is omitted by the distance between the screens to be naturally shown.
    - Tile ID Select the location of the Tile by setting an ID.
    - H Size Adjust the horizontal size of the screen taking into account the size of the bezel.
    - V Size Adjust the vertical size of the screen taking into account the size of the bezel.
    - H-Position Moving the screen position horizontally.
    - V-Position Moving the screen position vertically.
    - Reset Function to initialize and release Tile.
- All Tile setting are released when selecting Tile recall and the screen returns to Full screen.

### Low Power

- Low power reduces the plasma display's power consumption.

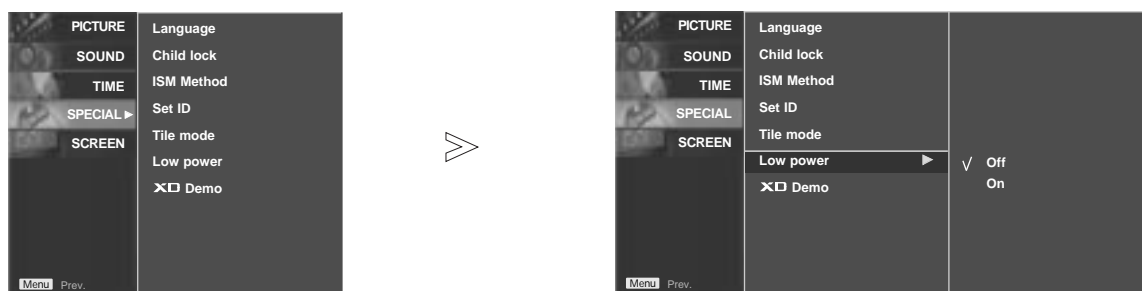

1. Press the **MENU** button and then use **▲ / ▼** button to select the **SPECIAL** menu.
2. Press the **▶** button and then use **▲ / ▼** button to select **Low power**.
3. Press the **▶** button and then use **▲ / ▼** button to select **On** or **Off**.
  - When you select **On**, the screen darkens.
4. Press the **EXIT** button to save the new settings.

## Special Menu Options

### XD DEMO

- Use it to see the difference between XD Demo on and XD Demo off.
- It's not available to use this function in RGB[PC], HDMI[PC] mode.

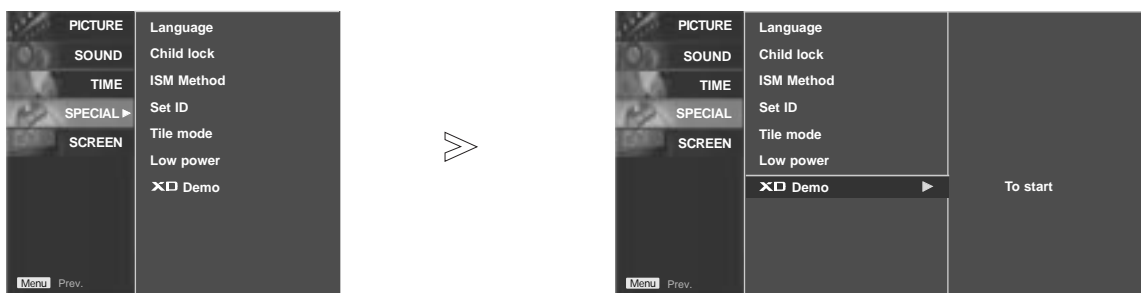

1. Press the MENU button and then ▲ / ▼ button to select the **SPECIAL** menu.
2. Press the ► button and then use ▲ / ▼ button to select **XD Demo**.
3. Press the ► button to begin **XD Demo**.
4. To stop **XD Demo**, press the MENU or EXIT button.

# Screen Menu Options

## Auto Configure

- Automatically adjusts picture position and minimizes image shaking.
- This function works in the following mode : RGB[PC].

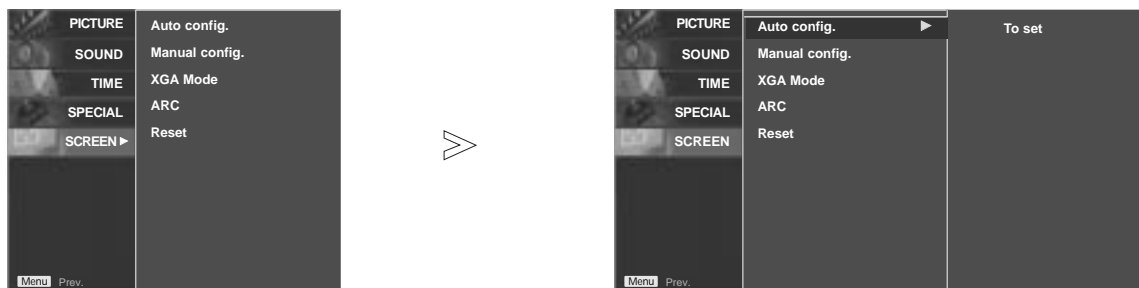

1. Press the **MENU** button and then use **▲ / ▼** button to select the **SCREEN** menu.
2. Press the **▶** button and then use **▲ / ▼** button to select **Auto config.**.
3. Press the **▶** button to start **Auto config.**.
  - When **Auto config.** has finished, **OK** will be shown on screen.
  - If the position of the image is still not correct, try Auto adjustment again.
4. If picture needs to be adjusted more after Auto adjustment in RGB (PC), you can adjust the **Manual config.**.
5. Press the **EXIT** button to save the new settings.

## Manual Configure

- This function works in the following mode:  
RGB[PC], RGB[DTV], HDMI[DTV], COMPONENT[DTV] mode only
- If the picture isn't clear after auto adjustment and especially if characters are still trembling, adjust the picture phase manually (RGB-PC mode only).
- To correct the screen size, adjust **Clock** (RGB-PC mode only).

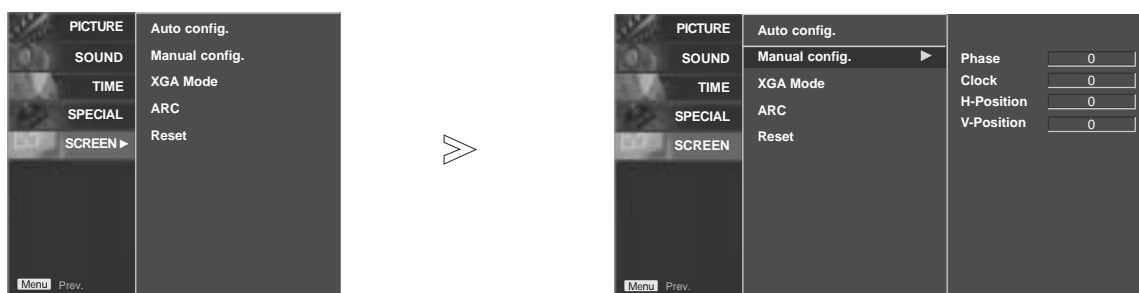

1. Press the **MENU** button and then **▲ / ▼** button to select the **SCREEN** menu.
2. Press the **▶** button and then **▲ / ▼** button to select **Manual config.**.
3. Press the **▶** button and then **▲ / ▼** button to select **Phase**, **Clock**, **H-Position** or **V-Position**.
4. Press the **◀ / ▶** button to make appropriate adjustments.
5. Press the **EXIT** button to save the new settings.

# Screen Menu Options

## Selecting XGA mode

- To see a normal picture, match the resolution of RGB mode and selection of XGA mode.
- This function works in the following mode : RGB[PC]

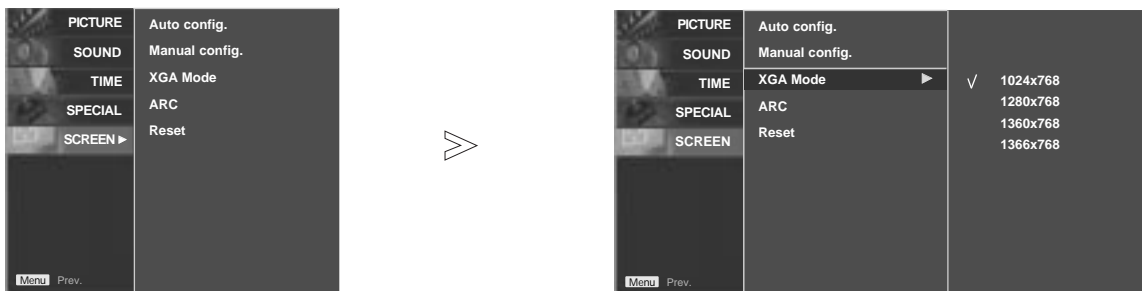

1. Press the **MENU** button and then use **▲ / ▼** button to select the **SCREEN** menu.
2. Press the **▶** button and then use **▲ / ▼** button to select **XGA Mode**.
3. Press the **▶** button and then use **▲ / ▼** button to select the desired XGA resolution.
4. Press the **SET** button.
5. Press the **EXIT** button to save the new settings.

## Setting the Picture Format

- You can watch the screen in various picture formats; **Spectacle, Full, Original, 4:3, 16:9, 1:1, 14:9, Zoom1, Zoom2.**

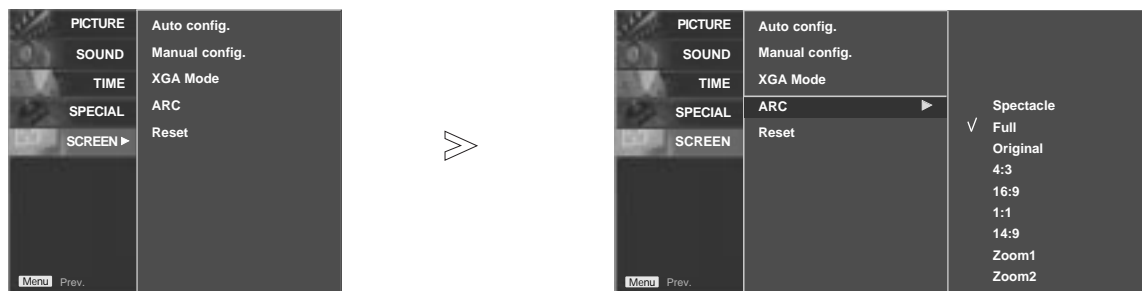

1. Press the **MENU** button and then use **▲ / ▼** button to select the **SCREEN** menu.
2. Press the **▶** button and then use **▲ / ▼** button to select **ARC**.
3. Press the **▶** button and then use **▲ / ▼** button to select **Spectacle, Full, Original, 4:3, 16:9, 1:1, 14:9** or **Zoom 1/2**.

- **Spectacle**

When your AV receives the wide screen signal, it will lead you to adjust the picture horizontally, in a nonlinear proportion, to fill the entire screen.

- **Full**

When your AV receives the wide screen signal, it will lead you to adjust the picture horizontally or vertically, in a linear proportion, to fill the entire screen fully. (Europe an version only)

- **Original**

When your AV receives the wide screen signal, it will be automatically changed to picture format to be sent.

- **4:3**

This picture format is 4:3 of general AV.

- **16:9**

You can enjoy movies (the picture format of 16:9) or general TV programmes through 16:9 mode. Programmes with 16:9 format are viewed naturally but 4:3 programmes are magnified on the left and right so that the screen is 16:9 format.

- **1:1**

This picture format is 1:1 of general AV. (only RGB PC, HDMI/DVI PC)

- **14:9**

You can enjoy the picture format of 14:9 or general AV programmes through 14:9 mode.

Programmes with 14:9 are viewed naturally, but 4:3 programmes are magnified on the top/bottom and left/right sides.

- **Zoom1, 2**

You can enjoy movies on a vast screen through Zoom mode. The 4:3 programmes are magnified on the top/bottom and left/right sides so that screen is 16:9 format. The bottom and top of the picture may be lost.

4. Press the **EXIT** button to save the new settings.

MODE ARC	AV	component	HDMI/DVI		RGB	
			DTV	PC	DTV	PC
Spectacle	O	X	X	X	X	X
Full	O	X	X	X	X	X
Original	O	X	X	X	X	X
4:3	O	O	O	X	O	X
16:9	O	O	O	O	O	O
14:9	O	X	X	X	X	X
Zoom1	O	O	O	X	O	X
Zoom2	O	O	O	X	O	X
1:1	X	X	X	O	X	O

Initializing (Reset to original factory settings)

- This function operates in current mode.
- To initialize the adjusted value

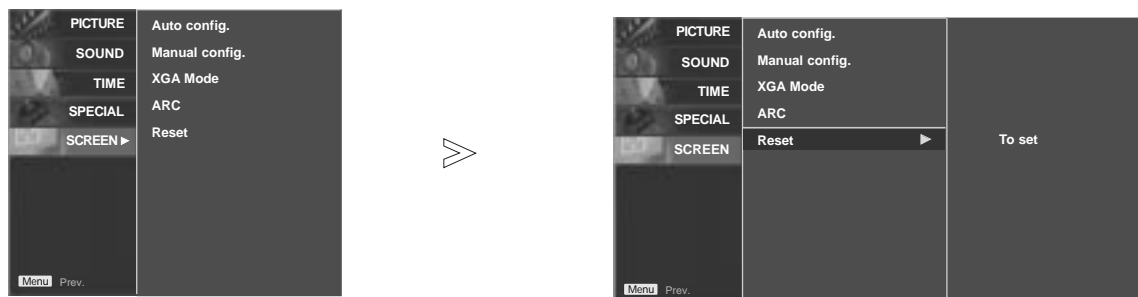

1. Press the **MENU** button and then **▲ / ▼** button to select the **SCREEN** menu.
2. Press the **▶** button and then **▲ / ▼** button to select **Reset**.
3. Press the **▶** button.
  - You can initialize Phase, Clock, H-Position, V-Position (Except ARC).



## External Control Device Setup

- Connect the RS-232C input jack to an external control device (such as a computer or an A/V control system) and control the Monitor's functions externally.
- Connect the serial port of the control device to the RS-232C jack on the Monitor back panel.
- RS-232C connection cables are not supplied with the Monitor.

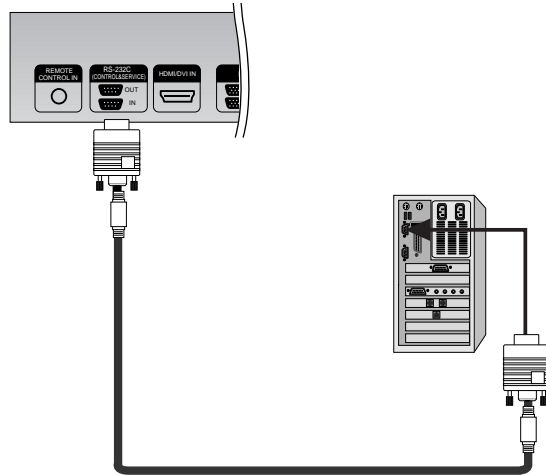

## Set ID

- Use this function to specify a monitor ID number.
- Refer to 'Real Data Mapping 1'. See page 35.

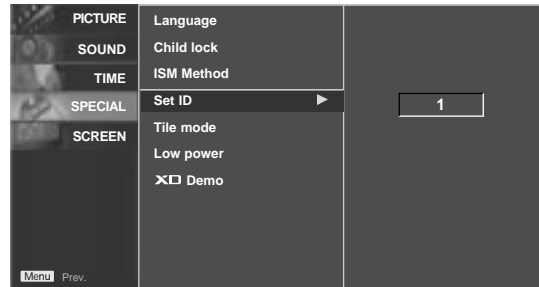
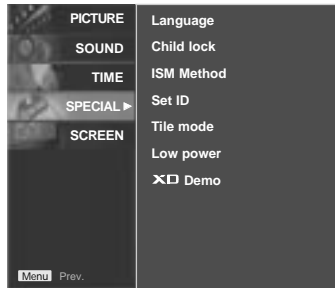

1. Press the **MENU** button and then use the **▲ / ▼** button to select the **SPECIAL** menu.
2. Press the **▶** button and then use **▲ / ▼** button to select **Set ID**.
3. Press the **▶** button and then use **◀ / ▶** button to adjust **Set ID** to choose the desired monitor ID number.
  - The adjustment range of **Set ID** is 1 ~ 99.

## Communication Parameters

- Baud rate : 9600 bps (UART)
- Data length : 8 bits
- Parity : None
- Stop bit : 1 bit
- Communication code : ASCII code
- Use a straight cable.

## Command Reference List

	COMMAND 1	COMMAND 2	DATA (Hexadecimal)
01. Power	k	a	0 ~ 1
02. Input Select	k	b	2 ~ 9
03. Aspect Ratio	k	c	1 ~ 9
04. Screen Mute	k	d	0 ~ 1
05. Volume Mute	k	e	0 ~ 1
06. Volume Control	k	f	0 ~ 64
07. Contrast	k	g	0 ~ 64
08. Brightness	k	h	0 ~ 64
09. Colour	k	i	0 ~ 64
10. Tint	k	j	0 ~ 64
11. Sharpness	k	k	0 ~ 64
12. OSD Select	k	l	0 ~ 1
13. Remote Lock /Key Lock	k	m	0 ~ 1
14. Balance	k	t	0 ~ 64
15. Colour Temperature	k	u	0 ~ 3
16. Abnormal state	k	z	FF
17. ISM mode	j	p	0 ~ 8
18. Auto Configure	j	u	1
19. Key	m	c	Key Code
20. Tile Mode	d	d	0 ~ 44
21. Tile H Size	d	g	0 ~ 64
22. Tile V Size	d	h	0 ~ 64
23. Tile ID Set	d	i	0 ~ 10
24. Natural Mode (In Tile mode)	d	j	0 ~ 1

## Transmission / Receiving Protocol

Transmission

[Command1][Command2][ ][Set ID][ ][Data][Cr]

- \* [Command 1]: k, j, m, d
- \* [Command 2]: To control Plasma Monitor set.
- \* [Set ID]: You can adjust the set ID to choose desired monitor ID number in Special menu. Adjustment range is 1 ~ 99. When selecting Set ID '0', every connected Plasma Monitor set is controlled. Set ID is indicated as decimal (1~99) on menu and as Hexa decimal (0x0~0x63) on transmission/receiving protocol.
- \* [DATA]: To transmit command data.  
Transmit 'FF' data to read status of command.
- \* [Cr]: Carriage Return  
ASCII code '0x0D'
- \* [ ]: ASCII code 'space (0x20)'

OK Acknowledgement

[Command2][ ][Set ID][ ][OK][Data][x]

- \* The Monitor transmits ACK (acknowledgement) based on this format when receiving normal data. At this time, if the data is data read mode, it indicates present status data. If the data is data write mode, it returns the data of the PC computer.

Error Acknowledgement

[Command2][ ][Set ID][ ][NG][Data][x]

- \*\* If there is error, it returns NG

**01. Power (Command 2:a)**

▶ To control Power On/Off of the Monitor.

Transmission

```
[k][a][ ][Set ID][ ][Data][Cr]
```

Data 0 : Power Off                      1 : Power On

Acknowledgement

```
[a][ ][Set ID][ ][OK][Data][x]
```

▶ To show Power On/Off.

Transmission

```
[k][a][ ][Set ID][ ][FF][Cr]
```

Data 0 : Power Off                      1 : Power On

Acknowledgement

```
[a][ ][Set ID][ ][OK][Data][x]
```

\* In a like manner, if other functions transmit 'FF' data based on this format, Acknowledgement data feedback presents status about each function.

**02. Input Select (Command 2:b) (Main Picture Input)**

▶ To select input source for the Monitor.  
You can also select an input source using the INPUT button on the Monitor's remote control.

Transmission

```
[k][b][ ][Set ID][ ][Data][Cr]
```

Data 2 : AV	6 : RGB (DTV)
4 : Component1	7 : RGB (PC)
5 : Component2	8 : HDMI/DVI(DTV)
	9 : HDMI/DVI(PC)

Acknowledgement

```
[b][ ][Set ID][ ][OK][Data][x]
```

Data 2 : AV	6 : RGB (DTV)
4 : Component1	7 : RGB (PC)
5 : Component2	8 : HDMI/DVI(DTV)
	9 : HDMI/DVI(PC)

**03. Aspect Ratio (Command 2:c) (Main picture format)**

▶ To adjust the screen format.  
You can also adjust the screen format using the ARC (Aspect Ratio Control) button on remote control or in the Screen menu.

Transmission

```
[k][c][ ][Set ID][ ][Data][Cr]
```

Data 1 : Normal screen (4:3)  
2 : Wide screen (16:9)  
3 : Horizon (Spectacle)  
4 : Zoom1  
5 : Zoom2  
6 : Original  
7 : 14 : 9  
8 : Full (Europe version only)  
9 : 1 : 1 (PC)

Acknowledgement

```
[c][ ][Set ID][ ][OK][Data][x]
```

**04. Screen Mute (Command 2:d)**

▶ To select screen mute on/off.

Transmission

```
[k][d][ ][Set ID][ ][Data][Cr]
```

Data 0 : Screen mute off (Picture on)  
1 : Screen mute on (Picture off)

Acknowledgement

```
[d][ ][Set ID][ ][OK][Data][x]
```

Data 0 : Screen mute off (Picture on)  
1 : Screen mute on (Picture off)

**05. Volume Mute (Command 2:e)**

▶ To control volume mute on/off.  
You can also adjust mute using the MUTE button on remote control.

Transmission

```
[k][e][ ][Set ID][ ][Data][Cr]
```

Data 0 : Volume mute on (Volume off)  
1 : Volume mute off (Volume on)

Acknowledgement

```
[e][ ][Set ID][ ][OK][Data][x]
```

Data 0 : Volume mute on (Volume off)  
1 : Volume mute off (Volume on)

**06. Volume Control (Command 2:f)**

▶ To adjust volume.  
You can also adjust volume with the volume buttons on remote control.

Transmission

```
[k][f][ ][Set ID][ ][Data][Cr]
```

Data Min : 0 ~ Max : 64  
• Refer to 'Real data mapping1'. See page 35.

Acknowledgement

```
[f][ ][Set ID][ ][OK][Data][x]
```

Data Min : 0 ~ Max : 64

**07. Contrast (Command 2:g)**

- ▶ To adjust screen contrast.  
You can also adjust contrast in the picture menu.

Transmission

```
[k][g][ ][Set ID][ ][Data][Cr]
```

Data Min : 0 ~ Max : 64

- Refer to 'Real data mapping 1' as shown below.

Acknowledgement

```
[g][ ][Set ID][ ][OK][Data][x]
```

Data Min : 0 ~ Max : 64

**\* Real data mapping 1**

```
0 : Step 0
⋮
A : Step 10 (SET ID 10)
⋮
F : Step 15 (SET ID 15)
10 : Step 16 (SET ID 16)
⋮
63 : Step 99 (SET ID 99)
64 : Step 100
```

**08. Brightness (Command 2:h)**

- ▶ To adjust screen brightness.  
You can also adjust brightness in the Picture menu.

Transmission

```
[k][h][ ][Set ID][ ][Data][Cr]
```

Data Min : 0 ~ Max : 64

- Refer to 'Real data mapping 1'.

Acknowledgement

```
[h][ ][Set ID][ ][OK][Data][x]
```

Data Min : 0 ~ Max : 64

**09. Colour (Command 2:i)**

- ▶ To adjust the screen colour.  
You can also adjust colour in the Picture menu.

Transmission

```
[k][i][ ][Set ID][ ][Data][Cr]
```

Data Min : 0 ~ Max : 64

- Refer to 'Real data mapping 1'.

Acknowledgement

```
[i][ ][Set ID][ ][OK][Data][x]
```

Data Min : 0 ~ Max : 64

**10. Tint (Command 2:j) (Video only)**

- ▶ To adjust the screen tint.  
You can also adjust tint in the Picture menu.

Transmission

```
[k][j][ ][Set ID][ ][Data][Cr]
```

Data Red : 0 ~ Green : 64

- Refer to 'Real data mapping 1'.

Acknowledgement

```
[j][ ][Set ID][ ][OK][Data][x]
```

Data Red : 0 ~ Green : 64

**11. Sharpness (Command 2:k)**

- ▶ To adjust the screen sharpness.  
You can also adjust sharpness in the Picture menu.

Transmission

```
[k][k][ ][Set ID][ ][Data][Cr]
```

Data Min : 0 ~ Max : 64

- Refer to 'Real data mapping 1'.

Acknowledgement

```
[k][ ][Set ID][ ][OK][Data][x]
```

Data Min : 0 ~ Max : 64

**12. OSD Select (Command 2:l)**

- ▶ To select OSD (On Screen Display) on/off.

Transmission

```
[k][l][ ][Set ID][ ][Data][Cr]
```

Data 0: OSD off 1: OSD on

Acknowledgement

```
[l][ ][Set ID][ ][OK][Data][x]
```

Data 0: OSD off 1: OSD on

**13. Remote Lock /Key Lock (Command 2:m)**

- ▶ To control Remote Lock on/off to the set.  
This function, when controlling RS-232C, locks the remote control and the local keys.

Transmission

```
[k][m][ ][Set ID][ ][Data][Cr]
```

Data 0: off 1: on

Acknowledgement

```
[m][ ][Set ID][ ][OK][Data][x]
```

Data 0: off 1: on

#### 14. Balance (Command2:t)

► To adjust balance.

Transmission

[k][t][ ][Set ID][ ][Data][Cr]

Data Min: 0 ~ Max: 64

- Refer to 'Real data mapping 1'. See page 35.

Acknowledgement

[t][ ][Set ID][ ][OK][Data][x]

Data Min: 0 ~ Max: 64

\* Balance : L50 ~ R50

#### 15. Colour Temperature (Command2:u)

► To adjust colour temperature.  
You can also adjust ACC in the Picture menu.

Transmission

[k][u][ ][Set ID][ ][Data][Cr]

Data 0: Normal 1: Cool 2: Warm 3: User

Acknowledgement

[u][ ][Set ID][ ][OK][Data][x]

Data 0: Normal 1: Cool 2: Warm 3: User

#### 16. Abnormal state (Command2 : z)

► Abnormal State : Used to Read the power off status when Stand-by mode.

Transmission

[k][z][ ][Set ID][ ][Data][Cr]

Data FF : Read

- 0 : Normal (Power on and signal exist)
- 1: No signal (Power on)
- 2 : Turn the monitor off by remote control
- 3 : Turn the monitor off by sleep time function
- 4 : Turn the monitor off by RS-232C function
- 6 : AC down
- 8 : Turn the monitor off by off time function
- 9 : Turn the monitor off by auto off function

Acknowledgement

[z][ ][Set ID][ ][OK][Data][x]

#### 17. ISM mode(Command: j p)

► Used to select the afterimage preventing function.

Transmission

[j][p][ ][Set ID][ ][Data][Cr]

Data 1 : Inversion

- 2 : Orbiter
- 3 : Orb.+Inv.
- 4 : White Wash
- 8 : Normal

Acknowledgement

[p][ ][Set ID][ ][OK][Data][x]

#### 18. Auto Configure (Command: j u)

► To adjust picture position and minimize image shaking automatically. Auto Configure only works in RGB-PC mode.

Transmission

[j][u][ ][Set ID][ ][Data][Cr]

Data 1: To set

Acknowledgement

[u][ ][Set ID][ ][OK][Data][x]

#### 19. Key (Command: m c)

► To adjust Key code for IR remote control.

Transmission

[m][c][ ][Set ID][ ][Data][Cr]

Data Key code : Refer to See page 39.

Acknowledgement

[c][ ][Set ID][ ][OK][Data][x]

#### 20. Tile Mode(Command : d d)

► Change a Tile Mode.

Transmission

[d][d][ ][Set ID][ ][Data][x]

Data	Description
00	Tile mode is off.
12	1 x 2 mode(column x row)
13	1 x 3 mode
14	1 x 4 mode
...	...
44	4 x 4 mode

\* The data can not be set to 0X or X0 except 00.

Acknowledgement

[d][ ][Set ID][ ][OK][Data][x]

**21. Tile H Size(Command : d g)**

▶ To set the Horizontal size.

Transmission

[d][g][ ][Set ID][ ][Data][x]

Data Min: 0 ~ Max: 64

- Refer to 'Real data mapping 1'. See page 35.

Acknowledgement

[g][ ][Set ID][ ][OK][Data][x]

**22. Tile V Size(Command : d h)**

▶ To set the Vertical size.

Transmission

[d][h][ ][Set ID][ ][Data][x]

Data Min: 0 ~ Max: 64

- Refer to 'Real data mapping 1'. See page 35.

Acknowledgement

[h][ ][Set ID][ ][OK][Data][x]

**23. Tile ID Set (Command : d i)**

▶ To assign the Tile ID for Tiling function .

Transmission

[d][i][ ][Set ID][ ][Data][x]

Data Min: 0 ~ Max: 10

- Refer to 'Real data mapping 1'. See page 35.

Acknowledgement

[i][ ][Set ID][ ][OK][Data][x]

**24. Natural Mode (In Tile mode) (Command : d j)**

▶ The image is omitted by the distance between the screens to be naturally shown.

Transmission

[d][j][ ][Set ID][ ][Data][x]

Data 0 : Natural Off  
1 : Natural On  
ff : Read Status

Acknowledgement

[j][ ][Set ID][ ][OK][Data][x]

# IR Code

## How to Connect

- ▶ Connect your wired remote control to the Remote Control port on the Monitor.

## Remote Control IR Code

### ▶ Output waveform

Single pulse, modulated with 37.917KHz signal at 455KHz

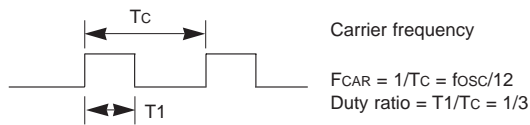

### ▶ Configuration of frame

- 1st frame

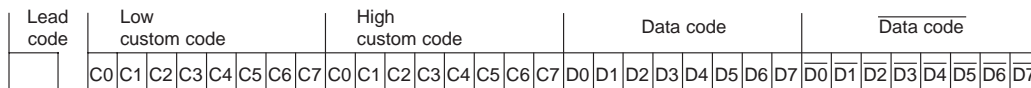

- Repeat frame

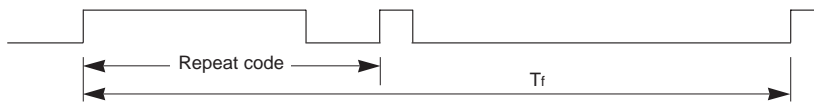

### ▶ Lead code



### ▶ Repeat code

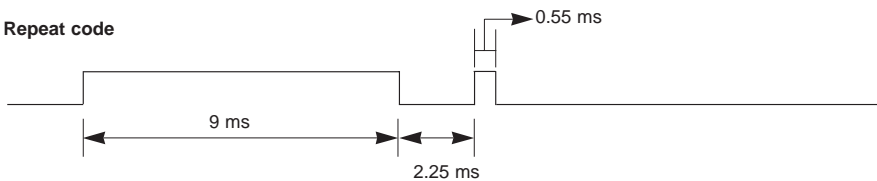

### ▶ Bit description

- Bit "0"

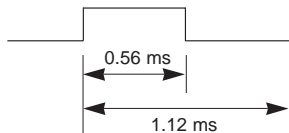

- Bit "1"

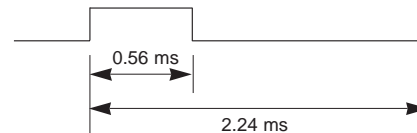

### ▶ Frame interval : Tf

The waveform is transmitted as long as a key is depressed.

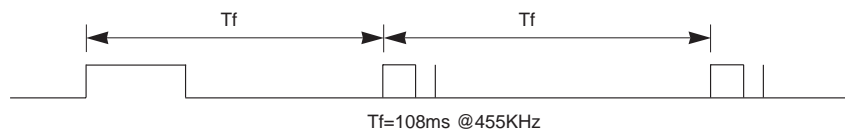

Code (Hexa)	Function	Note
10	Number Key 0	R/C Button
11	Number Key 1	R/C Button
12	Number Key 2	R/C Button
13	Number Key 3	R/C Button
14	Number Key 4	R/C Button
15	Number Key 5	R/C Button
16	Number Key 6	R/C Button
17	Number Key 7	R/C Button
18	Number Key 8	R/C Button
19	Number Key 9	R/C Button
0E	SLEEP	R/C Button
09	MUTE	R/C Button
08	POWER	R/C Button (Power On/Off)
02	VOL+	Discrete IR Code
03	VOL-	Discrete IR Code
44	SET (●)	R/C Button
0B	All INPUT SELECT	R/C Button
43	MENU	R/C Button
79	ARC	R/C Button (Spectacle, Full, Original, 4:3, 16:9, 1:1, 14:9, Zoom1, 2 mode Selection)
07	◀	R/C Button
06	▶	R/C Button
40	▲	R/C Button
41	▼	R/C Button
5B	EXIT	R/C Button
99	Auto config.	Discrete IR Code (Only RGB mode)
5A	Input video	Discrete IR Code (Input Video Selection)
BF	Input Component 1	Discrete IR Code (Input Component 1 Selection)
D4	Input Component 2	Discrete IR Code (Input Component 2 Selection)
D5	Input RGB	Discrete IR Code (Input RGB Selection)
C6	Input HDMI/DVI	Discrete IR Code (Input HDMI/DVI Selection)



## Troubleshooting Checklist

### No picture & No sound

- Check whether the Monitor is turned on.
- Power cord inserted into wall outlet?
- Test the wall power outlet, plug other product's power cord into the wall outlet where the Monitor's power cord was plugged in.

### Picture OK & No sound

- Press the **VOLUME** (▶) button.
- Sound muted? Press **MUTE** button.

### The remote control doesn't work

- Check to see if there is any object between the Plasma Display and the remote control causing obstruction.
- Are batteries installed with correct polarity (+ to +, - to -)?
- Install new batteries.

### Picture appears slowly after switching on

- This is normal, the image is muted during the plasma display startup process. Please contact your service center, if the picture has not appeared after five minutes.

### No or Poor colour or Poor picture

- Select **Colour** in the **Picture** menu and press the ▶ button.
- Keep a sufficient distance between the Monitor and the VCR.
- Activate any function to restore the brightness of the picture. (If still picture is on the screen for more than 5 minutes, the screen gets dark.)

### Horizontal/vertical bars or picture shaking

- Check for local interference such as an electrical appliance or power tool.

### No output from one of the speakers

- Adjust **Balance** in the **Sound** menu.

### Unusual sound from inside the monitor

- A change in ambient humidity or temperature may result in an unusual noise when the plasma display is turned on or off and does not indicate a fault with the monitor.

# Product Specifications

MODELS		42PM4M (42PM4M-WA) (42PM4MA-WA)	50PM4M (50PM4M-WA) (50PM4MA-WA)	60PM4M (60PM4M-WA) (60PM4MA-WA)
Width (inches / mm)		42 / 1066	49.3 / 1253	56.9 / 1455
Height (inches / mm)		25.6 / 650	29.3 / 745	34.8 / 883
Depth (inches / mm)		3.9 / 97.5	4.3 / 109.5	4.5 / 112
Weight (pounds / kg)		62.8 / 28.5	85.5 / 38.8	130.5 / 59.2
Power requirement		AC100-240V~ 50/60Hz 3.3A	AC100-240V~ 50/60Hz 4.5A	AC100-240V~ 50/60Hz 5.8A
Resolution		1024x 768 (Dot)	1365 x 768 (Dot)	1366 x 768 (Dot)
Environmental condition	Operating Temperature	32 ~ 140°F (0 ~ 60°C)		
	Operating Humidity	Less than 80%		
	Storage Temperature	-4 ~ 140°F (-20 ~ 60°C)		
	Storage Humidity	Less than 90%		

- The specifications shown above may change without notice for quality improvement.





