



# PLASMA TV OWNER'S MANUAL

MODELS: DU-50PX41S/51S



Please read this manual carefully and completely before operating your TV.

Retain this manual for future reference.

Record model number and serial number of the TV in the spaces provided below.

See the label attached on the back cover and relate this information to your dealer if you require service.

Model Number :

Serial Number :

# Warning/Caution

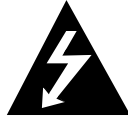

## WARNING/CAUTION:

TO REDUCE THE RISK OF ELECTRIC SHOCK DO NOT REMOVE COVER (OR BACK). NO USER SERVICEABLE PARTS INSIDE. REFER TO QUALIFIED SERVICE PERSONNEL.



The lightning flash with arrowhead symbol, within an equilateral triangle, is intended to alert the user to the presence of uninsulated "dangerous voltage" within the product's enclosure that may be of sufficient magnitude to constitute a risk of electric shock to persons.



The exclamation point within an equilateral triangle is intended to alert the user to the presence of important operating and maintenance (servicing) instructions in the literature accompanying the appliance.

## WARNING/CAUTION:

TO PREVENT FIRE OR SHOCK HAZARDS, DO NOT EXPOSE THIS PRODUCT TO RAIN OR MOISTURE.

## FCC NOTICE

### • A Class B digital device

This equipment has been tested and found to comply with the limits for a Class B digital device, pursuant to Part 15 of the FCC Rules. These limits are designed to provide reasonable protection against harmful interference in a residential installation. This equipment generates, uses and can radiate radio frequency energy and, if not installed and used in accordance with the instructions, may cause harmful interference to radio communications. However, there is no guarantee that interference will not occur in a particular installation. If this equipment does cause harmful interference to radio or television reception, which can be determined by turning the equipment off and on, the user is encouraged to try to correct the interference by one or more of the following measures:

- Reorient or relocate the receiving antenna.
- Increase the separation between the equipment and receiver.
- Connect the equipment into an outlet on a circuit different from that to which the receiver is connected.
- Consult the dealer or an experienced radio/TV technician for help.

### • Any changes or modifications not expressly approved by the party responsible for compliance could void the user's authority to operate the equipment.

## CAUTION:

Do not attempt to modify this product in any way without written authorization from LG Electronics. Unauthorized modification could void the user's authority to operate this product.

## COMPLIANCE:

The responsible party for this product's compliance is:  
LG Electronics U.S.A., Inc  
1000 Sylvan Avenue, Englewood Cliffs, NJ 07632  
1-201-816-2000  
<http://www.lgusa.com>

## WARNING/CAUTION

TO REDUCE THE RISK OF FIRE AND ELECTRIC SHOCK, DO NOT EXPOSE THIS PRODUCT TO RAIN OR MOISTURE.

---

# TV Guide On Screen Notices for U.S.A.

In the United States, the TV Guide On Screen system and other related marks are registered marks of Gemstar-TV Guide On Screen system International, Inc. and/or one of its affiliates. In Canada, TV Guide On Screen system is a registered mark of Transcontinental Inc., and is used under license by Gemstar-TV Guide On Screen system International, Inc.

The TV Guide On Screen system is manufactured under license from Gemstar-TV Guide On Screen system International, Inc. and/or one of its affiliates.

The TV Guide On Screen system is protected by one or more of the following issued United States patents 6,498,895, 6,418,556, 6,331,877; 6,239,794; 6,154,203; 5,940,073; 4,908,713; 4,751,578; 4,706,121.

Use of the CableCARD™ TradeMark.

“CableCARD™ is a trademark of Cable Television Laboratories, Inc.”

## Digital Cable Compatibility

This digital television is capable of receiving basic analog, digital basic and digital premium cable television programming by direct connection to a cable system providing such programming. A security card provided by your cable operator is required to view encrypted digital programming. Certain advanced interactive digital cable services such as video-on-demand, cable operator enhanced program (For example, electronic program guide provided by the cable operator), and data enhanced television service may require the use of a set top box. For more information contact your local cable operator.

# Safety Instructions

## IMPORTANT SAFETY INSTRUCTIONS

Important safety instructions shall be provided with each apparatus. This information shall be given in a separate booklet or sheet, or be located before any operating instructions in an instruction for installation for use and supplied with the apparatus. This information shall be given in a language acceptable to the country where the apparatus is intended to be used. The important safety instructions shall be entitled "Important Safety Instructions". The following safety instructions shall be included where applicable, and, when used, shall be verbatim as follows. Additional safety information may be included by adding statements after the end of the following safety instruction list. At the manufacturer's option, a picture or drawing that illustrates the intent of a specific safety instruction may be placed immediately adjacent to that safety instruction :

1. Read these instructions.
2. Keep these instructions.
3. Heed all warnings.
4. Follow all instructions.
5. Do not use this apparatus near water.
6. Clean only with dry cloth.
7. Do not block any ventilation openings. Install in accordance with the manufacturer's instructions.
8. Do not install near any heat sources such as radiators, heat registers, stoves, or other apparatus (including amplifiers) that produce heat.
9. Do not defeat the safety purpose of the polarized or grounding-type plug. A polarized plug has two blades with one wider than the other. A grounding type plug has two blades and a third grounding prong. The wide blade or the third prong are provided for your safety. If the provided plug does not fit into your outlet, consult an electrician for replacement of the obsolete outlet.
10. Protect the power cord from being walked on or pinched particularly at plugs, convenience receptacles, and the point where they exit from the apparatus.
11. Only use attachments/accessories specified by the manufacturer.
12. Use only with the cart, stand, tripod, bracket, or table specified by the manufacturer, or sold with the apparatus. When a cart is used, use caution when moving the cart/apparatus combination to avoid injury from tip-over.



## Safety Instructions continued

13. Unplug this apparatus during lightning storms or when unused for long periods of time.

14. Refer all servicing to qualified service personnel. Servicing is required when the apparatus has been damaged in any way, such as power-supply cord or plug is damaged, liquid has been spilled or objects have fallen into the apparatus, the apparatus has exposed to rain or moisture, does not operate normally, or has been dropped.

15. CAUTION concerning the Power Cord :

Most appliances recommend they be placed upon a dedicated circuit; that is, a single outlet circuit which powers only that appliance and has no additional outlets or branch circuits. Check the specification page of this owner's manual to be certain.

Do not overload wall outlets. Overloaded wall outlets, loose or damaged wall outlets, extension cords, frayed power cords, or damaged or cracked wire insulation are dangerous. Any of these conditions could result in electric shock or fire. Periodically examine the cord of your appliance, and if its appearance indicates damage or deterioration, unplug it, discontinue use of the appliance, and have the cord replaced with an exact replacement part by an authorized servicer.

Protect the power cord from physical or mechanical abuse, such as being twisted, kinked, pinched, closed in a door, or walked upon. Pay particular attention to plugs, wall outlets, and the point where the cord exits the appliance.

16. Outdoor Use Marking :

**WARNING - To Reduce The Risk Of Fire Or Electric Shock, Do Not Expose This Appliance To Rain Or Moisture.**

17. Wet Location Marking :

Apparatus shall not be exposed to dripping or splashing and no objects filled with liquids, such as vases, shall be placed on the apparatus.

# Contents

Warning/Caution .....	2	TV Speakers On/Off Setup .....	66
Digital Cable Compatibility .....	3	Stereo/SAP Broadcasts Setup .....	66
Safety Instructions .....	4~5	Time Menu Options .....	
<b>Introduction</b>		Auto Clock Setup .....	67
Controls .....	8	Manual Clock Setup .....	67
Connection Options .....	9	On/Off Timer Setup .....	67
Remote Control Key Functions .....	10~11	Sleep Timer / Auto Off .....	68
<b>Installation</b>		Option Menu Features .....	
Installation Instructions .....	13~14	Aspect Ratio Control .....	69
Joining the TV assembly to the wall to protect the set tumbling .....	13	Cinema 3:2 Mode Setup .....	69
Arrangement wires .....	13	Caption .....	70
External Equipment Connections .....	15~20	Caption / Text .....	70
Antenna or Cable Connection .....	15~16	Caption Option .....	71
VCR Setup .....	16	ISM Method .....	72
External A/V Source Setup .....	17	Low Power .....	73
DVD Setup .....	17	Auto Demo .....	73
CableCARD™ Setup .....	18	Freeze & Magnify .....	73
HDSTB Setup .....	18	Lock Menu Options .....	
PC Setup .....	19	Parental Lock Setup .....	75
Monitor Out Setup .....	20	CableCARD™ Function .....	
Digital Audio Output .....	20	Cable menu options .....	76
HDMI1/DVI (VIDEO), HDMI2 .....	21~23	Scrambled channel .....	76
TV Guide On Screen Setup .....	24~33	Cable Channel List .....	77
<b>IEEE 1394</b> .....	34~38	Emergency Alert Message .....	77
<b>TV Guide On Screen™ System</b> .....	39~57	Remote Control .....	
<b>Operation</b>		PIP (Picture-in-Picture)/Twin Picture .....	78
Screen Setup for PC mode .....		Watching PIP/POP/Twin Picture .....	78
Adjustments for screen Position, Size, and Phase ..	58	Selecting an Input Signal Source for PIP/Twin Picture ..	78
On-screen Menus Language Selection .....	59	Swapping PIP/Twin Picture .....	78
Setup Menu Options .....		TV Program Selection for PIP .....	78
EZ Scan (Channel Search) .....	60	Moving the PIP sub picture .....	79
Manual Scan .....	60	Adjusting Main and Sub Picture Sizes for Twin Picture ..	79
Channel Edit .....	61	POP (Picture-out-of-Picture: Channel Scan) ..	79
DTV Signal Strength .....	61	X STUDIO .....	80~82
Channel Label Setup .....	62	Brief Info. ....	83
Main Picture Source Selection .....	62	EZ Mute .....	84
Input Edit .....	62	<b>External Control Device Setup</b> .....	85~90
Video Menu Options .....		<b>IR Codes</b> .....	91~92
EZ Picture .....	63	<b>Programming the Remote</b> .....	93
Manual Picture Control (Custom Option) .....	63	<b>Programming Codes</b> .....	94~95
Color Temperature Control .....	63	<b>Troubleshooting Checklist</b> .....	96
Video Preset .....	63	<b>Maintenance</b> .....	97
Audio Menu Options .....		<b>Product Specifications</b> .....	98
Audio Language .....	64	<b>Warranty</b> .....	99~100
EZ SoundRite / EZ Sound .....	64		
Manual Sound Control (Custom Option) .....	64		
Front Surround .....	65		
BBE .....	65		

## Setup and Operation Checklist

### Setup and Operation Checklist

(See pages 13~20 for available connection and operational setup options.)

1. Unpack TV and all accessories.
2. Connect all external video and audio equipment.  
see pages 15~20.
3. Install batteries in remote control.  
See page 12.
4. Turn TV on.  
See page 59.
5. Turn video source equipment on.
6. Select viewing source for TV.  
See pages 62.
7. Fine-tune source image and sound to your personal preference or as required by source.  
See pages 63~ 66.
8. Additional features set up  
See Contents above.

After reading this manual, keep it handy for future reference.

# Introduction

## What is a Plasma Display Panel (PDP)?

A plasma display panel is the latest display technology and the best way to achieve flat panel displays with excellent image quality and large screen sizes that are easily viewable. The PDP can be thought of as a descendant of the neon lamp and it can be also be viewed as a series of fluorescent lamps.

## How does it work?

PDP is an array of cells, known as pixels, which are comprised of 3 sub pixels, corresponding to the colors red, green, and blue. Gas in a plasma state is used to react with phosphors in each sub-pixel to produce colored light (red, green, or blue). These phosphors are the same types used in Cathode Ray Tube (CRT) devices such as televisions and common computer monitors.

You get the rich, dynamic colors that you expect. Each sub-pixel is individually controlled by advanced electronics to produce over 16 million different colors. All of these mean that you get perfect images that are easily viewable in a display that is less than 5 inches thick.

## 160° - Wide angle range of vision

Your flat panel plasma screen offers an exceptionally broad viewing angle -- over 160 degrees. This means that the display is clear and visible to viewers anywhere in the room who can see the screen.

## Wide Screen

The screen of the Plasma Display is so wide that your viewing experience is as if you are in a theater.

## Multimedia

Connect your plasma display to a PC and you can use it for conferencing, games, and Internet browsing. The Picture-in-Picture feature allows you to view your PC and video images simultaneously.

## Versatile

The light weight and thin size makes it easy to install your plasma display in a variety of locations where conventional TVs will not fit.

## The PDP Manufacturing Process: a few minute colored dots may be present on the PDP screen

The PDP (Plasma Display Panel), which is the display device of this product, is composed of 0.9 to 2.2 million cells. A few cell defects will normally occur in the PDP manufacturing process. Several tiny, minute colored dots visible on the screen should be acceptable. This also occurs in other PDP manufacturers' products. The tiny dots appearing does not mean that this PDP is defective. Thus a few cell defects are not sufficient cause for the PDP to be exchanged or returned. Our production technology minimizes these cell defects during the manufacture and operation of this product.

## Cooling Fan Noise

In the same way that a fan is used in a PC computer to keep the CPU (Central Processing Unit) cool, the PDP is equipped with cooling fans to cool the Monitor and improve its reliability. Therefore, a certain level of noise could occur while the fans are operating and cooling the PDP.

The fan noise doesn't have any negative effect on the PDP's efficiency or reliability. The noise from these fans is normal during the operation of this product. We hope you understand that a certain level of noise from the cooling fans is acceptable and is not sufficient cause for the PDP to be exchanged or returned.

# Controls

- This is a simplified representation of front panel.  
Here shown may be somewhat different from your TV.

## Front Panel Controls

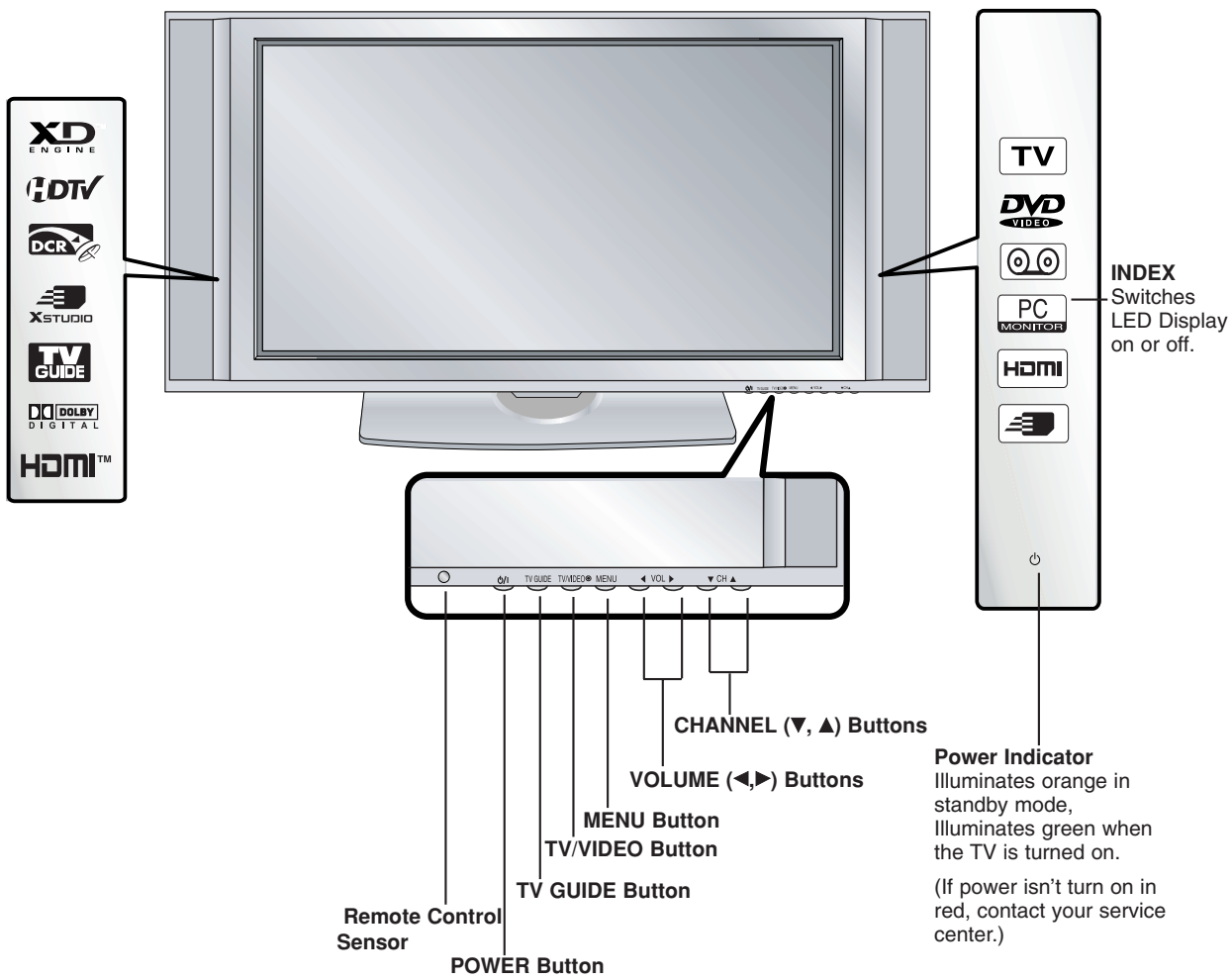



# Connection Options

## Back Connection Panel

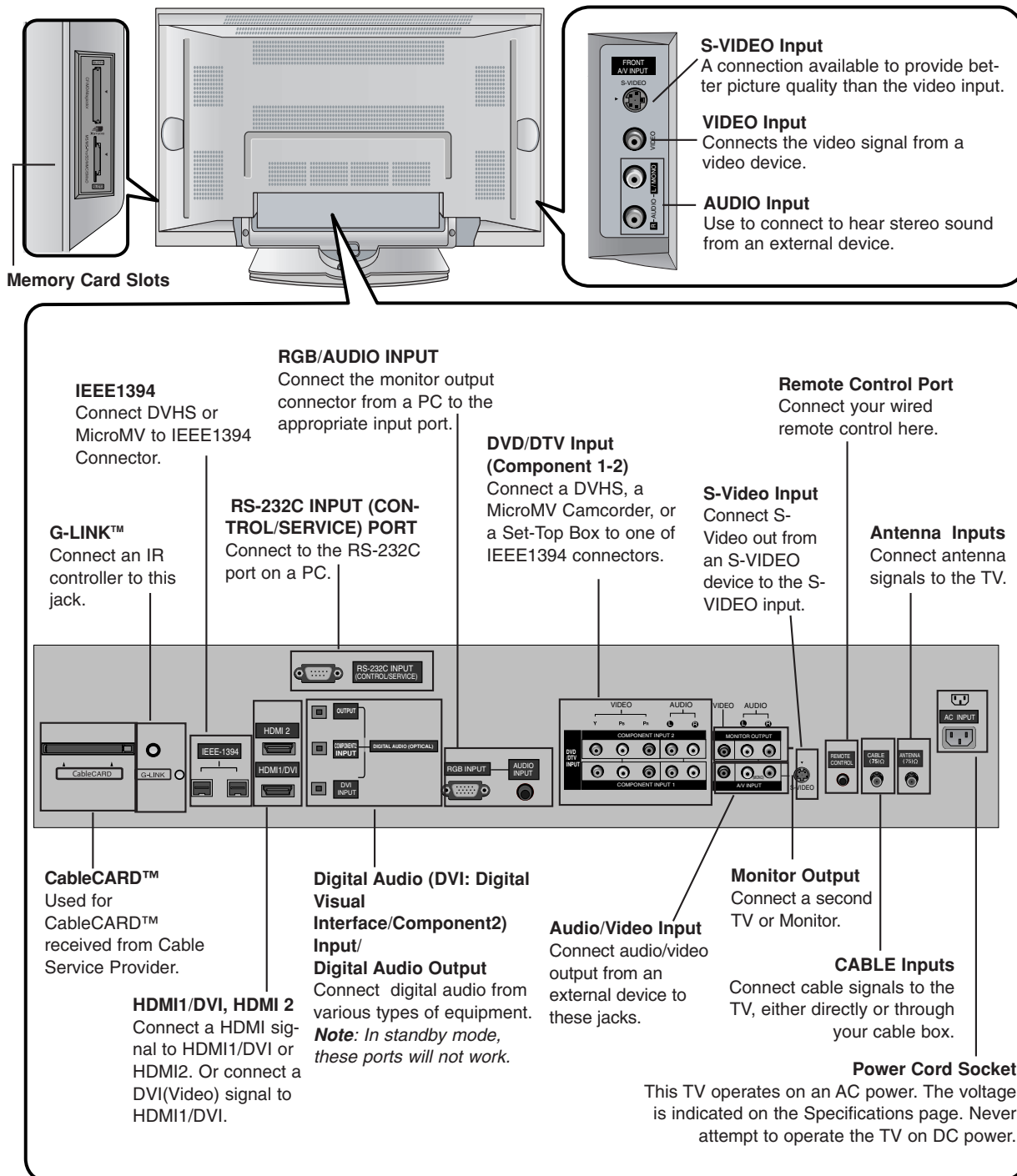

# Remote Control Key Functions

- When using the remote control, aim it at the remote control sensor on the TV.

**TV INPUT**  
When you watch the TV, Antenna and Cable is toggled. In Video, Front Video, Component 1-2, RGB-DTV (or RGB-PC), HDMI1/DVI, HDMI2 and IEEE1394 input sources, screen return to the last TV channel.

**MODE**  
Selects the remote operating mode: TV, DVD, VCR, AUDIO, CABLE or STB. Select a mode other than TV, for the remote to operate an external device.

**MENU**  
Brings up the main menu to the screen. Enters or exits a Panel Menu in the TV Guide On Screen system.

**EXIT**  
Clears all on-screen displays and returns to TV viewing from any menu.

**MUTE**  
Switches the sound on or off. (Refer to p.84)

**TIMER**  
Lets you select the amount of time before your TV turns itself off automatically.

**ADJUST**  
Adjusts screen position, size, and phase in PC mode.

**EZ PIC**  
Selects a factory preset picture mode depending on the viewing environment.

**FREEZE**  
Freezes the currently-viewed picture. Main picture is frozen in PIP/Twin picture mode.

**AUTO DEMO**  
Displays the slide show to explain the main features of this TV.

**TV/VIDEO**  
When you watch the TV, screen return to the last external ( Video, Front Video, Component 1-2, RGB-DTV (or RGB-PC), HDMI1/DVI, HDMI2) input. Selects: Video, Front Video, Component 1-2, RGB-DTV (or RGB-PC), HDMI1/DVI and HDMI2 input sources. (Only when the jack connects , Video, Front Video, Component 1-2 input sources are linked automatically)

**TV GUIDE**  
Brings up the TV Guide On Screen system to the screen.

**INFO**  
When you watch the TV, information displays on top of the screen. Not available in Component 1-2, RGB, HDMI1/DVI and fHDMI2 mode. (Refer to p.83)

**Mark**  
Selects a photo or music you want to view or play in Xstudio mode.

**FAV**  
Scroll the Favorite channels.

**FLASHBK**  
Tunes to the recent channels.

**PIP**  
Switches between PIP, POP (Picture-out-of-Picture) and Twin picture modes. Switches the video window locking or unlocking in the Listings Grid.

**PIPCH-/PIPCH+**  
Changes to the next higher/lower PIP channel.

**PIP INPUT**  
Selects the input source for the sub picture in PIP/Twin picture mode.

**SWAP**  
Exchanges the main/sub images in PIP/Twin picture mode.

# Remote Control Key Functions

- When using the remote control, aim it at the remote control sensor on the TV.

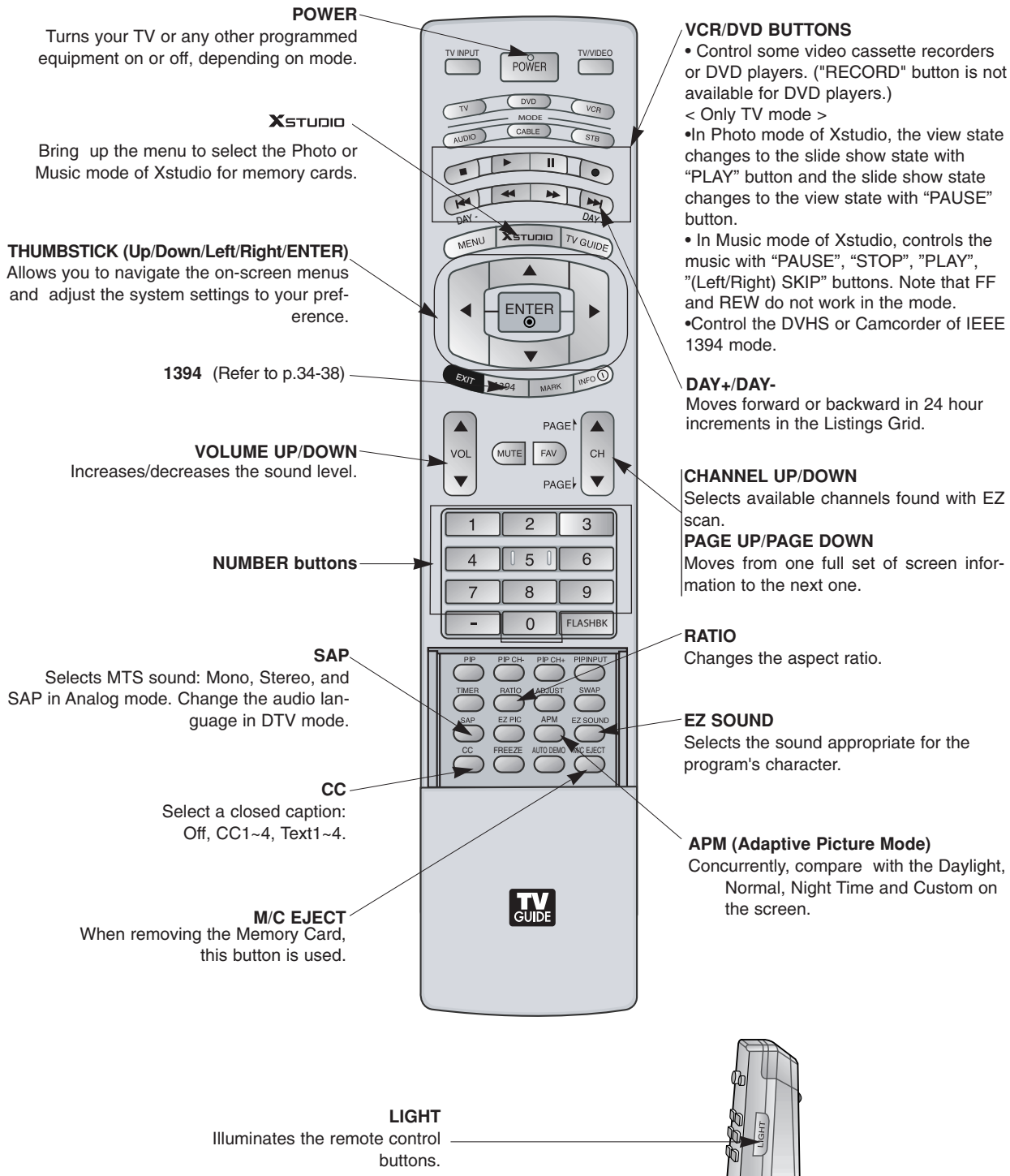

# Installation

Ensure that the following accessories are included with your plasma display. If an accessory is missing, please contact the dealer where you purchased the product.

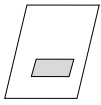

Owner's Manual

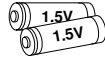

Batteries



Power Cord



75Ω Round Cable



Remote Control



2-Wall brackets



2-TV bracket bolts



G-LINK Cable

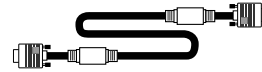

D-sub 15 pin Cable

## Installing Batteries

- Open the battery compartment cover on the back side and install the batteries matching correct polarity (+ with +, - with -).
- Install two 1.5V AA batteries. Don't mix old or used batteries with new ones. Replace cover.

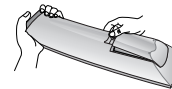

## Joining the TV assembly to the wall to protect the set tumbling

- Secure the TV assembly by joining it to a wall by using the TV/Wall brackets.

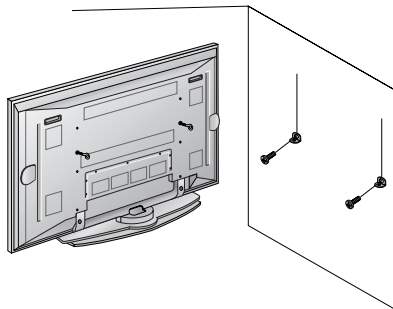

- After the set must be mounted on the desk top, install the TV brackets on the TV as shown.  
Install the TV brackets on the TV as shown. Insert the 2 bolts and tighten securely, in the upper holes on the bracket.  
Install the wall brackets on the wall with 4 bolts\*, (not supplied with the product), as shown.  
Match the height of the TV brackets and the wall brackets.  
Check to be sure the brackets are tightened securely.

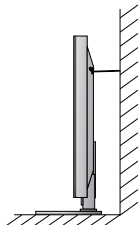

- Secure the TV assembly to the wall with strong strings or wound wire cables, (not supplied with the product), as shown.

---

# Installation Instructions

## Swivel function

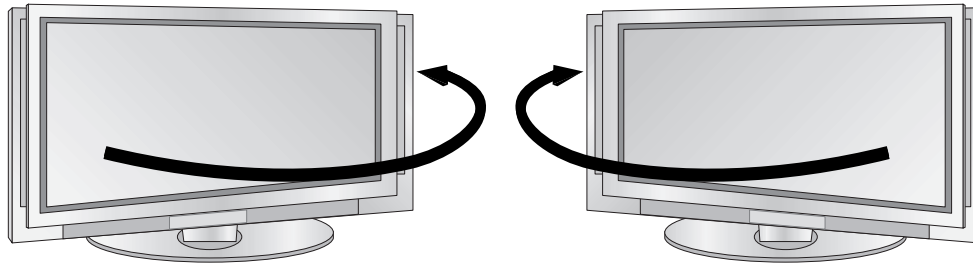

- After installing the TV, you can adjust the the TV set manually to the left or right direction by 20 degrees to suit your viewing position.

*Note: Before adjusting the angle, you must loosen (to the left) the shaft bolt on the middle of stand's back.  
And when stand be level with TV, you must close (to the right) the shaft bolt to set the hole.*

## Arrangement wires

- Run the accessory device wires inside the JACK MANAGEMENT pole as shown.

# Installation Instructions

- The TV can be installed in various ways such as on a wall, or on a desktop etc.
- The TV is designed to be mounted horizontally.

## GROUNDING

Ensure that you connect the grounding / earth wire to prevent possible electric shock. If grounding methods are not possible, have a qualified electrician install a separate circuit breaker. Do not try to ground the unit by connecting it to telephone wires, lightning rods, or gas pipes.

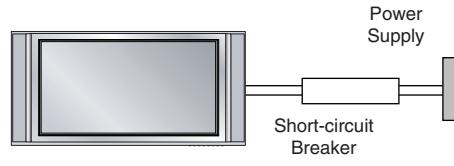

## Wall Mount: Horizontal installation

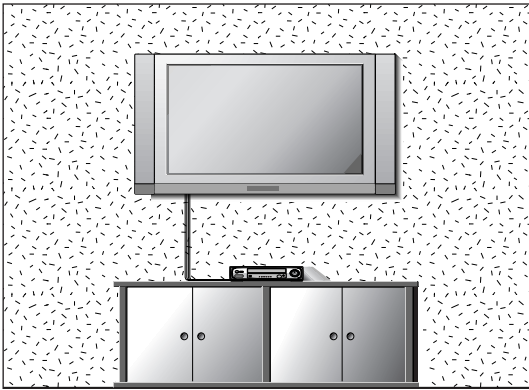

For proper ventilation, allow a clearance of 4" on each side and 2" from the wall. Detailed installation instructions are available from your dealer, see the optional Wall Mounting Bracket Installation.

## Desktop Pedestal Installation

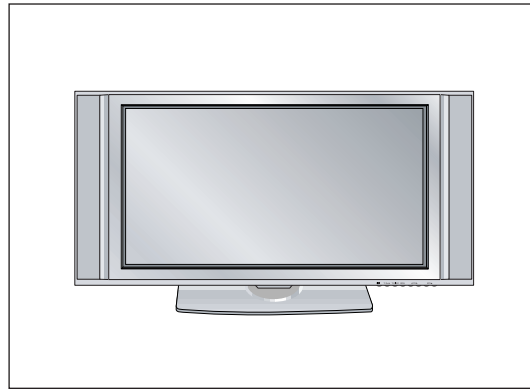

For proper ventilation, allow a clearance of 4" on each side and the top, 2.36" on the bottom, and 2" from the wall. Detailed installation instructions are included in the optional Desktop Stand Installation.

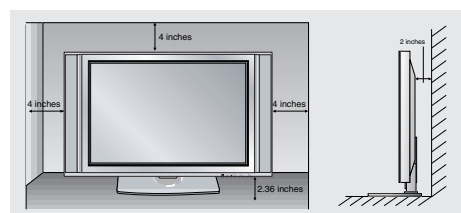
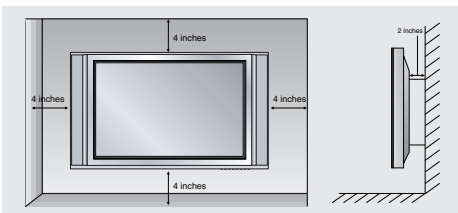

# External Equipment Connections

## Antenna or Cable Connection

### 1. Analog and Digital TV signals provided on antenna

- Wall Antenna Socket or Outdoor Antenna without a Cable Box Connections
- For optimum picture quality, adjust antenna direction if needed.

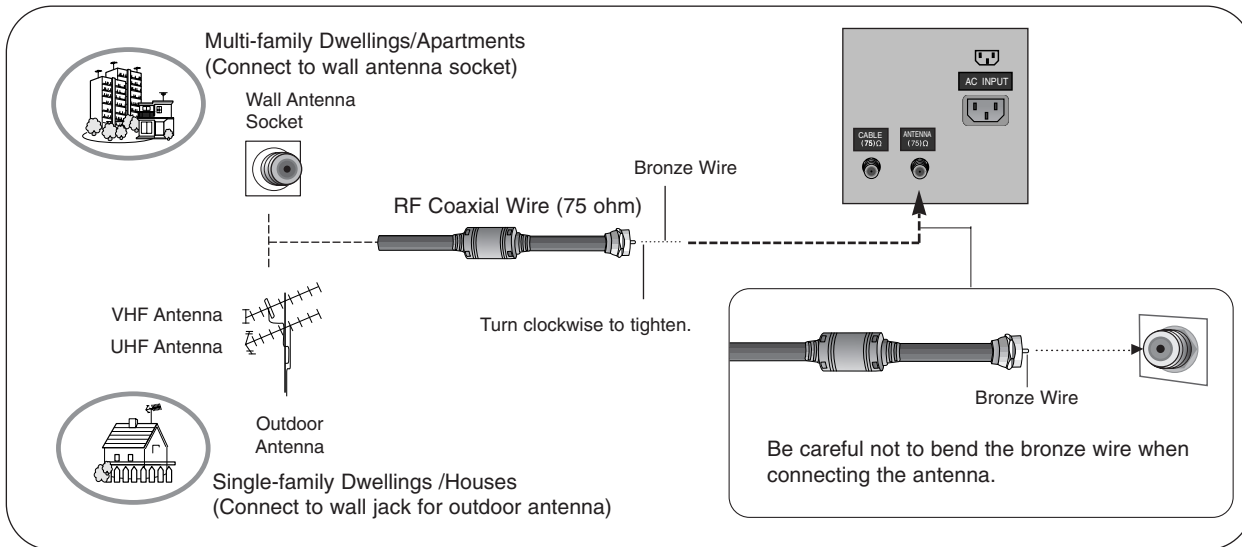

### 2. Analog and Digital TV signals provided on cable

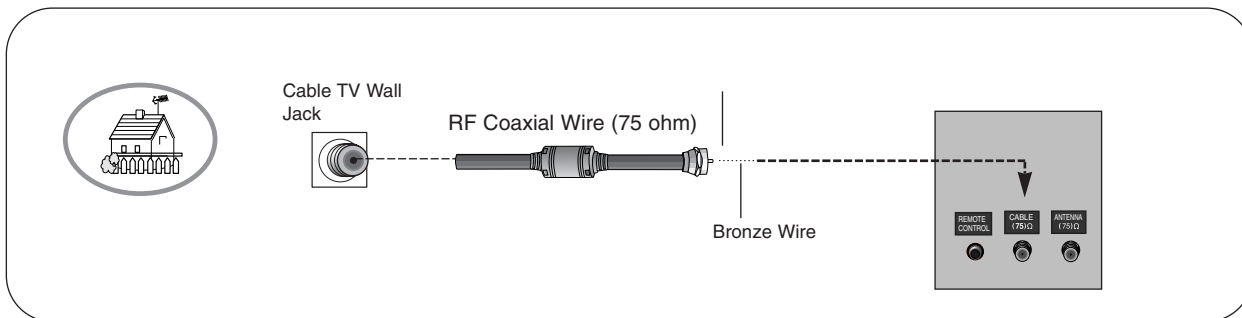

### 3. Analog and Digital TV signals provided on cable and antenna

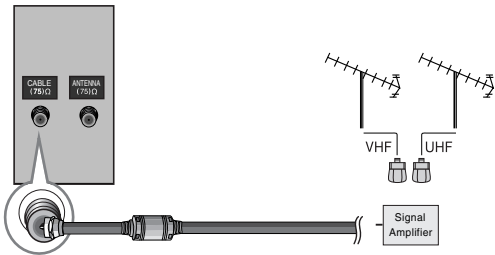
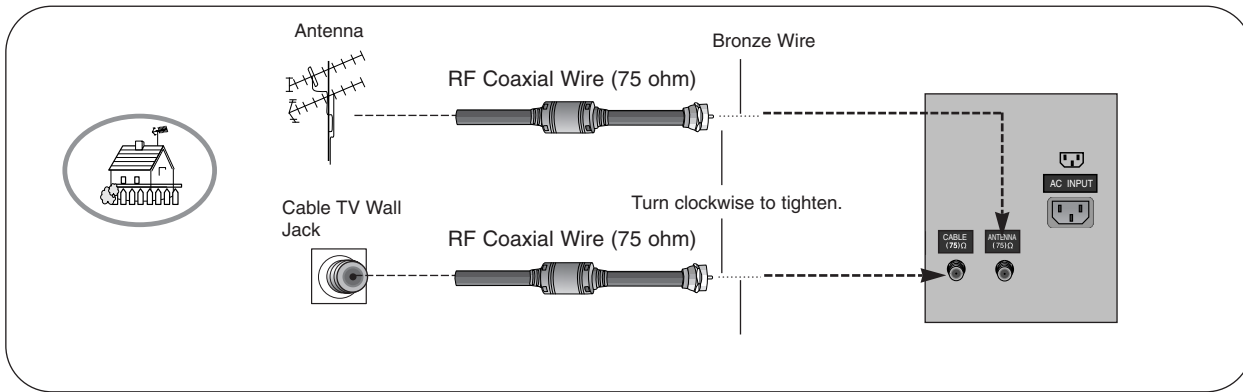

- In a poor signal area to improve picture quality, purchase and install a signal amplifier.
- If the antenna needs to be split for two TV's, install a "2-Way Signal Splitter" in the connections.
- If the antenna is not installed properly, contact your dealer for assistance.

#### VCR Setup

- To avoid picture noise (interference), leave an adequate distance between the VCR and TV
- Use the ISM Method (on the Option menu) feature to avoid having a fixed image remain on the screen for a long period of time. If the 4:3 picture format is used; the fixed images on the sides of the screen may remain visible on the screen.

#### Connection Option 1

Set VCR output switch to channel 3 or 4 and then tune the TV to the same channel number.

#### Connection Option 2

1. Connect the audio and video cables from the VCR's output jacks to the TV input jacks, as shown in the figure. When connecting the TV to VCR, match the jack colors (Video = yellow, Audio Left = white, and Audio Right = red). If you connect an S-VIDEO output from VCR to the S-VIDEO input, the picture quality is improved; compared to connecting a regular VCR to the Video input.
2. Insert a video tape into the VCR and press PLAY on the VCR. (Refer to the VCR owner's manual.)
3. Select the input source with using the **TV/VIDEO** button on the remote control. Note that this TV finds the connected input sources automatically for Video, Front Video and Component 1-2. It is presumed that RGB, HDMI1/DVI and HDMI2 sources are connected.

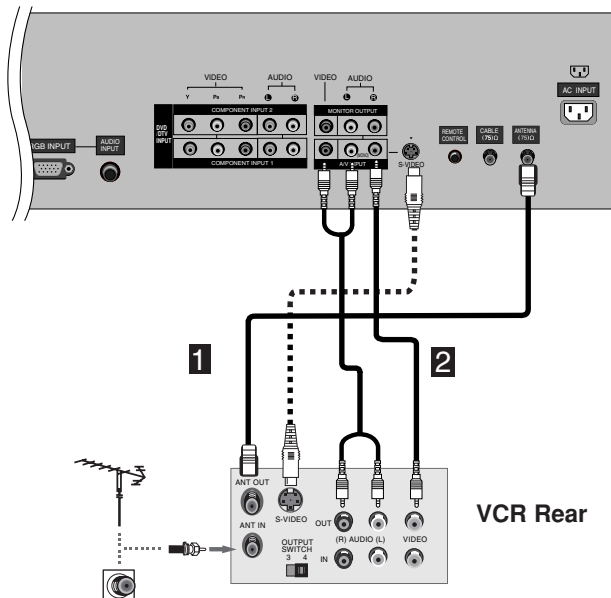

Do not connect to both Video and S-Video at the same time.



## External A/V Source Setup

### How to connect

Connect the audio and video cables from the external equipment's output jacks to the TV input jacks, as shown in the figure.

When connecting the TV to external equipment, match the jack colors (Video = yellow, Audio Left = white, and Audio Right = red).

### How to use

1. Select the input source with using the **TV/VIDEO** button on the remote control. Note that this TV finds the connected input sources automatically for Video 1-2 and Component 1-2. It is presumed that RGB, HDMI1/DVI and HDMI2 sources are connected.
2. Operate the corresponding external equipment. Refer to external equipment operating the tv guide on screen system.

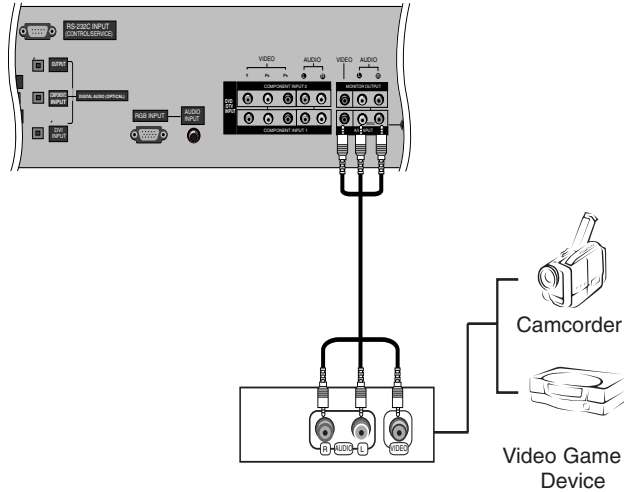

## DVD Setup

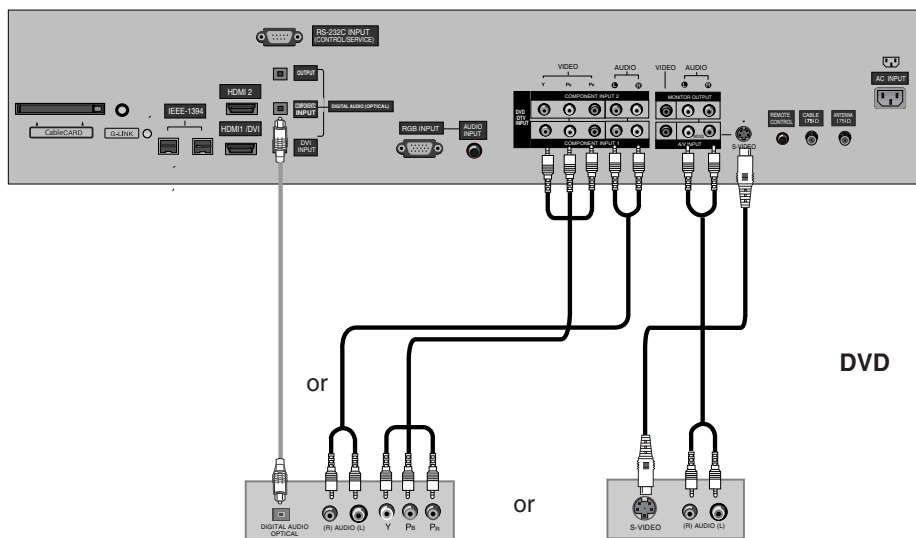

### How to connect

1. Connect the DVD video outputs (Y, Pb, Pr) to the COMPONENT (Y, Pb, Pr) INPUT jacks on the TV and connect the DVD audio outputs to the AUDIO INPUT jacks on the TV, as shown in the figure.
2. If your DVD only has an S-Video output jack, connect this to the S-VIDEO input on the TV and connect the DVD audio outputs to the AUDIO INPUT jacks on the TV, as shown in the figure.

**Note:** If your DVD player does not have component video output, use S-Video.

### How to use

1. Turn on the DVD player, insert a DVD.
2. Use the **TV/VIDEO** button on the remote control to select **Component 1** or **Component 2**. (If connected to S-VIDEO, select the **Video** or **Front Video** external input source.)
3. Refer to the DVD player's manual for operating instructions.

### Component Input ports

To get better picture quality, connect a DVD player to the component input ports as shown below.

Component ports on the TV	Y	P <sub>B</sub>	P <sub>R</sub>
Video output ports on DVD player	Y	P <sub>b</sub>	P <sub>r</sub>
	Y	B-Y	R-Y
	Y	Cb	Cr
	Y	P <sub>B</sub>	P <sub>R</sub>

### Notes:

- Digital Audio will not work for Component 1 input source.
- Digital Audio operation has priority if Digital Audio and AUDIO L/R are connected at the same time.

**CableCARD™ Setup**

**How to use**

Insert the CableCARD™ received from the cable service provider to the CableCARD™ slot of TV back panel.  
 If the pairing information about this TV and the CableCARD is automatically displayed on the screen, contact with the cable service provider by phone.

**Note :**  
 • CableCARD™ have the types of Motorola, Scientific Atlanta, SCM etc..  
 These 3 types of CableCARD™ can be used for this PLASMA TV.

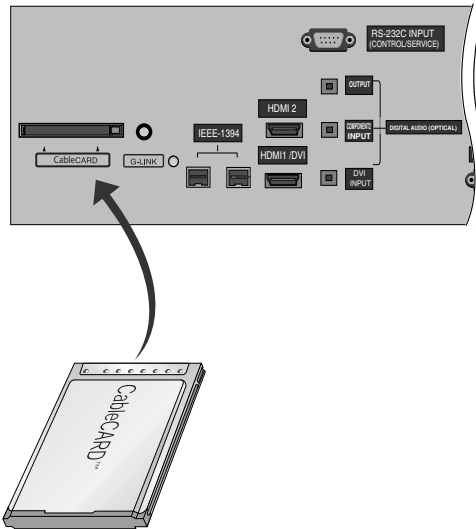

**Caution:** When removing the CableCARD™, do not fall it as this may cause impact to the CableCARD™.

**HDSTB Setup**

- This TV can receive Digital Over-the-air/Cable signals without an external digital set-top box. However, if you do receive Digital signals from a digital set-top box or other digital external device, refer to the figure as shown below.
- This TV supports HDCP (High-bandwidth Digital Contents Protection) protocol for Digital Contents (480p,720p,1080i).

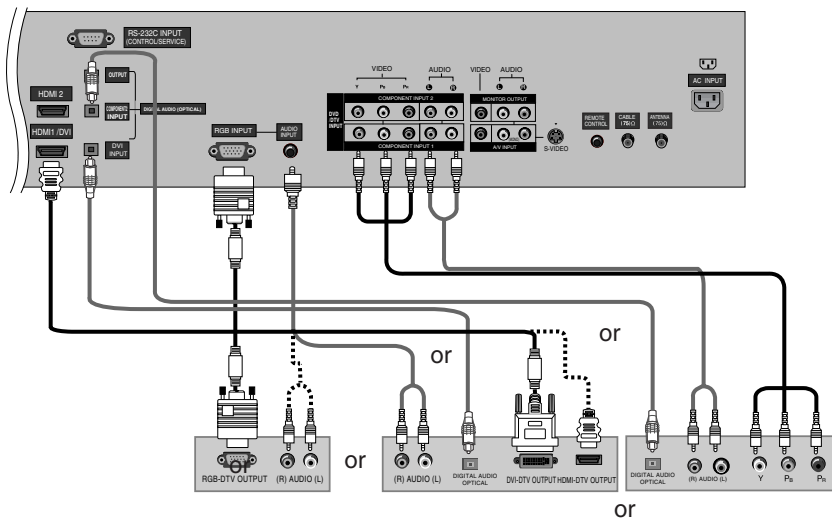

Digital Set-top Box

**How to connect**

Use the TV's COMPONENT (Y, Pb, Pr) INPUT, RGB, HDMI1/DVI or HDMI2 jack for video connections, depending on your set-top box connector. Then, make the corresponding audio connections.

**How to use**

1. Turn on the digital set-top box. (Refer to the owner's manual for the digital set-top box.)
2. Use TV/VIDEO on the remote control to select **Component 1**, **Component 2**, **RGB-DTV**, or **HDMI/DVI** source.

Signal	Component 1/2	RGB-DTV,HDMI1/DVI,HDMI2
480i	Yes	No
480p	Yes	Yes
720p	Yes	Yes
1080i	Yes	Yes

## PC Setup

- This TV provides Plug and Play capability, meaning that the PC adjusts automatically to the TV's settings.
- The TV perceives 640x480, 60Hz as DTV 480p based on the PC graphic card, change the screen scanning rate for the graphic card accordingly.

### <When the PC supports DVI>

#### How to connect

1. Connect the PC to HDMI1/DVI port of this TV with an HDMI-to-DVI cable(not supplied with this product).  
If you do not need to connect audio, HDMI2 port is also available for the DVI video connection.
2. If the PC(or the sound card of the PC) has a fiber optic digital audio output connector, connect the PC's audio output to DIGITAL AUDIO(OPTICAL) port for DVI INPUT.
3. If the PC(or the sound card of the PC) has an analog audio output connector, connect the PC's audio output to AUDIO INPUT port located on the right side of RGB INPUT port.

#### How To Use

1. To get the best picture quality, adjust the PC graphics card to 1024x768, 60Hz.
2. Select HDMI1/DVI input source in main input option of SETUP menu.(Refer to P.62)  
**TV/VIDEO** button is also available for this purpose.
3. Check the image on your TV. There may be noise associated with the resolution, vertical pattern, contrast or brightness in PC mode. If noise is present, change the PC output to another resolution, change the refresh rate to another rate or adjust the brightness and contrast on the VIDEO menu until the picture is clear. If the refresh rate of the PC graphic card can not be changed, change the PC graphic card or consult the manufacturer of the PC graphic card.

### <When the PC supports RGB>

#### How to connect

1. Connect the PC to RGB INPUT port of this TV with a RGB cable.
2. If the PC(or the sound card of the PC) has an analog audio output connector, connect the PC's audio output to AUDIO INPUT port located on the right side of RGB INPUT port.

#### How To Use

1. To get the best picture quality, adjust the PC graphics card to 1024x768, 60 Hz.
2. Select **RGB-PC** input source in main input option of SETUP menu.(Refer to P.57)  
Once you select **RGB-PC** in main input option of SETUP menu, **TV/VIDEO** button is also available for this purpose.
3. Check the image on your TV. There may be noise associated with the resolution, vertical pattern, contrast or brightness in PC mode. If noise is present, change the PC output to another resolution, change the refresh rate to another rate or adjust the brightness and contrast on the VIDEO menu until the picture is clear. If the refresh rate of the PC graphic card can not be changed, change the PC graphic card or consult the manufacturer of the PC graphic card.

### Monitor Display Specifications (RGB-PC )

Resolution	Horizontal Frequency(KHz)	Vertical Frequency(Hz)	Resolution	Horizontal Frequency(KHz)	Vertical Frequency(Hz)
720x400	31.469	70.08	800x600	35.156	56.25
	37.927	85.03		37.879	60.31
640x480	31.469	59.94		48.077	72.18
				46.875	75.00
	37.861	72.80		53.674	85.06
	37.500	75.00		1024x768	48.363
	43.269	85.00	56.476		70.06
			60.023	75.02	

### Monitor Display Specifications (HDMI/DVI Mode)

Resolution	Horizontal Frequency(KHz)	Vertical Frequency(Hz)	Resolution	Horizontal Frequency(KHz)	Vertical Frequency(Hz)
640x480	31.469	59.94	1024x768	48.363	60.00
	37.861	72.80		56.476	70.06
	37.500	75.00		60.023	75.02
800x600	35.156	56.25			
	37.879	60.31			
	48.077	72.18			
	46.875	75.00			

### Monitor Out Setup

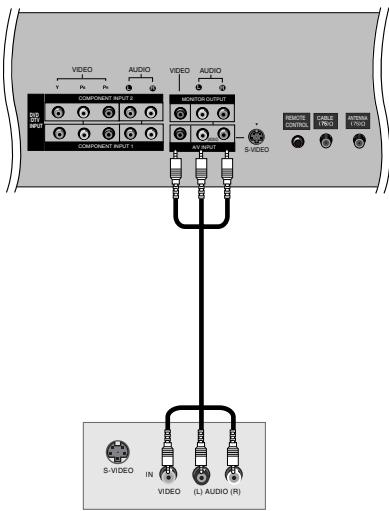

The TV has a special signal output capability which allows you to hook up a second TV or monitor.

Connect the second TV or monitor to the TV's MONITOR OUTPUT. See the Operating Manual of the second TV or monitor for further details regarding that device's input settings.

**Note**

- Component, RGB-PC/RGB-DTV, HDMI1/DVI, HDMI2, DTV input sources cannot be used for Monitor out.

### Digital Audio Output

Send the TV's audio to external audio equipment (stereo system) via the Digital Audio Output (Optical) port.

**How to connect**

1. Connect one end of an optical cable to the TV Digital Audio (Optical) Output port.
2. Connect the other end of the optical cable to the digital audio (optical) input on the audio equipment.
3. Set the "TV Speaker" option - **Off** in the AUDIO menu. Refer to page 65. See the external audio equipment instruction manual for operation.



**Caution:** Do not look into the optical output port. Looking at the laser beam may damage your vision.

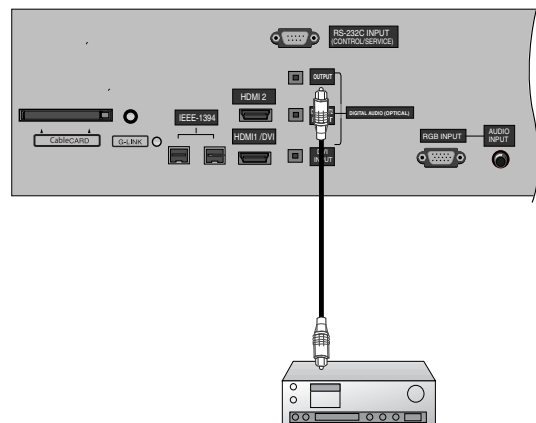

## HDMI / DVI (VIDEO).HDMI2



- HDMI™, the HDMI logo and High-Definition Multimedia Interface are trademarks or registered trademarks of HDMI Licensing LLC."
- This TV can receive the High-Definition Multimedia Interface(HDMI) or the Digital Visual Interface(DVI).
- This TV supports HDCP(High-bandwidth Digital Contents Protection) Protocol for 720x480p, 1280x720p, and 1920x1080i resolution.
- When you connect this TV with a source device(DVD player, Set Top Box or PC) supporting Auto HDMI/DVI function, the output resolution of the source device will be automatically set to 1280x720p.
- If the source device does not support Auto HDMI/DVI, you need to set the output resolution appropriately.  
To get the best picture quality, adjust the DVD Player or Set Top Box's output resolution to 1280x720p, and the PC graphics card's output resolution to 1024x768, 60Hz.
- If the source device has an HDMI output, no other audio connection is necessary because HDMI-to-HDMI connection includes both video and audio.
- If the source device has a DVI output and no HDMI output, a separated audio connection is necessary.

## &lt;When the source device(DVD player or Set Top Box) supports HDMI&gt;

**How To Connect**

1. Connect the source device to HDMI1/DVI or HDMI2 port of this TV with an HDMI cable(not supplied with this product).
2. No separated audio connection is necessary.

**How To Use**

- If the source device supports Auto HDMI function, the output resolution of the source device will be automatically set to 1280x720p.
- If the source device does not support Auto HDMI, you need to set the output resolution appropriately.  
To get the best picture quality, adjust the output resolution of the source device to 1280x720p.
- Select HDMI1/DVI or HDMI2 input source in main input option of SETUP menu.(Refer to P.62)  
TV/VIDEO button is also available for this purpose.

## &lt;When the source device(DVD player or Set Top Box) supports DVI&gt;

**How To Connect**

1. Connect the source device to HDMI1/DVI port of this TV with a HDMI-to-DVI cable(not supplied with this product).  
Do not use HDMI2 port for DVI connection if you want to connect audio.
2. A separated audio connection is necessary.
3. If the source device has a fiber optic digital audio output, connect the audio output to DIGITAL AUDIO(OPTICAL) port for DVI INPUT.
4. If the source device has an analog audio output connector, connect the PC's audio output to AUDIO INPUT port located on the right side of RGB INPUT port.

**How To Use**

- If the source device supports Auto DVI function, the output resolution of the source device will be automatically set to 1280x720p.
- If the source device does not support Auto DVI, you need to set the output resolution appropriately.  
To get the best picture quality, adjust the output resolution of the source device to 1280x720p.
- Select HDMI1/DVI input source in main input option of SETUP menu.(Refer to P.62)  
TV/VIDEO button is also available for this purpose.

## Reference

### Cable sample

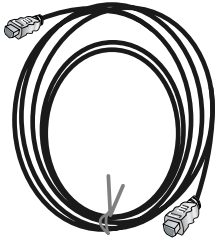

HDMI Cable  
(not supplied with the product)

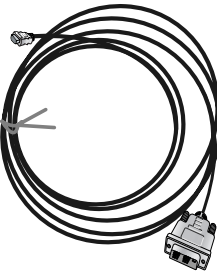

HDMI to DVI Cable  
(not supplied with the product)

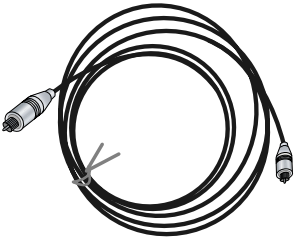

Fiber Optic Digital Audio Cable  
(not supplied with the product)



Analog Audio Cable(RCA type)  
(not supplied with the product)

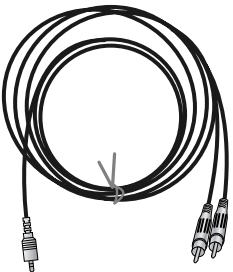

Analog Audio Cable(Stereo to RCA type)  
(not supplied with the product)

## How to use

1. Connect the HDMI1/DVI Source Devices(DVD Player or Set Top Box or PC) and the TV SET.
2. Turn on the display by pressing the POWER button on the TV SET and HDMI1/DVI Source Devices remote control.
3. Select HDMI1/DVI Input source in Main Input option of SETUP menu.(Refer to P.62)
4. Check the image on your TV SET. There may be noise associated with the resolution, vertical pattern, contrast or brightness in HDMI1/DVI Source Devices. If noise is present, change the HDMI1/DVI Source Devices to another resolution, change the refresh rate or adjust the brightness and contrast on the menu until the picture is clear. If the refresh rate of the PC graphics card can not be changed, change the PC graphics card or consult the manufacturer of the PC graphics card.

### Notes:

- Depending on the graphics card, DOS mode may not work if you use a HDMI1 to DVI Cable.
- Avoid keeping a fixed image on the TV SET screen for a long period of time. The fixed image may become permanently imprinted on the screen. Use the Orbiter screen saver when possible.
- When Source Devices connected HDMI/DVI Input, output PC Resolution(VGA, SVGA, XGA), Position, Size may not fit to Screen. As shown the lower picture, press the **ADJUST** button to adjust the screen Position of TV SET and contact an PC graphics card service center.
- When Source Devices connected HDMI1/DVI Input output TV SET Resolution(480p, 720p, 1080i), TV SET Display fit EIA/CEA-861-B Specification to Screen. If not, refer to the Manual of HDMI1/DVI Source Devices or contact your service center.
- In case HDMI1/DVI Source Devices is not connected Cable or poor cable connection, "NO SIGNAL" OSD display in HDMI1/DVI Input. And In case of, Video Resolution not supported TV SET output in HDMI1/DVI Source Devices, "INVALID FORMAT" OSD display. Refer to the Manual of HDMI1/DVI Source Devices or contact your service center.

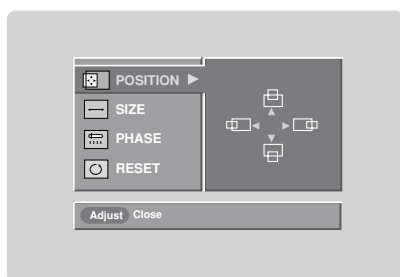

## In This Mode, the Supported TV SET Resolution Specification

- 1920 x 1080 I @ 59.94Hz / 60Hz, 16:9
- 1280 x 720 P @ 59.94Hz / 60Hz, 16:9(preferred format)
- 704 x 480 P @ 59.94Hz / 60Hz, 16:9
- 704 x 480 P @ 59.94Hz / 60Hz, 4:3

## In This Mode, the Supported PC Resolution Specification

- 640 x 480 @ 60Hz
- 640 x 480 @ 72Hz
- 640 x 480 @ 75Hz
- 800 x 600 @ 56Hz
- 800 x 600 @ 60Hz
- 800 x 600 @ 72Hz
- 800 x 600 @ 75Hz
- 1024 x 768 @ 60Hz(preferred format)
- 1024 x 768 @ 70Hz
- 1024 x 768 @ 75Hz

TV Guide On Screen Setup

- The TV Guide On Screen system uses Setup information to provide you with show listings and lineups in your area—which are updated several times a day.
- Once you set up the TV according to manufacturer’s instructions, you are ready to set up the TV Guide On Screen system.

**Note:** The TV Guide On Screen system interactive program guide provides listings for cable-ready, cable box, and digital cable services as well as over-the-air broadcast. It does not provide listings for satellite services.

How to connect VCR and Cable Box

1. Antenna Service

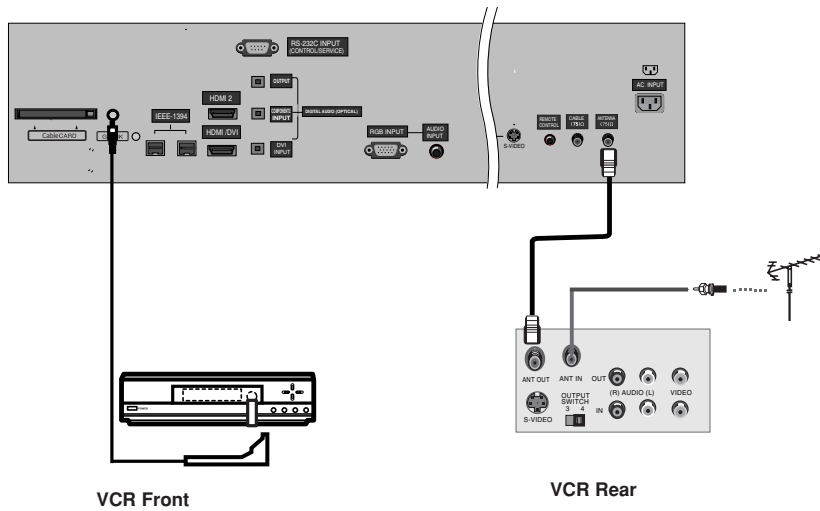

2. Cable Service without a Cable Box

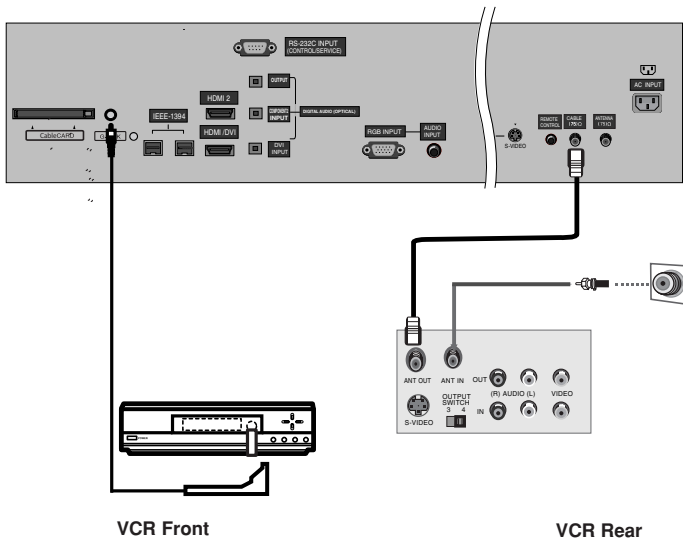



3. Cable Service with a Cable Box

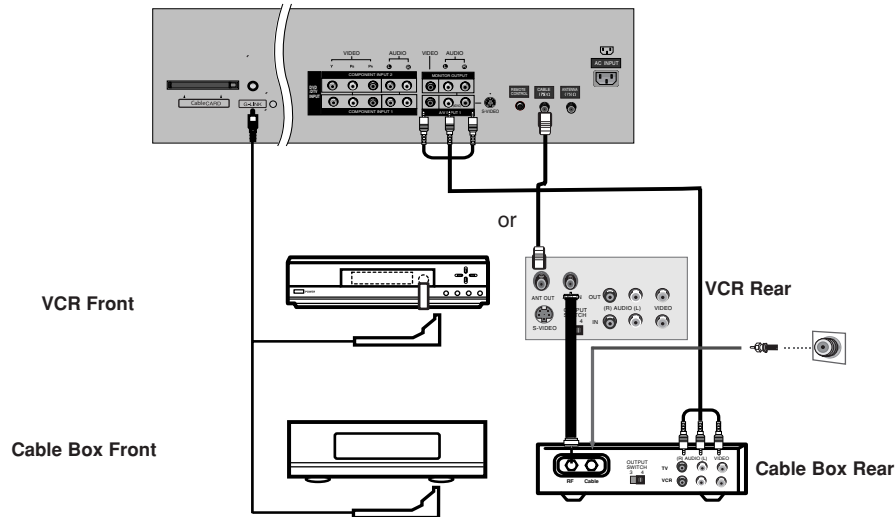

4. Antenna and Cable Service without a Cable Box

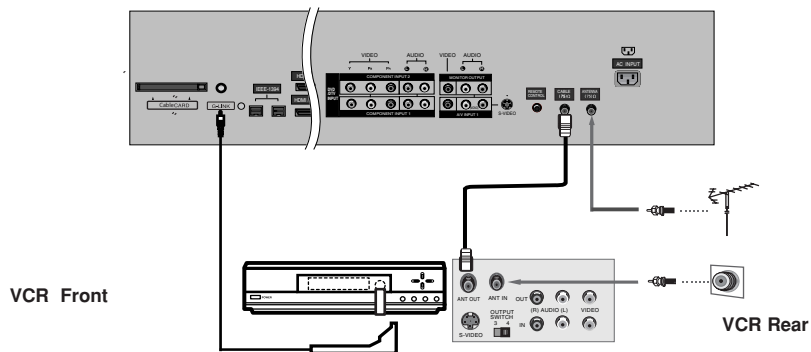

5. Antenna and Cable Service with a Cable Box

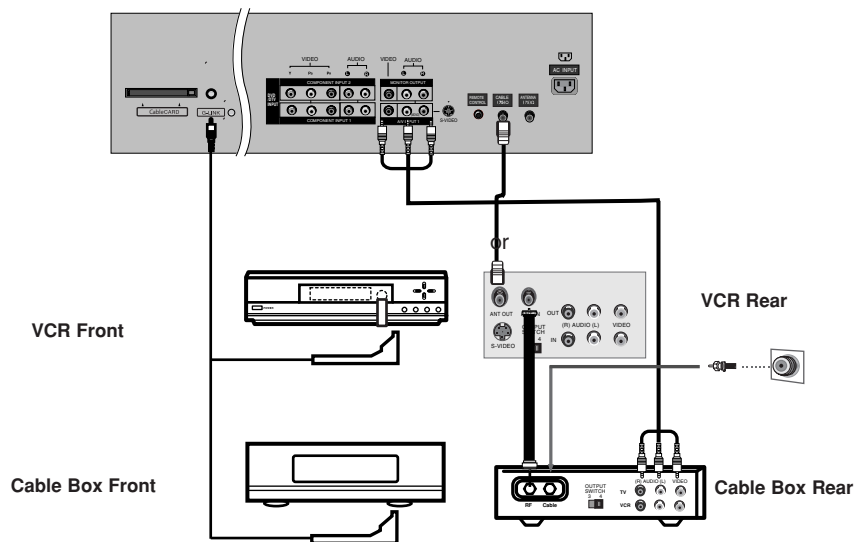

- Note:**
- The G-LINK™ cable is necessary for the TV Guide On Screen system to work with your Cable Box and VCR. See Page 23~24 for G-LINK™ connection instructions.

### 1. Reminder Screen

The TV Guide On Screen system's Reminder Screen appears:

- after initial TV set up
- if you power Off the TV and then power it back On

To make a selection, use the ▲ / ▼ button to highlight to an option, and press **ENTER**.

- "Set up TV Guide On Screen now," displays the Welcome Screen. Press **ENTER** to begin Setup.
- "Remind me to set up later" returns you to watching TV.
- "Don't remind me again" returns you to watching TV and stops the reminder screen from appearing upon power On.

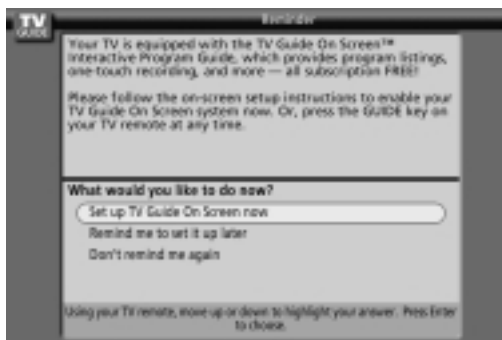

### 2. Welcome Screen

The TV Guide On Screen system's Welcome Screen appears:

- by pressing the TV Guide key
- when you power On your TV if you previously skipped "Set up TV Guide On Screen now" on the Reminder Screen.

The Welcome Screen highlights features of the TV Guide On Screen system.

Press **ENTER** to begin Setup.



## How to use

### 1. Screen 1: Country

- This screen asks you the location of your TV.
- Use the ▲ / ▼ button to highlight a country.
- Press **ENTER** to display Screen 2.

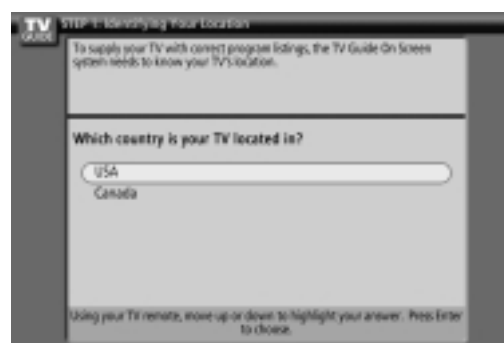

## 2. Screen 2: Enter Zip or Postal Code

### Option 1

- If you selected USA in Screen 1, you see the ZIP Code screen.
- You input numbers by either pressing the number keys on the remote or using the ▲ / ▼ button to display a number, and then the ◀ / ▶ button to move to another field.
- Press **ENTER** to display Screen 3.

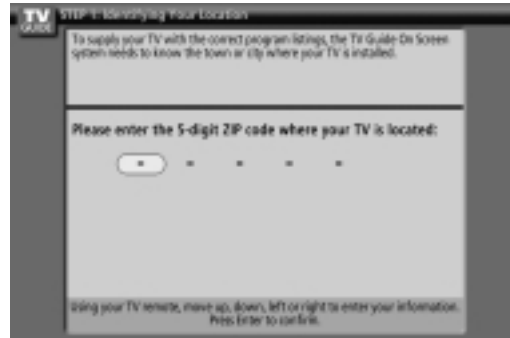

### Option 2

- If you selected Canada in Screen 1, you see the Postal Code screen.
- You input characters by using the ▲ / ▼ button, and then the ◀ / ▶ button to move to another field.
- Press **ENTER** to display Screen 3.

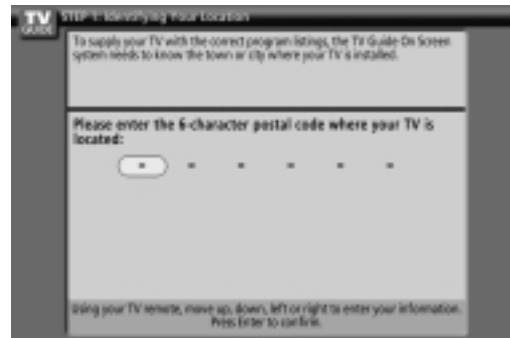

## 3. Screen 3: Do you have Cable Service connected?

- If you select Yes, you see Screen 4.
- If you select No, you see Screen 12.

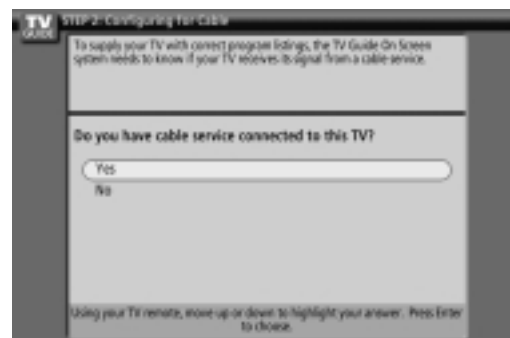

## 4. Screen 4: Do you have a Cable Box?

- If you select Yes, you see Screen 5.
- If you select No, you see Screen 12.

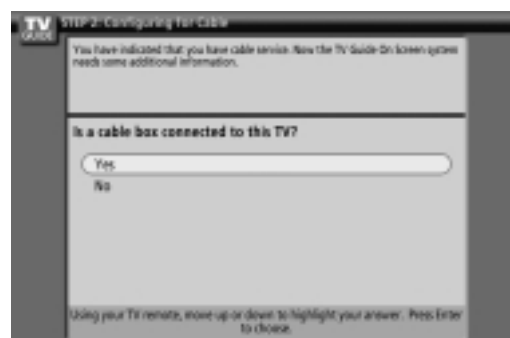

### 5. Screen 5: Which TV input is the cable box plugged into?

- If you select Cable, you see Screen 6.
- If you make any other choice, you see Screen 7 .

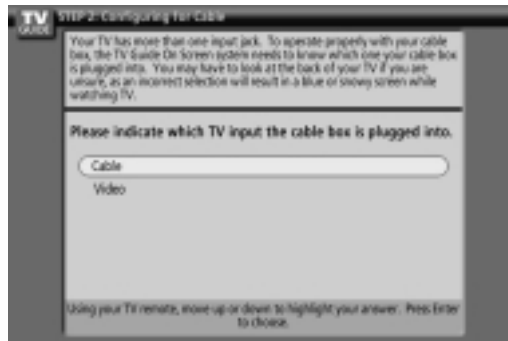

### 6. Screen 6: Cable Box Tuning Channel

- Select the channel used for the cable box.
- Press **ENTER** to display Screen 7.

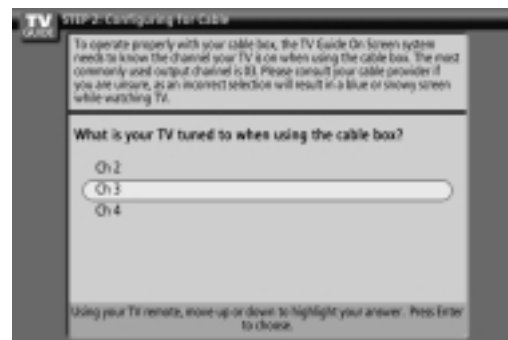

### 7. Screen 7: Cable Box Configuration Diagram

- The diagram shows the correct way to install the G-LINK Cable from the back of the device to the cable box.
- **Make sure the G-LINK™ Cable is properly installed.**
- Press **ENTER** to display Screen 8.

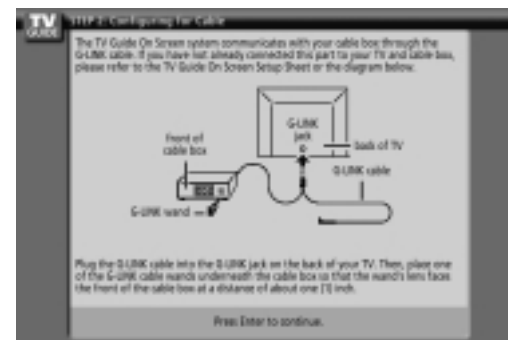

## 8. Screen 8: Cable Box Brand Name

- Use the ▲ / ▼ button to select a cable box brand.
- Press **ENTER** to display Screen 9.

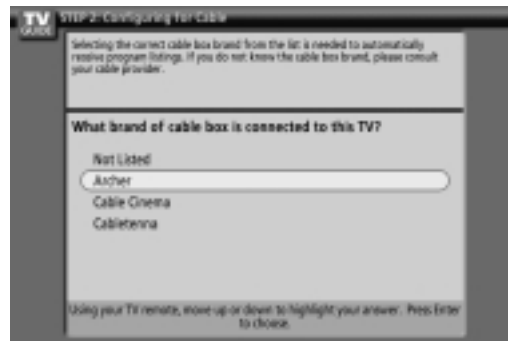

## 9. Screen 9: Cable Box Preparation

- Follow the on-screen instructions, and press **ENTER** to display Screen 10.

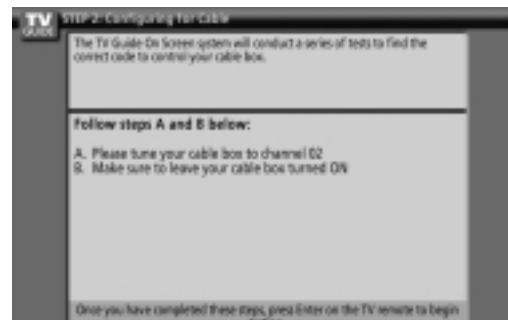

## 10. Screen 10: Cable Box Code Testing

- When testing is done, Screen 11 displays automatically.



## 11. Screen 11: Cable Box Tuned to Channel 9?

- If you select Yes, you see Screen 12.
- If you select No, a different code is tested in Screen 10.

### Note:

- *Many Cable Boxes require testing more than one code.*
- If you select Test this code again, the same code is tested again in Screen 10.

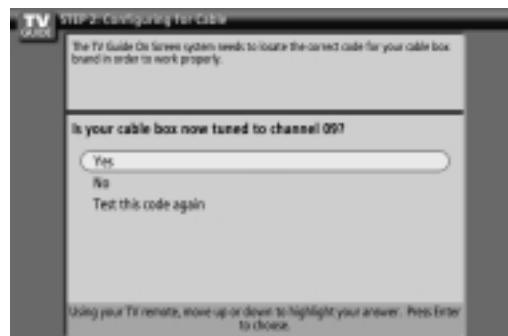

## 12. Screen 12: Do you have an antenna connected?

- If you select Yes, you see Screen 13.

**Note:**

- If you selected No in Screen 3 then you must select Yes in this screen to receive a channel lineup and listings.
- If you select No, you see Screen 13.

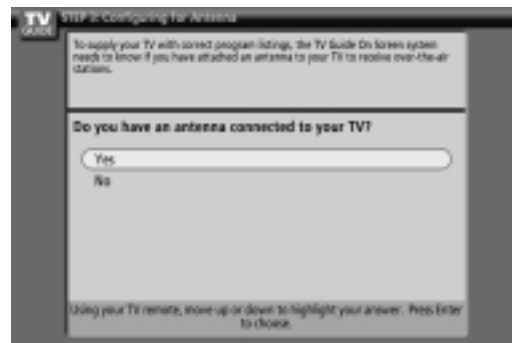

## 13. Screen 13: Are your basic settings correct?

- If you select Yes, you see Screen 14.
- If you select No, you see Screen 1.

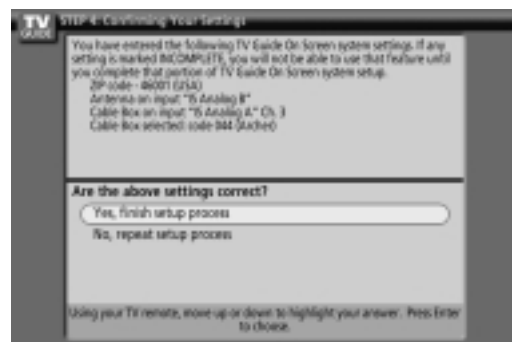

## 14. Screen 14: Congratulations

- Press **ENTER** to display Screen 15.



### 15. Screen 15: Is a VCR Connected?

- If you select Yes, you see Screen 16.
- If you select No, you see Screen 21.

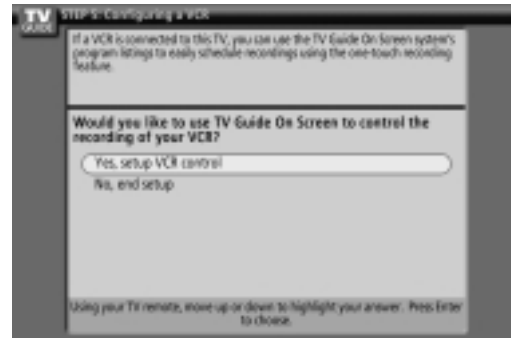

### 16. Screen 16: VCR Configuration Diagram

- This screen shows the correct way to install the G-LINK™ Cable from the back of the TV to the Recording device.
- **Make sure the G-LINK™ Cable is properly installed.**
- Press **ENTER**, and you see Screen 17.

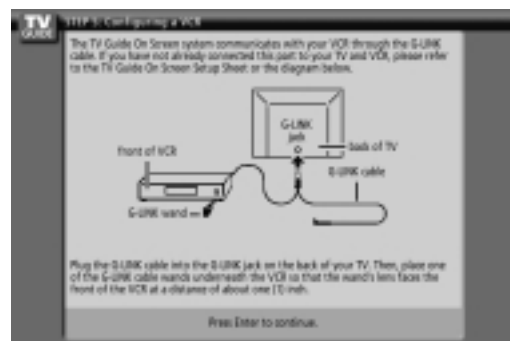

### 17. Screen 17: VCR Brand Name

- Use the ▲ / ▼ button to select the brand of the recording device.
- Press **ENTER**, and you see Screen 18.

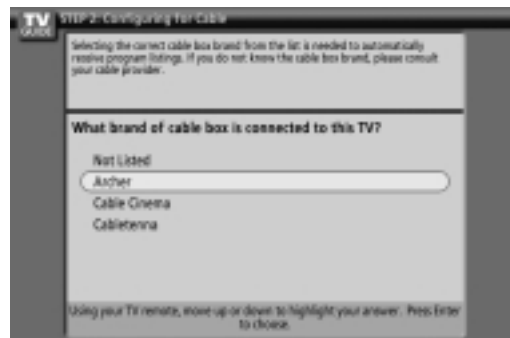

### 18. Screen 18: VCR Preparation

- Follow the on-screen instructions, and press **ENTER** to display Screen 19.

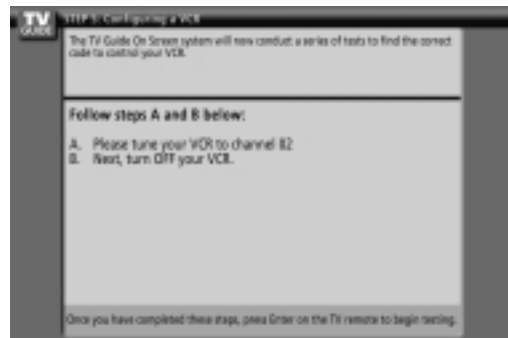

### 19. Screen 19: VCR Code Testing

- When testing is done, Screen 20 displays automatically.



### 20. Screen 20: VCR Tuned to Channel 9?

- If you select Yes, you see Screen 21.
- If you select No, a different code is tested in Screen 19.

**Notes :**

- Many VCRs require testing more than one code.
- If you select Test this code again, the same code is tested again in Screen 19.

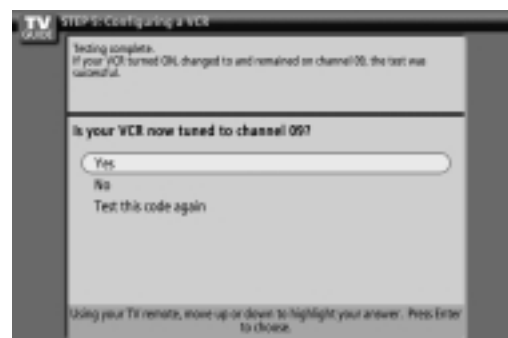



## 21. Screen 21: Confirming Your Settings

- Verify the Setup information is correct.
- If it is, select Yes, end setup, and you see Screen 22.
- If it is not, select No, repeat setup process, and you see Screen 1.

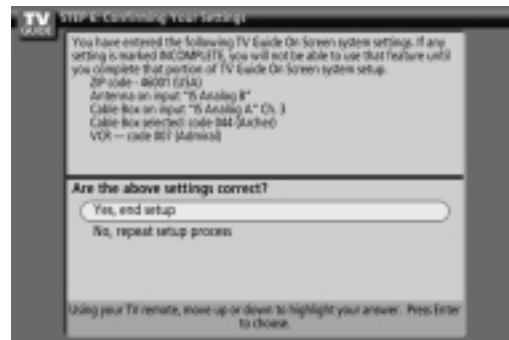

## 22. Screen 22: Congratulations

- You have successfully completed Setup!
- Press **ENTER** and you see Screen 23.



## 23. Screen 23: Helpful Information

- This screen tells you valuable information on using your TV Guide On-Screen system
- Press **ENTER** to watch TV.



### Notes:

- The TV Guide On-Screen system receives program listings data through your cable or over-the-air video signal. In order to receive regular program listings, please remember to do the following:
  1. Turn OFF your TV when it is not in use. (Do not unplug the power cord.)
  2. If you have a Cable box connected, leave it ON.
  3. If you have a VCR connected, turn it OFF when not in use. (Do not unplug the power cord.)
  4. If you have more than one Cable system in your area, you may be prompted to select which Cable system's program data to download. If so prompted, please follow the on-screen instructions.

# IEEE 1394 Functions

## IEEE 1394

- It's available to communicate to either direction and you can give and take a image, sound, or each control command with one cable.
- Use the DVHS, MicroMV Camcorder and DSTB to work the 1394.

### How to connect the 1394

•To work the 1394, 3 methods can used as below.

1. When connecting the DVHS or the MicroMV Camcorder, as shown in the (a) or (b) figure, press the **1394** button to show the control panel.

(a) TV ↔ DVHS

(b) TV ↔ MicroMV Camcorder

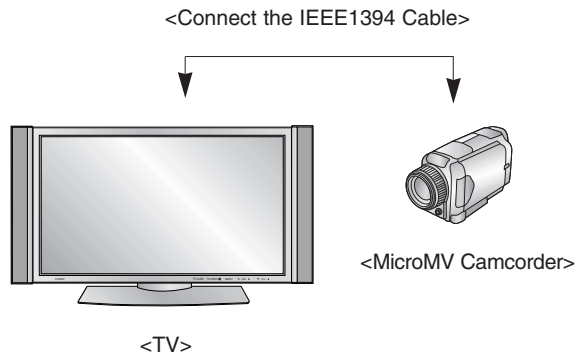
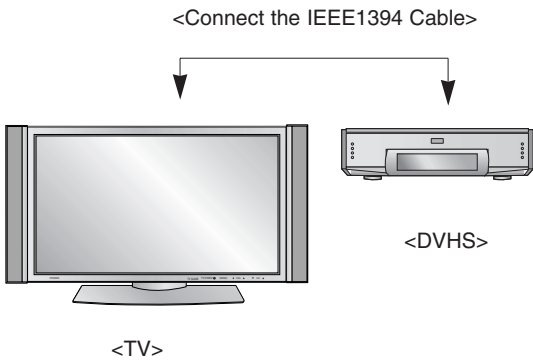

2. When connecting the DVHS and the MicroMV Camcorder, as shown in the (c) figure, press the **1394** button to show the contents panel and then select the DVHS or the MicroMV Camcorder to show the control panel.

(c) TV ↔ DVHS + MicroMV Camcorder

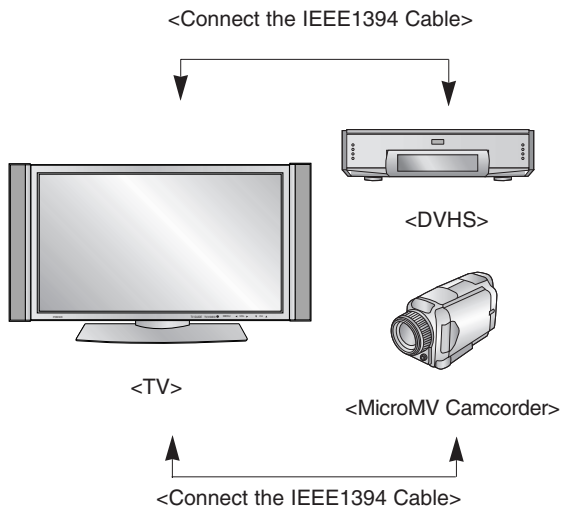

When connecting the 1394 and then playing, you must use the original DVHS tape. If not, it may be occurred the errors.

# IEEE 1394 functions continued

## DVHS

### How to play the DVHS

1. Connect the IEEE 1394 jack of the TV to the IEEE 1394 jack of the DVHS with IEEE 1394 Cable.

2. When watching the TV, press the **1394** button.

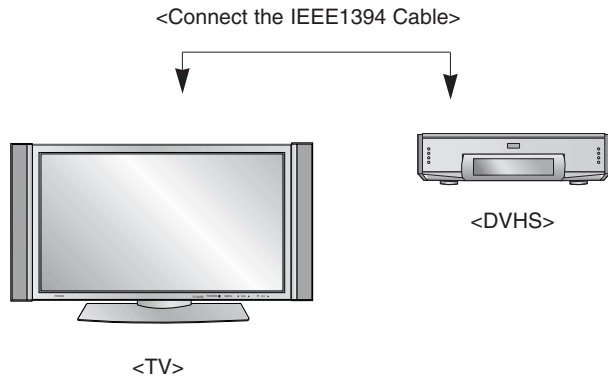

• Show the control panel of DVHS.

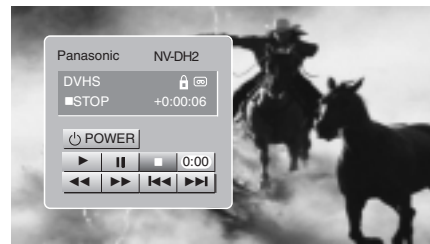

### \* Supported DVHS List

JVC (HM-DH5U)  
 JVC (HM-DH40000K)  
 JVC (HM-DH40000U)  
 PANASONIC (NV-DH2)  
 MITSUBISHI (HV-HD1000)  
 Motorola (DCT-6200)

• The control panel of DVHS

-Depending on the connected equipment, marked control panel may differ.

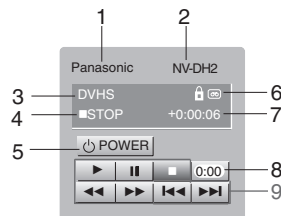

1. DVHS Company
2. DVHS Model
3. Connected Equipment to the 1394
4. DVHS Operating Status
5. Power On/Off
6. Tape Status
  - Tape shape Icon - Tape in or not
  - Lock shape Icon - Use or not use
7. DVHS Play Time
8. Initializing Play Time
9. DVHS Play, Pause, Stop, Search or Skip

#### (Notes:

- Skip- This function is for a fast search. It searches the program's start point and then plays. On skipping, Search (▶▶, ◀◀), Pause (||) and Play (▶) are displayed on the Control Panel. In some models, it's not available to operate the Skipping (◀◀, ▶▶) function.

# IEEE 1394 functions continued

## MicroMV Camcorder

### How to play the MicroMV Camcorder

1. Connect the IEEE 1394 jack of the TV to the IEEE 1394 jack of the MicroMV Camcorder with IEEE 1394 Cable.

2. When watching the TV, press the **1394** button.

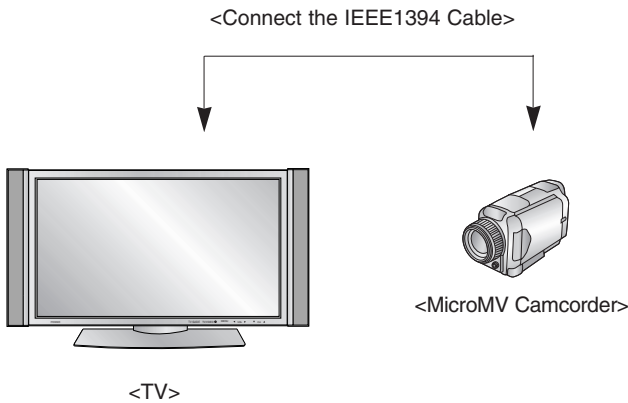

• Show the control panel of MicroMV Camcorder.

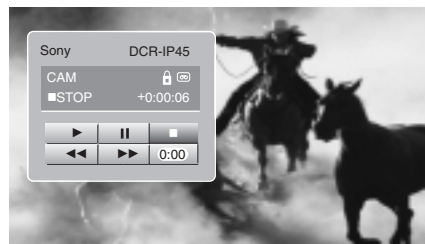

• The control panel of MicroMV Camcorder  
-Depending on the connected equipment, marked control panel may differ.

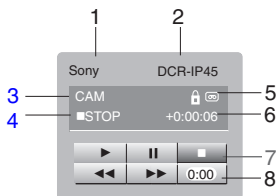

1. MicroMV Camcorder Company
2. MicroMV Camcorder Model
3. Connected Equipment to the 1394
4. MicroMV Camcorder Operating Status
5. Tape Status
  - Tape shape Icon - Tape in or not
  - Lock shape Icon - Use or not use
6. MicroMV Camcorder Play Time
7. MicroMV Camcorder Play, Pause, Stop or Search
8. Initializing Play Time

\* Supported MicroMV Camcorder List

- SONY MICROMV IP-5
- SONY MICROMV IP-45
- SONY MICROMV IP-210
- SONY MICROMV IP-1

# IEEE 1394 functions continued

## MicroMV Camcorder and DVHS

### how to play the MicroMV Camcorder and DVHS

1. Synchronously, connect the IEEE 1394 jack of the TV to the IEEE 1394 jack of the DVHS and the MicroMV Camcorder with IEEE 1394 Cable.



2. Press the ◀ / ▶ button to select device, then press **ENTER** button to play it . And then selected device will be showed OSD.

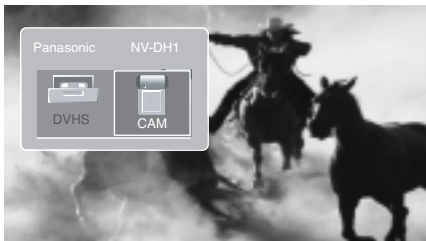

# IEEE 1394 functions continued

## How to connect the 1394

- When connecting these 3 methods, the **1394 will not work properly.**

(a) LOOP Connection

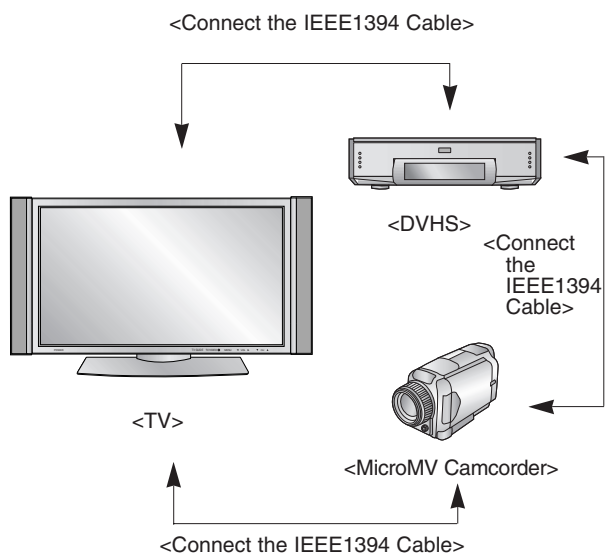

(b) Daisy Chain

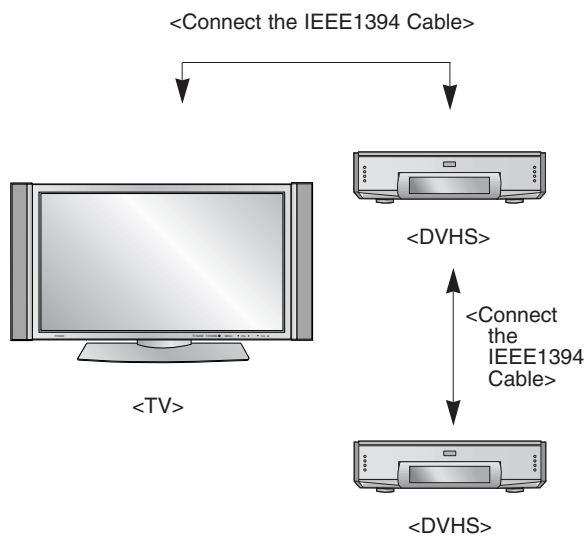

(c) MicroMV Camcorder Daisy Chain

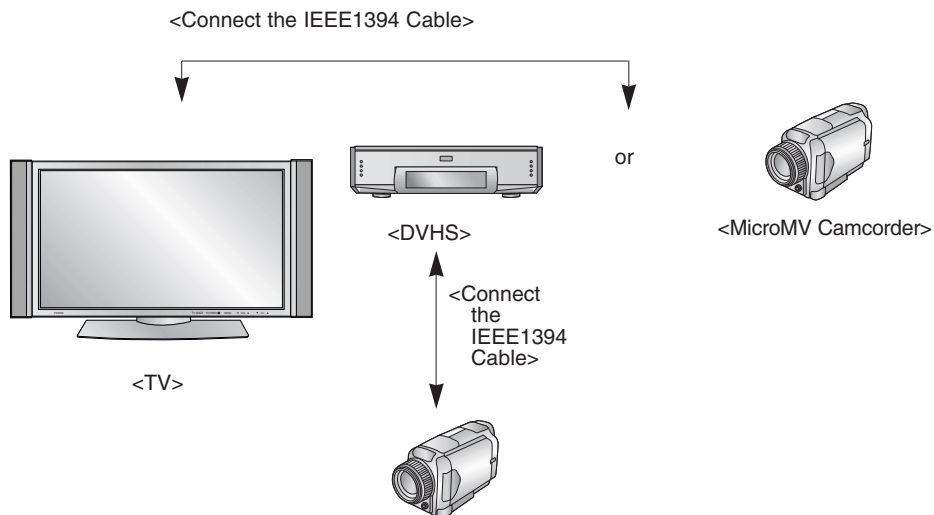

# TV Guide On Screen™ System

## Overview

- Your new TV contains the TV Guide On Screen system Interactive Program Guide.
- The TV Guide On Screen system has features that help you get the most out of your viewing experience.

## TV Guide On Screen system Overview

The TV Guide On Screen system has the following features:

- Eight days of show listings (today plus seven days).
- Icons that indicate show rating, stereo, HDTV, new episode, etc.
- Intuitive up/down/left/right navigation using your remote control.
- Set shows to Record.
- Schedule show Reminders.
- Search shows by category (e.g., Movies, Sports, Children, etc.).
- Search for shows based on keywords or alphabetically by title.
- Direct tuning to a channel.
- Show information while watching TV.
- Streamlined System Setup and default setting options.
- Channel lineup customization.
- Help screens while in the TV Guide On Screen system.

# TV Guide On Screen™ System continued

## Screen Components

- The screens displayed in the TV Guide On Screen system share many of the same components, as shown in the following figure:

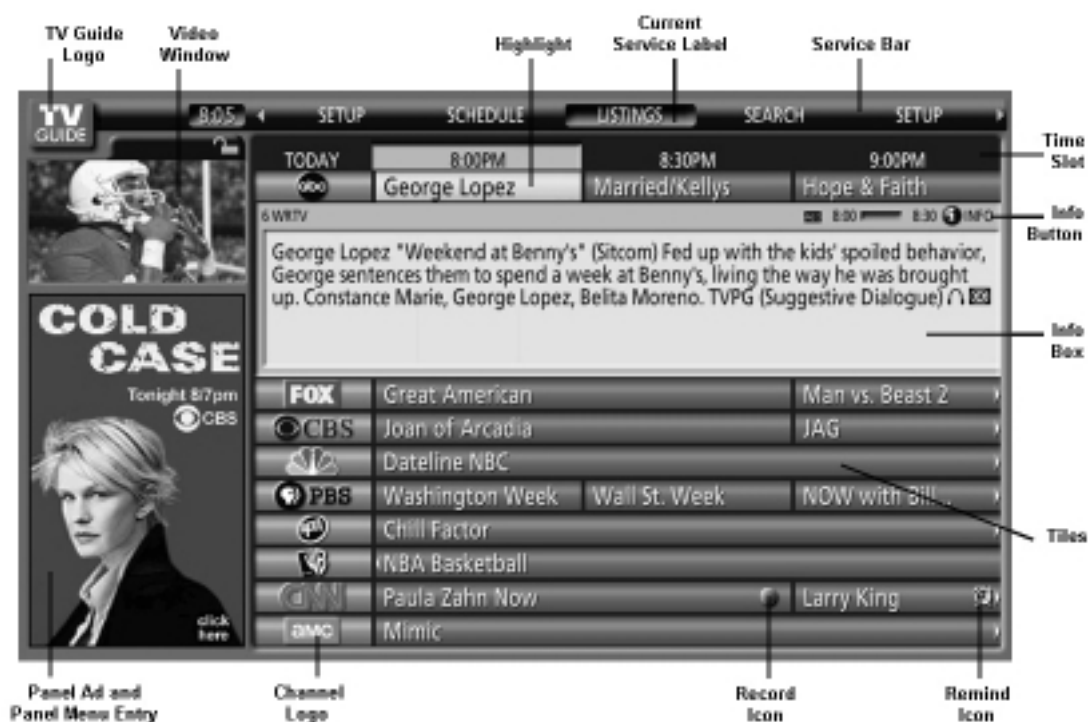

- Video Window** - displays TV video while the TV Guide On Screen system is displayed
- Service Bar** - provides access to the 4 main Guide Services
- Current Service Label** - indented to indicate current Service displayed
- Tile** - displays show title
- Highlight** - indicates an active tile
- INFO Box** - provides information for a highlighted item
- INFO Button** - cycles through the various Info Box sizes
- Channel Logo** - identifies network
- Record/Remind Icons** - indicates a show is set to Record or set as a Reminder
- Panel Ad** - location where show- or product-specific information appears (and also where Panel Menu appears)



# TV Guide On Screen™ System continued

## Panel Menu



- A Panel Menu appears when the Menu key is pressed on a highlighted tile and additional options are available. It also appears when you press **ENTER** on a show starting in the future.
- When a Panel Menu appears, the highlighted tile changes color to indicate the Panel Menu relates to this tile.
- The Panel Menu displays below the Video Window.
- Help is available for a displayed Panel Menu by pressing the **INFO** button.
- The ▲ / ▼ button move between the options within the Panel Menu.
- The left and right arrows move to adjacent options unless the highlight is on an odometer, where these arrows change the odometer choice.
- Pressing **ENTER** from an odometer or number entry box moves the highlight to the default command button of that Panel Menu, for example, Schedule Reminder.
- Pressing **ENTER** from a highlighted command button executes the action and closes the Panel Menu (e.g., Schedule Reminder, Cancel).
- Select Cancel to cancel any changes and press **ENTER** to close this menu.
- Pressing Menu is a shortcut to Cancel. Press Menu to cancel any changes and close the menu.
- If a Panel Menu contains more menu options than can be displayed on a single screen, ▲ / ▼ button appear at the top or bottom of a menu. Simply scroll down to access these options.

# TV Guide On Screen™ System continued

## Main Services

### < Listings >

- Access Listings by pressing the TV Guide button on your remote or on the front panel of your TV.
- Listings is always the first Service displayed in the TV Guide On Screen system.
- With Listings highlighted, press the Info button to display a Help screen. Press the Info button again to close the screen.

Use the ▲ / ▼ / ◀ / ▶ buttons to move the highlight within Listings to:

- View 8 days of show listings
- Read show descriptions
- Tune directly to a show currently airing
- Set a show to Remind
- Set a show to Record
- Lock and unlock the Video Window
- Access Panel and Channel Ads

#### Notes:

- There may be times when the TV Guide On Screen system could display partial or no program listings. The reasons for this include:

1. Program schedule information was not provided to TV Guide On Screen.
2. The transmission of the program listings was interrupted.
3. The phrase "No Listings" will be replaced with program information during the next transmission, which should occur within the next 24 hours.
4. Please remember to turn off your TV when not in use in order to receive program listings.

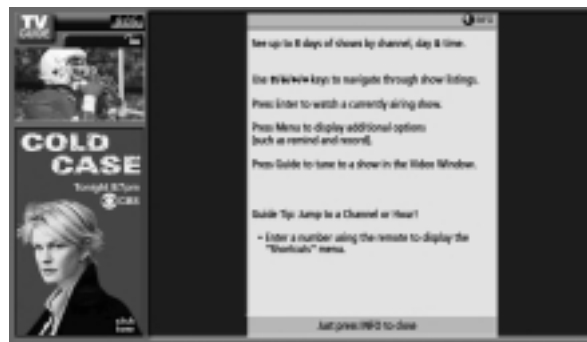

# TV Guide On Screen™ System continued

## < Search >

- Search lets you find shows by category (Alphabetical, Movies, Sports, Children, Educational, News, Variety, Series, HDTV) or by Keyword.
- With Search highlighted, press the **INFO** button to display a Help screen.  
Press the **INFO** button again to close the screen.

### •Category Search Example: Movies

1. From Search, use the ▼ button to highlight Movies.

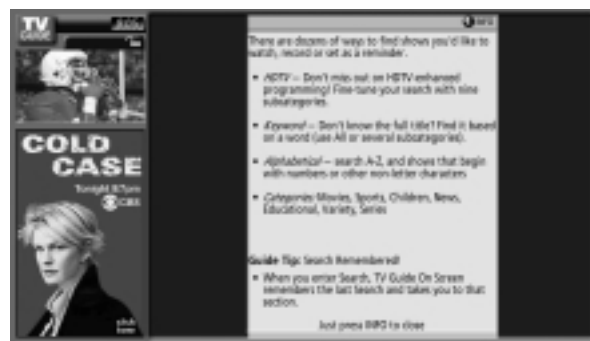

# TV Guide On Screen™ System continued

- Use the ▼ button to highlight a subcategory (for example, All).
- Press **ENTER** to display a list of all Movies, organized by date and time.



- Highlight a show and press **ENTER** to watch (if on now) or the Menu key to display the Episode Options menu.



You can choose to set a recording, a reminder, or tune to the channel.

**Go to Service Bar** - closes the menu, changes no information, and returns to the Search Service Bar.

**Tune to Channel** - exits the TV Guide On Screen system and tunes to the channel of the highlighted show (show airs in the future).

**Note:** This option reads *Watch Now* if the show is currently airing.

**Set Recording** - displays the Record Options menu, from which you can set frequency, start and end time, etc.

**Set Reminder** - displays the Remind Options menu, from which you can set frequency, when, automatically power On, and auto-tune the TV.

**Cancel** - closes the menu, changes no information, and returns to the highlighted show.

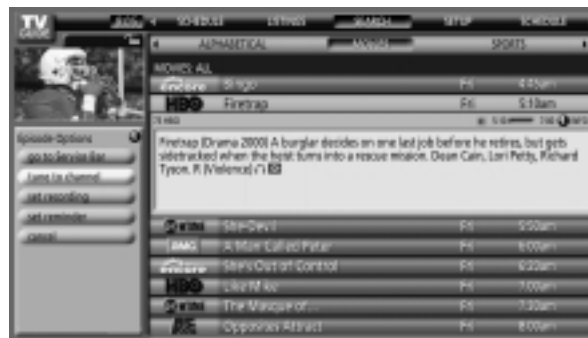

# TV Guide On Screen™ System continued

## • Keyword Search

- **Keyword search** lets you enter a word(s) to look for a particular show by category or for every show title that matches.

1. Highlight the Keyword navigation label, and press **ENTER** button to display the Keyword Search menu.
2. Highlight New Search, and press **ENTER** button.



3. The Search Options menu is displayed.
4. Highlight Category, and use the ◀ / ▶ button to select a category to search (e.g. All, HDTV, Children, Sports, etc.). When finished, use the ▼ button to highlight Enter Keyword.
5. Highlight Enter Keyword, and press **ENTER**. Then the keyboard is displayed.



6. Use the ▲ / ▼ / ◀ / ▶ button to highlight a character, and press **ENTER** to display it. When complete, highlight Done and press **ENTER**.



## TV Guide On Screen™ System continued

7. A list of all matching shows for that keyword is displayed.

Like the Category Search Example, you can highlight a show, and press **ENTER** to display all airings. You can then highlight a specific listing and press **ENTER** to watch (if On now) or the Menu key to display the Episode Options menu.

From the Episode Options menu, choose to set a recording, a reminder, or tune to the channel, as previously described.



The TV Guide On Screen system stores all the keywords you create. To edit or delete a keyword, highlight the keyword and press the Menu key. A Search Options menu is displayed.

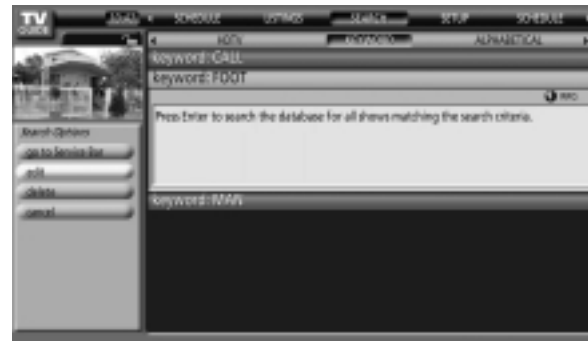

**Go to Service Bar** - closes the menu, changes no information, and returns to the Search Service Bar.

**Edit Search** - displays the keyboard, where you can change the keyword.

**Delete Search** - A Confirm menu is displayed.

- **Yes** - deletes the Search

- **No** - closes the panel menu

**Cancel** - closes the menu, changes no information, and returns to the highlighted show.







# TV Guide On Screen™ System continued

## < Schedule >





- Schedule lets you review, edit, or delete Record and Remind events that you set previously.
- With Schedule highlighted, press the **INFO** button to display a Help screen. Press the **INFO** button again to close the screen.
- An icon identifies the event type:

### Record

- ◆ Once —records the show one time
- ◆ Regularly , Daily —records the show every time the show airs on the same channel and starts at the same time
- ◆ Weekly —records the show each time the show airs on the same day of the week, on the same channel and starts at the same time
- ◆ Off —keeps the show in the list but will not record this show until the frequency is changed.



### Remind

- ◆ Once —sets a show reminder one time
- ◆ Regularly , Daily —sets a show reminder every time the show airs on the same channel and starts at the same time
- ◆ Weekly —sets a show reminder each time the show airs on the same day of the week, on the same channel and starts at the same time
- ◆ Off —keeps the show in the list but will not remind until the frequency is changed

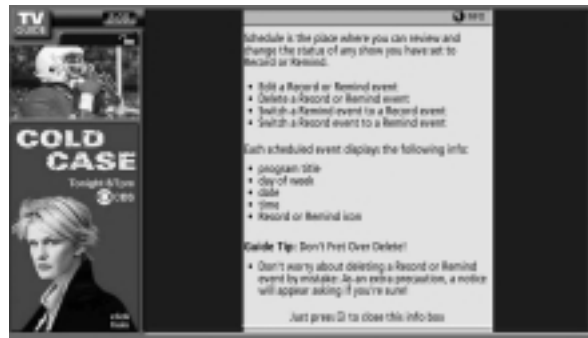

Highlight an event, and press the Menu key for options.

**Go to Service Bar** - closes the menu, changes no information, and returns to the Schedule Service Bar.

**Tune to channel** - exits the TV Guide On Screen system and tunes to the highlighted show.

**Delete Recording** - removes the recording from the Schedule, after a Confirm screen.

**Edit Recording** - opens a menu from which you can change existing recording information.

**Set Reminder** - opens a menu from which you can set a Reminder for the show (Record is not cancelled).

**Cancel** - closes the menu, changes no information, and returns to the highlighted show.



# TV Guide On Screen™ System continued

## < Setup >

- After you initially complete Guide Setup, you can make changes to Guide settings in the following areas:

- Change System Settings
- Change Channel Display
- Change Default Options

Highlight a choice, press **ENTER**, and follow the on-screen instructions.



With Setup highlighted, press the **INFO** button to display a Help screen. Press the **INFO** button again to close the screen.

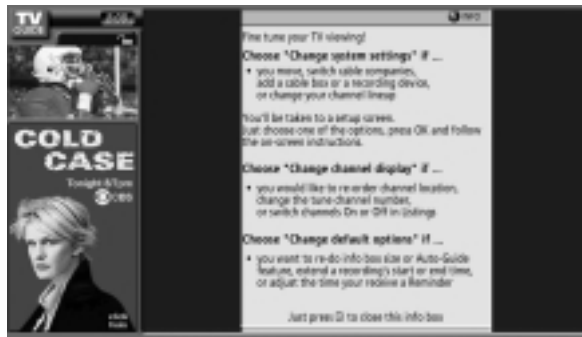

## • Change System Settings

This option appears after you have completed the initial Guide Setup process.

Press **ENTER** to display the Confirming Your Settings screen. You see your current settings.

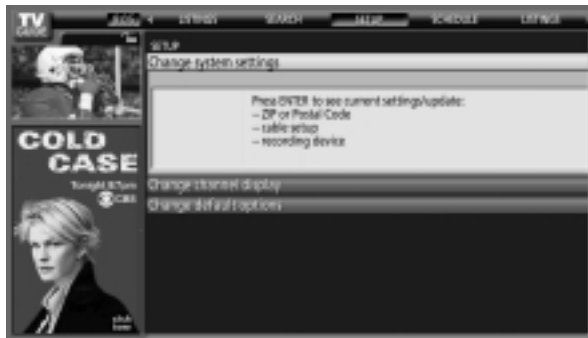

Choose one of the options, press **ENTER**, and follow the on-screen instructions.

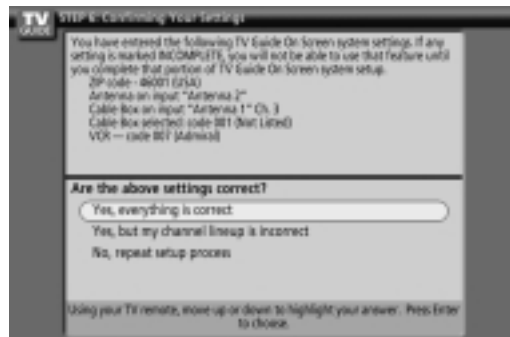



# TV Guide On Screen™ System continued

## • Change Channel Display

Change Channel Display lets you edit channel information that appears in Listings. With Change Channel Display you can :

- Re-order the position or the channel appears in Listings
- Change the tune channel number
- Switch a channel
  - ◆ On - the channel is always displayed
  - ◆ Off - the channel is never displayed
  - ◆ Auto-Hide - the channel is only displayed when program information is available.

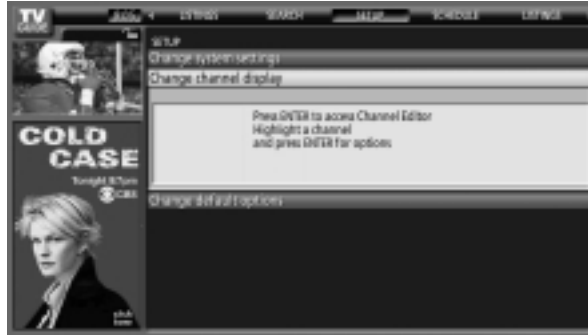

Press **ENTER** to display the Channel Editor screen.

Then, highlight a channel and press Menu. A Grid Options menu is displayed.

Highlight Go Back to Setup to close the menu, change no information, and return to the Setup Service Bar.

Or make changes and when finished, press **ENTER** to highlight Done. Press **ENTER** again to close the menu and accept the changes.



Highlight Cancel to close the menu, change no information, and return to the highlighted channel.

# TV Guide On Screen™ System continued

## • Change Default Options

Change Default Options lets you change default settings in the following categories:

- General Default Options
- Record Defaults
- Remind Defaults

Highlight Change Default Options, and press **ENTER**.



### <General Default Options>

General Default Options lets you set defaults for the following:

- The initial Info Box size when the TV Guide On Screen system is entered.  
Choices are No, Small, Large, and Last Used (Default = Last Used).
- The Info Box size rotation when the Info key is pressed while in the TV Guide On Screen system.  
Choices are No only, Small only, Large only, No & Small, No & Large, Small & Large, All (Default = All)
- Automatic entry into the TV Guide On Screen system (Auto-Guide) when the TV is powered On.  
Choices are On and Off (Default = On).

Highlight General Default Options, and press the Menu key to display the General Default Options menu.

Highlight Go to Service Bar to close the menu, change no information, and return to the Setup Service Bar.

When finished, press **ENTER** to highlight Done. Press **ENTER** again to close the menu and accept the changes.

Highlight Cancel to close the menu, change no information, and return to the highlighted option.

