

Using My Apps.

- 1 Enter the TV Apps after sign in.
- 2 Press the Navigation buttons to scroll to **My Apps.** and press **ENTER**.

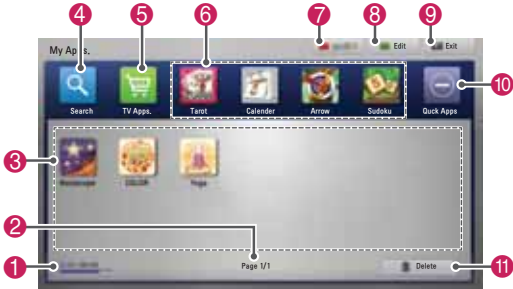

Option	Description
①	사용량과 전체 용량을 볼 수 있습니다.
②	Current page number/total number of pages of My Apps.
③	Shows the downloaded apps.
④	Search the TV Apps.
⑤	Moves the TV Apps.
⑥	Quick Apps.
⑦	Sign In the TV Apps. After sign in, manage the ID option (Account Setting, Change User, Sign Out).
⑧	Edit the My Apps (Move, Delete, Give Grades)
⑨	Exit the My Apps.
⑩	Move to the Quick Apps.
⑪	Delete the Apps.

Smart Share Card Function

Connecting USB storage devices

Connect USB storage devices such as a USB flash drive, external hard drive, or MP3 player to the TV and use multimedia features (See "Browsing files" on page 67).

Connect a USB flash drive or USB memory card reader to the TV as shown on the following illustration.

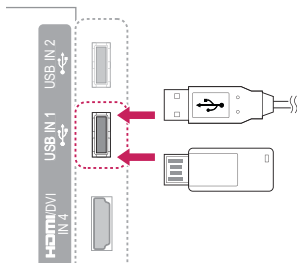

To disconnect a USB storage device, make sure to end the connection properly to prevent damages to the TV or files.

- 1 Press **●.MENU** to access the quick menus.
- 2 Press the Navigation buttons to scroll to **USB Device** and press **ENTER**.
- 3 Disconnect the USB storage device only when the message says that it is safe to remove.



CAUTION

- Do not turn the TV off or remove a USB storage device while the USB storage device is connected to the TV, as this could result in loss of files or damage to the USB storage device.
- Back up your files saved on a USB storage device frequently, as you may lose or damage the files and this may be not covered by the warranty.

Tips for using USB storage devices

- The TV recognizes only a USB storage device.
- If you connect a USB storage device to the TV through a USB hub, your TV may not recognize the USB storage device.
- The TV may not recognize a USB storage device that uses its own.
- The recognition speed of a USB storage device may differ depending on the device.
- Only use a USB storage device which has normal music or image files.
- Use only USB storage devices that are formatted as a FAT 32 or NTFS file system.
- You may need to connect a USB storage device to an external power supply with a power adapter.
- If the TV does not recognize a connected USB storage device, replace the cable and try again. Do not use an excessively long cable.
- The TV does not support some USB storage devices properly.
- You can use a multi-partition (up to 4) USB storage device.
- You can use up to 4 USB storage devices at a time by using a USB multi-card reader.
- The file alignment method of a USB storage device is similar to the one of Windows XP.
- You cannot create or delete a folder saved in a USB storage device directly on the TV.
- The number of characters for a file name is up to 100 English characters.
- **Up to 1000 including folders and files can be recognized.**
- If there are too many folders and files in one folder, it may not operate properly.
- The recommended capacity for a USB external hard disk is 1 TB or less and for a USB storage device is 32 GB or less.
- If a USB external hard disk with the Energy Saving feature does not work, turn the USB external hard disk off and on again to make it work properly. For more information, refer to the user manual of the USB external hard disk.
- USB storage devices below USB 2.0 are supported as well. But they may not work properly in the movie list.

Connecting DLNA DMP (Digital Living Network Alliance, Digital Media Player)

This TV can display and play many types of movie, photo and music files from your DLNA server and has been certified by DLNA for photos.

The Digital Living Network Alliance (DLNA) is a cross-industry organization of consumer electronics, computing industry and mobile device companies. Digital Living provides consumers with easy sharing of digital media through a wired or wireless network in the home.

The DLNA certification logo makes it easy to find products that comply with the DLNA Interoperability Guidelines. This unit complies with DLNA Interoperability Guidelines v1.5. When a PC running DLNA server software or other DLNA compatible device is connected to this TV, some setting changes of software or other devices may be required. Please refer to the operating instructions for the software or device for more information.

Please refer to “**Smart Share** Card Function” for additional information on supported file types and other instructions.

! NOTE

- The supplied Nero MediaHome 4 Essentials CD-ROM is a customized software edition only for sharing files and folders to this TV.
- The supplied Nero MediaHome 4 Essentials software does not support following functions: Transcoding, Remote UI, TV control, Internet services and Apple iTunes
- This manual explains operations with the English version of Nero MediaHome 4 Essentials as examples. Follow the explanation referring to the actual operations of your language version.
- If there are too many folders and files in one folder, it may not operate properly.
- For the DLNA option, use the Nero MediaHome program that is provided with the TV. However, we cannot guarantee that third party program will work perfectly.
- You can select a channel while viewing the small preview channel list on your TV screen.
- Check your network settings when the DLNA option does not work properly.
- If there is an abnormal operation or an error occurs in Nero Media Home, the DLNA option may not work properly. In this case, exit Nero Media Home and restart the program. You can download the latest version of Nero Media Home by clicking the question mark at the bottom-left of the program.
- When the network is unstable, the device may be slower or may need to load during playback.
- When playing a video in DLNA mode, the Multi Audio and Closed Caption features are not supported.
- When selecting Full Screen in DLNA mode, the ratio of the outputted screen may differ from the original.
- When more than one TV is connected to a single server in DLNA mode, a file may not play properly, depending on the server performance.
- If the play time information is not provided by the server, it is displayed as "- -."

Installing Nero MediaHome 4 Essentials

Nero MediaHome 4 Essentials is easy to use DLNA server software for Windows.

Requirement PC system before you install Nero MediaHome 4 Essentials

- Windows® XP (Service Pack 2 or higher), Windows Vista® (no Service Pack required), Windows® XP Media Center Edition 2005 (Service Pack 2 or higher), Windows Server® 2003
- Windows Vista® 64-bit edition (application runs in 32-bit mode)
- Hard drive space: 200 MB hard drive space for a typical installation of Nero MediaHome stand-alone
- 1.2 GHz Intel® Pentium® III or AMD Sempron™ 2200+ processors
- Memory: 256 MB RAM
- Graphics card with at least 32 MB video memory, minimum resolution of 800 x 600 pixels, and 16-bit color settings
- Windows® Internet Explorer® 6.0 or higher
- DirectX® 9.0c revision 30 (August 2006) or higher
- Network environment: 100 Mb Ethernet, WLAN (IEEE 802.11a/b/g/n)

- 1 Start up your computer, and insert the Nero MediaHome 4 Essentials CD-ROM into your computer's CD-ROM drive.
An installation wizard will walk you through the quick and uncomplicated installation process.
- 2 Close all Microsoft Windows programs and exit any anti-virus software that may be running.
- 3 Insert the Nero MediaHome 4 Essentials CD-ROM into your computer's CD-ROM drive.
- 4 Click **Nero MediaHome 4 Essentials**. The installation is prepared and the installation wizard appears.
- 5 Click the **Next** button to display the serial number input screen. Click **Next** to go to the next step.
- 6 If you accept all conditions, click **I accept the License Conditions** check box and click **Next**. Installation is not possible without this agreement.

- 7 Click **Typical** and click **Next**. The installation process is started.
- 8 If you want to take part in the anonymous collection of data, select the check box and click the **Next** button.
- 9 Click the **Exit** button to complete the installation.

Sharing files and folders

After installing Nero MediaHome, you must add folders you wish to share.

- 1 Double-click the Nero MediaHome 4 Essentials icon on the desktop.
- 2 Click Network icon on the left and define your network name in the Network name field. The Network name you enter will be recognized by your TV.
- 3 Click Shares icon on the left.
- 4 Click Local Folders tab on the Shared screen.
- 5 Click Add icon to open the Browse Folder window.
- 6 Select the folder containing the files you want to share. The selected folder is added to the list of shared folders.
- 7 Click Start Server icon to start the server.

NOTE

- If the shared folders or files are not displayed on the TV, click the folder on the Local Folders tab and click **Rescan Folder** at the **More** button.
- Visit <http://www.nero.com> for more information and software tools.

Playing back shared contents

You can display and play movie, photo and music content stored on your computer or other DLNA media servers.

- 1 Press **HOME** to access the Home menu.
- 2 Press the Navigation buttons to scroll to **Smart Share** and press **ENTER**.
- 3 Press the Navigation buttons to scroll to the device you want and press **ENTER**.
- 4 Press the Navigation buttons to select **DLNA**. Depending on the media server, this TV may need to get the permission from the server. If you want to re-scan available media server, press blue color button.

Tips for using DLNA DMP

- To play the file on the media server, the TV and the media server must be connected to the same access point.
- DLNA operation may not work properly according to the AP manufacturers.
- Because the compatibility and available playback functions on the **Smart Share** menu are tested on the bundle DLNA server (Nero MediaHome 4 Essentials) environment, file requirements and playback functions on the **Smart Share** may differ depending on media servers.
- **The file requirements** are not always compatible. There may have some restrictions by file features and media server's ability.
- Even the files that are not supported can be displayed in photo thumbnail or music thumbnail.
- **Movie thumbnail is only supported when DLNA server supports a Movie thumbnail.**
- If there is an unplayable music file in the **Smart Share** menu, the TV will skip the file and play next file.
- **Files in a folder can be played only when they are of the same type.**
- The file information indicated on the screen may not always correct for music and movie files in **Smart Share** menu
- This TV only supports movie subtitle files supplied by Nero MediaHome 4.
- The subtitle file name and movie file name have to be the same and located at the same folder.
- If subtitle files have been added after a directory has been indexed already, the user has to remove and re-add the folder to the list of shares.
- **The DRM/*.tp/*.trp file in DLNA server is not played when Movie List is in operation.**
- **The *.mpo file in DLNA server is not played when Photo List is in operation.**
- The playback and operating quality of the **Smart Share** function may be affected by your home network condition.
- The files from removable media such as USB drive, DVD-drive etc. on your media server may not share properly.
- When playing the Media through DLNA connection, it does not support the DivX file play which is protected by DRM.
- **Up to 1000 including folders and files can be recognized.**
- If there are too many folders and files in one folder, it may not operate properly.

Connecting DLNA DMR (Digital Living Network Alliance, Digital Media Render)

If the PC uses Windows 7, or a device (e.g. mobile phone) with the DLNA DMC certificate is connected to a network, you can play music, videos or photos etc. on the TV.

The DMR function only works properly when the TV and PC are configured to use the same network.

- 1 To play a file, select the file by using the "Remote Play" feature in Windows 7.
To do this, right-click on the file you want to play.
 - Refer to the **owner's manual of the mobile phone or other device to find out how to use it to play a file.**
 - You can change the name of a connected TV by double-clicking the item you want to change in Control Panel > Network and Internet > View network computers and devices.
 - You cannot change the name of a TV while DMR media is playing. Change it when playback is stopped.
- 2 Select **Yes** button on the TV pop-up window.
 - **여러개의 TV 나 기기가 연결되어 있어도 하나의 기기에서만 재생됩니다. 재생속도는 네트워크 속도에 따라 차이가 날 수 있습니다.**

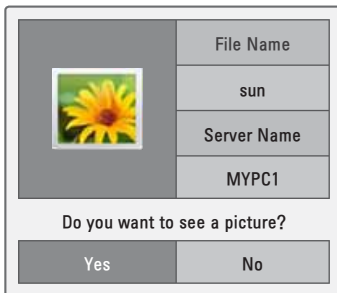

- 3 Press the **EXIT** button on the remote control to exit.
 - During play, only the volume, mute, exit and backwards buttons are available.



NOTE

- **DMC 장비에 따라 자막 지원이 되지 않을 수 있습니다.**
- The DMR function may not work properly in a wireless network.
- The seek function of the DMC only works on video files.
- The DMR is not available when another function is operating (recording, playback or Smart Share work etc.).

Browsing files

Access the photo, music, or movie lists and browse files.

- 1 Press **HOME** to access the Home menu.
- 2 Press the Navigation buttons to scroll to **My Media** and press **ENTER**.
- 3 Press the Navigation buttons to scroll to the device you want and press **ENTER**.
- 4 Press Navigation buttons to scroll to **All Media, Movie List, Photo List, or Music List** and press **ENTER**.
 - **All Media:** Shows all files in the file list.
 - **Movie List, Photo List, or Music List:** Shows only one type of file in the file list.
- 5 Press Navigation buttons to select a folder or file you want.

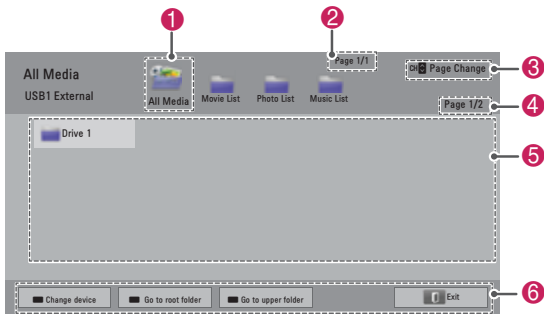

No.	Description
1	Shows all media folder.
2	Current page number/total number of pages of folder.
3	Moves to the previous or next page.
4	Current page number/total number of pages of contents.
5	Files info or thumbnail.
6	Available buttons on the remote control.

Thumbnail information

Type	Abnormal files	Non-supported files
Movie		
Photo		
Music		

Tips for using USB storage devices

Type	Supported File Formats		
Video	<ul style="list-style-type: none"> • MPG, MPEG, DAT, TS, TRP, TP, VOD, MP4, MOV, MKV, DivX, AVI, Motion JPEG (AVI, MP4, MKV), ASF, WMV, FLV • Max bitrate of playable movie file: 20 Mbps (Mega bit per second) • Bit rate of audio format: within 32 kbps to 320 kbps (MP3) • Supported external subtitle format: *.smi, *.srt, *.sub (MicroDVD, SubViewer 1.0/2.0), *.ass, *.ssa, *.txt (TMPlayer), *.psb (PowerDivX) • Supported Internal subtitle format: only XSUB (It is the subtitle format made in DivX6 files), Text utf-8, SRT, ASS, SAA (It is the subtitle format used in DivX6 files DivX-Plus file) 		
Photo	<ul style="list-style-type: none"> • Do not use the progressive option when saving JPG files on your PC. • It may take some time to open high-resolution images in full screen. 		
	File Extensions	Item	Profile
2D	jpeg jpg jpe	Supported file format	<ul style="list-style-type: none"> • SOF0: baseline • SOF1: Extend Sequential • SOF2: Progressive
		Photo size	<ul style="list-style-type: none"> • Min: 64 x 64 • Max - Normal Type: 15360 (W) x 8640 (H) • Progressive Type: 1920 (W) x 1440 (H)
3D (For 3D TV)	mpo	Supported file format	<ul style="list-style-type: none"> • mpo
		Photo size	<ul style="list-style-type: none"> • 4:3 size: 3,648 x 2,736 2,592 x 1,944 2,048 x 1,536 • 3:2 size: 3,648 x 2,432
Music	<ul style="list-style-type: none"> • MP3 • Bit rate range: 32 Kbps - 320 Kbps • Sampling rate (Sampling Frequency) MPEG1 layer 3: 32 kHz, 44.1 kHz, 48 kHz MPEG2 layer 3: 16 kHz, 22.05 kHz, 24 kHz * A copy-protected file will not play. 		

Viewing videos

Play video files on the TV. Your TV can display video files from a USB storage device.

- 1 Press **HOME** to access the Home menu.
- 2 Press the Navigation buttons to scroll to **Smart Share** and press **ENTER**.
- 3 Press the Navigation buttons to scroll to **Movie List** and press **ENTER**.
- 4 Press Navigation buttons to select a folder or file you want and press **ENTER**.
- 5 Play a movie by using the following menus/ buttons.

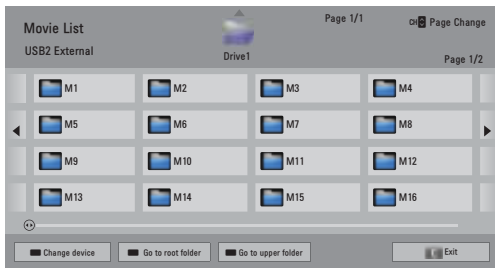

Button	Description
Navigation button	Scrolls the file.
ENTER	Plays the highlighted file.
CH (▲, ▼)	Moves to the previous or next page.
Red button	Change device: Changes to a different input.
Green button	Go to root folder.
Yellow button	Go to upper folder.

- 7 Control playback by using the following buttons.

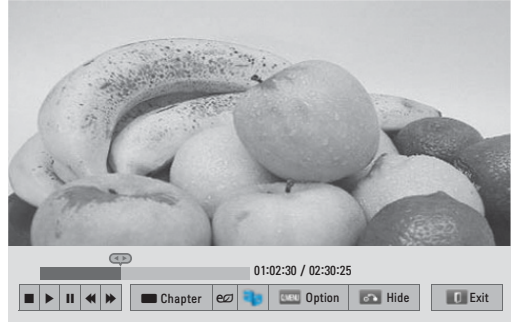

Button	Description
■	Stops the playback.
▶	Plays a video.
⏸	Pauses or resumes the playback
◀	Scans backward in a file
▶	Scans forward in a file
⏪ and ⏩	Plays videos in slow motion
Red button and < or >	Selects the frame directly. The entire file is divided into 10 frames. Frames may not be displayed depending on the file.
ENERGY SAVING	Increases or decreases the brightness of your screen.
●.MENU	Shows the Option menu (See p.70).
3D	Views the 3D imaging.
AV MODE	Select the desired source
BACK	Hides the menu on screen. To see the menu again, press ENTER button to display.
EXIT	Moves to the previous menu screen.

Tips for playing video files

- Some user-created subtitles may not work properly.
- Subtitles may not display some special characters or HTML tags.
- **Changing font and color in subtitles is not supported.**
- Subtitles in the non-supported languages are unavailable.
- **Video files with subtitle files of 1 MB or larger may not be played properly.**
- **The time information in an external subtitle file should be arranged in ascending order to play.**
- The screen may suffer from temporary interruptions such as image stoppage or faster playback when you change the audio language.
- If you play a damaged video file, the video file may not be played correctly or some player functions may not be available.
- The TV may not properly play the video files produced with certain encoders.
- If the recorded file does not have video or audio, either video or audio is not outputted.
- If the TV plays the recorded file without video or audio, either video or audio is not outputted.
- The TV may not smoothly play the video files with a resolution higher than the supported resolution for each frame.
- The TV may not properly play the video files not included on the specified type and format.
- The TV may not play the files encoded with GMC (Global Motion Compensation) or quarter-pel motion estimation.
- The TV supports the only 10,000 sync blocks within the subtitle file.
- The TV supports the H.264/AVC codec up to the profile level 4.1.
- The TV does not support DTS audio codec.
- The TV cannot play a video file whose size is larger than 30 GB.
- If you play a video file through the USB connection that does not support the high speed, the video player may not work properly.
- The video file and its subtitle should be in the same folder and the name of the video file and subtitle should be identical.
- The TV may not play the video files in the supported file format depending on the encoded condition.
- Trick Mode does not support other functions than ►► if video files do not have index information.
- Video file names that contain special characters may not be playable.

Q.MENU options for movie list

- 1 Press **●**. **MENU**.
A pop-up window will appears.
- 2 Press the Navigation buttons to scroll to movie list option and press **ENTER**.
- 3 Press the Navigation buttons to scroll to one of the following options and press **ENTER**.

Set Video Play.

Option	Description	
Picture Size	Selects your desired picture format for videos. <ul style="list-style-type: none"> • Full Mode: Files are played in full screen mode according to the aspect ratio of video. • Original Mode: Original file size are played. 	
Audio Language	Changes the Language Group of the audio for video files. Files with a single audio track cannot be selected.	
Subtitle Language	The subtitles can be turned on or off.	
Language	Activated for SMI subtitles and can select the language within the subtitle.	
Code Page	Subtitle font selection. When set to default, contents are displayed in the language set in "Option - Language - Menu Language."	
	Option	Description
	Subtitle Language Group	Latin1: English, Spanish, French Korean: English, Korean
	Sync	When the video is not synchronized with the captions, it can be adjusted by 0.5 second.
	Position	Move the location of the subtitles.
	Size	Changes the subtitle font size.
Repeat	Turn on/off repeat function of movie playback. When turned on, the file within the folder will be played back repeatedly. When turned off, if the next file name is similar to the previous file, it can be played sequentially.	

! NOTE

- When replaying a video file after stopping, you can play from where it stopped automatically.
- If you select "Yes" when playing the same file after the video file has been stopped, it will restart where it stopped previously.
- If continuous series files exist within the folder, the next file will automatically be played. But, this excludes cases when the Repeat function of Movie List Option is turned "On".

Set Video.

Control the menu option (Refer to "PICTURE Settings" on page 82).

Set Audio.

Control the menu option (Refer to "AUDIO Settings" on page 87).

Set DivX PLUS HD

Option	Description
Title	두 개 이상의 타이틀이 있는 파일인 경우 타이틀을 선택하여 재생할 수 있습니다.
Edition	소제목이 여러 개인 파일인 경우 소제목 중 하나를 선택하여 재생할 수 있습니다. <ul style="list-style-type: none"> • 소제목이란 탐색 구간을 기준으로 재생 순서를 설정한 정보입니다.
Authorized Chapter	원하는 탐색구간을 선택하여 재생할 수 있습니다.

DivX registration code

Registering the DivX code

Check and register the DivX registration code of your TV so that you can rent or purchase the latest movies at www.divx.com/vod. To play a rented or purchased DivX file, the file's registration code should be same with your TV's DivX registration code.

- 1 Press **MENU** to access the Home menu.
- 2 Press the Navigation buttons to scroll to **SETUP** and press **ENTER**.
- 3 Press the Navigation buttons to scroll to **Smart Share Setting (DivX/DLNA)** and press **ENTER**.
- 4 Press the Navigation buttons to scroll to **DivX VOD Registration** and press **ENTER**.
- 5 View the registration code of your TV.

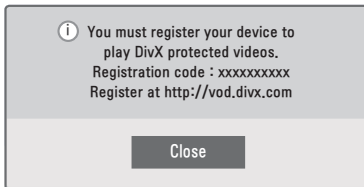

- 6 When you are finished, press **EXIT**.

NOTE

- While you are checking the registration code, some buttons may not work.
- If you use the DivX registration code of another device, you cannot play the rented or purchased DivX file. Make sure to use the DivX registration code assigned to your TV.
- The video or audio files that are not converted by the standard DivX codec may be corrupted or not be played.
- The DivX VOD code allows you to activate up to 6 devices under one account.

Deactivating the DivX feature

Deactivate all of the devices through the web server and block devices from activating. Delete the existing authentication information to receive a new DivX user authentication for the TV. Once this function is executed, a DivX user authentication is required again to see DivX DRM files.

- 1 Press **MENU** to access the Home menu.
- 2 Press the Navigation buttons to scroll to **SETUP** and press **ENTER**.
- 3 Press the Navigation buttons to scroll to **Smart Share Setting (DivX/DLNA)** and press **ENTER**.
- 4 Press the Navigation buttons to scroll to **DivX Deactivation** and press **ENTER**.
- 5 Select **Yes** to confirm.

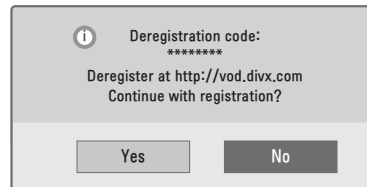

- 6 When you are finished, press **EXIT**.

Viewing photos

View image files saved in a USB storage device. The displays on the screen may differ from the model.

- 1 Press **HOME** to access the Home menu.
- 2 Press the Navigation buttons to scroll to **Smart Share** and press **ENTER**.
- 3 Press the Navigation buttons to scroll to **Photo List** and press **ENTER**.
- 4 Press Navigation buttons to select a folder or file you want and press **ENTER**.
- 5 View a photo by using the following menus/ buttons.

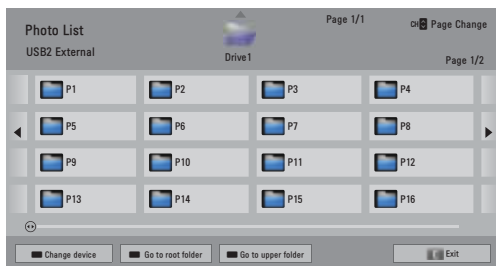

Button	Description
Navigation button	Scrolls the file.
ENTER	Views the highlighted file.
CH (▲, ▼)	Moves to the previous or next page.
Red button	Change device: Changes to a different input.
Green button	Go to root folder.
Yellow button	Go to upper folder.

- 7 Use the following options while viewing photos.

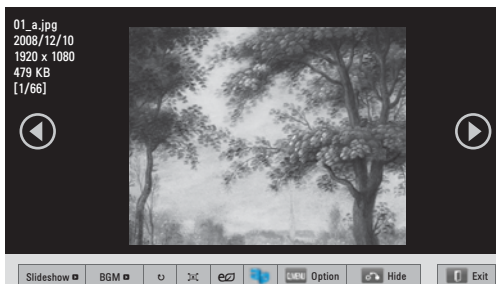

Option	Description
Slideshow	<ul style="list-style-type: none"> Starts or stops a slideshow. All photos saved in the current folder display during a slideshow. To set a slideshow speed, select Option.
BGM (Background Music)	<ul style="list-style-type: none"> Turns the background music on or off. To set the background music folder, select Option. <p>NOTE</p> <ul style="list-style-type: none"> You can't change or set-up the BGM while viewing the *.mpo file (3D camera file).
⌚ (Rotate)	<p>Rotates photos clockwise (90°, 180°, 270°, 360°).</p> <p>NOTE</p> <ul style="list-style-type: none"> The supported photo size is limited. You cannot rotate a photo if the resolution of the rotated width is larger than the supported resolution size.
⌕ (Full/Original)	Views the photo in full mode or original mode.
e (ENERGY SAVING)	Increases or decreases the brightness of your screen
3D	Views the 3D imaging.
Option	Shows the Option menu (See p.73).
Hide	Hides the option window. To display the options, press ENTER .
Exit	Moves to the previous menu screen.

NOTE

- Option values changed in Photo List do not affect Movie List and Music List.
- Option values changed in Photo List or Music List are changed likewise in Photo List and Music List, but not Movie List.

Q.MENU options for photo list

- 1 Press **●**. **MENU**.
A pop-up window will appear.
- 2 Press the Navigation buttons to scroll to photo list option and press **ENTER**.
- 3 Press the Navigation buttons to scroll to one of the following options and press **ENTER**.

Set Photo View.

Option	Description
Slide Speed	Selects a slideshow speed (Fast, Medium, Slow).
BGM	Selects a music folder for the background music. Select Repeat or Random option. <div data-bbox="308 1004 631 1149" style="border: 1px solid black; padding: 5px;"> <p>NOTE</p> <ul style="list-style-type: none"> • You cannot change the music folder while the background music is playing. </div>

NOTE

- You cannot select the Option in 3D imaging mode. (Only 3D models)

Set Video.

Control the menu option ([Refer to "PICTURE Settings" on page 82](#)).

Set Audio.

Control the menu option ([Refer to "AUDIO Settings" on page 87](#)).

Listening to music

- 1 Press **HOME** to access the Home menu.
- 2 Press the Navigation buttons to scroll to **Smart Share** and press **ENTER**.
- 3 Press the Navigation buttons to scroll to **Music List** and press **ENTER**.
- 4 Press Navigation buttons to select a folder or file you want and press **ENTER**.
- 5 Play music by using the following menus/ buttons.



Button	Description
Navigation button	Scrolls the file.
ENTER	Plays the highlighted file.
CH (▲, ▼)	Moves to the previous or next page.
Red button	Change device: Changes to a different input.
Green button	Go to root folder.
Yellow button	Go to upper folder.
Blue button	Open music player. It is enabled during palyng a music.

- 7 Control playback by using the following buttons.

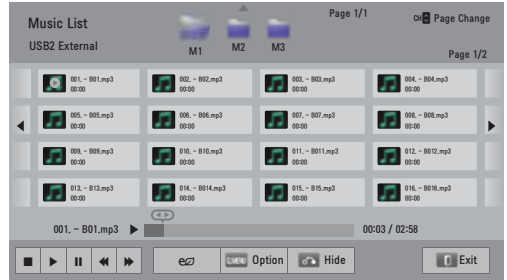

Button	Description
■	Stops playback.
▶	Plays a music file.
⏸	Pauses or resumes playback.
⏪	Skips to the next file.
⏩	Skips to the previous file.
< or >	Indicates a cursor
eO (ENERGY SAVING)	Increases or decreases the brightness of your screen.
●.MENU	Shows the Option menu (See p.74).
BACK	Hides the option window. To display the options, press ENTER .
EXIT	Moves to the previous menu screen.

Q.MENU options for music list

- 1 Press ●.MENU.
A pop-up window will appears.
- 2 Press the Navigation buttons to scroll to music list option and press **ENTER**.
- 3 Press the Navigation buttons to scroll to one of the following options and press **ENTER**.

NOTE

- Option values changed in Movie List does not affect Photo List and Music List.
- Option value changed in Photo List and Music List are changed likewise in Photo List and Music List excluding Movie List.

Set Audio Play.

Select Repeat or Random option.

Set Audio.

Control the menu option ([Refer to "AUDIO Settings"](#) on page 87).

! NOTE

- A copy-protected file will not play.
- If the TV is not in use for some time during playback, the information box as a screensaver will appear to prevent image burn.

To return to the Music list screen, press **ENTER**.

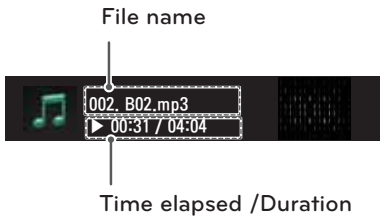

3D IMAGING (FOR 3D TV)

3D Technology

This TV can display in 3D via 3D broadcasting or when the TV is connected to a compatible device, such as a Blu-ray 3D Player. You need such a device to watch the TV in 3D. The 3D TV displays two separate pictures formatted for each eye. The viewer needs to wear 3D glasses in order to see these images in 3D format.



WARNING

- When viewing 3D imaging, watch the TV from an effective viewing angle and within the appropriate distance. The appropriate angle and distance are provided on the next page of this manual. If you exceed this viewing angle or distance, you may not be able to view the 3D imaging. Furthermore, the 3D imaging may not display if it is viewed while you are lying down (For LED LCD TV).
- If you watch the 3D imaging too closely or for a long period of time, it may harm your eyesight.
- Watching the TV or playing video games that incorporate 3D imaging with the 3D glasses for a long period of time can cause drowsiness, headaches or fatigue to you and/or your eyes. If you have a headache, or otherwise feel fatigued or drowsy, stop watching the TV and take a rest.
- Pregnant woman, seniors, persons with heart problems or persons who experience frequent drowsiness should refrain from watching 3D TV.
- Some 3D imaging may cause you to duck or dodge the image displayed in the video. Therefore, it is best if you do not watch 3D TV near fragile objects or near any objects that can be knocked over easily.
- Please prevent children under the age of 5 from watching 3D TV. It may affect their vision development.
- Warning for photosensitization seizure: Some viewers may experience a seizure or epilepsy when exposed to certain factors, including flashing lights or images in TV or video games. If you or anybody from your family has a history of epilepsy or seizure, please consult with your doctor before watching 3D TV. Also certain symptoms can occur in unspecified conditions without any previous history. If you experience any of the following symptoms, immediately stop watching the 3D imaging and consult a doctor: dizziness or lightheadedness, visual transition or altered vision, visual or facial instability, such as eye or muscle twitching, unconscious action, convulsion, loss of conscience, confusion or disorientation, loss of directional sense, cramps, or nausea. Parents should monitor their children, including teenagers, for these symptoms as they may be more sensitive to the effects of watching 3D TV.
- Risk of photosensitization seizure can be reduced with the following actions.
 - » Take frequent breaks from watching 3D TV.
 - » For those who have vision that is different in each eye, they should watch the TV after taking vision correction measures.
 - » Watch the TV so that your eyes are on the same level as the 3D screen and refrain from sitting too closely to the TV.
 - » Do not watch the 3D imaging when tired or sick, and avoid watching the 3D imaging for a long period of time.
 - » Do not wear the 3D glasses for any other purpose than viewing 3D imaging on a 3D TV.
 - » Some viewers may feel disoriented after watching 3D TV. Therefore, after you watch 3D TV, take a moment to regain awareness of your situation before moving.

**NOTE**

(For LW7700, LW9500, LZ9700, PZ950 series)

- To watch the TV in 3D, you must put on your 3D glasses. For best results, you should wear LG Brand 3D glasses. The 3D imaging may not display properly when using another brand of 3D glasses. Please see the 3D glasses manual for instructions on how to use the 3D glasses.
- After powering on the TV, a few seconds may be needed for your TV to calibrate.
- It may take a moment for you to see the 3D imaging if you look away from the TV and then revert your eyes back to the 3D program.
- The TV may flicker slightly if the 3D imaging is displayed under 3 wavelength fluorescent light (50 Hz - 60 Hz) or magnetic fluorescent lamp (50Hz - 60 Hz). In such instances, it is recommended to turn the lights off.
- If there is an obstacle between the TV and the 3D glasses, the 3D imaging may not display properly.
- Do not use the TV in close proximity to other electronic equipments and RF equipments.
- In Analog TV, 3D Imaging does not work.
- When watching 2D images, it is recommended to take off the 3D glasses. If you watch 2D images with the 3D glasses on, you may see distorted images.

When using 3D Glasses

**CAUTION**

- Do not use the 3D glasses to replace your corrective glasses, sunglasses or protective goggles.
- Do not store the 3D glasses in hot or cold locations.
- Do not drop objects onto the 3D glasses. Do not drop or bend the glasses.
- Since the lenses of the 3D glasses are easily scratched, make sure to clean only with a soft cloth. Shake off any dust before using the cloth since the glasses are easily scratched.

3D Imaging viewing range

(For LW7700, LW9500, LZ9700, PZ950 series)
TV size, viewing angle & other circumstances may change the viewing distance and the angle of view.

Viewing Distance	Viewing Angle
2 m - 15 m (6.5 ft - 49.2 ft)	120 ° (When the viewing distance is 2 m (6.5 ft))

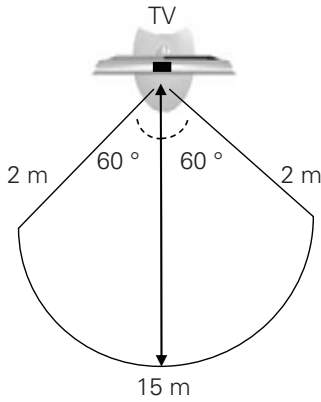



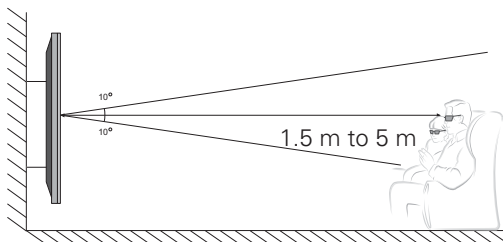

(For LW5600, LW5700, LW6500 series)
TV size, viewing angle & other circumstances may change the viewing distance and the angle of view.

Viewing Distance	Viewing Angle
1.5 m - 5 m (? ft - ? ft)	Top/Bottom 10 °



Viewing 3D Imaging

- 1 Play the video produced in 3D.
- 2 Press **3D** to watch 3D imaging.
- 3 Wear the 3D glasses.
- 4 Press the Navigation buttons to scroll the **OK** and press **ENTER**.
- 5 Press the Navigation buttons to select the shape and press **ENTER**.

Mode	Description
2D » 3D	Changed from 2D imaging to 3D imaging. 
Side by Side	
Top & Bottom	
Checker Board	
Frame Sequential	

- 6 Press **3D** button to **2D Off** or **3D Off**.



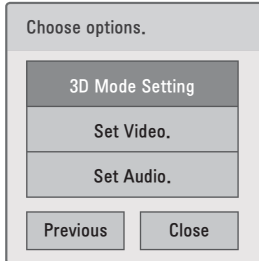

Option	Description
3D -> 2D	3D 효과가 제거된 2D 영상으로 감상합니다.
3D Off	입력된 원본 영상으로 감상합니다.
2D -> 3D	3D 효과를 적용합니다.
Cancel	Close the pop-up window.

Setting 3D Imaging

- 1 Press the **3D SETTING** while viewing 3D imaging.
A pop-up window will appear.
- 2 Press the Navigation buttons to scroll to one of the following options and press **ENTER**.



3D Mode Setting

Option	Description
Image View Mode	3D 효과 적용 또는 2D 영상 보기를 선택할 수 있습니다.
3D Picture Size ()	Cuts off the outer edges of the picture and stretch it to fit the full screen in 3D mode.
3D Image Type ()	?
3D Effects	Adjusts the distance between the object and the background in the picture to enhance the 3D effect in 2D to 3D mode.
3D Viewpoint	Brings the picture (including both the object and background images) to the front or back to enhance the 3D effect in 3D mode.
3D Picture Balance ()	Adjusts the color and brightness difference between the right and left sides of the picture in 3D mode.
3D Optimization ()	입체영상에서 카메라 특성 혹은 제작 단계에서 L, R의 영상이 밝기, 색 등이 차이가 나는 경우가 있는데 이를 보정하는 기능입니다. Adjusts the brightness and the contrast difference between the left and the right sides of the 3D image, which is caused during recording or due to certain features of the camera.

Set Video.

Control the menu option (Refer to "PICTURE Settings" on page 82).

Set Audio.

Control the menu option (Refer to "AUDIO Settings" on page 87).



CAUTION

- Some menus may not work while viewing 3D imaging.
- The 3D imaging is disabled automatically when switching input source.
- The screen may not be displayed properly if you view 2D DTV images in 3D imaging mode.
- 3D effect can be seen when 3D Mode is selected appropriately for the 3D input signal supplied to the TV.
- For *.mpo files (3D camera files), the 3D imaging mode is enabled automatically.
- To enable the 3D imaging mode, you can also press the ENTER button on the Magic Motion remote control.











NOTE

- If viewing 3D imaging, "Power indicator" is turned off automatically.
- You can only choose "Standard or Cinema" with the **AV MODE** button on the remote control. AV Mode is set as Standard while playing in 3D.
- Energy Saving is disabled while playing in 3D.

CUSTOMIZING TV SETTINGS

Accessing SETUP Menu

- 1 Press **HOME** to access the Home menu.
- 2 Press the Navigation buttons to select the **SETUP** menu and press **ENTER**.
- 3 Press the Navigation buttons to scroll to one of the following menus and press **ENTER**.
- 4 Press the Navigation buttons to scroll to the setting or option you want and press **ENTER**.
- 5 When you are finished, press **EXIT**.

Menu		Description
	CHANNEL	Sets up and edit channels.
	PICTURE	Adjusts the image size, quality, or effect.
	AUDIO	Adjusts the sound quality, effect, or volume level.
	TIME	Sets the time, date, or Timer feature.
	LOCK	Locks or unlocks channels and programs.
	OPTON	Customizes the general settings.
	NETWORK	Sets up the network setting.
	CUSTOMER SUPPORT	Checks the customer information.

Customizing Settings

CHANNEL Settings

- 1 Press **HOME** to access the Home menu.
- 2 Press the Navigation buttons to scroll to **SETUP** and press **ENTER**.
- 3 Press the Navigation buttons to scroll to **CHANNEL** and press **ENTER**.
- 4 Press the Navigation buttons to scroll to the setting or option you want and press **ENTER**.
 - To return to the previous level, press **BACK**.
- 5 When you are finished, press **EXIT**.

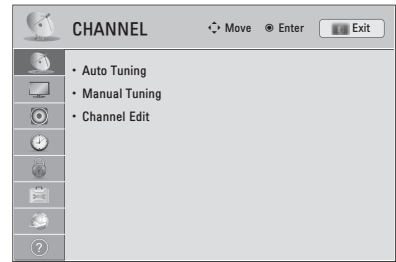

The available channel settings are described in the following.

Setting	Description
Auto Tuning	Tunes and stores all available channels through antennas or cable inputs (See p.44).
Manual Tuning	Tunes and stores the channels you want manually (See p.44).
Channel Edit	Adds or deletes channels on the channel (See p.44).

PICTURE Settings

- 1 Press **HOME** to access the Home menu.
- 2 Press the Navigation buttons to scroll to **SETUP** and press **ENTER**.
- 3 Press the Navigation buttons to scroll to **PICTURE** and press **ENTER**.
- 4 Press the Navigation buttons to scroll to the setting or option you want and press **ENTER**.
 - To return to the previous level, press **BACK**.
- 5 When you are finished, press **EXIT**.

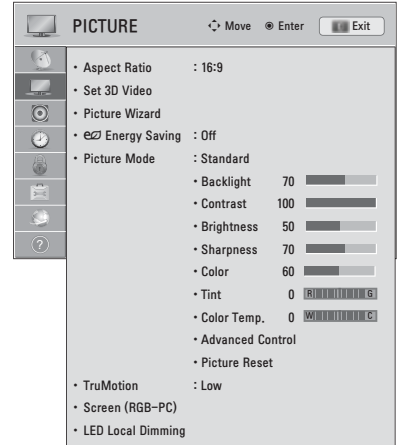

The available picture settings are described in the following.

Setting	Description												
Aspect Ratio	Changes the image size to view images at its optimal size (See p.47).												
Picture Wizard (LCD)	<p>Adjusts the image quality and calibrates the screen The customized options will be saved as Expert1 in the Picture Mode.</p> <div style="border: 1px solid black; padding: 5px;"> <p>NOTE</p> <ul style="list-style-type: none"> If you use Picture Wizard, the Energy Saving feature will turn off automatically. To reset changes made by Picture Wizard, operate Picture Reset when Picture Mode is on Expert1. </div>												
Set 3D Video (For 3D TV)	Sets the 3D imaging option (See p.79).												
Energy Saving	<p>Reduces the power consumption by adjusting the screen brightness.</p> <div style="border: 1px solid black; padding: 5px;"> <p>NOTE</p> <ul style="list-style-type: none"> When selecting Auto or Maximum, Backlight will not work (LCD). </div> <table border="1" style="width: 100%; border-collapse: collapse;"> <thead> <tr> <th colspan="2">Option</th> </tr> </thead> <tbody> <tr> <td style="width: 30%;">Auto (LCD)</td> <td>The backlight is adjusted automatically corresponding to the surroundings when selecting Auto using the Intelligent sensor feature.</td> </tr> <tr> <td>Intelligent sensor (Plasma)</td> <td>The most suitable picture is automatically adjusted corresponding to the surroundings.</td> </tr> <tr> <td>Off</td> <td>Select if this feature is not necessary.</td> </tr> <tr> <td>Minimum/ Medium/Maximum</td> <td>Selects the brightness level.</td> </tr> <tr> <td>Screen off (LCD)</td> <td>The screen turns off in 3 seconds. Pressing any button of the remote control will turn on the screen again.</td> </tr> </tbody> </table>	Option		Auto (LCD)	The backlight is adjusted automatically corresponding to the surroundings when selecting Auto using the Intelligent sensor feature.	Intelligent sensor (Plasma)	The most suitable picture is automatically adjusted corresponding to the surroundings.	Off	Select if this feature is not necessary.	Minimum/ Medium/Maximum	Selects the brightness level.	Screen off (LCD)	The screen turns off in 3 seconds. Pressing any button of the remote control will turn on the screen again.
Option													
Auto (LCD)	The backlight is adjusted automatically corresponding to the surroundings when selecting Auto using the Intelligent sensor feature.												
Intelligent sensor (Plasma)	The most suitable picture is automatically adjusted corresponding to the surroundings.												
Off	Select if this feature is not necessary.												
Minimum/ Medium/Maximum	Selects the brightness level.												
Screen off (LCD)	The screen turns off in 3 seconds. Pressing any button of the remote control will turn on the screen again.												



Setting	Description
Picture Mode	Selects one of the preset image or customizes options in each mode for the best TV screen performance. You are also able to customize advanced options of each mode. The available preset picture modes vary depending on the TV.
	Mode (Depending on model)
Intelligent Sensor	Sets the TV to adjust the image settings, such as contrast, brightness, sharpness, color, or tint, automatically corresponding to the surrounding environments.
Vivid	Adjusts the video image for the retail environment by enhancing the contrast, brightness, color, and sharpness.
Standard	Adjusts the image for the normal environment.
APS	Maximizes the video image reducing the power consumption without hurting the picture quality.
Cinema	Optimizes the video image for a cinematic look to enjoy movies as if you are in a movie theater.
THX Cinema, THX Bright Room	<p>Provides the experience of watching a movie at home. The user will be able enjoy the best level of satisfactory screen quality in any movie without any separate adjustments.</p> <ul style="list-style-type: none"> » THX Cinema express the optimal screen quality when it is darkest. » THX Bright Room express the optimal screen quality when it is brightest. <div style="border: 1px solid black; padding: 5px; margin-top: 10px;"> <p>NOTE</p> <ul style="list-style-type: none"> • THX : THX (Thomlinson Holman’s Experiment) is an audio and video certification standard established by George Lucas and Thomlinson. A THX certified display guarantees screen quality that exceeds the display standard specification in both hardware and software. </div>
Sport	Optimizes the video image for high and dynamic actions by emphasizing primary colors such as white, grass, or sky blue.
Game	Optimizes the video image for a fast gaming screen such as PCs or games.
Expert	<p>Adjusts the detailed video image settings for video experts as well as general viewers.</p> <div style="border: 1px solid black; padding: 5px; margin-top: 10px;"> <p>NOTE</p> <ul style="list-style-type: none"> • ISFccc (ISFccc: Imaging Science Foundation Certified Calibration Control) : This TV contains the detailed calibrations necessary for professional certification by the Imaging Science Foundation. The resulting ISF “day” and “night” modes will then be accessible by the user to experience the best their LG HDTV has to offer. Sophisticated and detailed calibrations can be made through the ISFccc mode. Detailed calibration requires a licensed technician. Please contact your local dealer to inquire about an ISF certified technician. </div>
	<div style="border: 1px solid black; padding: 5px;"> <p>NOTE</p> <ul style="list-style-type: none"> • If you select Intelligent Sensor, the option of the Energy saving feature will switch to Auto automatically (Lcd). • If you selecting Cinema, THX Cinema or THX Bright, the option of the Aspect ratio feature will switch to Just scan automatically. </div>



Setting	Description												
TruMotion 	<p>Advance video technology that provides clearer, smoother images, even during fast action scenes creating a more stable structure for a crisper picture.</p> <p>TruMotion works with all inputs except PC mode.</p> <p>If you enable "TruMotion", noise may appear on the screen. If this occurs, set "TruMotion" to "Off". If you select "Picture Mode-Game", set "TruMotion" to "Off".</p>												
	Mode												
	<table border="1"> <tr> <td>High</td> <td>Provides smoother picture movement.</td> </tr> <tr> <td>Low</td> <td>Provides smooth picture movement. Use this setting for standard use.</td> </tr> <tr> <td>Off</td> <td>Turn off TruMotion operation.</td> </tr> <tr> <td>User</td> <td>De-Judder: Adjusts noise of the screen. De-Blur: Adjusts after-image of the screen.</td> </tr> </table>	High	Provides smoother picture movement.	Low	Provides smooth picture movement. Use this setting for standard use.	Off	Turn off TruMotion operation.	User	De-Judder: Adjusts noise of the screen. De-Blur: Adjusts after-image of the screen.				
	High	Provides smoother picture movement.											
	Low	Provides smooth picture movement. Use this setting for standard use.											
Off	Turn off TruMotion operation.												
User	De-Judder: Adjusts noise of the screen. De-Blur: Adjusts after-image of the screen.												
SCREEN (RGB-PC)	<p>Customizes the PC display options.</p>												
	Option												
	<table border="1"> <tr> <td>Resolution</td> <td>Selects a proper resolution when your PC uses 1024 X 768, 1280 X 768, or 1360 X 768 resolution.</td> </tr> <tr> <td>Auto Configure</td> <td>Sets the TV to optimize the options automatically for the TV display.</td> </tr> <tr> <td>Position</td> <td>Locates the image at the proper position.</td> </tr> <tr> <td>Size</td> <td>Adjusts the image size.</td> </tr> <tr> <td>Phase</td> <td>Eliminates horizontal streaking.</td> </tr> <tr> <td>Reset</td> <td>Restores the options to the default setting.</td> </tr> </table>	Resolution	Selects a proper resolution when your PC uses 1024 X 768, 1280 X 768, or 1360 X 768 resolution.	Auto Configure	Sets the TV to optimize the options automatically for the TV display.	Position	Locates the image at the proper position.	Size	Adjusts the image size.	Phase	Eliminates horizontal streaking.	Reset	Restores the options to the default setting.
	Resolution	Selects a proper resolution when your PC uses 1024 X 768, 1280 X 768, or 1360 X 768 resolution.											
	Auto Configure	Sets the TV to optimize the options automatically for the TV display.											
	Position	Locates the image at the proper position.											
	Size	Adjusts the image size.											
Phase	Eliminates horizontal streaking.												
Reset	Restores the options to the default setting.												
LED Local Dimming (Depending on model)	<p>After analyzing the signal of the input video by areas of the screen, it adjusts the backlight to improve the contrast ratio.</p>												

Basic Image Options

Setting	Description
Backlight 	<p>Adjusts the brightness of the screen by controlling the LCD backlight. If you decrease the brightness level, the screen becomes darker and the power consumption will be reduced without any video signal loss.</p> <div style="border: 1px solid black; padding: 5px; margin-top: 10px;"> <p>NOTE</p> <ul style="list-style-type: none"> If you use the "Energy saving - Off, Minimum, Medium", Backlight will be available. </div>
Contrast	Increases or decreases the gradient of the video signal. You may use Contrast when the bright part of the picture is saturated.
Brightness	Adjusts the base level of the signal in the picture.
Sharpness	Adjusts the level of crispness in the edges between the light and dark areas of the picture. The lower the level, the softer the image.
Color	Adjusts intensity of all colors.
Tint	Adjusts the balance between red and green levels.
Color Temp.	Set to warm to enhance hotter colors such as red, or set to cool to enhance cooler colors such as blue.
Advanced Control or Expert Control	Customizes the advanced options.
Picture Reset	Restores the options of each mode to the factory default.

Advanced Image Options (Depending on model)

Setting	Description
Dynamic Contrast	Adjusts the contrast to keep it at the best level according to the brightness of the screen. The picture is improved by making bright parts brighter and dark parts darker.
Dynamic Color	Adjusts screen colors so that they look livelier, richer and clearer. This feature enhances hue, saturation and luminance so that red, blue and green white look more vivid.
Skin Color	It detects the skin area of video and adjusts it to express a natural skin color.
Noise Reduction	Reduces screen noise without compromising video quality.
MPEG Noise Reduction	Removes noise caused by compressing video.
Super Resolution	Provides a crystal-clear picture by improving the details in an area that has a blurry or unclear picture.
Gamma	You can adjust brightness of dark area and middle gray level area of the picture. <ul style="list-style-type: none"> » Low: Make the dark and middle gray level areas brighter. » Medium: Express the original picture level. » High: Make the dark and middle gray level area darker.
Black Level	Sets black level of the screen to proper level. This function is available in the following modes: AV (NTSC-M), HDMI or Component. <ul style="list-style-type: none"> » Low: The reflection of the screen gets darker. » High: The reflection of the screen gets brighter.
Clear White	Make the white area of screen brighter and more white.
Eye Care	Adjusts the brightness of the screen to prevent the screen from being too bright. Dims extremely bright pictures. This feature is enabled in "Picture Mode-Standard, Game".
Real Cinema or Film Mode	Makes video clips recorded in film look more natural by eliminating judder effect. DVD and Blu-ray movies are filmed at 24 frames per second (fps). With LG Real Cinema, every frame is consistently processed 5 times in 1/24 of a second producing 120 fps with TruMotion or 2 times in 1/24 of a second producing 48 fps without TruMotion, thus totally eliminating the judder effect. This function can also work when TruMotion is off.
Color Gamut	Advanced Control () <ul style="list-style-type: none"> » Maximizes the utilization of color to increase color quality. » Standard: Displays standard set of colors. » Wide: Increase number of colors used.
	Expert Control ( ) Displays color domain of the signal. <ul style="list-style-type: none"> » Standard: Displays standard set of colors. » Wide: Increase number of colors used. » EBU: Mode to display EBU standard color area. » SMPTE: Mode to display SMPTE standard color area. » BT709: Mode to display BT709 standard color area.
Edge Enhancer	Shows clearer and distinctive yet natural edges of the video.
xvYCC	This is produces richer colors. This feature represents rich colors as much as a conventional video signal. This function is enabled in "Picture mode - Cinema, Expert" when xvYCC signal is inputted through HDMI.
Color Filter	This is the function to filter the specific colors of the video. You can use the RGB filter to set color saturation and hue accurately.
Expert Pattern	This is the pattern used for expert adjustment. This function is enabled in "Picture Mode - Expert" when you watch DTV.

Setting	Description
Color Temperature	Adjusts the overall color of the screen by changing the white baseline. a. Gamma : Select 1.9, 2.2, 2.4
	 a. Gamma : Select 1.9, 2.2, 2.4 b. Method : 2 Points <ul style="list-style-type: none"> • Pattern: Inner, Outer • Red/Green/Blue Contrast, Red/Green/Blue Brightness c. Method : 20 Point IRE <ul style="list-style-type: none"> • IRE (Institute of Radio Engineers) is the unit to display the size of the video signal and can be set among 0, 5, 10, 15 - 100 Plasma TV. You can adjust Red, Green or Blue according to each setting. • Red/Green/Blue: The adjustment range is -50 - +50. d. Apply to all inputs
	 a. Gamma : Select 1.9, 2.2, 2.4 b. Method : 2 Points <ul style="list-style-type: none"> • Pattern: Inner, Outer • Red/Green/Blue Contrast, Red/Green/Blue Brightness c. Method : 10 Point IRE <ul style="list-style-type: none"> • Pattern: Inner, Outer • IRE (Institute of Radio Engineers) is the unit to display the size of the video signal and can be set among 10, 20, 30 - 100. You can adjust Red, Green or Blue according to each setting. • Luminance: This function displays calculated luminance value for 2.2 gamma. You can input luminance value you want at 100 IRE, than the target luminance value for 2.2 gamma is displayed at every 10 steps from 10 IRE to 90 IRE. • Red/Green/Blue: The adjustment range is -50 - +50. d. Apply to all inputs
Color Management System	As the tool used by the experts to make adjustments by using the test patterns, this does not affect other colors but can be used to selectively adjust the 6 color areas (Red/Green/Blue/Cyan/Magenta/Yellow). Color difference may not be distinctive even when you make the adjustments for the general video. Adjusts Red/Green/Blue/Yellow/Cyan/Magenta. <ul style="list-style-type: none"> » Red/Green/Blue/Yellow/Cyan/Magenta Color: The adjustment range is -30 - +30. » Red/Green/Blue/Yellow/Cyan/Magenta Tint: The adjustment range is -30 - +30. » This feature is disable in RGB-PC and HDMI-PC mode.

AUDIO Settings

- 1 Press **HOME** to access the Home menu.
- 2 Press the Navigation buttons to scroll to **SETUP** and press **ENTER**.
- 3 Press the Navigation buttons to scroll to **AUDIO** and press **ENTER**.
- 4 Press the Navigation buttons to scroll to the setting or option you want and press **ENTER**.
 - To return to the previous level, press **BACK**.
- 5 When you are finished, press **EXIT**.

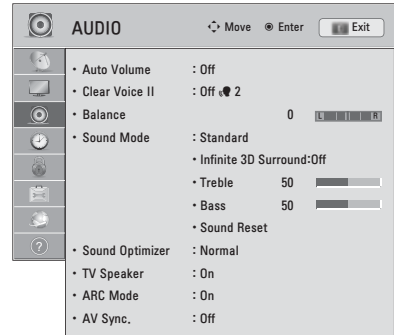

The available audio settings are described in the following.

Setting	Description																						
Auto Volume	Activates the Auto Volume feature to keep the volume level consistent whenever you change channels. The volume level may not be consistent due to different signal conditions of broadcasting stations.																						
Clear Voice II	Sets whether to enhance human voice clarity. You can adjust the level of clarity when you set this feature on. <div style="border: 1px solid gray; padding: 5px; margin-top: 10px;"> <p>NOTE</p> <ul style="list-style-type: none"> If the Clear voice II feature is on, Infinite 3D Surround will not be activated. </div>																						
Balance	Adjust balance between the left and right speakers according to your room environment.																						
Sound Mode	Selects one of the preset sound modes or customizes options in each mode. <table border="1" style="width: 100%; margin-top: 5px;"> <thead> <tr> <th colspan="2">Mode</th> </tr> </thead> <tbody> <tr> <td>Standard</td> <td>Select when you want standard-quality sound.</td> </tr> <tr> <td>Music</td> <td>Select when you listen to music.</td> </tr> <tr> <td>Cinema</td> <td>Select when you watch movies.</td> </tr> <tr> <td>Sport</td> <td>Select when you watch sports events.</td> </tr> <tr> <td>Game</td> <td>Select when you play games.</td> </tr> </tbody> </table> <div style="border: 1px solid gray; padding: 5px; margin-top: 10px;"> <p>NOTE</p> <ul style="list-style-type: none"> If sound quality or volume is not at the level you want, it is recommended to use a separate home theater system or amplifier to cope with different user environments. If the Clear Voice II feature is on, Infinite 3D Surround will not be activated. </div> <table border="1" style="width: 100%; margin-top: 5px;"> <thead> <tr> <th colspan="2">Option</th> </tr> </thead> <tbody> <tr> <td>Infinite 3D Surround</td> <td>Patents LG proprietary sound processing technology that strives immersive 5.1 surround sound with just two front speakers.</td> </tr> <tr> <td>Treble</td> <td>Controls the dominant sounds in the output. When you turn up the treble, it will increase the output to the higher frequency range.</td> </tr> <tr> <td>Bass</td> <td>Controls the softer sounds in the output. When you turn up the bass, it will increase the output to the lower frequency range.</td> </tr> <tr> <td>Sound Reset</td> <td>Resets the sound mode to the default setting.</td> </tr> </tbody> </table>	Mode		Standard	Select when you want standard-quality sound.	Music	Select when you listen to music.	Cinema	Select when you watch movies.	Sport	Select when you watch sports events.	Game	Select when you play games.	Option		Infinite 3D Surround	Patents LG proprietary sound processing technology that strives immersive 5.1 surround sound with just two front speakers.	Treble	Controls the dominant sounds in the output. When you turn up the treble, it will increase the output to the higher frequency range.	Bass	Controls the softer sounds in the output. When you turn up the bass, it will increase the output to the lower frequency range.	Sound Reset	Resets the sound mode to the default setting.
Mode																							
Standard	Select when you want standard-quality sound.																						
Music	Select when you listen to music.																						
Cinema	Select when you watch movies.																						
Sport	Select when you watch sports events.																						
Game	Select when you play games.																						
Option																							
Infinite 3D Surround	Patents LG proprietary sound processing technology that strives immersive 5.1 surround sound with just two front speakers.																						
Treble	Controls the dominant sounds in the output. When you turn up the treble, it will increase the output to the higher frequency range.																						
Bass	Controls the softer sounds in the output. When you turn up the bass, it will increase the output to the lower frequency range.																						
Sound Reset	Resets the sound mode to the default setting.																						

Setting	Description
Sound Optimizer	Optimizes the sound depending on the environment in which the TV is installed.
	Option
	Normal Normal sound mode.
	Wall Mount Type Optimized sound mode for a wall-mounted TV.
	Stand type Optimized sound mode for a stand-type TV.
TV Speaker	Turns on the internal speaker of the TV when using an external Hi-Fi system. You can use the TV speaker as an audio output device even if there is no video input.
ARC Mode (Audio Return Channel)	When using an external audio device with the ARC (Audio Return Channel) feature, optical SPDIF can be output using only a High Speed HDMI cable without an additional optical cable, and SIMPLINK can be enabled.
	 NOTE <ul style="list-style-type: none"> • Some HDMI cables may not support this mode. (A High Speed HDMI cable is recommended.) • The ARC mode only works for HDMI 1 • Activates the SIMPLINK feature to use this feature.
	Option
	On 연결된 ARC 장비가 켜져있으면 SIMPLINK 연결 후 자동으로 ARC 장비의 스피커로 전환됩니다.
	Off 연결된 ARC 장비가 켜져있고 SIMPLINK 연결하더라도 자동으로 ARC 장비의 스피커로 전환되지 않습니다.
AV Sync.	If the video and sound are not synced, you can adjust it manually. <ul style="list-style-type: none"> » (-) setting : Make audio output faster than the default. » (+) setting : Make audio output slower than the default.
	Option
	AV Sync. Adjusts the sync between the TV speaker and SPDIF.
	TV Speaker Adjusts the sync of the sound from the TV's internal speaker.
	SPDIF (Sony Philips Digital InterFace) Adjusts the sync of the sound from an external speaker connected to the digital audio output port.

TIME Settings

- 1 Press **HOME** to access the Home menu.
- 2 Press the Navigation buttons to scroll to **SETUP** and press **ENTER**.
- 3 Press the Navigation buttons to scroll to **TIME** and press **ENTER**.
- 4 Press the Navigation buttons to scroll to the setting or option you want and press **ENTER**.
 - To return to the previous level, press **BACK**.
- 5 When you are finished, press **EXIT**.

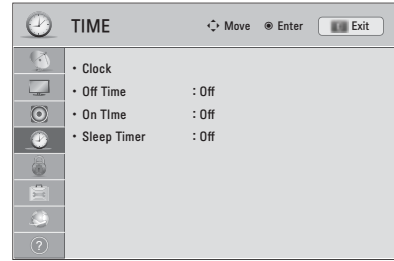

The available time settings are described in the following.

Setting	Description
Clock	Sets the time, date, time zone, and daylight-saving time feature. The time will be set automatically according to a digital channel signal which includes time information provided by the broadcasting station. If not, set the time and date manually.
Off Time/On Time	<p>Sets the time to turn on or off the TV automatically. To use this function, you should set the current time and date in advance.</p> <div style="border: 1px solid black; padding: 5px; margin-top: 10px;"> <p>NOTE</p> <ul style="list-style-type: none"> If you do not press any button within 2 hours after the TV turns on by the On Time feature, the TV enters the Standby mode automatically. If you set both Off time and On time features to the same time, the Off time feature overrides the On time feature. </div>
Sleep Timer	Sets the length of time until the TV to turns off. When you turn the TV off and turn it on again, the Sleep timer faature will be set to off.

LOCK Settings

- 1 Press **HOME** to access the Home menu.
- 2 Press the Navigation buttons to scroll to **SETUP** and press **ENTER**.
- 3 Press the Navigation buttons to scroll to **LOCK** and press **ENTER**.
- 4 Press the Navigation buttons to scroll to the setting or option you want and press **ENTER**.
 - To return to the previous level, press **BACK**.
- 5 When you are finished, press **EXIT**.

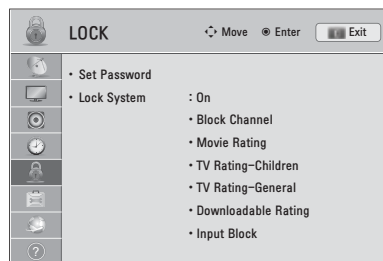

The available lock settings are described in the following.

Setting	Description	
Set Password	Changes the 4-digit password. The default PIN is "0 0 0 0". If you forget your password, press "0-3-2-5" on the remote control.	
Lock System	Activates or deactivates the lock system.	
Block Channel	Blocks the channels that contain inappropriate contents for children. The channels can be selected but the screen blank and the audio is muted. To watch a locked channel, enter the password.	
Movie Rating	Blocks the movies that are only broadcasted on the TV and contain inappropriate contents, based on the Motion Picture Association of America (MPAA) rating.	
	Rating	
	G	General audiences – All ages admitted
	PG	Parental guidance suggested – Some material may not be suitable for children
	PG-13	Parents strongly cautioned – Some material may be inappropriate for children under 13
	R	Restricted – Under 17 requires accompanying parent or adult guardian
	NC-17	No one 17 and under admitted.
X	Adults only	
TV Rating-Children (For USA)	Blocks the children's TV programs that parents do not want their children to watch. To block other TV programs, you should set the TV Rating-General feature.	
	Rating	
	Age	TV-Y (All children, including children from ages 2-6) TV-Y7 (Directed to older children, suitable for children age 6 and above)
	Fantasy Violence	TY-Y7 (Directed to older children – Fantasy violence, suitable for children age 6 and above, containing more intense or combative fantasy violence)

Setting	Description	
TV Rating-General (For USA)	Selecting Canadian English rating system.	
	Rating	
	Age	TV-G (General audience, suitable for all ages) TV-PG (Parental guidance suggested, containing material that are unsuitable for younger children) TV-14 (Parents strongly cautioned, containing material that are unsuitable for children age 14 and under) TV-MA (Mature audience only, unsuitable for children age under 17)
	Dialog (suggestive dialogue)	TV-PG or TV-14
	Language (coarse language)	TV-PG, TV-14, or TV-MA
	Sex (sexual situation)	TV-PG, TV-14, or TV-MA
	Violence	TV-PG, TV-14, or TV-MA
TV Rating-English (For Canada)	Selecting Canadian English rating system.	
	Rating	
	E	Exempt
	C	Children
	C8+	Children eight years and older
	G	General programming, suitable for all audiences
	PG	Parental Guidance
	14+	Viewers 14 years and older
	18+	Adult programming
Blocking Off	Permits all programs	
TV Rating-French (For Canada)	Selecting Canadian French rating system.	
	Rating	
	E	Exempt
	G	General
	8ans+	General-Not convenient for little children
	13ans+	Not convenient for children of 13 years and younger
	16ans+	Not convenient for children of 16 years and younger
	18ans+	This programs is only for adults
Blocking Off	Permits all programs	
Downloadable Rating	This function operates only when TV has received Region5 Rating data. The name of the rating option may differ. <div style="border: 1px solid black; padding: 10px; margin-top: 10px;"> <p> NOTE</p> <ul style="list-style-type: none"> This feature is available only for digital channels. </div>	
Input Block	Block the input sources.	

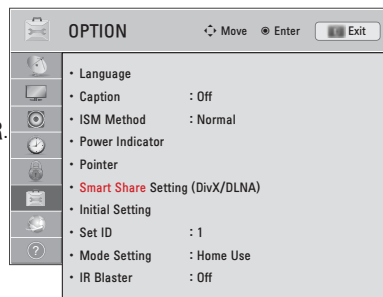

OPTION Settings

- 1 Press **HOME** to access the Home menu.
- 2 Press the Navigation buttons to scroll to **SETUP** and press **ENTER**.
- 3 Press the Navigation buttons to scroll to **OPTION** and press **ENTER**.
- 4 Press the Navigation buttons to scroll to the setting or option you want and press **ENTER**.
 - To return to the previous level, press **BACK**.
- 5 When you are finished, press **EXIT**.



The available general settings are described in the following.

Setting	Description
Language	Selects a desired language.
	Option
	Menu Language Selects a language for the display text. Audio Language Selects an audio language for your program. This feature operates only in the DTV or CADTV mode.
Caption	Sets whether to display captions and customize your option in each mode.
	Mode
	CC 1-4 (Closed Captioning) Displays the audio portion of a TV program as text on the TV screen. CC1 is the most common mode in use.
	Text 1-4 - Field 1 data channels: two Captions (CC1, CC2) and two Text (T1, T2). - Field 2 data channels: two Captions (CC3, CC4) and two Text (T1, T2).
	Service 1-6 This is only available for the digital broadcasting system.
	Option (For Digital Broadcasting)
	Size Selects the word size.
	Font Selects a typeface for the text.
	Text Color Selects a color for the text.
	Text Opacity Adjusts the opacity for the text color.
	Bg Color Selects a background color.
	Bg Opacity Adjusts the opacity for the background color.
	Edge Type Selects an edge type.
Edge Color Selects a color for the edges.	
Power Indicator (LED LCD TV)	Sets to turn on or off the indicator light on the TV.
	Option
	Standby Light Set to turn on or off the indicator light in Standby mode. Power Light Set to turn on or off the indicator light when you turn on the power.

Setting	Description								
ISM Method 	<p>Prevents image sticking or removes a ghost image. A frozen still picture displayed on the screen for prolonged periods can result in a ghost image.</p> <div style="border: 1px solid black; padding: 5px; margin: 10px 0;"> <p> NOTE</p> <ul style="list-style-type: none"> An excessive ghosted image may be impossible to clear entirely with White Wash. To return to normal viewing, press the any button. </div> <p>Mode</p> <table border="1" style="width: 100%; border-collapse: collapse;"> <tr> <td style="width: 20%;">Normal</td> <td>Sets it if image sticking is never a problem.</td> </tr> <tr> <td>Orbiter</td> <td>Avoids a ghost image on the screen. The image will move every 2 minutes to help prevent ghost images. However, it is best not to allow any fixed image to remain on the screen.</td> </tr> <tr> <td>Color Wash</td> <td>Removes a ghost image on the screen. The color block with the screen moved a little and the white pattern are alternately displayed. It is difficult to see the after image on all colors. Once it has been corrected it will not be visible in any color.</td> </tr> <tr> <td>White Wash</td> <td>Removes a ghost image on the screen. Use sparingly. Watch the TV normally for a while before using this feature to see if the ghost image disappears on its own.</td> </tr> </table>	Normal	Sets it if image sticking is never a problem.	Orbiter	Avoids a ghost image on the screen. The image will move every 2 minutes to help prevent ghost images. However, it is best not to allow any fixed image to remain on the screen.	Color Wash	Removes a ghost image on the screen. The color block with the screen moved a little and the white pattern are alternately displayed. It is difficult to see the after image on all colors. Once it has been corrected it will not be visible in any color.	White Wash	Removes a ghost image on the screen. Use sparingly. Watch the TV normally for a while before using this feature to see if the ghost image disappears on its own.
Normal	Sets it if image sticking is never a problem.								
Orbiter	Avoids a ghost image on the screen. The image will move every 2 minutes to help prevent ghost images. However, it is best not to allow any fixed image to remain on the screen.								
Color Wash	Removes a ghost image on the screen. The color block with the screen moved a little and the white pattern are alternately displayed. It is difficult to see the after image on all colors. Once it has been corrected it will not be visible in any color.								
White Wash	Removes a ghost image on the screen. Use sparingly. Watch the TV normally for a while before using this feature to see if the ghost image disappears on its own.								
Pointer (Depending on model)	<p>Sets the pointer option of the Motion remote control.</p> <p>Option</p> <table border="1" style="width: 100%; border-collapse: collapse;"> <tr> <td style="width: 20%;">Speed</td> <td>Changes the pointer speed.</td> </tr> <tr> <td>Shape</td> <td>Selects the pointer shape.</td> </tr> <tr> <td>Size</td> <td>Changes the pointer size.</td> </tr> <tr> <td>Alignment</td> <td>Align the remote control's direction with the pointer on your TV screen by shaking the remote control left and right. Then, the pointer automatically moves to the center of the screen.</td> </tr> </table>	Speed	Changes the pointer speed.	Shape	Selects the pointer shape.	Size	Changes the pointer size.	Alignment	Align the remote control's direction with the pointer on your TV screen by shaking the remote control left and right. Then, the pointer automatically moves to the center of the screen.
Speed	Changes the pointer speed.								
Shape	Selects the pointer shape.								
Size	Changes the pointer size.								
Alignment	Align the remote control's direction with the pointer on your TV screen by shaking the remote control left and right. Then, the pointer automatically moves to the center of the screen.								
Smart Share Setting (DivX/ DLNA)	<p>Sets the DivX and DLNA option.</p> <p>Option</p> <table border="1" style="width: 100%; border-collapse: collapse;"> <tr> <td style="width: 20%;">DivX Reg.Code</td> <td>Registers your TV to play DivX protected videos (See p.71).</td> </tr> <tr> <td>Deactivation</td> <td>Deactivates your TV (See p.71).</td> </tr> <tr> <td>DMR</td> <td>Activates or deactivates the DMR (Digital Media Render) connection.</td> </tr> </table>	DivX Reg.Code	Registers your TV to play DivX protected videos (See p.71).	Deactivation	Deactivates your TV (See p.71).	DMR	Activates or deactivates the DMR (Digital Media Render) connection.		
DivX Reg.Code	Registers your TV to play DivX protected videos (See p.71).								
Deactivation	Deactivates your TV (See p.71).								
DMR	Activates or deactivates the DMR (Digital Media Render) connection.								

Setting	Description												
Initial Setting	<p>Resets the TV to factory default and erases all stored channels. Customizes the TV settings to suit your preference. The initial setup screen will appear when you turn on the TV for the first time.</p> <div style="border: 1px solid black; padding: 5px; margin-top: 10px;"> <p> NOTE</p> <ul style="list-style-type: none"> When selecting “Lock System - On” in the LOCK menu, the message to enter the password appears. If you forget your password, press “0-3-2-5” on the remote control. </div> <table border="1" style="width: 100%; margin-top: 10px;"> <thead> <tr> <th data-bbox="312 490 491 529">Setting</th> <th data-bbox="491 490 1273 529"></th> </tr> </thead> <tbody> <tr> <td data-bbox="312 529 491 568">Language</td> <td data-bbox="491 529 1273 568">Selects a desired language.</td> </tr> <tr> <td data-bbox="312 568 491 799">Mode Setting</td> <td data-bbox="491 568 1273 799"> Selects Home Use for the home environment. Selects Store Demo for the retail environment. Selects Demo Mode to set to show special features of the TV. You can cancel the demo mode by pressing any buttons except the Volume and Mute buttons. </td> </tr> <tr> <td data-bbox="312 799 491 865">Power Indicator (LED LCD TV)</td> <td data-bbox="491 799 1273 865">Sets the power indicator.</td> </tr> <tr> <td data-bbox="312 865 491 904">Time Zone</td> <td data-bbox="491 865 1273 904">Sets the time zone and daylight saving.</td> </tr> <tr> <td data-bbox="312 904 491 942">Auto Tuning</td> <td data-bbox="491 904 1273 942">Scans and saves available channels automatically.</td> </tr> </tbody> </table>	Setting		Language	Selects a desired language.	Mode Setting	Selects Home Use for the home environment. Selects Store Demo for the retail environment. Selects Demo Mode to set to show special features of the TV. You can cancel the demo mode by pressing any buttons except the Volume and Mute buttons.	Power Indicator (LED LCD TV)	Sets the power indicator.	Time Zone	Sets the time zone and daylight saving.	Auto Tuning	Scans and saves available channels automatically.
Setting													
Language	Selects a desired language.												
Mode Setting	Selects Home Use for the home environment. Selects Store Demo for the retail environment. Selects Demo Mode to set to show special features of the TV. You can cancel the demo mode by pressing any buttons except the Volume and Mute buttons.												
Power Indicator (LED LCD TV)	Sets the power indicator.												
Time Zone	Sets the time zone and daylight saving.												
Auto Tuning	Scans and saves available channels automatically.												
Set ID	Adds an ID to the connected devices.												
Mode Setting	<p>Default selection is “Home Use”. We recommend setting the TV to “Home Use” mode for the best picture in your home environment.</p> <table border="1" style="width: 100%; margin-top: 5px;"> <thead> <tr> <th data-bbox="312 1047 491 1085">Option</th> <th data-bbox="491 1047 1273 1085"></th> </tr> </thead> <tbody> <tr> <td data-bbox="312 1085 491 1124">Home Use</td> <td data-bbox="491 1085 1273 1124">Selects it for the home environment.</td> </tr> <tr> <td data-bbox="312 1124 491 1163">Store Demo</td> <td data-bbox="491 1124 1273 1163">Selects it for the retail environment.</td> </tr> <tr> <td data-bbox="312 1163 491 1221">Demo Mode</td> <td data-bbox="491 1163 1273 1221">Sets to show special features of the TV. You can cancel the demo mode by pressing any buttons except the Volume and Mute buttons.</td> </tr> </tbody> </table>	Option		Home Use	Selects it for the home environment.	Store Demo	Selects it for the retail environment.	Demo Mode	Sets to show special features of the TV. You can cancel the demo mode by pressing any buttons except the Volume and Mute buttons.				
Option													
Home Use	Selects it for the home environment.												
Store Demo	Selects it for the retail environment.												
Demo Mode	Sets to show special features of the TV. You can cancel the demo mode by pressing any buttons except the Volume and Mute buttons.												
IR Blaster	Adjusts when connecting Wireless media box (sold separate). For further information, refer to the optional “Wireless media box” manual for operating instructions.												

NETWORK Settings

- 1 Press **HOME** to access the Home menu.
- 2 Press the Navigation buttons to scroll to **SETUP** and press **ENTER**.
- 3 Press the Navigation buttons to scroll to **NETWORK** and press **ENTER**.
- 4 Press the Navigation buttons to scroll to the setting or option you want and press **ENTER**.
 - To return to the previous level, press **BACK**.
- 5 When you are finished, press **EXIT**.

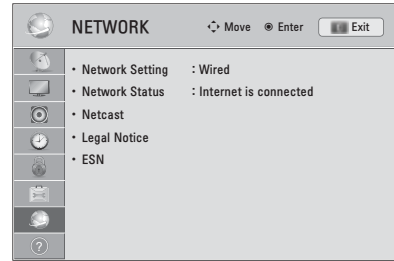

The available general settings are described in the following.

Setting	Description	
Network Setting	Configure the network settings (See p.50).	
Network Status	Display the network status (See p.55).	
Netcast	기상효과와 지역 설정이나 ID 를 관리하는 등의 동작을 합니다.	
	Setting	
	Country Setting	프리미엄 서비스의 국가를 설정할 수 있습니다. 국가를 변경하면 제공되는 프리미엄 서비스가 달라집니다.
	Regional Weather Effects Settings	프리미엄 화면의 배경에 나타나는 날씨 화면의 지역을 설정할 수 있습니다. 거주하시는 지역을 선택하세요.
	Premium Version	프리미엄 서비스의 버전이 표기됩니다.
	ID Management	TV에 로그인한 ID의 이력을 관리할 수 있습니다.
	TV Registration Number	PC의 넷캐스트 사이트에 등록하는 번호를 확인할 수 있습니다.
Reset	TV에 등록된 모든 ID의 정보와 설치된 모든 앱을 삭제하는 기능입니다. 기능 실행시 이미 구매한 유료 콘텐츠에 대한 정보가 삭제될 수 있으니 주의하시기 바랍니다.	
Legal Notice	Display the Legal notice (See p.57).	
ESN	View the supplied Netflix Electronic Serial Number (ESN)	

CUSTOMER SUPPORT settings

- 1 Press **HOME** to access the Home menu.
- 2 Press the Navigation buttons to scroll to **SETUP** and press **ENTER**.
- 3 Press the Navigation buttons to scroll to **CUSTOMER SUPPORT** and press **ENTER**.
- 4 Press the Navigation buttons to scroll to the setting or option you want and press **ENTER**.
 - To return to the previous level, press **BACK**.
- 5 When you are finished, press **EXIT**.

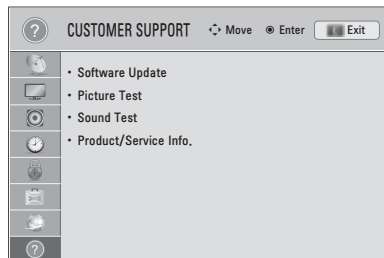

The available general settings are described in the following.

Setting	Description
Software Update	Update the TV with the latest firmware.
Picture Test	Executes picture or built-in melody sound tests.
Sound Test	<ul style="list-style-type: none"> » If this test has an error, select Yes. You can see the product or service information. » If this test has no errors, check the connection status of external devices and refer to the manual of external devices.
Product/Service Info.	Shows the product or service information. Customer Service Center can differ by country.

MAKING CONNECTIONS

Connect various external devices to the TV and switch input modes to select an external device. For more information of external device's connection, refer to the manual provided with each device.

Available external devices are: HD receivers, DVD players, VCRs, audio systems, USB storage devices, PC, camcorders or cameras, gaming devices, and other external devices.

NOTE

- If you record a TV program on a DVD recorder or VCR, make sure to connect the TV signal input cable to the TV through a DVD recorder or VCR. For more information of recording, refer to the manual provided with the connected device.
- The external device connection may differ from the model.
- Connect external devices to the TV regardless of the order of the TV port.

Connect external devices to the TV by referring to the following table.

Connection type	Video		Audio	
	Digital	Analog	Digital	Analog
HDMI (highly recommended)	O	-	O	-
DVI	O	-	-	-
Component	-	O	-	-
Composite	-	O	-	-
RGB	-	O	-	-
Optical audio	-	-	O	-

Connection overview

Connect various external devices to the ports on the TV back panel.

- 1 Find an external device you want to connect to your TV as shown on the following illustration.
- 2 Check the connection type of the external device.
- 3 Go to the appropriate illustration and check the connection details.

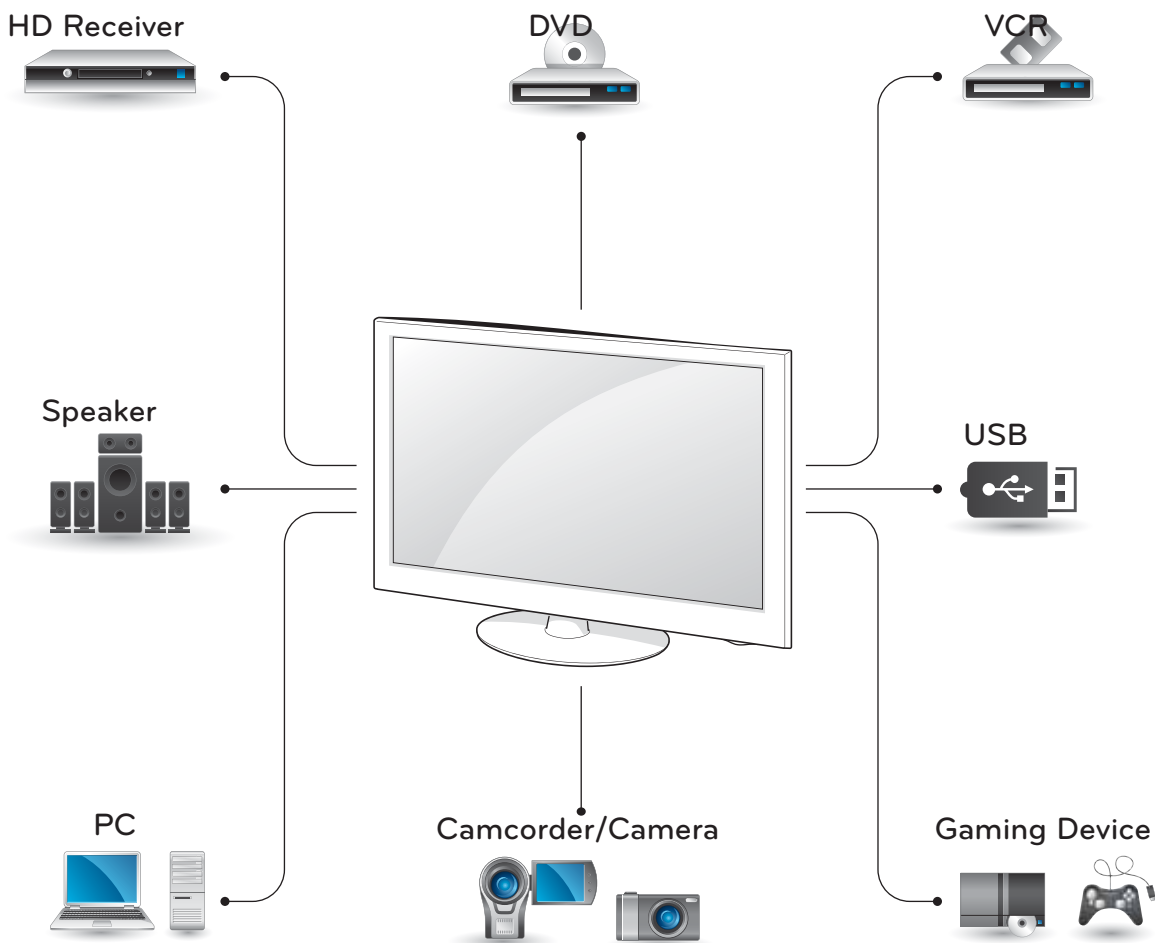

HDMI – See p.104

DVI – See p.105

Component – See p.101

Composite – See p.103

RGB – See p.106

Memory storage –
See p.109

Memory card reader – See p.109

Digital – See p.107



NOTE

- If you connect a gaming device to the TV, use the cable supplied with the gaming device.
- Refer to the external equipment's manual for operating instructions.

Connecting to a HD receiver, DVD, or VCR player

Connect a HD receiver, DVD, or VCR player to the TV and select an appropriate input mode.

HDMI connection

Transmits the digital video and audio signals from an external device to the TV. Connect the external device and the TV with the HDMI cable as shown in the following illustration.

NOTE

- Use the latest High Speed HDMI™ Cable with CEC (Customer Electronics Control) function.
- High Speed HDMI™ Cables are tested to carry an HD signal up to 1080p and higher.

50/60PZ950

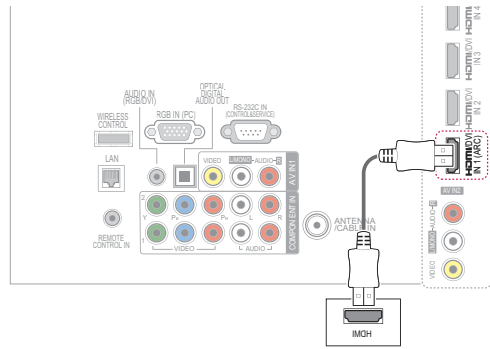

42/47/55LV5500

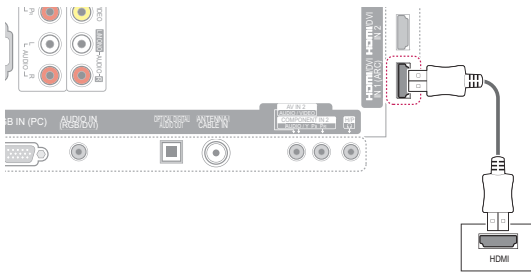

DVI to HDMI connection

Transmits the digital video signal from an external device to the TV. Connect the external device and the TV with the DVI-HDMI cable as shown in the following illustration. To transmit an audio signal, connect an optical audio cable.

42/47/55LV5500

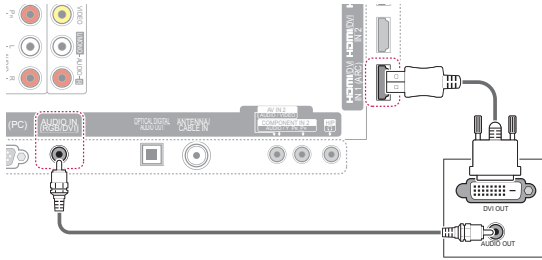

50/60PZ950

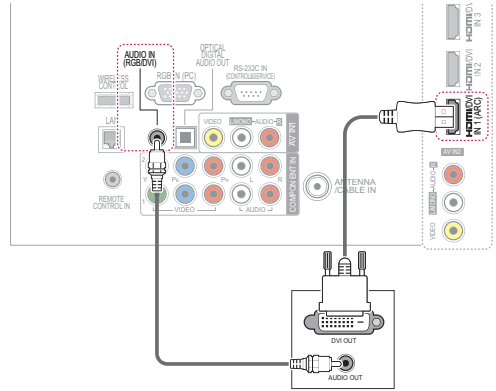

Component connection

Transmits the analog video and audio signals from an external device to the TV. Connect the external device and the TV with the component cable as shown in the following illustration.

42/47/55LV5500

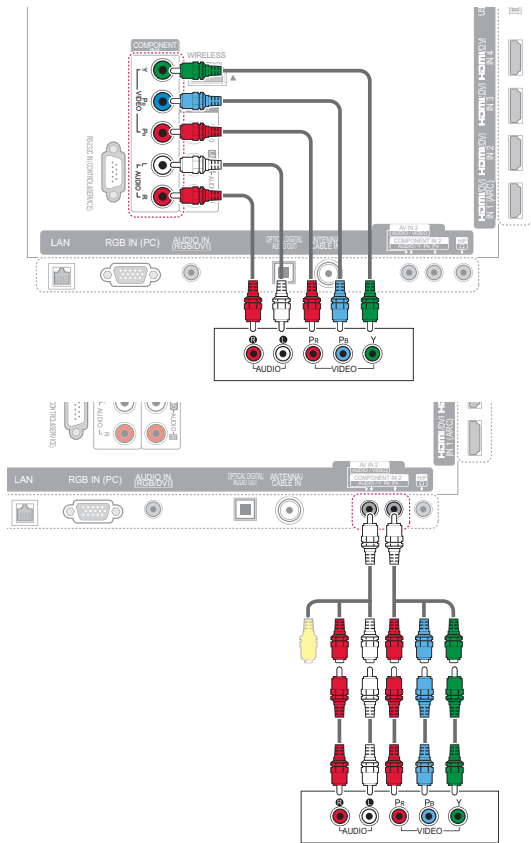

50/60PZ950

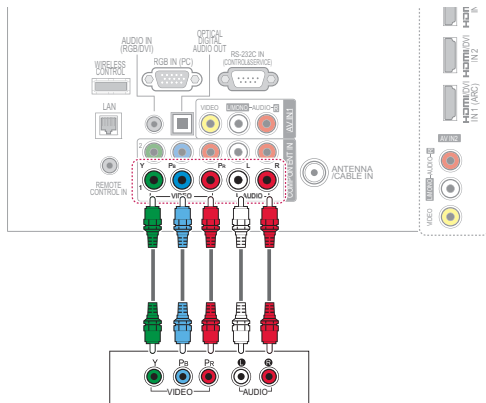
**NOTE**

- If cables are installed incorrectly, it could cause the image to display in black and white or with distorted color. Check to ensure the cable are matched with the corresponding color connection.

Composite connection

Transmits the analog video and audio signals from an external device to the TV. Connect the external device and the TV with the composite cable as shown in the following illustration.

NOTE

- If you have a mono VCR, connect the audio cable from the VCR to the AUDIO L/MONO jack of the TV.

50/60PZ950

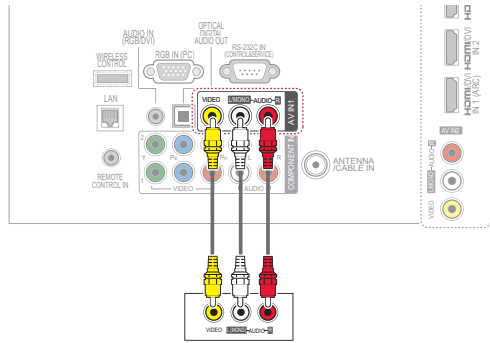

42/47/55LV5500

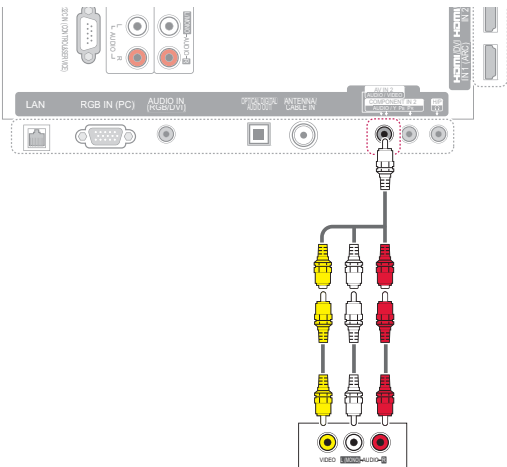
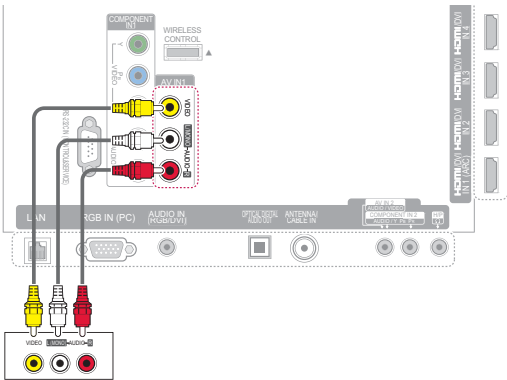

Connecting to a PC

This TV set supports the Plug & Play* feature.

* Plug & Play: The function when a PC recognizes a connected device that users connect to a PC and turn on, without device configuration or user intervention.

Connect the TV according to your PC by referring to the following table.

	HDMI (highly recommended)	RGB
Video	O (Digital)	O (Analog)
Audio	O (Digital)	X

NOTE

- It is recommended to use the TV set with the HDMI connection for the best image quality.

50/60PZ950

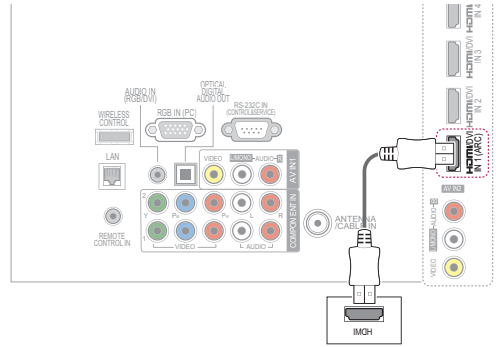

NOTE

- It is recommended to use the Monitor set with the 1920X1080@60Hz mode for the best image quality.

HDMI connection

Transmits the digital video and audio signals from your PC to the TV. Connect the PC and the TV with the HDMI cable as shown in the following illustrations.

42/47/55LV5500

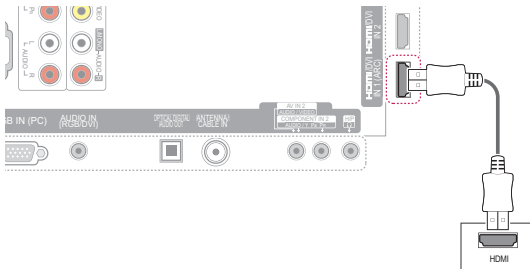

DVI to HDMI connection

Transmits the digital video signal from your PC to the TV. Connect the PC and the TV with the DVI-HDMI cable as shown in the following illustration. To transmit an audio signal, connect an optical audio cable.

42/47/55LV5500

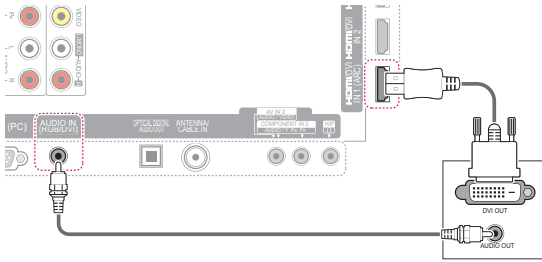

50/60PZ950

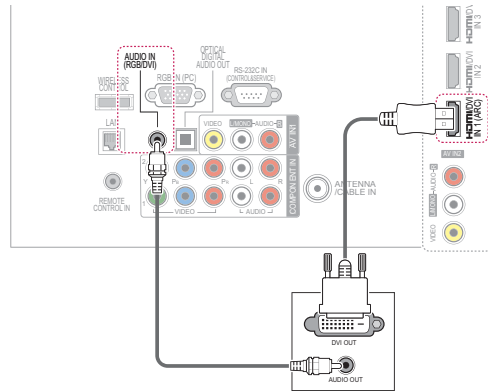

RGB connection

Transmits the analog video signal from your PC to the TV. Connect the PC and the TV with the supplied D-sub 15 pin signal cable as shown in the following illustrations. To transmit an audio signal, connect an optical audio cable.

50/60PZ950

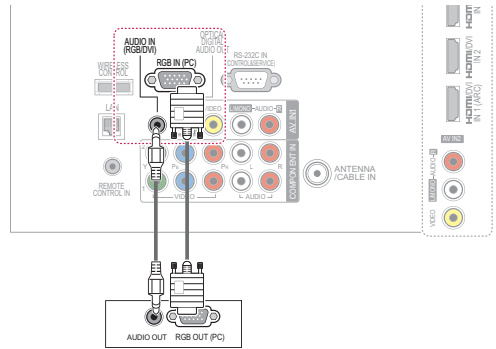

42/47/55LV5500

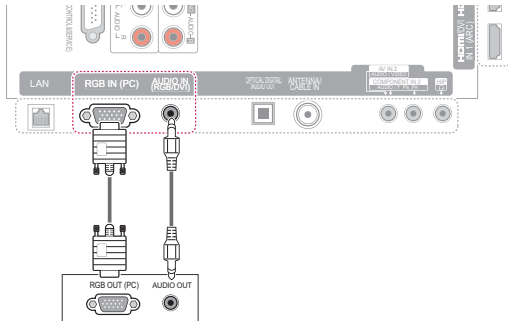

NOTE

- It is recommended to use the 1920 X 1080 @ 60 HZ video mode, set as the default preset, for the best image quality. If you use the TV in other video modes, afterimages or distorted images may appear on the screen.
- Depending on the graphics card, DOS mode may not work if a HDMI to DVI Cable is in use.
- In PC mode, there may be noise associated with the resolution, vertical pattern, contrast or brightness. If noise is present, change the PC output to another resolution, change the refresh rate to another rate or adjust the brightness and contrast on the PICTURE menu until the picture is clear.
- The synchronization input form for Horizontal and Vertical frequencies is separate.
- Depending on the graphics card, some resolution settings may not allow the image to be positioned on the screen properly.
- If you experience overscan issues when using HDMI-PC 1920x1080, change aspect ratio to Just scan.
- When selecting HDMI-PC, set the "Input Label - PC" in the OPTION menu.

Connecting to an audio system

Use an optional external audio system instead of the built-in speaker.

NOTE

- If you use an optional external audio device instead of the built-in speaker, set the TV speaker feature to off (See p.88).

Digital optical audio connection

Transmits the digital audio signal from the TV to an external device. Connect the external device and the TV with the optical audio cable as shown in the following illustration.

NOTE

- Do not look into the optical output port. Looking at the laser beam may damage your vision.
- Audio with ACP (Audio Copy Protection) function may block digital audio output.

42/47/55LV5500

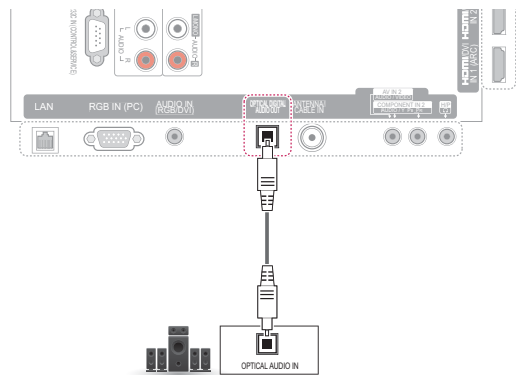

50/60PZ950

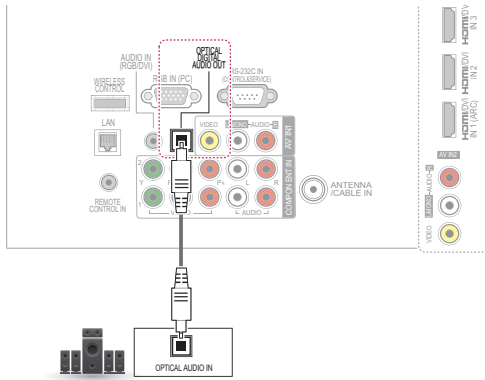

Connecting to a USB

Connect a USB storage device such as a USB flash memory, external hard drive, MP3 player or a USB memory card reader to the TV and access the **Smart Share** menu to use various multimedia files. See "Connecting USB storage devices" on page 62 and see "Browsing files" on page 67.

42/47/55LV5500

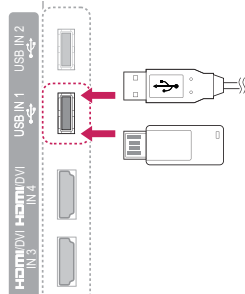

50/60PZ950

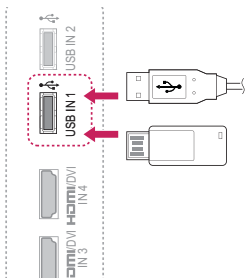

Connecting to a Headphone



Listen to the sound through a headphone.

42/47/55LV5500

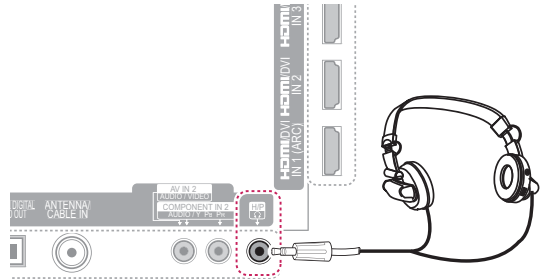

NOTE

- AUDIO menu options are disabled when connecting a headphone.
- When changing AV MODE with a headphone connected, the change is applied to video but not to audio.
- Optical Digital Audio Out is not available when connecting a headphone.
- Headphone impedance: 16 Ω
- Max audio output: 10 mW to 15 mW
- Headphone jack size: 0.32 cm (1/8 inch)

Connecting to a equipment wirelessly

(Not support for LK530 and LK550 series)

LG TVs with a Wireless Control port support the LG Wireless Media Box, which is sold separately. When you connect the wireless ready dongle (included with the media box) to the TV, external devices can be connected to the LG Wireless Media Box and video and audio will be sent to the TV wirelessly.

NOTE

- When using the external device connected to the Wireless Media Box, some functions of the TV menu may not work.

50/60PZ950

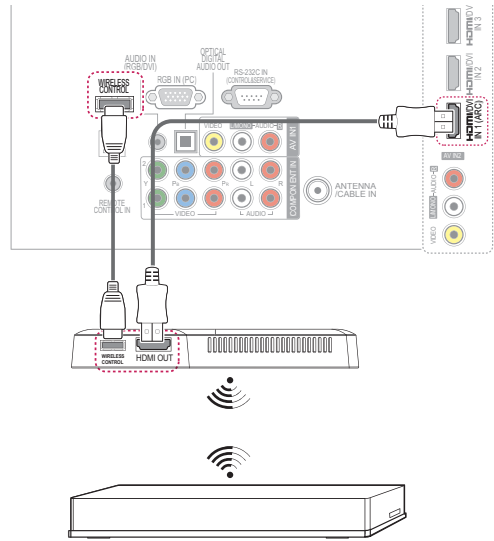

42/47/55LV5500

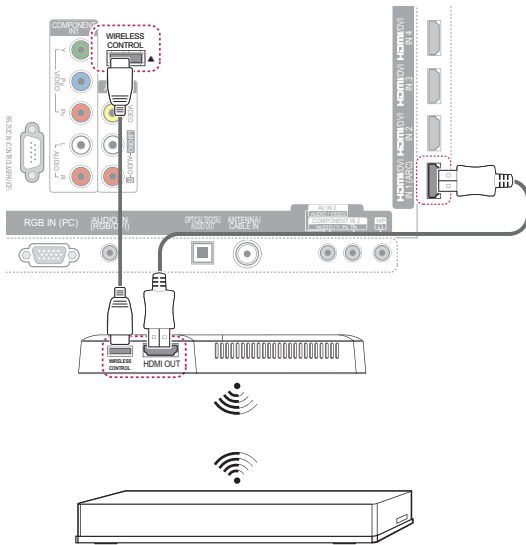

ENGLISH

SIMPLINK connection

Use the TV remote control to play and control the AV device connected with the HDMI cable through HDMI-CEC. [This TV may work with the devices that support HDMI-CEC, but only devices with the SIMPLINK logo are fully supported.](#)

Connect one end of the HDMI cable to the HDMI/DVI IN or HDMI IN terminal on the rear of the TV and the other end to the SIMPLINK device.

NOTE

- If the connected device does not support HDMI-CEC, the SIMPLINK feature is unavailable.
- To operate SIMPLINK, you should use an High Speed HDMI cable with the CEC (Consumer Electronics Control) function.
- **HDMI-CEC 기능이 있는 타사기기와 함께 사용시 정상적으로 동작되지 않을 수 있습니다.**

Activating and Using the SIMPLINK menus

- 1 Press **SIMPINK** to access the SIMPLINK menus.
- 2 Press the Navigation buttons to **select** to **On**.
- 3 Press the Navigation buttons to scroll to one of the devices and press **ENTER**.

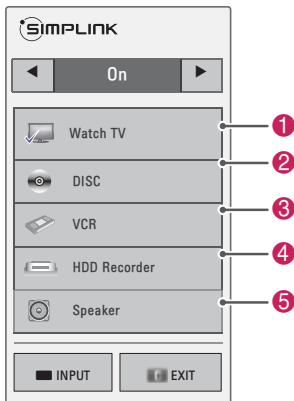

No.	Description
1	Displays the previously viewed TV channel.
2	Plays discs. When multiple discs are available, the title of the disc appears at the bottom of the screen.
3	Controls the connected VCR.
4	HDD recordings playback: Controls the recording stored in HDD.
5	Audio out to home theater speaker or Audio out to TV: Changes the audio output between Home theater speaker and TV speaker.

- A check mark appears in front of the selected device.
- Available devices display in a bright color.
- Unavailable devices display in grey.

3 Control the selected AV device.

- Direct Play: After connecting AV devices to the TV, you can directly control the devices and play media without additional settings.
- Select AV device: Enables you to select one of the AV devices connected to the TV.
- Disc playback: Control connected AV devices by pressing the Navigation buttons, ENTER, ▶, ■, ||, ◀ and ▶▶.
- Power off all devices: When you power off the TV, all connected devices are turned off.
- Switch audio-out: Offers an easy way to switch audio-out.
- Sync Power on: When the equipment with SIMPLINK function connected HDMI terminal starts to play, The TV will automatically turn on.

NOTE

- If you change the input source by pressing **INPUT**, the progressing function of the SIMPLINK device will stop.
- If you select a device that has the home theater feature, the sound output automatically switches to the home theater speaker and the TV speaker turns off.
- If a connected SIMPLINK home theater system does not play the audio from the TV, connect the DIGITAL AUDIO OUT terminal on the rear of the TV to the DIGITAL AUDIO IN terminal on the back of the SIMPLINK device with an optical cable.

MAINTENANCE

Update and clean your TV regularly to keep the best performance and to extend the product lifespan.

Updating the TV firmware

Download and install the latest firmware by connecting to the firmware update server to enhance or change the product function, or add new features.

The firmware update may not work properly depending on the Internet environment. If so, you may obtain the latest firmware update from the authorized LG Electronics service center.

To check the current firmware version or update the firmware,

- 1 Press **HOME** to access the Home menu.
- 2 Press the Navigation buttons to scroll to **SETUP** and press **ENTER**.
- 3 Press the Navigation buttons to scroll to **CUSTOMER SUPPORT** and press **ENTER**.
- 4 Press the Navigation buttons to scroll to **Software Update** and press **ENTER**.
The current firmware version displays.
- 5 Select **Check Update Version** to check a new firmware version manually.

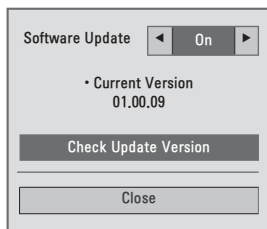

If selecting **Software Update - On**, the TV finds a new firmware through the NSU* and the update pop-up window will appear on the screen.

* NSU (Network Software Update): If the TV is connected to the internet, the TV finds a new firmware uploaded on the LG server.

! NOTE

- While you are updating the firmware, disconnect the LAN cable, turn the TV off, or unplug the power cord.
- Premium service is disabled while the software is being updated through NSU.

- 6 When the update is complete, the TV will automatically restart in 5 seconds.

You may need to reset some **CHANNEL**, **PICTURE**, or **AUDIO** menus.

! NOTE

- You cannot downgrade back to an older firmware version.
- The period of time for the firmware update may be different depending on the firmware size or network condition.

Cleaning your TV



CAUTION

- Make sure to turn the power off and disconnect the power cord and all other cables first.
- When the TV is left unattended and unused for a long time, disconnect the power cord from the wall outlet to prevent possible damage from lightning or power surges.

Screen and frame

To remove dust or light dirt, wipe the surface with a dry, clean, and soft cloth.

To remove major dirt, wipe the surface with a soft cloth dampened in clean water or a diluted mild detergent. Then wipe immediately with a dry cloth.



CAUTION

- Do not push, rub, or hit the surface with your fingernail or a sharp object, as this may result in scratches on the screen and image distortions.
- Do not use any chemicals, such as waxes, benzene, alcohol, thinners, insecticides, air fresheners, lubricants, as these may damage the screen's finish and cause discolorations.

Cabinet and stand

To remove dust or light dirt, wipe the cabinet with a dry, clean, and soft cloth.

To remove major dirt, wipe the cabinet with a soft cloth dampened in a clean water or water containing a small amount of mild detergent. Then wipe immediately with a dry cloth.



CAUTION

- Do not spray liquid onto the surface. If water enters the TV, it may result in fire, electric shock, or malfunction.
- Do not use any chemicals as this may deteriorate the surface.

Power cord

Remove the accumulated dust or dirt on the power cord regularly.

Preventing "Image burn" or "Burn-in" on your TV screen

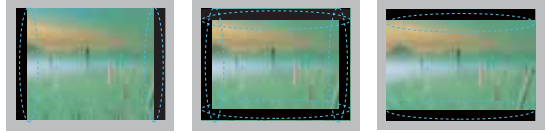

- If a fixed image displays on the TV screen for a long period of time, it will be imprinted and become a permanent disfigurement on the screen. This is "image burn" or "burn-in" and not covered by the warranty.
- If the aspect ratio of the TV is set to 4:3 for a long period of time, image burn may occur on the letterboxed area of the screen.
- Avoid displaying a fixed image on the TV screen for a long period of time (2 or more hours for LCD, 1 or more hours for the Plasma TV) to prevent image burn.

TROUBLESHOOTING

General

Problem	Resolution
Cannot control the TV with the remote control.	<ul style="list-style-type: none"> • Check the remote control sensor on the product and try again. • Check if there is any obstacle between the product and the remote control. • Check if the batteries are still working and properly installed (⊕ to ⊕, ⊖ to ⊖). • Check if the appropriate input mode such as TV or VCR is set for using the remote control.
No image display and no sound is produced.	<ul style="list-style-type: none"> • Check if the product is turned on. • Check if the power cord is connected to a wall outlet. • Check if there is a problem in the wall outlet by connecting other products.
Image appears slowly when the TV turns on.	<ul style="list-style-type: none"> • The image is muted during the product startup process. This is normal. If the image does not appear in a few minutes, unplug the TV for 30 seconds and try again. If the image still does not appear, contact the authorized service center in your local area.
Cannot connect external devices.	<ul style="list-style-type: none"> • Refer to the "Connection overview" (See p.98) and connect an external device.
The TV turns off suddenly.	<ul style="list-style-type: none"> • Check the power control settings. The power supply may be interrupted. • Check if the Auto sleep feature is activated in the Time settings. Refer to the "Sleep Timer" (See p.87). • If there is no signal while the TV is on, the TV will turn off automatically after 15 minutes of inactivity.

Audio

Problem	Resolution
No sound is produced while images are displaying.	<ul style="list-style-type: none"> • Press VOL + or - button. • Check if the sound is muted by pressing MUTE. • Scroll to other channels. There may a problem with the broadcast. • Check if the audio cables are connected properly. • Check if the TV Speaker feature is activated in the Sound menu.
One of the speakers produce noises or does not produce sound.	<ul style="list-style-type: none"> • A change in ambient humidity or temperature may result in an unusual noise when the product turns on or off. • There is no problem with your product.

Video

Problem	Resolution
An image displays in black and white or the color quality is poor.	<ul style="list-style-type: none"> Adjust the color setting in the Picture menu (See p.80). Keep a sufficient distance between this product and other electronic products. Scroll to other channels. There may a problem with the broadcast.
Horizontal or vertical bars appears or images blur	<ul style="list-style-type: none"> Check if there are local interferences such as an electrical appliance or power tool.
Lines or streaks appear on images	<ul style="list-style-type: none"> Check the antenna or aim the antenna to the proper direction.
Afterimages (ghosts) appear when the product turns off	<ul style="list-style-type: none"> Pixels may have been damaged from a fixed image displayed for a long time (image burn). Use a screen saver to prevent the pixel damage on the screen.
The power is on but the screen appears extremely dark.	<ul style="list-style-type: none"> Adjust the brightness and contrast in the Picture menu (See p.82).
"No Signal" appears on the screen.	<ul style="list-style-type: none"> Check if the signal cable is connected between the TV and products properly. Check the selected input source by pressing INPUT.
Black spots appear on the screen.	<ul style="list-style-type: none"> Several pixels in red, green, white, or black may appear on the screen that can attribute to the characteristics of the LCD panel. This is normal.
The display offset is wrong.	<ul style="list-style-type: none"> Adjust the position setting in the Picture menu (See p.80). Check if the video card resolution and frequency are supported by the product. If the frequency is out of range, set to the recommended resolution using the display settings on the external device.
Thin lines appear in the background of the screen.	<ul style="list-style-type: none"> Check the video cable connections.
Horizontal noises appear or characters blur.	<ul style="list-style-type: none"> Adjust the Phase setting in the Picture menu. Refer to the "SCREEN (RGB-PC)" (See p.82).
The reception on some channels is poor	<ul style="list-style-type: none"> Scroll to other channels. There may a problem with the broadcast. The station signal may be weak. Aim the antenna to the proper direction. Check if there are local interferences such as an electrical appliance or power tool.

Movie

Problem	Resolution
The file does not appear on the Movie List.	<ul style="list-style-type: none"> Check whether the extension is supported.
Message is displayed saying "This file is invalid" or the audio is working normally but the video is not working normally.	<ul style="list-style-type: none"> Check whether the file is playing normally on a PC. (Check whether the file is damaged.) Check whether the resolution is supported. Check whether the video/audio codec is supported. Check whether the frame rate is supported.
Message is displayed saying "Unsupported Audio" or the video is working normally but the audio is not working normally.	<ul style="list-style-type: none"> Check whether the file is playing normally on a PC. (Check whether the file is damaged.) Check whether the audio codec is supported. Check whether the bit rate is supported. Check whether the sample rate is supported.
Subtitle is not working.	<ul style="list-style-type: none"> Check whether the file is playing normally on a PC. (Check whether the file is damaged.) Check whether the video file and subtitle file name are the same. Check whether the video file and subtitle file are located in the same folder. Check whether the subtitle file is supported. Check whether the language is supported. (When you open the subtitle file in Memo Pad, you can check the language of the subtitle file.)

SPECIFICATIONS

Product specifications may be changed without prior notice due to upgrade of product functions.

Television System		NTSC-M, ATSC, 64 & 256 QAM
Program Coverage		VHF 2-13, UHF 14-69, CATV 1-135, DTV 2-69, CADTV 1-135
External Antenna Impedance		75 Ω
Environment condition	Operating Temperature	0 - 40°C
	Operating Humidity	Less than 80%
	Storage Temperature	-20 - 60°C
	Storage Humidity	Less than 85%

MODELS		50PZ950 (50PZ950-UA)	60PZ950 (60PZ950-UA)
		50PZ950U (50PZ950U-UA)	60PZ950U (60PZ950U-UA)
Dimensions (W x H x D)	With stand	1175.2 x 787.6 x 317.2 mm	1393.4 mm x 916.4 mm x 364.4 mm
	Without stand	1175.2 x 720.6 x 49.6 mm	1393.4 mm x 843.8 mm x 49.6 mm
Weight	With stand	31.8 kg	46.2 kg
	Without stand	28.2 kg	40.3 kg
Power requirement		AC 100 - 240V ~ 50 / 60 Hz	

MODELS		42LV3700 (42LV3700-UD)	47LV3700 (47LV3700-UD)	55LV3700 (55LV3700-UD)
		Dimensions (W x H x D)	With stand	997.2 mm x 684.2 mm x 256.6 mm
Without stand	997.2 mm x 614.7 mm x 40.1 mm		1108.4 mm x 677.2 mm x 40.1 mm	1285.9 mm x 777.8 mm x 40.1 mm
Weight	With stand	15.5 kg	20.9 kg	25.5 kg
	Without stand	13.3 kg	18.7 kg	21.4 kg
Power requirement		AC100-240V - 50/60Hz		

MODELS		42LV5400 (42LV5400-UA)	47LV5400 (47LV5400-UA)	55LV5400 (55LV5400-UA)
		Dimensions (W x H x D)	With stand	
Without stand				
Weight	With stand			
	Without stand			
Power requirement		AC100-240V - 50/60Hz		

MODELS		42LV5500 (42LV5500-UA)	47LV5500 (47LV5500-UA)	55LV5500 (55LV5500-UA)
Dimensions (W x H x D)	With stand	1011.6 mm x 683.3 mm x 254.9 mm	1121.4 x 742.8 x 255.0 mm	1298.2 mm x 848.9 mm x 341.0 mm
	Without stand	1011.6 mm x 616.8 mm x 29.9 mm	1121.4 x 677.8 x 29.9 mm	1298.2 mm x 778.4 mm x 29.9 mm
Weight	With stand	15.5 kg	21.45 kg	27.8 kg
	Without stand	13.2 kg	2.85 kg	22.9 kg
Power requirement		AC100-240V - 50/60Hz		

MODELS		42LW5600 (42LW5600-UA)	47LW5600 (47LW5600-UA)	55LW5600 (55LW5600-UA)
Dimensions (W x H x D)	With stand	1005.0 mm x 688.0 mm x 256.3 mm	1115.0 mm x 750.0 mm x 256.3 mm	1293.0 mm x 851.0 mm x 338.0 mm
	Without stand	1005.0 mm x 621.0 mm x 29.9 mm	1115.0 mm x 683.0 mm x 29.9 mm	1293.0 mm x 785.0 mm x 29.9 mm
Weight	With stand	15.2 kg	20.7 kg	26.3 kg
	Without stand	13.0 kg	18.5 kg	22.0 kg
Power requirement		AC100-240V - 50/60Hz		

MODELS		32LW5700 (32LW5700-UA)	42LW5700 (42LW5700-UA)
Dimensions (W x H x D)	With stand		999.2 mm x 681.2 mm x 255.0 mm
	Without stand		999.2 mm x 622.6 mm x 30.9 mm
Weight	With stand		17.0 kg
	Without stand		14.4 kg
Power requirement		AC100-240V - 50/60Hz	

MODELS		47LW5700 (47LW5700-UA)	55LW5700 (55LW5700-UA)
Dimensions (W x H x D)	With stand	1109.2 mm x 743.7 mm x 255.0 mm	1286.2 mm x 847.7 mm x 34.1 mm
	Without stand	1109.2 mm x 684.0 mm x 30.9 mm	1286.2 mm x 784.4 mm x 30.9 mm
Weight	With stand	20.2 kg	27.8 kg
	Without stand	17.4 kg	22.9 kg
Power requirement		AC100-240V - 50/60Hz	

MODELS		47LW6500 (47LW6500-UA)	55LW6500 (55LW6500-UA)	65LW6500 (65LW6500-UA)
Dimensions (W x H x D)	With stand	1119.4 mm x 746.4 mm x 255.0 mm	1296.7 mm x 851.2 mm x 341.0 mm	
	Without stand	1119.4 mm x 683.9 mm x 29.5 mm	1296.7 mm x 784.9 mm x 29.9 mm	
Weight	With stand	21.0 kg	27.0 kg	
	Without stand	18.2 kg	22.0 kg	
Power requirement		AC100-240V - 50/60Hz		

MODELS		47LW7700 (47LW7700-UA)	55LW7700 (55LW7700-UA)
Dimensions (W x H x D)	With stand	1175.8 x 771.6 x 289.7 mm	
	Without stand	1175.8 x 718.7 x 52.5 mm	
Weight	With stand	29.4 kg	
	Without stand	27.1 kg	
Power requirement		AC 100 - 240V ~ 50 / 60 Hz	

MODELS		47LW9500 (47LW9500-UA)	55LW9500 (55LW9500-UA)	60LW9500 (60LW9500-UA)
Dimensions (W x H x D)	With stand	1095.2 mm x 734.9 mm x 235.0 mm	1265.0 mm x 831.0 mm x 289.5 mm	1422.8 mm x 943.7 mm x 289.5 mm
	Without stand	1095.2 mm x 664.7 mm x 30.7 mm	1265.0 mm x 760.3 mm x 30.7 mm	1422.8 mm x 880.5 mm x 41.5 mm
Weight	With stand	22.5 kg	28.0 kg	29.6 kg
	Without stand	18.2 kg	22.8 kg	29.6 kg
Power requirement		AC 100 - 240V ~ 50 / 60 Hz		

MODELS		42LK530 (42LK530-UA)	47LK530 (47LK530-UA)	55LK530 (55LK530-UA)
Dimensions (W x H x D)	With stand	1024.0 mm x 685.0 mm x 261.0 mm	1137.0 mm x 758.0 mm x 270.0 mm	1329.0 mm x 872.0 mm x 330.0 mm
	Without stand	1024.0 mm x 621.0 mm x 76.8 mm	1137.0 mm x 685.0 mm x 76.8 mm	1329.0 mm x 796.0 mm x 96.5 mm
Weight	With stand	15.5 kg	20.3 kg	33.0 kg
	Without stand	13.9 kg	18.3 kg	29.8 kg
Power requirement		AC 100 - 240V ~ 50 / 60 Hz		

MODELS		42LK550 (42LK550-UA)	47LK550 (47LK550-UA)
Dimensions (W x H x D)	With stand	1019.0 mm x 698.0 mm x 265.0 mm	1132.0 mm x 762.0 mm x 265.0 mm
	Without stand	1019.0 mm x 631.0 mm x 76.5 mm	1132.0 mm x 695.0 mm x 76.5 mm
Weight	With stand	15.0 kg	18.8 kg
	Without stand	13.3 kg	17.1 kg
Power requirement		AC 100 - 240V ~ 50 / 60 Hz	

MODELS		72LZ9700 (72LZ9700-UA)
Dimensions (W x H x D)	With stand	1721,0 mm x 1126,0 mm x 410,0 mm
	Without stand	1721,0 mm x 1045,0 mm x 69,9 mm
Weight	With stand	
	Without stand	
Power requirement		AC 100 - 240V ~ 50 / 60 Hz

RGB (PC), HDMI (PC) supported mode

Resolution	Horizontal Frequency (kHz)	Vertical Frequency (Hz)
640x350	31.468	70.09
720x400	31.469	70.08
640x480	31.469	59.94
800x600	37.879	60.31
1024x768	48.363	60.00
1280x768 (RGB-PC)	47.776	59.87
1360x768	47.712	60.015
1280x1024	63.981	60.02
1920x1080 (RGB-PC)	66.587	59.934
1920x1080 (HDMI-PC)	67.50	60.00

HDMI (DTV) supported mode

Resolution	Horizontal Frequency (kHz)	Vertical Frequency (Hz)
720x480p	31.47	59.94
	31.50	60.00
1280x720p	44.96	59.94
	45.00	60.00
1920x1080i	33.72	59.94
	33.75	60.00
1920x1080p	26.97	23.976
	27.00	24.00
	33.71	29.97
	33.75	30.00
	67.432	59.939
	67.50	60.00

Component supported mode

Resolution	Horizontal Frequency (kHz)	Vertical Frequency (Hz)
720x480i	15.73	59.94
	15.73	60.00
720x480p	31.47	59.94
	31.50	60.00
1280x720p	44.96	59.94
	45.00	60.00
1920x1080i	33.72	59.94
	33.75	60.00
1920x1080p	26.97	23.976
	27.000	24.000
	33.71	29.97
	33.75	30.000
	67.432	59.94
	67.500	60.00

Component port connecting information

Component ports on the TV	Y	P _B	P _R

Video output ports on DVD player	Y	P _B	P _R
	Y	B-Y	R-Y
	Y	Cb	Cr
	Y	Pb	Pr

Video supported mode

File Extensions	Audio/Video	Codec	Profile/Level Support	Explanation
.asf .wmv	Video	VC-1 Advanced Profile	Advanced Profile@Level 3 (e.g. 720p60, 1080i60, 1080p30)	Only streams compliant to SMPTE 421M VC-1 standard are supported.
		VC-1 Simple and Main Profiles	Simple Profile@Medium Level (e.g. CIF, QVGA) Main Profile@High Level (e.g. 1080p30)	
	Audio	WMA Standard WMA 9 Professional		
.divx .avi	Video	DivX3.11		Global motion compensation or quarterpel motion estimation does not supported. Streams using this syntax are not supported.
		DivX4 DivX5 DivX6	Advanced Simple Profile (e.g. 720p/1080i)	
		XViD		
	H.264 / AVC	Main Profile@ Level 4.1 High Profile@ Level 4.1 (e.g. 720p60, 1080i60, 1080p30)		
Audio	MPEG-1 Layer I, II MPEG-1 Layer III (MP3) Dolby Digital			
.mp4 .m4v	Video	H.264 / AVC	Main Profile@ Level 4.1 High Profile@ Level 4.1 (e.g. 720p60, 1080i60, 1080p30)	Global motion compensation or quarterpel motion estimation does not supported. Streams using this syntax are not supported.
		MPEG-4 Part 2	Advanced Simple Profile (e.g. 720p/1080i)	
	Audio	AAC	AAC-LC and HE-AAC	
.mkv	Video	H.264 / AVC	Main Profile@ Level 4.1 High Profile@ Level 4.1 (e.g. 720p60, 1080i60, 1080p30)	Most of the MKV content available is encoded by the open source x264 codec.
	Audio	HE-AAC Dolby Digital	HE-AAC-LC and HE-AAC	
.ts .trp .tp	Video	H.264 / AVC	Main Profile@ Level 4.1 High Profile@ Level 4.1 (e.g. 720p60, 1080i60, 1080p30)	Only streams compliant to SMPTE 421M VC-1 standard are supported.
		MPEG-2	Main Profile@High Level (e.g. 720p60, 1080i60)	
		VC-1	Simple Profile@Medium Level (e.g. CIF, QVGA) Main Profile@High Level (e.g. 1080p30) Advanced Profile@Level3 (e.g. 720p60, 1080i60, 1080p30)	
	Audio	MPEG-1 Layer I, II MPEG-1 Layer III (MP3) Dolby Digital Dolby Digital Plus AAC	AAC-LC and HE-AAC	
.vob	Video	MPEG-1		
		MPEG-2	Main Profile@High Level (e.g. 720p60, 1080i60)	
	Audio	Dolby Digital MPEG-1 Layer I, II DVD-LPCM		
.mpg	Video	MPEG-1	Main Profile@High Level (e.g. 720p60, 1080i60)	Only streams compliant configured properly for TS, PS or ES
	Audio	MPEG-1 Layer I, II		

3D supported formats

	Signal	Resolution	Horizontal Frequency (kHz)	Vertical Frequency (Hz)	Playable 3D video format
HDMI Input	720p	1280x720	45.00	60	Top & Bottom, Side by Side HDMI (V. 1.4 with HDMI 3D) Frame Packing
	1080i	1920x1080	33.75		Top & Bottom, Side by Side
			67.50		Top & Bottom, Side by Side, Checker Board Single Frame Sequential
	1080p	1920x1080	27.00	24	Top & Bottom, Side by Side, Checker Board HDMI (V. 1.4 with HDMI 3D) Frame Packing
			33.75	30	Top & Bottom, Side by Side Checker Board
USB Input	1080p	1920x1080	33.75	30	Top & Bottom, Side by Side Checker Board, MPO (Photo)
				24	Top & Bottom, Side by Side MPO (Photo)
Component (For Plasma TV)	720p	1280x720	45.00	60	Top & Bottom, Side by Side
	1080i	1920x1080	33.75	60	
	Signal				Playable 3D video format
DTV	720p, 1080i				Top & Bottom, Side by Side

Wireless LAN for Broadband/DLNA Adaptor SPEC (For LW9500 series)

This device only works with compatible LG LED LCD TV or LCD TV.

Standard	IEEE802.11a/b/g/n
Frequency Range	2402 to 2483 MHz 5150 to 5250 MHz 5725 to 5850 MHz
Modulation	CCK / OFDM / MIMO
Output Power (Typical)	802.11a: 14 dBm 802.11b: 17 dBm 802.11g: 14 dBm 802.11n: 13 dBm
Data rate	802.11a/g: 54 Mbps 802.11b: 11 Mbps 802.11n: 300 Mbps
Antenna Gain (Typical)	2402 to 2483 MHz: 1.17 dBi 5150 to 5250 MHz: 4.67 dBi 5725 to 5850 MHz: 3.30 dBi
Occupied bandwidth	802.11a/b/g: HT20 802.11n: HT20/40

Because band channel used by the country could be different, the user can not change or adjust the operating frequency and this product is set for the regional frequency table.

- FCC ID of Wi-Fi module inside TV
FCC ID: BEJWN8522D1

**RF module (BM-LDS201) specification**

For TV By using a 2.4 GHz bandwidth radio frequency(RF).

- Output: 1 dBm or lower
- Maximum Communication Distance: 10 m (30 ft) in an open space
- Bandwidth: 2.4 GHz (2.4035 GHz - 2.4783 GHz)
- Transfer Rate: 250 kbps
- FCC ID of RF module inside TV
FCC ID: BEJLDS201



IR CODES

(Depending on model)

How to Connect

Connect your wired remote control to the Remote Control port on the TV.

Remote Control IR Codes

Output waveform

Single pulse, modulated with 37.917kHz signal at 455kHz

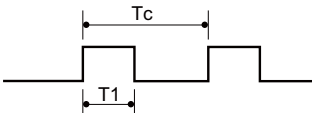

Frame configuration

1st frame

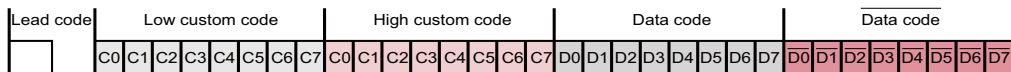

Repeat frame

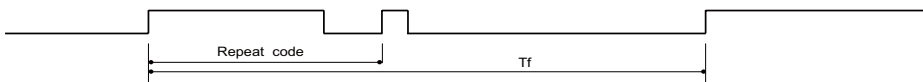

Lead code

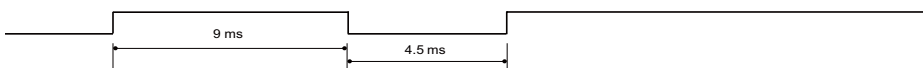

Repeat code

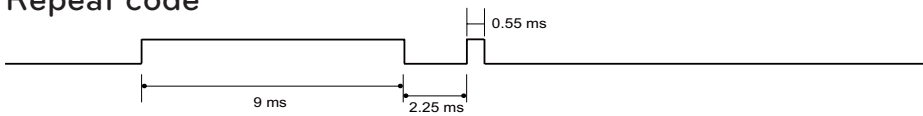

Bit description

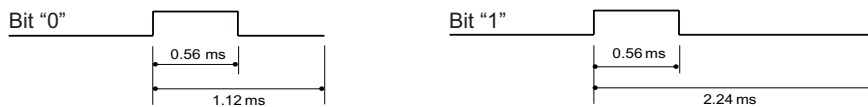

Frame interval: T_f

The waveform is transmitted as long as a key is depressed.

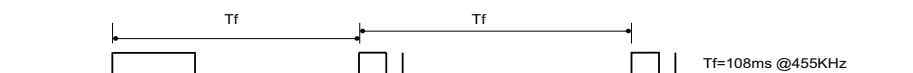

ENGLISH

Code (Hexa)	Function	Note	Code (Hexa)	Function	Note
08	POWER	Remote control Button (Power On/Off)	0F	TV	Remote control Button
			DC	3D	Remote control Button
45	Q.MENU	Remote control Button	5B	EXIT	Remote control Button
43	Home	Remote control Button	D6	TV	Discrete IR Code (TV Input Selection)
0B	INPUT	Remote control Button			
0F	Number Key 0-9	Remote control Button	C4	POWER ON	Discrete IR Code (Only Power Off)
11	- (Dash)/LIST	Remote control Button			
12	FLASHBK	Remote control Button	C5	POWER OFF	Discrete IR Code (Only Power Off)
13	MUTE/DELETE	Remote control Button			
14	VOL +	Remote control Button	5A	AV1	Discrete IR Code (AV1 Input Selection)
15	VOL -	Remote control Button			
16	CH ▲	Remote control Button	D0	AV2	Discrete IR Code (AV2 Input Selection)
17	CH ▼	Remote control Button			
18	FAV/MARK	Remote control Button	BF	COMPONENT1	Discrete IR Code (Component1 Input Selection)
19	▲	Remote control Button			
4C	▼	Remote control Button	D4	COMPONENT2	Discrete IR Code (Component2 Input Selection)
10	<	Remote control Button			
1A	>	Remote control Button	D5	RGB-PC	Discrete IR Code (RGB-PC Input Selection)
44	ENTER	Remote control Button			
28	BACK	Remote control Button	CE	HDMI1	Discrete IR Code (HDMI1 Input Selection)
79	RATIO	Remote control Button			
BA 	FREEZE	Remote control Button	CC	HDMI2	Discrete IR Code (HDMI2 Input Selection)
95	ENERGY SAVING	Remote control Button			
7E	SIMPLINK	Remote control Button	E9	HDMI3	Discrete IR Code (HDMI3 Input Selection)
AA	INFO	Remote control Button			
30	AV MODE	Remote control Button	DA	HDMI4	Discrete IR Code (HDMI4 Input Selection)
72	RED	Remote control Button			
71	GREEN	Remote control Button	76	Ratio 4:3	Discrete IR Code (Only 4:3 Mode)
63	YELLOW	Remote control Button			
61	BLUE	Remote control Button	77	Ratio 16:9	Discrete IR Code (Only 16:9 Mode)
B1	■	Remote control Button			
B0	▶	Remote control Button	AF	Ratio Zoom	Discrete IR Code (Only Zoom Mode)
BA	▬	Remote control Button			
8E	▶▶	Remote control Button			
8F	◀◀	Remote control Button			

EXTERNAL CONTROL DEVICE SETUP

RS-232C Setup

Connect the RS-232C (serial port) input jack to an external control device (such as a computer or an A/V control system) to control the product's functions externally.

Connect the serial port of the control device to the RS-232C jack on the product back panel.



NOTE

- RS-232C on this TV is intended to be used with third party RS-232C control hardware and software. The instructions below are provided to help with programming software or to test functionality using telenet software. RS-232C connection cables are not supplied with the product.

Type of connector; D-Sub 9-Pin Male

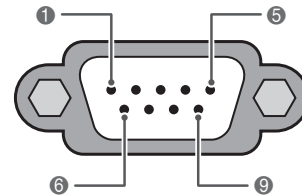

RS-232C IN
(CONTROL & SERVICE)

No.	Pin name
1	No connection
2	RXD (Receive data)
3	TXD (Transmit data)
4	DTR (DTE side ready)
5	GND
6	DSR (DCE side ready)
7	RTS (Ready to send)
8	CTS (Clear to send)
9	No Connection

RS-232C configurations

7-Wire Configuration

(Serial female-female NULL modem cable)

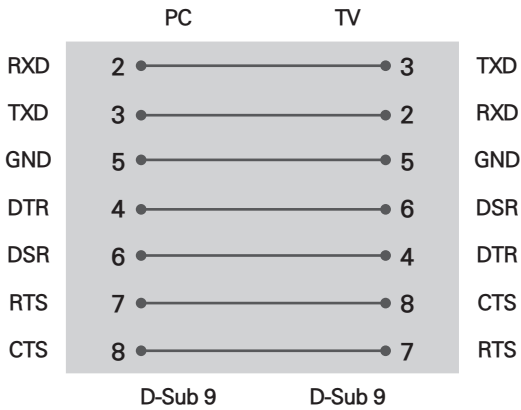

3-Wire Configurations(Not standard)

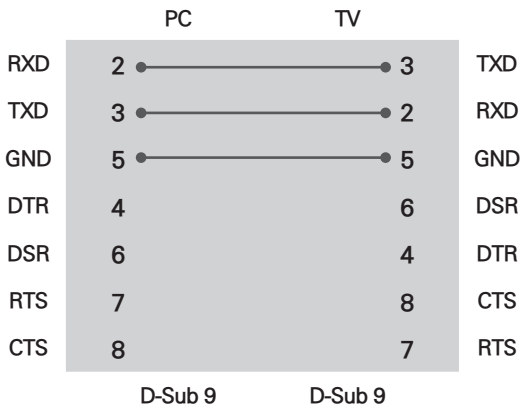

Set ID

Set ID number.

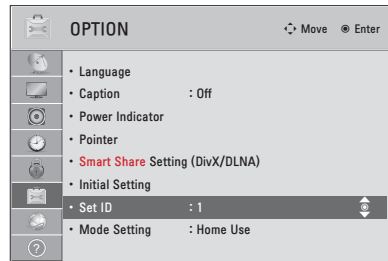

- 1 Press **HOME** to access the Home menu.
- 2 Press the Navigation buttons to scroll to **SETUP** and press **ENTER**.
- 3 Press the Navigation buttons to scroll to **OPTION** and press **ENTER**.
- 4 Press the Navigation buttons to scroll to **Set ID** and press **ENTER**.
- 5 Scroll left or right to select a set ID number and select **CLOSE**. The adjustment range is 1-99.
- 6 When you are finished, press **EXIT**.

```
*Real data mapping
0 : Step 0
  :
A : Step 10 (SET ID 10)
  :
F : Step 15 (SET ID 15)
10 : Step 16 (SET ID 16)
  :
63 : Step 99 (SET ID 99)
64 : Step 100
```

Communication Parameters

- Baud rate: 9600 bps (UART)
- Data length: 8 bits
- Parity : None
- Stop bit: 1 bit
- Communication code: ASCII code
- Use a crossed (reverse) cable.

Command reference list

	COMMAND1	COMMAND2	DATA (Hexadecimal)		COMMAND1	COMMAND2	DATA (Hexadecimal)
01. Power	k	a	00 - 01	14. Treble	k	r	00 - 64
02. Input Select	x	b	(See p.130)	15. Bass	k	s	00 - 64
03. Aspect Ratio	k	c	(See p.130)	16. Balance	k	t	00 - 64
04. Screen Mute	k	d	00 - 01	17. Color Temperature	x	u	00 - 64
05. Volume Mute	k	e	00 - 01	18. Energy Saving	j	q	(See p.131)
06. Volume Control	k	f	00 - 64	19. Auto Configuration	j	u	(See p.131)
07. Contrast	k	g	00 - 64	21. Channel Add/Del	m	b	00 - 01
08. Brightness	k	h	00 - 64	22. Key	m	c	(See p.132)
09. Color	k	i	00 - 64	23. Backlight	m	g	00 - 64
10. Tint	k	j	00 - 64				
11. Sharpness	k	k	00 - 64				
12. OSD Select	k	l	00 - 01				
13. Remote Control Lock Mode	k	m	00 - 01				

	COMMAND1	COMMAND2	DATA00 (Hexadecimal)	DATA01 (Hexadecimal)	DATA02 (Hexadecimal)	DATA03 (Hexadecimal)	DATA04 (Hexadecimal)	DATA05 (Hexadecimal)
20. Channel Tuning	m	a	physical program high	major program low	major low	minor high	minor low	attribute

- When setting the 17 to 24, a menu does not appear on screen.
- Note : During USB operations such as Dvix or EMF, all commands except Power(ka) and Key(mc) are not executed and treated as NG.

Transmission / Receiving protocol

Transmission

[Command1][Command2][][Set ID][][Data][Cr]

[Command 1] : First command to control the set.(j, k, m or x)

[Command 2] : Second command to control the set.

[Set ID] : You can adjust the set ID to choose desired set ID number in Option menu. Adjustment range is 1~ 99. When selecting Set ID '0', every connected the set is controlled. Set ID is indicated as decimal (1~ 99) on menu and as Hexa decimal (0x0~ 0x63) on transmission /receiving protocol.

[DATA] : To transmit the command data.

Transmit the 'FF' data to read status of command.

[Cr] : Carriage Return

ASCII code '0x0D'

[] : ASCII code 'space (0x20)'

* In this model, set will not send the status during the standby mode.

OK Acknowledgement

[Command2][][Set ID][][OK][Data][x]

The set transmits ACK (acknowledgement) based on this format when receiving normal data. At this time, if the data is data read mode, it indicates present status data. If the data is data write mode, it returns the data of the PC computer.

* In this model, set will not send the status during the standby mode.

* Data Format

[Command 2] : Use as command.

[Set ID] : Use the small character, if set ID is 10, it will send the '0', 'a'.

[DATA] : Use the small character, if data is 0 x ab, it will send the 'a', 'b'.

[OK] : Use the large character.

Error Acknowledgement

[Command2][][Set ID][][NG][Data][x]

The set transmits ACK (acknowledgement) based on this format when receiving abnormal data from non-viable functions or communication errors.

Data1: Illegal Code

Data2: Not supported function

Data3: Wait more time

* In this model, set will not send the status during the standby mode.

* Data Format

[Command 2] : Use as command.

[Set ID] : Use the small character, if set ID is 10, it will send the '0', 'a'.

[DATA] : Use the small character, if data is 0 x ab, it will send the 'a', 'b'.

[NG] : Use the large character

01. Power (Command: k a)

To control Power On/Off of the set.

Transmission [k][a][][Set ID][][Data][Cr]

Data 00: Power Off Data 01: Power On

Acknowledgement [a][][Set ID][][OK/NG][Data][x]

* In a like manner, if other functions transmit 'FF' data based on this format, Acknowledgement data feedback presents status about each function.

* Note: In this model, set will send the Acknowledge after power on processing completion.

There might be a time delay between command and acknowledge.

02. Input Select (Command: x b)

To select input source for set.

Transmission [x][b][][Set ID][][Data][Cr]

Data 00: DTV (Antenna)

Data 10: Analog (Antenna) Data 11: Analog (Cable)

Data 20: AV or AV1 Data 21: AV2

Data 40: Component

Data 60: RGB-PC

Data 90: HDMI1

Data 91: HDMI2

Data 92: HDMI3

Data 93: HDMI4

Acknowledgement [b][][Set ID][][OK/NG][Data][x]

* Use the feature depending on your model.

03. Aspect Ratio (Command: k c)

To adjust the screen format.

Transmission [k][c][][Set ID][][Data][Cr]

Data 01: 4:3

Data: 09: Just scan

Data 02: 16:9

Data: 10: Cinema Zoom 1

Data 05: Zoom 2

:

Data 06: Set by program Data 1F: Cinema Zoom16

Acknowledgement [c][][Set ID][][OK/NG][Data][x]

04. Screen Mute (Command: k d)

To select screen mute on/off.

Transmission [k][d][][Set ID][][Data][Cr]

Data 00: Screen mute off (Picture on), Video-out Mute off

Data 01: Screen mute on (Picture off)

Data 10: Video-out Mute on

Acknowledgement [d][][Set ID][][OK/NG][Data][x]

* In case of Video-out Mute on only, TV will display On Screen Display (OSD). But, in case of screen mute on, TV will not display On Screen Display (OSD).

05. Volume Mute (Command: k e)

To control volume mute on/off.

You can also adjust mute using the MUTE button on remote control.

Transmission [k][e][][Set ID][][Data][Cr]

Data 00: Volume mute on (Volume off)

Data 01: Volume mute off (Volume on)

Acknowledgement [e][][Set ID][][OK/NG][Data][x]

06. Volume Control (Command: k f)

To adjust volume.

You can also adjust volume with the volume buttons on remote control.

Transmission [k][f][][Set ID][][Data][Cr]

Data Min: 00 ~ Max: 64 (*transmit by Hexadecimal code)

*Refer to "Real data mapping".

Acknowledgement [f][][Set ID][][OK/NG][Data][x]

07. Contrast (Command: k g)

To adjust screen contrast.

You can also adjust contrast in the PICTURE menu.

Transmission [k][g][][Set ID][][Data][Cr]

Data Min: 00 ~ Max: 64 (*transmit by Hexadecimal code)

*Refer to "Real data mapping".

Acknowledgement [g][][Set ID][][OK/NG][Data][x]

08. Brightness (Command: k h)

To adjust screen brightness.

You can also adjust brightness in the PICTURE menu.

Transmission [k][h][][Set ID][][Data][Cr]

Data Min: 00 ~ Max: 64 (*transmit by Hexadecimal code)

*Refer to "Real data mapping".

Acknowledgement [h][][Set ID][][OK/NG][Data][x]

09. Color (Command: k i)

To adjust screen color.

You can also adjust color in the PICTURE menu.

Transmission [k][i][][Set ID][][Data][Cr]

Data Min: 00 ~ Max: 64 (*transmit by Hexadecimal code)

*Refer to "Real data mapping".

Acknowledgement [i][][Set ID][][OK/NG][Data][x]

10. Tint (Command: k j)

To adjust screen tint.

You can also adjust tint in the PICTURE menu.

Transmission [k][j][][Set ID][][Data][Cr]

Data Red: 00 ~ Green: 64 (*transmit by Hexadecimal code)

*Refer to "Real data mapping".

Acknowledgement [j][][Set ID][][OK/NG][Data][x]

11. Sharpness (Command: k k)

To adjust screen sharpness.

You can also adjust sharpness in the PICTURE menu.

Transmission [k][k][][Set ID][][Data][Cr]

Data Min: 00 ~ Max: 64 (*transmit by Hexadecimal code)

*Refer to "Real data mapping".

Acknowledgement [k][][Set ID][][OK/NG][Data][x]

12. OSD Select (Command: k l)

To select OSD (On Screen Display) on/off.

Transmission [k][l][][Set ID][][Data][Cr]

Data 00: OSD off Data 01: OSD on

Acknowledgement [l][][Set ID][][OK/NG][Data][x]

13. Remote Control Lock Mode (Command: k m)

To lock the remote control and the front panel controls on the set.

Transmission [k][m][][Set ID][][Data][Cr]

Data 00: Lock off Data 01: Lock on

Acknowledgement [m][][Set ID][][OK/NG][Data][x]

If you're not using the remote control and front panel controls on the Monitor set, use this mode. When main power is on/off, remote control lock is released. If Key Lock is on in the standby mode, TV will not turn on by POWER button of remote control and on the TV.

14. Treble (Command: k r)

To adjust treble.

You can also adjust treble in the AUDIO menu.

Transmission [k][r][][Set ID][][Data][Cr]

Data Min: 00 ~ Max: 64 (*transmit by Hexadecimal code)

*Refer to "Real data mapping".

Acknowledgement [r][][Set ID][][OK/NG][Data][x]

15. Bass (Command: k s)

To adjust bass.

You can also adjust bass in the AUDIO menu.

Transmission [k][s][][Set ID][][Data][Cr]

Data Min: 00 ~ Max: 64 (*transmit by Hexadecimal code)

*Refer to "Real data mapping".

Acknowledgement [s][][Set ID][][OK/NG][Data][x]

16. Balance (Command: k t)

To adjust balance.

You can also adjust balance in the AUDIO menu.

Transmission [k][t][][Set ID][][Data][Cr]

Data Min: 00 ~ Max: 64 (*transmit by Hexadecimal code)

*Refer to "Real data mapping".

Acknowledgement [t][][Set ID][][OK/NG][Data][x]

17. Color Temperature (Command: x u)

To adjust color temperature.

You can also adjust color temperature in the PICTURE menu.

Transmission [x][u][][Set ID][][Data][Cr]

Data Min: 00 ~ Max: 64 (*transmit by Hexadecimal code)

*Refer to "Real data mapping".

Acknowledgement [u][][Set ID][][OK/NG][Data][x]

18. Energy Saving (Command: j q)

To control the energy saving function.

Transmission [j][q][][Set ID][][Data][Cr]

Data 00: Energy Saving - off

01: Energy Saving - Minimum

02: Energy Saving - Medium

03: Energy Saving - Maximum

04: Energy Saving - Auto (Depending on model)

05: Energy Saving - Screen off

Acknowledgement [q][][Set ID][][OK/NG][Data][x]

19. Auto Configuration (Command: j u)

To adjust picture position and minimize image shaking automatically. Auto configuration only works in RGB-PC mode.

Transmission [j][u][][Set ID][][Data][Cr]

Data 01: To set

Acknowledgement [u][][Set ID][][OK/NG][Data][x]

20. Channel Tuning (Command: m a)

To tune channel to following physical/major/minor number.

Transmission [m][a][][Set ID][][Data00][][Data01][][Data02][][Data03][][Data04][][Data05][Cr]

Digital channels have a Physical, Major, and Minor channel number. The Physical number is the actual digital channel number, the Major is the number that the channel should be mapped to, and the Minor is the sub-channel. Since the ATSC tuner automatically maps the channel to the Major number, the Physical number is not required when sending a command.

Data 00: Physical Channel Number

NTSC air: 02~45, NTSC cable: 01, 0E~7D

ATSC air: 01~45, ATSC cable: 01~87

Data 01 & 02: Major Channel Number

Data 01: High byte Data 02: Low byte

Two bytes are available for the Major and Minor, normally only the second byte is used.

Data 03 & 04: Minor Channel Number

Not needed for NTSC.

7	Main/Sub Picture	6	Two/One Part Channel	5	Using Physical Channel	4 Reserved	3	2	1	0	Step
0	Main	0	Two	0	Use	x	0	0	0	0	NTSC Air
1	Sub	1	One	1	No Use	x	0	0	0	1	NTSC Cable
						x	0	0	1	0	ATSC Air
						x	0	0	1	1	ATSC Cable_std
						x	0	1	0	0	ATSC Cable_hrc
						x	0	1	0	1	ATSC Cable_irc
						x	0	1	1	0	ATSC cable_auto
						x	0	1	1	1	Reserved
						x	x	x	x	x	...
						x	1	1	1	1	Reserved

The table above lists the binary code which must be converted to Hexadecimal before sending. For example:

The binary code to tune the sub source to an NTSC cable channel is "1000 0001", which translates to "81" in Hex.

- * 7th bit : For which source do you want to change the channel.
- * 6th bit: Use a two part or one part channel. Most cases just use 0 since it's ignored when using NTSC.
- * 5th bit: Use 0 with NTSC since it can only use the physical channel number. Normally use 1 for ATSC since most times it doesn't matter what the physical number is.
- * 4th bit: Set to 0.
- * 3-0 bits: Choose signal type.

* Tune Command Examples:

1. Tune to the analog (NTSC) cable channel 35.

Data 00 = Physical of 35 = 23

Data 01 & 02 = No Major = 00 00

Data 03 & 04 = No Minor = 00 00

Data 05 = 0000 0001 in binary = 01

Total = ma 00 23 00 00 00 01

2. Tune to the digital (ATSC) local channel 30-3.

Data 00 = Don't know Physical = 00

Data 01 & 02 = Major is 30 = 00 1E

Data 03 & 04 = Minor is 3 = 00 03

Data 05 = 0010 0010 in binary = 22

Total = ma 00 00 00 1E 00 03 22

21. Channel Add/Del (Command: m b)

To add and delete the channels.

Transmission [m][b][][Set ID][][Data][Cr]

Data 00: Channel Delete Data 01: Channel Add

Acknowledgement [b][][Set ID][][OK/NG][Data][x]

22. Key (Command: m c)

To send IR remote key code.

Transmission [m][c][][Set ID][][Data][Cr]

See page 101.

Acknowledgement [c][][Set ID][][OK/NG][Data][x]

When TV is in the standby mode, TV will turn on by POWER button of remote control only.

23. Backlight (Command: m g)

To adjust screen backlight.

Transmission [m][g][][Set ID][][Data][Cr]

Data Min:00 ~ Max:64 (*transmit by Hexadecimal code)

*Refer to "Real data mapping".

Acknowledgement [g][][Set ID][][OK/NG][Data][x]

OPEN SOURCE LICENSE

Working_IE Gr.



The model and serial numbers of the TV is located on the back of the TV
Record it below should you ever need service.

MODEL _____

SERIAL _____