



LCD TV | PLASMA TV OWNER'S MANUAL

LCD TV MODEL

32LG30 37LG50
37LG30 42LG50
42LG30 47LG50
 52LG50

PLASMA TV MODELS

42PG60
50PG60
60PG60

32LG60 32LG70
37LG60 42LG70
42LG60 47LG70
47LG60 52LG70
52LG60

Please read this manual carefully before operating your set.

Retain it for future reference.

Record model number and serial number of the set.

See the label attached on the back cover and quote this information to your dealer when you require service.

ENERGY STAR is a set of power-saving guidelines issued by the U.S. Environmental Protection Agency(EPA).



As an ENERGY STAR Partner LGE U. S. A.,Inc. has determined that this product meets the ENERGY STAR guidelines for energy efficiency.

P/NO : SAC30708020 (0801-REV01)

WARNING / CAUTION



WARNING / CAUTION
RISK OF ELECTRIC SHOCK
DO NOT OPEN



TO REDUCE THE RISK OF ELECTRIC SHOCK
DO NOT REMOVE COVER (OR BACK). NO
USER SERVICEABLE PARTS INSIDE. REFER TO
QUALIFIED SERVICE PERSONNEL.



The lightning flash with arrowhead symbol, within an equilateral triangle, is intended to alert the user to the presence of uninsulated “dangerous voltage” within the product’s enclosure that may be of sufficient magnitude to constitute a risk of electric shock to persons.



The exclamation point within an equilateral triangle is intended to alert the user to the presence of important operating and maintenance (servicing) instructions in the literature accompanying the appliance.

WARNING/CAUTION

TO REDUCE THE RISK OF FIRE AND ELECTRIC SHOCK, DO NOT EXPOSE THIS PRODUCT TO RAIN OR MOISTURE.

NOTE TO CABLE/TV INSTALLER

This reminder is provided to call the CATV system installer’s attention to Article 820-40 of the National Electric Code (U.S.A.). The code provides guidelines for proper grounding and, in particular, specifies that the cable ground shall be connected to the grounding system of the building, as close to the point of the cable entry as practical.

WARNING / CAUTION

To prevent fire or shock hazards, do not expose this product to rain or moisture.

FCC NOTICE

Class B digital device

This equipment has been tested and found to comply with the limits for a Class B digital device, pursuant to Part 15 of the FCC Rules. These limits are designed to provide reasonable protection against harmful interference in a residential installation. This equipment generates, uses and can radiate radio frequency energy and, if not installed and used in accordance with the instructions, may cause harmful interference to radio communications. However, there is no guarantee that interference will not occur in a particular installation. If this equipment does cause harmful interference to radio or television reception, which can be determined by turning the equipment off and on, the user is encouraged to try to correct the interference by one or more of the following measures:

- Reorient or relocate the receiving antenna.
- Increase the separation between the equipment and receiver.
- Connect the equipment to an outlet on a circuit different from that to which the receiver is connected.
- Consult the dealer or an experienced radio/TV technician for help.

Any changes or modifications not expressly approved by the party responsible for compliance could void the user’s authority to operate the equipment.

CAUTION

Do not attempt to modify this product in any way without written authorization from LG Electronics. Unauthorized modification could void the user’s authority to operate this product

SAFETY INSTRUCTIONS

IMPORTANT SAFETY INSTRUCTIONS

Important safety instructions shall be provided with each apparatus. This information shall be given in a separate booklet or sheet, or be located before any operating instructions in an instruction for installation for use and supplied with the apparatus.

This information shall be given in a language acceptable to the country where the apparatus is intended to be used. The important safety instructions shall be entitled “Important Safety Instructions”. The following safety instructions shall be included where applicable, and, when used, shall be verbatim as follows. Additional safety information may be included by adding statements after the end of the following safety instruction list. At the manufacturer’s option, a picture or drawing that illustrates the intent of a specific safety instruction may be placed immediately adjacent to that safety instruction:

Read these instructions.
Keep these instructions.
Heed all warnings.
Follow all instructions.



1 Do not use this apparatus near water.

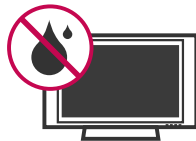

2 Clean only with dry cloth.



3 Do not block any ventilation openings. Install in accordance with the manufacturer’s instructions.



4 Do not install near any heat sources such as radiators, heat registers, stoves, or other apparatus (including amplifiers) that produce heat.



5 When mounting a TV it on the wall, make sure not to install TV by the hanging power and signal cables on the back of the TV.

6 Do not defeat the safety purpose of the polarized or grounding-type plug. A polarized plug has two blades with one wider than the other. A grounding type plug has two blades and a third grounding prong. The wide blade or the third prong are provided for your safety. If the provided plug does not fit into your outlet, consult an electrician for replacement of the obsolete outlet.



7 Protect the power cord from being walked on or pinched particularly at plugs, convenience receptacles, and the point where they exit from the apparatus.



8 Only use attachments/accessories specified by the manufacturer.



9 Unplug this apparatus when unused for long periods of time.

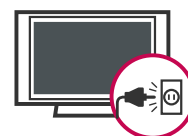

- 10** Use only with the cart, stand, tripod, bracket, or table specified by the manufacturer, or sold with the apparatus. When a cart is used, use caution when moving the cart/apparatus combination to avoid injury from tip-over.



- 11** Never touch this apparatus or antenna during a thunder or lightning storm.

- 12** Do not allow a impact shock or any objects to fall into the product, and do not drop onto the screen with something.

- 13** Refer all servicing to qualified service personnel. Servicing is required when the apparatus has been damaged in any way, such as power-supply cord or plug is damaged, liquid has been spilled or objects have fallen into the apparatus, the apparatus has exposed to rain or moisture, does not operate normally, or has been dropped.

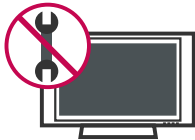

- 14** CAUTION concerning the Power Cord : Most appliances recommend they be placed upon a dedicated circuit; that is, a single outlet circuit which powers only that appliance and has no additional outlets or branch circuits. Check the specification page of this owner's manual to be certain.

Do not overload wall outlets. Overloaded wall outlets, loose or damaged wall outlets, extension cords, frayed power cords, or damaged or cracked wire insulation are dangerous. Any of these conditions could result in electric shock or fire. Periodically examine the cord of your appliance, and if its appearance indicates damage or deterioration, unplug it, discontinue use

of the appliance, and have the cord replaced with an exact replacement part by an authorized servicer. Protect the power cord from physical or mechanical abuse, such as being twisted, kinked, pinched, closed in a door, or walked upon. Pay particular attention to plugs, wall outlets, and the point where the cord exits the appliance.



- 15** Outdoor use marking :
WARNING - To reduce the risk of fire or electric shock, do not expose this appliance to rain or moisture.



- 16** Wet Location Marking : Apparatus shall not be exposed to dripping or splashing and no objects filled with liquids, such as vases, shall be placed on or over apparatus.



- 17** **GROUNDING**
Ensure that you connect the earth ground wire to prevent possible electric shock. If grounding methods are not possible, have a qualified electrician install a separate circuit breaker. Do not try to ground the unit by connecting it to telephone wires, lightening rods, or gas pipes.

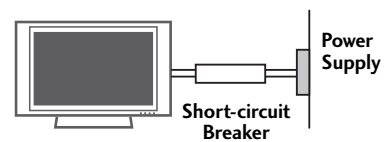

- 18** **DISCONNECTING DEVICE FROM MAINS**
Mains plug is the disconnecting device. The plug must remain readily operable.

CONTENTS

WARNING / CAUTION	1
SAFETY INSTRUCTIONS	2
FEATURE OF THIS TV	6

PREPARATION

Accessories	7
Front Panel Information	8
Back Panel Information	10
Stand Installation	14
Cable Management	16
Desktop Pedestal Installation	18
Swivel Stand	18
Attaching the TV to a Desk	18
VESA Wall Mounting	19
Protection Cover	20
Securing the TV to the wall to prevent falling	21
Antenna or Cable Connection	22

EXTERNAL EQUIPMENT SETUP

HD Receiver Setup	23
DVD Setup	29
VCR Setup	33
Other A/V Source Setup	36
PC Setup	37
USB Connection	46
Audio Out Connection	47

WATCHING TV / CHANNEL CONTROL

Remote Control Functions	48
Turning On TV	50
Channel Selection	50
Volume Adjustment	50
Quick Menu	51
Initial Setting	52
On-Screen Menus Selection	54

Channel Setup	
- Auto Scan (Auto Tuning)	56
- Add / Delete Channel (Manual Tuning)	57
- Channel Editing	58
Input List	59
Input Label	60
AV Mode	61
SIMPLINK	62

USB

Entry Modes	64
Photo List	65
Music List	69

PICTURE CONTROL

Picture Size (Aspect Ratio) Control	72
Preset Picture Settings	
- Picture Mode - Preset	74
- Color Tone - Preset	75
Manual Picture Adjustment	
- Picture Mode - User Mode	76
- Picture Mode - Expert Control	77
Picture Improvement Technology	78
Advanced Control - Black (Darkness) Level	79
Advanced Control - Eye Care	80
Advanced - Real Cinema/Film Mode	81
Advanced - TruMotion	82
TruMotion Demo	83
Picture Reset	84
Power Indicator	85
Image Sticking Minimization (ISM) Method	86
Power Saving Picture Mode	87

SOUND & LANGUAGE CONTROL

Auto Volume Leveler (Auto Volume)	88
Preset Sound Setting (Sound Mode)	89
Sound Setting Adjustment - User Mode	90
Clear Voice	91
Balance	92
TV Speakers On/Off Setup	93
Audio Reset	94
Stereo/SAP Broadcasts Setup	95
Audio Language	96
On-Screen Menus Language Selection	97
Caption Mode	
- Analog Broadcasting System Captions	98
- Digital Broadcasting System Captions	99
- Caption Option	100

TIME SETTING

Clock Setting	
- Auto Clock Setup	101
- Manual Clock Setup	102
Auto On/Off Time Setting	103
Sleep Timer Setting	104
Auto Shut-off Setting	105

PARENTAL CONTROL / RATINGS

Set Password & Lock System	106
Channel Blocking	109
Movie & TV Rating	110
Downloadable Rating	115
External Input Blocking	116
Key lock	117

APPENDIX

Troubleshooting	118
Maintenance	120
Product Specifications	121
Programming the Remote Control	124
IR Codes	127
External Control Through RS-232C	129
Open Source License	136

FEATURE OF THIS TV



 is a trademark of SRS Labs, Inc. TruSurround XT technology is incorporated under license from SRS Labs, Inc.



Manufactured under license from Dolby Laboratories. "Dolby" and the double-D symbol are trademarks of Dolby Laboratories.

FOR LCD TV

- If the TV feels cold to the touch, there may be a small “flicker” when it is turned on. This is normal, there is nothing wrong with TV.
- Some minute dot defects may be visible on the screen, appearing as tiny red, green, or blue spots. However, they have no adverse effect on the monitor’s performance.
- Avoid touching the LCD screen or holding your finger(s) against it for long periods of time. Doing so may produce some temporary distortion effects on the screen.

On Disposal

The fluorescent lamp used in this product contains a small amount of mercury. Do not dispose of this product with general household waste. Disposal of this product must be carried out in accordance to the regulations of your local authority.

PREPARATION

ACCESSORIES

Ensure that the following accessories are included with your TV. If an accessory is missing, please contact the dealer where you purchased the TV.

The accessories included may differ from the images below.

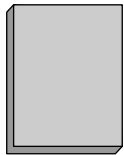

Owner's Manual



CD Manual

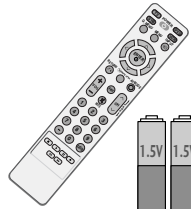

Remote Control,
Batteries



Power Cord



75ohm Round Cable

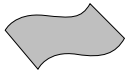

Polishing Cloth

(This feature is not available for all models.)

* Wipe spots on the exterior only with the polishing cloth.

* Do not wipe roughly when removing stain. Please be cautious of that excessive pressure may cause scratch or discoloration.

Option Extras

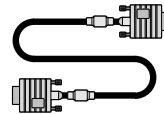

D-sub 15 pin Cable

When using the VGA (D-sub 15 pin cable) PC connection, the user must use shielded signal interface cables with ferrite cores to maintain standards compliance.

For Plasma TV models

(Only 42PG60)



Cable Holder

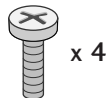

Bolts for stand assembly
(Refer to P.14)



Cable Management Clip

(Only 50/60PG60)

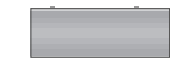

Protection Cover
(Refer to P.20)

For LCD TV models

32/37/42LG30, 37/42/47/52LG50, 32/42/47/52LG70

(Only 32/37/42LG30, 37/42LG50,
32/42LG70)

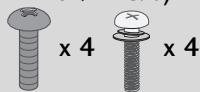

Bolts for stand assembly
(Refer to P.14)

(Only 32LG30/70)



Screw for stand fixing
(Refer to P.18)

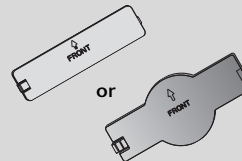

Protection Cover
(Refer to P.20)

32/37/42/47/52LG60

(Only 32/37LG60)



32LG60: 3EA
37LG60: 4EA
4EA

(Only 42LG60)



2EA
(4x16)
1EA
4EA
(4x20)



Protection Cover
(Refer to P.20)



Cable Management
Clip

Bolts for stand assembly
(Refer to P.15)

PREPARATION

FRONT PANEL INFORMATION

- Image shown may differ from your TV.
- NOTE:** If your TV has a protection tape attached, remove the tape. And then wipe the TV with a cloth (If a polishing cloth is included with your TV, use it).

Plasma TV Models

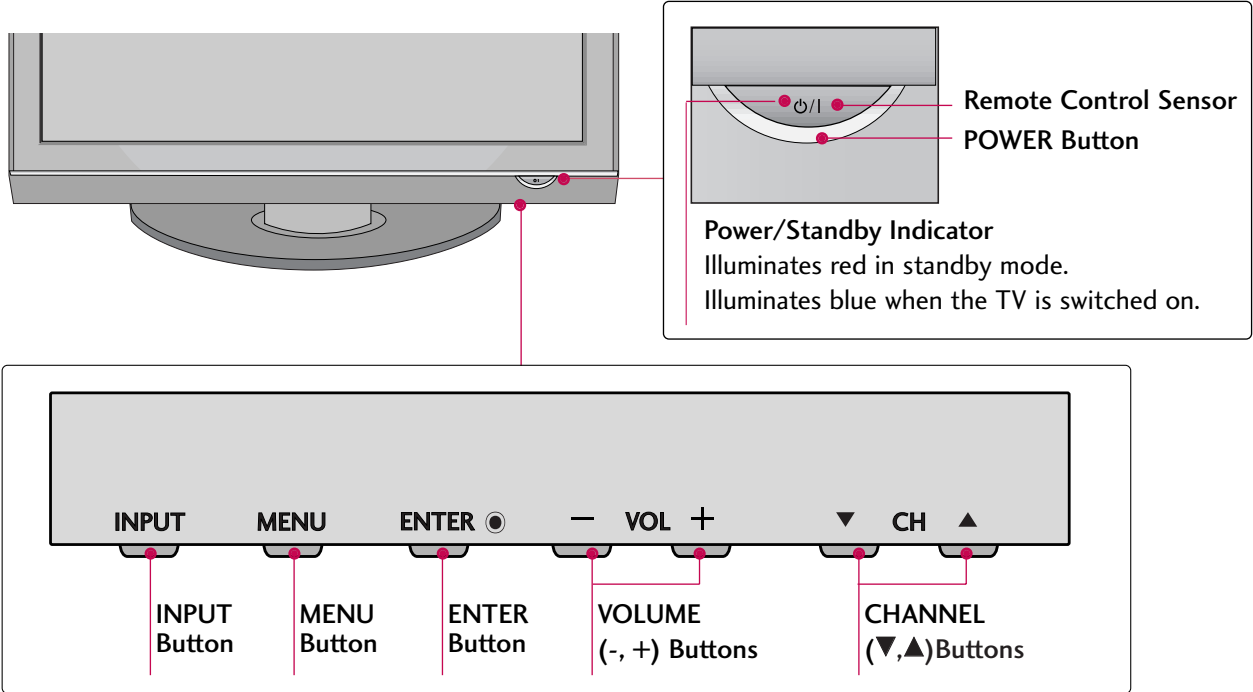

LCD TV Models

32/42/47/52LG70

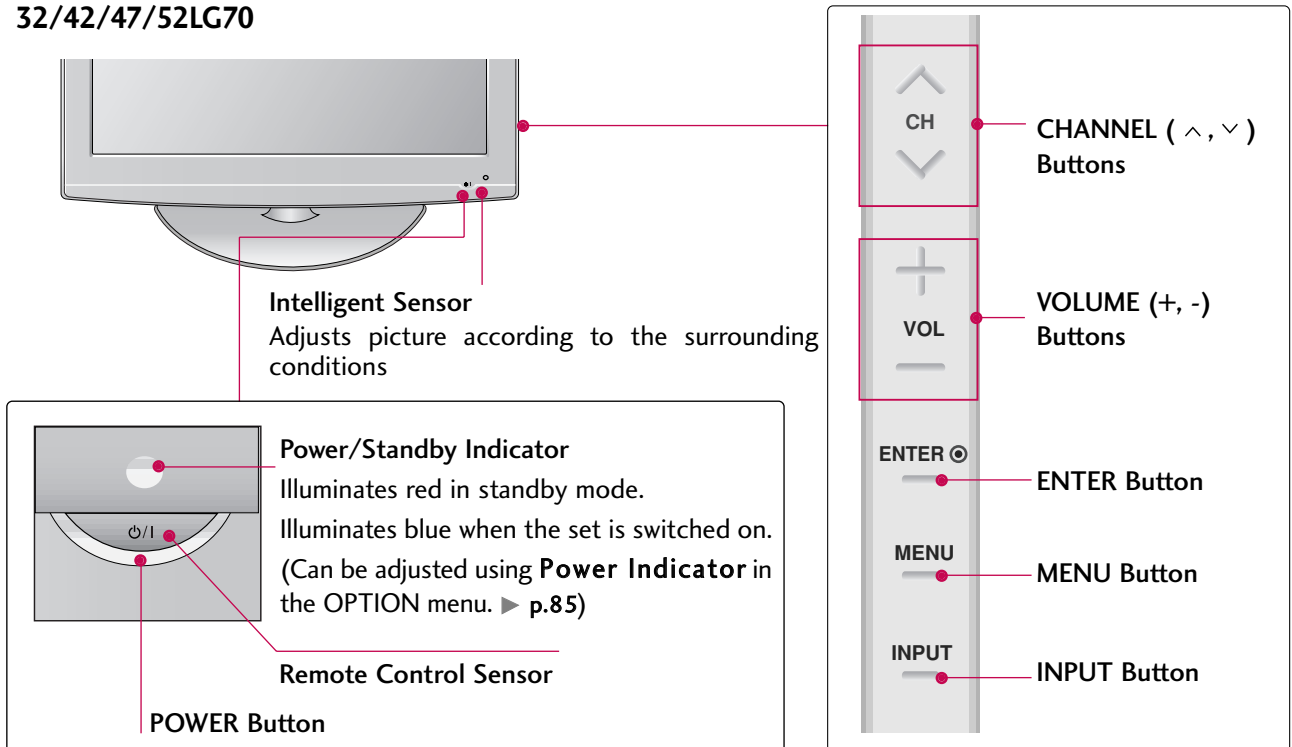

LCD TV Models

32/37/42LG30, 37/42/47/52LG50

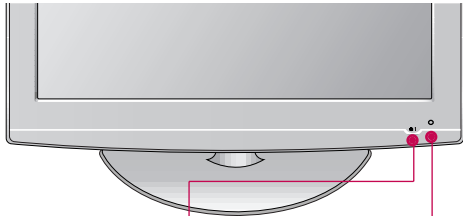

Intelligent Sensor (Except 32/37/42LG30)
Adjusts picture according to the surrounding conditions

Power/Standby Indicator
Illuminates red in standby mode.
Illuminates blue when the set is switched on.
(Can be adjusted using **Power Indicator** in the OPTION menu. ► p.85)

Remote Control Sensor

POWER Button

CHANNEL (^, v) Buttons

VOLUME (+, -) Buttons

ENTER Button

MENU Button

INPUT Button

32/37/42/47/52LG60

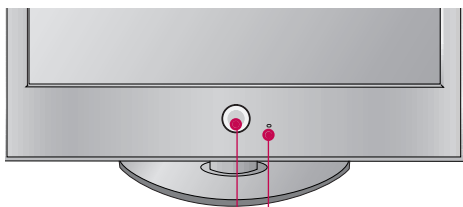

Intelligent Sensor
Adjusts picture according to the surrounding conditions.

POWER Button

Remote Control Sensor

Power/Standby Indicator
Illuminates red in standby mode.
Illuminates white when the set is switched on.
(Can be adjusted using **Power Indicator** in the OPTION menu. ► p.85)

CHANNEL (^, v) Buttons

VOLUME (+, -) Buttons

ENTER Button

MENU Button

INPUT Button

PREPARATION

BACK PANEL INFORMATION

■ Image shown may differ from your TV.

Plasma TV Models

PREPARATION

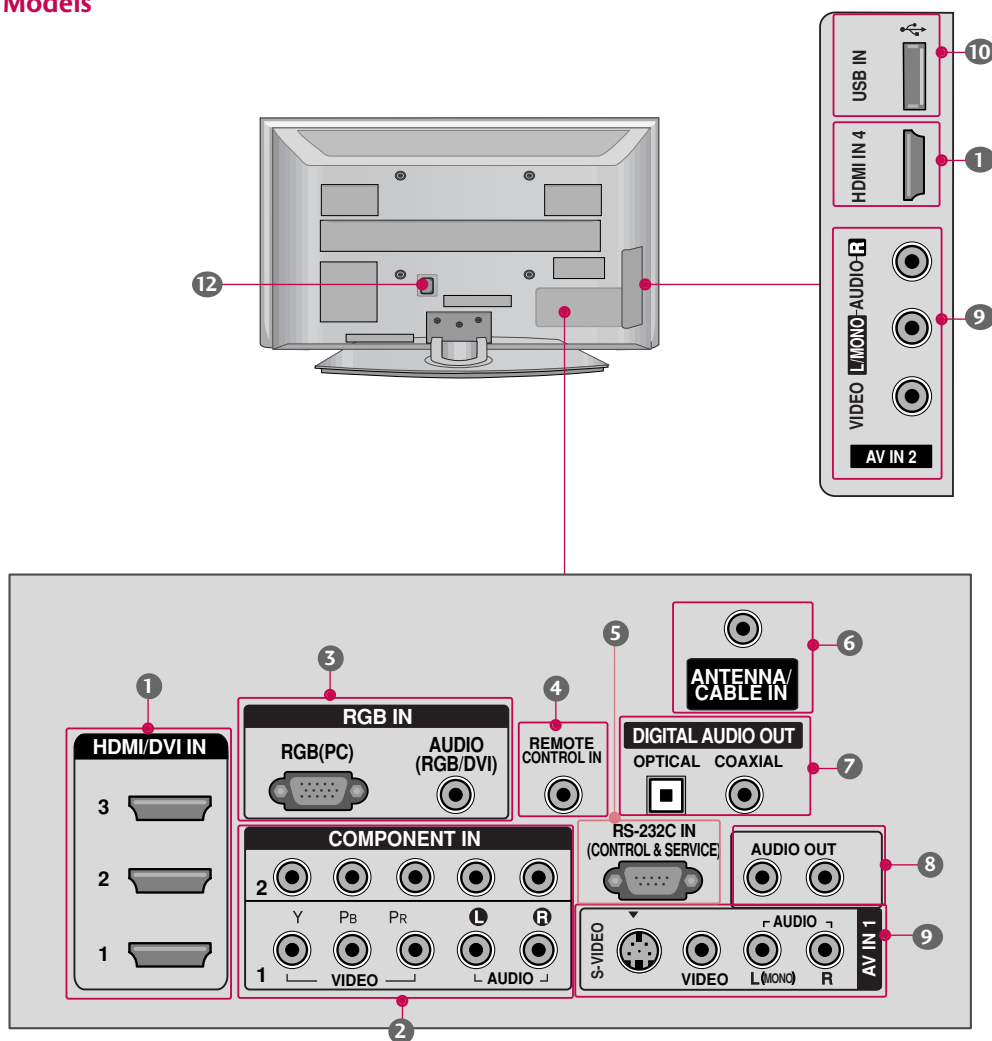

LCD TV Models

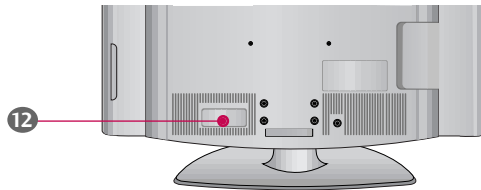

32/37/42LG30

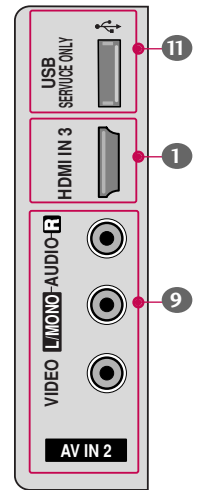
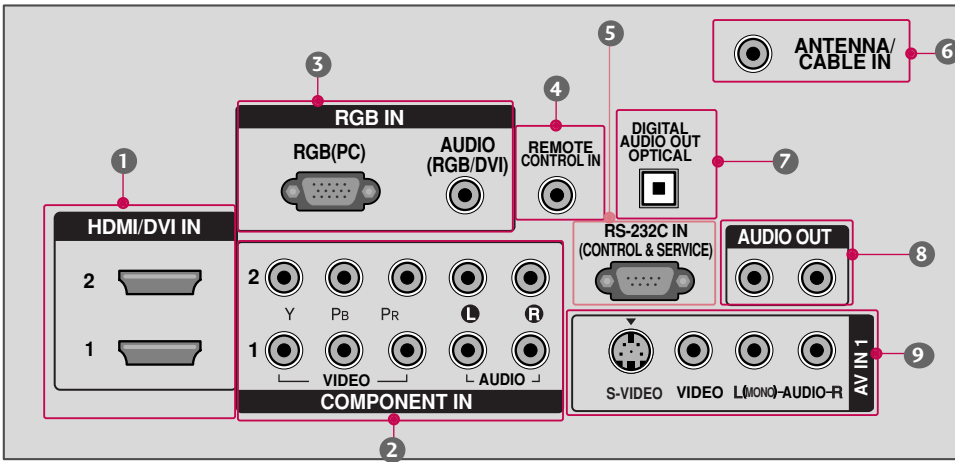

37/42/47/52LG50

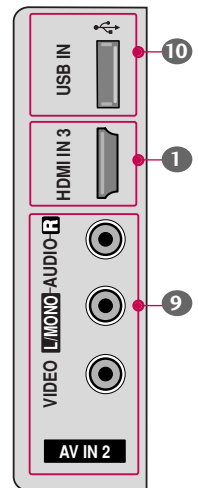
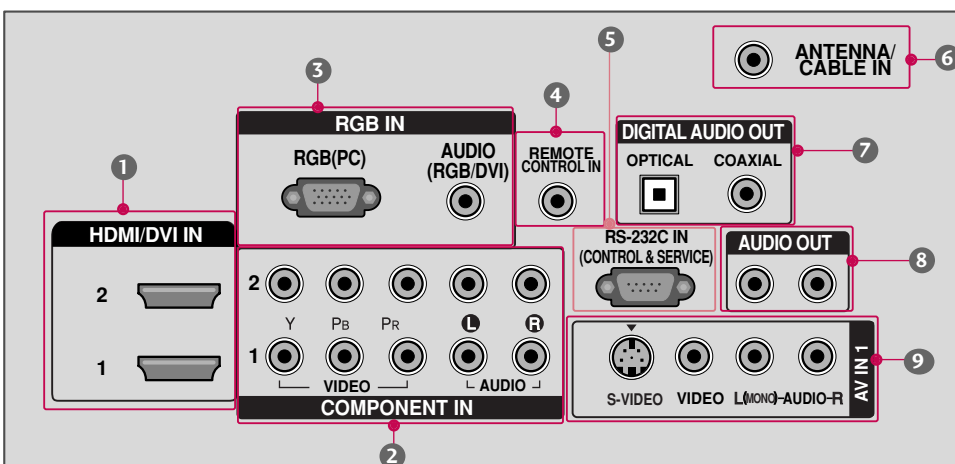

PREPARATION

Image shown may differ from your TV.

LCD TV Models

PREPARATION

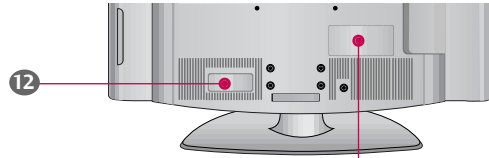

32/42/47/52LG70

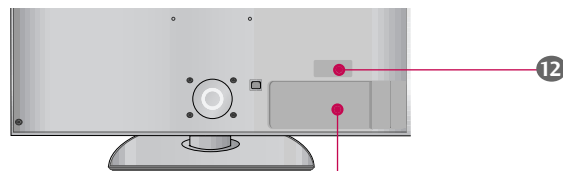
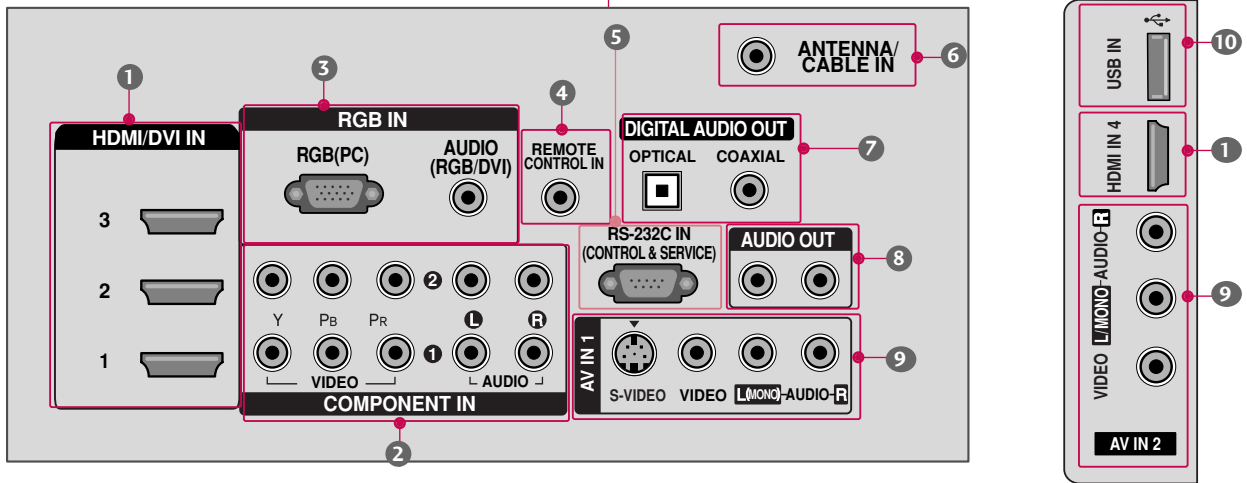

32/37/42/47/52LG60

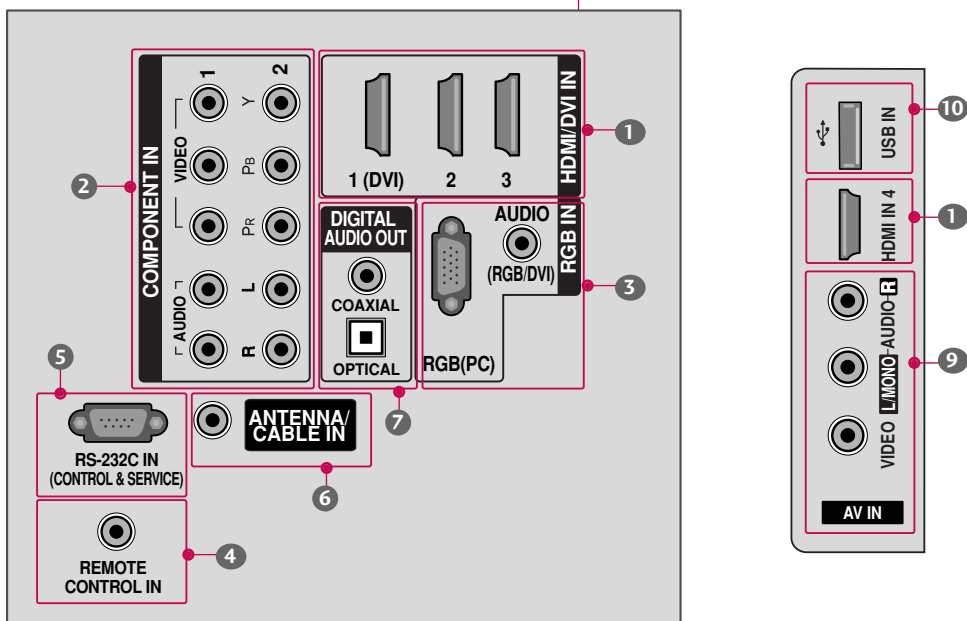

- 1 HDMI/DVI IN, HDMI IN**
Digital Connection.
Supports HD video and Digital audio. Doesn't support 480i.
Accepts DVI video using an adapter or HDMI to DVI cable (not included)
- 2 COMPONENT IN**
Analog Connection.
Supports HD.
Uses a red, green, and blue cable for video & red and white for audio.
- 3 RGB (PC)**
Analog PC Connection. Uses a D-sub 15 pin cable (VGA cable).
AUDIO (RGB/DVI)
1/8" headphone jack for analog PC audio input.
- 4 REMOTE CONTROL PORT**
For a wired remote control.
- 5 RS-232C IN (CONTROL & SERVICE) PORT**
Used by third party devices.
- 6 ANTENNA/CABLE IN**
Connect over-the air signals to this jack.
Connect cable signals to this jack.
- 7 DIGITAL AUDIO OUT**
Digital audio output for use with amps and home theater systems.
Includes an optical and/or coaxial connection.
Note: In standby mode, these ports do not work.
- 8 AUDIO OUT**
Analog audio output for use with amps and home theater systems.
- 9 AV (Audio/Video) IN**
Analog composite connection. Supports standard definition video only (480i).
S-VIDEO
Better quality than standard composition. Supports standard definition video only (480i).
- 10 USB INPUT**
Used for viewing photos and listening to MP3s.
- 11 USB SERVICE ONLY**
Used for software updates.
- 12 Power Cord Socket**
For operation with AC power.
Caution: Never attempt to operate the TV on DC power.

PREPARATION

STAND INSTALLATION

▪ Image shown may differ from your TV.

Only 42PG60

- 1 Carefully place the TV screen side down on a cushioned surface to protect the screen from damage.

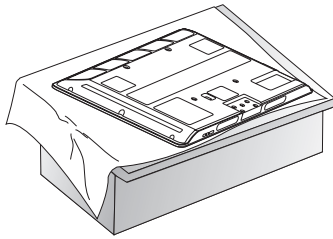

- 2 Assemble the TV as shown.

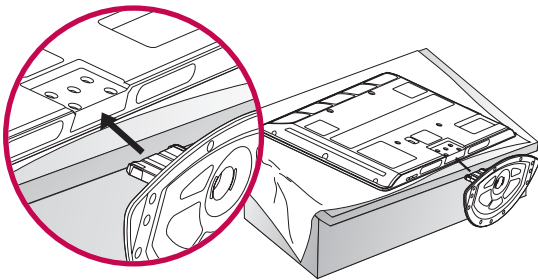

- 3 Fix the 4 bolts securely using the holes in the back of the TV.

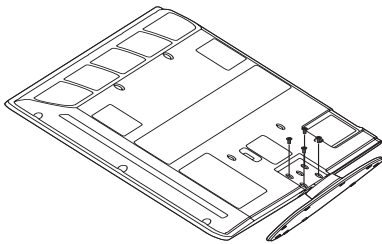

Only 32/37/42LG30, 37/42LG50, 32/42LG70

- 1 Carefully place the TV screen side down on a cushioned surface to protect the screen from damage.

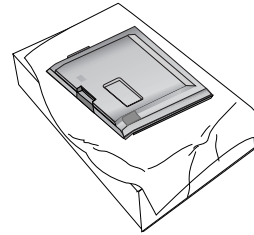

- 2 Assemble the parts of the **STAND BODY** with **COVER BASE** of the TV.

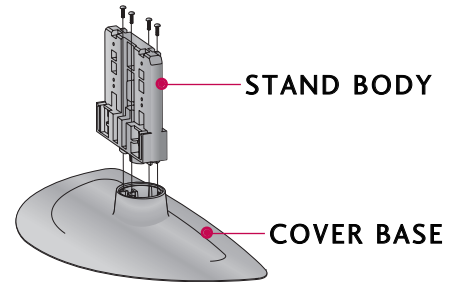

- 3 Assemble the TV as shown.

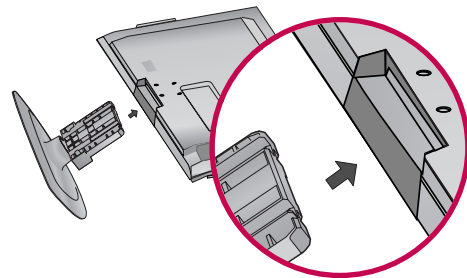

- 4 Fix the 4 bolts securely using the holes in the back of the TV.

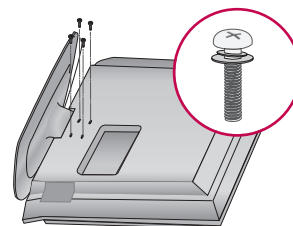

Only 32/37/42LG60

- 1 Carefully place the TV screen side down on a cushioned surface to protect the screen from damage.

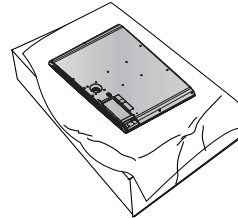

- 2 Assemble the parts of the **STAND BODY** with **COVER BASE** of the TV.

32LG60

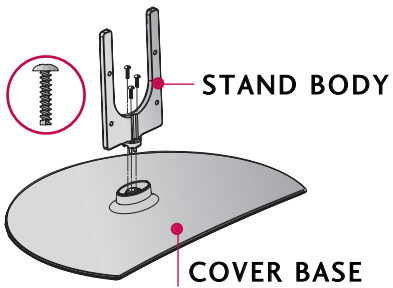

37LG60

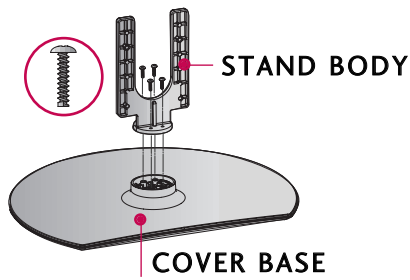

42LG60

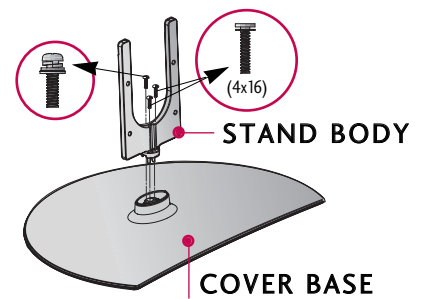

- 3 Assemble the TV as shown.

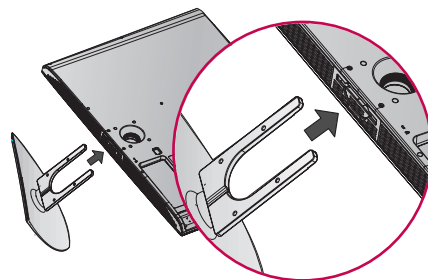

- 4 Fix the 4 bolts securely using the holes in the back of the TV.

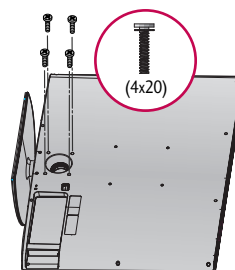

PREPARATION

CABLE MANAGEMENT

■ Image shown may differ from your TV.

Plasma TV Models

- 1 Connect the cables as necessary.
To connect additional equipment, see the **EXTERNAL EQUIPMENT SETUP** section.

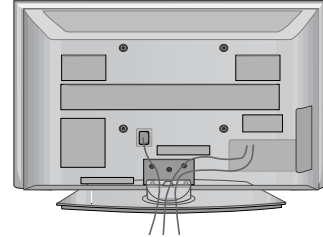

- 2 Install the **CABLE MANAGEMENT CLIP** as shown.
If your TV has the **CABLE HOLDER**, install it as shown and bundle the cables.

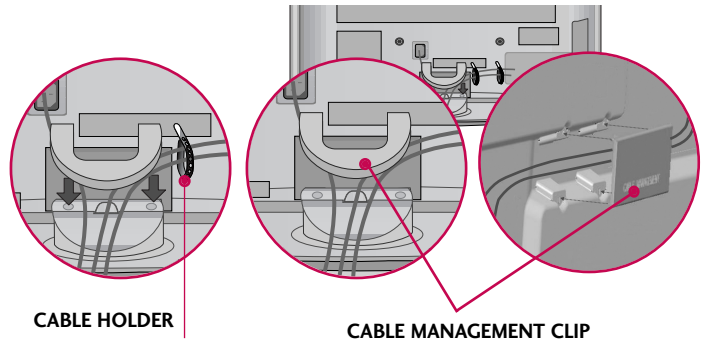

How to remove the **CABLE MANAGEMENT CLIP**

42PG60

- ▶ First, press the cable management. Hold the **CABLE MANAGEMENT CLIP** with both hands and pull it upward.

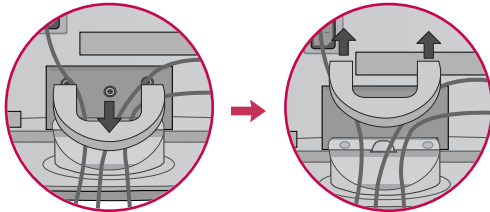

50/60PG60

- ▶ Hold the **CABLE MANAGEMENT CLIP** with both hands and pull it backward.
- ▶ Separate **CABLE MANAGEMENT CLIP** from TV by pressing two latches.

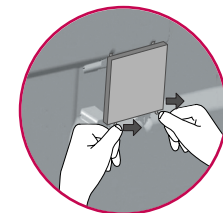
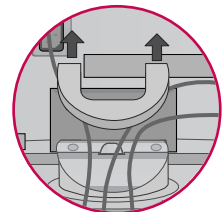

NOTE

- ▶ Do not hold the **CABLE MANAGEMENT CLIP** when moving the TV.
- If the TV is dropped, you may be injured or the product may be broken.

LCD TV Models

**32/37/42LG30, 37/42/47/52LG50,
32/42/47/52LG70**

- 1 Connect the cables as necessary.
To connect additional equipment, see the **EXTERNAL EQUIPMENT SETUP** section.

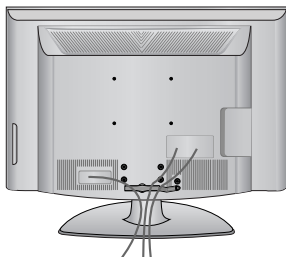

- 2 Install the **CABLE MANAGEMENT CLIP** as shown.

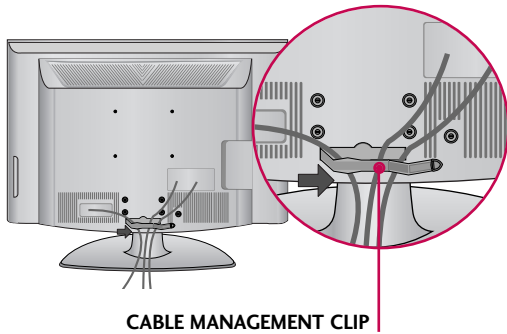

- 3 Put the cables inside the **CABLE MANAGEMENT CLIP** and snap it closed.

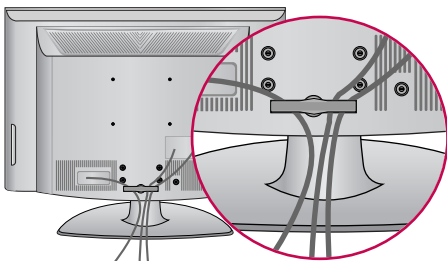

32/37/42/47/52LG60

- 1 Align the hole with the tab on the **CABLE MANAGEMENT CLIP**.

Turn the **CABLE MANAGEMENT CLIP** as shown.

Note: This cable management can be broken by excessive pressure.

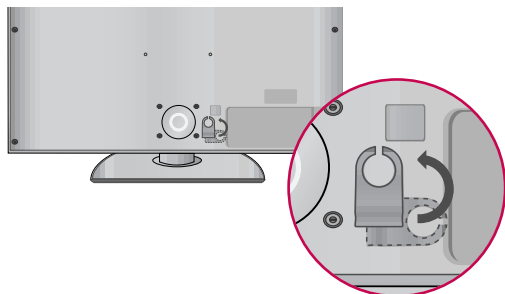
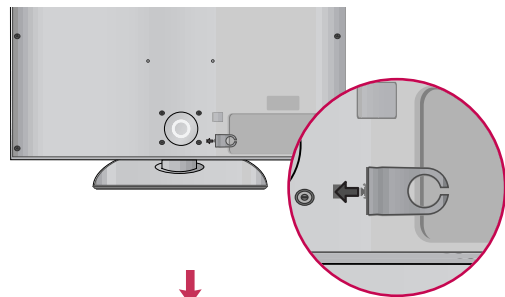

- 2 Connect the cables as necessary.
To connect additional equipment, see the **EXTERNAL EQUIPMENT SETUP** section.

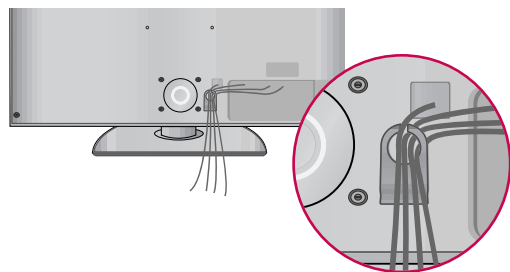

PREPARATION

DESKTOP PEDESTAL INSTALLATION

■ Image shown may differ from your TV.

For proper ventilation, allow a clearance of 4 inches on all four sides from the wall.

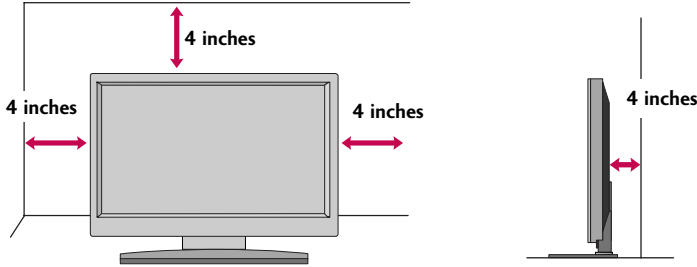

CAUTION ▶ Ensure adequate ventilation by following the clearance recommendations.

SWIVEL STAND

After installing the TV, you can adjust the TV set manually to the left or right direction by 20 degrees to suit your viewing position.

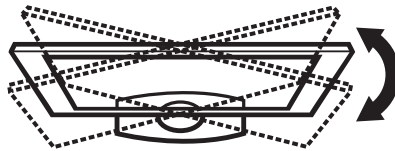

ATTACHING THE TV TO A DESK (Only 32LG30/70)

The TV must be attached to a desk so it cannot be pulled in a forward/backward direction, potentially causing injury or damaging the product. Use only an attached screw.

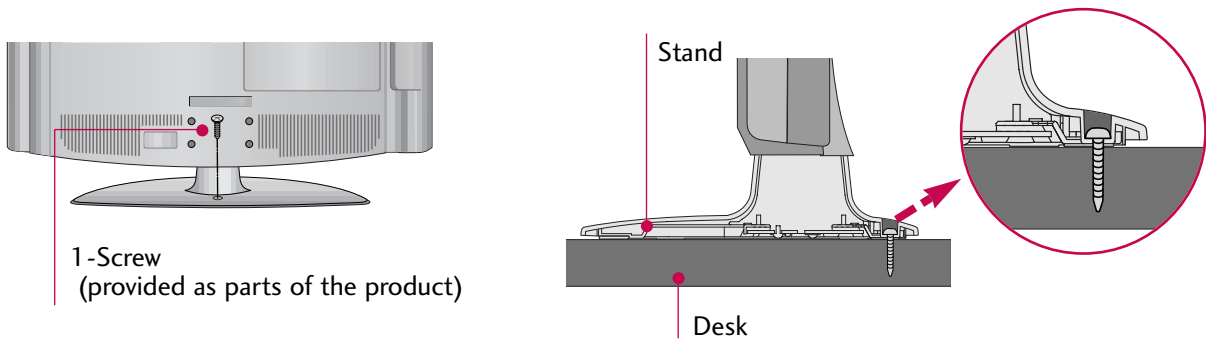

WARNING
▶ To prevent TV from falling over, the TV should be securely attached to the floor/wall per installation instructions. Tipping, shaking, or rocking the machine may cause injury.

VESA WALL MOUNTING

This TV accepts VESA FDMI compliant mounts via the four screw holes on the back of the TV. These mounts are sold by third parties and not available from LG. Refer to the instructions included with the mount for more info.

Plasma TV Models

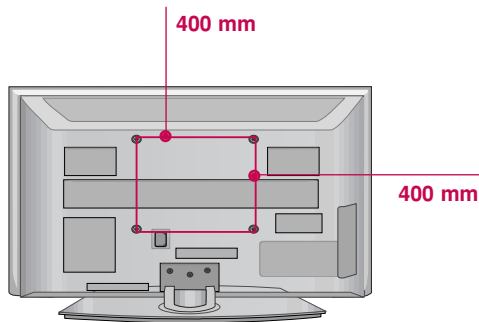

LCD TV Models

**32/37/42LG30, 37/42/47/52LG50,
32/42/47/52LG70**

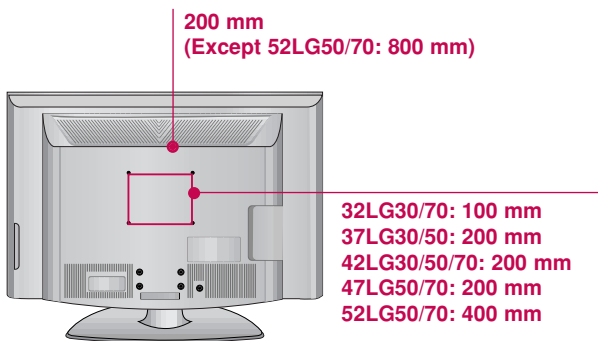

32/37/42/47/52LG60

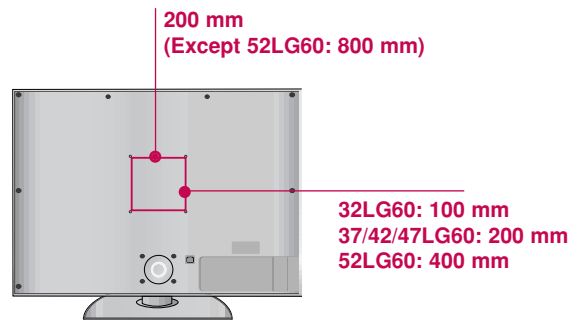

! NOTE

- ▶ Screw length needed depends on the wall mount used. For further information, refer to the instructions included with the mount.

PREPARATION

PROTECTION COVER

- Image shown may differ from your TV.

You can remove the stand before installing the TV on a wall mount by performing the previous stand instructions in reverse. After removing the stand, install the included **protection cover** over the hole for the stand.

Insert the **PROTECTION COVER** into the TV until clicking sound.

Plasma TV Models

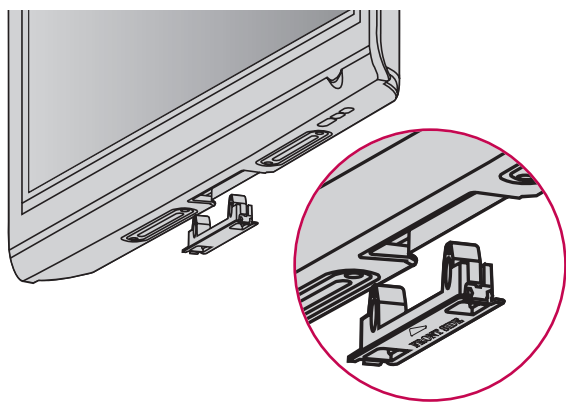

LCD TV Models

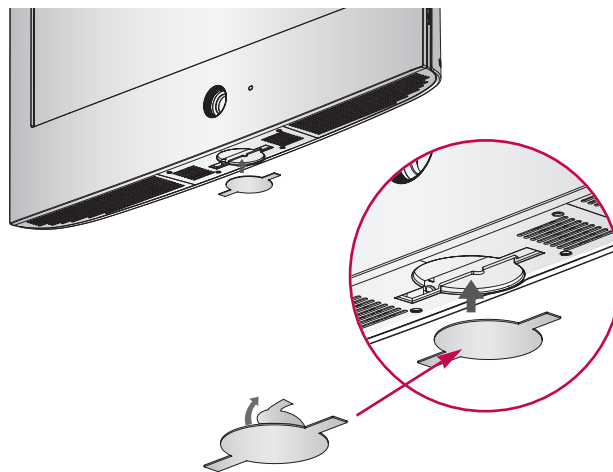
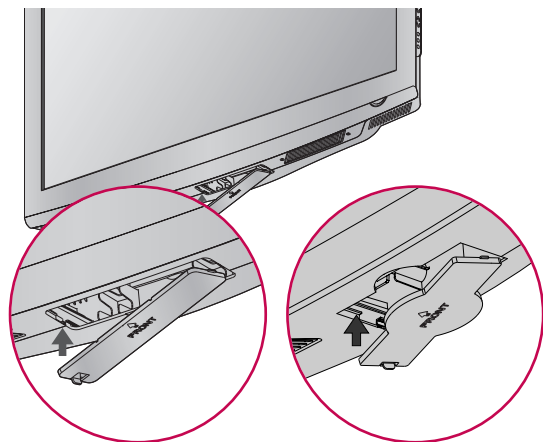

After removing the protection paper from the protection cover, adhere it to the TV as shown.

SECURING THE TV TO THE WALL TO PREVENT FALLING

- You should purchase necessary components to prevent TV from falling off of the stand.
- Image shown may differ from your TV.

We recommend that you set up the TV close to a wall so it cannot fall over if pushed backwards. Additionally, we recommend that the TV be attached to a wall so it cannot be pulled in a forward direction, potentially causing injury or damaging the product.

Caution: Please make sure that children don't climb on or hang from the TV.

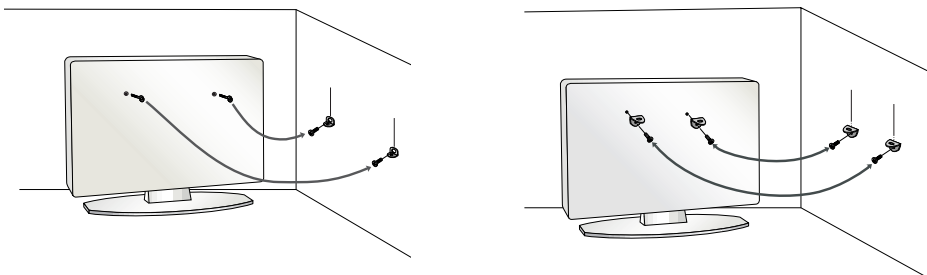

- Insert the eye-bolts (or TV brackets and bolts) to tighten the product to the wall as shown in the picture.

* If your product has the bolts in the eye-bolts position before inserting the eye-bolts, loosen the bolts.

* Insert the eye-bolts or TV brackets/bolts and tighten them securely in the upper holes.

Secure the wall brackets with the bolts (not provided as parts of the product, must purchase separately) to the wall. Match the height of the bracket that is mounted on the wall to the holes in the product.

Ensure the eye-bolts or brackets are tightened securely.

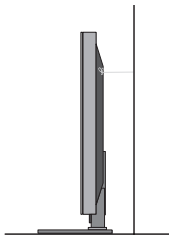

- Use a sturdy rope (not provided as parts of the product, must purchase separately) to tie the product. It is safer to tie the rope so it becomes horizontal between the wall and the product.

! NOTE

- ▶ Use a platform or cabinet strong enough and large enough to support the size and weight of the TV.
- ▶ To use the TV safely make sure that the height of the bracket on the wall and the one on the TV are the same.

PREPARATION

- To prevent damage do not connect to the power outlet until all connections are made between the devices.

ANTENNA OR CABLE CONNECTION

1. Antenna (Analog or Digital)

Wall Antenna Socket or Outdoor Antenna without a Cable Box Connection.

For optimum picture quality, adjust antenna direction if needed.

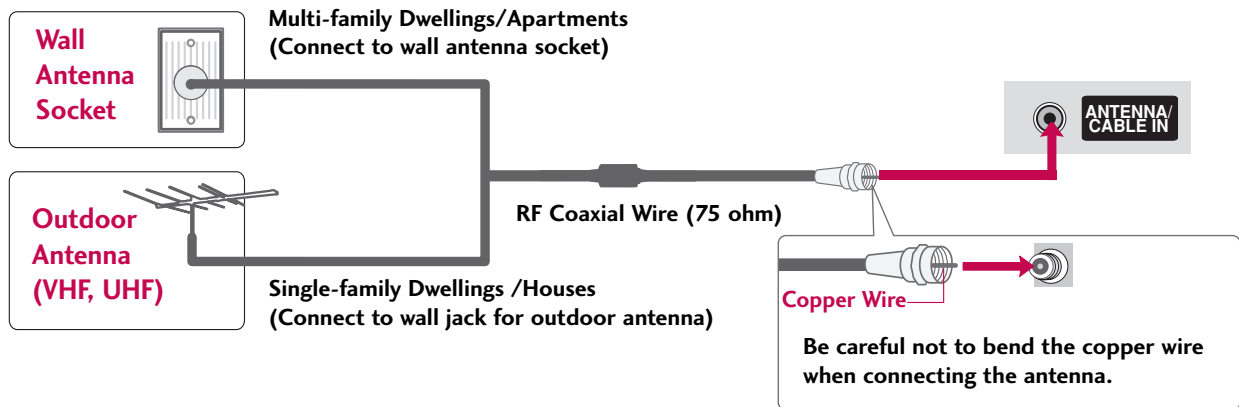

2. Cable

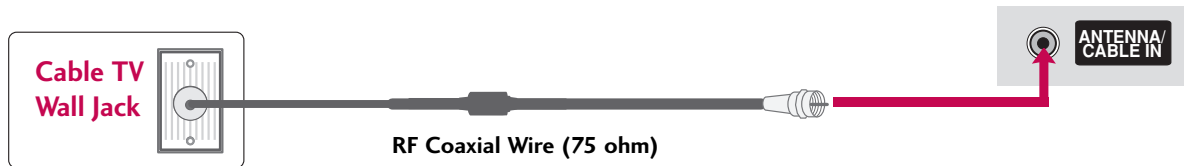

- To improve the picture quality in a poor signal area, please purchase a signal amplifier and install properly.
- If the antenna needs to be split for two TV's, install a 2-Way Signal Splitter.
- If the antenna is not installed properly, contact your dealer for assistance.

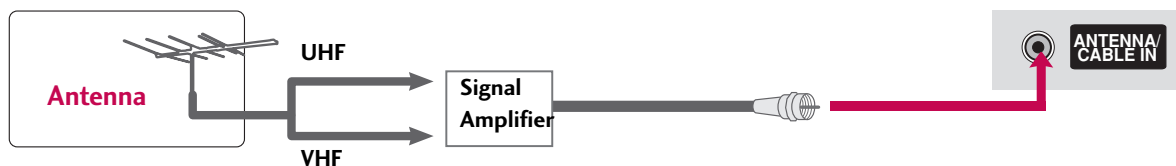

NOTE ▶ The TV will let you know when the analog, cable, and digital channel scans are complete.

EXTERNAL EQUIPMENT SETUP

- To prevent the equipment damage, never plug in any power cords until you have finished connecting all equipment.
- Image shown may differ from your TV.

HD RECEIVER SETUP

This TV can receive Digital Over-the-air/Cable signals without an external digital set-top box. However, if you do receive digital signals from a digital set-top box or other digital external device, refer to the figure as shown below.

Component Connection

1. How to connect

- 1 Connect the video outputs (Y, PB, PR) of the digital set-top box to the **COMPONENT IN VIDEO 1** jacks on the TV. Match the jack colors (Y = green, PB = blue, and PR = red).
- 2 Connect the audio output of the digital set-top box to the **COMPONENT IN AUDIO 1** jacks on the TV.

2. How to use

- Turn on the digital set-top box.
(Refer to the owner's manual for the digital set-top box operation)
- Select the **Component 1** input source on the TV using the **INPUT** button on the remote control.
- If connected to **COMPONENT IN2** input, select the **Component 2** input source on the TV.

Supported Resolutions

Signal	Component	HDMI
480i	Yes	No
480p	Yes	Yes
720p	Yes	Yes
1080i	Yes	Yes
1080p	Yes	Yes

Y, CB/PB, CR/PR

Resolution	Horizontal Frequency(KHz)	Vertical Frequency(Hz)
720x480i	15.73	59.94
	15.73	60.00
720x480p	31.47	59.94
	31.50	60.00
1280x720p	44.96	59.94
	45.00	60.00
1920x1080i	33.72	59.94
	33.75	60.00
1920x1080p	26.97	23.976
	27.00	24.00
	33.71	29.97
	33.75	30.00
	67.432	59.94
	67.50	60.00

EXTERNAL EQUIPMENT SETUP

Plasma TV, 32/37/42LG30, 37/42/47/52LG50,
32/42/47/52LG70

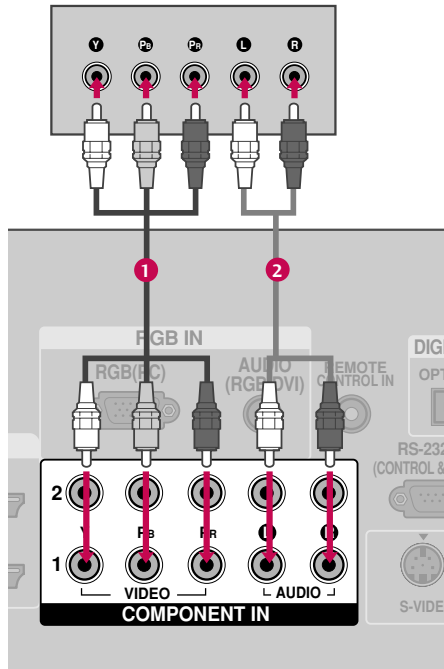

32/37/42/47/52LG60

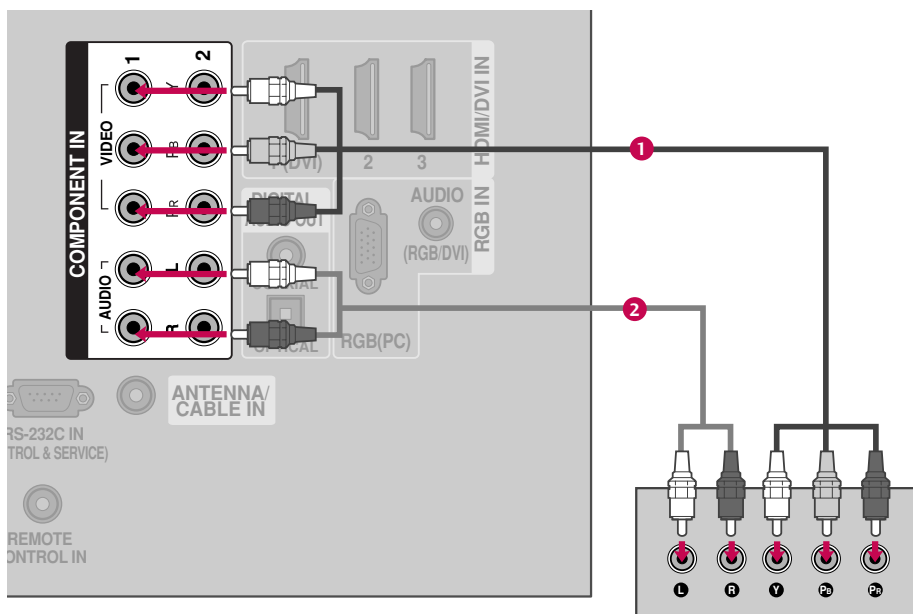

HDMI Connection

1. How to connect

- 1 Connect the digital set-top box to **HDMI/DVI IN1**, **2**, **3**, or **4** jack on the TV.
- 2 No separate audio connection is necessary.
HDMI supports both audio and video.

2. How to use

- Turn on the digital set-top box.
(Refer to the owner's manual for the digital set-top box.)
- Select the **HDMI1**, **HDMI2**, **HDMI3**, or **HDMI4** input source on the TV using the **INPUT** button on the remote control.

HDMI-DTV

Resolution	Horizontal Frequency(KHz)	Vertical Frequency(Hz)
720x480p	31.47	59.94
	31.50	60.00
1280x720p	44.96	59.94
	45.00	60.00
1920x1080i	33.72	59.94
	33.75	60.00
1920x1080p	26.97	23.976
	27.00	24.00
	33.71	29.97
	33.75	30.00
	67.432	59.939
	67.50	60.00

EXTERNAL EQUIPMENT SETUP

32/37/42LG30, 37/42/47/52LG50

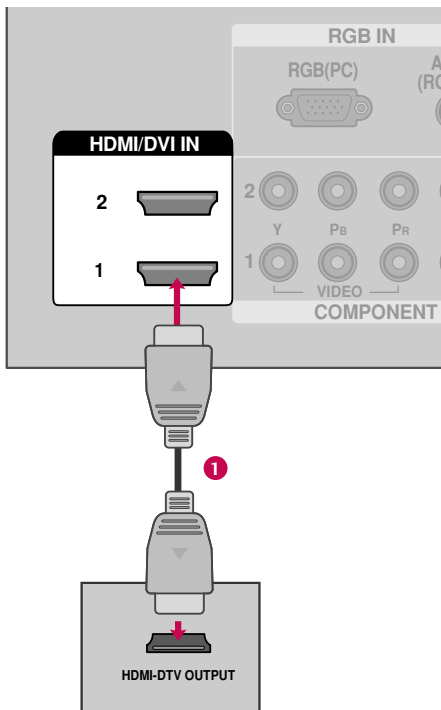

Plasma TV, 32/42/47/52LG70

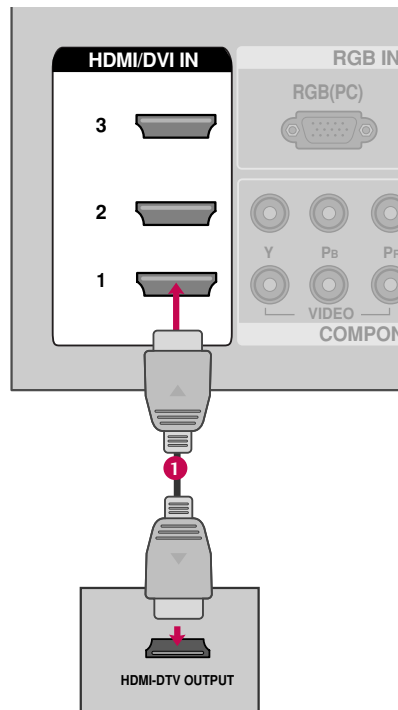

32/37/42/47/52LG60

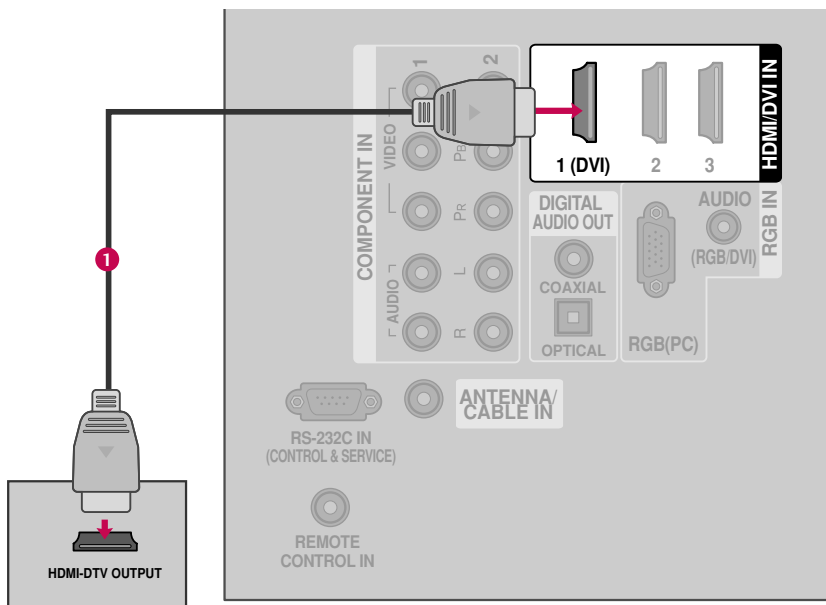

DVI to HDMI Connection

NOTE ▶ A DVI to HDMI cable or adapter is required for this connection. DVI doesn't support audio, so a separate audio connection is necessary.

32/37/42LG30, 37/42/47/52LG50

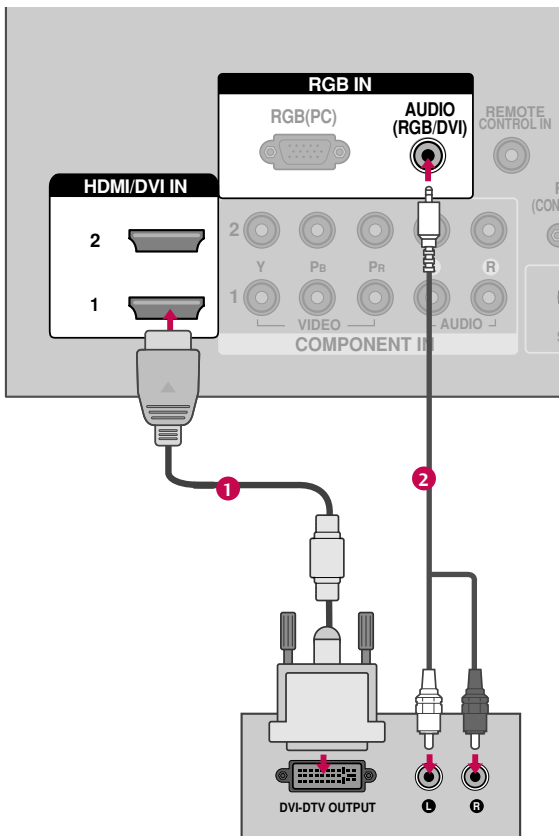

Plasma TV, 32/42/47/52LG70

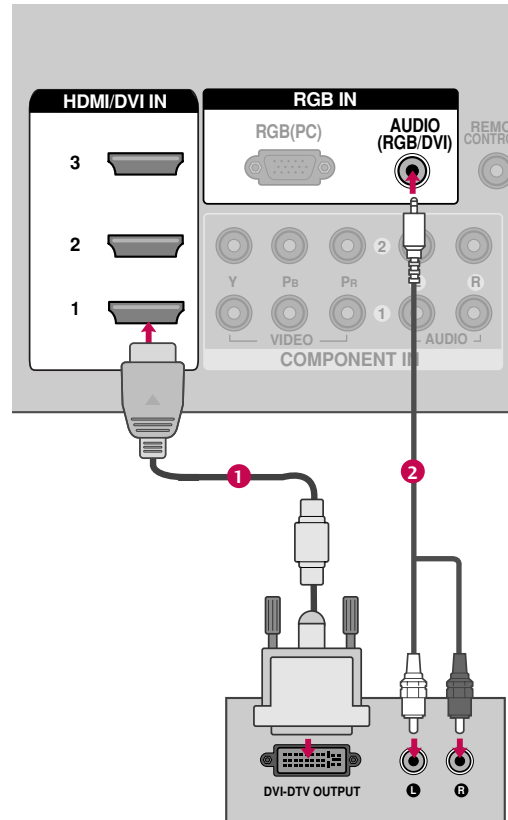

1. How to connect

- 1** Connect the DVI output of the digital set-top box to the **HDMI/DVI IN 1, 2, or 3** jack on the TV.
- 2** Connect the PC audio output to the **AUDIO (RGB/DVI)** jack on the TV.

2. How to use

- Turn on the digital set-top box. (Refer to the owner's manual for the digital set-top box.)
- Select the **HDMI1, HDMI2, or HDMI3** input source on the TV using the **INPUT** button on the remote control.

EXTERNAL EQUIPMENT SETUP

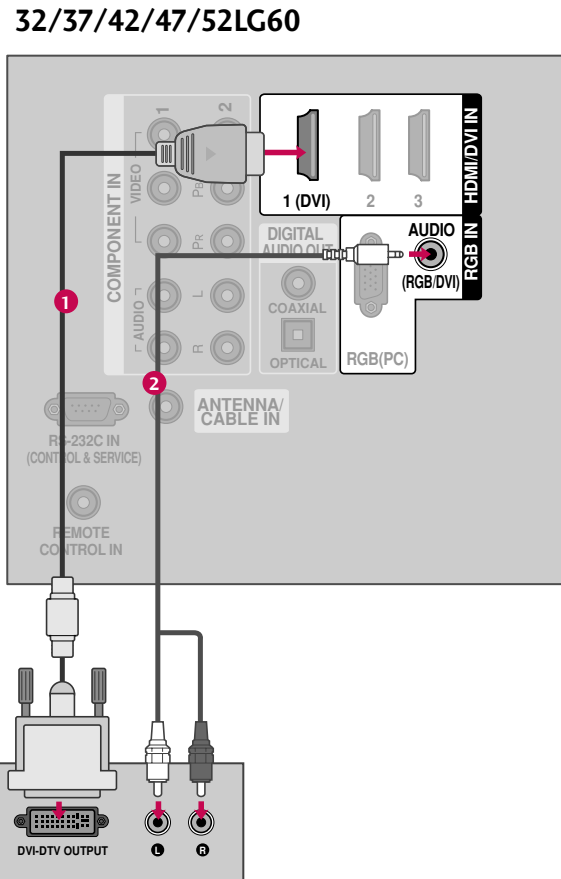

1. How to connect

- 1 Connect the DVI output of the digital set-top box to the **HDMI/DVI IN 1** jack on the TV.
- 2 Connect the PC audio output to the **AUDIO (RGB/DVI)** jack on the TV.

2. How to use

- Turn on the digital set-top box. (Refer to the owner's manual for the digital set-top box.)
- Select **HDMI1** input source on the TV using the **INPUT** button on the remote control.

DVD SETUP

Component Connection

1. How to connect

- 1 Connect the video outputs (Y, PB, PR) of the DVD to the **COMPONENT IN VIDEO1** jacks on the TV.
Match the jack colors (Y = green, PB = blue, and PR = red).

- 2 Connect the audio outputs of the DVD to the **COMPONENT IN AUDIO1** jacks on the TV.

2. How to use

- Turn on the DVD player, insert a DVD.
- Select the **Component 1** input source on the TV using the **INPUT** button on the remote control.
- If connected to **COMPONENT IN 2** input, select the **Component 2** input source on the TV.
- Refer to the DVD player's manual for operating instructions.

Component Input ports

To get better picture quality, connect a DVD player to the component input ports as shown below.

Component ports on the TV	Y	P _B	P _R
Video output ports on DVD player	Y	P _B	P _R
	Y	B-Y	R-Y
	Y	C _b	C _r
	Y	P _b	P _r

EXTERNAL EQUIPMENT SETUP

Plasma TV, 32/37/42LG30, 37/42/47/52LG50,
32/42/47/52LG70

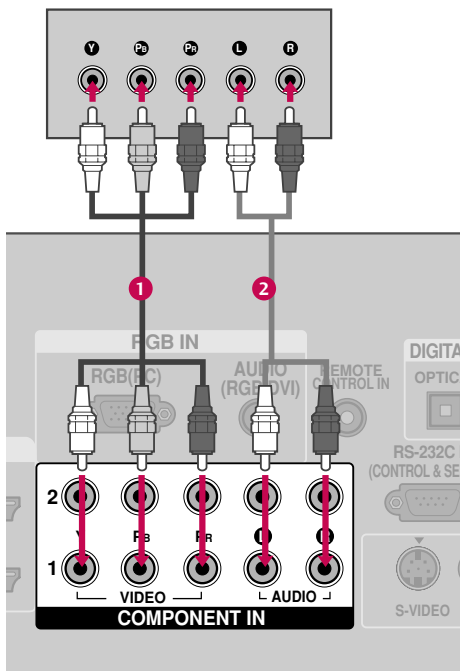

32/37/42/47/52LG60

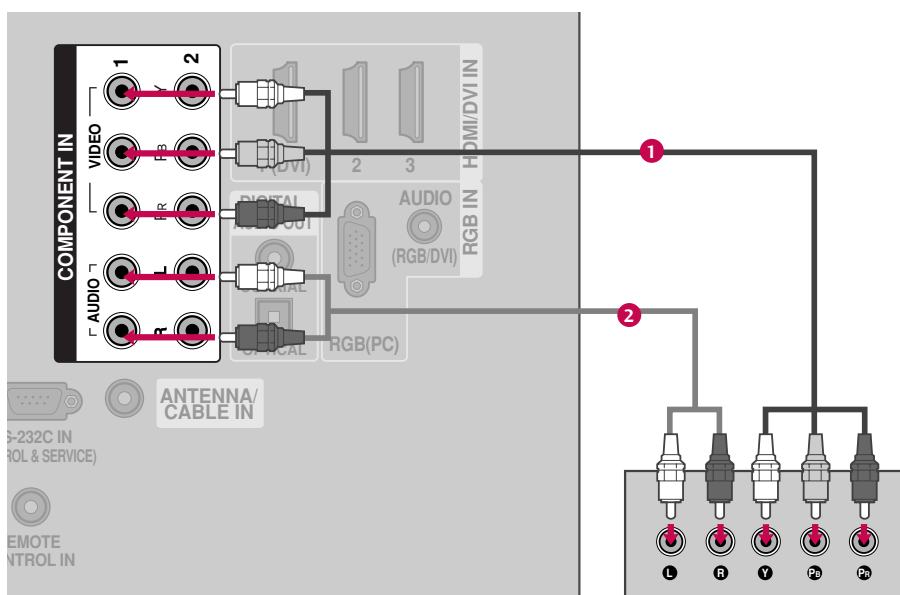

S-Video Connection (Except 32/37/42/47/52LG60)

1. How to connect

- 1 Connect the S-VIDEO output of the DVD to the **S-VIDEO** input on the TV.
- 2 Connect the audio outputs of the DVD to the **AUDIO** input jacks on the TV.

2. How to use

- Turn on the DVD player, insert a DVD.
- Select the **AV1** input source on the TV using the **INPUT** button on the remote control.
- Refer to the DVD player's manual for operating instructions.

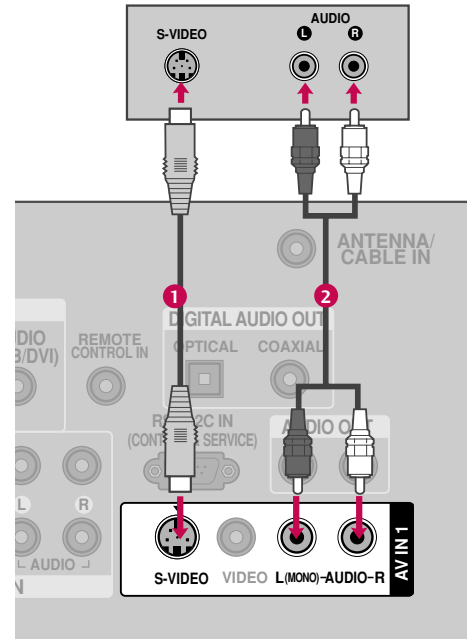

EXTERNAL EQUIPMENT SETUP

HDMI Connection

1. How to connect

- 1 Connect the HDMI output of the DVD to the HDMI/DVI IN1, 2, 3 or 4 jack on the TV.
- 2 No separate audio connection is necessary. HDMI supports both audio and video.

2. How to use

- Select the **HDMI1**, **HDMI2**, **HDMI3**, or **HDMI4** input source on the TV using the **INPUT** button on the remote control.
- Refer to the DVD player's manual for operating instructions.

32/37/42LG30, 37/42/47/52LG50

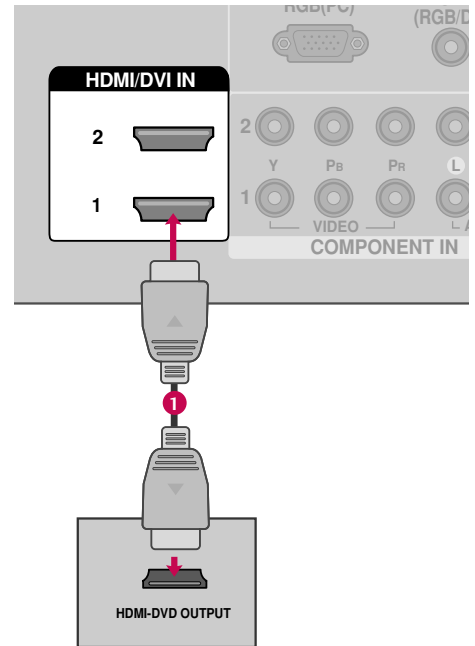

Plasma TV, 32/42/47/52LG70

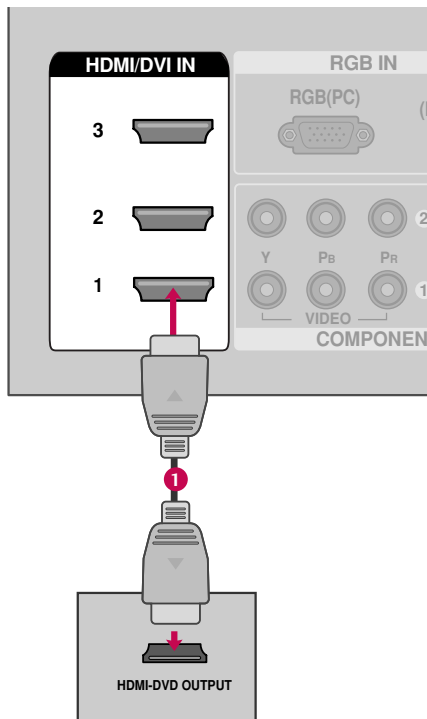

32/37/42/47/52LG60

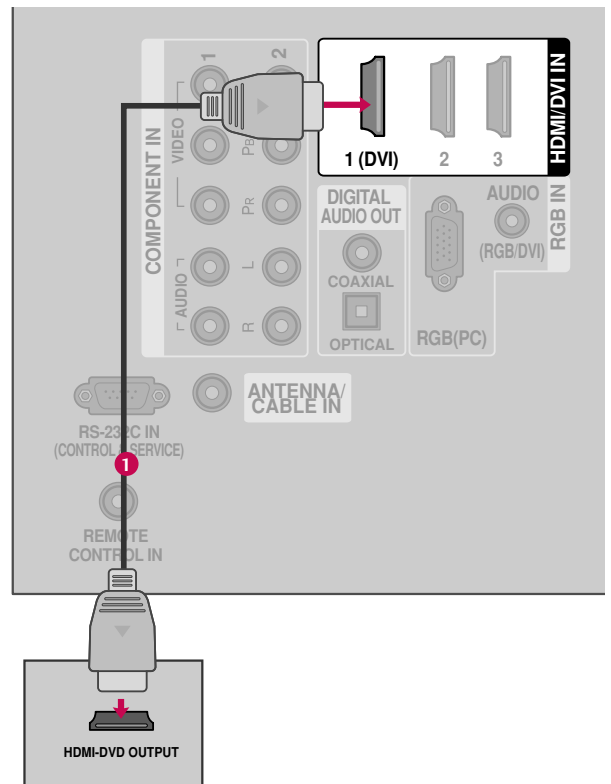

VCR SETUP

- To avoid picture noise (interference), leave an adequate distance between the VCR and TV.
- Use the ISM feature in the Option menu to avoid having a fixed image remain on the screen for a long period of time (Plasma TV models only). If the 4:3 picture format is used; the fixed images on the sides of the screen may remain visible on the screen. This phenomenon is common to all TVs and is not covered by warranty.

Antenna Connection

1. How to connect

- 1 Connect the RF antenna out socket of the VCR to the **ANTENNA/CABLE IN** socket on the TV.
- 2 Connect the antenna cable to the RF antenna in socket of the VCR.

2. How to use

- Set VCR output switch to 3 or 4 and then tune TV to the same channel number.
- Insert a video tape into the VCR and press PLAY on the VCR. (Refer to the VCR owner's manual.)

Plasma TV, 32/37/42LG30, 37/42/47/52LG50, 32/42/47/52LG70

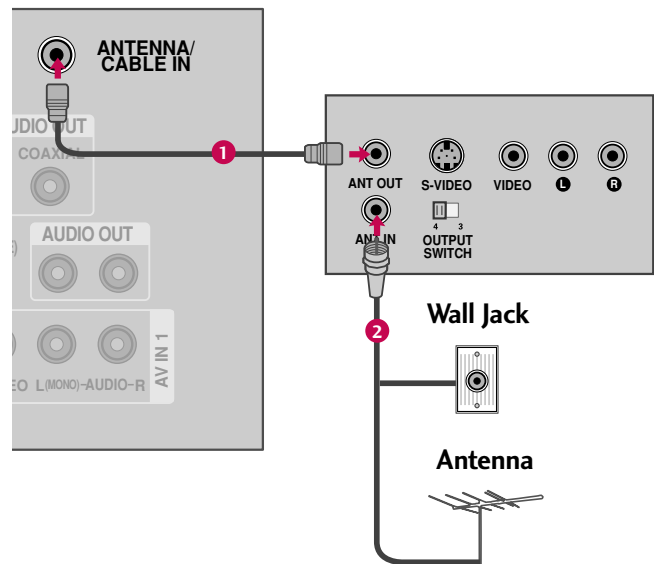

32/37/42/47/52LG60

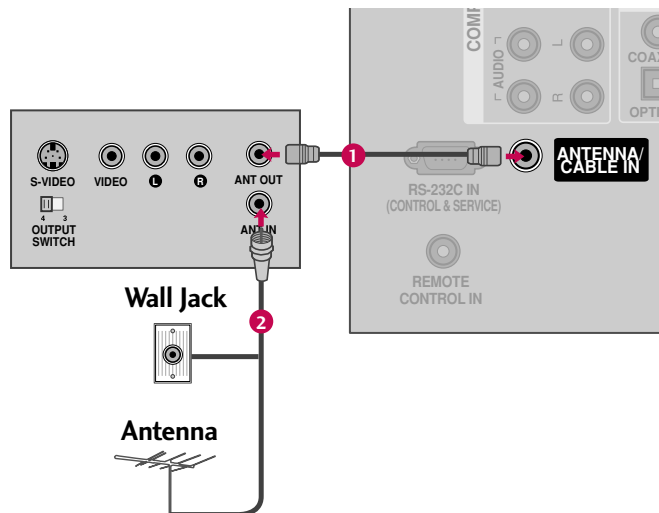

EXTERNAL EQUIPMENT SETUP

Composite (RCA) Connection

1. How to connect

- 1 Connect the **AUDIO/VIDEO** jacks between TV and VCR. Match the jack colors (Video = yellow, Audio Left = white, and Audio Right = red)

2. How to use

- Insert a video tape into the VCR and press PLAY on the VCR. (Refer to the VCR owner's manual.)
- Select the **AV1** input source on the TV using the **INPUT** button on the remote control.
- If connected to **AV IN2**, select **AV2** input source on the TV.

NOTE

- ▶ If you have a mono VCR, connect the audio cable from the VCR to the **AUDIO L/MONO** jack of the TV.

Plasma TV, 32/37/42LG30,
37/42/47/52LG50,
32/42/47/52LG70

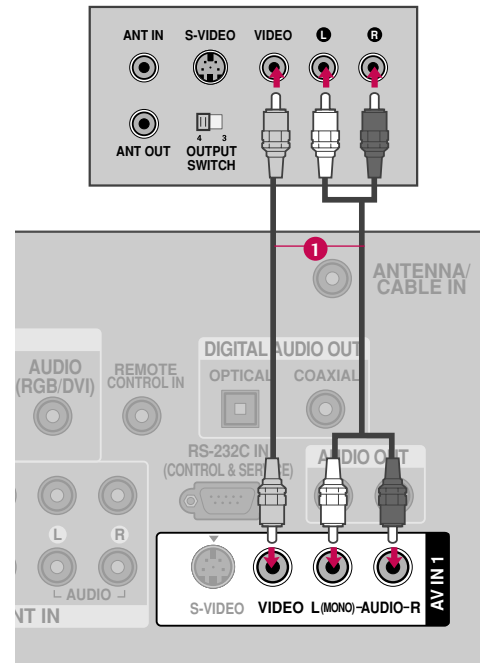

32/37/42/47/52LG60

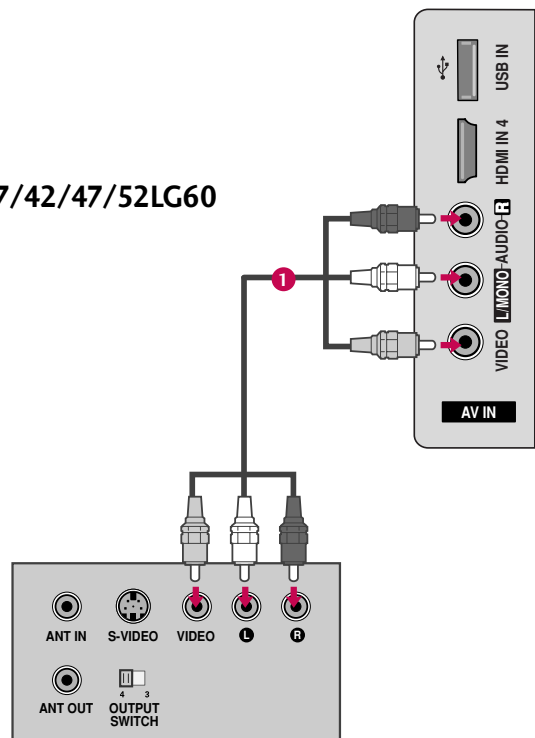

S-Video Connection (Except 32/37/42/47/52LG60)

1. How to connect

- 1 Connect the S-VIDEO output of the VCR to the S-VIDEO input on the TV.
- 2 Connect the audio outputs of the VCR to the AUDIO input jacks on the TV.

2. How to use

- Insert a video tape into the VCR and press PLAY on the VCR. (Refer to the VCR owner's manual.)
- Select the **AV1** input source on the TV using the **INPUT** button on the remote control.

NOTE

- ▶ S-Video provides better quality than composite. Use it when available.

CAUTION

- ▶ Do not connect to both Video and S-Video at the same time. In the event that you connect both Video and the S-Video cables, only the S-Video will work.

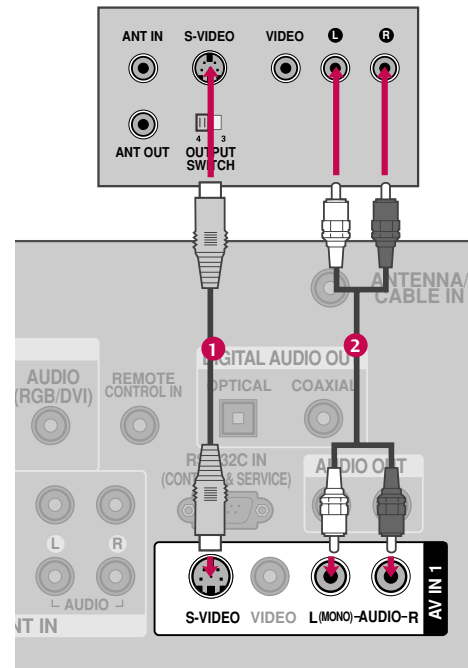

EXTERNAL EQUIPMENT SETUP

OTHER A/V SOURCE SETUP

1. How to connect

- 1 Connect the **AUDIO/VIDEO** jacks between TV and external equipment. Match the jack colors.
(Video = yellow, Audio Left = white, and Audio Right = red)

2. How to use

- Select the **AV2** input source on the TV using the **INPUT** button on the remote control.
- If connected to **AV IN1** input, select the **AV1** input source on the TV.
- Operate the corresponding external equipment.

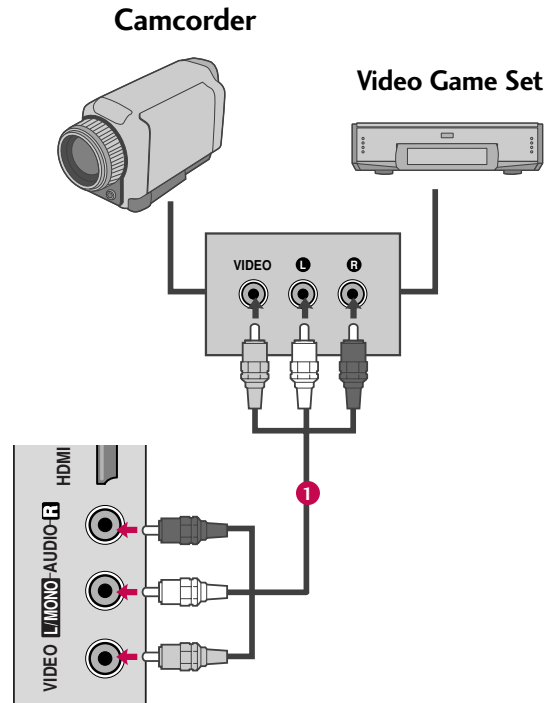

PC SETUP

This TV provides Plug and Play capability, meaning that the PC adjusts automatically to the TV's settings.

VGA (D-Sub 15 pin) Connection

Plasma TV, 32/37/42LG30,
37/42/47/52LG50, 32/42/47/52LG70

32/37/42/47/52LG60

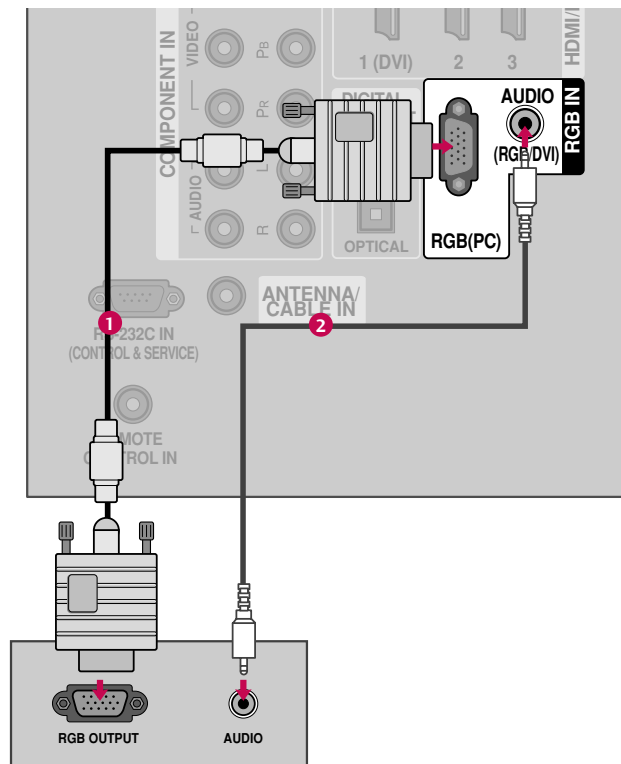
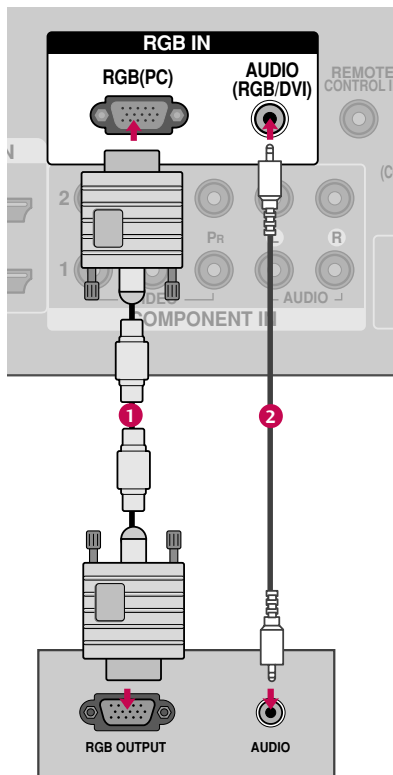

1. How to connect

- 1 Connect the VGA output of the PC to the **RGB (PC)** jack on the TV.
- 2 Connect the PC audio output to the **AUDIO (RGB/DVI)** jack on the TV.

2. How to use

- Turn on the PC and the TV.
- Select the **RGB-PC** input source on the TV using the **INPUT** button on the remote control.

EXTERNAL EQUIPMENT SETUP

DVI to HDMI Connection

32/37/42LG30, 37/42/47/52LG50

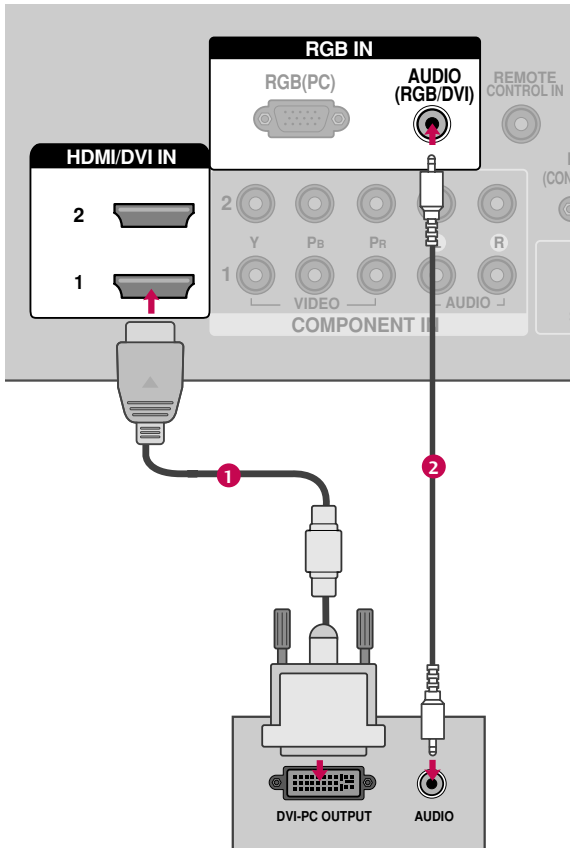

Plasma TV, 32/42/47/52LG70

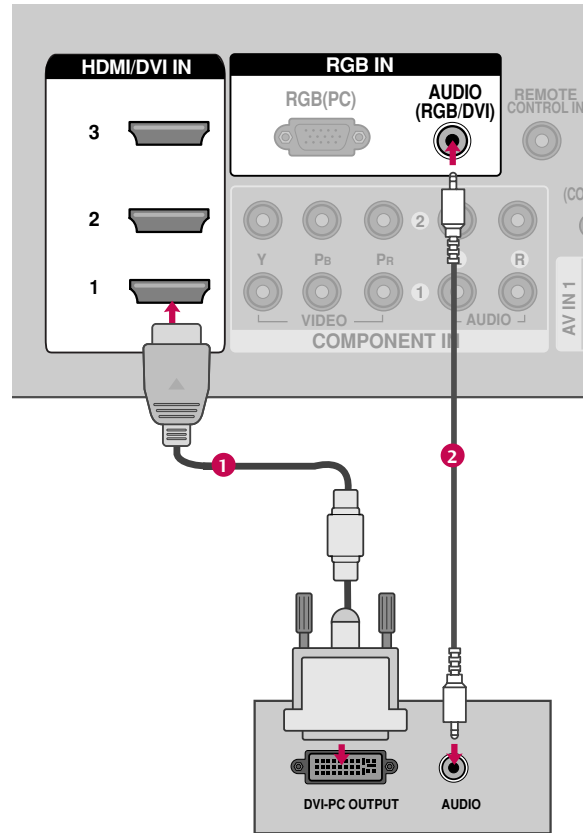

1. How to connect

- 1 Connect the DVI output of the PC to the **HDMI/DVI IN 1, 2, or 3** jack on the TV.
- 2 Connect the PC audio output to the **AUDIO (RGB/DVI)** jack on the TV.

2. How to use

- Turn on the PC and the TV.
- Select the **HDMI1, HDMI2, or HDMI3** input source on the TV using the **INPUT** button on the remote control.

1. How to connect

- 1 Connect the DVI output of the PC to the **HDMI/DVI IN1** jack on the TV.
- 2 Connect the PC audio output to the **AUDIO (RGB/DVI)** jack on the TV.

2. How to use

- Turn on the PC and the TV.
- Select the **HDMI1** input source on the TV using the **INPUT** button on the remote control.

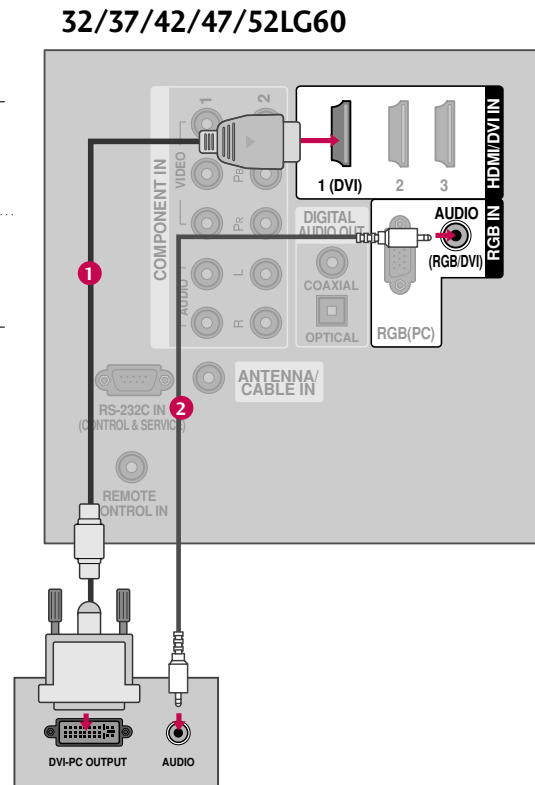

! NOTES

- ▶ 32/37/42LG30: To get the the best picture quality, adjust the PC graphics card to 1360x768.
- ▶ 37/42/47/52LG50, 32/42/47/52LG70: To get the the best picture quality, adjust the PC graphics card to 1920x1080.
- ▶ For Plasma TVs: To get the the best picture quality, adjust the PC graphics card to 1360x768.
- ▶ Depending on the graphics card, DOS mode may not work if a HDMI to DVI Cable is in use.
- ▶ In PC mode, there may be noise associated with the resolution, vertical pattern, contrast or brightness. If noise is present, change the PC output to another resolution, change the refresh rate to another rate or adjust the brightness and contrast on the PICTURE menu until the picture is clear.
- ▶ Avoid keeping a fixed image on the screen for a long period of time. The fixed image could become permanently imprinted on the screen.
- ▶ The synchronization input form for Horizontal and Vertical frequencies is separate.

EXTERNAL EQUIPMENT SETUP

Supported Display Specifications (RGB-PC, HDMI-PC)

! NOTE

▶ Depending on the graphics card, some resolution settings may not allow the image to be positioned on the screen properly.

For 32/37/42LG30

Resolution	Horizontal Frequency(KHz)	Vertical Frequency(Hz)
640x350	31.469	70.08 ●
720x400	31.469	70.08 ●
640x480	31.469	59.94
800x600	37.879	60.31
1024x768	48.363	60.00
1280x768	47.776	59.87
1360x768	47.720	59.799
1366x768	47.130	59.65

* Only RGB-PC mode

For 37/42/47/52LG50

Resolution	Horizontal Frequency(KHz)	Vertical Frequency(Hz)
640x350	31.468	70.09
720x400	31.469	70.08
640x480	31.469 37.500 37.861	59.94 75.00 72.80
800x600	35.156 37.879 46.875 48.077	56.25 60.31 75.00 72.18
1024x768	48.363 56.476 60.023	60.00 70.06 75.02
1280x768	47.776 60.289	59.87 74.893 ●
1280x1024	63.981 79.976	60.02 75.025
1360x768	47.712	60.015
1600x1200	75.00	60.00
1920x1080 RGB-PC	66.587	59.934
1920x1080 HDMI-PC	67.5	60.00

* Only RGB-PC mode

For 50/60PG60

Resolution	Horizontal Frequency(KHz)	Vertical Frequency(Hz)
640x350	31.468	70.09
720x400	31.469	70.08
640x480	31.469	59.94
	37.500	75.00
	37.861	72.80
800x600	35.156	56.25
	37.879	60.31
	46.875	75.00
	48.077	72.18
1024x768	48.363	60.00
	56.476	70.06
	60.023	75.02
1280x768	47.776	59.87
	60.289	74.893
1280x1024	63.981	60.02
	79.976	75.025
1360x768	47.712	60.015
1600x1200	75.00	60.00
1920x1080	66.587	59.934

* Only RGB-PC mode

For 32/37/42/47/52LG60, 32/42/47/52LG70

Resolution	Horizontal Frequency(KHz)	Vertical Frequency(Hz)
640x350	31.468	70.09
720x400	31.469	70.08
640x480	31.469	59.94
	37.500	75.00
	37.861	72.80
800x600	35.156	56.25
	37.879	60.31
	46.875	75.00
	48.077	72.18
1024x768	48.363	60.00
	56.476	70.06
	60.023	75.02
1280x768	47.776	59.87
	60.289	74.893
1280x1024	63.981	60.02
	79.976	75.025
1360x768	47.712	60.015
1600x1200	75.00	60.00
1920x1080	67.5	60.00

* Only RGB-PC mode

EXTERNAL EQUIPMENT SETUP

Screen Setup for PC mode







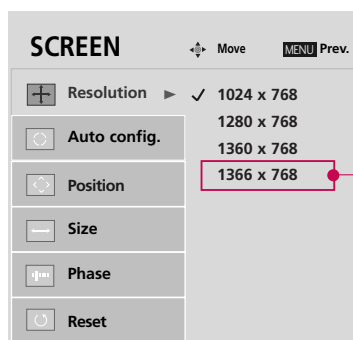
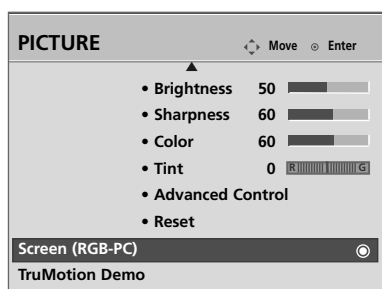

Selecting Resolution

You can choose the resolution in RGB-PC mode.

The **Position**, **Phase**, and **Size** can also be adjusted.











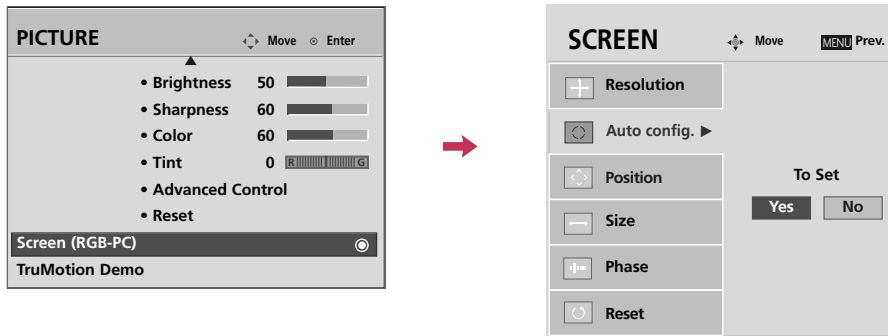

Only for LCD TV

-   Select **PICTURE**.
-   Select **Screen (RGB-PC)**.
-   Select **Resolution**.
-   Select the desired resolution.
- 

Auto Configure

Automatically adjusts picture position and minimizes image instability. After adjustment, if the image is still not correct, try using the manual settings or a different resolution or refresh rate on the PC.



- 1   Select **PICTURE**.
- 2   Select **Screen (RGB-PC)**.
- 3   Select **Auto config.**
- 4   Select **Yes**.
- 5  Start Auto Configuration.

- If the position of the image is still not correct, try Auto adjustment again.
- If picture needs to be adjusted again after Auto adjustment in RGB-PC, you can adjust the **Position**, **Size** or **Phase**.







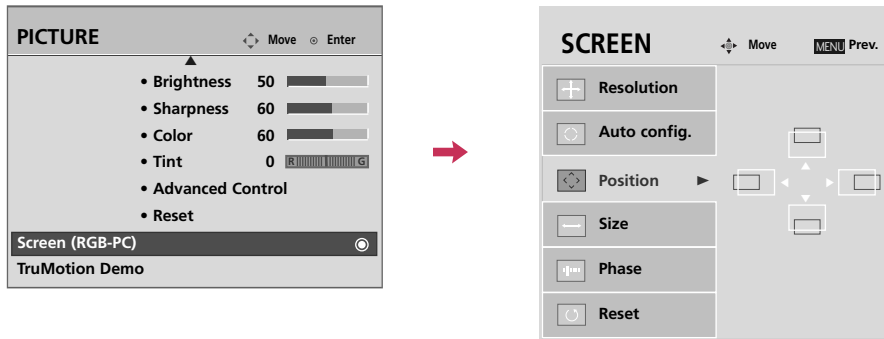

EXTERNAL EQUIPMENT SETUP

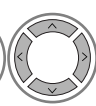
Adjustment for screen Position, Size, and Phase

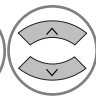
If the picture is not clear after auto adjustment and especially if characters are still trembling, adjust the picture phase manually.

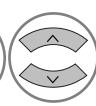
This feature operates only in RGB-PC mode.

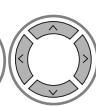









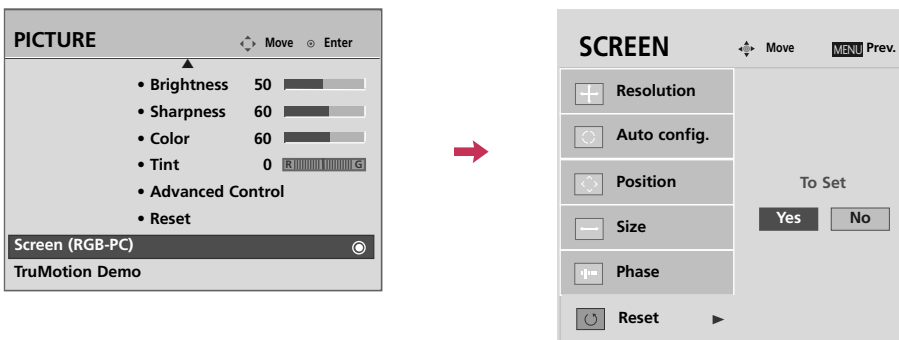

-   Select **PICTURE**.
-   Select **Screen (RGB-PC)**.
-   Select **Position, Size, or Phase**.
-   Make appropriate adjustments.
- 

- **Position:** This function is to adjust picture to left/right and up/down as you prefer.
- **Size:** This function is to minimize any vertical bars or stripes visible on the screen background. And the horizontal screen size will also change.
- **Phase:** This function allows you to remove any horizontal noise and clear or sharpen the image of characters.

Screen Reset (Reset to original factory values)

Returns **Position**, **Size**, and **Phase** to the default factory settings.
This feature operates only in RGB-PC mode.



- 1   Select **PICTURE**.
- 2   Select **Screen (RGB-PC)**.
- 3   Select **Reset**.
- 4   Select **Yes**.
- 5 

EXTERNAL EQUIPMENT SETUP

USB CONNECTION (Except 32/37/42LG30)

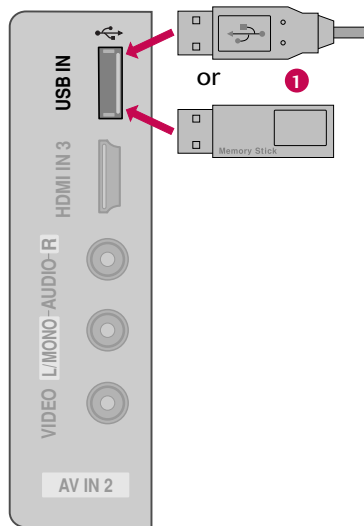

1. How to connect

-
- 1 Connect the USB device to the **USB IN** jack on the side of TV.
-

2. How to use

- After connecting the **USB IN** jack, you use the USB function. (▶ p.64)

AUDIO OUT CONNECTION

Send the TV's audio to external audio equipment via the Audio Output port.

Analog (Except 32/37/42/47/52LG60)

1. How to connect

- 1 Connect audio outputs to the TV's **AUDIO OUT** jacks.
- 2 Set the "TV Speaker option - Off" in the AUDIO menu. (▶ p.93). See the external audio equipment instruction manual for operation.

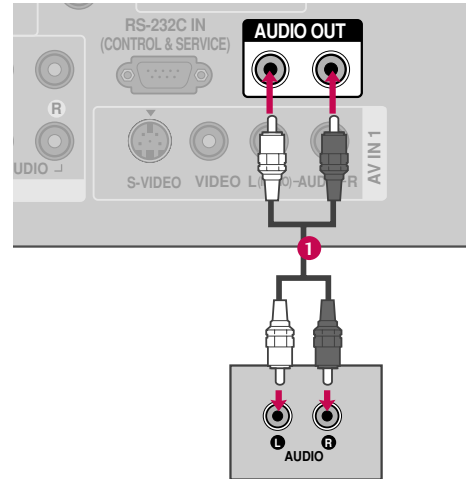

Digital

1. How to connect

- 1 Connect one end of the optical or coaxial cable to the TV's **OPTICAL** or **COAXIAL** (Except 32/37/42LG30) port of **DIGITAL AUDIO OUT**.
- 2 Connect the other end of the optical or coaxial cable to the digital audio input on the audio equipment.
- 3 Set the "TV Speaker option - Off" in the AUDIO menu. (▶ p.93). See the external audio equipment instruction manual for operation.

! NOTE

- ▶ When connecting with external audio equipments, such as amplifiers or speakers, you can turn the TV speakers off in the menu. (▶ p.93)

! CAUTION

- ▶ Do not look into the optical output port. Looking at the laser beam may damage your vision.
- ▶ Block the SPDIF out (optical/coaxial) about the contents with ACP(Audio Copy Protection) function.

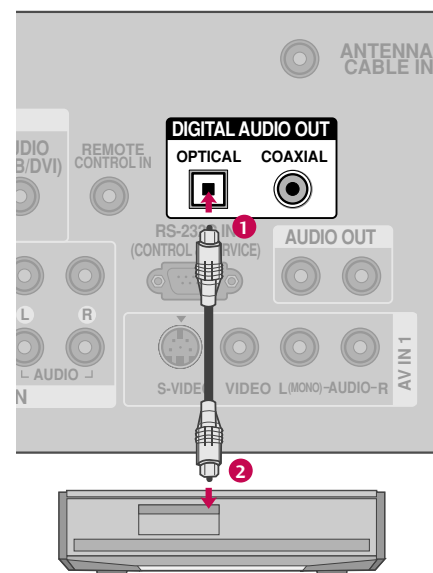

WATCHING TV / CHANNEL CONTROL

REMOTE CONTROL FUNCTIONS

When using the remote control, aim it at the remote control sensor on the TV.

TV/STB/DVD/VCR Select the remote operating mode: TV, STB, DVD, or VCR.

POWER Turns your TV or any other programmed equipment on or off, depending on the mode.

Q.MENU Select the desired quick menu source. ▶ p.51

MENU Displays the main menu.
Clear all on-screen displays and return to TV viewing from any menu.

INPUT External input modes rotate in regular sequence.

VOLUME UP / DOWN Increase/decrease the sound level.

FAV Scroll through the programmed Favorite channels. ▶ p.51

MUTE Switch the sound on or off. ▶ p.50

CHANNEL UP/DOWN Select available channels.

PAGE UP/DOWN Move from one full set of screen information to the next one.

NUMBER button

— (DASH) Used to enter a program number for multiple program channels such as 2-1, 2-2, etc.

FLASHBK Tune to the last channel viewed.

VCR/DVD, USB, SIMPLINK Control buttons

- Control video cassette recorders or DVD players.
- Control USB menu (PHOTO LIST and MUSIC LIST.)
- Control the SIMPLINK compatible devices.

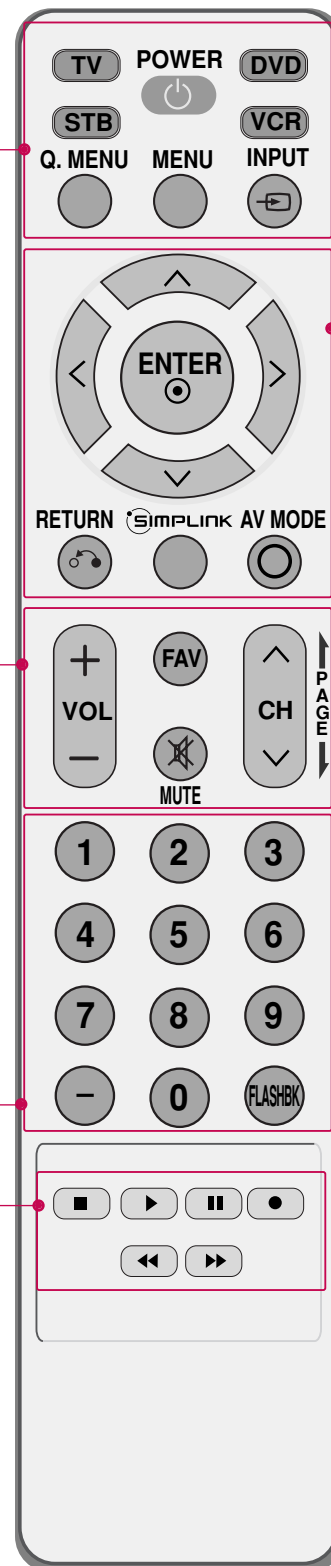

THUMBSTICK
(Up/Down/Left
Right/ENTER)

Navigate the on-screen menus and adjust the system settings to your preference.

RETURN

Allows the user to move return one step in an interactive application or other user interaction function.

SIMPLINK

See a list of AV devices connected to TV.

When you toggle this button, the SIMPLINK menu appears at the screen. ► p.62-63

AV MODE

It helps you select and set images and sounds when connecting AV devices. ► p.61

Installing Batteries

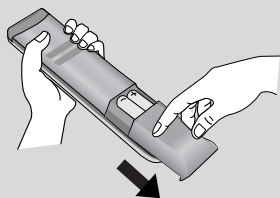

- Open the battery compartment cover on the back side and install the batteries matching correct polarity (+with +,-with -).
- Install two 1.5V AAA batteries. Don't mix old or used batteries with new ones.
- Close cover.

WATCHING TV / CHANNEL CONTROL

TURNING ON TV

- 1** First, connect power cord correctly.
At this moment, the TV switches to standby mode.
 - In standby mode to turn TV on, press the $\phi/|$, **INPUT**, **CH** (^ or v) button on the TV or press the **POWER**, **INPUT**, **CH**(^ or v), **Number** (0~9) button on the remote control.
 - 2** Select the viewing source by using the **INPUT** button on the remote control.
 - This TV is programmed to remember which power state it was last set to, even if the power cord is out.
 - 3** When finished using the TV, press the **POWER** button on the remote control. The TV reverts to standby mode.
-

! NOTE

- ▶ If you intend to be away on vacation, disconnect the power plug from the wall power outlet.

CHANNEL SELECTION

- 1** Press the **CH** (^ or v) or **NUMBER** buttons to select a channel number.
-

VOLUME ADJUSTMENT

Adjust the volume to suit your personal preference.

- 1** Press the **VOL** (+ or -) button to adjust the volume.
 - 2** If you want to switch the sound off, press the **MUTE** button.
 - 3** You can cancel the Mute function by pressing the **MUTE** or **VOL** (+ or -) button.
-

QUICK MENU

Your TV's OSD (On Screen Display) may differ slightly from what is shown in this manual.

Q.Menu (Quick Menu) is a menu of features which users might use frequently.

- **Aspect Ratio:** Selects your desired picture format.
- **Power Saving** (Plasma TV Only): Adjusts screen brightness to reduce the power consumption of the TV.
- **Backlight** (LCD TV Only): Adjust the brightness of LCD panel to control the brightness of the screen.
- **Clear Voice:** By differentiating the human sound range from others, it helps make human voices sound better.
- **Picture Mode:** Selects the factory preset picture depend on the viewing environment.
- **Sound Mode:** Selects the factory preset sound for type of program.
- **Caption:** Select on or off.
- **Multi Audio:** Changes the audio language (Digital signal).
SAP: Selects MTS sound (Analog signal).
- **Sleep Timer:** Select the amount of time before your TV turns off automatically.
- **Del/Add/Fav:** Select channel you want to add/delete or add the channel to the Favorite List.
- **USB Eject:** Select "USB Eject" in order to eject USB device.

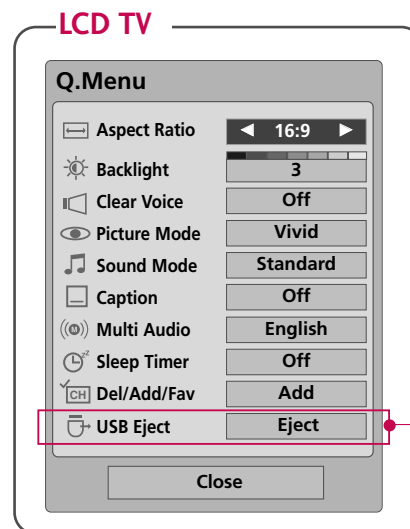

Except 32/37/42LG30

1   Display each menu.

2  Make appropriate adjustments.

3  Return to TV viewing.

WATCHING TV / CHANNEL CONTROL

INITIAL SETTING - LCD TV Only

This Function guides the user to easily set the essential items for viewing the TV for the first time when purchasing the TV. It will be displayed on the screen when turning the TV on for the first time. It can also be activated from the user menus.

- **In-Store Mode:** Picture mode is set to “Vivid”. Customers can adjust the “Picture Mode” manually while inspecting the TV, but the TV will automatically return to **Vivid** preset after 5 minutes.
- **Home Mode:** Picture mode is set to “Vivid” and user can change it to whatever they wish.



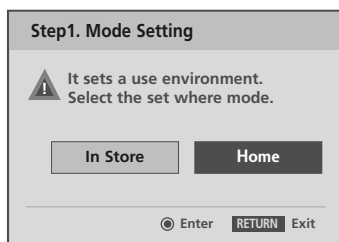

Step1. Mode setting



- 1  Select **Home Mode**.
- 2 

Step2. Time setting



- 1  Select **Auto** or **Manual**.
- 2   Select desired time option.
- 3 

Step3. Option setting

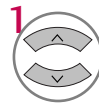
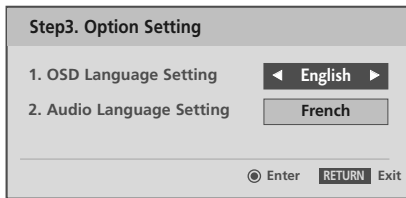

1 Select **OSD Language Setting** or **Audio Language Setting**.

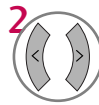

2 Select your desired language.



Step4. Auto Tuning

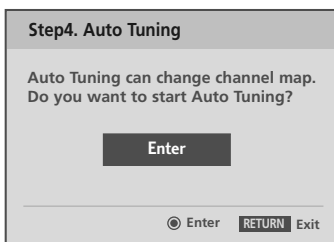

1 Start **Auto Tuning**.

! NOTE

- You can also adjust **Initial Setting** in the **OPTION** menu.

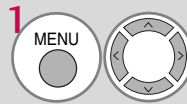
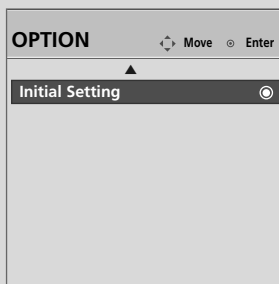

1 Select **OPTION**.

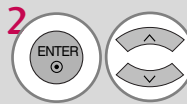

2 Select **Initial Setting**.



WATCHING TV /CHANNEL CONTROL

ON-SCREEN MENUS SELECTION

Your TV's OSD (On Screen Display) may differ slightly from that shown in this manual.

All models (Except 32/37/42LG30)

WATCHING TV / CHANNEL CONTROL

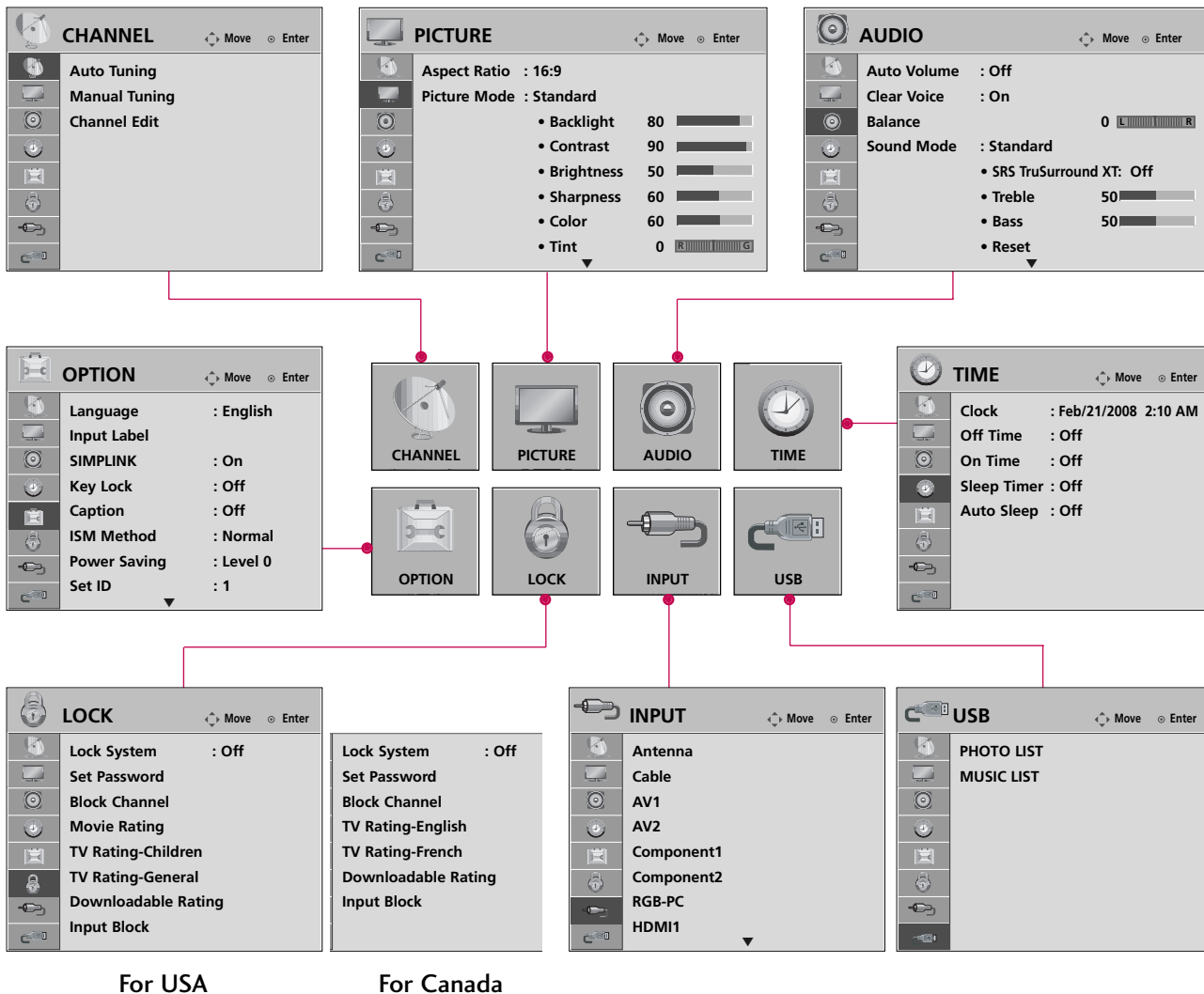





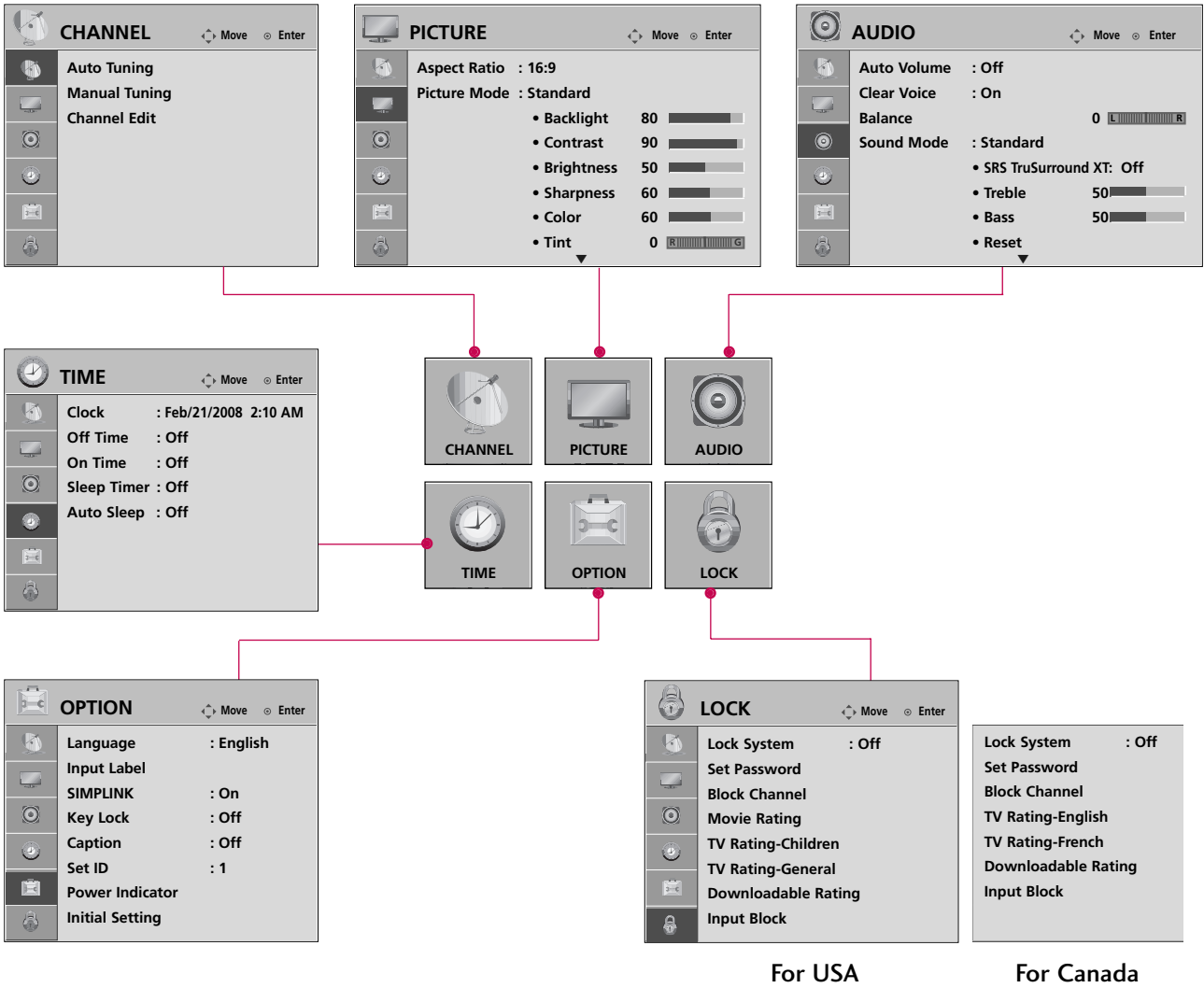

- 1 Display each menu.
- 2 Select a menu item.
- 3 Enter to the pop up menu.
- 4 Return to TV viewing.

! NOTE

- ▶ ISM Method, Power Saving: Only Plasma TV.
- ▶ Backlight, Power Indicator, TruMotion Demo: Only LCD TV. (But, TruMotion Demo: Only for 32/37/42/47/52LG60, 32/42/47/52LG70)

Only for 32/37/42LG30



- 1   Display each menu.
- 2   Select a menu item.
- 3  Enter to the pop up menu.
- 4  Return to TV viewing.