



LG OLED TV

THE ULTIMATE DISPLAY

OWNER'S MANUAL

Please read this manual carefully before operating your set and retain it for future reference.

55EA9800

www.lge.co.kr

P/NO : MFL67652661 (1305-REV00)

IMPORTANT SAFETY INSTRUCTIONS

Always comply with the following precautions to avoid dangerous situations and ensure peak performance of your product.





WARNING/CAUTION

RISK OF ELECTRIC SHOCK
DO NOT OPEN



TO REDUCE THE RISK OF ELECTRIC SHOCK DO NOT REMOVE COVER (OR BACK). NO USER SERVICEABLE PARTS INSIDE. REFER TO QUALIFIED SERVICE PERSONNEL.

 The lightning flash with arrowhead symbol, within an equilateral triangle, is intended to alert the user to the presence of uninsulated "dangerous voltage" within the product's enclosure that may be of sufficient magnitude to constitute a risk of electric shock to persons.

 The exclamation point within an equilateral triangle is intended to alert the user to the presence of important operating and maintenance (servicing) instructions in the literature accompanying the appliance.

WARNING/CAUTION
- TO REDUCE THE RISK OF FIRE AND ELECTRIC SHOCK, DO NOT EXPOSE THIS PRODUCT TO RAIN OR MOISTURE.

 **WARNING**

If you ignore the warning message, you may be seriously injured or there is a possibility of accident or death.

 **CAUTION**

If you ignore the caution message, you may be slightly injured or the product may be damaged.

 **NOTE**

The note helps you understand and use the product safely. Please read the note carefully before using the product.

Read these instructions.
Keep these instructions.
Heed all warnings.
Follow all instructions.



- Do not use this apparatus near water.



- Clean only with a dry cloth.



- Do not block any ventilation openings. Install in accordance with the manufacturer's instructions.



- Do not install near any heat sources such as radiators, heat registers, stoves, or other apparatus (including amplifiers) that produce heat.



- Do not defeat the safety purpose of the polarized or grounding-type plug. A polarized plug has two blades with one wider than the other. A grounding type plug has two blades and a third grounding prong. The wide blade or the third prong are provided for your safety. If the provided plug does not fit into your outlet, consult an electrician for replacement of the obsolete outlet (Can differ by country).



- Do not press strongly upon the panel with a hand or a sharp object such as a nail, pencil or pen, or make a scratch on it.



ENGLISH

WARNING: This product contains chemicals known to the State of California to cause cancer and birth defects or other reproductive harm.
Wash hands after handling.

- Protect the power cord from being walked on or pinched particularly at plugs, convenience receptacles, and the point where they exit from the apparatus.



- Only use attachments/accessories specified by the manufacturer.



- Use only with a cart, stand, tripod, bracket, or table specified by the manufacturer, or sold with the apparatus. When a cart is used, use caution when moving the cart/apparatus combination to avoid injury from tip-over.



- Unplug this apparatus during lightning storms or when unused for long periods of time.

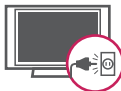

- Refer all servicing to qualified service personnel. Servicing is required when the apparatus has been damaged in any way, such as power-supply cord or plug is damaged, liquid has been spilled or objects have fallen into the apparatus, the apparatus has been exposed to rain or moisture, does not operate normally, or has been dropped.



- Do not stick metal objects or any other conductive material into the power cord. Do not touch the end of the power cord while it is plugged in.
- Keep the packing anti-moisture material or vinyl packing out of the reach of children. Anti-moisture material is harmful if swallowed. If swallowed by mistake, force the patient to vomit and visit the nearest hospital. Additionally, vinyl packing can cause suffocation. Keep it out of the reach of children.

- CAUTION concerning the Power Cord (Can differ by country):

It is recommended that appliances be placed upon a dedicated circuit; that is, a single outlet circuit which powers only that appliance and has no additional outlets or branch circuits. Check the specification page of this owner's manual to be certain. Do not connect too many appliances to the same AC power outlet as this could result in fire or electric shock. Do not overload wall outlets. Overloaded wall outlets, loose or damaged wall outlets, extension cords, frayed power cords, or damaged or cracked wire insulation are dangerous. Any of these conditions could result in electric shock or fire. Periodically examine the cord of your appliance, and if its appearance indicates damage or deterioration, unplug it, discontinue use of the appliance, and have the cord replaced with an exact replacement part by an authorized service. Protect the power cord from physical or mechanical abuse, such as being twisted, kinked, pinched, closed in a door, or walked upon. Pay particular attention to plugs, wall outlets, and the point where the cord exits the appliance. Do not move the TV with the power cord plugged in. Do not use a damaged or loose power cord. Be sure do grasp the plug when unplugging the power cord. Do not pull on the power cord to unplug the TV.



- **Warning** - To reduce the risk of fire or electrical shock, do not expose this product to rain, moisture or other liquids. Do not touch the TV with wet hands. Do not install this product near flammable objects such as gasoline or candles, or expose the TV to direct air conditioning.



- Do not expose to dripping or splashing and do not place objects filled with liquids, such as vases, cups, etc. on or over the apparatus (e.g. on shelves above the unit).



• **Grounding**

(Except for devices which are not grounded.)

Ensure that you connect the earth ground wire to prevent possible electric shock (i.e. a TV with a three-prong grounded AC plug must be connected to a three-prong grounded AC outlet). If grounding methods are not possible, have a qualified electrician install a separate circuit breaker. Do not try to ground the unit by connecting it to telephone wires, lightening rods, or gas pipes.

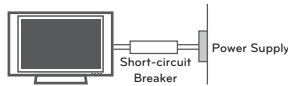

• As long as this unit is connected to the AC wall outlet, it is not disconnected from the AC power source even if the unit is turned off.

• Do not attempt to modify this product in any way without written authorization from LG Electronics. Unauthorized modification could void the user's authority to operate this product.

• **Outdoor Antenna Grounding**

(Can differ by country):

If an outdoor antenna is installed, follow the precautions below. An outdoor antenna system should not be located in the vicinity of overhead power lines or other electric light or power circuits, or where it can come in contact with such power lines or circuits as death or serious injury can occur. Be sure the antenna system is grounded so as to provide some protection against voltage surges and built-up static charges. Section 810 of the National Electrical Code (NEC) in the U.S.A. provides information with respect to proper grounding of the mast and supporting structure, grounding of the lead-in wire to an antenna discharge unit, size of grounding conductors, location of antenna discharge unit, connection to grounding electrodes and requirements for the grounding electrode.

Antenna grounding according to the National Electrical Code, ANSI/NFPA 70

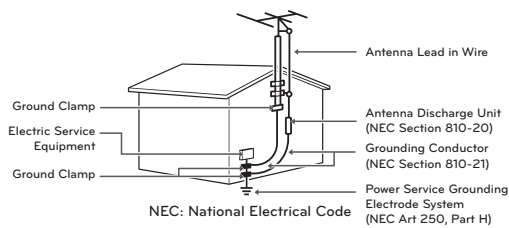

• **Cleaning**

When cleaning, unplug the power cord and wipe gently with a soft cloth to prevent scratching. Do not spray water or other liquids directly on the TV as electric shock may occur. Do not clean with chemicals such as alcohol, thinners or benzene.

• **Moving**

Make sure the product is turned off, unplugged and all cables have been removed. It may take 2 or more people to carry larger TVs. Do not press or put stress on the front panel of the TV.

• **Ventilation**

Install your TV where there is proper ventilation. Do not install in a confined space such as a bookcase. Do not cover the product with cloth or other materials while plugged. Do not install in excessively dusty places.

• If you smell smoke or other odors coming from the TV, unplug the power cord and contact an authorized service center.

• Keep the product away from direct sunlight.

• Never touch this apparatus or antenna during a thunder or lightning storm.

• When mounting a TV on the wall, make sure not to install the TV by hanging the power and signal cables on the back of the TV.

• Do not allow an impact shock or any objects to fall into the product, and do not drop anything onto the screen.

• **Disconnecting the Main Power**

The power outlet used with this device must remain easily accessible.

• Store the accessories (battery, etc.) in a safe location out of the reach of children.

• This apparatus use batteries. In your community there might be regulations that require you to dispose of these batteries properly due to environmental considerations. Please contact your local authorities for disposal or recycling information.

• Do not dispose of batteries in a fire.

• Do not short circuit, disassemble or allow the batteries to overheat.

• Dot Defect

The Plasma or LCD panel is a high technology product with resolution of two million to six million pixels. In a very few cases, you could see fine dots on the screen while you're viewing the TV. Those dots are deactivated pixels and do not affect the performance and reliability of the TV.

• Generated Sound

"Cracking" noise: A cracking noise that occurs when watching or turning off the TV is generated by plastic thermal contraction due to temperature and humidity. This noise is common for products where thermal deformation is required.

Electrical circuit humming/panel buzzing: A low level noise is generated from a high-speed switching circuit, which supplies a large amount of current to operate a product. It varies depending on the product.

This generated sound does not affect the performance and reliability of the product.

- Take care not to touch the ventilation openings. When watching the TV for a long period, the ventilation openings may become hot. This does not affect the performance of the product or cause defects in the product.
- If the TV feels cold to the touch, there may be a small "flicker" when it is turned on. This is normal, there is nothing wrong with TV. Some minute dot defects may be visible on the screen, appearing as tiny red, green, or blue spots. However, they have no adverse effect on the TV's performance. Avoid touching the LCD screen or holding your finger(s) against it for long periods of time. Doing so may produce some temporary distortion effects on the screen.

Preventing "Image burn" or "Burn-in" on your TV screen

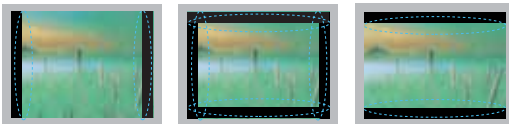

- If a fixed image displays on the TV screen for a long period of time, it will be imprinted and become a permanent disfigurement on the screen. This is "image burn" or "burn-in" and not covered by the warranty.
- If the aspect ratio of the TV is set to 4:3 for a long period of time, image burn may occur on the letterboxed area of the screen.
- Avoid displaying a fixed image on the TV screen for a long period of time (2 or more hours for LCD, 1 or more hours for the Plasma TV) to prevent image burn.

For USA and Canada

FCC NOTICE

This equipment has been tested and found to comply with the limits for a Class B digital device, pursuant to Part 15 of the FCC Rules. These limits are designed to provide reasonable protection against harmful interference in a residential installation. This equipment generates, uses and can radiate radio frequency energy and, if not installed and used in accordance with the instructions, may cause harmful interference to radio communications. However, there is no guarantee that interference will not occur in a particular installation. If this equipment does cause harmful interference to radio or television reception, which can be determined by turning the equipment off and on, the user is encouraged to try to correct the interference by one or more of the following measures:

- Reorient or relocate the receiving antenna.
- Increase the separation between the equipment and the receiver.
- Connect the equipment to an outlet on a circuit different from that to which the receiver is connected.
- Consult the dealer or an experienced radio/TV technician for help.

This device complies with part 15 of the FCC Rules. Operation is subject to the following two conditions: (1) this device may not cause harmful interference and (2) this device must accept any interference received, including interference that may cause undesired operation of the device.

Any changes or modifications in construction of this device which are not expressly approved by the party responsible for compliance could void the user's authority to operate the equipment.

NOTE TO CABLE/TV INSTALLER

This reminder is provided to call the CATV system installer's attention to Article 820-40 of the National Electric Code (U.S.A.). The code provides guidelines for proper grounding and, in particular, specifies that the cable ground shall be connected to the grounding system of the building, as close to the point of the cable entry as practical.

Viewing 3D Imaging

WARNING

Viewing Environment

- Viewing Time
 - When watching 3D contents, take 5 - 15 minute breaks every hour. Viewing 3D contents for a long period of time may cause headache, dizziness, fatigue or eye strain.

Those that have a photosensitive seizure or chronic illness

- Some users may experience a seizure or other abnormal symptoms when they are exposed to a flashing light or particular pattern from 3D contents.
- Do not watch 3D videos if you feel nausea, are pregnant and/ or have a chronic illness such as epilepsy, cardiac disorder, or blood pressure disease, etc.
- 3D Contents are not recommended to those who suffer from stereo blindness or stereo anomaly. Double images or discomfort in viewing may be experienced.
- If you have strabismus (cross-eyed), amblyopia (weak eyesight) or astigmatism, you may have trouble sensing depth and easily feel fatigue due to double images. It is advised to take frequent breaks than the average adult.
- If your eyesight varies between your right and left eye, revise your eyesight prior to watching 3D contents.

Symptoms which require discontinuation or refraining from watching 3D contents

- Do not watch 3D contents when you feel fatigue from lack of sleep, overwork or drinking.
- When these symptoms are experienced, stop using/ watching 3D contents and get enough rest until the symptom subsides.
 - Consult your doctor when the symptoms persist. Symptoms may include headache, eyeball pain, dizziness, nausea, palpitation, blurriness, discomfort, double image, visual inconvenience or fatigue.

CAUTION

Viewing Environment

- Viewing Distance
 - Maintain a distance of at least twice the screen diagonal length when watching 3D contents. If you feel discomfort in viewing 3D contents, move further away from the TV.

Viewing Age

- Infants / Children
 - Usage/ Viewing 3D contents for children under the age of 5 are prohibited.
 - Children under the age of 10 may overreact and become overly excited because their vision is in development (for example: trying to touch the screen or trying to jump into it. Special monitoring and extra attention is required for children watching 3D contents.
 - Children have greater binocular disparity of 3D presentations than adults because the distance between the eyes is shorter than one of adults. Therefore they will perceive more stereoscopic depth compared to adults for the same 3D image.
- Teenagers
 - Teenagers under the age of 19 may be stimulated to light coming from 3D videos. Advise them not to watch 3D videos for a long time when they are tired.
- Elderly
 - The elderly may perceive less of a 3D effect than the youth. Do not sit closer to the TV than the recommended distance.

Cautions when using the 3D glasses

- Make sure to use LG 3D glasses. Otherwise, you may not be able to view 3D videos properly.
- Do not use 3D glasses instead of your normal glasses, sunglasses or protective goggles.
- Using modified 3D glasses may cause eye strain or image distortion.
- Do not keep your 3D glasses in extremely high or low temperatures. It will cause deformation.
- The 3D glasses are fragile and are easy to be scratched. Always use a soft, clean piece of cloth when wiping the lenses. Do not scratch the lenses of the 3D glasses with sharp objects or clean/wipe them with chemicals.

LICENSES

Supported licenses may differ by model. For more information about licenses, visit 'www.lg.com'.



Manufactured under license from Dolby Laboratories. "Dolby" and the double-D symbol are trademarks of Dolby Laboratories.



The terms HDMI and HDMI High-Definition Multimedia Interface, and the HDMI logo are trademarks or registered trademarks of HDMI Licensing LLC in the United States and other countries.



ABOUT DIVX VIDEO: DivX[®] is a digital video format created by DivX, LLC, a subsidiary of Rovi Corporation. This is an official DivX Certified[®] device that plays DivX video. Visit divx.com for more information and software tools to convert your files into DivX video.

ABOUT DIVX VIDEO-ON-DEMAND: This DivX Certified[®] device must be registered in order to play purchased DivX Video-on-Demand (VOD) movies. To obtain your registration code, locate the DivX VOD section in your device setup menu. Go to vod.divx.com for more information on how to complete your registration.

"DivX Certified[®] to play DivX[®] video up to HD 1080p, including premium content."

"DivX[®], DivX Certified[®] and associated logos are trademarks of Rovi Corporation or its subsidiaries and are used under license."

"Covered by one or more of the following U.S. patents:
7,295,673; 7,460,668; 7,515,710; 7,519,274"



Manufactured under license under U.S. Patent Nos: 5,956,674; 5,974,380; 6,487,535 & other U.S. and worldwide patents issued & pending. DTS, the Symbol & DTS and the Symbol together are registered trademarks & DTS 2.0+Digital Out is a trademark of DTS, Inc. Product includes software. © DTS, Inc. All Rights Reserved.

OPEN SOURCE SOFTWARE NOTICE

To obtain the source code under GPL, LGPL, MPL and other open source licenses, that is contained in this product, please visit 'http://opensource.lge.com'.

In addition to the source code, all referred license terms, warranty disclaimers and copyright notices are available for download.

LG Electronics will also provide open source code to you on CD-ROM for a charge covering the cost of performing such distribution (such as the cost of media, shipping and handling) upon email request to 'opensource@lge.com'. This offer is valid for three (3) years from the date on which you purchased the product.

TABLE OF CONTENTS

2 IMPORTANT SAFETY INSTRUCTIONS

6 Viewing 3D Imaging

7 LICENSES

7 OPEN SOURCE SOFTWARE NOTICE

8 TABLE OF CONTENTS

9 INSTALLATION PROCEDURE

9 ASSEMBLING AND PREPARING

9 Unpacking

11 Optional Extras

12 Parts and Buttons

13 Lifting and moving the TV

14 Setting up the TV

14 - Mounting on a table

15 - Tidying cables

16 Using Video Call Camera

17 - Preparing Video Call Camera

19 MAKING CONNECTIONS

19 Connecting to an antenna or cable

20 Connecting to a HD receiver, DVD Player or VCR

20 - HDMI Connection

21 - DVI to HDMI Connection

22 - Connecting to a mobile phone

23 - Component Connection

24 - Composite Connection

25 Connecting a PC

25 - HDMI Connection or DVI to HDMI Connection

27 Connecting to an Audio System

27 - Digital Optical Audio Connection

28 Connecting Headphones

28 Connecting a USB Device

29 MAGIC REMOTE CONTROL FUNCTIONS

30 Registering Magic Remote Control

30 How to use Magic Remote Control

30 Precautions to Take when Using the Magic Remote Control

31 REMOTE CONTROL

33 WATCHING TV

33 Turning the TV on for the first time

34 USING THE USER GUIDE

35 SPECIFICATIONS

38 EXTERNAL CONTROL DEVICE SETUP

39 MAINTENANCE

39 Cleaning Your TV

39 - Screen, frame, cabinet and stand

39 - Power cord

39 TROUBLESHOOTING

NOTE

- Image shown may differ from your TV.
- Your TV's OSD (On Screen Display) may differ slightly from that shown in this manual.
- The available menus and options may differ from the input source or product model that you are using.
- New features may be added to this TV in the future.

INSTALLATION PROCEDURE

- 1 Open the package and make sure all the accessories are included.
- 2 Attach the stand to the TV set.
- 3 Connect an external device to the TV set.
- 4 Make sure the network connection is available.
You can use the TV network functions only when the network connection is made.

ASSEMBLING AND PREPARING

Unpacking

Check your product box for the following items. If there are any missing accessories, contact the local dealer where you purchased your product. The illustrations in this manual may differ from the actual product and item.

CAUTION

- Do not use any unapproved items to ensure the safety and product life span.
- Any damages or injuries by using unapproved items are not covered by the warranty.
- Some models appear to have a thin film on the screen. It is actually part of the screen, do not remove it.

NOTE

- The items supplied with your product may vary depending on the model.
- Product specifications or contents of this manual may be changed without prior notice due to upgrade of product functions.
- For an optimal connection, HDMI cables and USB devices should have bezels less than 10 mm (0.39 inches) thick and 18 mm (0.7 inches) width.
- Use an extension cable that supports USB 2.0 if the USB cable or USB memory stick does not fit into your TV's USB port.

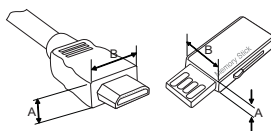

*A ≤ 10 mm (0.39 inches)

*B ≤ 18 mm (0.7 inches)

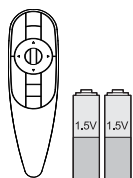

Magic Remote Control, Batteries (AA)
(See p.29)

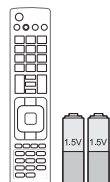

Remote Control, Batteries (AAA)
(See p.31)

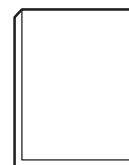

Owner's Manual



Cable Management
(See p.15)

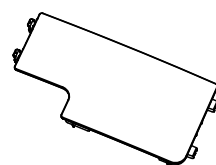

AV cover
(See p.15)

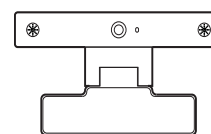

AN-VC5**
Video call camera
(See p.16)



Cinema 3D Glasses
The number of 3D glasses may differ depending on the model or country.



Dual Play glasses
The number of Dual play glasses may differ depending on the model or country.
(Depending on model)



Band Expendable
(See p.15)



Cable Management Screw
(See p.15)

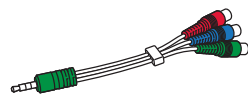

Component Video Cable
(See p.23)

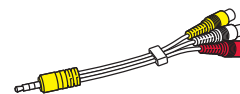

Composite Video Cable
(See p.23, 24)



Tag on



Polishing cloth
Use this to remove dust from the cabinet.



Velcro Band

Optional Extras

Optional extras can be changed or modified for quality improvement without any notification. Contact your dealer for buying these items. These devices only work with certain models. The model name or design may be changed manufacturer's circumstances or policies.

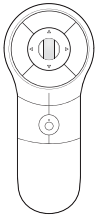

AN-MR400
Magic Remote



AG-F***
Cinema 3D Glasses



AG-F*DP**
Dual Play Glasses

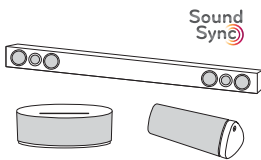

LG Audio device



Tag On

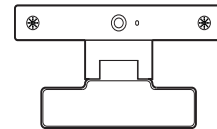

AN-VC5**
Video Call Camera

Parts and Buttons

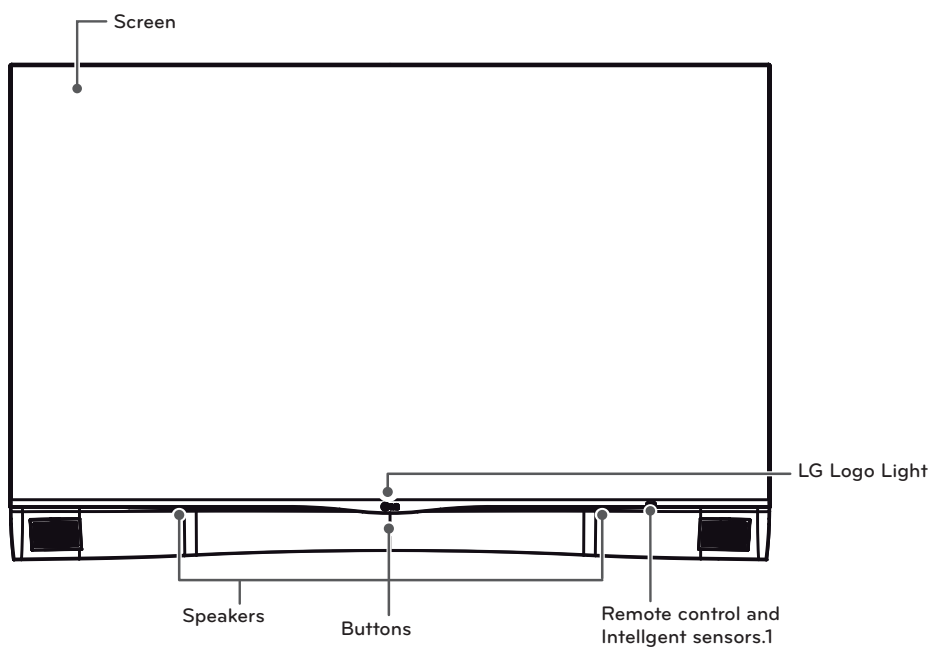

ENGLISH

Button	Description
⏻/⏻	Turns the power on or off.

1. Intelligent sensor - Adjusts the image quality and brightness based on the surrounding environment.

Lifting and moving the TV

When moving or lifting the TV, read the following to prevent the TV from being scratched or damaged and for safe transportation regardless of its type and size.

CAUTION

- Avoid touching the screen at all times, as this may result in damage to the screen.
- Do not place the product on the floor with its front facing down. Doing so may result in damage to the screen.

- It is recommended to move the TV in the box or packing material that the TV originally came in.
- Before moving or lifting the TV, disconnect the power cord and all cables.
- When holding the TV, the screen should face away from you to avoid damage.

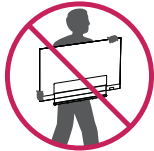

- Hold the top and bottom of the TV frame firmly. Make sure not to hold the transparent part, speaker, or speaker grill area.

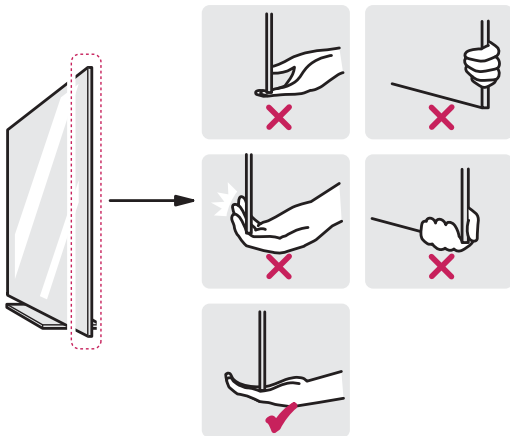

- When transporting a large TV, there should be at least 2 people.
- When transporting the TV by hand, hold the TV as shown in the following illustration.

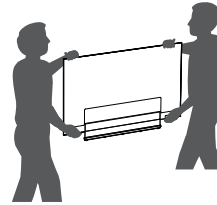

- When transporting the TV, do not expose the TV to jolts or excessive vibration.
- When transporting the TV, keep the TV upright, never turn the TV on its side or tilt towards the left or right.

Setting up the TV

Please assemble the AV cover, as shown in the figure.

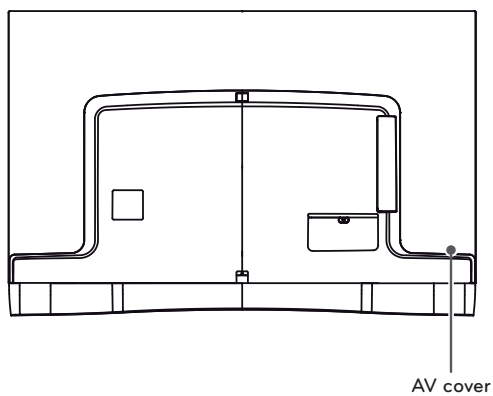

Mounting on a table

- 1 Lift and tilt the TV into its upright position on a table.
 - Leave a 10 cm (4 inch) (minimum) space from the wall for proper ventilation.

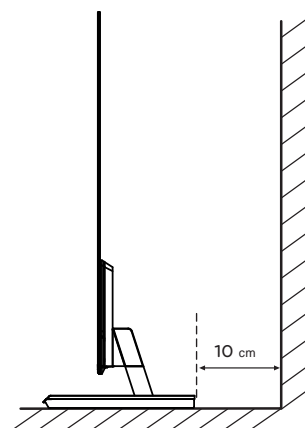
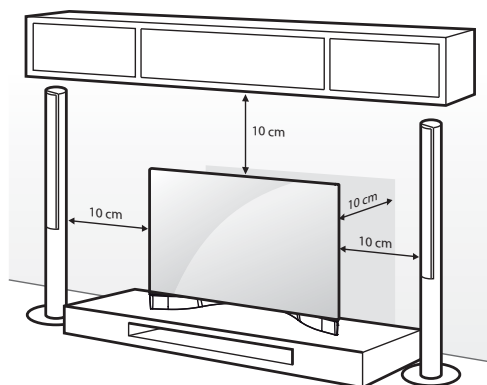

- 2 Connect the power cord to a wall outlet.



CAUTION

- Do not place the TV near or on sources of heat, as this may result in fire or other damage.

Tidying cables

- 1 Fix the Cable Management with screw and arrange the cables.

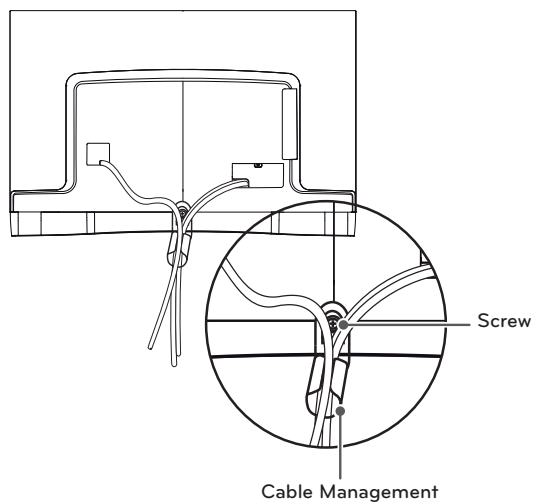

- 2 Wrap the arranged cables with the Band Expendable.

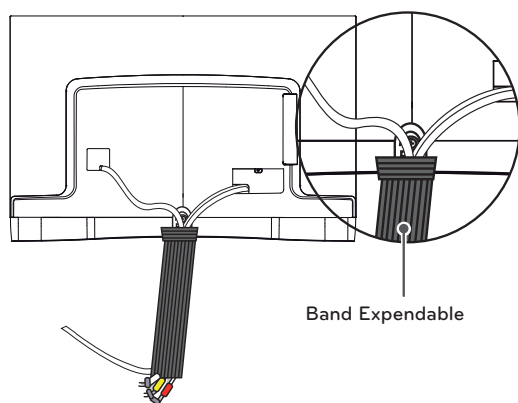

⚠ CAUTION

- Do not move the TV by holding the cable management and cable holder, as the cable holders may break, and injuries and damage to the TV may occur.

Using Video Call Camera

Front

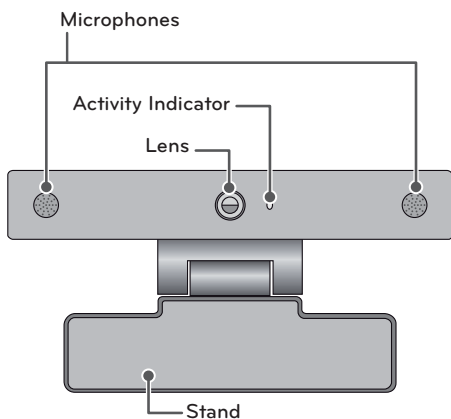

Rear

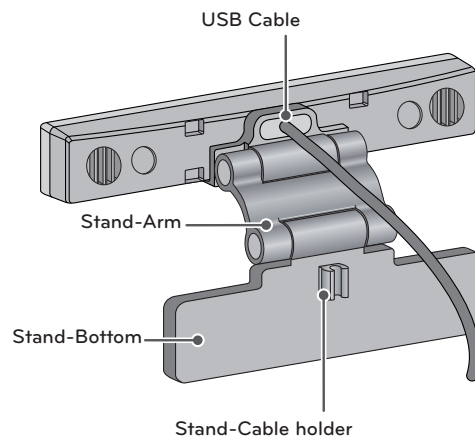

ENGLISH

Product Handling

- Do not let the camera get wet. Liquid getting into the camera could cause a short circuit.
- Wipe the camera gently with a dry cloth to remove any dust or dirt. If the product is very dirty, spray a mild detergent on the cloth first.
- Do not clean with thinner, alcohol, benzene or any other volatile agent. These may damage the product's surface or affect its operation.
- Do not disassemble, repair or alter the product. Incorrect disassembly may cause a fire, electric shock, or injury.
- Do not shake the camera.
- Do not pull on the cable.

Installation Instructions

- Make sure you have enough space for connections when installing the product.
- Do not install in a dusty, dirty or moist area.
- Do not install in direct sunlight or near a heat source.
- Magnetic objects, such as speakers, may interfere with the camera's operation.
- Install the product in a place with moderate temperature and humidity. The recommended temperature range is 0 °C (32 °F) to 40 °C (104 °F).
- Strong electromagnetic waves from other devices could interfere with the camera's operation.
- Remove all the protective plastic bags (Vinyl) before use.

The product and company names contained in this manual may or may not be registered trademarks or copyrights, and are only used for identification or explanatory purposes. All trademarks reserved.



No emergency calls with Skype

Skype is not a telephony replacement service, and cannot be used for emergency service dialing.

Preparing Video Call Camera

- 1 Unfold the stand and put it on the top center of the TV set.

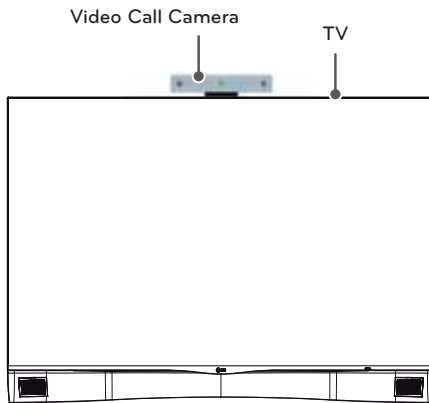

- 4 Insert the video call camera's cable into the cable holder. Please open the USB Camera Cover for video call camera's cable connection. The camera shall be connected to the CAM terminal as shown in the figure.

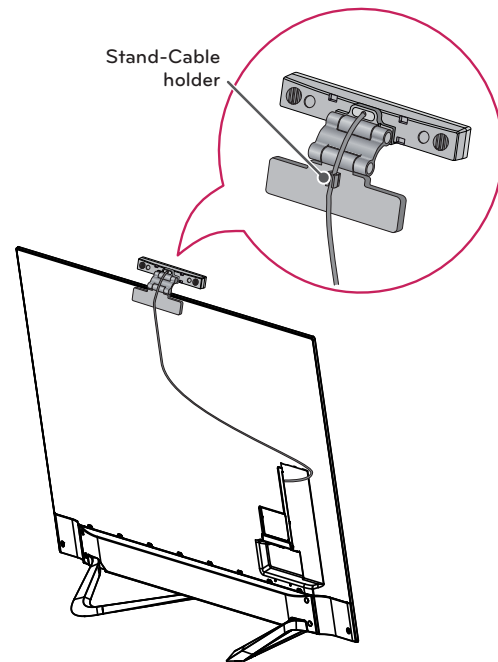

- 2 Bend the stand of the video call camera.

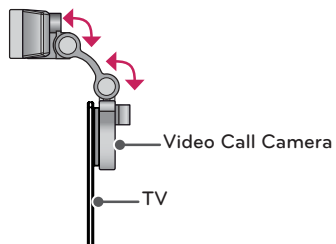

- 3 Firmly attach the TV stand to the back of the TV set using the velcro tape.

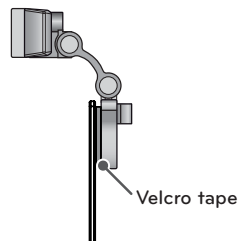

! NOTE

- For the best quality video and audio outputs, install the camera on the top-center of your TV.
- Set up with the television switched off.
- When using external speakers, allow sufficient space between the microphones and the speakers.
- The TV must be connected to a network for Skype to work.

! NOTE

- For best results when using an external speakers on your TV, only use the front right/left (stereo) speakers when using Skype.
- When making a video call with Skype using a PC, the Skype software version for Windows should be 4.2 or newer. (Visit the Skype homepage (www.skype.com) for operating systems other than Windows, e.g. OS X, Linux, etc.)
- Video calls can not be made to a Mac that runs Skype 2.8 or lower.
- Content can be changed or deleted depending on Content Provider.
- Please visit the content providers web site for specific information on their services.
- The software update screen will automatically appear when an update is available.
- For some models, you cannot use input devices such as a keyboard and mouse while using Skype (premium content).

MAKING CONNECTIONS

You can connect various external devices to the TV. Supported external devices are: HD receivers, DVD players, VCRs, audio systems, USB storage devices, PC, gaming devices, and other external devices. For more information on external device's connection, refer to the manual provided with each device.

NOTE

- If you record a TV program on a DVD recorder or VCR, make sure to connect the TV signal input cable to the TV through a DVD recorder or VCR. For more information of recording, refer to the manual provided with the connected device.
- The external device connections shown may differ slightly from illustrations in this manual.
- Connect external devices to the TV regardless of the order of the TV port.
- If you connect a gaming device to the TV, use the cable supplied with the gaming device.
- Refer to the external equipment's manual for operating instructions.

Connecting to an antenna or cable

Connect an antenna, cable, or cable box to watch TV while referring to the following. The illustrations may differ from the actual items and a RF cable is optional.

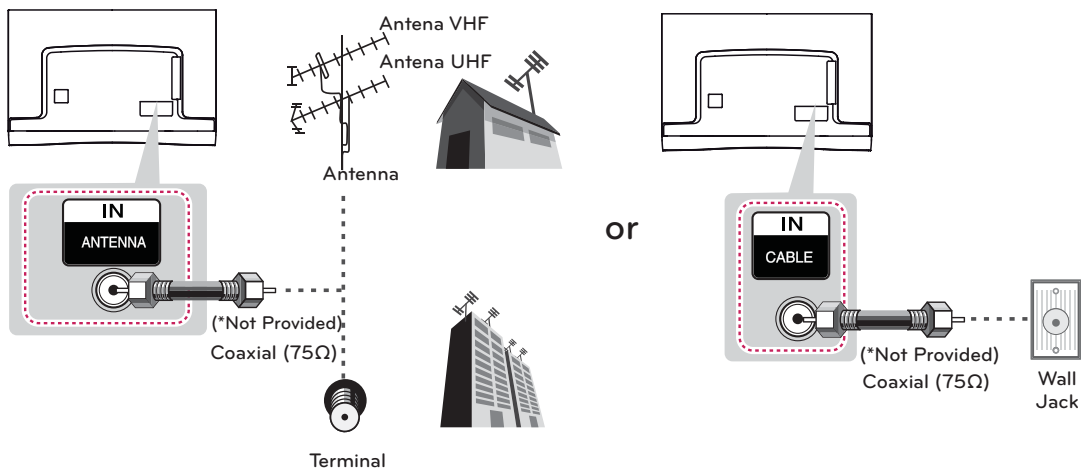

ENGLISH

CAUTION

- Make sure not to bend the copper wire of the RF cable.

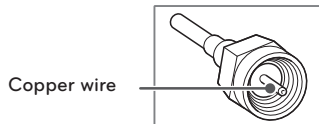

- Complete all connections between devices, and then connect the power cord to the power outlet to prevent damage to your TV.

NOTE

- Use a signal splitter to use more than 2 TVs.
- Visit <http://lgknowledgebase.com> for more information about the antenna and cable connection. Search for antenna.
- DTV Audio Supported Codec: MPEG, Dolby Digital.

Connecting to a HD receiver, DVD Player or VCR

Connect a HD receiver, DVD Player, or VCR to the TV and select an appropriate input mode.

HDMI Connection

HDMI is the best way to connect a device.

Transmits digital video and audio signals from an external device to the TV. Connect the external device and the TV with the HDMI cable as shown in the following illustration.

NOTE

- Use the latest High Speed HDMI™ Cable that supports CEC (Customer Electronics Control) function.
- High Speed HDMI™ Cables are tested to carry an HD signal up to 1080p and higher.
- HDMI Audio Supported Format: PCM (Up to 192 kHz, 32 kHz / 44.1 kHz / 48 kHz / 88 kHz / 96 kHz / 176 kHz / 192 kHz)

Choose any HDMI input port to connect.
It does not matter which port you use.

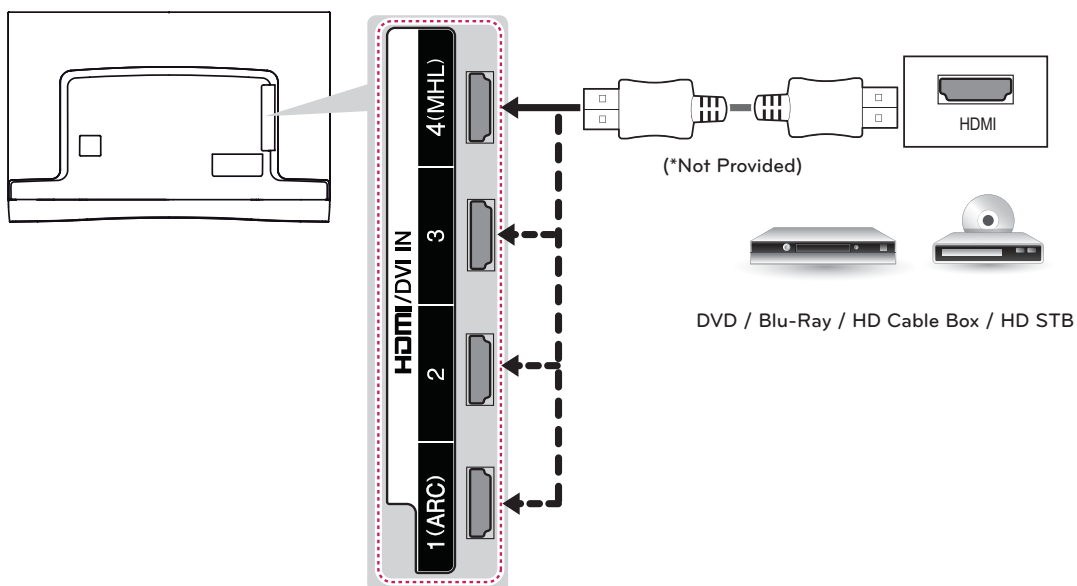

ENGLISH

ARC (Audio Return Channel)

- When connected with a high-speed HDMI cable, digital audio can be sent to a compactible device without an additional optical audio cable.
- ARC is only supported on the HDMI input 1 (ARC) port. An external audio device that supports ARC should be connected to HDMI 1 if you wish to use ARC.

DVI to HDMI Connection

Transmits the digital video signal from an external device to the TV. Connect the external device and the TV with the DVI-HDMI cable as shown in the following illustration. To transmit an audio signal, connect an audio cable.

NOTE

- When using the HDMI/DVI cable, Single link is only supported.

Choose any HDMI input port to connect.
It does not matter which port you use.

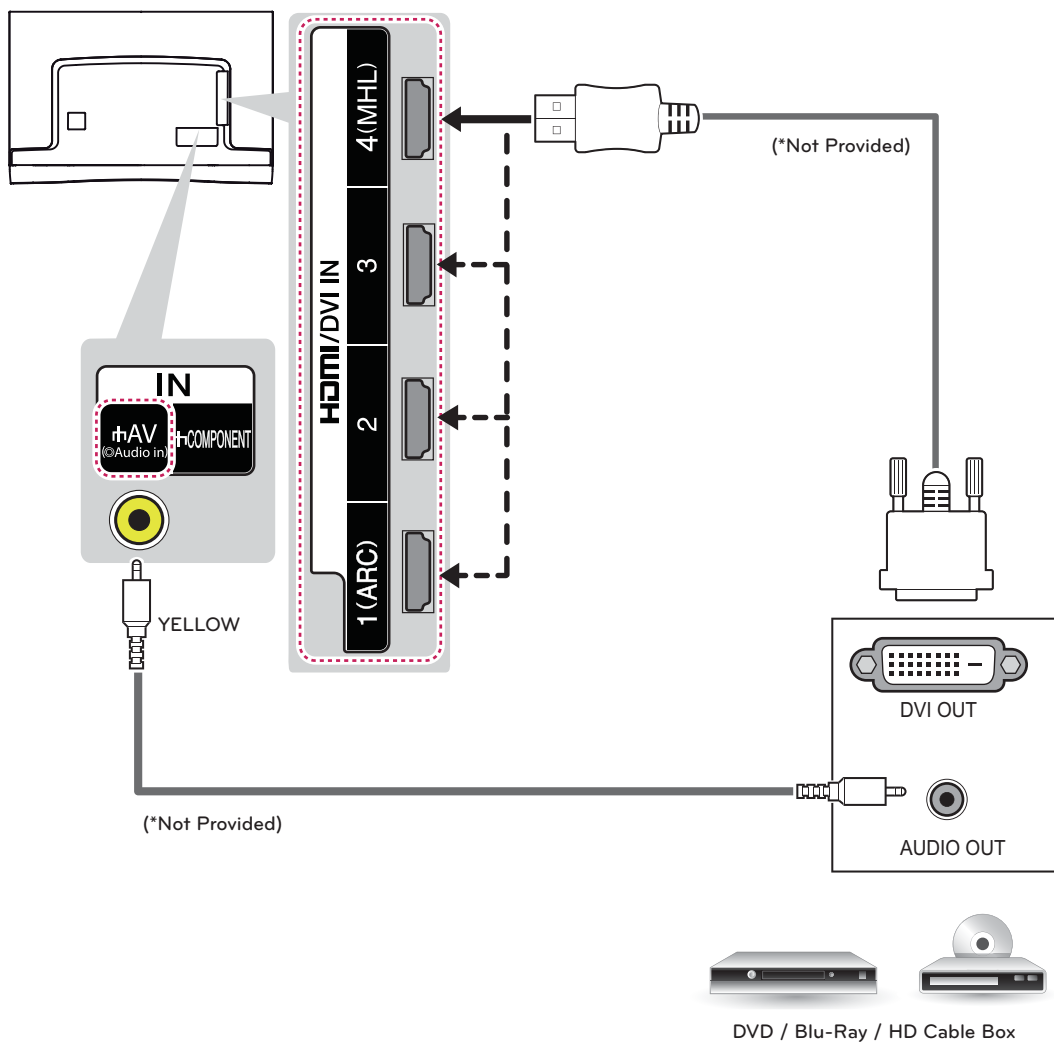

Connecting to a mobile phone

Mobile High-definition Link (MHL) is an interface for transmitting digital audio/visual signals from mobile phones to television sets.

! NOTE

- Connect the mobile phone to the HDMI IN 4 (MHL) port to view the phone screen on the TV.
- This only works with an MHL-enabled phone.
- With some MHL supporting mobile phones, you can use the TV remote to control the phone.
- An MHL passive cable is needed to connect the TV and a mobile phone.
- Remove the MHL cable from the TV when:
 - the MHL function is disabled
 - your mobile device is fully charged in standby mode

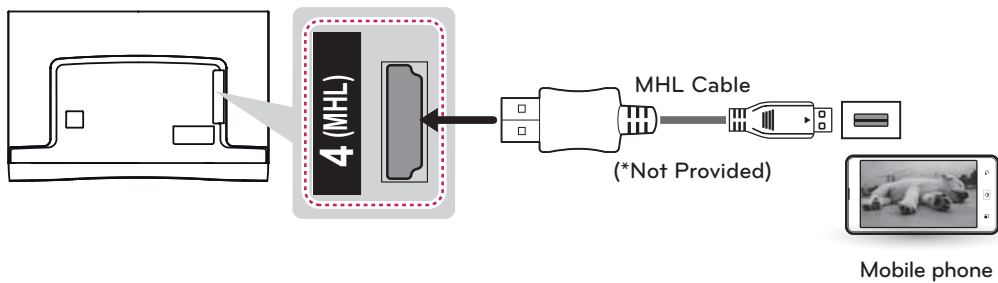

Component Connection

Transmits analog video and audio signals from an external device to the TV. Connect the external device and the TV with a component cable as shown in the following illustration.

NOTE

- If cables are installed incorrectly, it could cause the image to display in black and white or with distorted color.
- Check to ensure the cables are matched with the corresponding color connection.

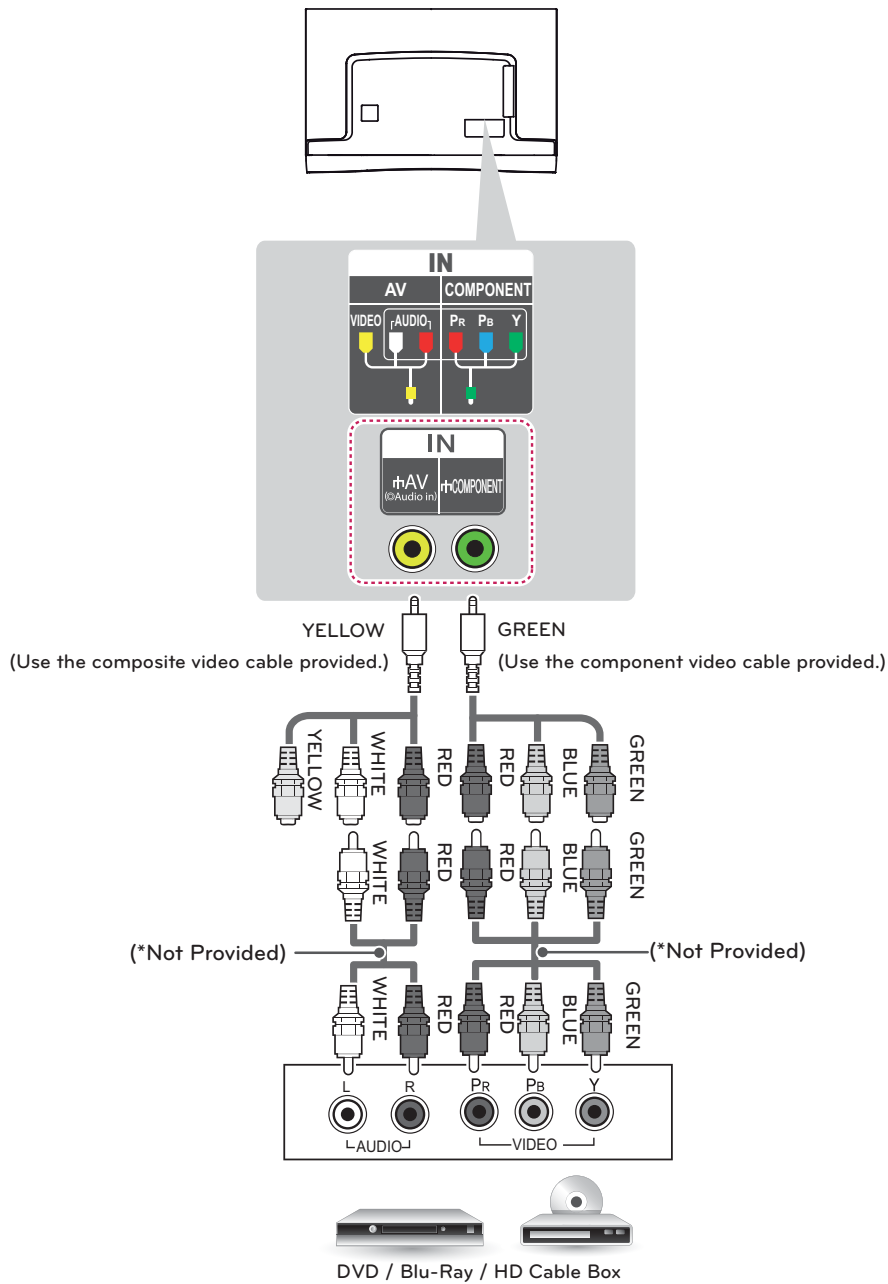

Composite Connection

Transmits analog video and audio signals from an external device to the TV. Connect the external device and the TV with the composite cable as shown in the following illustration.

NOTE

- If you have a mono VCR, connect the audio cable from the VCR to the AUDIO L/MONO jack of the TV.
- Check to ensure the cables are matched with the corresponding color connection.

ENGLISH

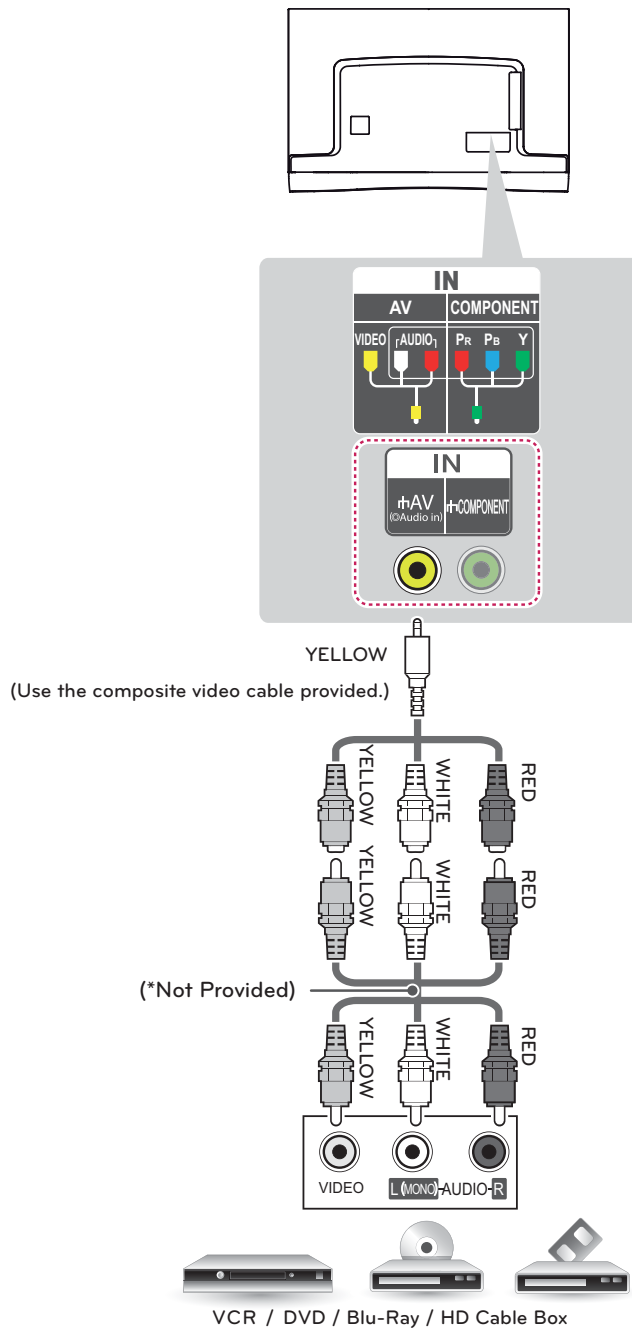

Connecting a PC

NOTE

- It is recommended to use an HDMI connection for the best image quality.
- Depending on the graphics card, DOS mode video may not work if a HDMI to DVI Cable is in use.
- In PC mode, there may be noise associated with the resolution, vertical pattern, contrast or brightness. If noise is present, change the PC output to another resolution, change the refresh rate to another rate or adjust the brightness and contrast on the PICTURE menu until the picture is clear.
- The synchronization input form for Horizontal and Vertical frequencies is separate.
- Depending on the graphics card, some resolution settings may not allow the image to be positioned on the screen properly.
- If you are using DVI out from a PC, you have to connect analog audio separately. Refer to the instructions on the next page.
- When using the HDMI/DVI cable, Single link is only supported.

HDMI Connection or DVI to HDMI Connection

Choose method A or B to make connection.

Method A: HDMI Connection

Choose any HDMI input port to connect.
It does not matter which port you use.

Method B: DVI to HDMI Connection

Choose any HDMI input port to connect.
It does not matter which port you use.

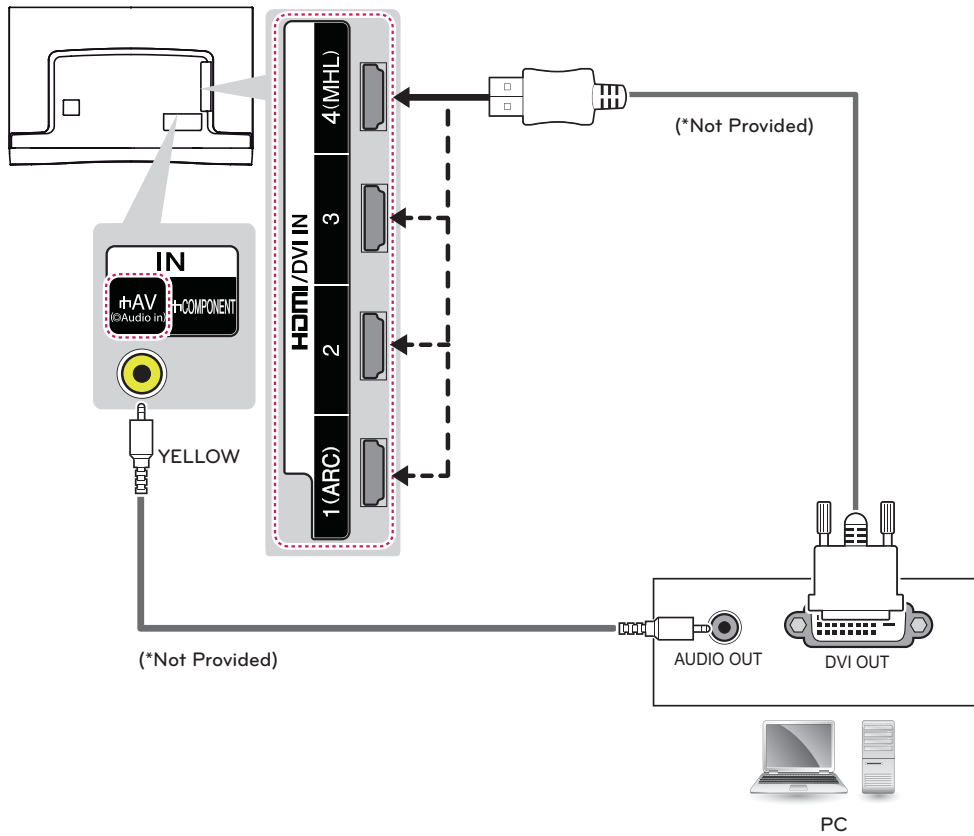

ENGLISH

Connecting to an Audio System

You can use an optional external audio system instead of the built-in speaker.

Digital Optical Audio Connection

Transmits a digital audio signal from the TV to an external device. Connect the external device and the TV with the optical audio cable as shown in the following illustration.

NOTE

- Do not look into the optical output port. Looking at the laser beam may damage your vision.
- Audio with ACP (Audio Copy Protection) function may block digital audio output.

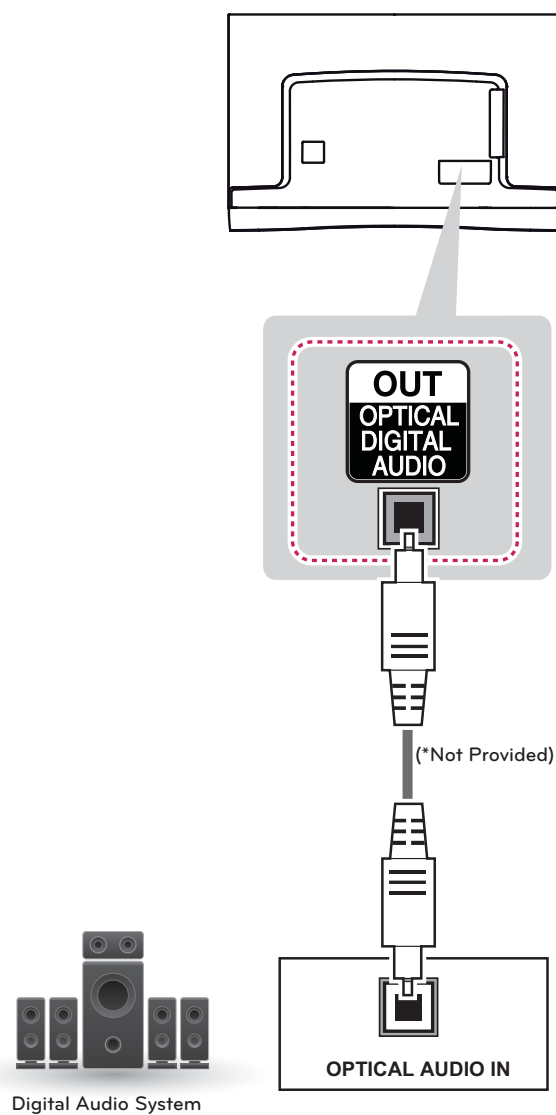

Connecting Headphones

Listening to sound with headphones



NOTE

- Do not use headsets (earphones) at high volume or for a long time. Otherwise, it may cause damage to your hearing.
- AUDIO menu options are disabled when headphones are connected.
- When changing AV MODE with a headphone connected, the change is applied to video but not to audio.
- Optical Digital Audio Out is not available when connecting a headphone.
- Headphone impedance: 16 Ω
- Max audio output: 0.624 mW to 1.04 mW
- Headphone jack size: 0.35 cm (0.13 inches)

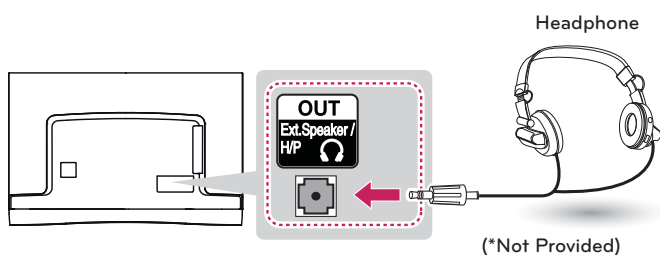

ENGLISH

Connecting a USB Device

Connect a USB storage device such as USB flash memory, external hard drive, or a USB memory card reader to the TV and access the Smart Share menu to use various multimedia files.



NOTE

- To use Time Machine function, make sure your USB drive is connected to the USB IN 1 Time Machine Ready port.
- Some USB Hubs may not work. If a USB device connected using a USB Hub is not detected, connect it to the USB port on the TV directly.

Choose any USB input port to connect.
It does not matter which port you use.

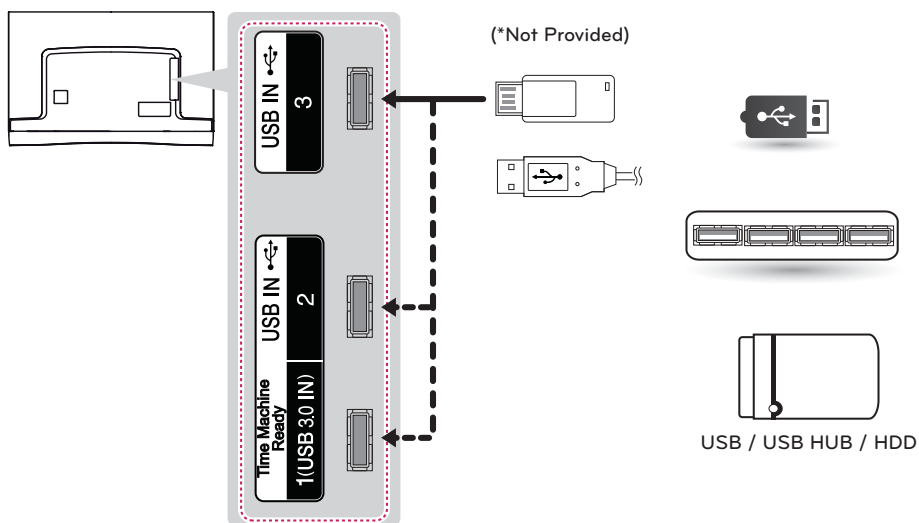

MAGIC REMOTE CONTROL FUNCTIONS

When the message "Magic remote control battery is low. Change the battery." is displayed, replace the battery. To install batteries, open the battery cover, replace batteries (1.5 V AA) matching ⊕ and ⊖ to the label inside the compartment, and close the battery cover. **Failure to match the correct polarities of the battery may cause the battery to burst or leak, resulting in fire, personal injury, or ambient pollution.** Be sure to point the remote control at the remote control sensor on the TV. To remove the batteries, perform the installation actions in reverse.

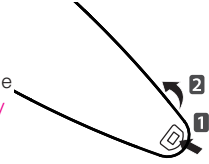

CAUTION

- Do not mix old and new batteries, as this may damage the remote control.

This remote uses infrared light. When in use, it should be pointed in the direction of the TV's remote sensor.

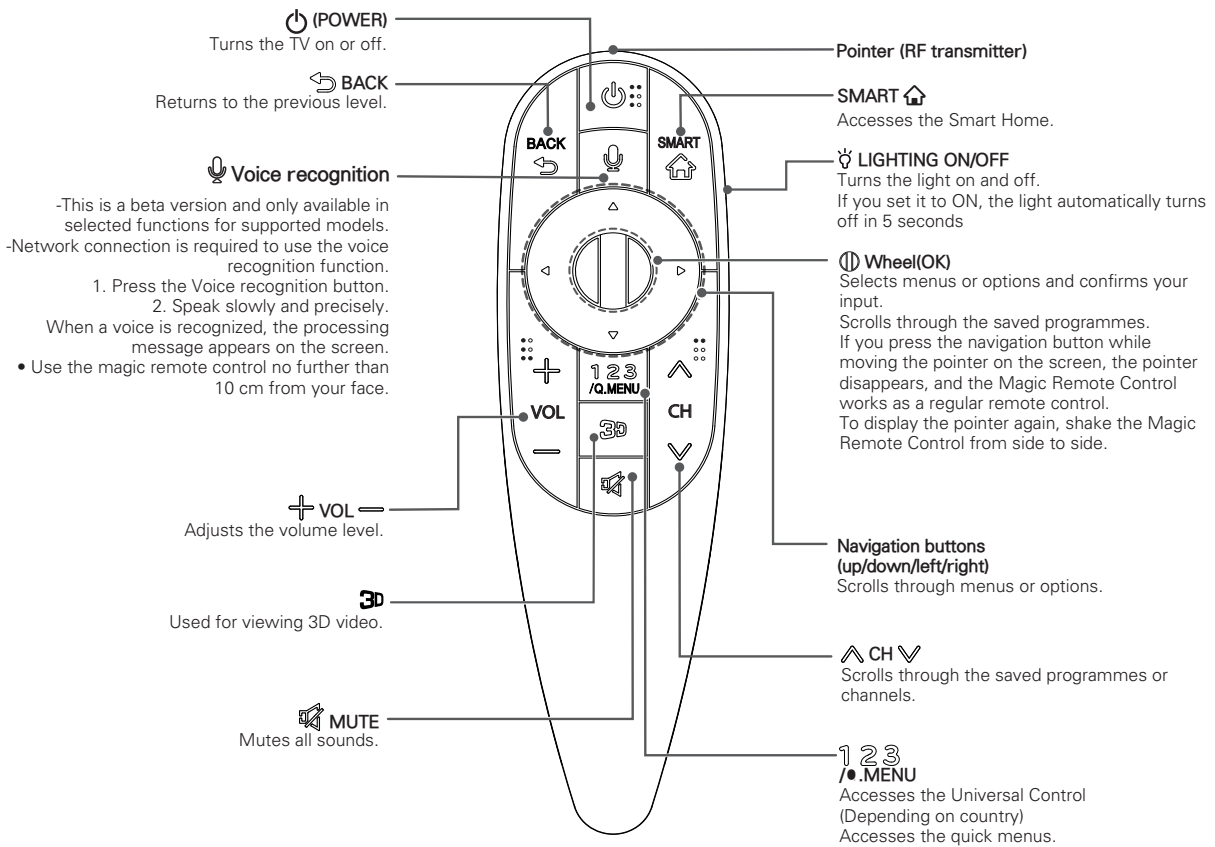

Registering Magic Remote Control

The Magic Remote Control operates by pairing with your TV. Please register the remote as follows.

How to register the Magic Remote Control

 (Wheel)	To register automatically, turn the TV on and press the Wheel (OK) . When registration is completed, the completion message appears on the screen. If registration fails, turn the TV off and back on, then press the Wheel (OK) to complete registration.
--	---

How to Re-register the Magic Remote Control

BACK 	1 Press and hold the BACK and SMART buttons together for 5 seconds to reset, then register it by following "How to register the Magic remote control" above.
SMART 	2 To re-register the Magic remote control, press and hold the BACK button for 5 seconds toward the TV.

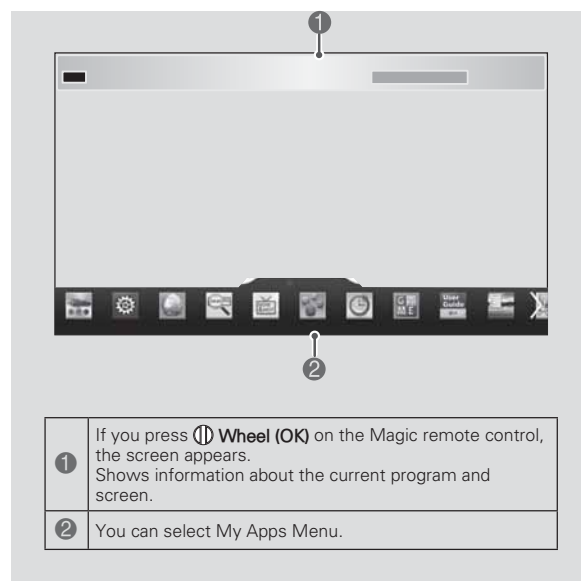

How to use Magic Remote Control

	1 You can move the pointer by aiming the Pointer Receiver of the remote control at your TV then move it left, right, up or down. » If the pointer does not work properly leave the remote control for 10 seconds then use it again.
	2 If the pointer disappears, move the remote control slightly to left or right. Then, it will automatically appear on the screen. » If the pointer has not been used for a certain period of time, it will disappear.

Precautions to Take when Using the Magic Remote Control

- Use the Magic remote control within the maximum communication distance (10 m, 32.8ft). Using the remote control beyond this distance, or with an object obstructing it, may cause a communication failure.
- A communication failure may occur due to nearby devices. Electrical devices such as a microwave oven or wireless LAN product may cause interference, as these use the same bandwidth (2.4 GHz) as the Magic remote control.
- The Magic remote control may be damaged or may malfunction if it is dropped or receives a heavy impact.
- Take care not to bump into nearby furniture or other people when using the Magic remote control.
- Manufacturer and installer cannot provide service related to human safety as the applicable wireless device has possibility of electric wave interference.
- It is recommended that an Access Point (AP) be located more than 1 m (3.28 ft) away from the TV. If the AP is installed closer than 1 m (3.28 ft), the Magic remote control may not perform as expected due to frequency interference.

REMOTE CONTROL

The descriptions in this manual are based on the buttons on the remote control. Please read this manual carefully and use the TV correctly. To replace batteries, open the battery cover, replace batteries (1.5 V AAA) matching the ⊕ and ⊖ ends to the label inside the compartment, and close the battery cover. **Failure to match the correct polarities of the battery may cause the battery to burst or leak, resulting in fire, personal injury, or ambient pollution.** To remove the batteries, perform the installation actions in reverse.

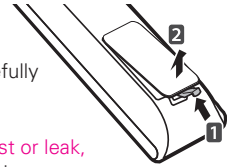

CAUTION

- Do not mix old and new batteries, as this may damage the remote control.
- In Analogue TV and some countries, some remote control buttons may not work.

This remote uses infrared light. When in use, it should be pointed in the direction of the TV's remote sensor.

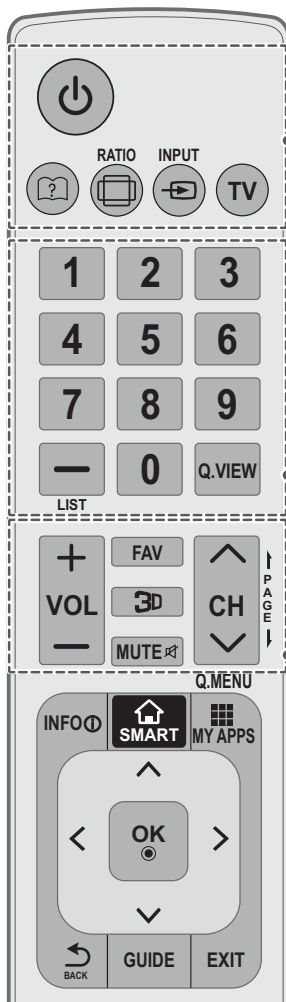

- ⏻ (POWER)**
Turns the TV on or off.
- 📖 (User Guide)**
Sees user-guide.
- 📐 RATIO**
Resizes an image.
- 📺 INPUT**
Rotates through inputs.
Also switches the TV on from standby.
- TV**
Returns to the last TV channel.

- Number button**
Enters numbers.
- LIST**
Accesses the saved channel list.
- (Dash)**
Inserts a dash between numbers such as 2-1 and 2-2.
- .VIEW**
Tunes to the last channel viewed.

- + VOL -**
Adjusts the volume level.
- FAV**
Accesses your favorite channel list.
- 3D**
Used for viewing 3D video.
- MUTE 🚫**
Mutes all sounds.
- ^ CH v**
Scrolls through the saved channels.
- ⏪ PAGE ⏩**
Moves to the previous or next screen.

ENGLISH

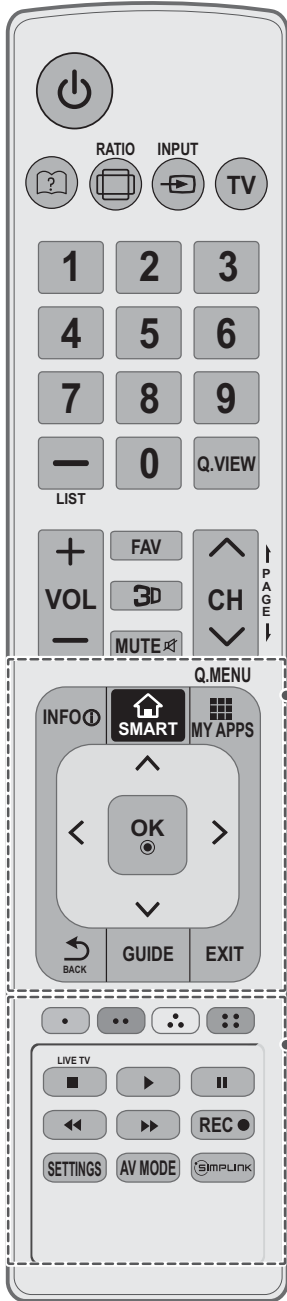

INFO ⓘ
Views the information of the current program and screen.

SMART 🏠
Accesses the Smart Home menu.

MY APPS 📺
Shows the list of Apps.

.MENU ●
Accesses the quick menu.

Navigation buttons (up/down/left/right)
Scrolls through menus or options.

OK ●
Selects menus or options and confirms your input.

BACK ↶
Returns to the previous level.

GUIDE 📅
Displays the program event according to time scheduler.

EXIT ✖
Clears all on-screen displays and returns to TV viewing.

Color buttons
These access special functions in some menus.
(●: Red, ●: Green, ●: Yellow, ●: Blue)

Control buttons (■, ▶, ⏸, ⏪, ⏩)
Controls the SIMPLINK compatible devices (USB, SIMPLINK).

LIVE TV 📺
Returns to the LIVE TV.

REC ●
Start to record and display record menu.

SETTINGS ⚙️
Accesses the main menu.

AV MODE 📺
Selects an AV mode.

SIMPLINK 🔗
Accesses the AV devices connected to the TV;
Opens the SIMPLINK menu.

WATCHING TV

Turning the TV on for the first time

When you turn the TV on for the first time, the Initial setting screen appears. Select a language and customize the basic settings.

- 1 Connect the power cord to a power outlet.
- 2 In Standby mode, press the power button on the remote control to turn the TV on.
The Initial setting screen appears if you turn the TV on for the first time.

NOTE

- You can also access **Initial Setting** by accessing **OPTION** in the main menu.

- 3 Follow the on-screen instructions to customize your TV settings according to your preferences.

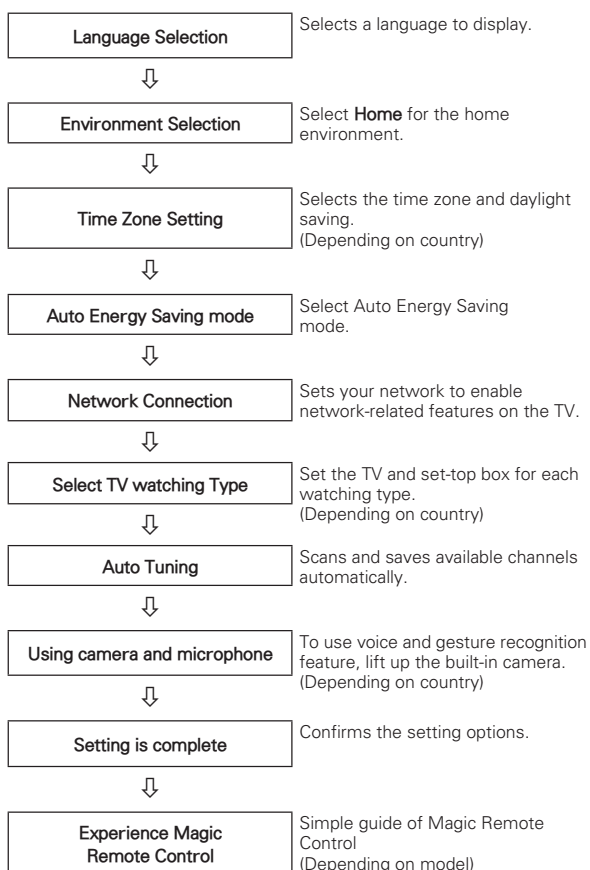

NOTE

- Select **Home** when prompted. **Store** mode puts the TV in demo mode.
- If you select **Store**, the any customized settings will switch back to the default settings of **Store** in 5 minutes.
- Power Indicator feature is disabled in Store Demo mode.

- 4 When the basic settings are complete, press the **Wheel (OK)**.



NOTE

- If you do not complete the Initial setting, it will appear whenever the TV turns on.
- Disconnect the power cord from the power outlet when you do not use the TV for a long period of time.

- 5 To turn the TV off, press the power button on the remote control.

USING THE USER GUIDE

User Guide allows you to easily access detailed TV information.

- 1 Press **SMART**  button to access the Smart Home menus.
- 2 Select **User Guide** and press the  **Wheel (OK)** button.

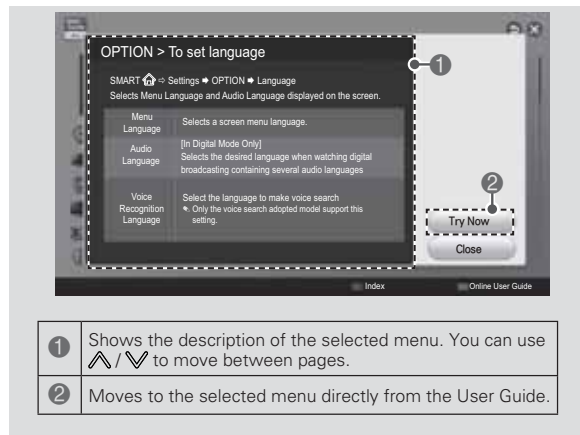

ENGLISH

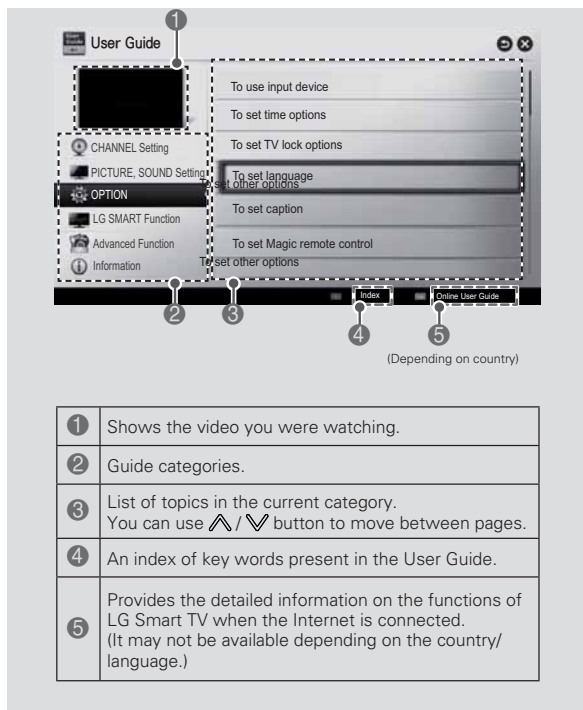

SPECIFICATIONS

Product specifications may be changed without prior notice due to upgrade of product functions.

Power requirement	AC 100 - 240 V ~ 50 / 60 Hz	
Television System	NTSC-M, ATSC, 64 & 256 QAM	
Program Coverage	VHF 2-13, UHF 14-69, CATV 1-135, DTV 2-69, CADTV 1-135	
External Antenna Impedance	75 Ω	
Environment condition	Operating Temperature	0 °C ~ 40 °C (32 °F ~ 104 °F)
	Operating Humidity	Less than 80 %
	Storage Temperature	-20 °C ~ 60 °C (-4 °F ~ 140 °F)
	Storage Humidity	Less than 85 %

MODELS		55EA9800 (55EA9800 - UA)
Dimensions (W x H x D)	With stand	1,227 x 798.5 x 192 (mm) 48.3 x 31.4 x 7.5 (inch)
	Without stand	1,227 x 714 x 4.45 (mm) 48.3 x 28.1 x 0.1 (inch)
Weight	With stand	17.2 Kg (37.92lbs)
	Without stand	10.9 Kg (24.03 lbs)
Current Value / Power consumption		TBD

HDMI (DTV) supported mode

Resolution	Horizontal Frequency (kHz)	Vertical Frequency (Hz)
720 x 480	31.469 31.50	59.94 60.00
1280 x 720	44.96 45.00	59.94 60.00
1920 x 1080	33.72 33.75 26.97 27.000 33.716 33.75 67.43 67.500	59.94 60.00 23.97 24.000 29.976 30.00 59.94 60

Component supported mode

Resolution	Horizontal Frequency (kHz)	Vertical Frequency (Hz)
720 x 480i	15.73 15.73	59.94 60.00
720 x 480p	31.47 31.50	59.94 60
1280 x 720p	44.96 45.00	59.94 60.00
1920 x 1080i	33.72 33.75	59.94 60.00
1920 x 1080p	26.97 27.00 33.71 33.75 67.432 67.500	23.976 24.00 29.97 30.00 59.94 60.00

Component port connecting information

Component ports on the TV	Y	PB	PR

Video output ports on DVD player	Y	PB	PR
	Y	B-Y	R-Y
	Y	Cb	Cr
	Y	Pb	Pr

HDMI (PC) supported mode

Resolution	Horizontal Frequency (kHz)	Vertical Frequency (Hz)
640 x 480	31.469	59.94
800 x 600	37.879	60.31
1024 x 768	48.363	60.00
1152 x 864	54.348	60.053
1360 x 768	47.712	60.015
1280 x 1024	63.981	60.020
1920 x 1080	67.5	60.00

Wireless LAN module (WN8122E1) specification

Standard	IEEE802.11a/b/g/n
Frequency Range	2400 to 2483.5 MHz 5725 to 5850 MHz
Output Power (Max.)	802.11a: 16.5 dBm 802.11b: 16 dBm 802.11g: 15.5 dBm 802.11n - 2.4GHz: 15.5 dBm 802.11n - 5GHz: 16.5 dBm

- Because band channel used by the country could be different, the user can not change or adjust the operating frequency and this product is set for the regional frequency table.
- Contains FCC ID: BEJWN8122E1
Contains IC: 2703H-WN8122E1

Bluetooth module (BM-LDS401) specification

Standard	Bluetooth Version 3.0
Frequency Range	2400 ~ 2483.5 MHz
Output Power (Max.)	10 dBm or lower

- Contains FCC ID: BEJLDS401
Contains IC: 2703H-LDS401

3D supported mode

- Video, which is input as below media contents is switched into the 3D screen automatically.

3D supported mode automatically					
Input	Signal	Horizontal Frequency (kHz)	Vertical Frequency (Hz)	Playable 3D video format	
HDMI	1080p	54.00	24	F/P, L/A	
		67.50	30		
		27.00	24	S/S, T&B, S/S Full	
		33.75	30		
		67.50	60	S/S, T&B	
	1080i	67.50	60	F/P, F/A	
		33.75		S/S, T&B, S/S Full	
	720p	90.00		F/P, L/A	
		45.00		S/S, T&B, S/S Full	
	480p	63.00		F/P, L/A	
		31.50		T/B, S/S, S/S Full	
	USB	1080p		33.75	30
DLNA					

S/S : Side by Side, S/S Full : Side by Side Full, S/S Half :Side by Side Half,

T/B : Top & Bottom, F/P : Frame Packing, F/A : Field Alternative, L/A : Line Alternative, C/B : Checker Board,

R/I : Row Interleaving, C/I: Column Interleaving, F/S : Single Frame Sequential

3D supported mode manually		
Input	Signal	Playable 3D video format
TV	-	2D to 3D, S/S, T&B
ATV(CVBS)	-	
Component	-	
HDMI-PC	1080p	2D to 3D, S/S, T&B, C/B, R/I, C/I (60Hz : F/S)
	Others	2D to 3D, S/S, T&B
HDMI-DTV	Interlace	2D to 3D, S/S, T&B
	Progressive	2D to 3D, S/S, T&B, C/B, R/I, C/I (60Hz : F/S)
USB / DLNA (Movie)	704 x 480p (Over)	2D to 3D, S/S, T&B, C/B, R/I, C/I (60Hz : F/S)
	704 x 480i (Over)	2D to 3D, S/S, T&B
	704 x 480 (Under)	2D to 3D
USB / DLNA (Photo)	320 x 240 (Over)	2D to 3D, S/S, T&B
	320 x 240 (Under)	2D to 3D
Miracast™ / WiDi	1024 x 768p	2D to 3D, S/S, T&B
	1280 x 720p	
	1920 x 1080p	
	Others	2D to 3D

EXTERNAL CONTROL DEVICE SETUP

To obtain the external control device setup information, please visit 'www.lg.com'.

MAINTENANCE

Cleaning Your TV

Clean your TV regularly to keep it at peak performance and to extend the product lifespan.

⚠ CAUTION

- Before Cleaning, turn the power off and disconnect the power cord and all other cables.
- When the TV is left unattended or unused for a long time, disconnect the power cord from the wall outlet to prevent possible damage from lightning or power surges.

Screen, frame, cabinet and stand

To remove dust or light dirt, wipe the surface with a dry, clean, and soft cloth.

To remove major dirt, wipe the surface with a soft cloth dampened in clean water or a diluted mild detergent. Then wipe immediately with a dry cloth.

⚠ CAUTION

- Do not push, rub, or hit the surface with your fingernail or a sharp object, as this may result in scratches on the screen and image distortions.
- Do not use any chemicals, such as waxes, benzene, alcohol, thinners, insecticides, air fresheners, lubricants, as these may damage the screen's finish and cause discoloration.
- Do not spray liquid onto the surface. If water enters the TV, it may result in fire, electric shock, or malfunction.

Power cord

Remove the accumulated dust or dirt on the power cord regularly.

ENGLISH

TROUBLESHOOTING

Problem	Solution
Cannot control the TV with the remote control.	<ul style="list-style-type: none"> • Check the remote control sensor on the product and try again. • Check if there is any obstacle between the product and the remote control. • Check if the batteries are still working and properly installed (⊕ to ⊕, ⊖ to ⊖).
No image display and no sound is produced.	<ul style="list-style-type: none"> • Check if the product is turned on. • Check if the power cord is connected to a wall outlet. • Check if there is a problem in the wall outlet by connecting other products.
The TV turns off suddenly.	<ul style="list-style-type: none"> • Check the power control settings. The power supply may be interrupted. • Check if the Auto sleep feature is activated in the Time settings. • If there is no signal while the TV is on, the TV will turn off automatically after 15 minutes of inactivity.

Problem	Solution
If Skype doesn't start	<ul style="list-style-type: none"> • Check whether the Video Call Camera is properly connected to the USB port on the TV. • Check the network connection status.
If the Notification Window is not displayed when a call is received	<ul style="list-style-type: none"> • Check that your status is not set as "Do not disturb". • When using certain TV functions, incoming calls can't be received (e.g. during a software update, etc.). • Check 'Privacy Settings' is "Allow calls from people in my contact list only".
If there's echo (e.g. when you hear your own voice played back through the speakers)	<ul style="list-style-type: none"> • Change the home theater audio setting to stereo rather than surround. • Reduce the speaker volume. • Too much echo in the room can decrease audio quality. • Test microphone using the 'Echo / Sound Test Service'.
If you're not able to receive any video or if it is of low quality	<ul style="list-style-type: none"> • Internet or network congestion can degrade video quality. • Using wireless can also degrade video quality. We recommend using a wired internet connection. • Screen quality can decrease when using Zoom-In. We recommend you use minimum zoom during video calls. • Check whether the call quality information is marked as "critical". If this is the case, video quality can be degraded.
If the call ends abruptly	<ul style="list-style-type: none"> • When certain TV functions are activated, the call may be disconnected. (e.g. Sleep timer, etc.) • Do not unplug the Video Call Camera during a call.
If the Skype menu does not appear on the Premium menu	<ul style="list-style-type: none"> • Connect the camera to your TV, then update the software. For details about how to update the software, refer to your TV manual.
Other issues	<ul style="list-style-type: none"> • Issues may arise from network congestion or problems with the Skype network. • For further inquiries about Skype functions, visit www.skype.com.



CHILD SAFETY:

It Makes A Difference How and Where
You Use Your Flat Panel Display

Congratulations on your purchase! As you enjoy your new product, please keep these safety tips in mind:



THE ISSUE

- The home theater entertainment experience is a growing trend and larger flat panel displays are popular purchases. However, flat panel displays are not always supported on the proper stands or installed according to the manufacturer's recommendations.
- Flat panel displays that are inappropriately situated on dressers, bookcases, shelves, desks, speakers, chests or carts may fall over and cause injury.

THIS MANUFACTURER CARES!

- The consumer electronics industry is committed to making home entertainment enjoyable and safe.

TUNE INTO SAFETY

- One size does NOT fit all. Follow the manufacturer's recommendations for the safe installation and use of your flat panel display.
- Carefully read and understand all enclosed instructions for proper use of this product.
- Don't allow children to climb on or play with furniture and television sets.
- Don't allow place flat panel displays on furniture that can easily be used as steps, such as a chest of drawers.
- Remember that children can become excited while watching a program, especially on a "larger than life" flat panel display. Care should be taken to place or install the display where it cannot be pushed, pulled over, or knocked down.
- Care should be taken to route all cords and cables connected to the flat panel display so that they cannot be pulled or grabbed by curious children.

WALL MOUNTING: IF YOU DECIDE TO WALL MOUNT YOUR FLAT PANEL DISPLAY, ALWAYS:

- Use a mount that has been recommended by the display manufacturer and/or listed by an independent laboratory (such as UL, CSA, ETL).
- Follow all instructions supplied by the display and wall mount manufacturers.
- If you have any doubts about your ability to safely install your flat panel display, contact your retailer about professional installation.
- Make sure that the wall where you are mounting the display is appropriate. Some wall mounts are not designed to be mounted to walls with steel studs or old cinder block construction. If you are unsure, contact a professional installer.
- A minimum of two people are required for installation. Flat panel displays can be heavy



 **CEA**
Consumer Electronics Association
www.CE.org/safety



) **Federal Communications Commission(FCC) Statement**

You are cautioned that changes or modifications not expressly approved by the part responsible

for compliance could void the user's authority to operate the equipment.

This equipment has been tested and found to comply with the limits for a Class B digital device, pursuant to part 15 of the FCC rules.

These limits are designed to provide reasonable protection against harmful interference in a residential installation.

This equipment generates, uses and can radiate radio frequency energy and, if not installed and used in accordance with the instructions, may cause harmful interference to radio communications.

However, there is no guarantee that interference will not occur in a particular installation.

If this equipment does cause harmful interference to radio or television reception, which can be determined by turning the equipment off and on, the user is encouraged to try to correct the

interference by one or more of the following measures:

- Reorient or relocate the receiving antenna.
- Increase the separation between the equipment and receiver.
- Connect the equipment into an outlet on a circuit different from that to which the receiver is connected
- Consult the dealer or an experienced radio/TV technician for help.

This device complies with Part 15 of the FCC Rules.

Operation is subject to the following two conditions:

- 1) this device may not cause harmful interference, and
- 2) this device must accept any interference received, including interference that may cause undesired operation of the device.

Indoor use only

FCC Caution: Any changes or modifications not expressly approved by the party responsible for compliance could void the user's authority to operate this equipment.

Caution: Exposure to Radio Frequency Radiation.

1. This device and its antenna must not be co-located or operating in conjunction with any other antenna or transmitter.

2. This equipment complies with FCC RF radiation exposure limits set forth for an uncontrolled environment. This equipment should be installed and operated with a minimum distance of 20 centimeters between the radiator and your body.