



**LG**

Life's Good

# OWNER'S MANUAL LED TV\*

\* LG LED TV applies LCD screen with LED backlights.

Please read this manual carefully before operating your TV and retain it for future reference.

50LN5100	47LN5200	32LN530B	32LN5310	32LN536B	42LN5400
55LN5100	50LN5200	32LN5300	47LN5310		47LN5400
	55LN5200	39LN5300	50LN5310		50LN5400
		42LN5300	55LN5310		55LN5400

# IMPORTANT SAFETY INSTRUCTIONS

Always comply with the following precautions to avoid dangerous situations and ensure peak performance of your product.

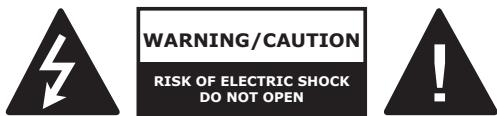

TO REDUCE THE RISK OF ELECTRIC SHOCK  
DO NOT REMOVE COVER (OR BACK).  
NO USER SERVICEABLE PARTS INSIDE.  
REFER TO QUALIFIED SERVICE PERSONNEL.

 The lightning flash with arrowhead symbol, within an equilateral triangle, is intended to alert the user to the presence of uninsulated “dangerous voltage” within the product’s enclosure that may be of sufficient magnitude to constitute a risk of electric shock to persons.

 The exclamation point within an equilateral triangle is intended to alert the user to the presence of important operating and maintenance (servicing) instructions in the literature accompanying the appliance.

## WARNING/CAUTION

- TO REDUCE THE RISK OF FIRE AND ELECTRIC SHOCK, DO NOT EXPOSE THIS PRODUCT TO RAIN OR MOISTURE.

### WARNING

If you ignore the warning message, you may be seriously injured or there is a possibility of accident or death.

### CAUTION

If you ignore the caution message, you may be slightly injured or the product may be damaged.

### NOTE

The note helps you understand and use the product safely. Please read the note carefully before using the product.

Read these instructions.  
Keep these instructions.  
Heed all warnings.  
Follow all instructions.



- Do not allow the television to become wet.



- Clean only with a dry cloth.



- Do not block any ventilation openings. Install in accordance with the manufacturer’s instructions.



- Do not install near any heat sources such as radiators, heat registers, stoves, or other apparatus (including amplifiers) that produce heat.



- Do not defeat the safety purpose of the polarized or grounding-type plug. A polarized plug has two blades with one wider than the other. A grounding type plug has two blades and a third grounding prong. The wide blade or the third prong are provided for your safety. If the provided plug does not fit into your outlet, consult an electrician for replacement of the obsolete outlet (Can differ by country).



- Do not press strongly upon the panel with a hand or a sharp object such as a nail, pencil or pen, or make a scratch on it.



- Protect the power cord from being walked on or pinched particularly at plugs, convenience receptacles, and the point where they exit from the apparatus.



- Only use attachments/accessories specified by the manufacturer.



- Use only with a cart, stand, tripod, bracket, or table specified by the manufacturer, or sold with the apparatus. When a cart is used, use caution when moving the cart/apparatus combination to avoid injury from tip-over.



- Unplug this apparatus during lightning storms or when unused for long periods of time.



- Refer all servicing to qualified service personnel. Servicing is required when the apparatus has been damaged in any way, such as power-supply cord or plug is damaged, liquid has been spilled or objects have fallen into the apparatus, the apparatus has been exposed to rain or moisture, does not operate normally, or has been dropped.



- Do not stick metal objects or any other conductive material into the power cord. Do not touch the end of the power cord while it is plugged in.
- Keep the packing anti-moisture material or vinyl packing out of the reach of children. Anti-moisture material is harmful if swallowed. If swallowed by mistake, induce vomiting and go the nearest hospital. Additionally, vinyl packing can cause suffocation. Keep it out of the reach of children.

- CAUTION** concerning the Power Cord (Can differ by country):  
 It is recommended that appliances be placed upon a dedicated circuit; that is, a single outlet circuit which powers only that appliance and has no additional outlets or branch circuits. Check the specification page of this owner's manual to be certain. Do not connect too many appliances to the same AC power outlet as this could result in fire or electric shock. Do not overload wall outlets. Overloaded wall outlets, loose or damaged wall outlets, extension cords, frayed power cords, or damaged or cracked wire insulation are dangerous. Any of these conditions could result in electric shock or fire. Periodically examine the cord of your appliance, and if its appearance indicates damage or deterioration, unplug it, discontinue use of the appliance, and have the cord replaced with an exact replacement part by an authorized service. Protect the power cord from physical or mechanical abuse, such as being twisted, kinked, pinched, closed in a door, or walked upon. Pay particular attention to plugs, wall outlets, and the point where the cord exits the appliance. Do not move the TV with the power cord plugged in. Do not use a damaged or loose power cord. Be sure do grasp the plug when unplugging the power cord. Do not pull on the power cord to unplug the TV.



- Warning** - To reduce the risk of fire or electrical shock, do not expose this product to rain, moisture or other liquids. Do not touch the TV with wet hands. Do not install this product near flammable objects such as gasoline or candles, or expose the TV to direct air conditioning.



- Do not expose to dripping or splashing and do not place objects filled with liquids, such as vases, cups, etc. on or over the apparatus (e.g. on shelves above the unit).



- Grounding**  
 (Except for devices which are not grounded.)  
 Ensure that you connect the earth ground wire to prevent possible electric shock (i.e. a TV with a three-prong grounded AC plug must be connected to a three-prong grounded AC outlet). If grounding methods are not possible, have a qualified electrician install a separate circuit breaker. Do not try to ground the unit by connecting it to telephone wires, lightning rods, or gas pipes.

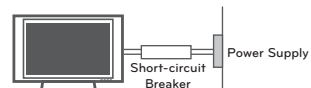

- As long as this unit is connected to the AC wall outlet, it is not disconnected from the AC power source even if the unit is turned off.
- Do not attempt to modify this product in any way without written authorization from LG Electronics. Unauthorized modification could void the user's authority to operate this product.
- **Outdoor Antenna Grounding** (Can differ by country):

If an outdoor antenna is installed, follow the precautions below. An outdoor antenna system should not be located in the vicinity of overhead power lines or other electric light or power circuits, or where it can come in contact with such power lines or circuits as death or serious injury can occur. Be sure the antenna system is grounded so as to provide some protection against voltage surges and built-up static charges. Section 810 of the National Electrical Code (NEC) in the U.S.A. provides information with respect to proper grounding of the mast and supporting structure, grounding of the lead-in wire to an antenna discharge unit, size of grounding conductors, location of antenna discharge unit, connection to grounding electrodes and requirements for the grounding electrode.

**Antenna grounding according to the National Electrical Code, ANSI/NFPA 70**

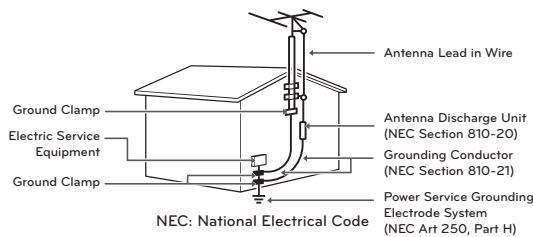

- **Cleaning**  
When cleaning, unplug the power cord and wipe gently with a soft cloth to prevent scratching. Do not spray water or other liquids directly on the TV as electric shock may occur. Do not clean with chemicals such as alcohol, thinners, or benzine.
- **Moving**  
Make sure the product is turned off, unplugged, and all cables have been removed. It may take 2 or more people to carry larger TVs. Do not press or put stress on the front panel of the TV.
- **Ventilation**  
Install your TV where there is proper ventilation. Do not install in a confined space such as a bookcase. Do not cover the product with cloth or other materials while plugged. Do not install in excessively dusty places.
- If you smell smoke or other odors coming from the TV, unplug the power cord and contact an authorized service center.
- Keep the product away from direct sunlight.
- Never touch this apparatus or antenna during a lightning storm.
- When mounting a TV on the wall, make sure not to install the TV by hanging the power and signal cables on the back of the TV.
- Do not allow an impact shock, any objects to fall into the product, and do not drop anything onto the screen.

- **Disconnecting the Main Power**

The power outlet used with this device must remain easily accessible.

- Store the accessories (battery, etc.) in a safe location out of the reach of children.
- This apparatus uses batteries. In your community there might be regulations that require you to dispose of these batteries properly due to environmental considerations. Please contact your local authorities for disposal or recycling information.
- Do not dispose of batteries in a fire.
- Do not short circuit, disassemble, or allow the batteries to overheat.

- **Dot Defect**

The panel is a high technology product with resolution of two million to six million pixels. In a very few cases, you could see fine dots on the screen while you're viewing the TV. Those dots are deactivated pixels and do not affect the performance and reliability of the TV.

- **Generated Sound**

Cracking noise: A cracking noise that occurs when watching or turning off the TV is generated by plastic thermal contraction due to temperature and humidity. This noise is common for products where thermal deformation is required.

Electrical circuit humming/panel buzzing: A low level noise is generated from a high-speed switching circuit, which supplies a large amount of current to operate a product. It varies depending upon the product.

This generated sound does not affect the performance and reliability of the product.

- Take care not to touch the ventilation openings. When watching the TV for a long period, the ventilation openings may become hot. This does not affect the performance of the product or cause defects in the product.
- If the TV feels cold to the touch, there may be a small flicker when it is turned on. This is normal, there is nothing wrong with TV. Some minute dot defects may be visible on the screen, appearing as tiny red, green, or blue spots. However, they have no adverse effect on the TV's performance. Avoid touching the LCD screen or holding your finger(s) against it for long periods of time. Doing so may produce some temporary distortion effects on the screen.

**Preventing Image burn or Burn-in on your TV screen**

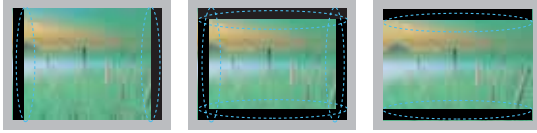

- If a fixed image displays on the TV screen for a long period of time, it will be imprinted and become a permanent disfigurement on the screen. This is image burn or burn-in and not covered by the warranty.
- If the aspect ratio of the TV is set to 4:3 for a long period of time, image burn may occur on the letterboxed area of the screen.
- Avoid displaying a fixed image on the TV screen for a long period of time (2 or more hours for LCD, 1 or more hours for the Plasma TV) to prevent image burn.

**For USA and Canada**

**FCC NOTICE**

This equipment has been tested and found to comply with the limits for a Class B digital device, pursuant to Part 15 of the FCC Rules. These limits are designed to provide reasonable protection against harmful interference in a residential installation. This equipment generates, uses and can radiate radio frequency energy and, if not installed and used in accordance with the instructions, may cause harmful interference to radio communications. However, there is no guarantee that interference will not occur in a particular installation. If this equipment does cause harmful interference to radio or television reception, which can be determined by turning the equipment off and on, the user is encouraged to try to correct the interference by one or more of the following measures:

- Reorient or relocate the receiving antenna.
- Increase the separation between the equipment and the receiver.
- Connect the equipment to an outlet on a circuit different from that to which the receiver is connected.
- Consult the dealer or an experienced radio/TV technician for help.

This device complies with part 15 of the FCC Rules. Operation is subject to the following two conditions: (1) this device may not cause harmful interference and (2) this device must accept any interference received, including interference that may cause undesired operation of the device.

Any changes or modifications in construction of this device which are not expressly approved by the party responsible for compliance could void the user's authority to operate the equipment.

**NOTE TO CABLE/TV INSTALLER**

This reminder is provided to call the CATV system installer's attention to Article 820-40 of the National Electric Code (U.S.A.). The code provides guidelines for proper grounding and, in particular, specifies that the cable ground shall be connected to the grounding system of the building, as close to the point of the cable entry as practical.

ENGLISH

## LICENSES

Supported licenses may differ by model. For more information about licenses, visit [www.lg.com](http://www.lg.com).



Manufactured under license from Dolby Laboratories.  
"Dolby" and the double-D symbol are trademarks of Dolby Laboratories.



The terms HDMI and HDMI High-Definition Multimedia Interface, and the HDMI logo are trademarks or registered trademarks of HDMI Licensing LLC in the United States and other countries.

## OPEN SOURCE SOFTWARE NOTICE

ENGLISH

To obtain the source code under GPL, LGPL, MPL and other open source licenses, that is contained in this product, please visit <http://opensource.lge.com>.

In addition to the source code, all referred license terms, warranty disclaimers and copyright notices are available for download.

LG Electronics will also provide open source code to you on CD-ROM for a charge covering the cost of performing such distribution (such as the cost of media, shipping and handling) upon email request to [opensource@lge.com](mailto:opensource@lge.com). This offer is valid for three (3) years from the date on which you purchased the product.



# TABLE OF CONTENTS

## 2 IMPORTANT SAFETY INSTRUCTIONS

---

## 8 LICENSES

---

## 8 OPEN SOURCE SOFTWARE NOTICE

---

## 9 TABLE OF CONTENTS

---

## 11 INSTALLATION PROCEDURE

---

### 11 ASSEMBLING AND PREPARING

---

- 11 Unpacking
- 13 Parts and Buttons
- 16 Lifting and moving the TV
- 17 Setting up the TV
  - 17 - Attaching the stand
  - 18 - Mounting on a table
  - 20 - Tidying cables
  - 20 - Mounting on a wall

### 22 REMOTE CONTROL

---

## 24 WATCHING TV

---

- 24 Turning the TV on for the first time
- 24 Watching TV
- 25 Managing channels
  - 25 - Setting up channels
  - 26 - Using favorite channels
  - 27 - Checking current program info
- 28 Using additional options
  - 28 - Adjusting aspect ratio
  - 29 - Changing AV modes
  - 29 - Using the input list
- 30 Using the quick menu

## 31 ENTERTAINMENT

---

- 31 - Connecting USB storage devices
- 32 - Browsing files
- 33 - Viewing Photos
- 34 - Listening to music

## 36 CUSTOMIZING TV SETTINGS

---

- 36 The Main Menus
- 37 Customizing Settings
  - 37 - PICTURE Settings
  - 40 - AUDIO Settings
  - 41 - CHANNEL Settings
  - 41 - TIME Settings
  - 42 - OPTION Settings
  - 44 - LOCK Settings

## **46 MAKING CONNECTIONS**

---

- 46 Connecting to an antenna or cable
- 47 Connection Overview
- 48 Connecting to a HD receiver, DVD Player, or VCR
  - 48 - HDMI Connection
  - 49 - Connecting to a mobile phone
  - 50 - Component Connection
  - 51 - Composite Connection
- 52 Connecting a PC
  - 52 - HDMI Connection
- 53 Connecting to an Audio System
  - 53 - Digital Optical Audio Connection
- 54 Connecting a USB Device
- 55 SIMPLINK Connection
  - 55 - Activating and Using the SIMPLINK menus

## **57 TROUBLESHOOTING**

---

## **58 EXTERNAL CONTROL DEVICE SETUP**

---

## **59 SPECIFICATIONS**

---

## **56 MAINTENANCE**

---

- 56 Cleaning Your TV
  - 56 - Screen, frame, cabinet, and stand
  - 56 - Power cord

### **! NOTE**

- Image shown may differ from your TV.
- Your TV's OSD (On Screen Display) may differ slightly from that shown in this manual.
- The available menus and options may differ from the input source or product model that you are using.
- New features may be added to this TV in the future.

# INSTALLATION PROCEDURE

- 1 Open the package and make sure all the accessories are included.
- 2 Attach the stand to the TV set.
- 3 Connect an external device to the TV set.

# ASSEMBLING AND PREPARING

## Unpacking

Check your product box for the following items. If there are any missing accessories, contact the local dealer where you purchased your product. The illustrations in this manual may differ from the actual product and item.

### CAUTION

- Do not use any unapproved items to ensure the safety and product life span.
- Any damages or injuries by using unapproved items are not covered by the warranty.
- Some models appear to have a thin film on the screen. It is actually part of the screen; do not remove it.

### NOTE

- The items supplied with your product may vary depending on the model.
- Product specifications or contents of this manual may be changed without prior notice due to upgrade of product functions.
- For an optimal connection, HDMI cables and USB devices should have bezels less than 10 mm (0.39 inches) thick and 18 mm (0.7 inches) width.
- Use an extension cable that supports USB 2.0 if the USB cable or USB memory stick does not fit into your TV's USB port.

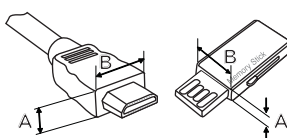

\*A ≤ 10 mm (0.39 inches)  
 \*B ≤ 18 mm (0.7 inches)

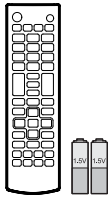

**Remote Control, Batteries  
(AAA)**

(See p. 22)

---

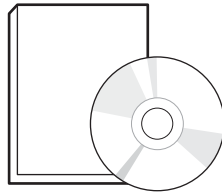

**Owner's Manual,  
CD manual**

---



**Power Cord**

---

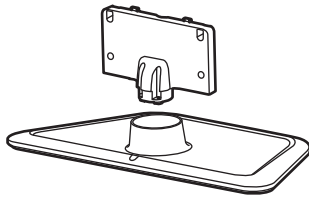

**Stand Body, Stand Base**

(See p. 17)

---

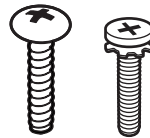

**Stand Screws**

3 EA, P5 x 25  
4 EA, M4 x 14  
(See p. 17)

---

(For [50LN5100](#), 47/50LN5200, 32LN530B,  
32/39/42LN5300, 32/47/50LN5310,  
32LN536B, 42/47/50LN5400)



**Desk-mount Screw**

(See p. 18)

---



**Cable Holder**

(See p. 20)

---

## Parts and Buttons

For LN5100 series

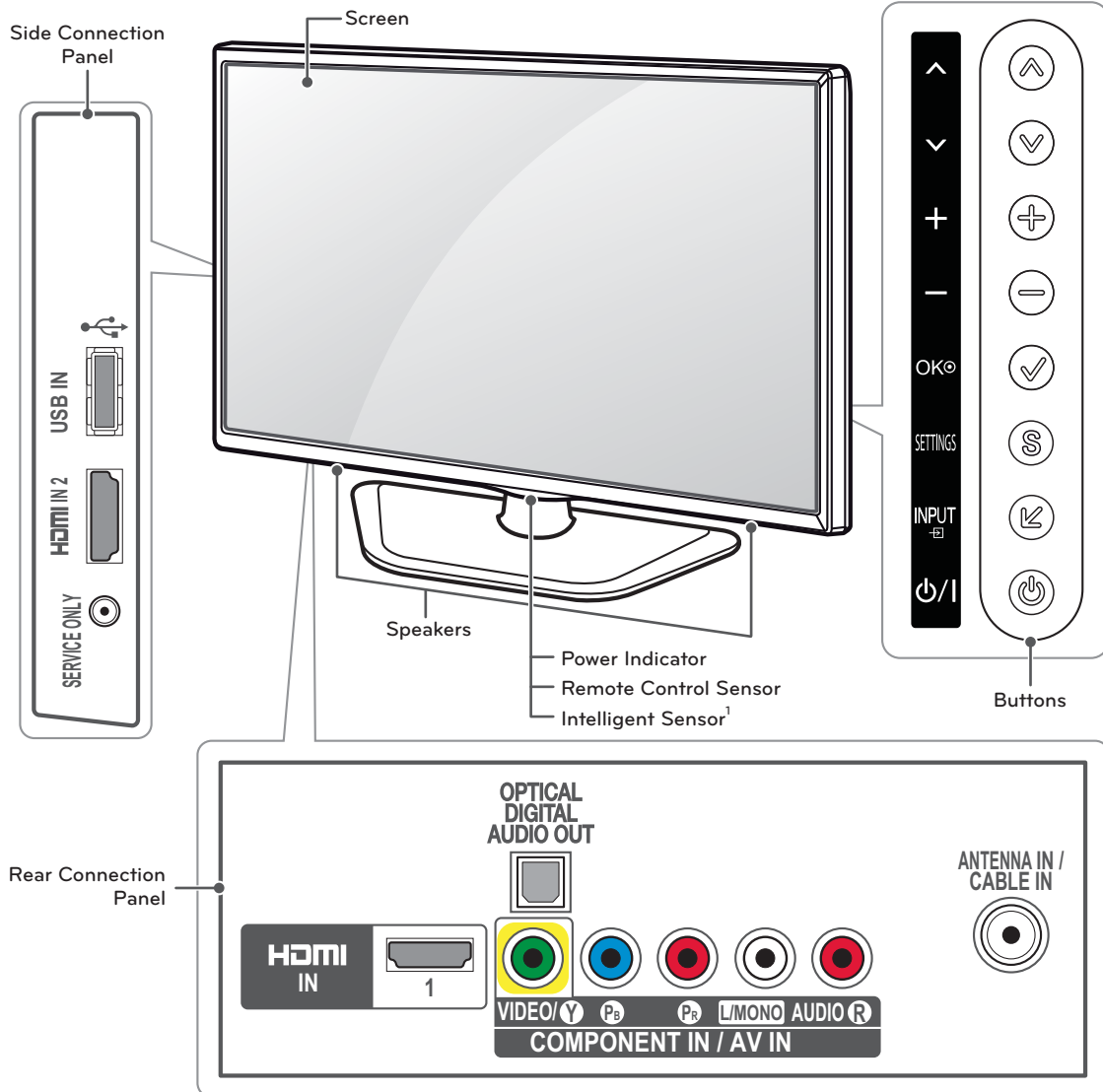

ENGLISH

Button	Description
▲ / ▼ (▲ / ▼)	Scrolls through the saved channels.
+ / = (+ / -)	Adjusts the volume level.
✓ (OK)	Selects the highlighted menu option or confirms an input.
S (SETTINGS)	Accesses the main menus, or saves your input and exits the menus.
↻ (INPUT)	Changes the input source.
⏻ (power)	Turns the power on or off.

1 Intelligent sensor - Adjusts the image quality and brightness based on the surrounding environment.

For LN5200, LN530B, LN5300, LN5310, LN5400 series

ENGLISH

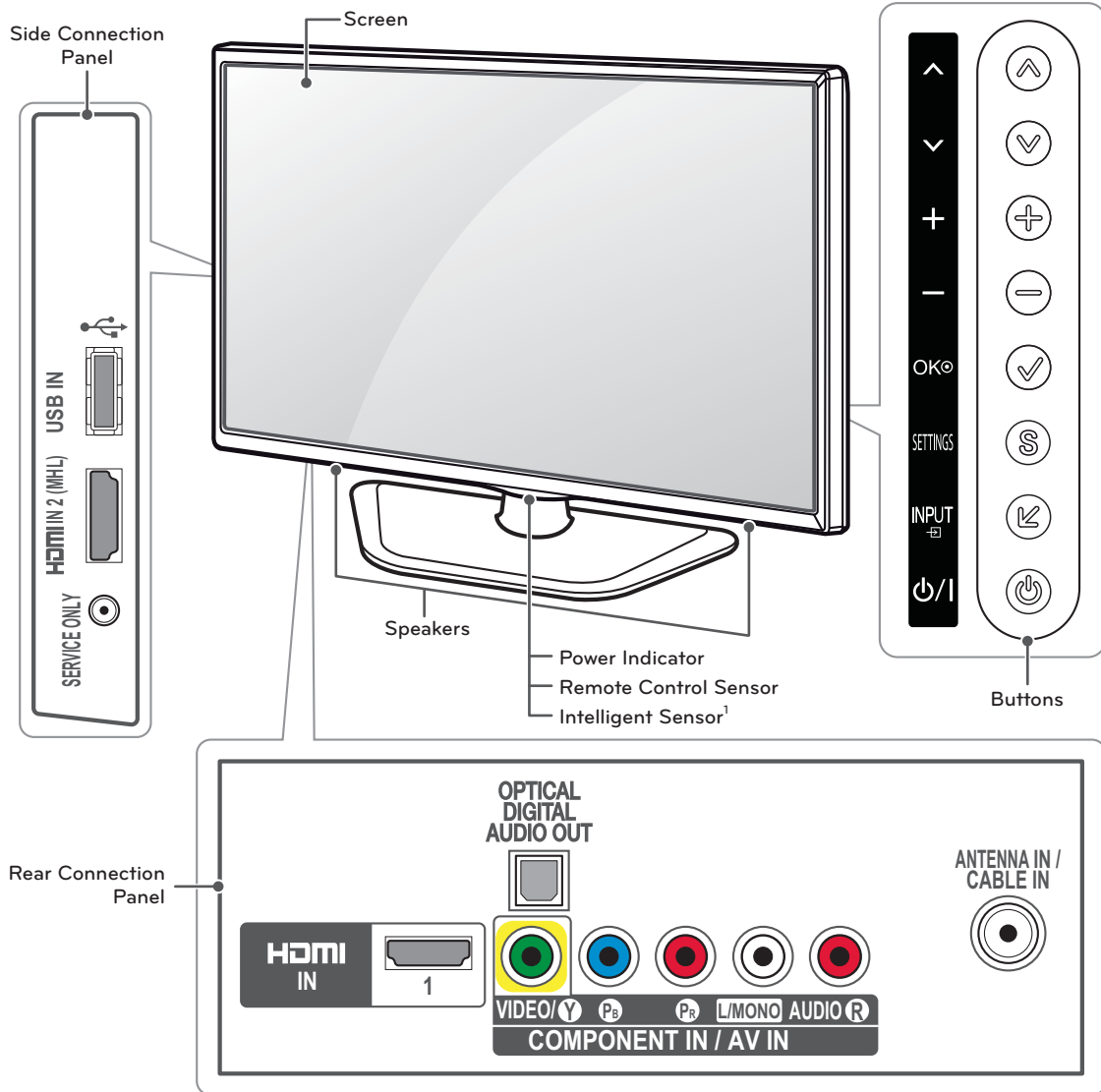

Button	Description
▲ / ▼ (▲ / ▼)	Scrolls through the saved channels.
⊕ / ⊖ (⊕ / ⊖)	Adjusts the volume level.
✓ (OK)	Selects the highlighted menu option or confirms an input.
S (SETTINGS)	Accesses the main menus, or saves your input and exits the menus.
↶ (INPUT)	Changes the input source.
⏻ / ⏼	Turns the power on or off.

1 Intelligent sensor - Adjusts the image quality and brightness based on the surrounding environment.

For LN536B series

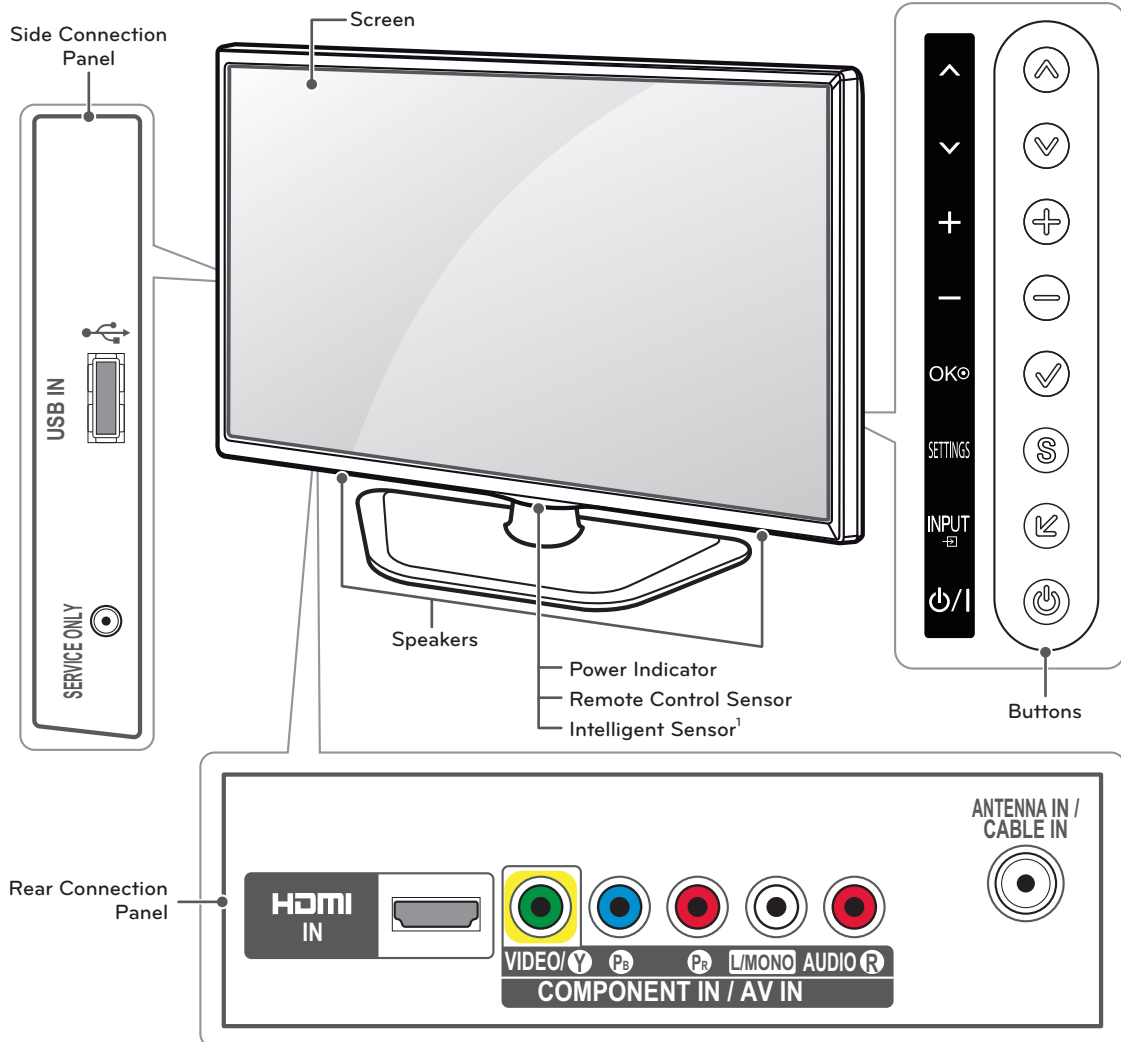

ENGLISH

Button	Description
▲ / ▼ (▲ / ▼)	Scrolls through the saved channels.
+ / = (+ / -)	Adjusts the volume level.
✓ (OK)	Selects the highlighted menu option or confirms an input.
S (SETTINGS)	Accesses the main menus, or saves your input and exits the menus.
⏪ (INPUT)	Changes the input source.
⏻ (power)	Turns the power on or off.

1 Intelligent sensor - Adjusts the image quality and brightness based on the surrounding environment.

## Lifting and moving the TV

When moving or lifting the TV, read the following to prevent the TV from being scratched or damaged and for safe transportation regardless of its type and size.

### CAUTION

- Avoid touching the screen at all times, as this may result in damage to the screen.
- Do not place the product on the floor with its front facing down. Failure to do so may result in damage to the screen.

- It is recommended to move the TV in the box or packing material that the TV originally came in.
- Before moving or lifting the TV, disconnect the power cord and all cables.
- When holding the TV, the screen should face away from you to avoid damage.



- Hold the top and bottom of the TV frame firmly. Make sure not to hold the transparent part, speaker, or speaker grill area.

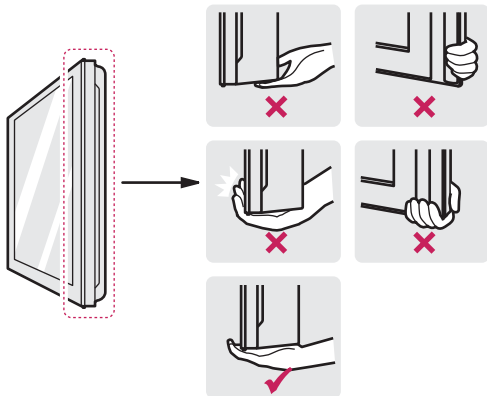

- Use at least two people to move a large TV.
- When transporting the TV by hand, hold the TV as shown in the following illustration.

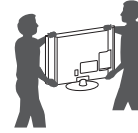

- When transporting the TV, do not expose the TV to jolts or excessive vibration.
- When transporting the TV, keep the TV upright; never turn the TV on its side or tilt towards the left or right.



## Setting up the TV

You can mount your TV to a wall or attach the stand if you wish to place the TV on an entertainment center or other furniture.

### Attaching the stand

If you are not mounting the TV to a wall, use the following instructions to attach the stand.

**CAUTION**

- When attaching the stand to the TV set, place the screen facing down on a cushioned table or flat surface to protect the screen from scratches.
- Make sure that the screws are fastened tightly. (If they are not fastened securely enough, the TV may tilt forward after being installed.)
- Do not tighten the screws with too much force; otherwise they may be damaged and come loose later.

**NOTE**

- Remove the stand before installing the TV on a wall mount by performing the stand attachment in reverse.

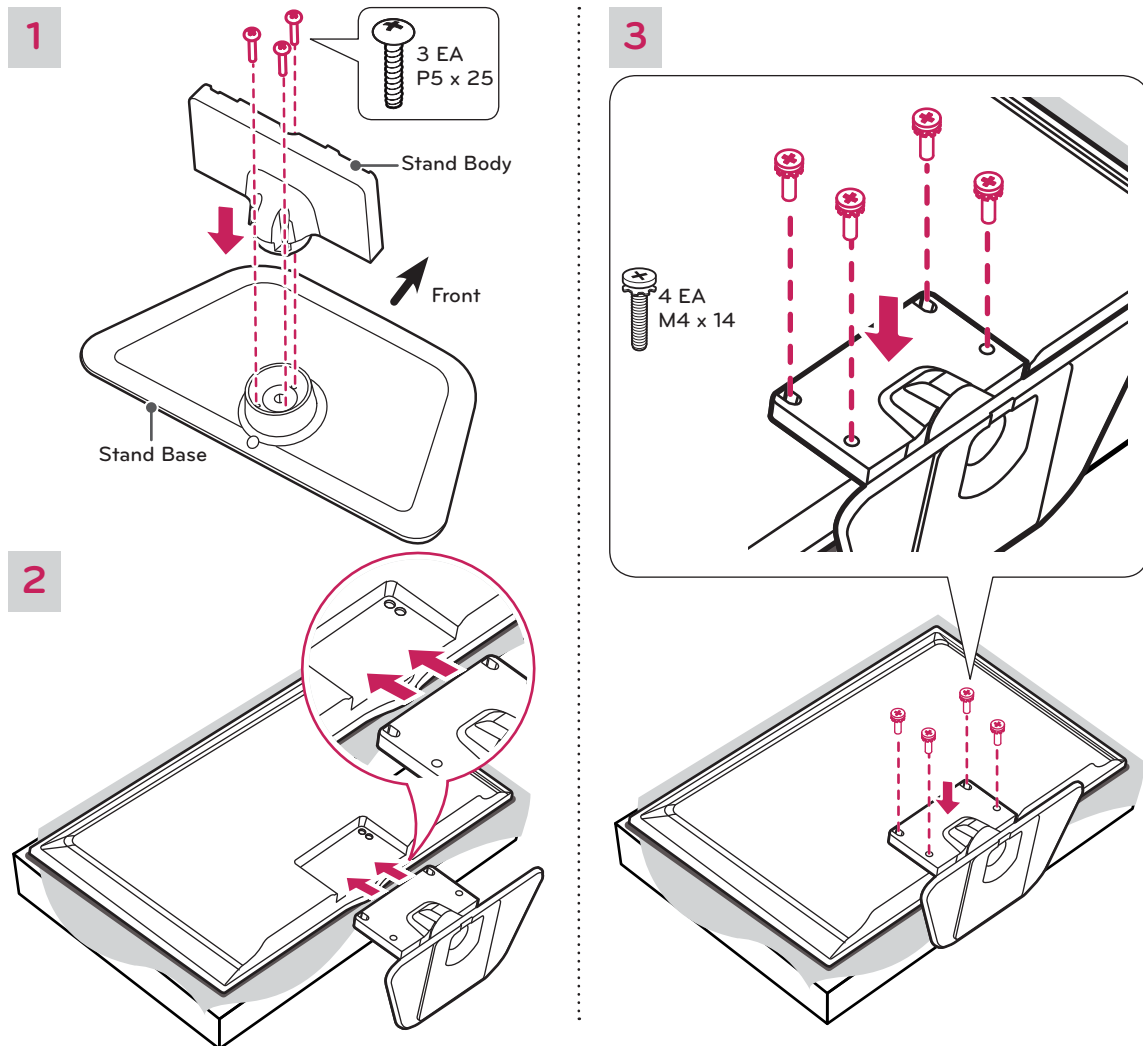

## Mounting on a table

- 1 Lift and tilt the TV into its upright position on a table.
  - Leave a 10 cm (4 inches) (minimum) space from the wall for proper ventilation.

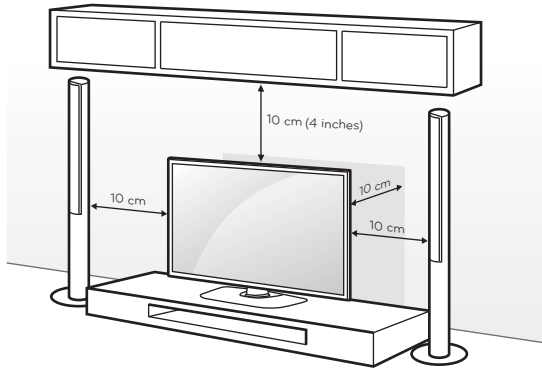

- 2 Connect the power cord to a wall outlet.

### ⚠ CAUTION

- Do not place the TV near or on sources of heat, as this may result in fire or other damage.

ENGLISH

### Securing the TV to a table

(For 50LN5100, 47/50LN5200, 32LN530B, 32/39/42LN5300, 32/47/50LN5310, 32LN536B, 42/47/50LN5400)

Attach the TV to a table to prevent from tilting forward, damage, and potential injury.

Mount the TV on a table, and then insert and tighten the supplied screw on the rear of the stand.

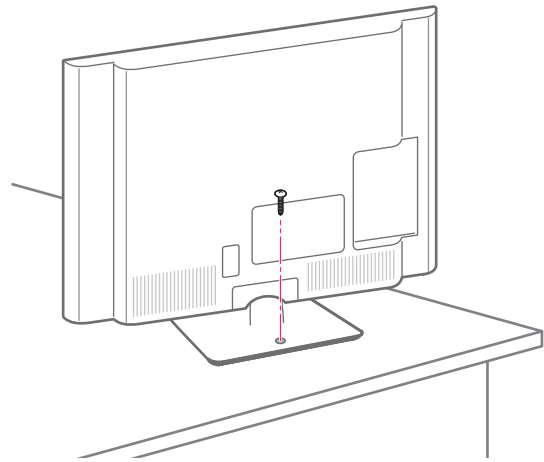

### ⚠ WARNING

- To prevent TV from falling over, the TV should be securely attached to the floor/wall per installation instructions. Tipping, shaking, or rocking the TV may cause injury.

**Using the Kensington security system (optional)**

The Kensington security system connector is located at the rear of the TV. For more information of installation and using, refer to the manual provided with the Kensington security system or visit <http://www.kensington.com>.

Connect the Kensington security system cable between the TV and a table.

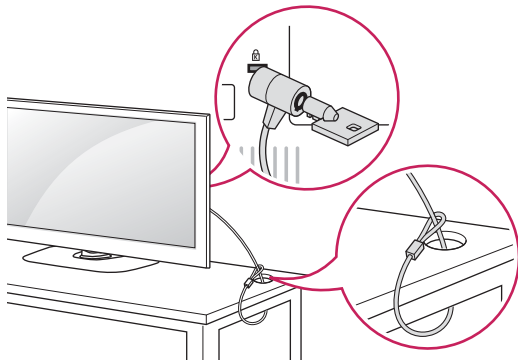
**NOTE**

- The Kensington security system is optional. You can obtain additional accessories from your local dealer.

**Securing the TV to a wall (optional)**

(Depending on model)

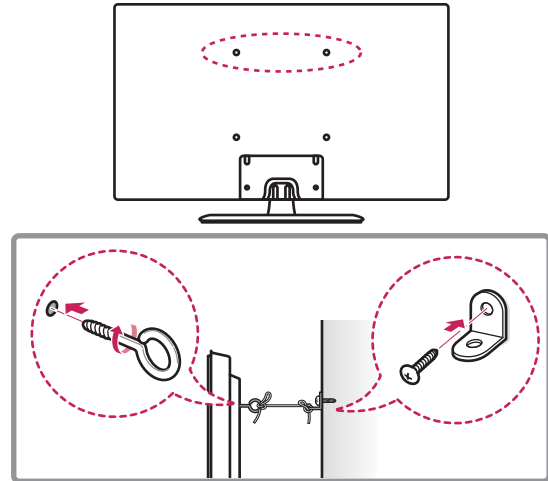

- 1 Insert and tighten the eye-bolts, or TV brackets and bolts on the back of the TV.  
- If there are bolts inserted at the eye-bolts position, remove the bolts first.
- 2 Mount the wall brackets with the bolts to the wall.  
Match the location of the wall bracket and the eye-bolts on the rear of the TV.
- 3 Connect the eye-bolts and wall brackets tightly with a sturdy rope or cable.  
Make sure to keep the rope parallel to the flat surface.

**CAUTION**

- Make sure that children do not climb on or hang on the TV.

**NOTE**

- Use a platform or cabinet that is strong and large enough to support the TV securely.
- Brackets, bolts and ropes, are optional. You can obtain additional accessories from your local dealer.

## Tidying cables

- 1 Gather and bind the cables with the cable holder.

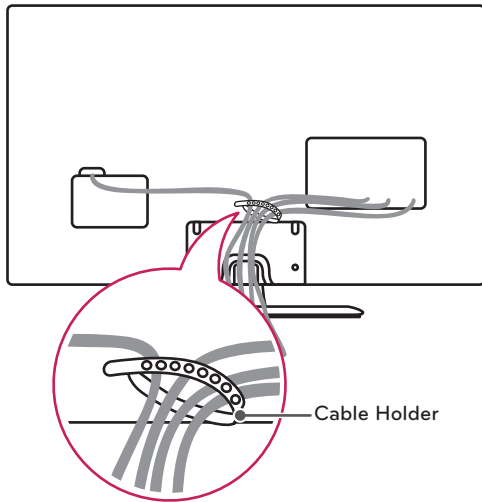

### ⚠ CAUTION

- Do not move the TV by holding the cable holder, as the cable holders may break, and injuries and damage to the TV may occur.

ENGLISH

## Mounting on a wall

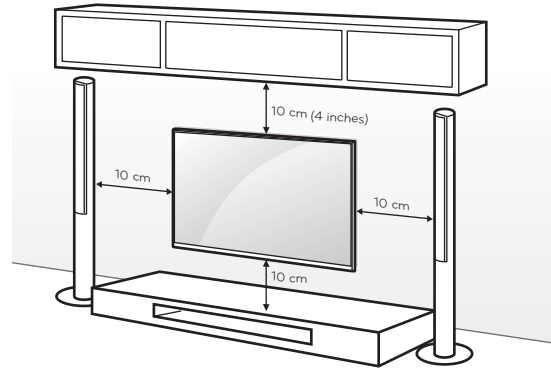

An optional wall mount can be used with your LG Television. Consult with your local dealer for a wall mount that supports the VESA standard used by your TV model. Carefully attach the wall mount bracket at the rear of the TV. Install the wall mount bracket on a solid wall perpendicular to the floor. If you are attaching the TV to other building materials, please contact qualified personnel to install the wall mount. Detailed instructions will be included with the wall mount. We recommend that you use an LG brand wall mount.



Make sure to use screws and wall mounts that meet the VESA standard. Standard dimensions for the wall mount kits are described in the following table.

<b>Model</b>	32LN530B 32LN5300 32LN5310 32LN536B	39LN5300 42LN5300 42LN5400
<b>VESA (A x B)</b> 	200 x 100	200 x 200
<b>Standard screw</b>	M4	M6
<b>Number of screws</b>	4	4
<b>Wall mount bracket (optional)</b>	LSW130B	LSW230B MSW240

<b>Model</b>	50LN5100 55LN5100 47LN5200 50LN5200 55LN5200 47LN5310 50LN5310 55LN5310	47LN5400 50LN5400 55LN5400
<b>VESA (A x B)</b> 	400 x 400	
<b>Standard screw</b>	M6	
<b>Number of screws</b>	4	
<b>Wall mount bracket (optional)</b>	LSW430B MSW240	

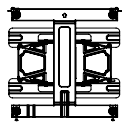
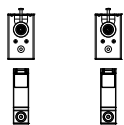
Wall mount bracket (optional)	
LSW130B	
LSW230B	
LSW430B	
MSW240	

**CAUTION**

- Disconnect the power before moving or installing the TV. Otherwise electric shock may occur.
- If you install the TV on a ceiling or slanted wall, it may fall and result in severe injury. Use an authorized LG wall mount and contact the local dealer or qualified personnel.
- Do not over tighten the screws as this may cause damage to the TV and void your warranty.
- Use the screws and wall mounts that meet the VESA standard. Any damages or injuries by misuse or using an improper accessory are not covered by the warranty.

**NOTE**

- Use the screws that are listed in the VESA standard screw specifications.
- The wall mount kit includes an installation manual and necessary parts.
- The wall mount bracket is optional. You can obtain additional accessories from your local dealer.
- The length of screws may differ depending upon the wall mount. Make sure to use the proper length.
- For more information, refer to the manual supplied with the wall mount.

## REMOTE CONTROL

The descriptions in this manual are based on the buttons on the remote control. Please read this manual carefully and use the TV correctly.

To install batteries, open the battery cover, replace batteries (1.5 V AAA) matching the ⊕ and ⊖ ends to the label inside the compartment, and close the battery cover.

Failure to match the correct polarities of the battery may cause the battery to burst or leak, resulting in fire, personal injury, or ambient pollution.

To remove the batteries, perform the installation actions in reverse.

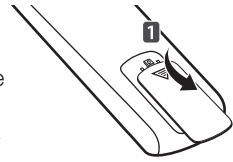

### ⚠ CAUTION

- Do not mix old and new batteries, as this may damage the remote control.

This remote uses infrared light. When in use, it should be pointed in the direction of the TV's remote sensor.

ENGLISH

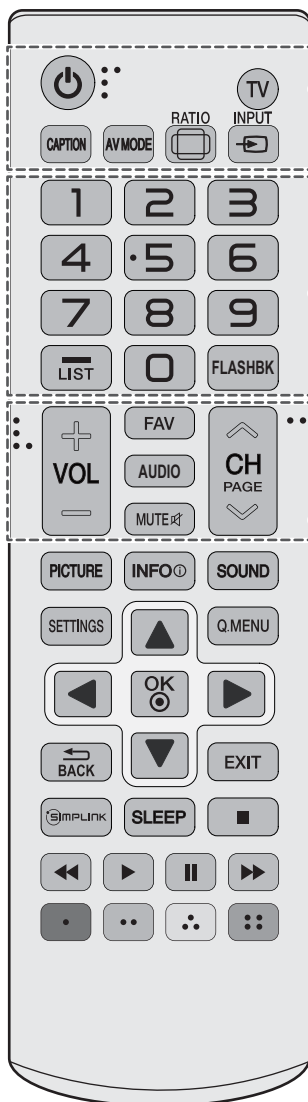

#### ⏻ (POWER)

Turns the TV on or off.

#### TV

Returns to the last TV channel.

#### CAPTION

Activates or deactivate the subtitles.

#### AV MODE (See p. 29)

Selects an AV mode.

#### 🖼️ RATIO (See p. 28)

Resizes an image.

#### 📺 INPUT (See p. 29)

Changes the input source. Turns the TV on if it is off.

#### Number button

Enters numbers.

#### - (Dash)

Inserts a dash between numbers such as 2-1 and 2-2.

#### LIST (See p. 26)

Accesses the saved channel list.

#### FLASHBK

Alternates between the two last channels selected (pressing repeatedly).

#### + VOL -

Adjusts the volume level.

#### FAV (See p. 26)

Accesses your favorite channel list.

#### AUDIO

Digital signal: Changes the audio language.  
Analog signal: Changes the MTS sound.

#### MUTE 🚫

Mutes all sounds.

#### ⏪ CH ⏩

Scrolls through the saved channels.

#### ⏪ PAGE ⏩

Moves to the previous or next screen.

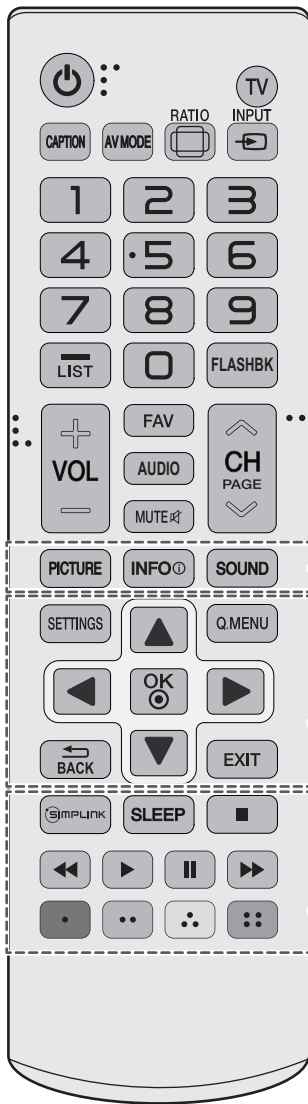

**PICTURE**

Changes the image mode.

**INFO** (See p. 27)

Shows information on the current program.

**SOUND**

Changes the sound mode.

**SETTINGS**

Accesses the main menu.

**.MENU** (See p. 30)

Accesses the quick menu.

**Navigation buttons** (up/down/left/right)

Scrolls through menus or options.

**OK**

Selects menus or options and confirms your input.

**BACK**

Returns to the previous screen.

**EXIT**

Clears all on-screen displays and returns to TV viewing.

**SIMPLINK** (See p. 55)

Accesses the AV devices connected to the TV.  
Opens the SIMPLINK menu.

**SLEEP**

Sets the length of time until the TV to turns off.

**Control buttons** (stop, play, pause, fast forward, fast reverse)

Controls SIMPLINK compatible devices (USB, SIMPLINK).

**Color buttons**

These access special functions in some menus.

(Red): Red, (Green): Green, (Yellow): Yellow, (Blue): Blue

## WATCHING TV

### Turning the TV on for the first time

When you turn the TV on for the first time, the Initial setting screen appears. Select a language and customize the basic settings.

- 1 Connect the power cord to a power outlet.
- 2 In standby mode, press the power button on the remote control to turn the TV on. The Initial setting screen appears when you turn the TV on for the first time.

#### ! NOTE

- You can also access **Initial Setting** by accessing **OPTION** in the main menu.

- 3 Follow the on-screen instructions to customize your TV settings according to your preferences.

<b>Language</b>	Selects a language to display.
↓	
<b>Mode Setting</b>	Selects <b>Home Use</b> for the home environment.
↓	
<b>Time Setting</b>	Selects the time zone and daylight saving.
↓	
<b>Auto Tuning</b>	Scans and saves available channels automatically.

#### ! NOTE

- To display images in the best quality for your home environment, select **Home Use**.
- **Store Demo** is suitable for the retail environment.
- If you select **Store Demo**, any customized settings will switch back to the default settings of **Store Demo** in 5 minutes.

- 4 When the basic settings are complete, press the **OK**.

#### ! NOTE

- If you do not complete the initial setting, it will appear whenever the TV turns on.
- Disconnect the power cord from the power outlet when you do not use the TV for a long period of time.

- 5 To turn the TV off, press the power button on the remote control.

### Watching TV

- 1 In Standby mode, press the power button on the remote control to turn the TV on.
- 2 Press **INPUT** and select **TV**.
- 3 Control the TV using the following buttons while you are watching TV.

Button	Description
<b>CH</b> (↖, ↗)	Scrolls through saved channels.
<b>LIST</b>	Selects a channel on the saved channel list.
<b>0 - 9</b>	Selects a channel by entering numbers.
<b>VOL</b> (+, -)	Adjusts the volume level.
<b>MUTE</b> (🔇)	Mutes all sounds.
<b>AV MODE</b> <sup>1</sup>	Selects an AV mode. (See p. 29)
<b>.MENU</b>	Accesses the quick menus. (See p. 30)
<b>FLASHBK</b>	Alternates between the last two channels selected.
<b>RATIO</b> (📐)	Resizes an image. (See p. 28)

<sup>1</sup> Each **AV mode** has different optimized image and sound settings. If you select **Off**, the image and sound settings will be restored to the previously customized settings.

- 4 To turn the TV off, press the power button on the remote control. The TV switches to Standby mode.



## Managing channels

### Setting up channels

#### Storing channels

##### To store channels automatically,

- 1 Press **SETTINGS** to access the main menus.
- 2 Press the Navigation buttons to scroll to **CHANNEL** and press **OK**.
- 3 Press the Navigation buttons to scroll to **Auto Tuning** and press **OK**.
- 4 Select **Yes** to start automatic tuning. The TV scans and saves available channels automatically.

#### ! NOTE

- If the TV scans and saves channels, the previously saved channels will be overwritten.

- 5 When you are finished, press **EXIT**. When you return to the previous menu, press **↩ BACK**.

##### To store channels manually,

- 1 Press **SETTINGS** to access the main menus.
- 2 Press the Navigation buttons to scroll to **CHANNEL** and press **OK**.
- 3 Press the Navigation buttons to scroll to **Manual Tuning** and press **OK**.
- 4 Scroll through the channel types, and then add or delete channels.
- 5 When you are finished, press **EXIT**. When you return to the previous menu, press **↩ BACK**.

#### ! NOTE

- You can store up to 800 channels. The number of channels that you can store differs depending on the broadcasting signal environment.
- The channels are stored in the order of **DTV**, **TV**, **CADTV** and **CATV**.

### Editing your channel list

- 1 Press **SETTINGS** to access the main menus.
- 2 Press the Navigation buttons to scroll to **CHANNEL** and press **OK**.
- 3 Press the Navigation buttons to scroll to **Channel Edit** and press **OK**.
- 4 Edit channels using the following buttons.

Button	Description
▲	Highlights the channel type.
▲, ▼, ◀, ▶	Scrolls through channel types or channels.
OK ⊙	Selects the highlighted channel to view.
CH (↵, ↻)	Moves to the previous or next page.
Blue button	Adds or deletes a channel. The deleted channel displays in grey.

- 5 When you are finished, press **EXIT**.  
When you return to the previous menu, press **⇐ BACK**.

### Selecting a channel on the channel list

- 1 Press **LIST** to access the channel list.
  - To move to the previous or next page, press **CH (↵, ↻)**.
  - To tune to the "CHANNEL menu - Channel Edit", press **Blue** button.
- 2 Select a channel you want and press **OK**.

## Using favorite channels

Add the channels that you watch frequently to the favorite list.

### Setting up your favorite list

- 1 Select a channel to add to the favorite list.
- 2 Press **●.MENU**.
- 3 Press the Navigation buttons to scroll to **Del/Add/Fav**.
- 4 Press the Navigation buttons to scroll to **Favorite**.
- 5 Press **OK** to add the selected channel to the favorite list.
- 6 When you are finished, press **EXIT**.

### Selecting a channel on the favorite list

- 1 Press **FAV** to access the favorite list.
  - To move to the previous or next page, press **CH (↵, ↻)**.
- 2 Select a channel you want and press **OK**.

## Checking current program info

Press **OK** to view the information of the currently program while you are watching.  
The following information appears at the top of the screen.

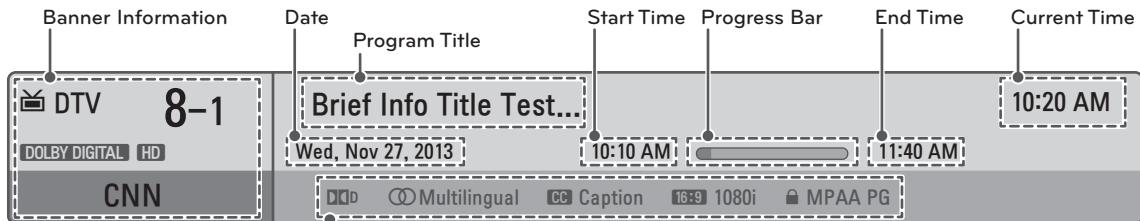

Icon		Description
Dolby Digital		The program contains a Dolby Digital audio signal. Supported by TV and HDMI input sources.
Multilingual		The program contains two or more audio language services. You can change the audio language using the quick menu.
Caption		The program contains one or more language caption services. You can change the caption language using the quick menu.
Aspect ratio	 	The original aspect ratio of the video is 4:3. The original aspect ratio of the video is 16:9 (wide).
Resolution	480i 480p 720p 1080i 1080p	The video resolution is 720 x 480i. The video resolution is 720 x 480p. The video resolution is 1280 x 720p. The video resolution is 1920 x 1080i. The video resolution is 1920 x 1080p.
Rating		The program contains Rating information. (See "LOCK Settings" on p. 44)

## Using additional options

### Adjusting aspect ratio

Resize an image to view at its optimal size by pressing **RATIO** while you are watching TV.

#### ! NOTE

- You can also change the image size by pressing **●.MENU** or accessing **Aspect Ratio** in the **PICTURE** menu.
- The available ratio varies depending on the input source.
  - The input sources: HDMI-PC support 4:3 and 16:9.

- **16:9:** Resizes images to fit the screen width.



- **Just Scan:** Displays video images in the original size without cutting off the edges.



#### ! NOTE

- If you select **Just Scan**, you may see image noises at the edge or edges of the screen.
- The input sources: DTV, Component, and HDMI-DTV (720p/1080i/1080p) support **Just Scan**.

- **Set By Program:** Displays images in the same aspect ratio as the original image.

(4:3 → 4:3 )



(16:9 → 16:9 )



- **4:3:** Resizes images to the previous standard 4:3.



- **Zoom:** Formats an image to fit the screen width. The top and bottom of the image may not appear.



- **Cinema Zoom1:** Formats an image to the cinemascope ratio, 2.35:1.  
To change the ratio of the cinema zoom, press ◀ or ▶ and its range is from 1 to 16.



### ! NOTE

- If you enlarge or reduce an image, the image may be distorted.

## Changing AV modes

Each **AV mode** has optimized image and sound settings.

Press **AV MODE** repeatedly to select an appropriate mode.

Mode	Description
<b>Off</b>	Changes to the previously customized settings.
<b>Cinema</b>	Uses the optimized image and sound settings for a cinematic look.
<b>Game</b>	Uses the optimized image and sound settings for fast gaming. When playing a video game using PlayStation or Xbox, it is recommended to use the Game mode. When in Game mode, functions related to picture quality will be optimized for playing games.

## Using the input list

### Selecting an input source

- 1 Press **INPUT** to access the input sources.  
- The connected device displays on each input source.

### ! NOTE

- You can also access the input source list by selecting **INPUT** in the **SETTINGS** menu.

- 2 Press the Navigation buttons to scroll to one of the input sources and press **OK**.

Input source	Description
<b>TV</b>	Watch TV over the air, cable, and digital cable broadcast.
<b>AV</b>	Watch video from a VCR or other external devices.
<b>Component</b>	Watch video from a DVD or other external devices, or through a digital set-top box.
<b>HDMI</b>	Watches video from a HTS or other high definition devices.

The disconnected input sources will be gray.

- To add an input label, press the **Blue** button.  
You can easily identify a device connected to each input source.
- If you connect a new external device to the TV, a pop-up window appears. Select Yes on the pop-up window to switch to that input source.

### Adding an Input label









Add a label to an input source so that you can easily identify a device connected to each input source.

- 1 Press **INPUT** to access the input sources.
- 2 Press the Navigation buttons to scroll to one of the input sources.
- 3 Press the **Blue** button.
- 4 Press the Navigation buttons to scroll to one of the input labels and press **OK**.
- 5 When you are finished, press **EXIT**.  
When you return to the previous menu, press **↶ BACK**.

## Using the quick menu

Customize frequently used menus.

- 1 Press **●.MENU** to access the quick menus.
- 2 Press the Navigation buttons to scroll through the following menus and press **OK**.

Menu	Description
 <b>Aspect Ratio</b>	Changes the image size.
 <b>Picture Mode</b>	Changes the image mode.
 <b>Sound Mode</b>	Changes the sound mode.
 <b>Caption</b>	Activates or deactivate the subtitles.
 <b>Multi Audio</b> (Digital signal)	Changes the audio language.
 <b>SAP</b> (Analog signal)	Changes the MTS sound.
 <b>Sleep Timer</b>	Sets the length of time until the TV to turns off.
 <b>Del/Add/Fav</b>	Edits the channels to add or delete the channel.
 <b>Eject USB</b>	Eject a USB device. The menu is displayed only when the USB device is connected.

### NOTE

- The available menus and options may differ from the input source that you are using.

- 3 Press the Navigation buttons to scroll to the option you want.
- 4 When you are finished, press **●.MENU**.

# ENTERTAINMENT

## Connecting USB storage devices

Connect USB storage devices such as a USB flash drive or external hard drive to the TV and use multimedia features. (See "Browsing files" on p. 32)

Connect a USB flash drive or USB memory card reader to the TV as shown in the following illustration.

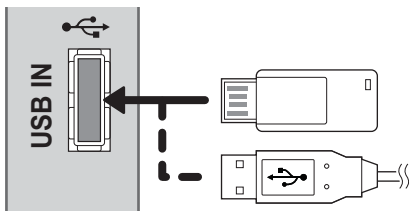

To disconnect a USB storage device, make sure to end the connection properly to prevent damages to the TV or files.

- 1 Press **●.MENU** to access the quick menus.
- 2 Press the Navigation buttons to scroll to **Eject USB** and press **OK**.
- 3 Disconnect the USB storage device only when the message says that it is safe to remove.

### CAUTION

- Do not turn the TV off or remove a USB storage device while the USB storage device is connected to the TV, as this could result in loss of files or damage to the USB storage device.
- Back up your files saved on a USB storage device frequently, as you may lose or damage the files and this is not covered by the warranty.

### Tips for using USB storage devices

- The TV recognizes only a USB storage device.
- If you connect a USB storage device to the TV through a USB hub, your TV may not recognize the USB storage device.
- The TV may not recognize a USB storage device that requires a special driver.
- The recognition speed of a USB storage device may differ depending on the device.
- Only use a USB storage device which has normal music or image files.
- Use only USB storage devices that are formatted as a FAT 32 or NTFS file system.
- You may need to connect a USB storage device to an external power supply with a power adapter.
- If the TV does not recognize a connected USB storage device, replace the cable and try again. Do not use an excessively long cable.
- The TV does not support some USB storage devices properly.
- You can use a multi-partition (up to 4) USB storage device.
- The file alignment method of a USB storage device is similar to the one of Window XP.
- You cannot create or delete a folder saved in a USB storage device directly on the TV.
- The number of characters for a file name is up to 100 English characters.
- If there are too many folders and files in one folder, it may not operate properly.
- The recommended capacity for a USB external hard disk is 1 TB or less and for a USB storage device is 32 GB or less.
- If a USB external hard disk with the Energy Saving feature does not work, turn the USB external hard disk off and on again to make it work properly. For more information, refer to the user manual of the USB external hard disk.
- The electrostatic can cause USB device's malfunction. In this case, USB Device has to be plugged again.

## Browsing files

Access the photo or music lists to browse files.

- 1 Connect a USB storage device.
- 2 Press Navigation buttons to scroll to **Photo List** or **Music List** and press **OK**.

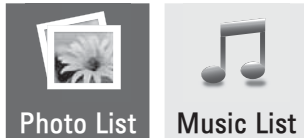

- 3 Select **DriveA** to access the connected USB storage device.
- 4 Press the Navigation buttons to Select a folder/ file you want.

### Tips for using USB storage devices

Type	Supported File Formats
Photo	<ul style="list-style-type: none"> <li>• JPG</li> <li>• Available size Baseline: 64 pixel (W) x 64 pixel (H) - 15360 pixel (W) x 8640 pixel (H) Progressive: 64 pixel (W) x 64 pixel (H) - 1024 pixel (W) x 768 pixel (H) * Do not use the progressive option when saving JPG files on your PC.</li> <li>• It may take some time to open high-resolution images in full screen.</li> </ul>
Music	<ul style="list-style-type: none"> <li>• MP3</li> <li>• Bit rate range 32 Kbps - 320 Kbps</li> <li>• Sampling rate (Sampling Frequency) MPEG1 layer 3: 32 kHz, 44.1 kHz, 48 kHz MPEG2 layer 3: 16 kHz, 22.05 kHz, 24 kHz MPEG2.5 layer 3: 8 kHz, 11.025 kHz, 12 kHz * A copy-protected file will not play.</li> </ul>

ENGLISH

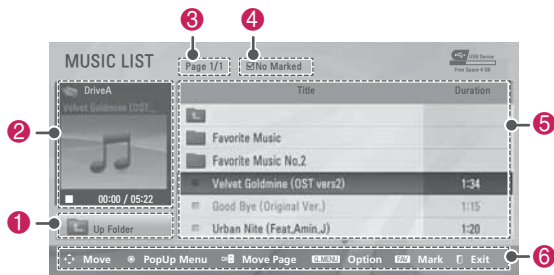
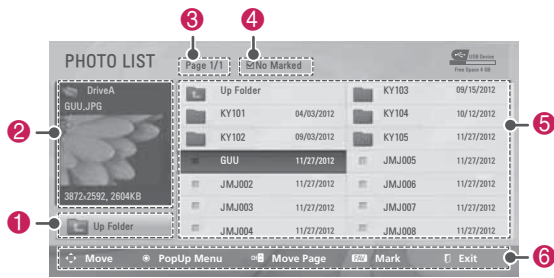

No.	Description
1	Moves to the upper level folder.
2	Preview
3	Current page/Total pages
4	Total number of marked files
5	Contents under the folder focused on 1
6	Available buttons on the remote control



## Viewing Photos

You can view image files saved on a USB storage device. The displays on the screen may differ based on the model.

- 1 Press **SETTINGS** to access the main menus.
- 2 Press the Navigation buttons to scroll to **USB** and press **OK**.
- 3 Press the Navigation buttons to scroll to **Photo List** and press **OK**.
- 4 Select **DriveA** to access the connected USB storage device.
- 5 Press the Navigation buttons to scroll to a folder/file you want and press **OK**.
- 6 View photos by using the following menus/ buttons.

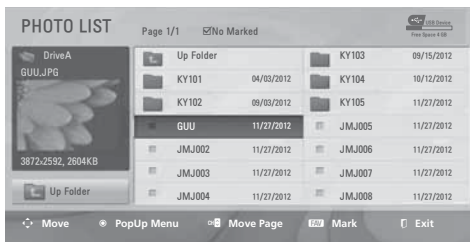

Button	Description
Navigation button	Scrolls through the files.
OK	Views the highlighted file or enters the mark mode.
CH (←, →)	Moves to the previous or next page.
FAV	Enters the mark mode.
Menu	Description
View	Views the selected photo.
Mark All	Selects all files
Unmark All	Clears all of your selections.
Close	Exits the Mark Mode.

**NOTE**

-  : Non-supported files are displayed using this graphic.

- 7 The following options are available while viewing photos.



Option	Description
Slide show	<ul style="list-style-type: none"> <li>• Starts or stops a slideshow with selected photos.</li> <li>• If there are no selected photos, all photos saved in the current folder display during a slideshow.</li> <li>• To set a slideshow speed, select Option.</li> </ul>
BGM (Background Music)	Turns the background music on or off. To set the background music folder, select Option.
⌚ (Rotate)	Rotates photos clockwise. (90°, 180°, 270°, 360°) <div style="border: 1px solid black; padding: 5px; margin-top: 5px;"> <p><b>NOTE</b></p> <ul style="list-style-type: none"> <li>• The supported photo size is limited. You cannot rotate a photo if the resolution of the rotated width is larger than the supported resolution size.</li> </ul> </div>
Hide	Hides the option window. To display the options, press <b>OK</b> .

**NOTE**

- Option values changed in Photo List do not affect Music List.
- Option values changed in Photo List or Music List are changed likewise in Photo List and Music List.

**Q.MENU options for photo list**

- 1 Press **Q.MENU**.  
A pop-up window will appear.
- 2 Press the Navigation buttons to scroll to **Set photo view**, and press **OK**.
- 3 Press the Navigation buttons to scroll to one of the following options and press **OK**.

**Set photo view.**

Option	Description
<b>Slide Speed</b>	Selects a slideshow speed (Fast, Normal, Slow).
<b>Music Folder</b>	Selects a music folder for the background music. <b>NOTE</b> • You can't change the music folder while the background music is playing.

**Set video.**

Allows you to change Video presets.  
(See "PICTURE Settings" on p. 37)

**Set audio.**

Allows you to change Audio presets.  
(See "AUDIO Settings" on p. 40)

ENGLISH

**Listening to music**

- 1 Press **SETTINGS** to access the main menus.
- 2 Press the Navigation buttons to scroll to **USB** and press **OK**.
- 3 Press the Navigation buttons to scroll to **Music List** and press **OK**.
- 4 Select **DriveA** to access the connected USB storage device.
- 5 Press the Navigation buttons to scroll to a folder/file you want and press **OK**.
- 6 Play music by using the following menus/buttons.

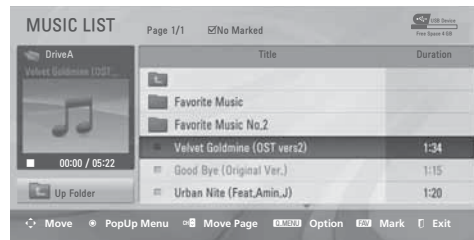

Button	Description
Navigation button	Scrolls through the files.
<b>OK</b>	Views the highlighted file or enters the mark mode.
<b>CH</b> (, )	Moves to the previous or next page.
<b>FAV</b>	Enters the mark mode.
Menu	Description
<b>Play</b>	Plays the selected music file.
<b>Play with Photo</b>	Displays photos during playback.
<b>Mark All</b>	Selects all files.
<b>Unmark All</b>	Clears all of your selections.
<b>Close</b>	Exits the Mark Mode.

**NOTE**

- : Abnormal files are displayed using this graphic.
- : Non-supported files are displayed using this graphic.

7 Control playing by using the following buttons.

Button	Description
■	Stops playback.
▶	Plays a music file.
	Pauses or resumes playback.
◀◀	Skips to the previous file.
▶▶	Skips to the next file.

#### Q.MENU options for music list

- 1 Press **●.MENU**.  
A pop-up window will appear.
- 2 Press the Navigation buttons to scroll to **Set Audio.** and press **OK**.
- 3 Press the Navigation buttons to scroll to one of the following options and press **OK**.

#### ! NOTE

- Option value changed in Photo List and Music List are changed likewise in Photo List and Music List.

#### Set Audio.

Allows you to change Audio presets.  
(See "AUDIO Settings" on p. 40)

#### ! NOTE

- The TV will not play copy protected files.
- If the TV is not in use for some time during playback, the information box as a screensaver will appear to prevent image burn.  
To return to the Music list screen, press **OK** or **↶ BACK**.



## CUSTOMIZING TV SETTINGS

### The Main Menu

- 1 Press **SETTINGS** to access the main menu.
- 2 Press the Navigation buttons to scroll to one of the following menus and press **OK**.
- 3 Press the Navigation buttons to scroll to the setting or option you want and press **OK**.
- 4 When you are finished, press **EXIT**.

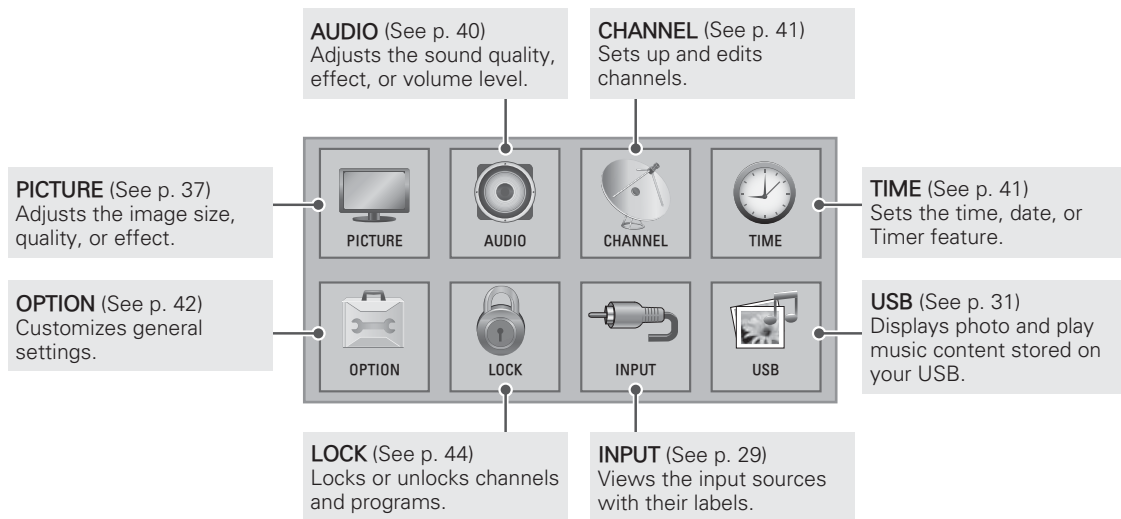

## Customizing Settings

### PICTURE Settings

- 1 Press **SETTINGS** to access the main menus.
- 2 Press the Navigation buttons to scroll to **PICTURE** and press **OK**.
- 3 Press the Navigation buttons to scroll to the setting or option you want and press **OK**.
  - To return to the previous level, press **⇐ BACK**.
- 4 When you are finished, press **EXIT**.

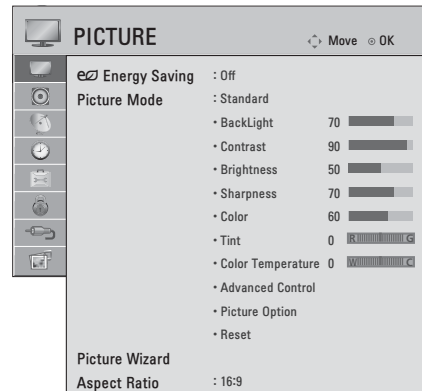

The available picture settings are described in the following.

Setting	Description														
<b>Energy Saving</b>	Reduces the power consumption by adjusting the screen brightness. <div style="border: 1px solid black; padding: 5px; margin-top: 10px;"> <p><b>NOTE</b></p> <ul style="list-style-type: none"> <li>When selecting <b>Auto</b> or <b>Maximum</b>, <b>Backlight</b> will not work.</li> </ul> </div>														
	<b>Option</b>														
	<table border="1" style="width: 100%;"> <tr> <td style="width: 20%;"><b>Auto</b></td> <td>The backlight is adjusted automatically corresponding to the surroundings when selecting <b>Auto</b> using the <b>Intelligent sensor</b> feature.</td> </tr> <tr> <td><b>Off</b></td> <td>Select if this feature is not necessary.</td> </tr> <tr> <td><b>Minimum/ Medium/ Maximum</b></td> <td>Selects the brightness level.</td> </tr> <tr> <td><b>Screen off</b></td> <td>The screen turns off in 3 seconds. Pressing any button of the remote control will turn on the screen again.</td> </tr> </table>	<b>Auto</b>	The backlight is adjusted automatically corresponding to the surroundings when selecting <b>Auto</b> using the <b>Intelligent sensor</b> feature.	<b>Off</b>	Select if this feature is not necessary.	<b>Minimum/ Medium/ Maximum</b>	Selects the brightness level.	<b>Screen off</b>	The screen turns off in 3 seconds. Pressing any button of the remote control will turn on the screen again.						
	<b>Auto</b>	The backlight is adjusted automatically corresponding to the surroundings when selecting <b>Auto</b> using the <b>Intelligent sensor</b> feature.													
	<b>Off</b>	Select if this feature is not necessary.													
<b>Minimum/ Medium/ Maximum</b>	Selects the brightness level.														
<b>Screen off</b>	The screen turns off in 3 seconds. Pressing any button of the remote control will turn on the screen again.														
<b>Picture Mode</b>	Selects one of the preset image or customizes options in each mode for the best TV screen performance. You are also able to customize advanced options of each mode. The available preset picture modes vary depending on the TV.														
	<table border="1" style="width: 100%;"> <tr> <td colspan="2"><b>Mode</b></td> </tr> <tr> <td style="width: 20%;"><b>Vivid</b></td> <td>Adjusts the video image for the retail environment by enhancing the contrast, brightness, color, and sharpness.</td> </tr> <tr> <td><b>Standard</b></td> <td>Adjusts the image for a normal environment.</td> </tr> <tr> <td><b>Eco</b></td> <td>The Energy Saver feature changes settings on the TV to reduce power consumption.</td> </tr> <tr> <td><b>Cinema</b></td> <td>Optimizes the video image for a cinematic look to enjoy movies as if you are in a movie theater.</td> </tr> <tr> <td><b>Game</b></td> <td>Optimizes the video image for fast moving video such as PCs or games.</td> </tr> <tr> <td><b>Expert1 or 2</b></td> <td>Adjusts the detailed video image settings for video experts as well as general viewers.</td> </tr> </table>	<b>Mode</b>		<b>Vivid</b>	Adjusts the video image for the retail environment by enhancing the contrast, brightness, color, and sharpness.	<b>Standard</b>	Adjusts the image for a normal environment.	<b>Eco</b>	The Energy Saver feature changes settings on the TV to reduce power consumption.	<b>Cinema</b>	Optimizes the video image for a cinematic look to enjoy movies as if you are in a movie theater.	<b>Game</b>	Optimizes the video image for fast moving video such as PCs or games.	<b>Expert1 or 2</b>	Adjusts the detailed video image settings for video experts as well as general viewers.
<b>Mode</b>															
<b>Vivid</b>	Adjusts the video image for the retail environment by enhancing the contrast, brightness, color, and sharpness.														
<b>Standard</b>	Adjusts the image for a normal environment.														
<b>Eco</b>	The Energy Saver feature changes settings on the TV to reduce power consumption.														
<b>Cinema</b>	Optimizes the video image for a cinematic look to enjoy movies as if you are in a movie theater.														
<b>Game</b>	Optimizes the video image for fast moving video such as PCs or games.														
<b>Expert1 or 2</b>	Adjusts the detailed video image settings for video experts as well as general viewers.														
<b>Picture Wizard</b>	Adjusts the image quality and calibrates the screen. The customized options will be saved as <b>Expert1</b> in the <b>Picture Mode</b> .														
	<div style="border: 1px solid black; padding: 5px;"> <p><b>NOTE</b></p> <ul style="list-style-type: none"> <li>If you use <b>Picture Wizard</b>, the <b>Energy saving</b> feature will turn off automatically.</li> <li>To reset changes made by <b>Picture Wizard</b>, operate <b>Reset</b> when <b>Picture Mode</b> is on <b>Expert1</b>.</li> </ul> </div>														
<b>Aspect Ratio</b>	Changes the image size to view images at its optimal size. (See p. 28)														

## Basic Image Options

Setting	Description
<b>Backlight</b>	Adjusts the brightness of the screen by controlling the LCD backlight. If you decrease the brightness level, the screen becomes darker and the power consumption will be reduced without any video signal loss.  <div style="border: 1px solid black; padding: 5px;"> <p><b>NOTE</b></p> <ul style="list-style-type: none"> <li>If you use the "Energy saving - Off, Minimum, Medium", Backlight will be available.</li> </ul> </div>
<b>Contrast</b>	Increases or decreases the amplitude of the video signal. You may use Contrast when the bright part of the picture is saturated.
<b>Brightness</b>	Adjusts the base level of the signal in the picture.
<b>Sharpness</b>	Adjusts the level of crispness in the edges between the light and dark areas of the picture. The lower the level, the softer the image.
<b>Color</b>	Adjusts intensity of all colors.
<b>Tint</b>	Adjusts the balance between red and green levels.
<b>Color Temperature</b>	Sets to warm to enhance hotter colors such as red, or set to cool to enhance cooler colors such as blue.
<b>Advanced Control or Expert Control</b>	Customizes the advanced options.
<b>Picture Option</b>	Adjusts detailed setting for images.
<b>Reset</b>	Restores the options of each mode to the factory default.

## Advanced or Expert Image Options (Depending on model)

Setting	Description
<b>Dynamic Contrast</b>	Adjusts the contrast to keep it at the best level according to the brightness of the screen. The picture is improved by making bright parts brighter and dark parts darker.
<b>Dynamic Color</b>	Adjusts screen colors so that they look livelier, richer and clearer. This feature enhances hue, saturation and luminance so that red, blue and green white look more vivid.
<b>Skin Color</b>	Skin color spectrum can be separately set to implement the skin color defined by the user.
<b>Grass Color</b>	Natural color spectrum(meadows, hills, etc.) can be separately set.
<b>Sky Color</b>	Sky color is set separately.
<b>Gamma</b>	Sets the gradation curve according to the output of picture signal in relation to the input signal.
<b>Color Gamut</b>	Displays color domain of the signal. <ul style="list-style-type: none"> <li>Standard: Displays standard set of colors.</li> <li>EBU: Mode to display EBU standard color area.</li> <li>SMPTE: Mode to display SMPTE standard color area.</li> <li>BT709: Mode to display BT709 standard color area.</li> <li>Wide: Increase number of colors used.</li> </ul>
<b>Edge Enhancer</b>	Shows clearer and distinctive yet natural edges of the video. This function works well over Sharpness UI 30 value.
<b>Color Filter</b>	This is the function to filter the specific colors of the video. You can use the RGB filter to set color saturation and hue accurately.

<b>Color Temperature</b>	<p>Adjusts the overall color of the screen by changing the white baseline.</p> <p>a. Gamma : Select Cool, Medium, Warm1, Warm2                  b. Method : 2 Points                  • Pattern: Inner, Outer                  • Points: Low, High                  • Red/Green/Blue: The adjustment range is -50 - +50</p> <p>c. Method : 20 Point IRE                  • Pattern: Inner, Outer                  • IRE (Institute of Radio Engineers) is the unit to display the size of the video signal and can be set among 0, 5, 10, 15 - 100. You can adjust Red, Green or Blue according to each setting.                  • Red/Green/Blue: The adjustment range is -50 - +50.                  d. Apply to all inputs</p>
<b>Color Management System</b>	<p>As the tool used by the experts to make adjustments by using the test patterns, this does not affect other colors but can be used to selectively adjust the 6 color areas (Red/Green/Blue/Cyan/Magenta/Yellow).</p> <p>Color difference may not be distinctive even when you make the adjustments for the general video. Adjusts Red/Green/Blue/Yellow/Cyan/Magenta.                  Red/Green/Blue/Yellow/Cyan/Magenta Saturation: The adjustment range is -30 - +30.                  Red/Green/Blue/Yellow/Cyan/Magenta Tint: The adjustment range is -30 - +30.                  Red/Green/Blue/Yellow/Cyan/Magenta Luminance: The adjustment range is -30 - +30.</p>

**Picture Option (Depending on model)**

Setting	Description
<b>Noise Reduction</b>	Reduces screen noise without compromising video quality.
<b>MPEG Noise Reduction</b>	Reduces noise caused by compressing digital video.
<b>Black Level</b>	<p>Sets black level of the screen to proper level. This function is available in the following modes: TV(NTSC-M/J, PAL-M, PAL-N), AV (NTSC-M/J, PAL-M, PAL-N), HDMI or Component.</p> <ul style="list-style-type: none"> <li>• Auto: Realizing the black level of the screen and set it to High or Low automatically.</li> <li>• Low: The reflection of the screen gets darker.</li> <li>• High: The reflection of the screen gets brighter.</li> </ul>
<b>Real Cinema</b>	Optimizes the screen for movie viewing.
<b>Motion Eye Care</b>	Saves power consumption by adjusting the brightness corresponding to movement in the video.

## AUDIO Settings

- 1 Press **SETTINGS** to access the main menus.
- 2 Press the Navigation buttons to scroll to **AUDIO** and press **OK**.
- 3 Press the Navigation buttons to scroll to the setting or option you want and press **OK**.
  - To return to the previous level, press **⇐ BACK**.
- 4 When you are finished, press **EXIT**.



The available audio settings are described in the following.

Setting	Description																						
<b>Auto Volume</b>	Activates the Auto Volume feature to keep the volume level consistent whenever you change channels. The volume level may not be consistent due to different signal conditions of broadcasting stations.																						
<b>Clear Voice II</b>	Enhances human voice clarity. You can adjust the level of clarity when you set this feature on.																						
<b>Balance</b>	Adjusts balance between the left and right speakers according to your room environment.																						
<b>Sound Mode</b>	Selects one of the preset sound modes or customizes options in each mode. <table border="1" style="width: 100%; margin-top: 5px;"> <thead> <tr> <th colspan="2">Mode</th> </tr> </thead> <tbody> <tr> <td><b>Standard</b></td> <td>Select when you want standard-quality sound.</td> </tr> <tr> <td><b>Music</b></td> <td>Select when you listen to music.</td> </tr> <tr> <td><b>Cinema</b></td> <td>Select when you watch movies.</td> </tr> <tr> <td><b>Sport</b></td> <td>Select when you watch sports events.</td> </tr> <tr> <td><b>Game</b></td> <td>Select when you play games.</td> </tr> </tbody> </table> <div style="border: 1px solid gray; padding: 5px; margin-top: 5px;"> <p><b>NOTE</b></p> <ul style="list-style-type: none"> <li>• If the Clear Voice II feature is on, <b>Virtual Surround</b> will not be activated.</li> </ul> </div> <table border="1" style="width: 100%; margin-top: 5px;"> <thead> <tr> <th colspan="2">Option</th> </tr> </thead> <tbody> <tr> <td><b>Virtual Surround</b></td> <td>Virtual Surround is a patented LG proprietary sound processing technology that produces immersive 5.1 surround sound with just two front speakers.</td> </tr> <tr> <td><b>Treble</b></td> <td>Controls the dominant sounds in the output. When you turn up the treble, it will increase the output to the higher frequency range.</td> </tr> <tr> <td><b>Bass</b></td> <td>Controls the softer sounds in the output. When you turn up the bass, it will increase the output to the lower frequency range.</td> </tr> <tr> <td><b>Reset</b></td> <td>Resets the sound mode to the default setting.</td> </tr> </tbody> </table>	Mode		<b>Standard</b>	Select when you want standard-quality sound.	<b>Music</b>	Select when you listen to music.	<b>Cinema</b>	Select when you watch movies.	<b>Sport</b>	Select when you watch sports events.	<b>Game</b>	Select when you play games.	Option		<b>Virtual Surround</b>	Virtual Surround is a patented LG proprietary sound processing technology that produces immersive 5.1 surround sound with just two front speakers.	<b>Treble</b>	Controls the dominant sounds in the output. When you turn up the treble, it will increase the output to the higher frequency range.	<b>Bass</b>	Controls the softer sounds in the output. When you turn up the bass, it will increase the output to the lower frequency range.	<b>Reset</b>	Resets the sound mode to the default setting.
Mode																							
<b>Standard</b>	Select when you want standard-quality sound.																						
<b>Music</b>	Select when you listen to music.																						
<b>Cinema</b>	Select when you watch movies.																						
<b>Sport</b>	Select when you watch sports events.																						
<b>Game</b>	Select when you play games.																						
Option																							
<b>Virtual Surround</b>	Virtual Surround is a patented LG proprietary sound processing technology that produces immersive 5.1 surround sound with just two front speakers.																						
<b>Treble</b>	Controls the dominant sounds in the output. When you turn up the treble, it will increase the output to the higher frequency range.																						
<b>Bass</b>	Controls the softer sounds in the output. When you turn up the bass, it will increase the output to the lower frequency range.																						
<b>Reset</b>	Resets the sound mode to the default setting.																						
<b>TV Speaker</b>	Turns off the internal speaker of the TV when using an external Hi-Fi system.																						



## CHANNEL Settings

- 1 Press **SETTINGS** to access the main menus.
- 2 Press the Navigation buttons to scroll to **CHANNEL** and press **OK**.
- 3 Press the Navigation buttons to scroll to the setting or option you want and press **OK**.
  - To return to the previous level, press **⇐ BACK**.
- 4 When you are finished, press **EXIT**.

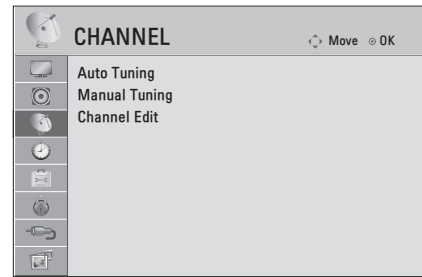

The available channel settings are described in the following.

Setting	Description
<b>Auto Tuning</b>	Tunes and stores all available channels through antennas or cable inputs. (See p. 25)
<b>Manual Tuning</b>	Tunes and stores the channels you want manually. (See p. 25)
<b>Channel Edit</b>	Adds or deletes channels on the channel. (See p. 26)

## TIME Settings

- 1 Press **SETTINGS** to access the main menus.
- 2 Press the Navigation buttons to scroll to **TIME** and press **OK**.
- 3 Press the Navigation buttons to scroll to the setting or option you want and press **OK**.
  - To return to the previous level, press **⇐ BACK**.
- 4 When you are finished, press **EXIT**.

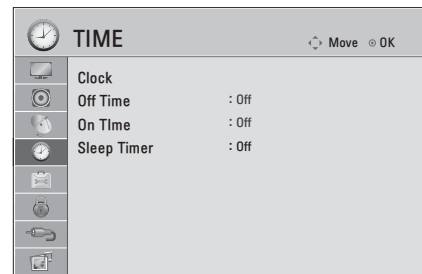

The available time settings are described in the following.

Setting	Description
<b>Clock</b>	Sets the time, date, time zone, and daylight-saving time feature. The time will be set automatically according to a digital channel signal which includes time information provided by the broadcasting station. If not, set the time and date manually.
<b>Off Time / On Time</b>	Sets the time to turn on or off the TV automatically. To use this function, you should set the current time and date in advance. <div style="border: 1px solid black; padding: 5px; margin-top: 10px;"> <p><b>NOTE</b></p> <ul style="list-style-type: none"> <li>If you do not press any button within 2 hours after the TV turns on by the On Time feature, the TV enters the Standby mode automatically.</li> <li>When power is turned on: The power is automatically turned off by the <b>Off Time</b> feature.</li> <li>When power is turned off: The power is automatically turned on by the <b>On Time</b> feature.</li> </ul> </div>
<b>Sleep Timer</b>	Sets the length of time until the TV to turns off. When you turn the TV off and turn it on again, the Sleep timer feature will be set to off.

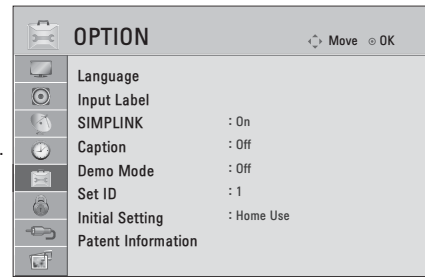

## OPTION Settings

- 1 Press **SETTINGS** to access the main menus.
- 2 Press the Navigation buttons to scroll to **OPTION** and press **OK**.
- 3 Press the Navigation buttons to scroll to the setting or option you want and press **OK**.
  - To return to the previous level, press **⇐ BACK**.
- 4 When you are finished, press **EXIT**.



The available general settings are described in the following.

Setting	Description
<b>Language</b>	Selects a desired language.
	<b>Option</b>
	<b>Menu</b> Selects a language for the display text.
	<b>Audio</b> Selects an audio language for your program. This feature operates only in the DTV or CADTV mode.
<b>Input Label</b>	Indicates which device is connected to which input port.
<b>SIMPLINK</b>	Use the TV remote control to play and control the AV device connected with the HDMI cable through HDMI-CEC.
<b>Caption</b>	Sets whether to display captions and customize your option in each mode.
	<b>Mode</b>
	<b>CC1 - 4 (Closed Captioning)</b> Displays the audio portion of a TV program as text on the TV screen. CC1 is the most common mode in use. - Field 1 data channels: two Captions (CC1, CC2) and two Text (T1, T2). - Field 2 data channels: two Captions (CC3, CC4) and two Text (T3, T4).
	<b>Text1 - 4</b>
	<b>Service1 - 6</b> This is only available for the digital broadcasting system.
	<b>Digital Option (For DTV, CADTV)</b>
	<b>Size</b> Selects the word size.
	<b>Font</b> Selects a typeface for the text.
	<b>Text Color</b> Selects a color for the text.
	<b>Text Opacity</b> Adjusts the opacity for the text color.
	<b>Bg Color</b> Selects a background color.
	<b>Bg Opacity</b> Adjusts the opacity for the background color.
	<b>Edge Type</b> Selects an edge type.
	<b>Edge Color</b> Selects a color for the edges.
<b>Demo Mode</b>	Shows special features of the TV. You can cancel the demo mode by pressing any button.
<b>Set ID</b>	Adds an ID to the connected devices.

<b>Initial Setting</b>	<p>Resets the TV to factory default and erases all stored channels. Customizes the TV settings to suit your preference. The initial setup screen will appear when you turn on the TV for the first time.</p> <p> <b>NOTE</b></p> <ul style="list-style-type: none"> <li>When selecting “<b>Lock System - On</b>” in the <b>LOCK</b> menu, the message to enter the password appears.</li> </ul>
<b>Setting</b>	
<b>Language</b>	Selects a desired language.
<b>Mode Setting</b>	<p>Selects <b>Home Use</b> for the home environment.          Selects <b>Store Demo</b> for the retail environment.          Selects <b>Demo Mode</b> to set to show special features of the TV. You can cancel the demo mode by pressing any buttons.</p> <p> <b>NOTE</b></p> <ul style="list-style-type: none"> <li>When selecting <b>Store Demo, Demo Mode</b> will be activated.</li> </ul>
<b>Time Setting</b>	Sets the time zone and daylight saving.
<b>Auto Tuning</b>	Scans and saves available channels automatically.

## LOCK Settings

- 1 Press **SETTINGS** to access the main menus.
- 2 Press the Navigation buttons to scroll to **LOCK** and press **OK**.
- 3 Press the Navigation buttons to scroll to the setting or option you want and press **OK**.
  - To return to the previous level, press **⇐ BACK**.
- 4 When you are finished, press **EXIT**.

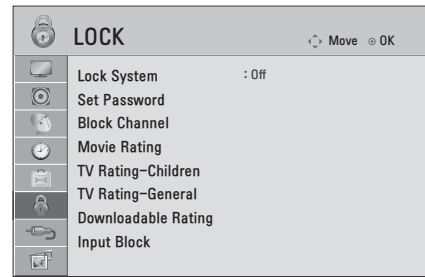

The available lock settings are described in the following.

Setting	Description	
<b>Lock System</b>	Activates or deactivates the lock system.	
<b>Set Password</b>	Changes the 4-digit password. The default PIN is "0 0 0 0".	
<b>Block Channel</b>	Blocks the channels that contain inappropriate content for children by pressing the <b>Blue</b> button. The Lock icon appears in front of the blocked channels. The channels can be selected but the screen is blanked and the audio is muted.	
<b>Movie Rating</b>	Blocks the movies that are only broadcasted on the TV and contain inappropriate contents, based on the Motion Picture Association of America (MPAA) rating.	
	<b>Rating</b>	
	<b>G</b>	General audiences – All ages admitted
	<b>PG</b>	Parental guidance suggested – Some material may not be suitable for children
	<b>PG-13</b>	Parents strongly cautioned – Some material may be inappropriate for children under 13
	<b>R</b>	Restricted – Under 17 requires accompanying parent or adult guardian
	<b>NC-17</b>	No one 17 and under admitted
	<b>X</b>	Adults only
<b>Blocking Off</b>	Permits all programs	
<b>TV Rating-Children</b>	Blocks programs that parents do not want their children to watch. To block other TV programs, you should set the TV Rating-General feature.	
	<b>Rating</b>	
	<b>Age</b>	TV-Y (All children, including children from ages 2-6) TV-Y7 (Directed to older children, suitable for children age 6 and above)
	<b>Fantasy Violence</b>	TY-Y7 (Directed to older children – Fantasy violence, suitable for children age 6 and above, containing more intense or combative fantasy violence)

<p><b>TV Rating-General</b></p>	<p>Blocks the TV programs that you want based on the ratings by using the Parental Control Function (V-Chip).</p> <div style="border: 1px solid black; padding: 5px; margin-top: 10px;"> <p><b>NOTE</b></p> <ul style="list-style-type: none"> <li>The V-Chip electronically reads TV program ratings and allows parents to block programs that are unsuitable for children.</li> </ul> </div> <table border="1" style="width: 100%; border-collapse: collapse;"> <thead> <tr style="background-color: #f2f2f2;"> <th colspan="2" style="text-align: left; padding: 5px;">Rating</th> </tr> </thead> <tbody> <tr> <td style="width: 20%; padding: 5px;"><b>Age</b></td> <td style="padding: 5px;">TV-G (General audience, suitable for all ages) TV-PG (Parental guidance suggested, containing material that are unsuitable for younger children) TV-14 (Parents strongly cautioned, containing material that are unsuitable for children age 14 and under) TV-MA (Mature audience only, unsuitable for children age under 17)</td> </tr> <tr> <td style="padding: 5px;"><b>Dialog (suggestive dialogue)</b></td> <td style="padding: 5px;">TV-PG or TV-14</td> </tr> <tr> <td style="padding: 5px;"><b>Language (coarse language)</b></td> <td style="padding: 5px;">TV-PG, TV-14, or TV-MA</td> </tr> <tr> <td style="padding: 5px;"><b>Sex (sexual situation)</b></td> <td style="padding: 5px;">TV-PG, TV-14, or TV-MA</td> </tr> <tr> <td style="padding: 5px;"><b>Violence</b></td> <td style="padding: 5px;">TV-PG, TV-14, or TV-MA</td> </tr> </tbody> </table>	Rating		<b>Age</b>	TV-G (General audience, suitable for all ages) TV-PG (Parental guidance suggested, containing material that are unsuitable for younger children) TV-14 (Parents strongly cautioned, containing material that are unsuitable for children age 14 and under) TV-MA (Mature audience only, unsuitable for children age under 17)	<b>Dialog (suggestive dialogue)</b>	TV-PG or TV-14	<b>Language (coarse language)</b>	TV-PG, TV-14, or TV-MA	<b>Sex (sexual situation)</b>	TV-PG, TV-14, or TV-MA	<b>Violence</b>	TV-PG, TV-14, or TV-MA
Rating													
<b>Age</b>	TV-G (General audience, suitable for all ages) TV-PG (Parental guidance suggested, containing material that are unsuitable for younger children) TV-14 (Parents strongly cautioned, containing material that are unsuitable for children age 14 and under) TV-MA (Mature audience only, unsuitable for children age under 17)												
<b>Dialog (suggestive dialogue)</b>	TV-PG or TV-14												
<b>Language (coarse language)</b>	TV-PG, TV-14, or TV-MA												
<b>Sex (sexual situation)</b>	TV-PG, TV-14, or TV-MA												
<b>Violence</b>	TV-PG, TV-14, or TV-MA												
<p><b>Downloadable Rating</b></p>	<p>This function operates only when TV has received Region5 Rating data. The name of the rating option may differ.</p> <div style="border: 1px solid black; padding: 5px; margin-top: 10px;"> <p><b>NOTE</b></p> <ul style="list-style-type: none"> <li>This feature is available only for digital channels.</li> </ul> </div>												
<p><b>Input Block</b></p>	<p>Blocks the input sources.</p>												

## MAKING CONNECTIONS

You can connect various external devices to the TV. Supported external devices are: HD receivers, DVD players, VCRs, audio systems, USB storage devices, PC, gaming devices, and other external devices. For more information on external device's connection, refer to the manual provided with each device.

### ! NOTE

- If you record a TV program on a DVD recorder or VCR, make sure to connect the TV signal input cable to the TV through a DVD recorder or VCR. For more information about recording, refer to the manual provided with the connected device.
- The external device connections shown may differ slightly from illustrations in this manual.
- Connect external devices to the TV regardless about the order of the TV port.
- If you connect a gaming device to the TV, use the cable supplied with the gaming device.
- Refer to the external equipment's manual for operating instructions.

### Connecting to an antenna or cable

Connect an antenna, cable, or cable box to watch TV while referring to the following. The illustrations may differ from the actual items and a RF cable is optional.

ENGLISH

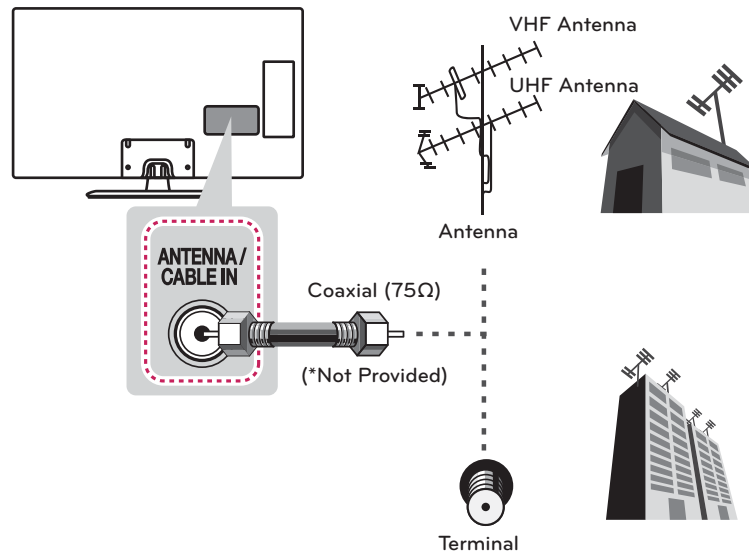

### ! CAUTION

- Make sure not to bend the copper wire of the RF cable.

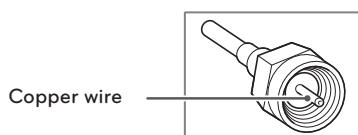

- Complete all connections between devices, and then connect the power cord to the power outlet to prevent damage to your TV.

### ! NOTE

- Use a signal splitter to use more than 2 TVs.
- Visit <http://lgknowledgebase.com> for more information about the antenna and cable connection. Search for antenna.
- DTV Audio Supported Codec: MPEG, Dolby Digital.

## Connection Overview

Connect various external devices to the ports on the TV back panel.

- 1 Find an external device you want to connect to your TV as shown on the following illustration.
- 2 Check the connection type of the external device.
- 3 Go to the appropriate illustration and check the connection details.

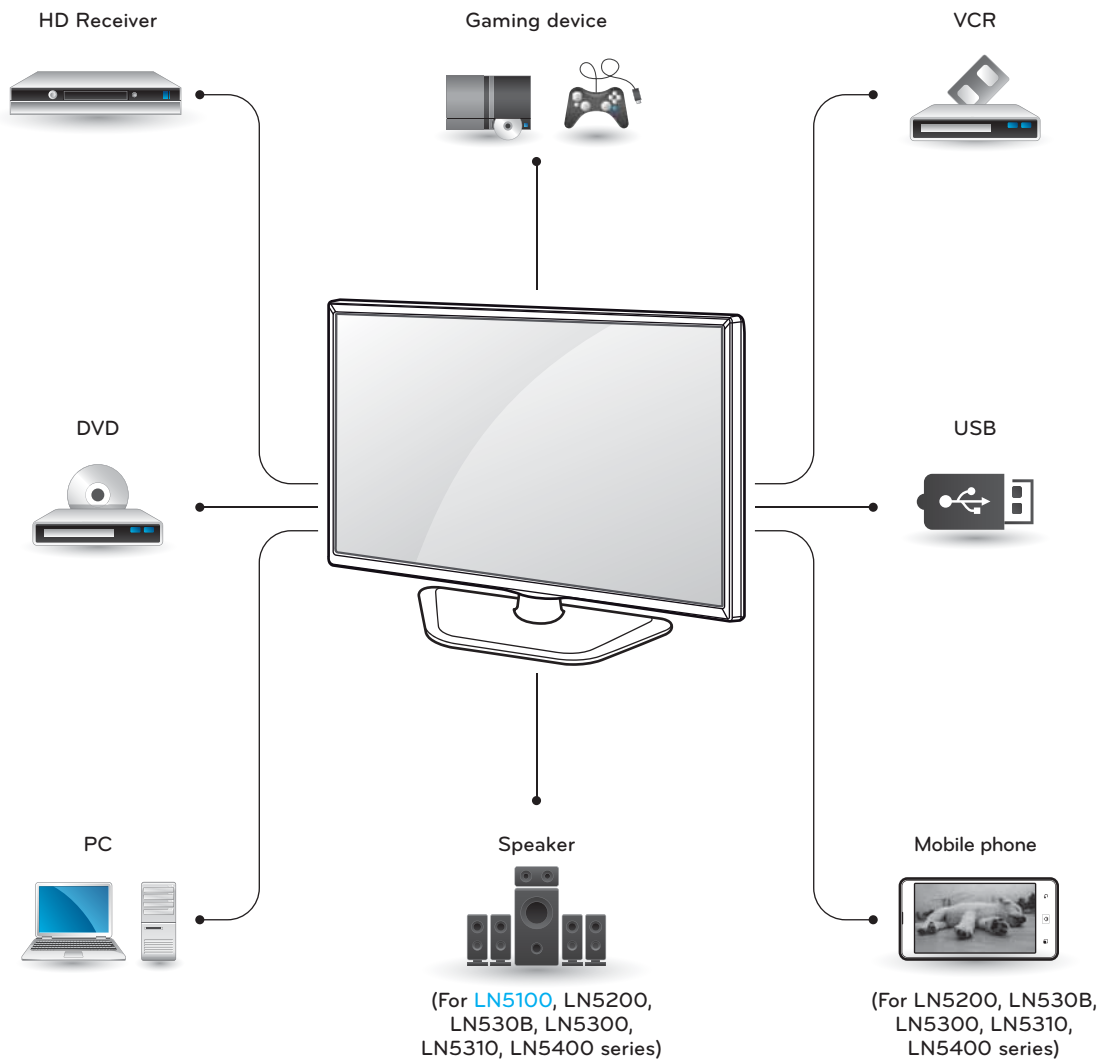

ENGLISH

## Connecting to a HD receiver, DVD Player, or VCR

Connect a HD receiver, DVD Player, or VCR to the TV and select an appropriate input mode.

### HDMI Connection

**HDMI is the best way to connect a device.**

Transmits digital video and audio signals from an external device to the TV. Connect the external device and the TV with the HDMI cable as shown in the following illustration.

**NOTE**

- Use the latest High Speed HDMI™ Cable that supports CEC (Customer Electronics Control) function.
- High Speed HDMI™ Cables are tested to carry an HD signal up to 1080p and higher.
- HDMI Audio Supported Format: Dolby Digital, PCM (Up to 192 kHz, 32 kHz / 44.1 kHz / 48 kHz / 96 kHz / 192 kHz) -> DTS is not supported.

Choose any HDMI input port to connect.  
It does not matter which port you use.

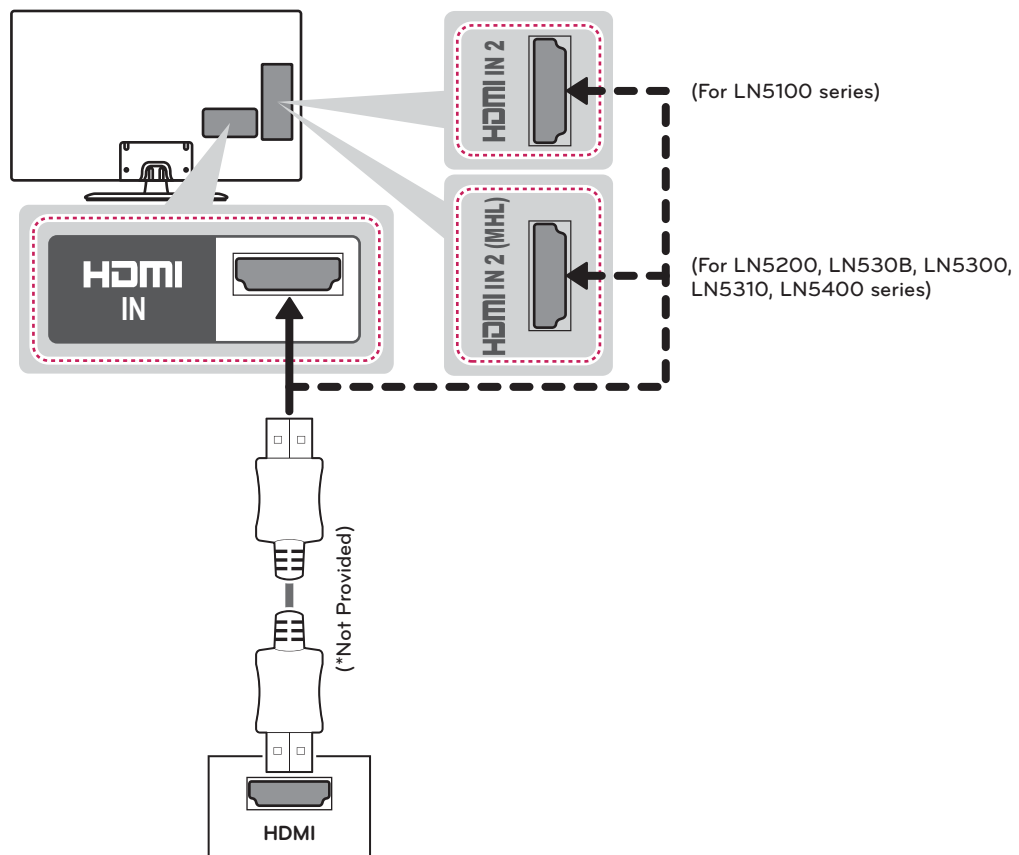

DVD / Blu-Ray / HD Cable Box / HD STB

ENGLISH



## Connecting to a mobile phone

(For LN5200, LN530B, LN5300, LN5310, LN5400 series)

Mobile High-definition Link (MHL) is an interface for transmitting digital audio/visual signals from mobile phones to television sets.

### ! NOTE

- Connect the mobile phone to the HDMI IN 2 (MHL) port to view the phone screen on the TV.
- This only works with an MHL-enabled phones.
- With some MHL supporting mobile phones, you can use the TV remote to control the phone.
- An MHL supported cable is needed to connect the TV and a mobile phone.
- Remove the MHL cable from the TV when:
  - the MHL function is disabled.
  - your mobile device is fully charged in standby mode.

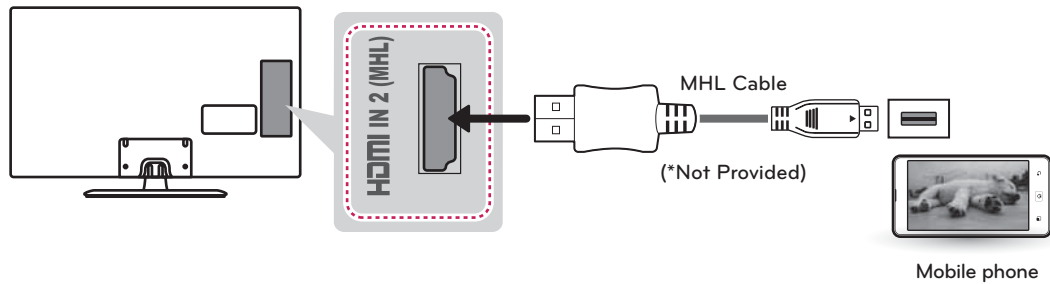

## Component Connection

Transmits analog video and audio signals from an external device to the TV. Connect the external device and the TV with a component cable as shown in the following illustration.

### ! NOTE

- If cables are installed incorrectly, it could cause the image to display in black and white or with distorted color.
- **Check to ensure the cables are matched with the corresponding color connection.**

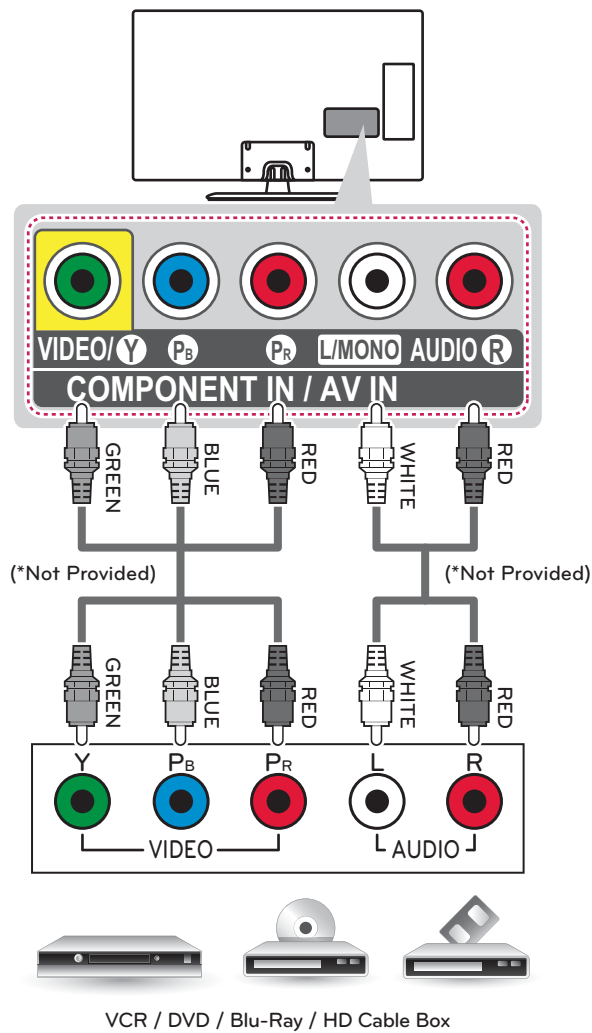

## Composite Connection

Transmits analog video and audio signals from an external device to the TV. Connect the external device and the TV with the composite cable as shown in the following illustration.

**NOTE**

- If you have a mono VCR, connect the audio cable from the VCR to the AUDIO L/MONO jack of the TV.

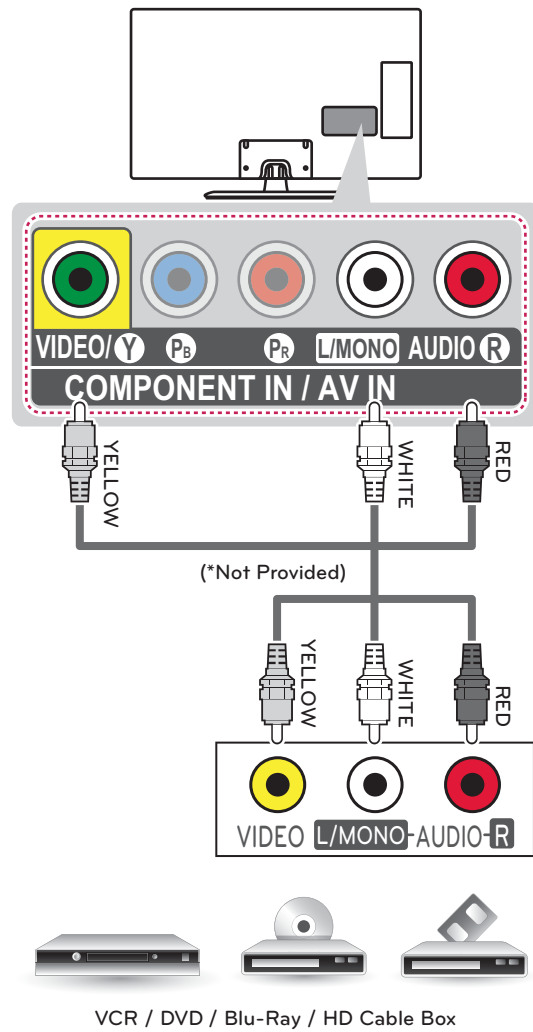

## Connecting a PC

### ! NOTE

- Use an HDMI connection for the best image quality.
- Depending upon the graphics card, DOS mode video may not work if a HDMI to DVI Cable is in use.
- In PC mode, there may be noise associated with the resolution, vertical pattern, contrast, or brightness. If noise is present, change the PC output to another resolution, change the refresh rate to another rate or adjust the brightness and contrast on the PICTURE menu until the picture is clear.
- The synchronization input form for Horizontal and Vertical frequencies is separate.
- Depending on the graphics card, some resolution settings may not allow the image to be positioned on the screen properly.
- If you use DVI to HDMI cable for PC, you have to use external speaker for PC audio sound.

### HDMI Connection

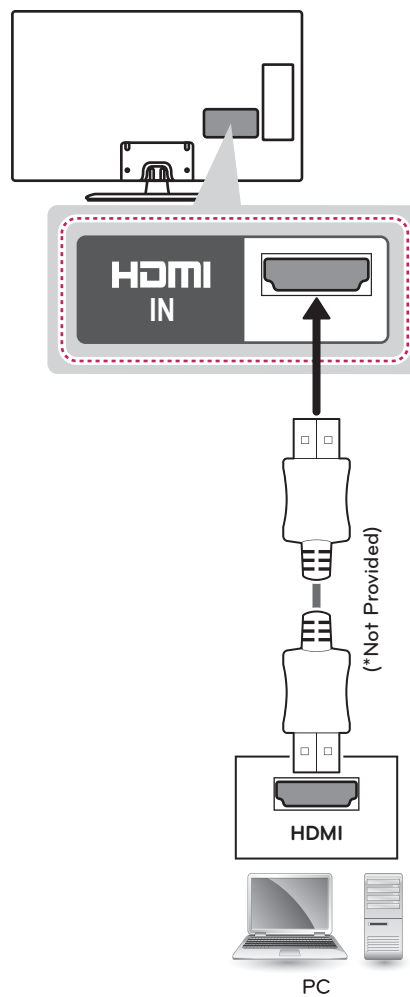

## Connecting to an Audio System

(For LN5100, LN5200, LN530B, LN5300, LN5310, LN5400 series)

You can use an optional external audio system instead of the built-in speaker.

### Digital Optical Audio Connection

Transmits a digital audio signal from the TV to an external device. Connect the external device and the TV with the optical audio cable as shown in the following illustration.

**NOTE**

- Do not look into the optical output port. Looking at the laser beam may damage your vision.
- Audio with ACP (Audio Copy Protection) function may block digital audio output.

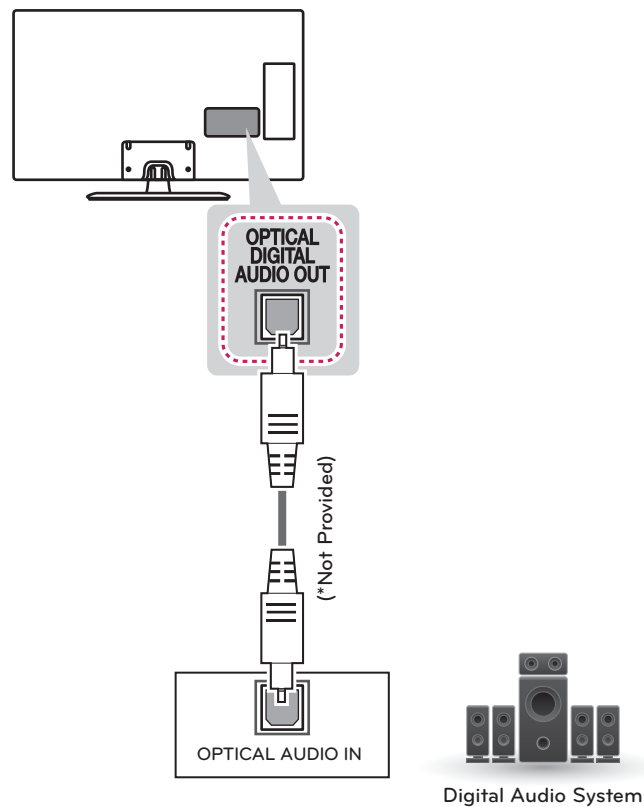

## Connecting a USB Device

Connect a USB storage device such as a USB flash memory, external hard drive, or a USB memory card reader to the TV.

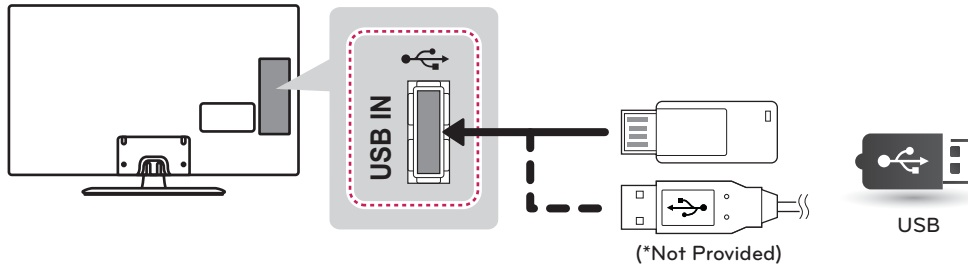

## SIMPLINK Connection

Use the TV remote control to play and control the AV device connected with the HDMI cable through HDMI-CEC. Your TV only works with the devices that support HDMI-CEC. But only devices with the SIMPLINK logo are supported.

Connect one end of the HDMI cable to the HDMI IN terminal on the rear of the TV and the other end to the SIMPLINK device.

**NOTE**

- If the connected device does not support HDMI-CEC, the SIMPLINK feature is unavailable.
- To operate SIMPLINK, you should use a High Speed HDMI cable that supports CEC (Consumer Electronics Control) function.
- SIMPLINK may not work properly if you a third-party device that has an HDMI-CEC function.

## Activating and Using the SIMPLINK menus

- 1 Press **SIMPLINK** to access the SIMPLINK menus.
- 2 Press the Navigation buttons to scroll to one of the devices and press **OK**.

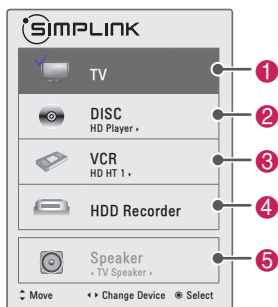

No.	Description
1	Displays the previously viewed TV channel.
2	Plays discs. When multiple discs are available, the title of the disc appears at the bottom of the screen.
3	Controls the connected VCR.
4	HDD recordings playback: Controls the recording stored in HDD.
5	Changes the audio output between Home theater speaker and TV speaker for the connected HTS only.

- A check mark appears in front of the selected device.
- Available devices display in a bright color.
- Unavailable devices display in grey.

**3** Control the selected AV device.

- Direct Play: After connecting AV devices to the TV, you can directly control the devices and play media without additional settings.
- Select AV device: Enables you to select one of the AV devices connected to the TV.
- Disc playback: Control connected AV devices by pressing the Navigation buttons, **OK**, **▶**, **■**, **⏮**, **◀** and **▶▶**.
- Power off all devices: When you power off the TV, all connected devices are turned off.
- Switch audio-out: Offers an easy way to switch audio-out. (HTS only)
- Sync Power on: When the equipment with SIMPLINK function connected HDMI terminal starts to play, The TV will automatically turn on.

**NOTE**

- If you change the input source by pressing **INPUT**, the progressing function of the SIMPLINK device will stop.
- If you select a device that has the home theater feature, the sound output automatically switches to the home theater speaker and the TV speaker turns off.
- If a connected SIMPLINK home theater system does not play the audio from the TV, connect the DIGITAL AUDIO OUT terminal on the rear of the TV to the DIGITAL AUDIO IN terminal on the back of the SIMPLINK device with an optical cable. (For LN5100, LN5200, LN530B, LN5300, LN5310, LN5400 series)

## MAINTENANCE

### Cleaning Your TV

Clean your TV regularly to keep it at peak performance and to extend the product lifespan.

 **CAUTION**

- Before cleaning, turn the power off and disconnect the power cord and all other cables.
- When the TV is left unattended or unused for a long time, disconnect the power cord from the wall outlet to prevent possible damage from lightning or power surges.

### Screen, frame, cabinet, and stand

To remove dust or light dirt, wipe the surface with a dry, clean, and soft cloth.

To remove major dirt, wipe the surface with a soft cloth dampened in clean water or a diluted mild detergent. Then wipe immediately with a dry cloth.

 **CAUTION**

- Do not push, rub, or hit the surface with your fingernail or a sharp object, as this may result in scratches on the screen and image distortions.
- Do not use any chemicals, such as waxes, benzene, alcohol, thinners, insecticides, air fresheners, or lubricants, as these may damage the screen's finish and cause discoloration.
- Do not spray liquid onto the surface. If water enters the TV, it may result in fire, electric shock, or malfunction.

### Power cord

Remove the accumulated dust or dirt on the power cord regularly.



# TROUBLESHOOTING

## General

Problem	Solution
Cannot control the TV with the remote control.	<ul style="list-style-type: none"> <li>• Check the remote control sensor on the product and try again.</li> <li>• Check if there is any obstacle between the product and the remote control.</li> <li>• Check if the batteries are still working and properly installed (⊕ to ⊕, ⊖ to ⊖).</li> </ul>
No image display and no sound is produced.	<ul style="list-style-type: none"> <li>• Check if the product is turned on.</li> <li>• Check if the power cord is connected to a wall outlet.</li> <li>• Check if there is a problem in the wall outlet by connecting other products.</li> </ul>
Image appears slowly when the TV turns on.	<ul style="list-style-type: none"> <li>• The image is muted during the product startup process. This is normal. If the image does not appear in a few minutes, unplug the TV for 30 seconds and try again. If the image still does not appear, contact the authorized service center in your local area.</li> </ul>
Cannot connect external devices.	<ul style="list-style-type: none"> <li>• Refer to the <b>Connection Overview</b> and connect an external device.</li> </ul>
The TV turns off suddenly.	<ul style="list-style-type: none"> <li>• Check the power control settings. The power supply may be interrupted.</li> <li>• Check if the Auto sleep feature is activated in the Time settings. Refer to the <b>Sleep Timer</b>.</li> <li>• If there is no signal while the TV is on, the TV will turn off automatically after 15 minutes of inactivity. (Depending on model)</li> </ul>

## Audio

Problem	Solution
No sound is produced while images are displaying.	<ul style="list-style-type: none"> <li>• Press <b>VOL +</b> or <b>–</b> button.</li> <li>• Check if the sound is muted by pressing <b>MUTE</b>.</li> <li>• Scroll to other channels. There may a problem with the broadcast.</li> <li>• Check if the TV Speaker feature is activated in the menu option.</li> </ul>
No output from one of the speakers	<ul style="list-style-type: none"> <li>• Adjust Balance in the menu option.</li> </ul>
Unusual sound from inside the TV is produced.	<ul style="list-style-type: none"> <li>• A change in ambient humidity or temperature may result in an unusual noise when the product turns on or off. There is no problem with your product.</li> </ul>

## Video

Problem	Solution
An image displays in black and white or the color quality is poor.	<ul style="list-style-type: none"> <li>• Adjust the color setting in the menu option.</li> <li>• Keep a sufficient distance between this product and other electronic products.</li> <li>• Scroll to other channels. There may a problem with the broadcast.</li> </ul>
Horizontal or vertical bars appears or images blur	<ul style="list-style-type: none"> <li>• Check if there are local interferences such as an electrical appliance or power tool.</li> </ul>
Lines or streaks appear on images	<ul style="list-style-type: none"> <li>• Check the antenna or aim the antenna to the proper direction.</li> </ul>
Afterimages (ghosts) appear when the product turns off	<ul style="list-style-type: none"> <li>• Pixels may have been damaged from a fixed image displayed for a long time (image burn). Use a screen saver to prevent the pixel damage on the screen.</li> </ul>
The power is on but the screen appears extremely dark.	<ul style="list-style-type: none"> <li>• Adjust the brightness and contrast in the menu option.</li> </ul>
"No Signal" appears on the screen.	<ul style="list-style-type: none"> <li>• Check if the signal cable is connected between the TV and products properly.</li> <li>• Check the selected input source by pressing <b>INPUT</b>.</li> </ul>
Black spots appear on the screen.	<ul style="list-style-type: none"> <li>• Several pixels in red, green, white, or black may appear on the screen that can attribute to the characteristics of the panel.</li> <li>• This is normal.</li> </ul>
The display offset is wrong.	<ul style="list-style-type: none"> <li>• Adjust the position setting in the Picture menu.</li> <li>• Check if the video card resolution and frequency are supported by the product. If the frequency is out of range, set to the recommended resolution using the display settings on the external device.</li> </ul>
Thin lines appear in the background of the screen.	<ul style="list-style-type: none"> <li>• Check the video cable connections.</li> </ul>
The reception on some channels is poor	<ul style="list-style-type: none"> <li>• Scroll to other channels. There may a problem with the broadcast.</li> <li>• The station signal may be weak. Aim the antenna to the proper direction.</li> <li>• Check if there is local interferences such as an electrical appliance or power tool.</li> </ul>

## EXTERNAL CONTROL DEVICE SETUP

To obtain the external control device setup information, please visit [www.lg.com](http://www.lg.com).

# SPECIFICATIONS

Product specifications may be changed without prior notice due to upgrade of product functions.

<b>Power requirement</b>	AC 100 - 240 V ~ 50 / 60 Hz	
<b>Television System</b>	NTSC-M, ATSC, 64 & 256 QAM	
<b>Program Coverage</b>	VHF 2-13, UHF 14-69, CATV 1-135, DTV 2-69, CADTV 1-135	
<b>External Antenna Impedance</b>	75 $\Omega$	
<b>Environment condition</b>	Operating Temperature	0 °C ~ 40 °C (32 °F ~ 104 °F)
	Operating Humidity	Less than 80 %
	Storage Temperature	-20 °C ~ 60 °C (-4 °F ~ 140 °F)
	Storage Humidity	Less than 85 %

MODELS		32LN530B (32LN530B-UA)	39LN5300 (39LN5300-UB)
		32LN5300 (32LN5300-UB)	
Dimensions (W x H x D)		32LN5310 (32LN5310-UB)	
		32LN536B (32LN536B-UB)	
Dimensions (W x H x D)	With stand	738 x 497 x 207 (mm)	894 x 587 x 236 (mm)
		29.0 x 19.5 x 8.1 (inches)	35.1 x 23.1 x 9.2 (inches)
	Without stand	738 x 449 x 79 (mm)	894 x 537 x 79.0 (mm)
		29.0 x 17.6 x 3.1 (inches)	35.1 x 21.1 x 3.1 (inches)
Weight	With stand	7.0 kg (15.4 lbs)	9.7 kg (21.3 lbs)
	Without stand	6.4 kg (14.1 lbs)	8.6 kg (18.9 lbs)
Current Value / Power consumption		1.3 A / 80 W	1.5 A / 100 W

MODELS		42LN5300 (42LN5300-UB)
Dimensions (W x H x D)	With stand	968 x 629 x 236 (mm)
		38.1 x 24.7 x 9.2 (inches)
	Without stand	968 x 579 x 79 (mm)
		38.1 x 22.7 x 3.1 (inches)
Weight	With stand	10.7 kg (23.5 lbs)
	Without stand	9.6 kg (21.1 lbs)
Current Value / Power consumption		1.6 A / 110 W

MODELS		42LN5400 (42LN5400-UA)	47LN5200 (47LN5200-UB)
			47LN5310 (47LN5310-UB)
			47LN5400 (47LN5400-UA)
Dimensions (W x H x D)	With stand	968 x 629 x 236 (mm)	1,080 x 694 x 264 (mm)
		38.1 x 24.7 x 9.2 (inches)	42.5 x 27.3 x 10.3 (inches)
	Without stand	968 x 579 x 79 (mm)	1,080 x 642 x 80.5 (mm)
		38.1 x 22.7 x 3.1 (inches)	42.5 x 25.2 x 3.1 (inches)
Weight	With stand	10.7 kg (23.5 lbs)	14.7 kg (32.4 lbs)
	Without stand	9.6 kg (21.1 lbs)	13.4 kg (29.5 lbs)
Current Value / Power consumption		1.1 A / 110 W	1.3 A / 130 W

MODELS		50LN5100 (50LN5100-UB)	55LN5100 (55LN5100-UB)
		50LN5200 (50LN5200-UB)	55LN5200 (55LN5200-UB)
		50LN5310 (50LN5310-UB)	55LN5310 (55LN5310-UB)
		50LN5400 (50LN5400-UA)	55LN5400 (55LN5400-UA)
Dimensions (W x H x D)	With stand	1,136 x 727 x 264 (mm)	1,250 x 790 x 297 (mm)
		44.7 x 28.6 x 10.3 (inches)	49.2 x 31.1 x 11.6 (inches)
	Without stand	1,136 x 673 x 82.1 (mm)	1,250 x 737 x 79.1 (mm)
		44.7 x 26.4 x 3.2 (inches)	49.2 x 29.0 x 3.1 (inches)
Weight	With stand	15.6 kg (34.3 lbs)	21.2 kg (46.7 lbs)
	Without stand	14.2 kg (31.3 lbs)	19.1 kg (42.1 lbs)
Current Value / Power consumption		1.4 A / 140 W	1.6 A / 160 W

**HDMI (PC) supported mode**

Resolution	Horizontal Frequency (kHz)	Vertical Frequency (Hz)
640 x 350	31.468	70.09
720 x 400	31.469	70.08
640 x 480	31.469	59.94
800 x 600	37.879	60.31
1024 x 768	48.363	60.00
1360 x 768	47.712	60.015
1152 x 864	54.348	60.053
1280 x 1024	63.981	60.02
1920 x 1080	67.50	60.00

For [50/55LN5100](#), 47/50/55LN5200, 32/39/42LN5300, 32/47/50/55LN5310, 42/47/50/55LN5400

**HDMI (DTV) supported mode**

Resolution	Horizontal Frequency (kHz)	Vertical Frequency (Hz)
720 x 480p	31.47	59.94
	31.50	60.00
1280 x 720p	44.96	59.94
	45.00	60.00
1920 x 1080i	33.72	59.94
	33.75	60.00
1920 x 1080p	26.97	23.976
	27.00	24.00
	33.71	29.97
	33.75	30.00
	67.432	59.94
	67.50	60.00

**Component port connecting information**

Component ports on the TV	Y	P <sub>B</sub>	P <sub>R</sub>
---------------------------	---	----------------	----------------

Video output ports on DVD player	Y	P <sub>B</sub>	P <sub>R</sub>
	Y	B-Y	R-Y
	Y	Cb	Cr
	Y	Pb	Pr

**Component supported mode**

Resolution	Horizontal Frequency (kHz)	Vertical Frequency (Hz)
720 x 480i	15.73	59.94
	15.73	60.00
720 x 480p	31.47	59.94
	31.50	60.00
1280 x 720p	44.96	59.94
	45.00	60.00
1920 x 1080i	33.72	59.94
	33.75	60.00
1920 x 1080p	26.97	23.94
	27.00	24.00
	33.71	29.97
	33.75	30.00
	67.432	59.94
	67.50	60.00



The model and serial numbers of the TV are located on the back and one side of the TV. Record them below should you ever need service.

MODEL \_\_\_\_\_

SERIAL \_\_\_\_\_