



## QUICK REFERENCE GUIDE

# LED TV\*

\* LG LED TV applies LCD screen with LED backlights.

Please read this manual carefully before operating your set and retain it for future reference.

32LP645H    32LP620H  
39LP645H    39LP620H  
42LP645H    42LP620H  
47LP645H  
55LP645H  
60LP645H

## IMPORTANT SAFETY INSTRUCTIONS

Always comply with the following precautions to avoid dangerous situations and ensure peak performance of your product.





**WARNING/CAUTION**

**RISK OF ELECTRIC SHOCK  
DO NOT OPEN**





TO REDUCE THE RISK OF ELECTRIC SHOCK DO NOT REMOVE COVER (OR BACK). NO USER SERVICEABLE PARTS INSIDE. REFER TO QUALIFIED SERVICE PERSONNEL.

 The lightning flash with arrowhead symbol, within an equilateral triangle, is intended to alert the user to the presence of uninsulated "dangerous voltage" within the product's enclosure that may be of sufficient magnitude to constitute a risk of electric shock to persons.

 The exclamation point within an equilateral triangle is intended to alert the user to the presence of important operating and maintenance (servicing) instructions in the literature accompanying the appliance.

**WARNING/CAUTION**  
- TO REDUCE THE RISK OF FIRE AND ELECTRIC SHOCK, DO NOT EXPOSE THIS PRODUCT TO RAIN OR MOISTURE.

 **WARNING**  
If you ignore the warning message, you may be seriously injured or there is a possibility of accident or death.

 **CAUTION**  
If you ignore the caution message, you may be slightly injured or the product may be damaged.

 **NOTE**  
The note helps you understand and use the product safely. Please read the note carefully before using the product.

Read these instructions.  
Keep these instructions.  
Heed all warnings.  
Follow all instructions.



- Do not use this apparatus near water.



- Clean only with a dry cloth.



- Do not block any ventilation openings. Install in accordance with the manufacturer's instructions.



- Do not install near any heat sources such as radiators, heat registers, stoves, or other apparatus (including amplifiers) that produce heat.



- Do not defeat the safety purpose of the polarized or grounding-type plug. A polarized plug has two blades with one wider than the other. A grounding type plug has two blades and a third grounding prong. The wide blade or the third prong are provided for your safety. If the provided plug does not fit into your outlet, consult an electrician for replacement of the obsolete outlet (Can differ by country).



- Do not press strongly upon the panel with a hand or a sharp object such as a nail, pencil or pen, or make a scratch on it.



**WARNING:** This product contains chemicals known to the State of California to cause cancer and birth defects or other reproductive harm.

*Wash hands after handling.*

- Protect the power cord from being walked on or pinched particularly at plugs, convenience receptacles, and the point where they exit from the apparatus.



- Only use attachments/accessories specified by the manufacturer.



- Use only with a cart, stand, tripod, bracket, or table specified by the manufacturer, or sold with the apparatus. When a cart is used, use caution when moving the cart/apparatus combination to avoid injury from tip-over.



- Unplug this apparatus during lightning storms or when unused for long periods of time.

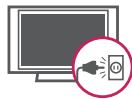

- Refer all servicing to qualified service personnel. Servicing is required when the apparatus has been damaged in any way, such as power-supply cord or plug is damaged, liquid has been spilled or objects have fallen into the apparatus, the apparatus has been exposed to rain or moisture, does not operate normally, or has been dropped.



- Do not stick metal objects or any other conductive material into the power cord. Do not touch the end of the power cord while it is plugged in.
- Keep the packing anti-moisture material or vinyl packing out of the reach of children. Anti-moisture material is harmful if swallowed. If swallowed by mistake, force the patient to vomit and visit the nearest hospital. Additionally, vinyl packing can cause suffocation. Keep it out of the reach of children.

- CAUTION concerning the Power Cord (Can differ by country):

It is recommended that appliances be placed upon a dedicated circuit; that is, a single outlet circuit which powers only that appliance and has no additional outlets or branch circuits. Check the specification page of this owner's manual to be certain. Do not connect too many appliances to the same AC power outlet as this could result in fire or electric shock. Do not overload wall outlets. Overloaded wall outlets, loose or damaged wall outlets, extension cords, frayed power cords, or damaged or cracked wire insulation are dangerous. Any of these conditions could result in electric shock or fire. Periodically examine the cord of your appliance, and if its appearance indicates damage or deterioration, unplug it, discontinue use of the appliance, and have the cord replaced with an exact replacement part by an authorized service. Protect the power cord from physical or mechanical abuse, such as being twisted, kinked, pinched, closed in a door, or walked upon. Pay particular attention to plugs, wall outlets, and the point where the cord exits the appliance. Do not move the TV with the power cord plugged in. Do not use a damaged or loose power cord. Be sure to grasp the plug when unplugging the power cord. Do not pull on the power cord to unplug the TV.



- **Warning** - To reduce the risk of fire or electrical shock, do not expose this product to rain, moisture or other liquids. Do not touch the TV with wet hands. Do not install this product near flammable objects such as gasoline or candles, or expose the TV to direct air conditioning.



- Do not expose to dripping or splashing and do not place objects filled with liquids, such as vases, cups, etc. on or over the apparatus (e.g. on shelves above the unit).



• **Grounding**

(Except for devices which are not grounded.) Ensure that you connect the earth ground wire to prevent possible electric shock (i.e. a TV with a three-prong grounded AC plug must be connected to a three-prong grounded AC outlet). If grounding methods are not possible, have a qualified electrician install a separate circuit breaker. Do not try to ground the unit by connecting it to telephone wires, lightening rods, or gas pipes.

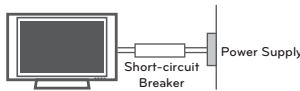

- As long as this unit is connected to the AC wall outlet, it is not disconnected from the AC power source even if the unit is turned off.
- Do not attempt to modify this product in any way without written authorization from LG Electronics. Unauthorized modification could void the user's authority to operate this product.
- **Outdoor Antenna Grounding** (Can differ by country): If an outdoor antenna is installed, follow the precautions below. An outdoor antenna system should not be located in the vicinity of overhead power lines or other electric light or power circuits, or where it can come in contact with such power lines or circuits as death or serious injury can occur. Be sure the antenna system is grounded so as to provide some protection against voltage surges and built-up static charges. Section 810 of the National Electrical Code (NEC) in the U.S.A. provides information with respect to proper grounding of the mast and supporting structure, grounding of the lead-in wire to an antenna discharge unit, size of grounding conductors, location of antenna discharge unit, connection to grounding electrodes and requirements for the grounding electrode.

**Antenna grounding according to the National Electrical Code, ANSI/NFPA 70**

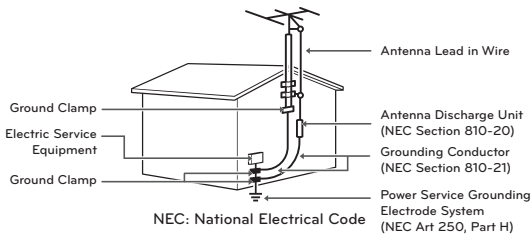

• **Cleaning**

When cleaning, unplug the power cord and wipe gently with a soft cloth to prevent scratching. Do not spray water or other liquids directly on the TV as electric shock may occur. Do not clean with chemicals such as alcohol, thinners or benzene.

• **Moving**

Make sure the product is turned off, unplugged and all cables have been removed. It may take 2 or more people to carry larger TVs. Do not press or put stress on the front panel of the TV.

• **Ventilation**

Install your TV where there is proper ventilation. Do not install in a confined space such as a bookcase. Do not cover the product with cloth or other materials while plugged. Do not install in excessively dusty places.

- If you smell smoke or other odors coming from the TV, unplug the power cord and contact an authorized service center.
- Keep the product away from direct sunlight.
- Never touch this apparatus or antenna during a thunder or lightning storm.
- When mounting a TV on the wall, make sure not to install the TV by hanging the power and signal cables on the back of the TV.
- Do not allow an impact shock or any objects to fall into the product, and do not drop anything onto the screen.
- **Disconnecting the Main Power**  
The power outlet used with this device must remain easily accessible.
- Store the accessories (battery, etc.) in a safe location out of the reach of children.
- This apparatus use batteries. In your community there might be regulations that require you to dispose of these batteries properly due to environmental considerations. Please contact your local authorities for disposal or recycling information.
- Do not dispose of batteries in a fire.
- Do not short circuit, disassemble or allow the batteries to overheat.

**• Dot Defect**

The Plasma or LCD panel is a high technology product with resolution of two million to six million pixels. In a very few cases, you could see fine dots on the screen while you're viewing the TV. Those dots are deactivated pixels and do not affect the performance and reliability of the TV.

**• Generated Sound**

**"Cracking" noise:** A cracking noise that occurs when watching or turning off the TV is generated by plastic thermal contraction due to temperature and humidity. This noise is common for products where thermal deformation is required.

**Electrical circuit humming/panel buzzing:** A low level noise is generated from a high-speed switching circuit, which supplies a large amount of current to operate a product. It varies depending on the product.

This generated sound does not affect the performance and reliability of the product.

- Take care not to touch the ventilation openings. When watching the TV for a long period, the ventilation openings may become hot. This does not affect the performance of the product or cause defects in the product.
- If the TV feels cold to the touch, there may be a small "flicker" when it is turned on. This is normal, there is nothing wrong with TV. Some minute dot defects may be visible on the screen, appearing as tiny red, green, or blue spots. However, they have no adverse effect on the TV's performance. Avoid touching the LCD screen or holding your finger(s) against it for long periods of time. Doing so may produce some temporary distortion effects on the screen.

**Preventing "Image burn" or "Burn-in" on your TV screen**

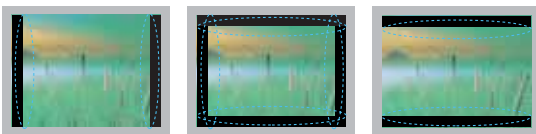

- If a fixed image displays on the TV screen for a long period of time, it will be imprinted and become a permanent disfigurement on the screen. This is "image burn" or "burn-in" and not covered by the warranty.
- If the aspect ratio of the TV is set to 4:3 for a long period of time, image burn may occur on the letterboxed area of the screen.
- Avoid displaying a fixed image on the TV screen for a long period of time (2 or more hours for LCD, 1 or more hours for the Plasma TV) to prevent image burn.

**For USA and Canada**

**FCC NOTICE**

This equipment has been tested and found to comply with the limits for a Class B digital device, pursuant to Part 15 of the FCC Rules. These limits are designed to provide reasonable protection against harmful interference in a residential installation. This equipment generates, uses and can radiate radio frequency energy and, if not installed and used in accordance with the instructions, may cause harmful interference to radio communications. However, there is no guarantee that interference will not occur in a particular installation. If this equipment does cause harmful interference to radio or television reception, which can be determined by turning the equipment off and on, the user is encouraged to try to correct the interference by one or more of the following measures:

- Reorient or relocate the receiving antenna.
- Increase the separation between the equipment and the receiver.
- Connect the equipment to an outlet on a circuit different from that to which the receiver is connected.
- Consult the dealer or an experienced radio/TV technician for help.

This device complies with part 15 of the FCC Rules. Operation is subject to the following two conditions: (1) this device may not cause harmful interference and (2) this device must accept any interference received, including interference that may cause undesired operation of the device.

Any changes or modifications in construction of this device which are not expressly approved by the party responsible for compliance could void the user's authority to operate the equipment.

**NOTE TO CABLE/TV INSTALLER**

This reminder is provided to call the CATV system installer's attention to Article 820-40 of the National Electric Code (U.S.A.). The code provides guidelines for proper grounding and, in particular, specifies that the cable ground shall be connected to the grounding system of the building, as close to the point of the cable entry as practical.

## LICENSES

Supported licenses may differ by model. For more information about licenses, visit '[www.lg.com](http://www.lg.com)'.



Manufactured under license from Dolby Laboratories.  
"Dolby" and the double-D symbol are trademarks of Dolby Laboratories.



The terms HDMI and HDMI High-Definition Multimedia Interface, and the HDMI logo are trademarks or registered trademarks of HDMI Licensing LLC in the United States and other countries.



ABOUT DIVX VIDEO: DivX<sup>®</sup> is a digital video format created by DivX, LLC, a subsidiary of Rovi Corporation. This is an official DivX Certified<sup>®</sup> device that plays DivX video. Visit [divx.com](http://divx.com) for more information and software tools to convert your files into DivX video.

ABOUT DIVX VIDEO-ON-DEMAND: This DivX Certified<sup>®</sup> device must be registered in order to play purchased DivX Video-on-Demand (VOD) movies. To obtain your registration code, locate the DivX VOD section in your device setup menu. Go to [vod.divx.com](http://vod.divx.com) for more information on how to complete your registration.

"DivX Certified<sup>®</sup> to play DivX<sup>®</sup> video up to HD 1080p, including premium content."

"DivX<sup>®</sup>, DivX Certified<sup>®</sup> and associated logos are trademarks of Rovi Corporation or its subsidiaries and are used under license."

"Covered by one or more of the following U.S. patents:  
7,295,673; 7,460,668; 7,515,710; 7,519,274"

ENGLISH

## OPEN SOURCE SOFTWARE NOTICE

To obtain the source code under GPL, LGPL, MPL and other open source licenses, that is contained in this product, please visit '<http://opensource.lge.com>'.

In addition to the source code, all referred license terms, warranty disclaimers and copyright notices are available for download.

LG Electronics will also provide open source code to you on CD-ROM for a charge covering the cost of performing such distribution (such as the cost of media, shipping and handling) upon email request to '[opensource@lge.com](mailto:opensource@lge.com)'. This offer is valid for three (3) years from the date on which you purchased the product.

# TABLE OF CONTENTS

---

## 2 IMPORTANT SAFETY INSTRUCTIONS

---

## 6 LICENSES

---

## 6 OPEN SOURCE SOFTWARE NOTICE

---

## 7 TABLE OF CONTENTS

---

## 8 INSTALLATION PROCEDURE

---

## 8 ASSEMBLING AND PREPARING

---

- 8 Unpacking
- 10 Parts and Buttons
- 12 Lifting and Moving the TV
- 13 Setting up the TV
  - 13 - Attaching the Stand
  - 15 - Mounting on a Table
  - 18 - Mounting on a Wall
  - 19 - External Speaker Out
  - 19 - Tidying Cables
- 20 Making Connections

## 21 REMOTE CONTROL

---

## 23 SPECIFICATIONS

---

## 26 TROUBLESHOOTING

---

## 27 IR CODES

---

### NOTE

- Image shown may differ from your TV.
- Your TV's OSD (On Screen Display) may differ slightly from that shown in this manual.
- The available menus and options may differ from the input source or product model that you are using.
- New features may be added to this TV in the future.

## INSTALLATION PROCEDURE

- 1 Open the package and make sure all the accessories are included.
- 2 Attach the stand to the TV set.
- 3 Connect an external device to the TV set.

## ASSEMBLING AND PREPARING

### Unpacking

Check your product box for the following items. If there are any missing accessories, contact the dealer where you purchased your product. The illustrations in this manual may differ from the actual product and item.

#### CAUTION

- Do not use any unapproved items to ensure the safety and product life span.
- Any damages or injuries by using unapproved items are not covered by the warranty.
- Some models appear to have a thin film on the screen. It is actually part of the screen, do not remove it.

#### NOTE

- The items supplied with your product may vary depending on the model.
- Product specifications or contents of this manual may be changed without prior notice due to upgrade of product functions.
- For an optimal connection, HDMI cables and USB devices should have bezels less than 10 mm (0.39 inches) thick and 18 mm (0.7 inches) width.
- Use an extension cable that supports USB 2.0 if the USB cable or USB memory stick does not fit into your TV's USB port.

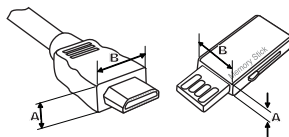

\*A ≤ 10 mm (0.39 inches)

\*B ≤ 18 mm (0.7 inches)

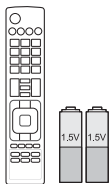

Remote Control, Batteries (AAA)  
(See p. 21)

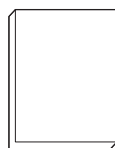

Quick Reference Guide



Power Cord



(For 32/39/42/47LP645H,  
32/39/42LP620H,  
55/60LP645H-UZ)

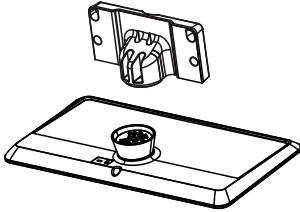

**Stand Body, Stand Base**  
(See p. 13)

(For 32/39/42/47LP645H,  
32/39/42LP620H,  
55/60LP645H-UZ)

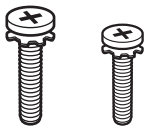

**Stand Screws**  
4 EA, M4 x 20  
4 EA, M4 x 16  
(See p. 13)

(For 32/39/42/47LP645H,  
32/39/42LP620H,  
55/60LP645H-UZ)

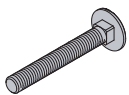

**Screws for Stand Fixing**  
2 EA  
(See p. 17)



**Torx Plus  
Star-Head Screw**  
2 EA  
(See p. 13, 14)

(For 55LP645H-UH,  
60LP645H-UA)

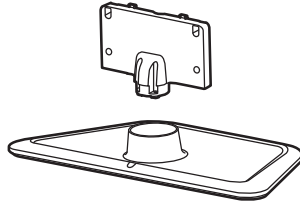

**Stand Body, Stand Base**  
(See p. 14)

(For 55LP645H-UH)



**Stand Screws**  
7 EA, M4 x 14  
(See p. 14)

(For 32/39/42/47LP645H,  
32/39/42LP620H,  
55/60LP645H-UZ)

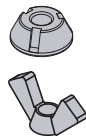

**Nuts for Stand Fixing**  
2 EA  
(See p. 17)

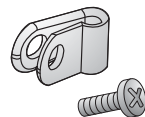

**Power Cord Holder and Screw**  
(See p. 19)

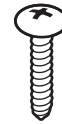

**Desk-Mount Screw**  
(See p. 15)

(For 60LP645H-UA)

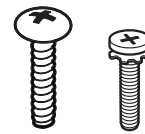

**Stand Screws**  
3 EA, P5 x 25  
4 EA, M4 x 14  
(See p. 14)

(For 32/39/42/47LP645H,  
32/39/42LP620H,  
55/60LP645H-UZ)



**Washers for Stand Fixing**  
2 EA  
(See p. 17)



**Cable Holder**  
(See p. 19)

## Parts and Buttons

For LP645H series

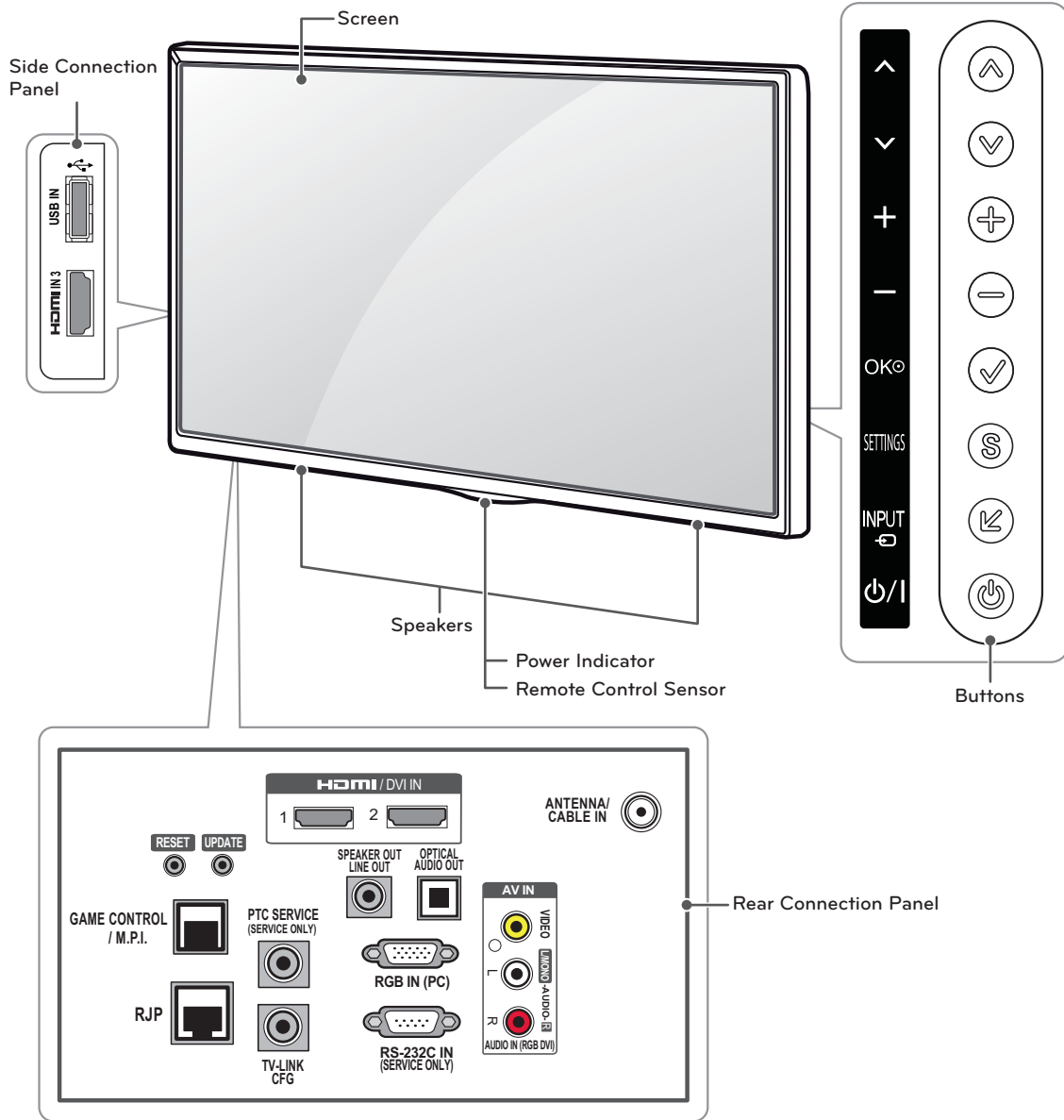

ENGLISH

Button	Description
▲ / ▼ (▲ / ▼)	Scrolls through the saved channels.
⊕ / ⊖ (⊕ / ⊖)	Adjusts the volume level.
✓ (OK)	Selects the highlighted menu option or confirms an input.
S (SETTINGS)	Accesses the main menus, or saves your input and exits the menus.
↶ (INPUT)	Changes the input source.
⏻ (⏻)	Turns the power on or off.

For LP620H series

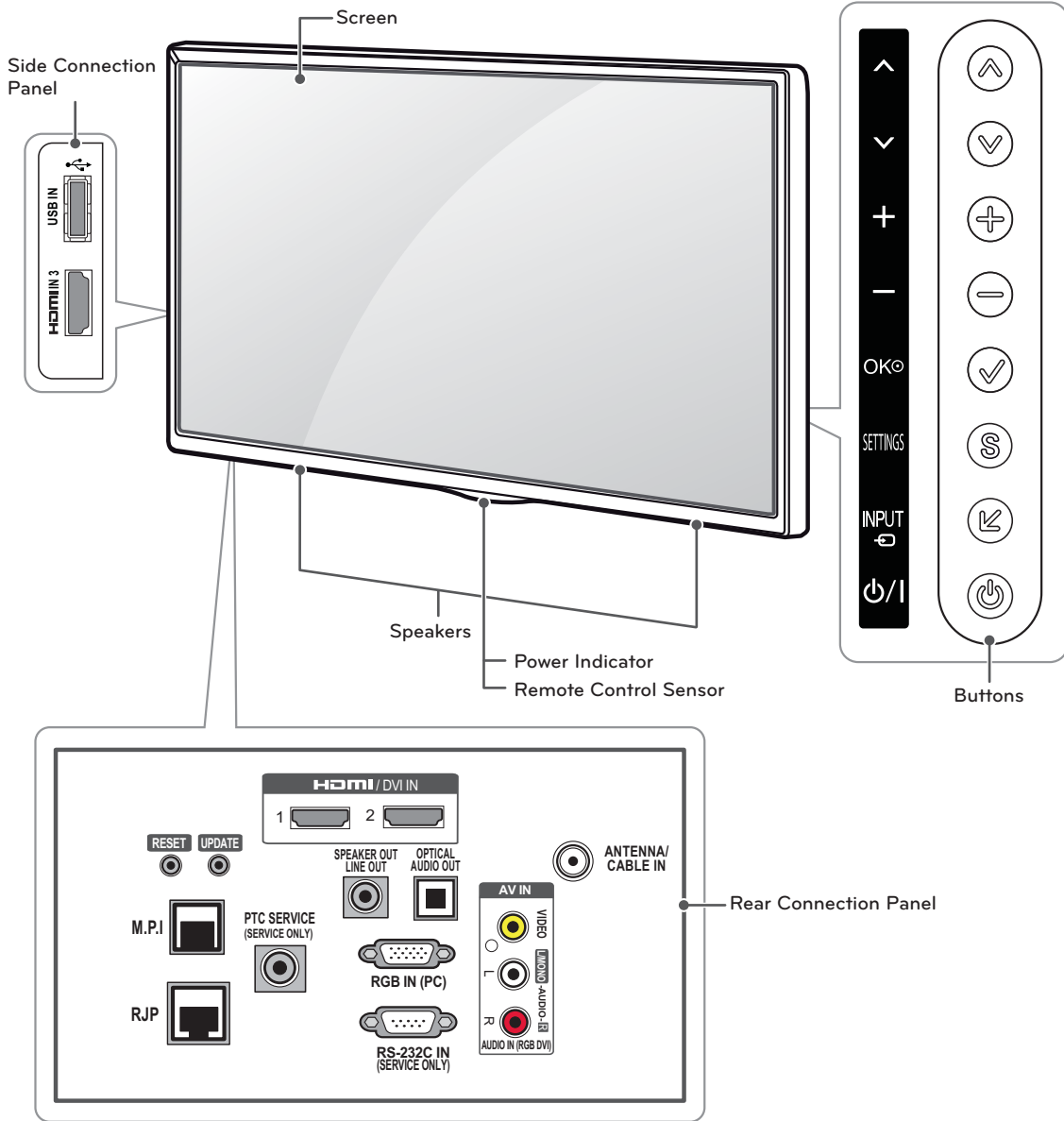

ENGLISH

Button	Description
▲ / ▼ / ▲ / ▼	Scrolls through the saved channels.
+ / - (+ / -)	Adjusts the volume level.
✓ (OK)	Selects the highlighted menu option or confirms an input.
S (SETTINGS)	Accesses the main menus, or saves your input and exits the menus.
↶ (INPUT)	Changes the input source.
⏻ (Power)	Turns the power on or off.

## Lifting and Moving the TV

When moving or lifting the TV, read the following to prevent the TV from being scratched or damaged and for safe transportation regardless of its type and size.

 **CAUTION**

- Avoid touching the screen at all times, as this may result in damage to the screen.

- It is recommended to move the TV in the box or packing material that the TV originally came in.
- Before moving or lifting the TV, disconnect the power cord and all cables.
- When holding the TV, the screen should face away from you to avoid damage.



- Hold the top and bottom of the TV frame firmly. Make sure not to hold the transparent part, speaker, or speaker grill area.

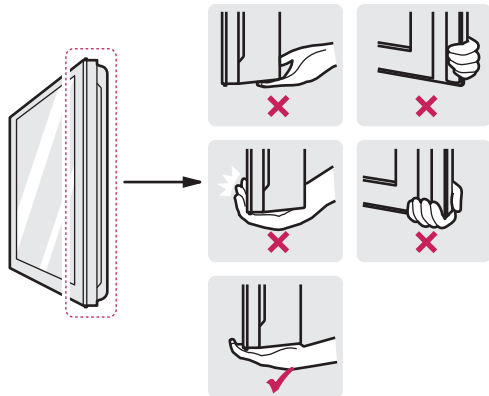

- When transporting a large TV, there should be at least 2 people.
- When transporting the TV by hand, hold the TV as shown in the following illustration.

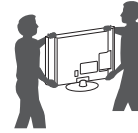

- When transporting the TV, do not expose the TV to jolts or excessive vibration.
- When transporting the TV, keep the TV upright, never turn the TV on its side or tilt towards the left or right.

## Setting up the TV

You can mount your TV to a wall or attach the stand if you wish to place the TV on an entertainment center or other furniture.

### Attaching the Stand

If you are not mounting the TV to a wall, use the following instructions to attach the stand.

**CAUTION**

- When attaching the stand to the TV set, place the screen facing down on a cushioned table or flat surface to protect the screen from scratches.
- Make sure that the screws are fastened tightly. (If they are not fastened securely enough, the TV may tilt forward after being installed.)
- Do not tighten the screws with too much force; otherwise they may be damaged and come loose later.

**NOTE**

- Make sure to hold the stand when attaching it to the TV to prevent the stand or TV from falling.
- Remove the stand before installing the TV on a wall mount by performing the stand attachment in reverse.

(For 32/39/42/47LP645H, 32/39/42LP620H, 55/60LP645H-UZ)

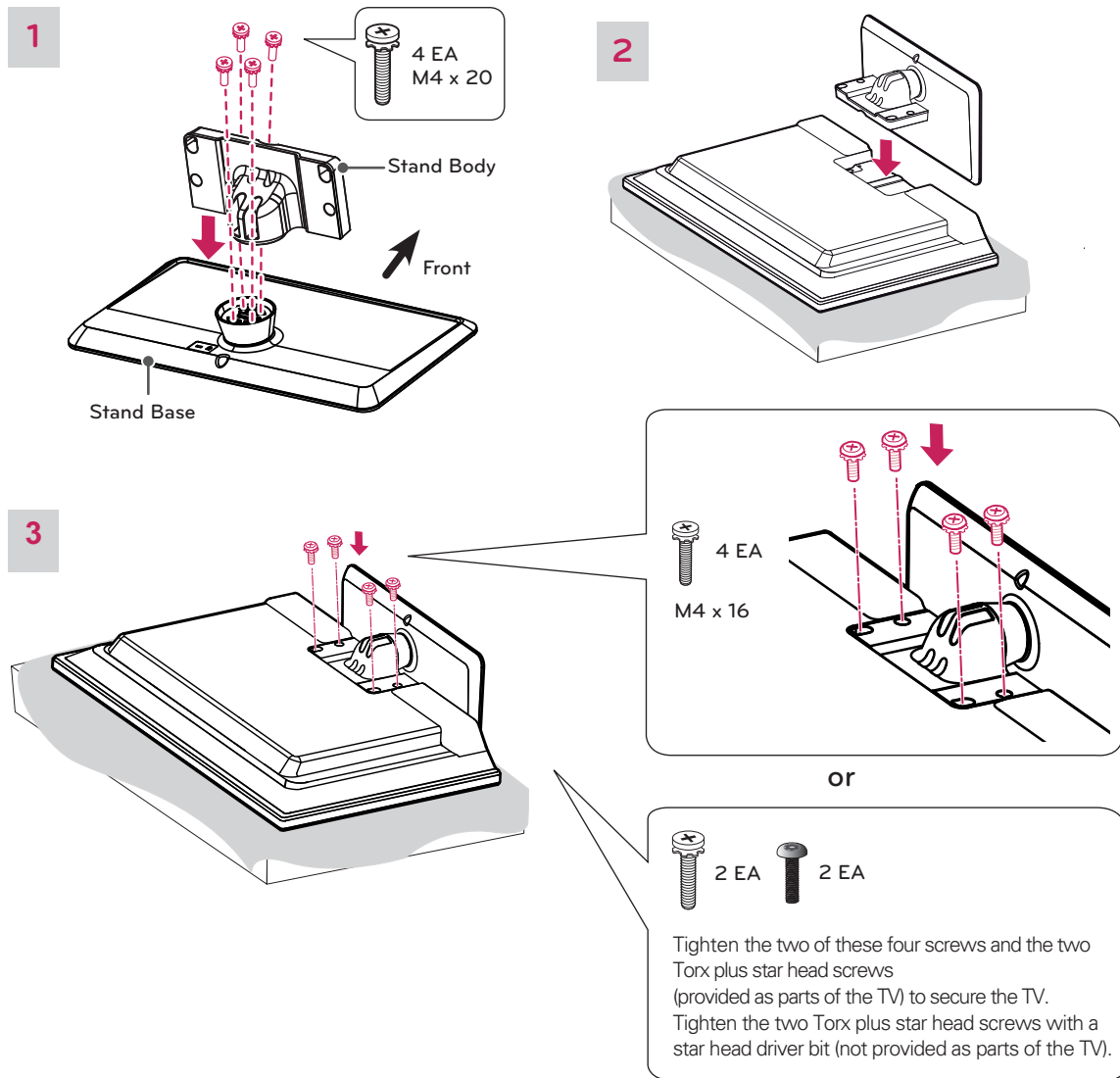

ENGLISH

(For 55LP645H-UH, 60LP645H-UA)

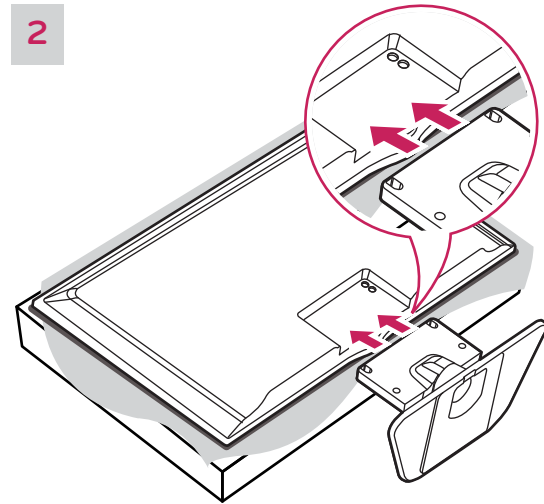
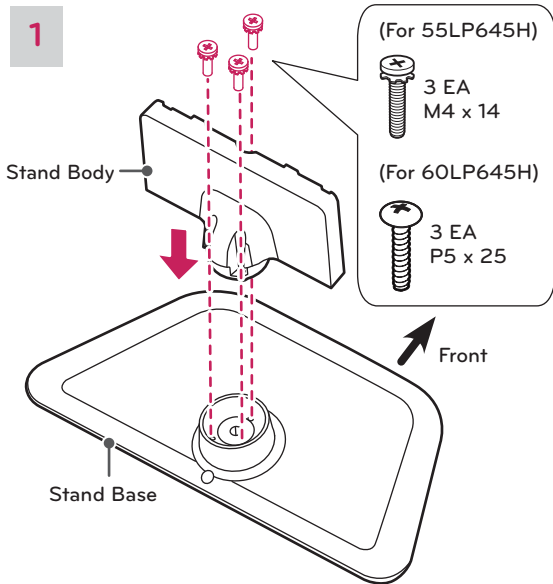

ENGLISH

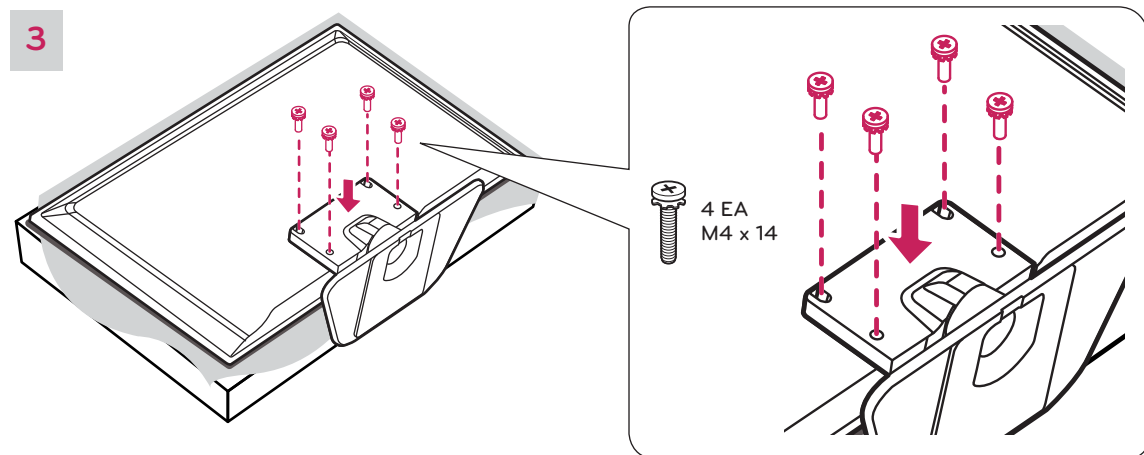

or



Tighten the two of these four screws and the two Torx plus star head screws (provided as parts of the TV) to secure the TV.  
Tighten the two Torx plus star head screws with a star head driver bit (not provided as parts of the TV).

### Mounting on a Table

- 1 Lift and tilt the TV into its upright position on a table.
  - Leave a 10 cm (4 inches) (minimum) space from the wall for proper ventilation.

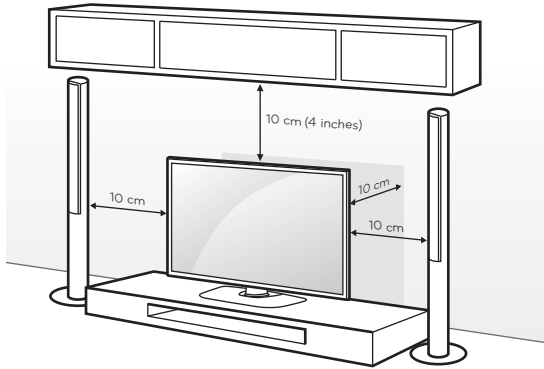

- 2 Connect the power cord to a wall outlet.

**CAUTION**

- Do not place the TV near or on sources of heat, as this may result in fire or other damage.

#### Using the Kensington security system (optional)

The Kensington security system connector is located at the rear of the TV. For more information of installation and using, refer to the manual provided with the Kensington security system or visit <http://www.kensington.com>.

Connect the Kensington security system cable between the TV and a table.

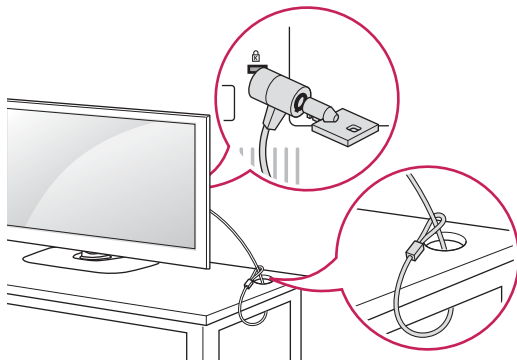

**NOTE**

- The Kensington security system is optional. You can obtain additional accessories from your local dealer.

### Securing the TV to a table

Fix the TV to a table to prevent from tilting forward, damage, and potential injury. Mount the TV on a table, and then insert and tighten the supplied screw on the rear of the stand.

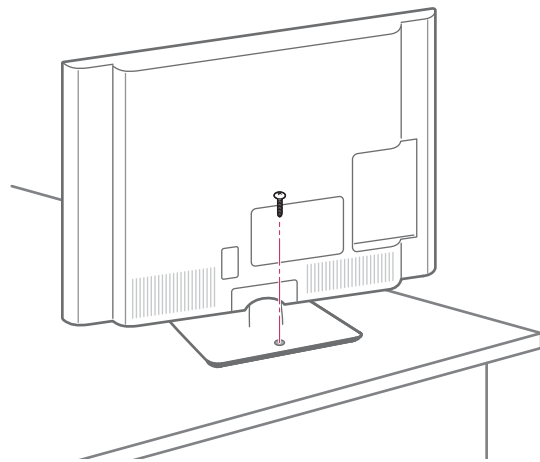

**WARNING**

- To prevent TV from falling over, the TV should be securely attached to the floor/wall per installation instructions. Tipping, shaking, or rocking the TV may cause injury.

**CAUTION**

- Make sure that children do not climb on or hang on the TV.

### Adjusting the angle of the TV to suit view

(For 32/39/42/47LP645H, 32/39/42LP620H, 55/60LP645H-UZ)

The swivel angle is adjustable. The default swivel angle is 20°. Attaching a screw to the **A** position on the bottom of the stand will allow a swivel angle range of 45°. Attaching a screw to the **B** position will allow a swivel angle range of 90°.

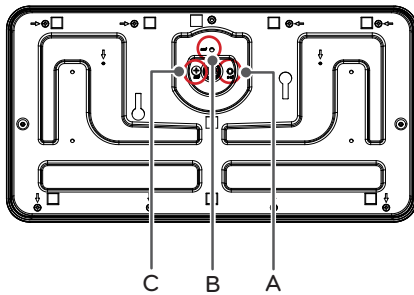
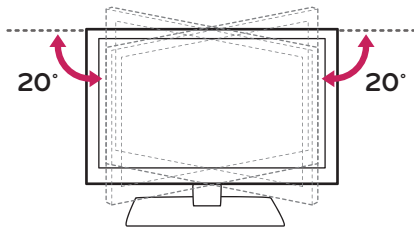

ENGLISH

#### NOTE

- Only one swivel screw is included and attached to position C.

#### CAUTION

- When adjusting the angle of the TV, watch out for your fingers.
  - Personal injury may occur if hands or fingers are pinched. If the product is tilted too much, it may fall, causing damage or injury.
- Removing the swivel fixing screw will allow the set to rotate 360°.

(For 55LP645H-UH)

Swivel 90 degrees to the left or right and adjust the angle of the TV to suit your view.

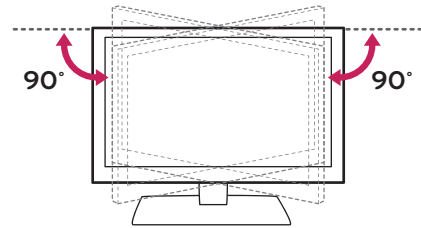

#### CAUTION

- When adjusting the angle of the TV, watch out for your fingers.
  - Personal injury may occur if hands or fingers are pinched. If the product is tilted too much, it may fall, causing damage or injury.



**Attaching the TV to a desk**

(Depending on model)

The TV should be attached to a desk so it cannot be pulled in a forward/backward direction, potentially causing injury or damaging the product.

TYPE 1

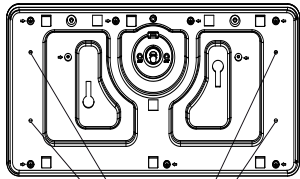

4-Screws

(Not provided as parts of the product)

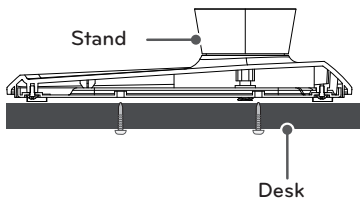

**NOTE**

- Screw: M5 x L (\*L: Table depth + 8~10 mm)  
ex) Table depth: 15mm, Screw: M5 x 25

TYPE 2

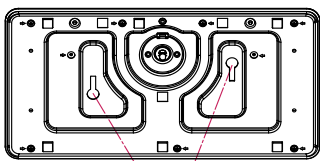

2-Screws, 2-Washers, 2-Nuts  
(provided as parts of the product)

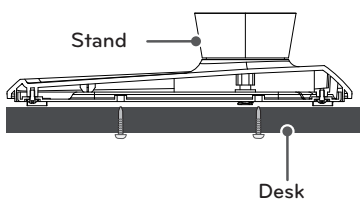

**Securing the TV to a wall (optional)**

(Depending on model)

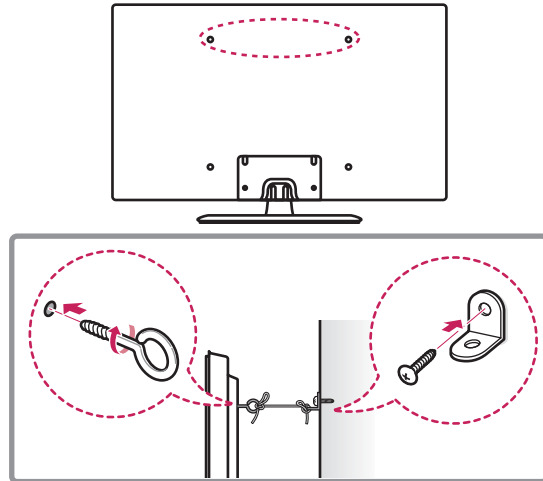

- 1 Insert and tighten the eye-bolts, or TV brackets and bolts on the back of the TV.  
- If there are bolts inserted at the eye-bolts position, remove the bolts first.
- 2 Mount the wall brackets with the bolts to the wall. Match the location of the wall bracket and the eye-bolts on the rear of the TV.
- 3 Connect the eye-bolts and wall brackets tightly with a sturdy rope.  
Make sure to keep the rope horizontal with the flat surface.

**CAUTION**

- Make sure that children do not climb on or hang on the TV.

**NOTE**

- Use a platform or cabinet that is strong and large enough to support the TV securely.
- Brackets, bolts and ropes are optional. You can obtain additional accessories from your local dealer.

### Mounting on a Wall

An optional wall mount can be used with your LG Television. Consult with your local dealer for a wall mount that supports the VESA standard used by your TV model. Carefully attach the wall mount bracket at the rear of the TV. Install the wall mount bracket on a solid wall perpendicular to the floor. If you are attaching the TV to other building materials, please contact qualified personnel to install the wall mount. Detailed instructions will be included with the wall mount. We recommend that you use an LG brand wall mount.

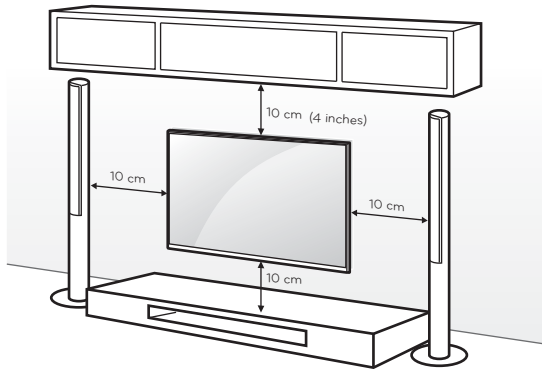

#### CAUTION



- Disconnect the power before moving or installing the TV. Otherwise electric shock may occur.
- If you install the TV on a ceiling or slanted wall, it may fall and result in severe injury. Use an authorized LG wall mount and contact the local dealer or qualified personnel.
- Do not over tighten the screws as this may cause damage to the TV and void your warranty.
- Use the screws and wall mounts that meet the VESA standard. Any damages or injuries by misuse or using an improper accessory are not covered by the warranty.

#### NOTE

- The wall mount bracket is optional. You can obtain additional accessories from your local dealer.
- Use the screws that are listed in the VESA standard screw specifications.
- The wall mount kit includes an installation manual and necessary parts.
- The length of screws may differ depending on the wall mount. Make sure to use the proper length.
- For more information, refer to the manual supplied with the wall mount.

ENGLISH

Make sure to use screws and wall mounts that meet the VESA standard. Standard dimensions for the wall mount kits are described in the following table.

<b>Model</b>	32LP645H 32LP620H	39LP645H 39LP620H 42LP645H 42LP620H
<b>VESA (A x B)</b>	200 x 100	200 x 200
<b>Standard screw</b>	M4	M6
<b>Number of screws</b>	4	4
<b>Wall mount bracket (optional)</b>	LSW130B 	LSW230B 

<b>Model</b>	47LP645H 55LP645H 60LP645H
<b>VESA (A x B)</b>	400 x 400
<b>Standard screw</b>	M6
<b>Number of screws</b>	4
<b>Wall mount bracket (optional)</b>	LSW430B 

## External Speaker Out

(This section uses illustrations of LP645H series.)

Connect the external speaker.

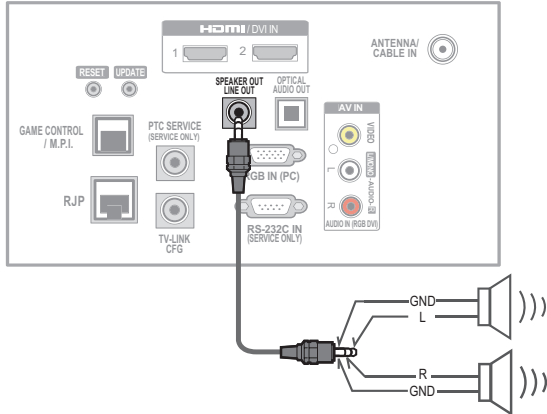

### NOTE

- Make sure that the external speaker should be connected with TV under power-off state.
- Use external speaker with SE type (3 pin).

## Tidying Cables

- 1 Install the power cord holder and power cord. It will help prevent the power cable from being removed by accident.
- 2 Gather and bind the cables with the cable holder.

For 32/39/42LP645H, 32/39/42LP620H

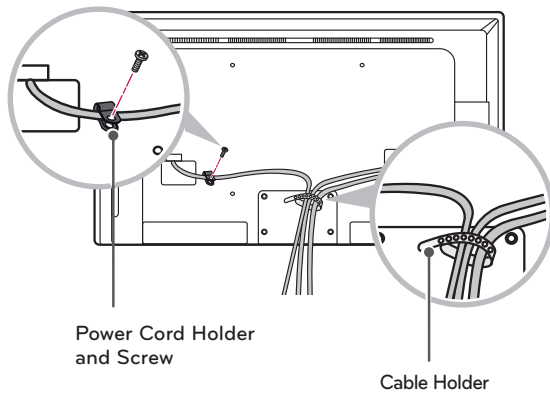

For 47/55/60LP645H

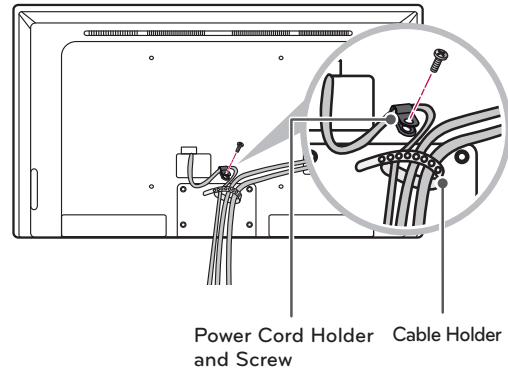

### CAUTION

- Do not move the TV by holding the cable holder and power cord holder, as the cable holders may break, and injuries and damage to the TV may occur.

## Making Connections

- Image shown may differ from your TV.

Connect the external devices.

ENGLISH

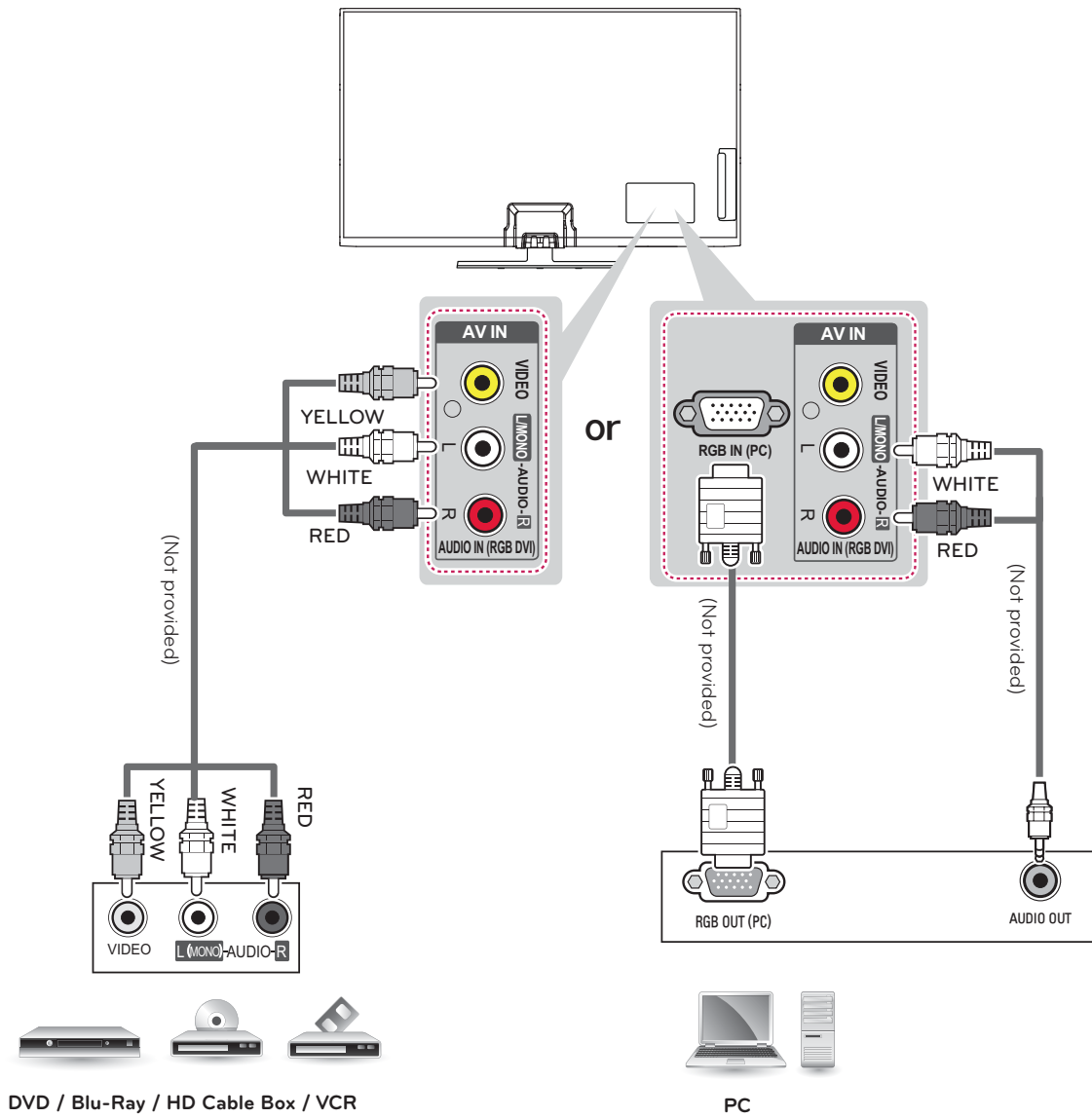

# REMOTE CONTROL

Below is a description of the remote control. Your remote control may look slightly different. To install batteries, open the battery cover, insert batteries (1.5 V AAA) matching the ⊕ and ⊖ ends to the label inside the compartment, and close the battery cover. To remove the batteries, perform the installation actions in reverse.

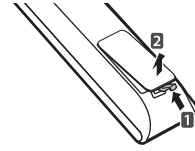

**CAUTION**

- Do not mix old and new batteries, as this may damage the remote control.

This remote uses infrared light. When in use, it should be pointed in the direction of the TV's remote sensor.

- ⏻ (POWER)**  
Turns the TV on or off.
- MENU**  
Not functional
- TV**  
Selects the remote's operating mode: TV.
- DVD**  
Selects the remote's operating mode: DVD.
- INPUT**  
Rotates through inputs.
- MARK**  
Not functional
- Number button**  
Enters numbers. Also supports characters.
- (DASH)**  
Selects a program number for multiple program channels such as 2-1, 2-2, etc.
- FLASHBK**  
Tunes to the last channel or input viewed.
- + VOL -**  
Adjusts the volume level.
- CHAR/NUM**  
Switches between Letter and Number input modes.
- CC**  
Selects a closed caption.
- TIMER**  
Turns the TV off in a set amount of time.
- DELETE**  
Deletes letters and numbers.
- MUTE**   
Mutes all sounds.
- ^ CH v**  
Scrolls through the saved channels.
- ↑ PAGE ↓**  
Moves to the previous or next screen.

ENGLISH

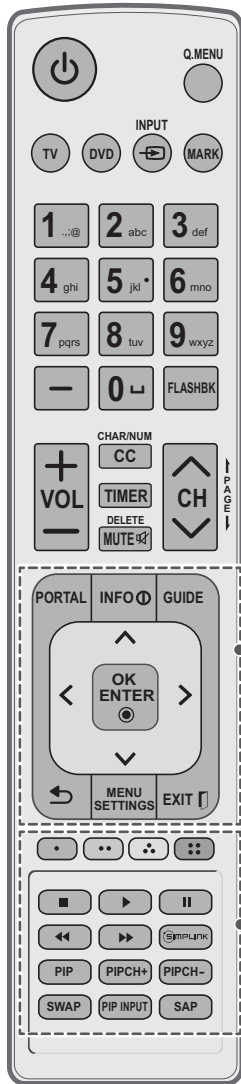

**PORTAL**

Displays and removes Pro:Centric Application.

**INFO**

Views the information list of the Pro:Centric Application.

**GUIDE**

Displays and removes the electronic program guide.

**Navigation buttons** (up/down/left/right)

Scrolls through menus or options.

**OK/ENTER**

Selects menus or options and confirms your input.

**BACK**

Returns to the previous level.

**MENU/SETTINGS**

Accesses the main menu.

**EXIT**

Clears all on-screen displays and returns to TV viewing.

**Color buttons** (Red, Green, Yellow, Blue)

These access special functions in some menus.

**VCR/DVD/USB control buttons** (Stop, Play, Pause, Fast Forward, Rewind)

Controls video cassette recorders or DVD players or USB.

**SIMPLINK**

Accesses the AV devices connected to the TV; Opens the SIMPLINK menu.

**PIP**

Not functional

**PIP CH +/-**

Not functional

**SWAP**

Not functional

**PIP INPUT**

Not functional

**SAP**

Analog mode: Selects MTS sound (Mono, Stereo or SAP)  
DTV mode: Changes the audio language.

## SPECIFICATIONS

Product specifications may be changed without prior notice due to upgrade of product functions.

<b>Power requirement</b>	AC 100 - 240 V ~ 50 / 60 Hz	
<b>Television System</b>	NTSC-M, ATSC, 64 & 256 QAM	
<b>Program Coverage</b>	VHF 2-13, UHF 14-69, CATV 1-135, DTV 2-69, CADTV 1-135	
<b>External Antenna Impedance</b>	75 $\Omega$	
<b>Environment condition</b>	Operating Temperature	0 °C ~ 40 °C (32 °F ~ 104 °F)
	Operating Humidity	Less than 80 %
	Storage Temperature	-20 °C ~ 60 °C (-4 °F ~ 140 °F)
	Storage Humidity	Less than 85 %

MODELS		32LP645H (32LP645H-UH)	32LP620H (32LP620H-UH)
Dimensions (W x H x D)	With stand	738 x 496 x 226 (mm)	
		29.0 x 19.5 x 8.9 (inch)	
	Without stand	738 x 449 x 79 (mm)	
		29.0 x 17.7 x 3.1 (inch)	
Weight	With stand	8.9 kg (19.6 lbs)	
	Without stand	6.4 kg (14.1 lbs)	
Current Value / Power consumption		1.3 A / 80 W	

MODELS		39LP645H (39LP645H-UH)	39LP620H (39LP620H-UH)
Dimensions (W x H x D)	With stand	894 x 583 x 283 (mm)	
		35.2 x 23.0 x 11.1 (inch)	
	Without stand	894 x 537 x 79 (mm)	
		35.2 x 21.1 x 3.1 (inch)	
Weight	With stand	12.3 kg (27.1 lbs)	
	Without stand	8.6 kg (18.9 lbs)	
Current Value / Power consumption		1.5 A / 100 W	

MODELS		42LP645H (42LP645H-UH)	42LP620H (42LP620H-UH)
Dimensions (W x H x D)	With stand	968 x 625 x 283 (mm)	
		38.1 x 24.6 x 11.1 (inch)	
	Without stand	968 x 579 x 79 (mm)	
		38.1 x 22.8 x 3.1 (inch)	
Weight	With stand	13.3 kg (29.3 lbs)	
	Without stand	9.6 kg (21.2 lbs)	
Current Value / Power consumption		1.6 A / 110 W	

MODELS		47LP645H (47LP645H-UH)
Dimensions (W x H x D)	With stand	1,080 x 688 x 282.4 (mm)
		42.5 x 27.1 x 11.1 (inch)
	Without stand	1,080 x 642 x 80.5 (mm)
		42.5 x 25.3 x 3.2 (inch)
Weight	With stand	16.7 kg (36.8 lbs)
	Without stand	13.4 kg (29.5 lbs)
Current Value / Power consumption		1.3 A / 130 W

MODELS		55LP645H (55LP645H-UH)	55LP645H (55LP645H-UZ)
Dimensions (W x H x D)	With stand	1,250 x 790 x 297 (mm)	1,250 x 786 x 283 (mm)
		49.2 x 31.1 x 11.6 (inch)	49.2 x 30.9 x 11.1 (inch)
	Without stand	1,250 x 737 x 79.1 (mm)	1,250 x 737 x 79.1 (mm)
		49.2 x 29.0 x 3.1 (inch)	49.2 x 29.0 x 3.1 (inch)
Weight	With stand	21.3kg (46.9 lbs)	22.9 kg (50.4 lbs)
	Without stand	19.1 (42.1 lbs)	19.1 (42.1 lbs)
Current Value / Power consumption		1.6 A / 160 W	TBD

ENGLISH

MODELS		60LP645H (60LP645H-UA)	60LP645H (60LP645H-UZ)
Dimensions (W x H x D)	With stand	1,359 x 852 x 297 (mm)	1,359 x 848 x 283 (mm)
		53.5 x 33.5 x 11.6 (inch)	53.5 x 33.3 x 11.1 (inch)
	Without stand	1,359 x 799 x 67.2 (mm)	1,359 x 799 x 67.2 (mm)
		53.5 x 31.4 x 2.6 (inch)	53.5 x 31.4 x 2.6 (inch)
Weight	With stand	26.3 kg (57.9 lbs)	27.9 kg (61.5 lbs)
	Without stand	24.2 kg (53.3 lbs)	24.2 kg (53.3 lbs)
Current Value / Power consumption		2.0 A / 200 W	TBD



## HDMI (DTV) supported mode

Resolution	Horizontal Frequency (kHz)	Vertical Frequency (Hz)
720 x 480p	31.47	59.94
	31.50	60.00
1280 x 720p	44.96	59.94
	45.00	60.00
1920 x 1080i	33.72	59.94
	33.75	60.00
1920 x 1080p	26.97	23.976
	27.00	24.00
	33.71	29.97
	33.75	30.00
	67.432	59.94
	67.50	60.00

## RGB (PC), HDMI (PC) supported mode

Resolution	Horizontal Frequency (kHz)	Vertical Frequency (Hz)
720 x 400	31.46	70.08
640 x 480	31.46	59.94
800 x 600	37.87	60.31
1024 x 768	48.36	60.00
1360 x 768	47.71	60.01
1280 x 1024	63.98	60.02
1920 x 1080	67.50	60.00

Except 32LP645H, 32LP620H

## TROUBLESHOOTING

### General

Problem	Solution
Cannot control the TV with the remote control.	<ul style="list-style-type: none"> <li>Check the remote control sensor on the product and try again.</li> <li>Check if there is any obstacle between the product and the remote control.</li> <li>Check if the batteries are still working and properly installed (⊕ to ⊕, ⊖ to ⊖).</li> </ul>
No image display and no sound is produced.	<ul style="list-style-type: none"> <li>Check if the product is turned on.</li> <li>Check if the power cord is connected to a wall outlet.</li> <li>Check if there is a problem in the wall outlet by connecting other products.</li> </ul>
Image appears slowly when the TV turns on.	<ul style="list-style-type: none"> <li>The image is muted during the product startup process. This is normal. If the image does not appear in a few minutes, unplug the TV for 30 seconds and try again. If the image still does not appear, contact the authorized service center in your local area.</li> </ul>
Cannot connect external devices.	<ul style="list-style-type: none"> <li>Refer to the "Connection Overview" and connect an external device.</li> </ul>
The TV turns off suddenly.	<ul style="list-style-type: none"> <li>Check the power control settings. The power supply may be interrupted.</li> <li>Check if the Auto sleep feature is activated in the Time settings. Refer to the "Sleep Timer".</li> </ul>

### Audio

Problem	Solution
No sound is produced while images are displaying.	<ul style="list-style-type: none"> <li>Press <b>VOL +</b> or <b>-</b> button.</li> <li>Check if the sound is muted by pressing <b>MUTE</b>.</li> <li>Scroll to other channels. There may a problem with the broadcast.</li> <li>Check if the TV Speaker feature is activated in the menu option.</li> </ul>
No output from one of the speakers	<ul style="list-style-type: none"> <li>Adjust Balance in the menu option.</li> </ul>
Unusual sound from inside the TV is produced.	<ul style="list-style-type: none"> <li>A change in ambient humidity or temperature may result in an unusual noise when the product turns on or off. There is no problem with your product.</li> </ul>

### Video

Problem	Solution
An image displays in black and white or the color quality is poor.	<ul style="list-style-type: none"> <li>Adjust the color setting in the menu option.</li> <li>Keep a sufficient distance between this product and other electronic products.</li> <li>Scroll to other channels. There may a problem with the broadcast.</li> </ul>
Horizontal or vertical bars appears or images blur	<ul style="list-style-type: none"> <li>Check if there are local interferences such as an electrical appliance or power tool.</li> </ul>
Lines or streaks appear on images	<ul style="list-style-type: none"> <li>Check the antenna or aim the antenna to the proper direction.</li> </ul>
Afterimages (ghosts) appear when the product turns off	<ul style="list-style-type: none"> <li>Pixels may have been damaged from a fixed image displayed for a long time (image burn). Use a screen saver to prevent the pixel damage on the screen.</li> </ul>
The power is on but the screen appears extremely dark.	<ul style="list-style-type: none"> <li>Adjust the brightness and contrast in the menu option.</li> <li>Check the Backlight settings in the video menu option.</li> </ul>
<b>No Signal</b> appears on the screen.	<ul style="list-style-type: none"> <li>Check if the signal cable is connected between the TV and products properly.</li> <li>Check the selected input source by pressing <b>INPUT</b>.</li> </ul>
Black spots appear on the screen.	<ul style="list-style-type: none"> <li>Several pixels in red, green, white, or black may appear on the screen that can attribute to the characteristics of the panel.</li> <li>This is normal.</li> </ul>
The display offset is wrong.	<ul style="list-style-type: none"> <li>Adjust the position setting in the Picture menu.</li> <li>Check if the video card resolution and frequency are supported by the product. If the frequency is out of range, set to the recommended resolution using the display settings on the external device.</li> </ul>
Thin lines appear in the background of the screen.	<ul style="list-style-type: none"> <li>Check the video cable connections.</li> </ul>
The reception on some channels is poor	<ul style="list-style-type: none"> <li>Scroll to other channels. There may a problem with the broadcast.</li> <li>The station signal may be weak. Aim the antenna to the proper direction.</li> <li>Check if there is local interferences such as an electrical appliance or power tool.</li> </ul>

## IR CODES

(Depending on model)

Code (Hexa)	Function	Note
08	⏻ (POWER)	Remote control Button (Power On/Off)
0B	INPUT	Remote control Button
0F	TV	Remote control Button
10-19	Number Key 0-9	Remote control Button
4C	- (DASH)	Remote control Button
1A	FLASHBK	Remote control Button
02	VOL +	Remote control Button
03	VOL -	Remote control Button
09	MUTE / DELETE	Remote control Button
00	CH ^ / PAGE ^	Remote control Button
01	CH v / PAGE v	Remote control Button
43	SETTINGS / MENU	Remote control Button
45	Q.MENU	Remote control Button
28	↩ (BACK)	Remote control Button
AA	INFO	Remote control Button
5B	EXIT	Remote control Button
44	OK / ENTER	Remote control Button
40	^	Remote control Button
41	v	Remote control Button
07	<	Remote control Button
06	>	Remote control Button
C1	RED	Remote control Button
C0	GREEN	Remote control Button
C2	YELLOW	Remote control Button
C3	BLUE	Remote control Button
B1	■	Remote control Button
B0	▶	Remote control Button
BA		Remote control Button
8E	▶▶	Remote control Button
8F	◀◀	Remote control Button
7E	SIMPLINK	Remote control Button
60	PIP	Remote control Button
71	PIP CH +	Remote control Button
72	PIP CH -	Remote control Button
63	SWAP	Remote control Button
61	PIP INPUT	Remote control Button
0A	SAP	Remote control Button
0E	TIMER	Remote control Button
39	CC / CHAR/NUM	Remote control Button
1E	MARK	Remote control Button
0C	PORTAL	Remote control Button
AB	GUIDE	Remote control Button







# CHILD SAFETY:

It Makes A Difference How and Where You Use Your Flat Panel Display

**Congratulations on your purchase! As you enjoy your new product, please keep these safety tips in mind:**



## THE ISSUE

- The home theater entertainment experience is a growing trend and larger flat panel displays are popular purchases. However, flat panel displays are not always supported on the proper stands or installed according to the manufacturer's recommendations.
- Flat panel displays that are inappropriately situated on dressers, bookcases, shelves, desks, speakers, chests or carts may fall over and cause injury.

## THIS MANUFACTURER CARES!

- The consumer electronics industry is committed to making home entertainment enjoyable and safe.

## TUNE INTO SAFETY

- One size does NOT fit all. Follow the manufacturer's recommendations for the safe installation and use of your flat panel display.
- Carefully read and understand all enclosed instructions for proper use of this product.
- Don't allow children to climb on or play with furniture and television sets.
- Don't allow place flat panel displays on furniture that can easily be used as steps, such as a chest of drawers.
- Remember that children can become excited while watching a program, especially on a "larger than life" flat panel display. Care should be taken to place or install the display where it cannot be pushed, pulled over, or knocked down.
- Care should be taken to route all cords and cables connected to the flat panel display so that they cannot be pulled or grabbed by curious children.



## WALL MOUNTING: IF YOU DECIDE TO WALL MOUNT YOUR FLAT PANEL DISPLAY, ALWAYS:

- Use a mount that has been recommended by the display manufacturer and/or listed by an independent laboratory (such as UL, CSA, ETL).
- Follow all instructions supplied by the display and wall mount manufacturers.
- If you have any doubts about your ability to safely install your flat panel display, contact your retailer about professional installation.
- Make sure that the wall where you are mounting the display is appropriate. Some wall mounts are not designed to be mounted to walls with steel studs or old cinder block construction. If you are unsure, contact a professional installer.
- A minimum of two people are required for installation. Flat panel displays can be heavy.



The model and serial number of the TV is located on the back and one side of the TV. Record it below should you ever need service.

MODEL \_\_\_\_\_

SERIAL \_\_\_\_\_

### LG Customer Information Center

For inquires or comments, visit [www.lg.com](http://www.lg.com) or call:

**1-888-865-3026** USA, Commercial User

**1-888-542-2623** CANADA

Pro:Centric is a trademark of LG Electronics U.S.A., Inc. Pro:Idiom is a registered trademark of Zenith Electronics LLC. b-LAN is a trademark of LodgeNet Interactive Corporation. All other trademarks or registered trademarks are the property of their respective owners.



This product qualifies for ENERGY STAR in the "factory default (Home Use)" setting.

Changing the factory default settings or enabling other features may increase power consumption that could exceed the limits necessary to qualify for ENERGY STAR.