



LG

Life's Good

OWNER'S MANUAL

LED TV

* LG LED TV applies LCD screen with LED backlights.

Please read this manual carefully before operating the set and retain it for future reference.

GA6400 Series GA6450 Series GA7900 Series

P/NO : SAC35615301 (1305-REV00)

www.lg.com

TABLE OF CONTENTS

2 TABLE OF CONTENTS

4 BEFORE USE

- 4 LICENSES
- 5 IMPORTANT SAFETY INSTRUCTIONS
- 9 Viewing 3D Imaging
- 11 Unpacking
- 14 Optional Extras
- 15 Parts and Buttons
- 16 Remote Control Functions
 - 16 - Inserting batteries
 - 19 - Registering the remote control
 - 19 - How to use the zoom in/out gestures
 - 19 - Voice Search for Google TV
 - 19 - Precautions to take when using the remote control

20 INSTALLATION

- 20 Lifting and moving the TV
- 21 Setting up the TV
 - 21 - Attaching the stand
 - 23 - Mounting on a table
 - 24 - Mounting on a wall
 - 25 - Tidying cables

26 CONNECTIONS

- 26 Connecting to an antenna or cable
- 27 Network connection
 - 27 - Wireless Network Connection
 - 27 - Wired Network Connection
- 28 Connection Overview
- 29 Connecting to a HD receiver, DVD Player, or VCR
 - 29 - HDMI Connection
 - 30 - DVI to HDMI Connection
 - 31 - Connecting to a mobile phone
 - 32 - Component Connection

- 33 - Composite Connection
- 34 Connecting a PC
 - 34 - HDMI Connection or DVI to HDMI Connection
- 36 Connecting to an Audio System
 - 36 - Digital Optical Audio Connection
- 37 Connecting to a Headphone
- 37 Connecting a USB Device

38 USING (BASIC)

- 38 Turning the TV on for the first time
- 38 Setting the Mode
- 39 Accessing Home Menu
- 40 Setting up channels
- 41 Checking current program info
- 42 Adjusting aspect ratio
- 43 Using the input list
- 44 Using the customer support
 - 44 - Testing the Picture / Sound
 - 44 - Using the product or service information

45 APPLICATIONS

- 45 Google Chrome
 - 45 - Getting started
 - 45 - Browser windows
 - 46 - Bookmarks
 - 46 - Safety and security settings
 - 46 - Advanced settings
- 47 Google Play
 - 47 - Getting Started
 - 47 - How to download or remove apps
 - 48 - Charges
 - 48 - Returning apps
- 49 Live TV
- 50 3D World
 - 50 - When watching 3D imaging
 - 50 - When using 3D Glasses

50	- Viewing 3D Imaging
51	- Setting 3D Imaging
52	SmartShare
52	- Options
53	Netflix
53	Photos
54	Search
54	PrimeTime
55	YouTube
55	Dual Play

56 SETTINGS

56	The Main Menu
57	- Network
57	- Video input
57	- Picture & sound
58	- Channel setting
58	- 3D settings
58	- Input List
58	- Search
58	- Applications
58	- Language & input devices
59	- Accounts & sync
59	- Privacy & safety
60	- Storage
60	- Date, time & location
61	- Accessibility
61	- Options
61	- About

62 APPENDIX

62	Updating the TV system
63	Cleaning Your TV
63	- Screen, frame, cabinet and stand
63	- Power cord
63	Preventing "Image burn" or "Burn-in" on your TV screen
64	IR Blaster Guide
65	- IR Code list (by brand name)
70	Troubleshooting
72	Specifications
79	Open Source Software Notice

BEFORE USE

LICENSES

Supported licenses may differ by model. For more information about licenses, visit www.lg.com.



Manufactured under license from Dolby Laboratories. "Dolby" and the double-D symbol are trademarks of Dolby Laboratories.



The terms HDMI and HDMI High-Definition Multimedia Interface, and the HDMI logo are trademarks or registered trademarks of HDMI Licensing LLC in the United States and other countries.



Manufactured under license under U.S. Patent Nos: 5,956,674; 5,974,380; 6,487,535 & other U.S. and worldwide patents issued & pending. DTS, the Symbol & DTS and the Symbol together are registered trademarks & DTS 2.0+ Digital Out is a trademark of DTS, Inc. Product includes software. © DTS, Inc. All Rights Reserved.

IMPORTANT SAFETY INSTRUCTIONS

Always comply with the following precautions to avoid dangerous situations and ensure peak performance of your product.





WARNING/CAUTION

**RISK OF ELECTRIC SHOCK
DO NOT OPEN**





TO REDUCE THE RISK OF ELECTRIC SHOCK DO NOT REMOVE COVER (OR BACK). NO USER SERVICEABLE PARTS INSIDE. REFER TO QUALIFIED SERVICE PERSONNEL.

 The lightning flash with arrowhead symbol, within an equilateral triangle, is intended to alert the user to the presence of uninsulated "dangerous voltage" within the product's enclosure that may be of sufficient magnitude to constitute a risk of electric shock to persons.

 The exclamation point within an equilateral triangle is intended to alert the user to the presence of important operating and maintenance (servicing) instructions in the literature accompanying the appliance.

WARNING/CAUTION
- TO REDUCE THE RISK OF FIRE AND ELECTRIC SHOCK, DO NOT EXPOSE THIS PRODUCT TO RAIN OR MOISTURE.

 **WARNING**
If you ignore the warning message, you may be seriously injured or there is a possibility of accident or death.

 **CAUTION**
If you ignore the caution message, you may be slightly injured or the product may be damaged.

 **NOTE**
The note helps you understand and use the product safely. Please read the note carefully before using the product.

WARNING: This product contains chemicals known to the State of California to cause cancer and birth defects or other reproductive harm.
Wash hands after handling.

Read these instructions.
Keep these instructions.
Heed all warnings.
Follow all instructions.



- Do not use this apparatus near water.



- Clean only with a dry cloth.



- Do not block any ventilation openings. Install in accordance with the manufacturer's instructions.



- Do not install near any heat sources such as radiators, heat registers, stoves, or other apparatus (including amplifiers) that produce heat.



- Do not defeat the safety purpose of the polarized or grounding-type plug. A polarized plug has two blades with one wider than the other. A grounding type plug has two blades and a third grounding prong. The wide blade or the third prong are provided for your safety. If the provided plug does not fit into your outlet, consult an electrician for replacement of the obsolete outlet (Can differ by country).



- Do not press strongly upon the panel with a hand or a sharp object such as a nail, pencil or pen, or make a scratch on it.



ENGLISH

- Protect the power cord from being walked on or pinched particularly at plugs, convenience receptacles, and the point where they exit from the apparatus.



- Only use attachments/accessories specified by the manufacturer.



- Use only with a cart, stand, tripod, bracket, or table specified by the manufacturer, or sold with the apparatus. When a cart is used, use caution when moving the cart/apparatus combination to avoid injury from tip-over.



- Unplug this apparatus during lightning storms or when unused for long periods of time.

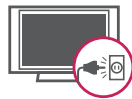

- Refer all servicing to qualified service personnel. Servicing is required when the apparatus has been damaged in any way, such as power-supply cord or plug is damaged, liquid has been spilled or objects have fallen into the apparatus, the apparatus has been exposed to rain or moisture, does not operate normally, or has been dropped.



- Do not stick metal objects or any other conductive material into the power cord. Do not touch the end of the power cord while it is plugged in.
- Keep the packing anti-moisture material or vinyl packing out of the reach of children. Anti-moisture material is harmful if swallowed. If swallowed by mistake, force the patient to vomit and visit the nearest hospital. Additionally, vinyl packing can cause suffocation. Keep it out of the reach of children.

- CAUTION concerning the Power Cord (Can differ by country):

It is recommended that appliances be placed upon a dedicated circuit; that is, a single outlet circuit which powers only that appliance and has no additional outlets or branch circuits. Check the specification page of this owner's manual to be certain. Do not connect too many appliances to the same AC power outlet as this could result in fire or electric shock. Do not overload wall outlets. Overloaded wall outlets, loose or damaged wall outlets, extension cords, frayed power cords, or damaged or cracked wire insulation are dangerous. Any of these conditions could result in electric shock or fire.

Periodically examine the cord of your appliance, and if its appearance indicates damage or deterioration, unplug it, discontinue use of the appliance, and have the cord replaced with an exact replacement part by an authorized service. Protect the power cord from physical or mechanical abuse, such as being twisted, kinked, pinched, closed in a door, or walked upon. Pay particular attention to plugs, wall outlets, and the point where the cord exits the appliance. Do not move the TV with the power cord plugged in. Do not use a damaged or loose power cord. Be sure to grasp the plug when unplugging the power cord. Do not pull on the power cord to unplug the TV.



- **Warning** - To reduce the risk of fire or electrical shock, do not expose this product to rain, moisture or other liquids. Do not touch the TV with wet hands. Do not install this product near flammable objects such as gasoline or candles, or expose the TV to direct air conditioning.



- Do not expose to dripping or splashing and do not place objects filled with liquids, such as vases, cups, etc. on or over the apparatus (e.g. on shelves above the unit).



- **Grounding**

(Except for devices which are not grounded.)
Ensure that you connect the earth ground wire to prevent possible electric shock (i.e. a TV with a three-prong grounded AC plug must be connected to a three-prong grounded AC outlet). If grounding methods are not possible, have a qualified electrician install a separate circuit breaker. Do not try to ground the unit by connecting it to telephone wires, lightening rods, or gas pipes.

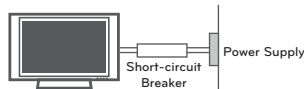

- As long as this unit is connected to the AC wall outlet, it is not disconnected from the AC power source even if the unit is turned off.
- Do not attempt to modify this product in any way without written authorization from LG Electronics. Unauthorized modification could void the user's authority to operate this product.

- **Outdoor Antenna Grounding**

(Can differ by country):

If an outdoor antenna is installed, follow the precautions below. An outdoor antenna system should not be located in the vicinity of overhead power lines or other electric light or power circuits, or where it can come in contact with such power lines or circuits as death or serious injury can occur. Be sure the antenna system is grounded so as to provide some protection against voltage surges and built-up static charges. Section 810 of the National Electrical Code (NEC) in the U.S.A. provides information with respect to proper grounding of the mast and supporting structure, grounding of the lead-in wire to an antenna discharge unit, size of grounding conductors, location of antenna discharge unit, connection to grounding electrodes and requirements for the grounding electrode.

Antenna grounding according to the National Electrical Code, ANSI/NFPA 70

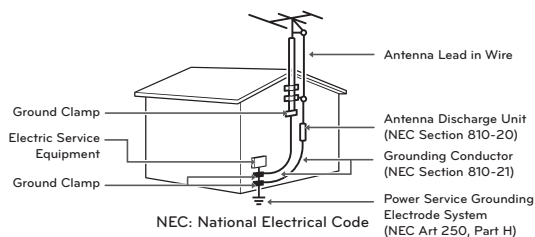

- **Cleaning**

When cleaning, unplug the power cord and wipe gently with a soft cloth to prevent scratching. Do not spray water or other liquids directly on the TV as electric shock may occur. Do not clean with chemicals such as alcohol, thinners or benzene.

- **Moving**

Make sure the product is turned off, unplugged and all cables have been removed. It may take 2 or more people to carry larger TVs. Do not press or put stress on the front panel of the TV.

- **Ventilation**

Install your TV where there is proper ventilation. Do not install in a confined space such as a bookcase. Do not cover the product with cloth or other materials while plugged. Do not install in excessively dusty places.

- If you smell smoke or other odors coming from the TV, unplug the power cord and contact an authorized service center.
- Keep the product away from direct sunlight.
- Never touch this apparatus or antenna during a thunder or lightning storm.
- When mounting a TV on the wall, make sure not to install the TV by hanging the power and signal cables on the back of the TV.
- Do not allow an impact shock or any objects to fall into the product, and do not drop anything onto the screen.
- **Disconnecting the Main Power**
The power outlet used with this device must remain easily accessible.
- Store the accessories (battery, etc.) in a safe location out of the reach of children.
- This apparatus use batteries. In your community there might be regulations that require you to dispose of these batteries properly due to environmental considerations. Please contact your local authorities for disposal or recycling information.
- Do not dispose of batteries in a fire.
- Do not short circuit, disassemble or allow the batteries to overheat.

- **Dot Defect**

The Plasma or LCD panel is a high technology product with resolution of two million to six million pixels. In a very few cases, you could see fine dots on the screen while you're viewing the TV. Those dots are deactivated pixels and do not affect the performance and reliability of the TV.

- **Generated Sound**

“Cracking” noise: A cracking noise that occurs when watching or turning off the TV is generated by plastic thermal contraction due to temperature and humidity. This noise is common for products where thermal deformation is required.

Electrical circuit humming/panel buzzing: A low level noise is generated from a high-speed switching circuit, which supplies a large amount of current to operate a product. It varies depending on the product.

This generated sound does not affect the performance and reliability of the product.

- Take care not to touch the ventilation openings. When watching the TV for a long period, the ventilation openings may become hot. This does not affect the performance of the product or cause defects in the product.
- If the TV feels cold to the touch, there may be a small “flicker” when it is turned on. This is normal, there is nothing wrong with TV. Some minute dot defects may be visible on the screen, appearing as tiny red, green, or blue spots. However, they have no adverse effect on the TV’s performance. Avoid touching the LCD screen or holding your finger(s) against it for long periods of time. Doing so may produce some temporary distortion effects on the screen.
- **Network**
For seamless internet streaming LG recommends a stable 4Mbps broadband speed and 1.5Mbps as a minimum.

Preventing “Image burn” or “Burn-in” on your TV screen

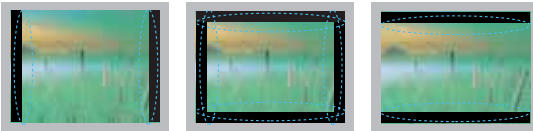

- If a fixed image displays on the TV screen for a long period of time, it will be imprinted and become a permanent disfigurement on the screen. This is “image burn” or “burn-in” and not covered by the warranty.
- If the aspect ratio of the TV is set to 4:3 for a long period of time, image burn may occur on the letterboxed area of the screen.
- Avoid displaying a fixed image on the TV screen for a long period of time (2 or more hours for LCD, 1 or more hours for the Plasma TV) to prevent image burn.

For USA and Canada

FCC NOTICE

This equipment has been tested and found to comply with the limits for a Class B digital device, pursuant to Part 15 of the FCC Rules. These limits are designed to provide reasonable protection against harmful interference in a residential installation. This equipment generates, uses and can radiate radio frequency energy and, if not installed and used in accordance with the instructions, may cause harmful interference to radio communications. However, there is no guarantee that interference will not occur in a particular installation. If this equipment does cause harmful interference to radio or television reception, which can be determined by turning the equipment off and on, the user is encouraged to try to correct the interference by one or more of the following measures:

- Reorient or relocate the receiving antenna.
- Increase the separation between the equipment and the receiver.
- Connect the equipment to an outlet on a circuit different from that to which the receiver is connected.
- Consult the dealer or an experienced radio/TV technician for help.

This device complies with part 15 of the FCC Rules. Operation is subject to the following two conditions: (1) this device may not cause harmful interference and (2) this device must accept any interference received, including interference that may cause undesired operation of the device.

Any changes or modifications in construction of this device which are not expressly approved by the party responsible for compliance could void the user’s authority to operate the equipment.

NOTE TO CABLE/TV INSTALLER

This reminder is provided to call the CATV system installer’s attention to Article 820-40 of the National Electric Code (U.S.A.). The code provides guidelines for proper grounding and, in particular, specifies that the cable ground shall be connected to the grounding system of the building, as close to the point of the cable entry as practical.

Viewing 3D Imaging

WARNING

Viewing Environment

- Viewing Time
 - When watching 3D contents, take 5 - 15 minute breaks every hour. Viewing 3D contents for a long period of time may cause headache, dizziness, fatigue or eye strain.

Those that have a photosensitive seizure or chronic illness

- Some users may experience a seizure or other abnormal symptoms when they are exposed to a flashing light or particular pattern from 3D contents.
- Do not watch 3D videos if you feel nausea, are pregnant and/ or have a chronic illness such as epilepsy, cardiac disorder, or blood pressure disease, etc.
- 3D Contents are not recommended to those who suffer from stereo blindness or stereo anomaly. Double images or discomfort in viewing may be experienced.
- If you have strabismus (cross-eyed), amblyopia (weak eyesight) or astigmatism, you may have trouble sensing depth and easily feel fatigue due to double images. It is advised to take frequent breaks than the average adult.
- If your eyesight varies between your right and left eye, revise your eyesight prior to watching 3D contents.

Symptoms which require discontinuation or refraining from watching 3D contents

- Do not watch 3D contents when you feel fatigue from lack of sleep, overwork or drinking.
- When these symptoms are experienced, stop using/watching 3D contents and get enough rest until the symptom subsides.
 - Consult your doctor when the symptoms persist. Symptoms may include headache, eyeball pain, dizziness, nausea, palpitation, blurriness, discomfort, double image, visual inconvenience or fatigue.

**CAUTION****Viewing Environment**

- Viewing Distance
 - Maintain a distance of at least twice the screen diagonal length when watching 3D contents. If you feel discomfort in viewing 3D contents, move further away from the TV.

Viewing Age

- Infants / Children
 - Usage/ Viewing 3D contents for children under the age of 5 are prohibited.
 - Children under the age of 10 may overreact and become overly excited because their vision is in development (for example: trying to touch the screen or trying to jump into it. Special monitoring and extra attention is required for children watching 3D content.
 - Children have greater binocular disparity of 3D presentations than adults because the distance between the eyes is shorter than one of adults. Therefore they will perceive more stereoscopic depth compared to adults for the same 3D image.
- Teenagers
 - Teenagers under the age of 19 may experience eye strain when watching 3D video. Advise them not to watch 3D videos for a long time when they are tired.
- Elderly
 - The elderly may perceive less of a 3D effect than the youth. Do not sit closer to the TV than the recommended distance.

Cautions when using the 3D glasses

- Make sure to use LG 3D glasses. Otherwise, you may not be able to view 3D videos properly.
- Do not use 3D glasses instead of your normal glasses, sunglasses or protective goggles.
- Using modified 3D glasses may cause eye strain or image distortion.
- Do not keep your 3D glasses in extremely high or low temperatures. It will cause deformation.
- The 3D glasses are fragile and are easy to be scratched. Always use a soft, clean piece of cloth when wiping the lenses. Do not scratch the lenses of the 3D glasses with sharp objects or clean/wipe them with chemicals.

Unpacking

Check your product box for the following items. If there are any missing accessories, contact the local dealer where you purchased your product. The illustrations in this manual may differ from the actual product and item.



CAUTION

- Do not use any unapproved items to ensure the safety and product life span.
- Any damages or injuries by using unapproved items are not covered by the warranty.
- Some models appear to have a thin film on the screen. It is actually part of the screen, do not remove it.



NOTE

- The items supplied with your product may vary depending on the model.
- Product specifications or contents of this manual may be changed without prior notice due to upgrade of product functions.
- For an optimal connection, HDMI cables and USB devices should have bezels less than 10 mm (0.39 inches) thick and 18 mm (0.7 inches) width.
- Use an extension cable that supports USB 2.0 if the USB cable or USB memory stick does not fit into your TV's USB port.

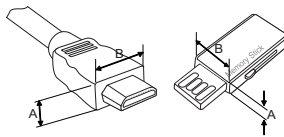

*A ≦ 10 mm (0.39 inches)

*B ≦ 18 mm (0.7 inches)

For GA6400, GA6450 series

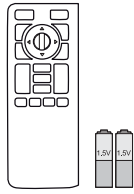

● WERTY Remote Control,
Batteries (AA)
(See p.16)

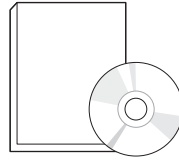

Owner's Manual,
CD Manual



Power Cord



Cinema 3D Glasses

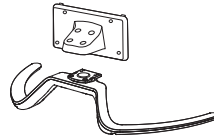

Stand Base, Stand Body
(See p.21)



Stand Screws
8 EA, M4 x 14
(See p.21)



Wall Mount Inner Spacers
4 EA
(See p.24)



Cable Management
2 EA
(See p.25)

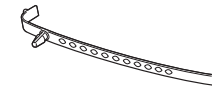

Cable Holder
(See p.25)

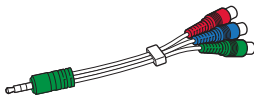

Component Video Cable
(See p.32)

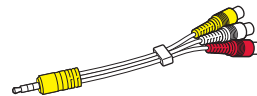

Composite Video Cable
(See p.32,33)

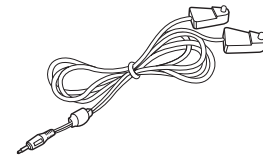

IR Blaster Cable
(See p.64)

For GA7900 series

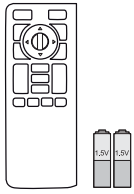

● WERTY Remote Control,
Batteries (AA)
(See p.16)

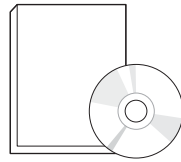

Owner's Manual,
CD Manual



Power Cord



Cinema 3D Glasses

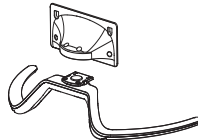

Stand Base, Stand Body
(See p.22)



Stand Screws
8 EA, M4 x 14
(See p.22)

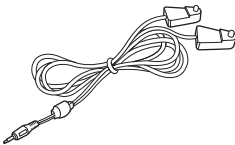

IR Blaster Cable
(See p.64)



Cable Management
2 EA
(See p.25)

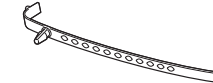

Cable Holder
(See p.25)

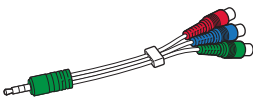

Component Video Cable
(See p.32)

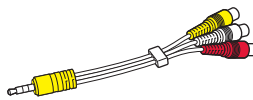

Composite Video Cable
(See p.32,33)

Optional Extras

Optional extras can be changed or modified for quality improvement without any notification. Contact your dealer for buying these items. These devices only work with certain models. The model name or design may be changed manufacturer's circumstances or policies.



AG-F***
Cinema 3D Glasses



AG-F*DP**
Dual Play Glasses

Parts and Buttons

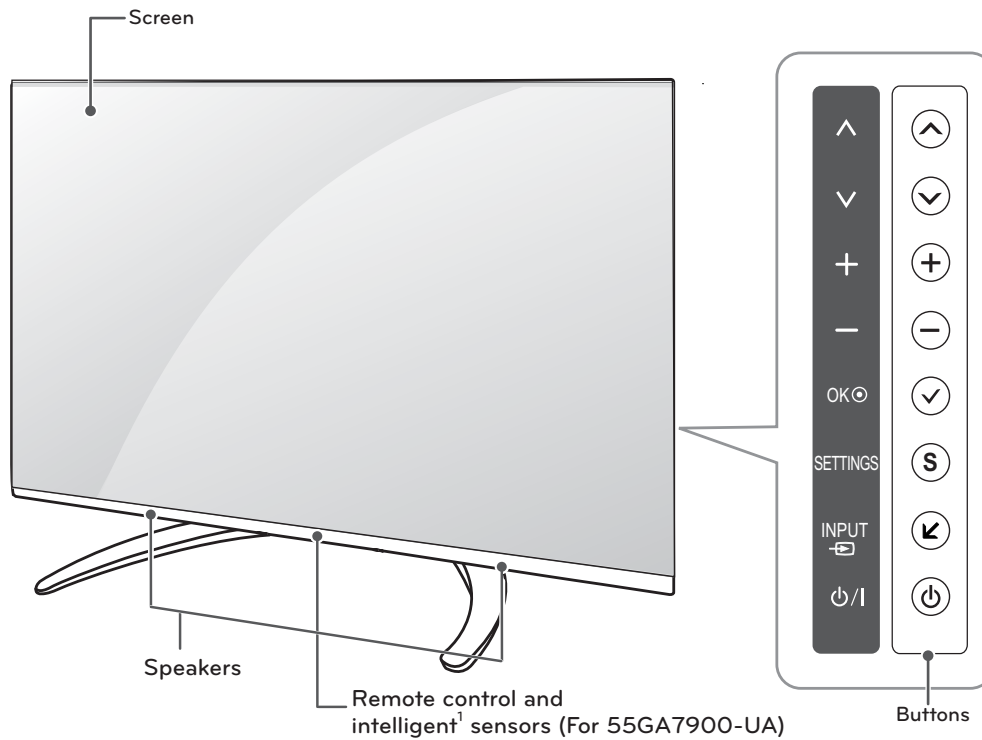

ENGLISH

Button	Description
▲ / ▼ (^ / v)	Scrolls through the saved channels.
⊕ / ⊖ (+ / -)	Adjusts the volume level.
✓ (OK ◉)	Selects the highlighted menu option or confirms an input.
S (SETTINGS)	Accesses the main menus, or saves your input and exits the menus.
⏪ (INPUT ⏪)	Changes the input source.
⏻ (⏻ / I)	Turns the power on or off.

1. Intelligent sensor - Adjusts the image quality and brightness based on the surrounding environment. (For 55GA7900)

Remote Control Functions

Inserting batteries

When you use the remote control for the first time, you should insert the batteries to remote control.

1. Open the battery cover as shown below.

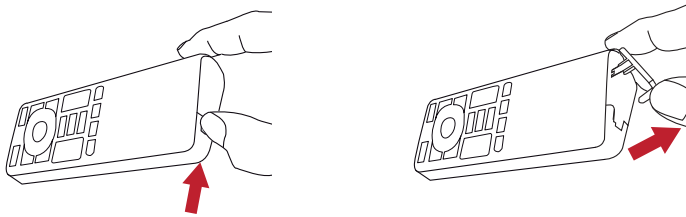

2. Insert batteries into the remote control.

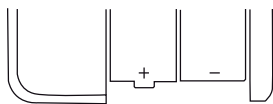

3. Close the battery cover as shown below.

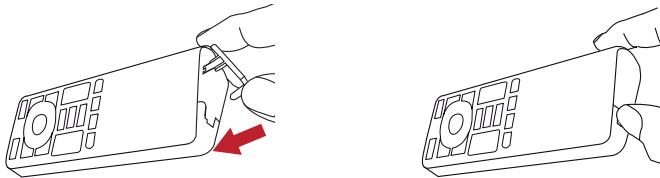

ENGLISH

 **CAUTION**

- Do not mix old and new batteries, as this may damage the remote control.

Remote Control Side - Front



ENGLISH

QWERTY Side - Back

ESC
Cancel state or command
Tab
Move focus to the next step
Shift
Combination key for upper letter
Back
Move to previous or superior step.

X
Delete text
Enter
Finish text input

EXT PWR (Fn+Z)
Turn on/off external device
AMP PWR (Fn+X)
Turn on/off amplifier



Fn
Combination key with other keys
Ctrl
Combination key with other keys

Space
Enter a space

⌕(Fn+↑)/⌕(Fn+↓)
Zoom in/out
AMP VOL - (Fn+←)/AMP VOL + (Fn+→)
Volume up/down on audio receiver

TV
Activate TV player app
PIP
Activate/Deactivate PIP
INFO
Show channel information (available only on Live TV)
DVR
Enter DVR menu

ENGLISH

NOTE

- To enjoy Onlive application, you should purchase the onlive controller. (www.onlive.com)

Registering the remote control

The Remote Control operates by pairing with your TV. When turning the TV on for the first time, please pair the remote to the TV.

How to register the remote control

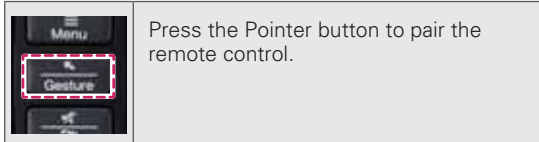

How to re-register the remote control after registration failure

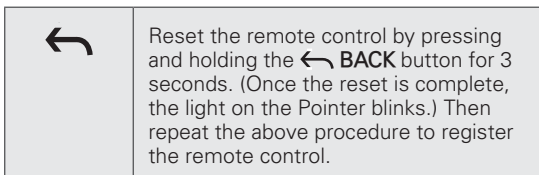

How to use the zoom in/out gestures

- 1 Press and hold the Gesture button for 2 seconds.
- 2 While holding the Gesture button, draw a circle in a clockwise direction to zoom in or counter-clockwise direction to zoom out.
(This feature is only available in the Chrome browser.)

Voice Search for Google TV

You can use the Voice Search to control and find your content easily.

Example)

- "open" [app name] : Open the application
- "go to" [cnn.com] : Go to the website on Google Chrome
- "watch" [Avatar] : Open the movie on Prime Time

Precautions to take when using the remote control

- Use the remote control within the maximum communication distance (10 m, 32.8 ft). Using the remote control beyond this distance, or with an object obstructing it, may cause a communication failure.
- A communication failure may occur due to nearby devices. Electrical devices such as a microwave oven or wireless LAN product may cause interference, as these use the same bandwidth (2.4 GHz) as the Remote Control.
- The Remote Control may be damaged or may malfunction if it is dropped or receives a heavy impact.
- Manufacturer and installer cannot provide service related to human safety as the applicable wireless device has possibility of electric wave interference.
- It is recommended that an Access Point (AP) be located more than 1 m (3.28 ft) away from the TV. If the AP is installed closer than 1 m (3.28 ft), the remote control may not perform as expected due to frequency interference.
- The TV only supports the included LG QWERTY remote control. It may be compatible with a keyboard that meets HID specifications.
- The cursor automatically stays still when the QWERTY keyboard is facing up in order to prevent any wobbling cursor.

INSTALLATION

Lifting and moving the TV

When moving or lifting the TV, read the following to prevent the TV from being scratched or damaged and for safe transportation regardless of its type and size.

CAUTION

- Avoid touching the screen at all times, as this may result in damage to the screen.
- It is recommended to move the TV in the box or packing material that the TV originally came in.
- Before moving or lifting the TV, disconnect the power cord and all cables.
- When holding the TV, the screen should face away from you to avoid damage.



- Hold the top and bottom of the TV frame firmly. Make sure not to hold the transparent part, speaker, or speaker grill area.

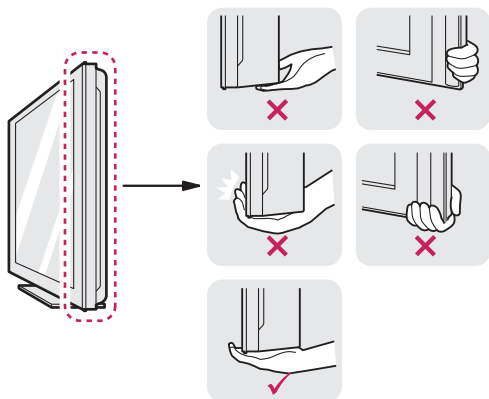

- When transporting a large TV, there should be at least 2 people.
- When transporting the TV by hand, hold the TV as shown in the following illustration.

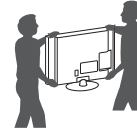

- When transporting the TV, do not expose the TV to jolts or excessive vibration.
- When transporting the TV, keep the TV upright, never turn the TV on its side or tilt towards the left or right.

Setting up the TV

You can mount your TV to a wall or attach the stand if you wish to place the TV on an entertainment center or other furniture.

Attaching the stand

If you are not mounting the TV to a wall, use the following instructions to attach the stand.

⚠ CAUTION

- When attaching the stand to the TV set, place the screen facing down on a cushioned table or flat surface to protect the screen from scratches.
- Make sure that the screws are fastened tightly. (If they are not fastened securely enough, the TV may tilt forward after being installed.)
- Do not tighten the screws with too much force; otherwise they may be damaged and come loose later.

! NOTE

- Remove the stand before installing the TV on a wall mount by performing the stand attachment in reverse.

For GA6400, GA6450 series

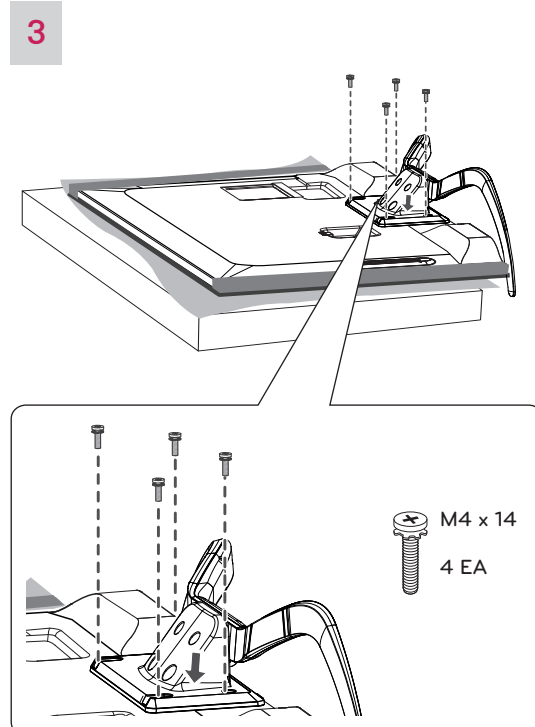
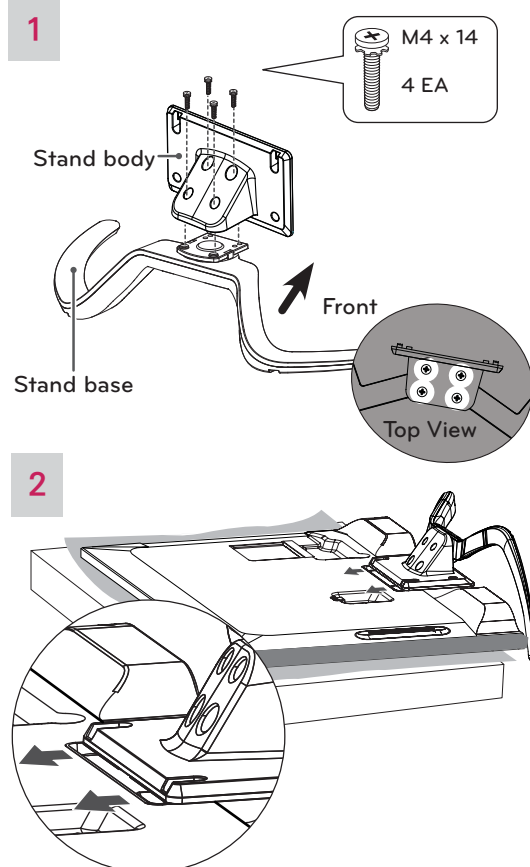

For GA7900 series

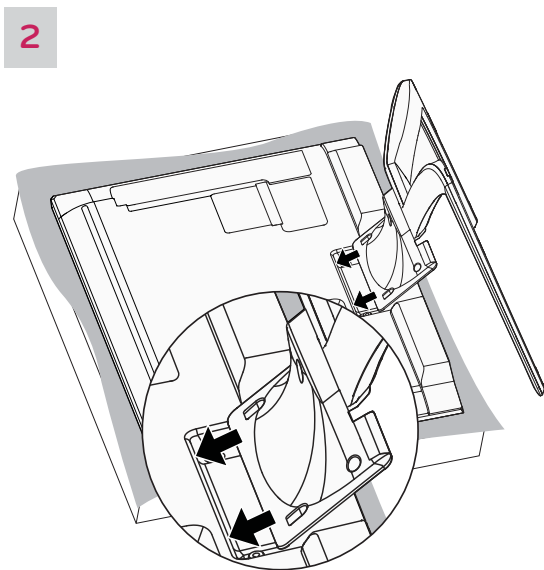
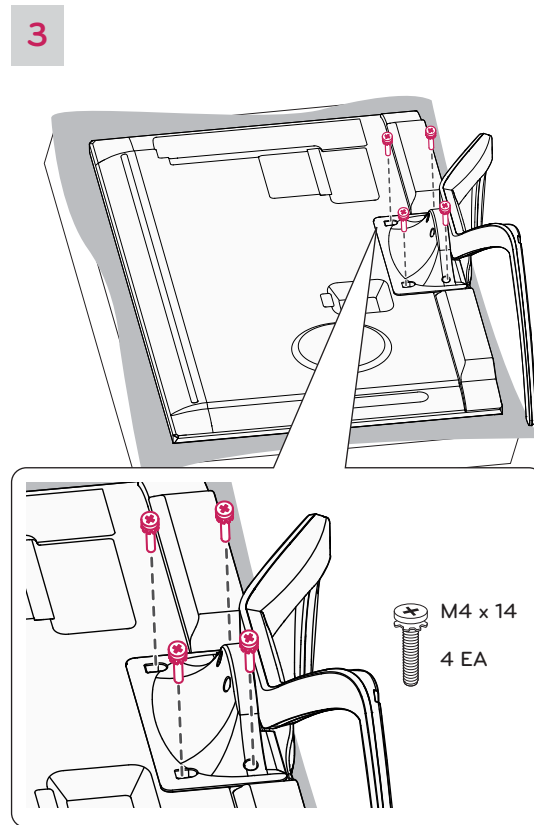
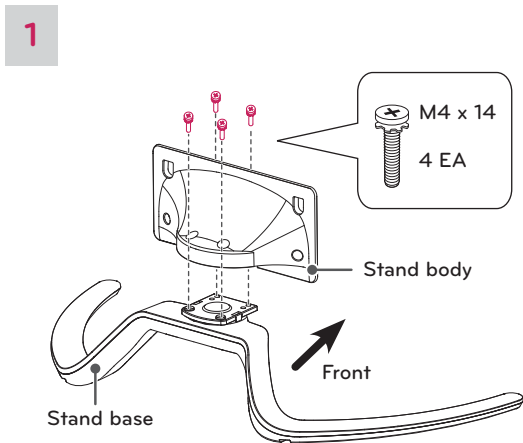

ENGLISH

Mounting on a table

- Lift and tilt the TV into its upright position on a table.
 - Leave a 10 cm (4 inch) (minimum) space from the wall for proper ventilation.

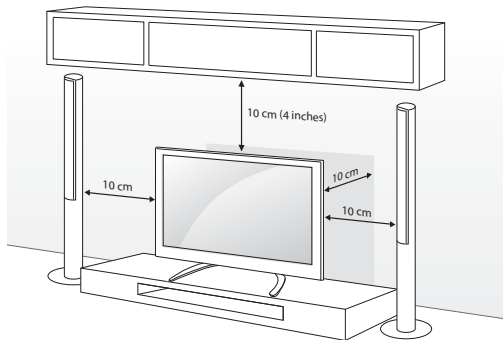

- Connect the power cord to a wall outlet.



CAUTION

- Do not place the TV near or on sources of heat, as this may result in fire or other damage.

Adjusting the angle of the TV to suit view

Swivel 15 degrees to the left or right and adjust the angle of the TV to suit your view.

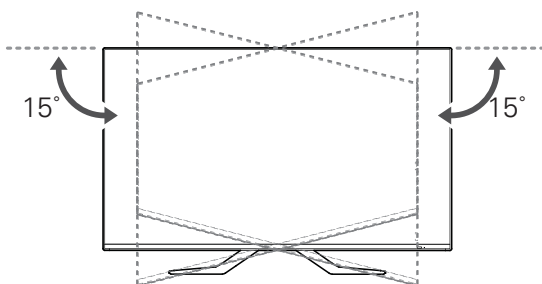

NOTE

- When adjusting the angle of the TV, watch out for your fingers.
- Personal injury may occur if hands or fingers are pinched. If the product is tilted too much, it may fall, causing damage or injury.

Securing the TV to a wall (optional)

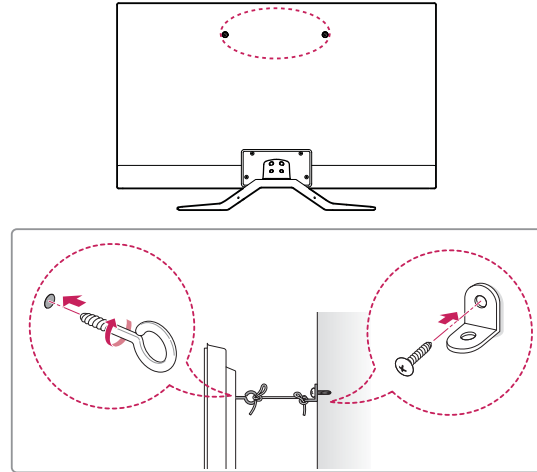

- Insert and tighten the eye-bolts, or TV brackets and bolts on the back of the TV.
 - If there are bolts inserted at the eye-bolts position, remove the bolts first.
- Mount the wall brackets with the bolts to the wall.
 - Match the location of the wall bracket and the eye-bolts on the rear of the TV.
- Connect the eye-bolts and wall brackets tightly with a sturdy rope.
 - Make sure to keep the rope horizontal with the flat surface.



CAUTION

- Make sure that children do not climb on or hang on the TV.



NOTE

- Use a platform or cabinet that is strong and large enough to support the TV securely.
- Brackets, bolts and ropes are optional. You can obtain additional accessories from your local dealer.

Mounting on a wall

An optional wall mount can be used with your LG Television. Consult with your local dealer for a wall mount that supports the VESA standard used by your TV model. Carefully attach the wall mount bracket at the rear of the TV. Install the wall mount bracket on a solid wall perpendicular to the floor. If you are attaching the TV to other building materials, please contact qualified personnel to install the wall mount. Detailed instructions will be included with the wall mount. We recommend that you use an LG brand wall mount.

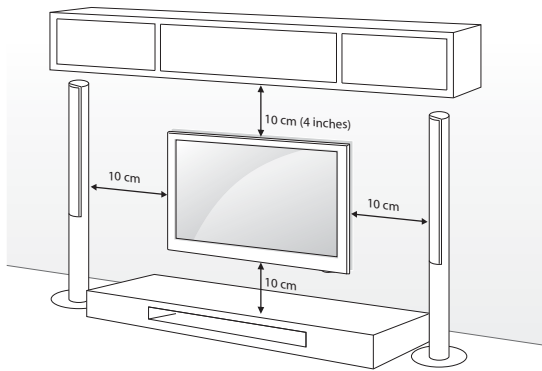

ENGLISH

Make sure to use screws and wall mounts that meet the VESA standard. Standard dimensions for the wall mount kits are described in the following table.

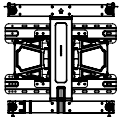
Model	42/47/50/55/60GA6400 42/47/50/55/60GA6450 47/55GA7900
VESA	400 x 400
Standard screw	M6
Number of screws	4
Wall mount bracket (optional)	LSW430B 

⚠ CAUTION

- Disconnect the power first, and then move or install the TV. Otherwise electric shock may occur.
- If you install the TV on a ceiling or slanted wall, it may fall and result in severe injury. Use an authorized LG wall mount and contact the local dealer or qualified personnel.
- Do not over tighten the screws as this may cause damage to the TV and void your warranty.
- Use the screws and wall mounts that meet the VESA standard. Any damages or injuries by misuse or using an improper accessory are not covered by the warranty.

! NOTE

- Use the screws that are listed on the VESA standard screw specifications.
- The wall mount kit includes an installation manual and necessary parts.
- The wall mount bracket is optional. You can obtain additional accessories from your local dealer.
- The length of screws may differ depending on the wall mount. Make sure to use the proper length.
- For more information, refer to the manual supplied with the wall mount.
- When attaching a third-party wall mounting bracket to the TV, insert the wall mount inner spacers into the TV wall mount holes to move your TV in vertical angle. Please make sure not to use the spacers for LG wall mounting bracket.

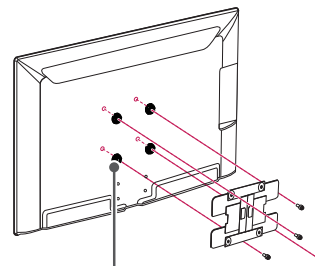

Wall Mount Inner Spacer
(For GA6400, 6450 Series)

Tidying cables

- This section uses illustrations of the GA6400 series.

1 Gather the cables with the stand rear cover.

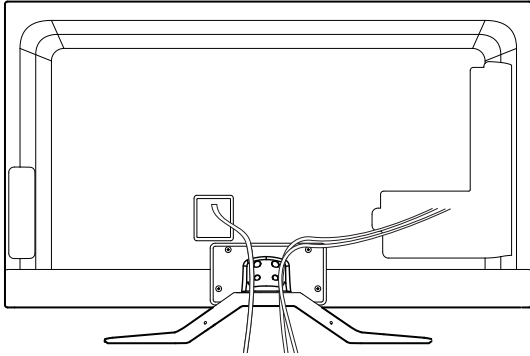

2 Install the cable management as shown.

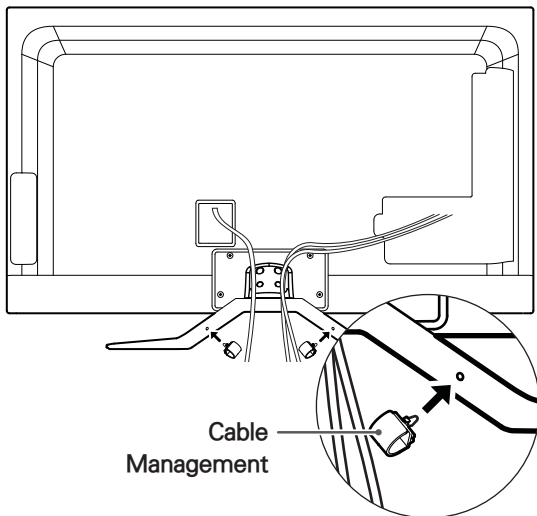

3 Gather and bind the cables with the cable holder.

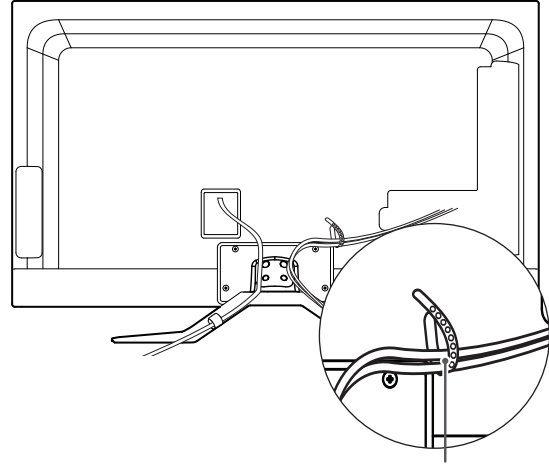

Cable Holder

⚠ CAUTION

- Do not move the TV by holding the cable holder and cable management clip, as the cable holders may break, and injuries and damage to the TV may occur.

CONNECTIONS

- This section uses illustrations of the GA6400 series.

Connect various external devices to the TV and switch input modes to select an external device. For more information on an external device's connection, refer to the manual provided with each device.

Available external devices are: HD receivers, DVD players, VCRs, audio systems, USB storage devices, PC, gaming devices, and other external devices.

! NOTE

- If you record a TV program on a DVD recorder or VCR, make sure to connect the TV signal input cable to the TV through a DVD recorder or VCR. For more information on recording, refer to the manual provided with the connected device.
- The external device connections shown may differ slightly from illustrations in this manual.
- Connect external devices to the TV regardless of the order of the TV port.
- If you connect a gaming device to the TV, use the cable supplied with the gaming device.
- Refer to the external equipment's manual for operating instructions.

Connecting to an antenna or cable

Connect an antenna, cable, or cable box to watch TV while referring to the following. The illustrations may differ from the actual items and a RF cable is optional.

ENGLISH

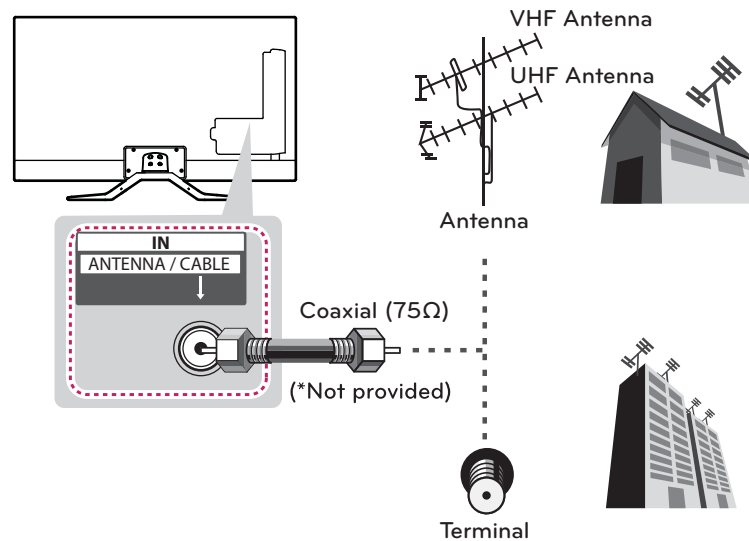

! CAUTION

- Make sure not to bend the copper wire of the RF cable.

Copper wire

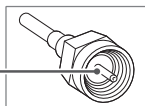

- Complete all connections between devices, and then connect the power cord to the power outlet to prevent damage to your TV.

! NOTE

- Use a signal splitter to use more than 2 TVs.
- Visit <http://lgknowledgebase.com> for more information about the antenna and cable connection. Search for antenna.
- DTV Audio Supported Codec: MPEG, Dolby Digital

Network connection

Connect the TV to a router with a LAN cable. Or, connect with Wi-Fi by accessing Network Setup in the initial Setup Wizard. For seamless internet streaming LG recommends a stable 4 Mbps broadband speed and 1.5 Mbps as a minimum.

Wireless Network Connection

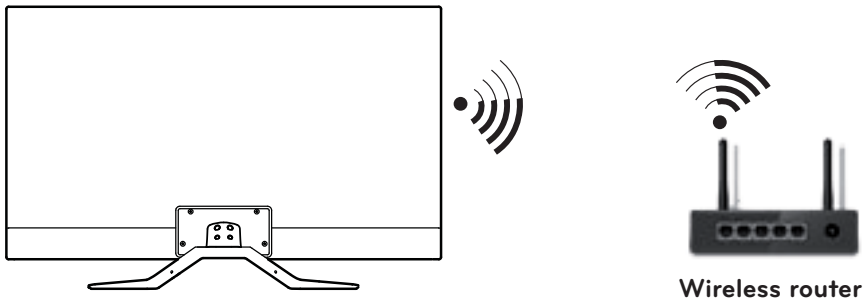

Wired Network Connection

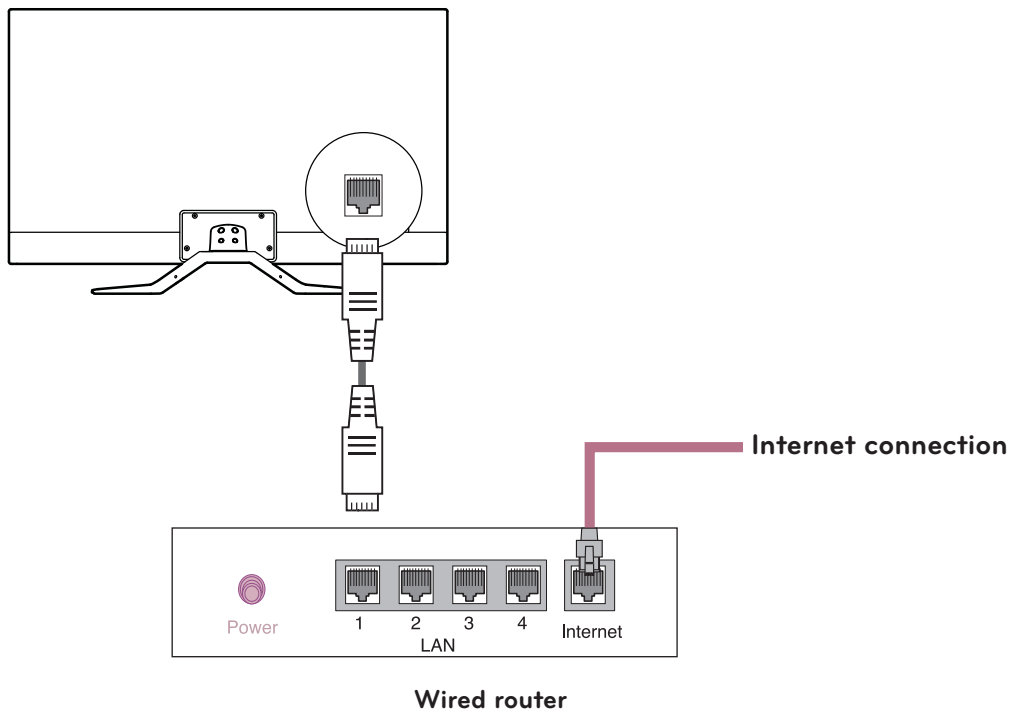

Connection Overview

Connect various external devices to the ports on the TV back panel.

- 1 Find an external device you want to connect to your TV as shown in the following illustration.
- 2 Check the connection type of the external device.
- 3 Go to the appropriate illustration and check the connection details.

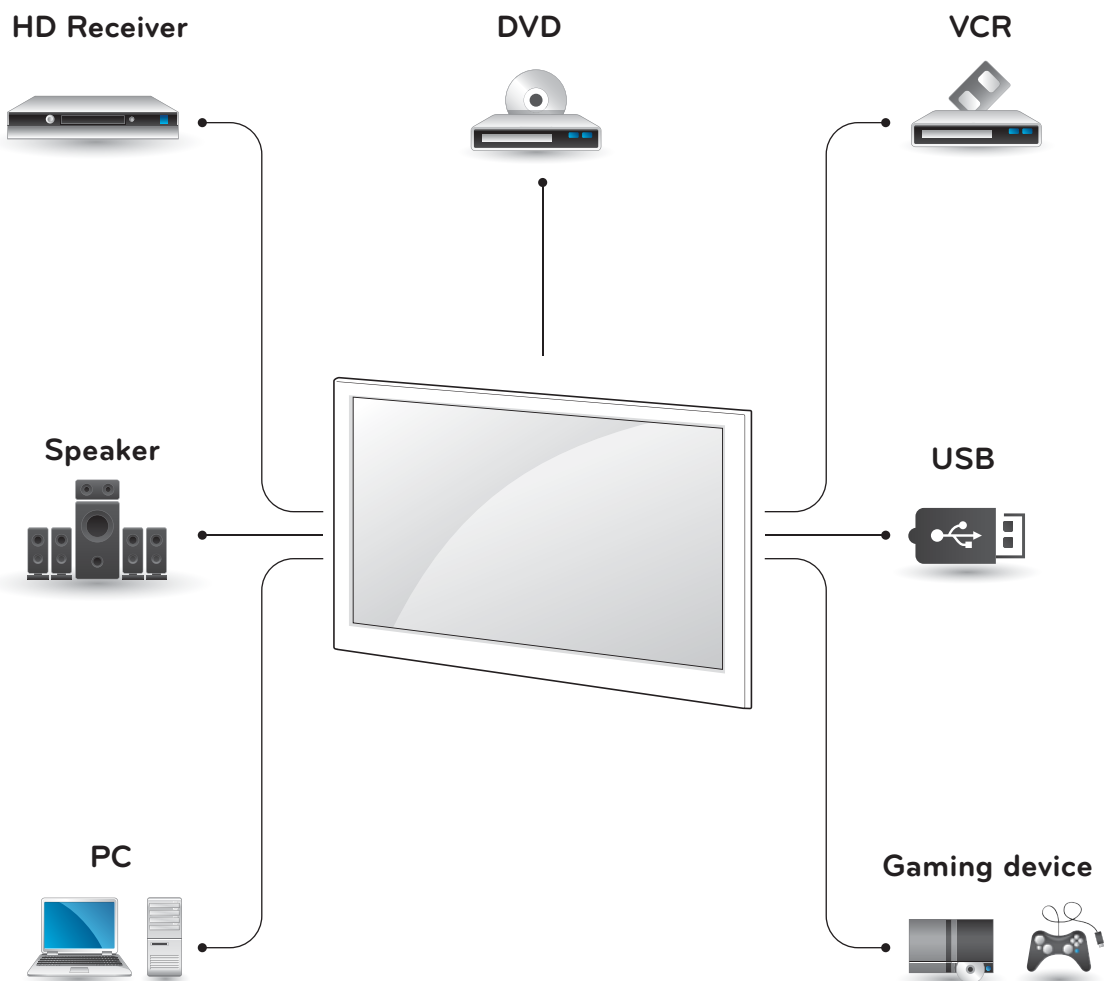

ENGLISH

Connecting to a HD receiver, DVD Player, or VCR

Connect a HD receiver, DVD Player, or VCR to the TV and select an appropriate input mode.

HDMI Connection

HDMI is the best way to connect a device.

Transmits digital video and audio signals from an external device to the TV. Connect the external device and the TV with an HDMI cable as shown in the following illustration.

NOTE

- High Speed HDMI™ Cables carry an HD signal up to 1080p and higher.
- HDMI Audio supported Format: Dolby Digital, DTS, PCM
(Up to 192 kHz, 32 kHz / 44.1 kHz / 48 kHz / 88 kHz / 96 kHz / 176 kHz / 192 kHz)

Choose any HDMI input port to connect.
It does not matter which port you use.

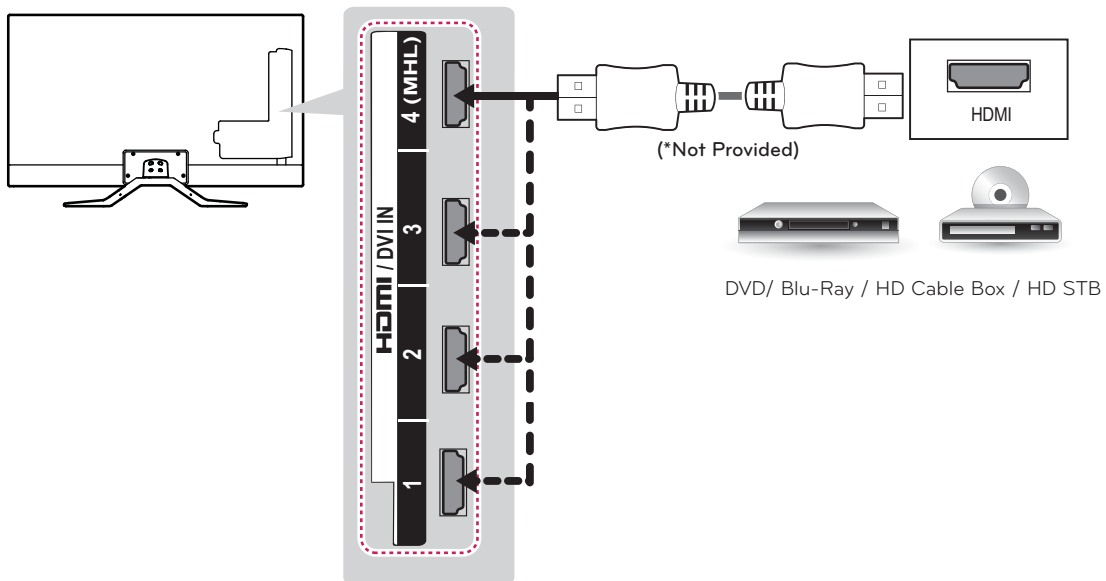

DVI to HDMI Connection

Transmits the digital video signal from an external device to the TV. Connect the external device and the TV with the DVI-HDMI cable as shown in the following illustration. To transmit an audio signal, connect an audio cable.

Choose any HDMI input port to connect.
It does not matter which port you use.

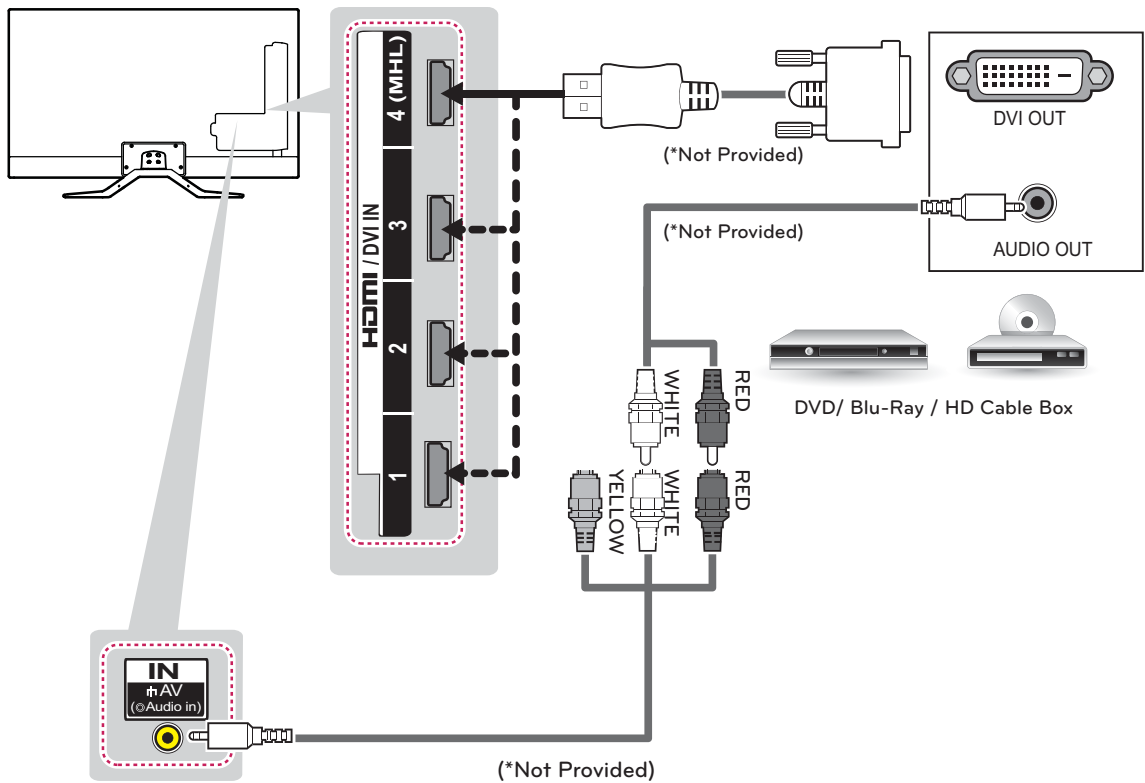

ENGLISH

Connecting to a mobile phone

Mobile High-definition Link (MHL) is an interface for transmitting digital audiovisual signals from mobile phones to television sets.

! NOTE

- Connect the mobile phone to the HDMI IN 4 (MHL) port to view the phone screen on the TV.
- This only works for the MHL-enabled phone.
- With some MHL supporting mobile phones, you can use the TV remote to control the phone.
- An MHL passive cable is needed to connect the TV and a mobile phone.
- Remove the MHL cable from the TV when:
 - the MHL function is disabled
 - your mobile device is fully charged in standby mode

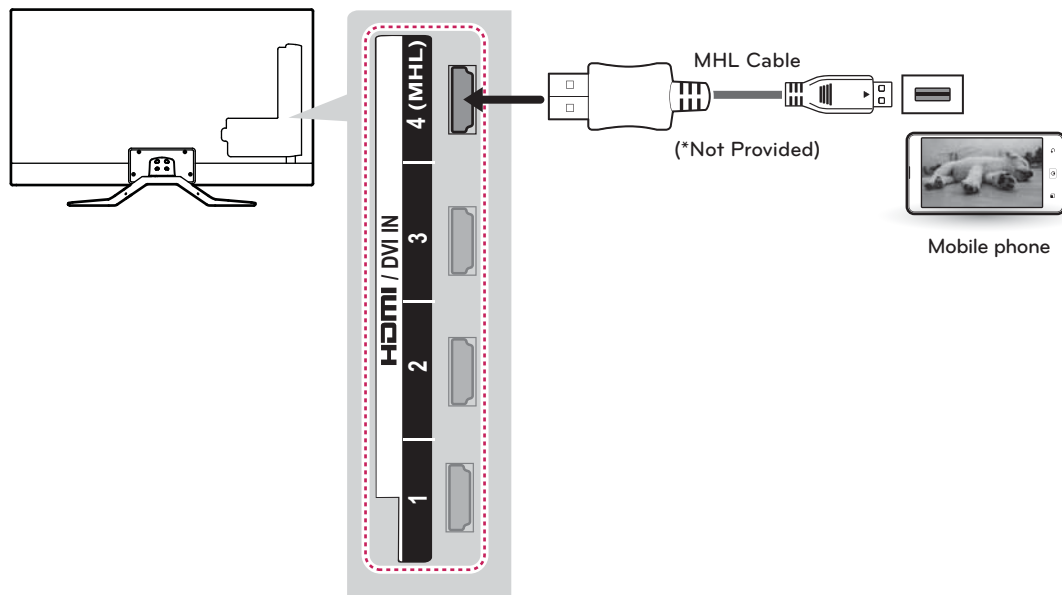

Component Connection

Transmits the analog video and audio signals from an external device to the TV. Connect the external device and the TV with the component cable as shown in the following illustration.

NOTE

- If cables are installed incorrectly, it could cause the image to display in black and white or with distorted color.
- Check to ensure each cable is matched with the corresponding color connection.

ENGLISH

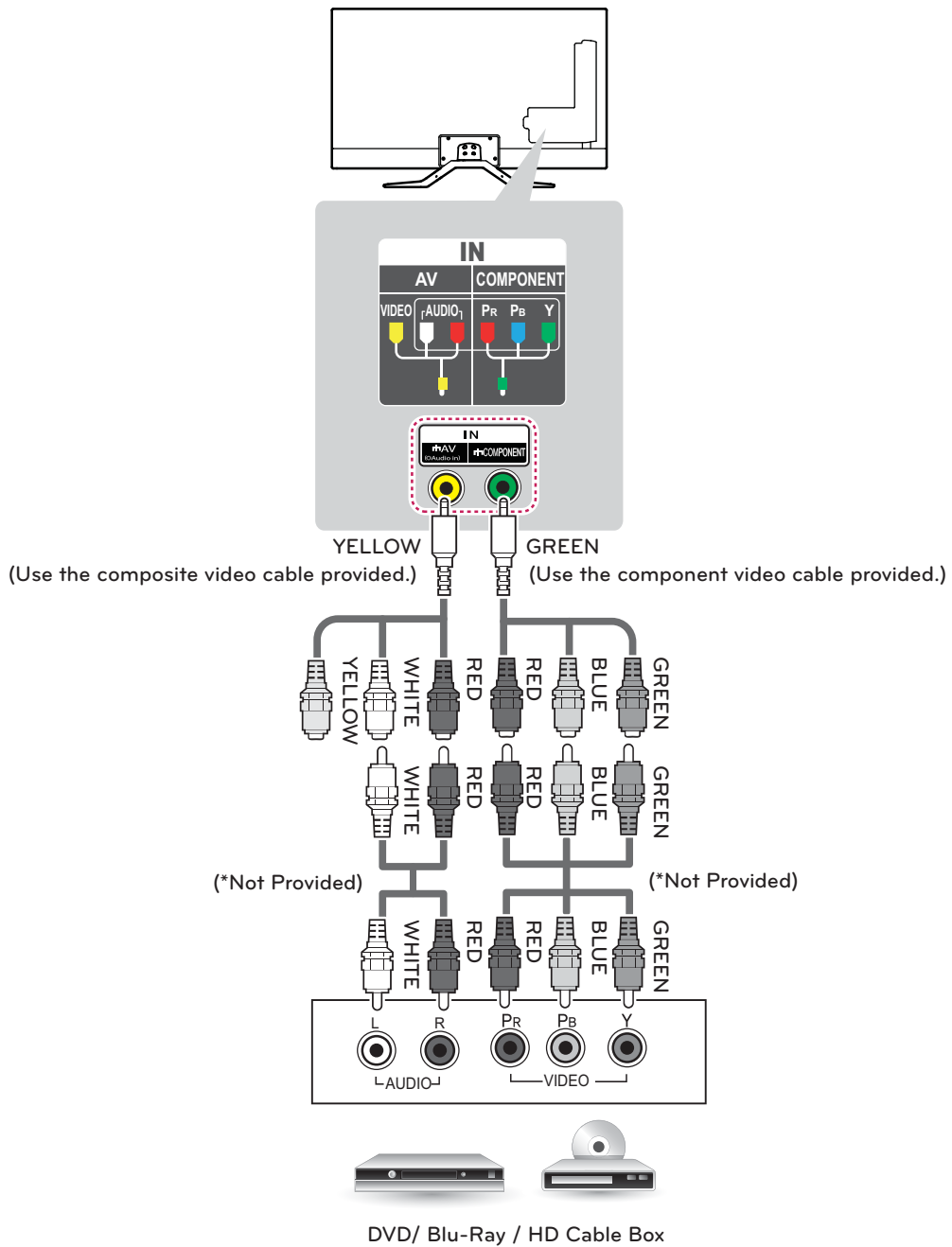

Composite Connection

Transmits the analog video and audio signals from an external device to the TV. Connect the external device and the TV with the composite cable as shown in the following illustration.

NOTE

- If you have a mono VCR, connect the audio cable from the VCR to the AUDIO L/MONO jack of the TV.
- Check to ensure the cables are matched with the corresponding color connection.

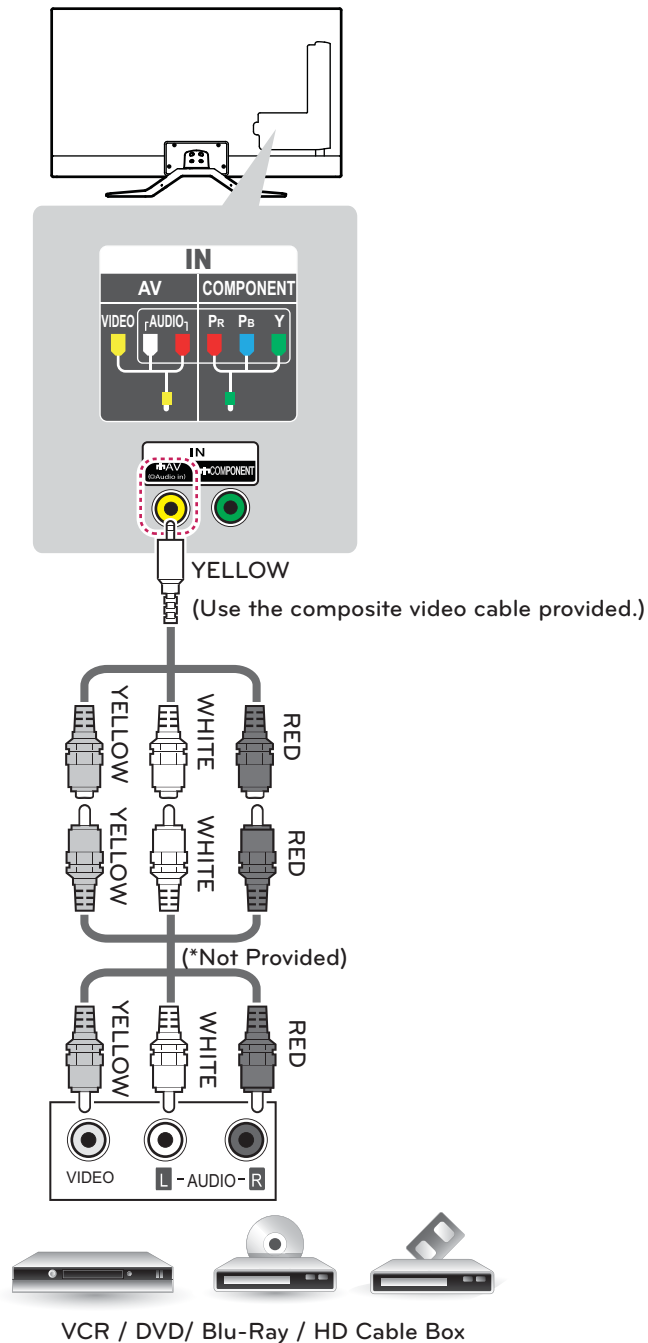

Connecting a PC

NOTE

- It is recommended to use a TV with an HDMI connection for the best image quality.
- Depending on the graphics card, DOS mode may not work if a HDMI to DVI Cable is in use.
- In PC mode, there may be noise associated with the resolution, vertical pattern, contrast or brightness. If noise is present, change the PC output to another resolution, change the refresh rate to another rate or adjust the brightness and contrast on the PICTURE menu until the picture is clear.
- The synchronization input form for Horizontal and Vertical frequencies is separate.
- Depending on the graphics card, some resolution settings may not allow the image to be positioned on the screen properly.

HDMI Connection or DVI to HDMI Connection

Choose method A or B to make connection.

Method A: HDMI Connection

Choose any HDMI input port to connect.
It does not matter which port you use.

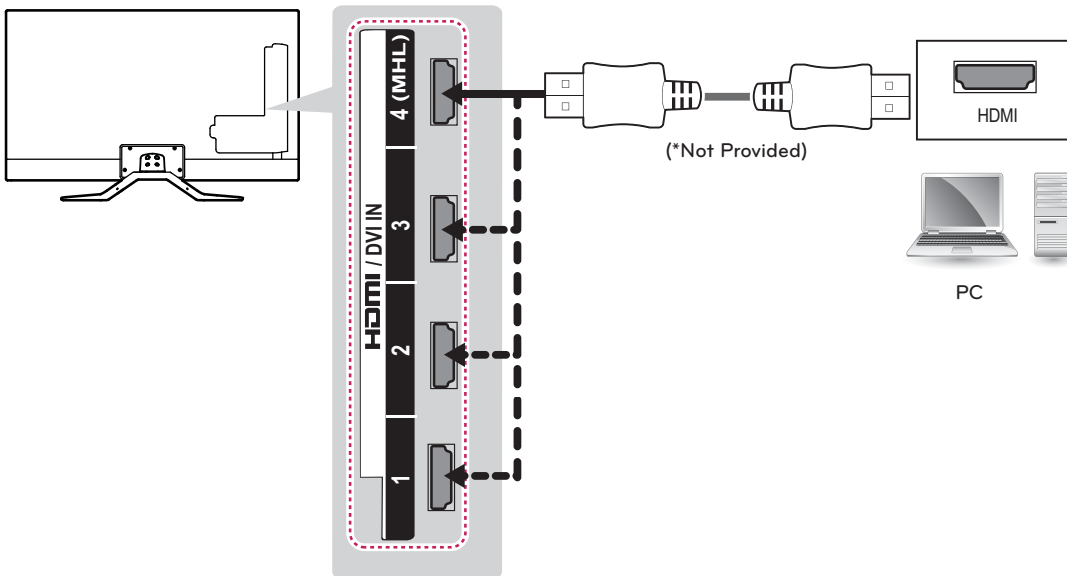

Method B: DVI to HDMI Connection

Choose any HDMI input port to connect.
It does not matter which port you use.

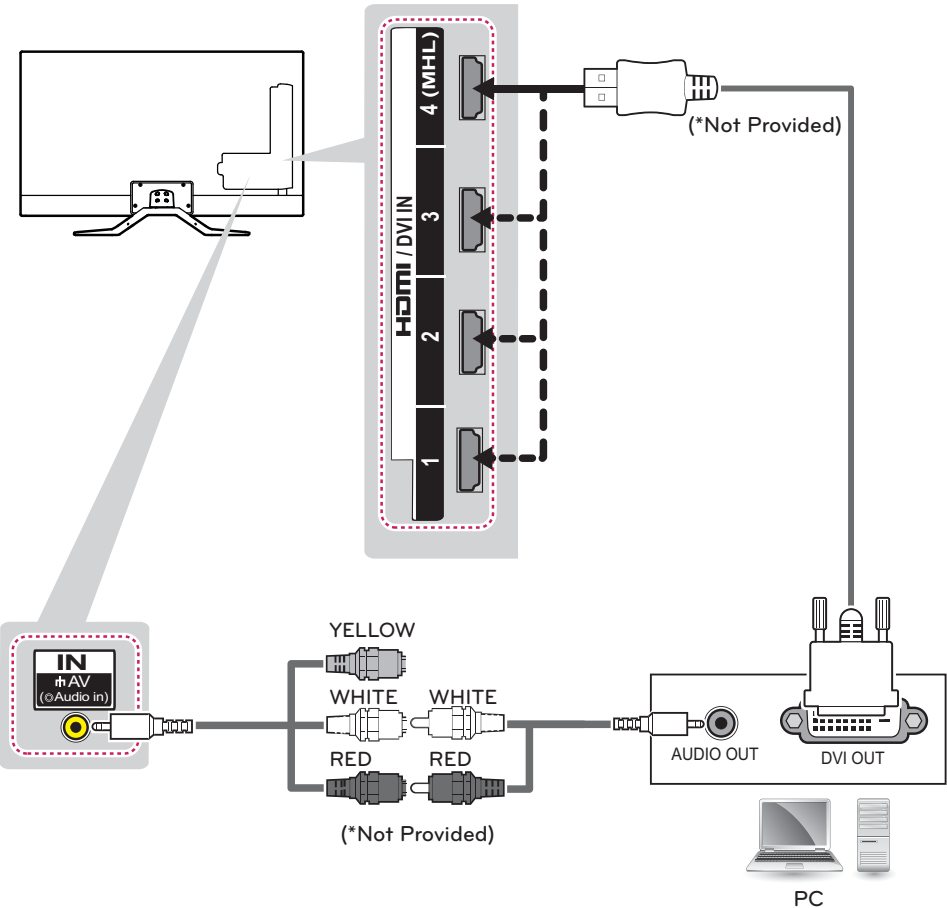

ENGLISH

Connecting to an Audio System

You may use an optional external audio system instead of the built-in speaker.

! NOTE

- If you use an optional external audio device instead of the built-in speaker, set the TV speaker feature to off.

Digital Optical Audio Connection

Transmits the digital audio signal from the TV to an external device. Connect the external device and the TV with the optical audio cable as shown in the following illustration.

! NOTE

- Do not look into the optical output port. Looking at the laser beam may damage your vision.
- Audio with ACP (Audio Copy Protection) function may block digital audio output.

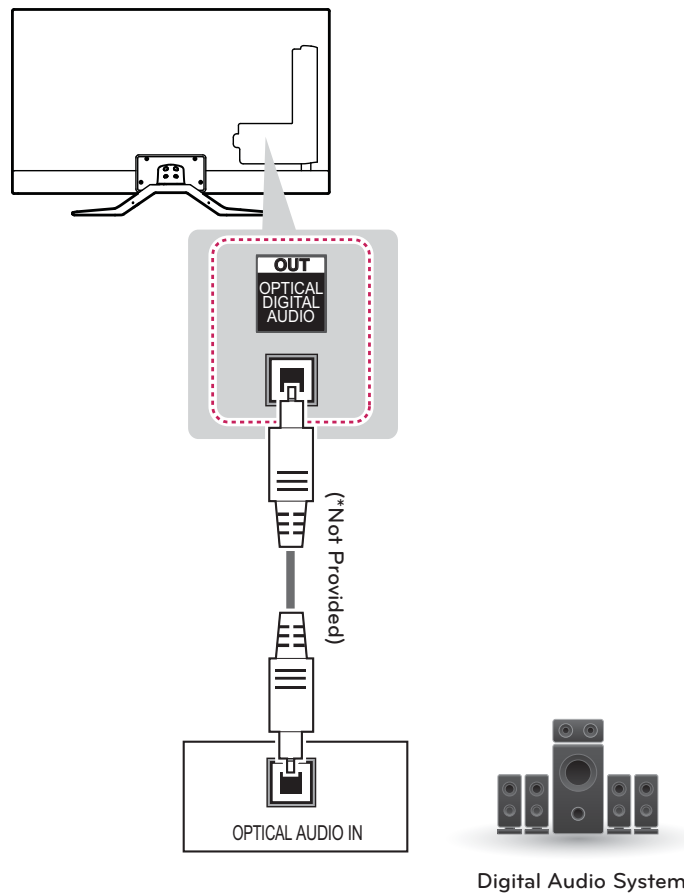

Connecting to a Headphone

Listen to the sound through a headphone.

! NOTE

- AUDIO menu options are disabled when connecting a headphone.
- When changing AV MODE with a headphone connected, the change is applied to video but not to audio.
- Optical Digital Audio Out is not available when connecting a headphone.
- Headphone impedance: 16 Ω
- Max audio output: 10 mW to 15 mW
- Headphone jack size: 0.35 cm (0.13 inches)

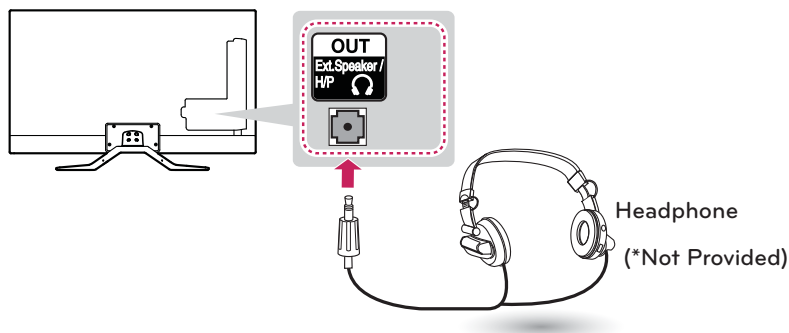

Connecting a USB Device

Connect a USB storage device such as a USB flash memory, external hard drive, or a USB memory card reader to the TV.

! NOTE

- Some USB Hubs may not work. If a USB device connected using a USB Hub is not detected, connect it to the USB port on the TV directly.

Choose any USB input port to connect.
It does not matter which port you use.

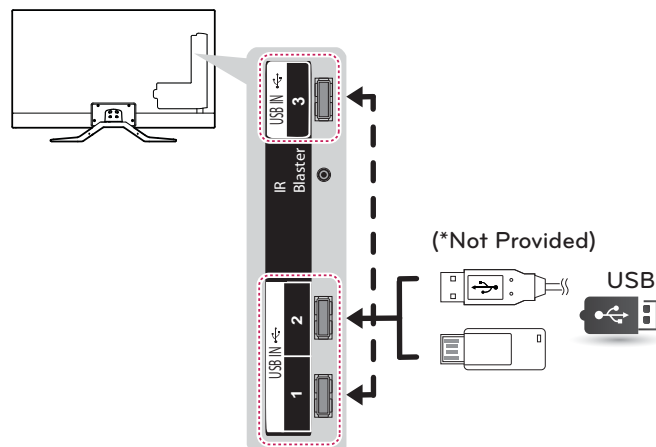

USING (BASIC)

Turning the TV on for the first time

When you turn the TV on for the first time, the Initial setting screen appears. Select a language and customize the basic settings.

- 1 Connect the power cord to a power outlet. The Power indicator turns on and the TV switches to Standby mode.
- 2 In Standby mode, press the power button on the remote control to turn the TV on. The Initial setting screen appears when you turn the TV on for the first time.

NOTE

- You can also access **Initial Setting** by accessing **OPTION** in the main menu.

- 3 Follow the on-screen instructions to customize your TV settings according to your preferences.

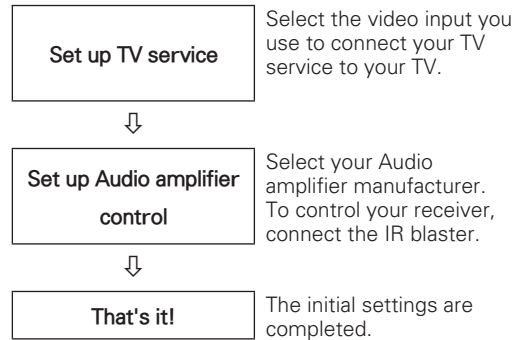
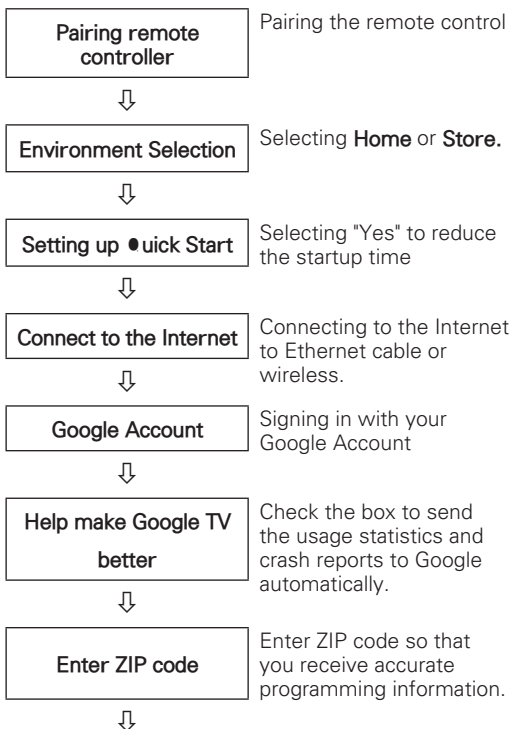

- 4 When the initial settings are completed, select **Finish**.
- 5 To turn the TV off, press the power button on the remote control.

NOTE

- Disconnect the power cord from the power outlet when you do not use the TV for a long period of time.

Setting the Mode

- 1 Press **Home** to access the Home menu.
- 2 Go to **All Apps > Settings > Option > Environment Selection**.
- 3 Select **Store** for in-store display. For use in-home, select **Home**.

NOTE

- To display images in the best quality for your home environment, select **Home**.
- **Store** is suitable for the retail environment.
- If you select **Store**, any customized settings will switch back to the default settings of **Store** in 5 minutes.

Accessing Home Menu

Press **Home** to access the Home menu.

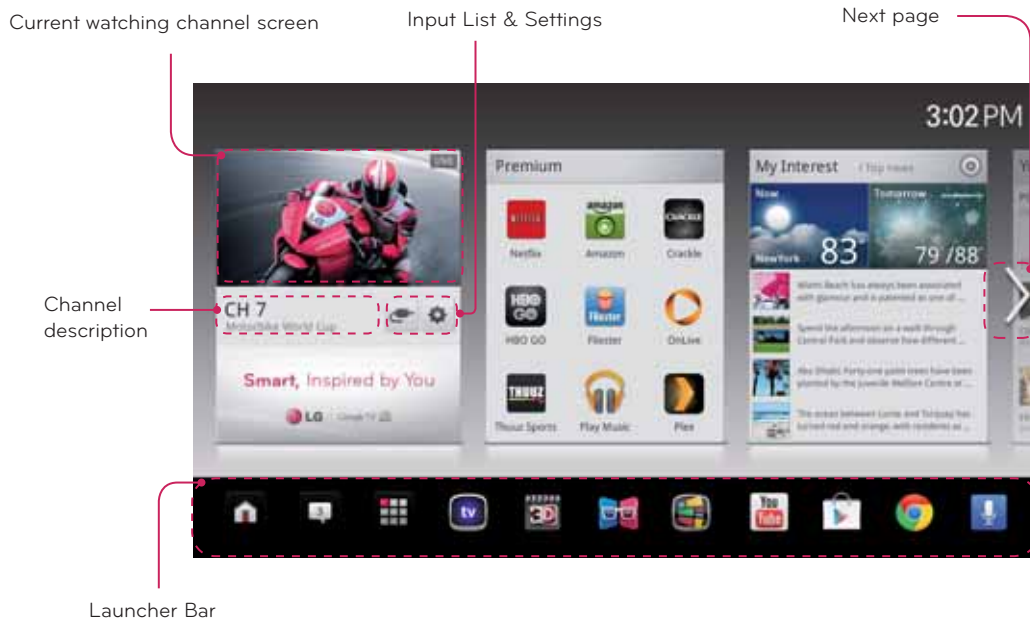

Setting up channels

Storing channels

To store channels automatically,

- 1 Press **Home** to access the Home menu.
- 2 Go to **All Apps > Settings > Channel setting > Auto Tuning**.
- 3 Select **Start** to start automatic tuning.
The TV scans and saves available channels automatically.
- 4 When you return to the previous menu, press **← BACK**.

To store channels manually,

- 1 Press **Home** to access the Home menu.
- 2 Go to **All Apps > Settings > Channel setting > Manual Tuning**.
- 3 Scroll through the channel types, and then add or delete channels.
- 4 When you return to the previous menu, press **← BACK**.

! NOTE

- You can store up to 1000 channels. The number of channels that you can store differs depending on the broadcasting signal environment.

Checking current program info

Press **MENU** and select **INFO** to view the information of the current program program while you are watching. The following information appears on the screen.

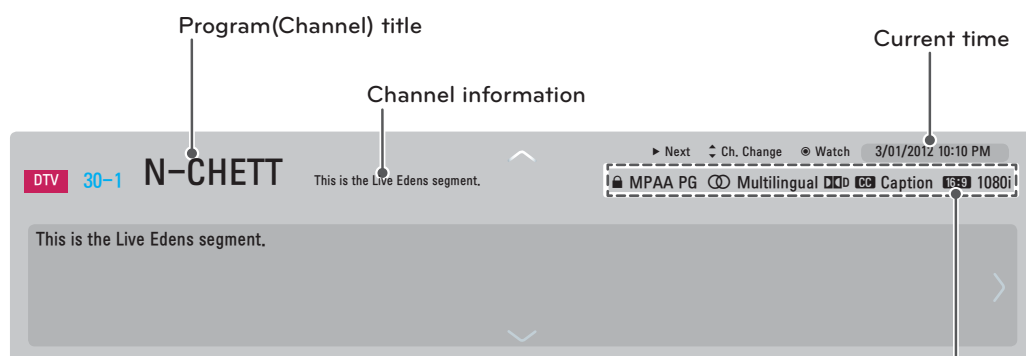

Icon		Description
Multilingual		The program contains two or more audio language services. You can change the audio language on settings.
Dolby Digital		The program contains a Dolby Digital audio signal in TV and HDMI input sources.
Dolby Digital Plus		The program contains a Dolby Digital Plus audio signal in TV and HDMI input sources.
Caption		The program contains one or more language caption services. You can select a closed caption you want on settings.
Aspect ratio		The original aspect ratio of the video is 4:3.
		The original aspect ratio of the video is 16:9 (wide).
Resolution		The video resolution is 720 x 480i.
		The video resolution is 720 x 480p.
		The video resolution is 1280 x 720p.
		The video resolution is 1920 x 1080i.
V-Chip		The video resolution is 1920 x 1080p.
		The program contains Lock information.

Adjusting aspect ratio

Resize an image to view its optimal size while you are watching TV.

- 1 Press **Home** to access the Home menu.
- 2 Go to **All Apps > Settings > Picture & sound > Picture adjustment**.
- 3 Press the Navigation buttons to scroll to **Aspect Ratio** and press **Wheel**.
- 4 Select a display method.

! NOTE

- The available ratio varies depending on the input source.
 - The input sources: HDMI-PC support 4:3 and 16:9.
 - The input sources: HDMI-PC 1920 X 1080 supports 4:3 and 16:9 of the aspect ratios.

- **16:9**: Resizes images to fit the screen width.



- **Just scan**: No any resize images. It is available the input signal is up to 720P resolution.
- **Set by Program**: When your TV receives a wide screen signal it will automatically change to the picture format broadcast.



- **4:3**: Resizes images to the previous standard 4:3.



- **Zoom**: You can move or select the aspect ratio by pressing up or down button.
- **Cinema Zoom 1**: Formats an image to the cinemascope ratio, 2.35:1.
 - To change the ratio of the cinema zoom, press left or right and its range is from 1 to 16.
 - To move the zoom focus up or down, press up or down.



! NOTE

- If you enlarge or reduce an image, the image may be distorted.

Using the input list

Selecting an input source

- 1 Go to **All Apps > Settings > Input List**
- The connected device displays on each input source.

NOTE

- You can also access the input source list by selecting **Input List** in the **Settings** menu.

- 2 Press the Navigation buttons to scroll to one of the input sources and press **OK**.

Input source	Description
TV	Watch TV over the air, cable, and digital cable broadcast.
AV	Watch video from a VCR or other external devices.
COMPONENT	Watch video from a DVD or other external devices, or through a digital set-top box.
HDMI	Watch video from a HTS or other high definition devices.

Editing input name

Edit the input name so that you can easily identify a device connected to each input source.

- 1 Press **Home** to access the Home menu.
- 2 Go to **All Apps > Settings > Input List > Edit Input Name**.
- 3 Select the **Input Name** and **New Input Name** to change the input name.
- 4 Select **Set** to save.
- 5 When you return to the previous menu, press **← BACK**.

Using the customer support

Testing the Picture / Sound

To execute picture and sound tests.

- 1 Press **Home** to access the Home menu.
- 2 Go to **All Apps > Settings > Options > Customer Support**.
- 3 Select **Picture test** or **Sound test**.
- 4 If you have any problem, select **Yes**. LG customer service center and product information appears. Contact LG customer service center for help.
- 5 When you are finished, select **Close**.
When you return to the previous menu, press **← BACK**.

Using the product or service information

To check the product or service information

- 1 Press **Home** to access the Home menu.
- 2 Go to **All Apps > Settings > About > Product/Service Info**.
- 3 You can check the various Product/Service information based on your model.
- 4 When you are finished, select **Close**.
When you return to the previous menu, press **← BACK**.

APPLICATIONS

Google Chrome

Getting started

- 1 Select the **Google Chrome** in **Home** or in **All Apps**, or simply type a URL or search query directly into the search bar. Use the **SEARCH** key to open the search bar.
- 2 While using Google Chrome, press the **Menu** key to manage your browser windows, bookmarks, history, and more. Select **Settings** to configure your browser settings.

Browser windows

- To open a new window, press the **Menu** key, select **Windows**, then select **New window** or press **Ctrl + T** on your controller.
- To view all open windows, press the **Menu** key and select **Windows**. You can have 3 open Chrome windows at one time.
- To reload a browser window, press the **Menu** key and then **Reload** or press **Ctrl + R** on your controller.

NOTE

- Chrome Browser supports up to Flash (10.2.164) but does not support platform-dependent technology like ActiveX.
- Chrome Browser only works with pre-installed plug-ins.
- Chrome Browser only replays the following media file formats: JPEG / PNG / GIF / BMP / WMV(ASF) / WMA / MP3 / MP4
- Chrome Browser is forcibly closed when memory is insufficient.
- For Chrome Browser, fonts installed on the TV are used and may not be displayed normally depending on the content played.
- Chrome Browser does not support file and font download.
- Chrome Browser is made for TV so it may function differently from PC browsers.

Google Chrome shortcuts

Ctrl + R	Reloads the current tab
Ctrl + ↑	Zooms in
Ctrl + ↓	Zooms out
Ctrl + 0	Resets zoom level to 100%
Ctrl + T	Opens a new tab
Ctrl + Shift + T	Opens a new tab in an incognito window
Ctrl + W	Closes the current tab
Ctrl + D	Adds to Bookmarks or Home Screen.
Ctrl + F	Opens the find on page bar
Space bar	Scrolls down the current web page

Browsing history

- To access your Google Chrome browsing history, press the **Menu** key and select **History**. To clear your history, select **Clear history**.
- To clear all browsing data, including clearing your cache, history and cookie data, press the **Menu** key and select **Settings**.

Incognito Browsing

If you don't want your website visits to be recorded in your browser history, you can browse in incognito mode. To open a new incognito window, press the **Menu** key, select **Windows**, then select **New incognito window** or press **Ctrl + Shift + T** on your controller.

Bookmarks

Bookmarking allows you to save websites without having to remember URLs. Your web bookmarks are located within your Google Chrome browser for easy access while you're surfing the web.

To Bookmark a Webpage:

- 1 Open Google Chrome.
- 2 Navigate to the webpage you want to bookmark.
- 3 Press the **≡ Menu** key and select **Save**.
- 4 From the following menu, select **Add to bookmarks** or **Add to home screen**. You can name your bookmark on the next screen.
- 5 Select **OK** to save changes.

To Access your Bookmarks:

- 1 Open Google Chrome.
- 2 Press the **≡ Menu** key and select **Bookmarks**.

To Delete a Bookmark:

- 1 Open your bookmarks using the steps above.
- 2 Navigate to the bookmark you'd like to delete, then long-press (press and hold) the **Enter** or **OK** key on your remote.
- 3 Select **Delete bookmark**.

Safety and security settings

Lock Google Chrome

Lock Google Chrome by setting a PIN password to open the application. Press the **≡ Menu** key and select **Settings**. Under **Privacy & Safety**, select **Chrome lock settings** and check the box for **Lock Google Chrome**. Enter the **PIN number** and select **OK**.

Enable SafeSearch:

Enabling SafeSearch on Google Chrome is a little bit different from enabling it for Google TV Search. To enable SafeSearch for in-browser searches, press the **🔍 SEARCH** key and enter **<http://www.google.com/preferences>**. Select your preferred option under SafeSearch Filtering. Visit this article for more information about SafeSearch on Google.

Advanced settings

Press the **≡ Menu**, select **Settings**, then **Advanced settings** to configure several advanced options, including:

- **Personal Stuff**
 - Passwords
 - Form Autofill
- **Under the Hood**
 - Privacy
 - Web Content
 - Security
 - User Agent

Google Play

Getting Started

The Google Play offers easy access to Android applications available on Google TV. These have been created by developers all around the world, and have been rated by your fellow users.

Google Accounts and the Google Play

The first time you open the Google Play, you'll be prompted to select your Google Account in case there're more than two accounts. This will be the default Google Account for Google Play purchases and downloads.

All items downloaded to your Google TV will be accessible under **All Apps** (press the **Home** key and select **All Apps**), regardless of which Google Account was used to download them.

How to download or remove apps

Downloading Apps

Free Apps

- 1 Navigate to an item you want to install and select it. The item details screen will appear and you can read more about the item and its developer.
- 2 If you want to install the item, select the **Install**. Allow access appears.
- 3 Select **Install** to accept the permissions for the app, the item will start downloading immediately.

Paid Apps

- 1 Navigate to an item you want to install and select it. The item details screen will appear and you can read more about the item and its developer.
- 2 If you want to install the item, select the **BUY** button.
- 3 Press **Continue** to accept the permissions for the app.

NOTE

- You may be asked to sign in to your Google Checkout account if it's the first time you're purchasing from the Google Play.
- Sign in and select **Purchase now** if you want to proceed.

Removing Applications

- 1 Open the Google Play app and select **My apps** from the Google Play home screen. (On some devices, press **Menu** and then select **My apps**)
- 2 Select the item you'd like to uninstall.
- 3 On the application home screen, select the **"Uninstall"** button.

NOTE

- You will be able to return to **My apps** at any time to reinstall a purchased application that you've previously removed.

Charges

When to Expect Charges

Once you place an order, charges generally post to your credit/debit card within a few days. Check your receipt in the **Purchase History** section of your account to see if your card has been charged or the exact date your credit/debit card was charged for your purchase.

Please note, if you cancelled your order within the first 15 minutes, rest assured that your credit/debit card has not been charged. Any line items on your statement are only authorizations.

Charges and Cancelled Orders

If you believe you were charged for an order you cancelled, please verify that your order was cancelled in your Google Checkout account. Here's how:

- 1 Sign in to your account at <https://checkout.google.com/>.
- 2 On the **Purchase History** page, click **View Order** next to the order containing the item you'd like to review.
- 3 If your order has been cancelled, the order details should read **Your order has been cancelled**.

! NOTE

- If your order has been cancelled, the pending amount that you've noticed on your credit/debit card statement is only an authorization, not an actual charge.
- If your order details do not reflect cancellation, or if you're waiting for a refund, learn more about cancelling your order directly through the seller.

Returning apps

Refund Policy

You have **15 minutes** from the time of download to return an application purchased through Google Play for a full refund. You may only return a given application once; if you subsequently purchase the same app again, you may not return it a second time.

How to return an app within the 15 minute return period:

- 1 Launch Google Play on your device
- 2 Select **Menu > My Apps**
- 3 Select the app you'd like to return

! NOTE

- If the 15 minute refund window has not yet passed, the app is eligible for return and will have two buttons saying "Open" or "Refund"

- 4 Select the **Refund** option

! NOTE

- The Refund button will now say "Uninstall." Press "Uninstall" to remove the app from your device and initiate the refund.
- After the 15 minute return period has expired, the Refund option will not be available. Selecting the "Uninstall" button at this point will simply remove the application from your device.

After the 15 minute return period:

If you're unsatisfied with an application after the 15 minute return period has expired, we recommend contacting the developer directly.

You may find developers' contact information here:

- 1 Go to Google Play and select the app in question.
- 2 On the app's description page, scroll down to the "Developer" section
- 3 One of the following contact options will be provided: an email address, a phone number, or a website.

Live TV

Google TV works with your existing cable or satellite TV service to help you find what you want to watch through search and to bring you access to the full internet to find great web content.

3D World

This TV can display in 3D via 3D broadcasting or when the TV is connected to a compatible device, such as a Blu-ray 3D Player. The viewer must wear compatible 3D glasses in order to see these images in 3D format.

When watching 3D imaging

- To watch the TV in 3D, you must put on your 3D glasses. For best results, you should wear LG Brand 3D glasses. The 3D imaging may not display properly when using another brand of 3D glasses. Please see the 3D glasses manual for instructions on how to use the 3D glasses.
- When watching 2D images, it is recommended to take off the 3D glasses. If you watch 2D images with the 3D glasses on, you may see distorted images.
- We recommend that you maintain a distance of at least twice the screen diagonal length when watching 3D videos.

NOTE

- If 3D TV broadcast standard changes in the future and it is not supported by this TV set, you may need a separate device, such as a set-top-box.







When using 3D Glasses

- Do not use the 3D glasses to replace your corrective glasses, sunglasses or protective goggles.
- Do not store the 3D glasses in hot or cold locations.
- Do not drop objects onto the 3D glasses. Do not drop or bend the glasses.
- Since the lenses of the 3D glasses are easily scratched, make sure to clean only with a soft cloth. Shake off any dust before using the cloth since the glasses are easily scratched.

Viewing 3D Imaging

- Play the video produced in 3D.
- Wear the 3D glasses.
- Select the thumbnail matching the screen.
- Press **3D** button to select a option.

Change Format Change the thumbnail matching the screen.

2D » 3D	<p>Changed from 2D imaging to 3D imaging.</p> <p>2D-to-3D converted videos may appear less realistic than titles originally produced as 3D videos.</p> 
Side by Side	
Top & Bottom	
Checker Board	
Frame Sequential	
Row Interleaving	
Column Interleaving	

- 3D settings** Adjusts 3D settings.
- Picture adjustment** Adjusts the Picture adjustment.
- 3D to 2D** Changes the 3D to 2D.
- 3D off** Turn off the 3D.

NOTE

- Supported 3D applications : TV applications, SmartShare (USB), 3D World

Setting 3D Imaging

- 1 Go to **All Apps > Settings > 3D settings**
- 2 Select one of the following options and press **OK(Wheel)**.

3D Settings

3D Mode	Select one of the 3D mode.
3D Depth	Adjusts the stereoscopic effect of the 3D image converted from 2D image.
3D Viewpoint	Moves the 3D image to front and back to adjust the 3D perspective view.
3D Color Correction	Provides the 3D Optimized color.
3D Sound Zooming	Provides the 3D Optimized sound.
3D Image Correction	Selects Left/Right or Right/Left . Selects the screen with 3D video with better visibility.



CAUTION





- Some menus may not work while viewing 3D imaging.
- The 3D imaging is disabled automatically when switching input source or DTV channel. (Except for 2D to 3D)
- The screen may not be displayed properly if you view 2D images in 3D imaging mode.
- 3D effect can be seen when 3D Mode is selected appropriately for the 3D input signal supplied to the TV.

SmartShare

Play back audio/video/image files.

- 1 Insert a USB device containing files into the USB jack.
- 2 Go to **All Apps > SmartShare**.
- 3 Select a file from the list and press **OK**.

Keys available during playback

-  Starts or re-starts playback (video/music playback). Starts Slideshow or starts moving a panoramic photo (photo playback)..
-  Pauses playback (video/music playback).
-  Stops playback. Stops Slideshow or Image viewer, and returns to the file list (photo playback).
-  Fast rewinds/Fast forwards the title/track.
-  Skips to the previous/next title (video playback)/track (music playback)/file (photo playback).

NOTE

- USB devices must be less than 2TB.

Options

Various settings and playback operations are available by pressing  **MENU** during playback. The available items differ depending on the situation.

Photo playback

- Slide show** You can start (Play Slideshow) or pause (Pause Slideshow) a slideshow.
- Rotate** You can rotate photo files clockwise (Right) by 90 degrees.
- Slide show setting** You can adjust the speed or random play of the slide show.

Netflix

Sign in to your Netflix® account to browse by genre, search for titles, manage your Instant Queue and review Netflix® recommendations all from your Google TV. If you do not have a Netflix® account, you will need to create a new account to use this feature.

For more information, visit www.Netflix.com.

Watch TV shows and movies online or by streaming them from Netflix.

Photos

Browse photos on a photo sharing website, such as Picasa. You can also browse photos in the connected USB devices.

To View Albums from Local Media

- 1 Insert your USB device into the USB slot on your TV.
- 2 In the **Photos** app, navigate to **Local media** on the left navigation bar.
- 3 Select your USB device and you will then be able to navigate through the folders on your device.

To Link your online Album:

- 1 While in the **Photos** app, press the  **Menu** key on remote control.
- 2 Select **Settings**. Check the box next to the account that you want to link to the **Photos** app.
- 3 If your Google account is not listed, select **New Account** where you will be asked to Create a new account or Sign-In to an existing account.

Search

- 1 Press the **Q SEARCH** key on your remote control. The **Q SEARCH** key works no matter where you are on your Google TV, and searches across all applications, bookmarks, TV content, web video, and web pages.
- 2 When you enter a search query, a drop-down list will display a selection of results.
- 3 Navigate search results using the directional arrow keys, then press **Enter** to select an option. You can also enter a URL into Google TV search to navigate directly to a website.

To customize Search Results

It's easy to configure your Google TV search experience to include results from PrimeTime, Apps, Podcasts, and more.

- 1 Press the **Q SEARCH** key, type 'Settings,' and select the **Settings** application.
- 2 Select **Search**, then **Searchable items** to customize what appears when you search.

SafeSearch

Use SafeSearch to block adult content from appearing in search results.

- 1 Press the **Q SEARCH** key, type 'Settings,' and select the **Settings** application.
- 2 Select **Privacy & safety**, navigate to **Safety**, and select **SafeSearch**.

PrimeTime

PrimeTime is the simplest way to find shows and movies to watch instantly. In addition to live TV, you can browse and search for video on demand options, and filter results by price (Free vs. All) and streaming quality (HD vs. all).

! NOTE

PrimeTime provides:

- Access to content from your Netflix subscription
- Access to web video content from 100+ web domains
- Access to VOD rentals on Amazon and YouTube

To access PrimeTime:

- 1 Press the **Home** key and select **PrimeTime**.
- 2 Once in **PrimeTime**, use the left navigation bar to filter by **Live**, **Shows** and **Movies**

To filter available PrimeTime:

- **Live:** Use the top toolbar to filter live TV listings by time and quality (All or HD)
- **Shows:** Use the top toolbar to filter shows by price (Free or All) and quality
- **Movies:** Use the top toolbar to filter movies by price and quality

Ratings

Rate your favorite shows and movies to get personalized recommendations. Personalized recommendations are based on your viewing history and prior series and movie ratings.

To rate a movie or TV series, select a 'star' rating on the Movie or Show page using the pressing 1-5 on remote control. The first time you rate at TV series or movie, you will be asked to enable personalized recommendations.

! NOTE

- Your watch history and ratings will be associated with your Google Account.

PrimeTime Quick Guide

Press **GUIDE** on remote control to watch the thumbnail of program list. It is available only when the set-top box is connected by the **Add device manually** on **Video input** settings.

YouTube

Full-length feature films from many major Hollywood studios are now available for rent on YouTube. Discover a universe of related remixes, clips, and behind the scenes footage with YouTube Movie Extras. On Google TV, navigate to YouTube.com/Movies to browse and search for movies, and rent titles using your Google Account.

Google TV offers two different YouTube experiences:

- The YouTube on TV app, an Android-based app that makes it easy to find and watch content on YouTube.
- Through **YouTube.com**: Use the Chrome browser to access the desktop YouTube experience you're used to.

! NOTE

- YouTube Movies (video-on-demand rentals) are currently only available through the YouTube.com experience.
- Browse movies and shows in PrimeTime or at YouTube.com/movies. To learn more about Google TV's video on demand options, please visit the Video on Demand article.

Dual Play

To enjoy the game with dual-display, use the DualPlay application. You can select the mode between Top-bottom and Side By Side.

! NOTE

- It is available only for Game console mode.
- It is available only when connected with HDMI supporting the DualPlay feature.

SETTINGS

The Main Menu

You can review or edit your TV settings by typing **Settings** into the Search bar or by navigating to **Settings** in **All Apps**.

You will be able to review or update the TV settings including:

Q Enter keyword for settings

Recent...	Most recently accessed settings
Network	Manage internet connection.
Video input	Set up TV service provider.
Picture & sound	Adjust the Picture and Sound.
Channel setting	Set up and edit channels.
3D Setting	Set up 3D mode.
Input List	Select an input source.
Search	Manage searchable items, clear shortcuts.
Applications	Manage applications and development options.
Language & input devices	Manage system language, input devices, IP remotes.
Accounts & sync	Manage accounts and data sync.
Privacy & safety	Manage privacy, safety and lock settings.
Storage	Unmount USB storage, view available storage.
Date, time & location	Set date, time, time zone and formats.
Accessibility	Manage accessibility options
Options	Manage system option.
About	System information

Network

Manage Internet connection.

Ethernet	You can set up the status of the wired network connection.
Wi-Fi	You can select an available Wi-Fi network from the list of Wi-Fi networks found in your area or set up a new Wi-Fi network.
Status	You can check the network information, such as IP address, Ethernet MAC address, and Wi-Fi MAC address.

Video input

Edit configured devices

You can select the device to control or to set as the tuner.

Select available source

To add a device, select it from the list. You can add a device you want to control using the IR Blaster.

Picture & sound

Adjusts screen saver, screen off timeout and sound effects.

Picture

Screen saver	Adjust the screen saver timeout.
Screen off timeout	Adjust the screen off timeout.
Picture adjustment	Adjust the image size, quality or effect.

Sound

Volume	Adjust the volume level.
Sound effects	Set the sound effects enabled or disabled.
Notification sounds	Select Silent if you want to silence the notification sounds.
Text-to-speech	Set the Text-to-speech function.
Sound adjustment	Adjust the sound quality, effect or volume level.
Speaker	Select TV or external speaker
Audio Amplifier	Set the IR Blaster to control the Audio amplifier

Channel setting

Set up and edit channels.

Auto Tuning	Tune and Store all available channels through antennas or cable inputs.
Manual Tuning	Tune and Store the channels that you want manually.

3D settings

3D Mode	Select one of the 3D mode.
3D Depth	Adjusts the stereoscopic effect of the 3D image converted from 2D image.
3D Viewpoint	Moves the 3D image to front and back to adjust the 3D perspective view.
3D Color Correction	Provides the 3D Optimized color.
3D Sound Zooming	Provides the 3D Optimized sound.
3D Image Correction	Selects Left/Right or Right/Left . Selects the screen with 3D video with better visibility.

Input List

Views the input sources with their labels. You can select a input source.

ENGLISH

Search

Manage Searchable items and Clear shortcuts

Searchable items	Choose applications to search.
Clear shortcuts	Clear shortcuts to recently chosen search suggestions.
About	source information

Applications

Manage applications and development options.

Unknown sources	Allow installation of non-Google Play applications
Manage applications	Manage and remove installed applications.
Running services	View and control currently running services.
Development	Set options for application development

Language & input devices

Manage system language, input devices, IP remotes

Manage IP remotes	Connect and disconnects IP remotes.
Chrome to TV	Push links to this device from Google Chrome.

Pointer speed	Adjust mouse and trackpad speed.
Select language	Select a language.
Current keyboard	Configure current keyboard.
Configure input methods	Configure input methods.
Voice search and voice recognition	Manage voice input language, safe voice search.

Accounts & sync

Manage accounts and data sync.

General sync settings

Background data	Applications can sync, send and receive data at anytime.
Auto-sync	Applications sync data automatically.

Manage accounts

You can clear the saved password or remove account.

Add account	Adds a new account.
--------------------	---------------------

Privacy & safety

Manage privacy, safety and lock settings.

Personal data

Reporting	Automatically sends Google TV usage statistics and crash reports to Google.
Video history	Enable history of video watching such as TV channels.
Clear video history	Erase the video history.

Safety

SafeSearch	Block adult content from appearing in search results.
Application lock	Require PIN to use Google Chrome & Google Play.
Safety(Lock)	Lock or Unlock channels and programs.

Backup and restore

Back up my data	Back up application data and other settings to Google servers.
Backup account	Set the backup account.
Automatic restore	If you reinstall an application, restore backup settings or other data.

Storage

Unmount USB storage, view available storage.

Internal memory

Total	View the total internal memory size.
Available	View the available memory size.

External access via FTP

Enable FTP access	Set the FTP server to be disabled or enabled.
--------------------------	---

Media storage

View the connected storage devices.

Date, time & location

Sets the date, time, time zone and formats.

Date & time

Automatic	Use provided network time.
Set date	Set the date manually.
Set time	Set the time manually.
Select time zone	Select the time zone.
Use 24-hour format	Select the 24-hour format.
Select date format	Select the date format.

Timer

Off Time	Set the time to turn Off the TV automatically.
On Time	Set the time to turn On the TV automatically.
Sleep Timer	Set the length of time before the TV turns off.

Location

Select country	Select your country.
Set location	Set your location by ZIP code.

Accessibility

Manage accessibility options.

Accessibility services

TalkBack Check the box to provide audible explanations for Google TV features.

Accessibility scripts

Download accessibility scripts Allow applications to download accessibility scripts from Google.

Options

Manage system option.

Initial Setting Factory Reset. All user settings and channel settings will be reset.

Audio Language Select the audio language.

Caption Set whether to display captions and Customize your option in each mode.

LG Logo Light Set to turn on or off the indicator light in Standby Mode

Quick Start Set the TV to power on quickly

Pointer Alignment Align the remote control's direction with the pointer on your TV screen by shaking the remote control left and right.

Customer Support Check the customer information.

Environment Selection Select your environment.

Netflix Deactivation Delete all Netflix private data

ENGLISH

About

Views the system information.

Product/Service Info Show the Product or Service information

System updates Update the system.

System tutorial Learn about the key features of Google TV.

Model name View the model name.

Android version View the android version.

Build number View the build number.

Legal information

Open source licenses View the open source licenses.

Google legal View the Google legal information.

APPENDIX

Updating the TV system

Download and install the latest system through network signal to enhance or change the product function, or add new features.

To check the current firmware version or update the firmware,

- 1 Go to **All Apps > Settings > About > System updates**.
- 2 Press the Navigation buttons to scroll to **System updates** and select **Check now**.
The current firmware version displays.
- 3 If new update exists, the download is started automatically on background. When downloading is completed, a Pop-up appears. Then update your system.

 **NOTE**

- You cannot downgrade back to an older system version.
- The period of time for the firmware update may be different depending on the firmware size and network bandwidth.

Cleaning Your TV

Clean your TV regularly to keep the best performance and to extend the product lifespan.

CAUTION

- Make sure to turn the power off and disconnect the power cord and all other cables first.
- When the TV is left unattended and unused for a long time, disconnect the power cord from the wall outlet to prevent possible damage from lightning or power surges.

Screen, frame, cabinet and stand

To remove dust or light dirt, wipe the surface with a dry, clean, and soft cloth.

To remove major dirt, wipe the surface with a soft cloth dampened in clean water or a diluted mild detergent. Then wipe immediately with a dry cloth.

CAUTION

- Do not push, rub, or hit the surface with your fingernail or a sharp object, as this may result in scratches on the screen and image distortions.
- Do not use any chemicals, such as waxes, benzene, alcohol, thinners, insecticides, air fresheners, lubricants, as these may damage the screen's finish and cause discoloration.
- Do not spray liquid onto the surface. If water enters the TV, it may result in fire, electric shock, or malfunction.

Power cord

Remove the accumulated dust or dirt on the power cord regularly.

Preventing "Image burn" or "Burn-in" on your TV screen

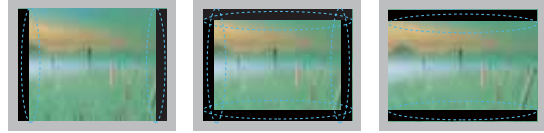

- If a fixed image displays on the TV screen for a long period of time, it will be imprinted and become a permanent disfigurement on the screen. This is "image burn" or "burn-in" and not covered by the warranty.
- If the aspect ratio of the TV is set to 4:3 for a long period of time, image burn may occur on the letterboxed area of the screen.
- Avoid displaying a fixed image on the TV screen for a long period of time (1 or more hours for the Plasma TV) to prevent image burn.

IR Blaster Guide

Universal remote control setting enables user to control multiple devices with a single remote controller. In order to continue the setting, please check, if IR Blaster and other devices are connected with TV properly.

When set-top box is connected:



- 1 Connect the IR Blaster Cable to the TV. Place the transmitter in front of the Set-top box.
- 2 Go to **Home > All Apps > Settings > Video input > Add device manually**.
- 3 Select a device and **Next**. The TV signal playing is displayed.
- 4 Select your device type.
- 5 Select your lineup provider. (when device type is Cable box, Satellite receiver or DVR)
- 6 Select the manufacturer of the selected device.

Check if the IR Blaster is firmly plugged into the IR Blaster port and is placed near the remote sensor of your device. and Select **Next**.

- 7 Select **Send POWER** or Press **CH up/down** to test the code. If the code is not matched, select **No, try next code** to find the corresponding code. If the code is matched, select **Yes**.
- 8 Analyzing channels. **Select Next**. (when device type is Cable box, Satellite receiver or DVR)
- 9 Select **Finish**. Your device is registered.

When audio amplifier is connected:

- 1 Connect the IR Blaster Cable to the TV. Place the transmitter in front of the Audio amplifier.
- 2 Go to **Home > All Apps > Settings > Picture & sound > Audio Amplifier**.
- 3 Select **Yes, I have an Audio amplifier** and **Next**.
- 4 Select the manufacturer of the receiver.
- 5 Test the code. If the code is not matched, select **No, try next code** to find the corresponding code.
- 6 Select **Yes**. Your device is registered.
- 7 Press **Fn + X** to test the code. And select **Next**.
- 8 Select the default output between Audio amplifier and TV speakers. And Select **Done**. The setting is finished.

NOTE

- Some devices can be supported even if there are no exist in IR code list.
- Some functions may differ depending on the device.

IR Code list (by brand name)

AUDIO

Adcom Limited	Cambridge Audio Limited	Fosgate Audionics	Koss Corporation	Mondial Designs	Philips Corporation	Sherwood
Aiwa Corporation	Carver	Harman Kardon Inc.	Krell Industries	Myryad	Pioneer Electronics	Sony Corporation
Akai Professional LP	Cary Audio Design	Hitachi. Ltd	Lexicon	NAD Electronics	Proceed Audio	SOUNDESIGN
Anthem	Citation	Integra	LG Electronics	Nakamichi Corporation	RCA Corporation	Sunfire
Aragon Indy Audio Labs	Clarion Co. Ltd.	Jamo	Linn Products Ltd	NEC Corporation	Realistic	TEAC Corporation
Arcam	Denon Corporation	J.C. Penney Co. Inc.	Luxman Corporation	Niles Audio	Rotel	Technics
Atlantic Technology	Digital Projection Ltd.	JVC Corporation	Magnavox	Onkyo Corporation	Samsung Electronics	The Fisher
Audiofile Limited	Dvico Inc.	Kenwood Corporation	Marantz Corporation	Optimus Audio	Sansui Electric Co. Ltd.	Theta Digital
B&K Sound and Vibration	ELAN Audio	Klegg Audio	Mcintosh Laboratory	Outlaw Audio	SANYO Electric Co. Ltd.	Toshiba Corporation
Bose Corporation	Enlightened Audio Designs	KLH Audio	Meridian Audio Ltd.	Panasonic Corporation	SCOTT	Yamaha Corporation
Boston Acoustics Inc.	Flextronics	Klipsch Audio Tech.	Mitsubishi Corporation	Parasound	Sharp Corporation	Zenith

DVD

Accurian	Audiovox Corporation	CyberHome	Funai	Initial	Konka	Mcintosh Laboratory
Adcom Limited	Bel Canto Design	DAEWOO	Gateway	Insignia	Koss Corporation	Memorex Products Inc.
Advent	Blaupunkt	DENON	GE	Integra	Kreisen	Meridian Audio Ltd.
Aiwa Corporation	Broksonic	Diamond Vision	Go Video	Jaton	Krell Industries	Microsoft
Akai Professional LP	Buffalo	Disney	GPX	JBL	Lasonic	Mintek
Allegro Films	California Audio Labs	Durabrand	Gradiente	JSI	Lexicon	Mitsubishi Corporation
Alpine	Cambridge Audio	DVD 2000	Greenhill	JVC Corporation	LG Electronics	Myryad
AMW	Cary Audio Design	DYNEX	Grundig	jWIN	Liteon Corporation	NAD Electronics
Anthem Pictures	Centrios	Emerson	Harman Kardon Inc.	Kawasaki	Loewe	Nakamichi Corporation
Apex Digital	Cinevision	Enterprise	Hitachi. Ltd	Kenwood Corporation	Magnavox	Nesa Vision
Arcam	Citizen	ESA	Hiteker	Kiss	Malata	NeuNeo
Aspire Digital	COBY Electronics	Fisher	LLO	KLH	Marantz Corporation	NexxTech

DVD

Mcintosh Laboratory	NeuNeo	Philips Corporation	RCA Corporation	Sharp Corporation	Symphonic	Urban Concepts
Memorex Products Inc.	NexxTech	Philips Magnavox	Rio	Sherwood	Tag McLaren	US Logic
Meridian Audio Ltd.	Norcent Technologies	Pioneer Electronics	Rjtech	Shinsonic	Tatung	Venturer Electronics
Microsoft	Onkyo Corporation	Polaroid	Rotel	Sonic Blue	TEAC	Vinc
Mintek	OPPO Digital	Polk Audio	Sampo	Sony Corporation	Technics	XBOX
Mitsubishi Corporation	Optimus Audio	Presidian	Samsung Electronics	Spectroniq	Techwood	Yamaha Corporation
Myryad	Orion	Prima	Sansui	Sungale	Theta Digital	Zenith
NAD Electronics	Oritron	Primare	SANYO Electric Co. Ltd.	Superscan	Thompson Electronics	
Nakamichi Corporation	Panasonic Corporation	Princeton	Sears	SVA	Toshiba Corporation	
Nesa Vision	Parasound	Proscan	Sensory Science	Sylvania	Trutech	

Cable STB

Cisco/Scientific Atlanta	Digital Stream Technology	Homecast Co. Ltd.	Nfusion	Sony Corporation	Toshiba Corporation
Pioneer Electronics	Dune HD	Jerrold Electronics	Panasonic Corporation	Sprucer	Viewstar
Pace plc	Evolution Digital Ltd.	LG Electronics	Philips Corporation	Suddenlink	Zenith
Samsung Electronics	FOXTEL	Magnavox	Pulsar	Telnet	
Motorola Inc.	General Instrument	Memorex Products Inc.	RCA Corporation	Thompson Electronics	
CE Labs	Hamlin	Moxi ARRIS Group	Regal	TiVo Inc.	
Digeo Inc.	Hitachi Ltd.	NBOX	Regency	Tocom	

IPTV STB

ADB	Cisco/Scientific Atlanta	Entone Inc.	Motorola Inc.	WEGENER Corporation
Amino Communications	DREAM	Minerva Networks Inc.	Myrio Corporation	

Satellite STB

DirecTV Limited	Hitachi Ltd.	LG Electronics	Next Level	Radioshack	TiVo Inc.
DISH Network	HTS	Magnavox	Panasonic Corporation	RCA Corporation	Toshiba Corporation
General Electric	Hughes Network Systems	Memorex Products Inc.	Philips Corporation	Samsung Electronics	Zenith
General Instrument	JVC Corporation	Mitsubishi Corporation	Proscan	Sony Corporation	

DVR

DirectTV Limited	Humax Co.	Philips Corporation	Replay Networks	Toshiba Corporation
Hughes Network Systems	Moxi ARRIS Group	RCA Corporation	Sony Corporation	

Universal Remote key list

Function		Key (on Google TV RCU)	Reference	Devices			
				Audio amplifier	STB (Cable/SAT)	DVD	DVR
Power	Power (on/ off)	FN + Z (EXT PWR)	STB/DVD/DVR (completed the configuration)		O	O	O
		FN + X (AMP PWR)	Audio amplifier (completed the configuration)	O			
1	Numbers	1			O	O	O
2	Numbers	2			O	O	O
3	Numbers	3			O	O	O
4	Numbers	4			O	O	O
5	Numbers	5			O	O	O
6	Numbers	6			O	O	O
7	Numbers	7			O	O	O
8	Numbers	8			O	O	O
9	Numbers	9			O	O	O
0	Numbers	0			O	O	O
-	Dash	FN + S					
Up		Up	Q side, R side		O	O	O
Down		Down	Q side, R side		O	O	O
Left		Left	Q side, R side		O	O	O
Right		Right	Q side, R side		O	O	O
Ok	Confirms	OK	Q side, R side		O	O	O
Exit	Closes all menus / Moves previous step	ESC	Available for a device has Exit button		O	O	O
Vol Up	Volume up	FN + Right (AMP VOL +)	Available for a device selected to volume control	O			
Vol Down	Volume down	FN + Left (AMP VOL -)	Available for a device selected to volume control	O			
Mute	Mute	 (Mute)		O			
Ch Up	Channel up	CH +			O		
Ch Down	Channel down	CH -			O		
Menu	Menu	Menu	Q side, R side				
⏸	Pauses	⏸			O	O	O
▶	Plays	▶			O	O	O
BACK	Closes all menus / Moves previous step	Back	Q side, R side		O	O	O

Function		Key (on Google TV RCU)	Reference	Devices			
				Audio amplifier	STB (Cable/SAT)	DVD	DVR
YELLOW		FN + INFO	Not available for DVD receiver or device has no color keys		0	0	
RED		FN + TV	Not available for DVD receiver or device has no color keys		0	0	
GREEN		FN + PIP	Not available for DVD receiver or device has no color keys		0	0	
BLUE		FN + DVR	Not available for DVD receiver or device has no color keys		0	0	
GUIDE	Displays EPG	Guide			0		
DVR		DVR					0

Troubleshooting

General

Problem	Solution
Cannot control the TV with the remote control.	<ul style="list-style-type: none"> • Check the remote control sensor on the product and try again. • Check if the batteries are still working and properly installed (⊕ to ⊕, ⊖ to ⊖).
No image display and no sound is produced.	<ul style="list-style-type: none"> • Check if the product is turned on. • Check if the power cord is connected to a wall outlet. • Check if there is a problem in the wall outlet by connecting other products.
Image appears slowly when the TV turns on.	<ul style="list-style-type: none"> • The image is muted during the product startup process. This is normal. If the image does not appear in a few minutes, unplug the TV for 30 seconds and try again. If the image still does not appear, contact the authorized service center in your local area.
Cannot connect external devices.	<ul style="list-style-type: none"> • Refer to the "Connection Overview" and connect an external device.
The TV turns off suddenly.	<ul style="list-style-type: none"> • Check the power control settings. The power supply may be interrupted. • If there is no signal while the TV is on, the TV will turn off automatically after 15 minutes of inactivity.

Audio

Problem	Solution
No sound is produced while images are displaying.	<ul style="list-style-type: none"> • Press VOL + or - button. • Check if the sound is muted by pressing MUTE. • Scroll to other channels. There may be a problem with the broadcast. • Check if the TV Speaker feature is activated in the settings.
No output from one of the speakers	<ul style="list-style-type: none"> • Adjust Balance in the settings.
Unusual sound from inside the TV is produced.	<ul style="list-style-type: none"> • A change in ambient humidity or temperature may result in an unusual noise when the product turns on or off. There is no problem with your product.

Browser

Problem	Solution
While using internet features, there is space that does not appear in some web sites.	<ul style="list-style-type: none"> • The internet of the TV supports up to Flash (10.2.164) and may not replay any file format other than the following : JPEG, PNG, GIF, BMP, WMV (ASF), WMA, MP3, MP4.
Internet closes automatically when visiting website.	<ul style="list-style-type: none"> • If memory is insufficient because of large volume of image information in the web page, internet may be forced to close.

Video

Problem	Solution
An image displays in black and white or the color quality is poor.	<ul style="list-style-type: none"> Adjust the color setting in the menu option. Keep a sufficient distance between this product and other electronic products. Scroll to other channels. There may a problem with the broadcast.
Horizontal or vertical bars appears or images blur	<ul style="list-style-type: none"> Check if there are local interferences such as an electrical appliance or power tool.
Lines or streaks appear on images	<ul style="list-style-type: none"> Check the antenna or aim the antenna to the proper direction.
Afterimages (ghosts) appear when the product turns off	<ul style="list-style-type: none"> Pixels may have been damaged from a fixed image displayed for a long time (image burn). Use a screen saver to prevent the pixel damage on the screen.
The power is on but the screen appears extremely dark.	<ul style="list-style-type: none"> Adjust the brightness and contrast in the menu option.
"No Signal" appears on the screen.	<ul style="list-style-type: none"> Check if the signal cable is connected between the TV and products properly.
Black spots appear on the screen.	<ul style="list-style-type: none"> Several pixels in red, green, white, or black may appear on the screen that attribute to the characteristics of the panel. This is normal.
The display offset is wrong.	<ul style="list-style-type: none"> Adjust the position setting in the settings. Check if the video card resolution and frequency are supported by the product. If the frequency is out of range, set to the recommended resolution using the display settings on the external device.
Thin lines appear in the background of the screen.	<ul style="list-style-type: none"> Check the video cable connections.
The reception on some channels is poor	<ul style="list-style-type: none"> Scroll to other channels. There may a problem with the broadcast. The station signal may be weak. Aim the antenna to the proper direction. Check if there is local interferences such as an electrical appliance or power tool.

Movie

Problem	Solution
Message is displayed saying "This file is invalid" or the audio is working normally but the video is not working normally.	<ul style="list-style-type: none"> Check whether the file is playing normally on a PC. (Check whether the file is damaged.) Check whether the resolution is supported. Check whether the video/audio codec is supported. Check whether the frame rate is supported.
Message is displayed saying "Unsupported Audio" or the video is working normally but the audio is not working normally.	<ul style="list-style-type: none"> Check whether the file is playing normally on a PC. (Check whether the file is damaged.) Check whether the audio codec is supported. Check whether the bit rate is supported. Check whether the sample rate is supported.
Subtitle is not working.	<ul style="list-style-type: none"> Check whether the file is playing normally on a PC. (Check whether the file is damaged.) Check whether the video file and subtitle file name are the same. Check whether the video file and subtitle file are located in the same folder. Check whether the subtitle file is supported. Check whether the language is supported. (When you open the subtitle file in Memo Pad, you can check the language of the subtitle file.)

Specifications

Product specifications may be changed without prior notice due to upgrade of product functions.

Power requirement		AC 100 ~ 240 V ~ 50 / 60 Hz
Television System		NTSC-M, ATSC, 64 & 256 QAM
Program Coverage		VHF 2-13, UHF 14-69, CATV 1-135, DTV 2-69, CADTV 1-135
External Antenna Impedance		75 Ω
Environment condition	Operating Temperature	0 °C ~ 40 °C (32 °F ~ 104 °F)
	Operating Humidity	Less than 80 %
	Storage Temperature	-20 °C ~ 60 °C (-4 °F ~ 140 °F)
	Storage Humidity	Less than 85 %

MODELS		42GA6400 (42GA6400-UD)	47GA6400 (47GA6400-UD)
		42GA6450 (42GA6450-UD)	47GA6450 (47GA6450-UD)
Dimensions (W x H x D)	With stand	973 x 652 x 286 (mm)	1,086 x 708 x 286 (mm)
		38.3 x 25.6 x 11.2 (inch)	42.7 x 27.8 x 11.2 (inch)
	Without stand	973 x 591 x 36.3 (mm)	1,086 x 654 x 36.3 (mm)
		38.3 x 23.2 x 1.4 (inch)	42.7 x 25.7 x 1.4 (inch)
Weight	With stand	14.1 kg (31.0 lbs)	16.7 kg (36.8 lbs)
	Without stand	12.4 kg (27.3 lbs)	15.0 kg (33.0 lbs)
Current Value / Power consumption		1.1 A / 110 W	1.2 A / 120 W

MODELS		50GA6400 (50GA6400-UD)	55GA6400 (55GA6400-UD)
		50GA6450 (50GA6450-UD)	55GA6450 (55GA6450-UD)
Dimensions (W x H x D)	With stand	1,137 x 742 x 326 (mm)	1,260 x 816 x 326 (mm)
		44.7 x 29.2 x 12.8 (inch)	49.6 x 32.1 x 12.8 (inch)
	Without stand	1,137 x 677 x 37.2 (mm)	1,260 x 753 x 36.3 (mm)
		44.7 x 26.6 x 1.4 (inch)	49.6 x 29.6 x 1.4 (inch)
Weight	With stand	19.1 kg (42.1 lbs)	24.0 kg (52.9 lbs)
	Without stand	16.7 kg (36.8 lbs)	21.5 kg (47.3 lbs)
Current Value / Power consumption		1.3 A / 130 W	1.4 A / 140 W

MODELS		60GA6400 (60GA6400-UD)
		60GA6450 (60GA6450-UD)
Dimensions (W x H x D)	With stand	1,393 x 884 x 326 (mm)
		54.8 x 34.8 x 12.8 (inch)
	Without stand	1,393 x 834 x 41.4 (mm)
		54.8 x 32.8 x 1.6 (inch)
Weight	With stand	29.5 kg (65.0 lbs)
	Without stand	27.0 kg (59.5 lbs)
Current Value / Power consumption		1.8 A / 180 W

MODELS		47GA7900 (47GA7900-UA)	55GA7900 (55GA7900-UA)
		Dimensions (W x H x D)	With stand
42.4 x 27.1 x 11.2 (inch)	49.0 x 31.0 x 12.8 (inch)		
Without stand	1,077 x 625 x 34.1 (mm)		1,247 x 722 x 34.1 (mm)
	42.4 x 24.6 x 1.3 (inch)		49.0 x 28.4 x 1.3 (inch)
Weight	With stand	18.5 kg (40.7 lbs)	25.3 kg (55.7 lbs)
	Without stand	16.8 kg (37.0 lbs)	23 kg (50.7 lbs)
Current Value / Power consumption		1.3 A / 130 W	1.5 A / 150 W

HDMI (PC) supported mode

Resolution	Horizontal Frequency (KHz)	Vertical Frequency (Hz)
640x350	31.468	70.09
720x400	31.469	70.08
640x480	31.469	59.94
800x600	37.879	60.31
1024x768	48.363	60.00
1360x768	47.712	60.015
1280x1024 HDMI-PC	63.981	60.02
1920x1080	67.50	60.00

HDMI (DTV) supported mode

Resolution	Horizontal Frequency (KHz)	Vertical Frequency (Hz)
720x480p	31.47	59.94
	31.47	60.00
1280x720p	44.96	59.94
	45.00	60.00
1920x1080i	33.72	59.94
	33.75	60.00
1920x1080p	26.97	23.976
	27.00	24.00
	33.71	29.97
	33.75	30.00
	67.432	59.94
	67.50	60.00

Component port connecting information

Component ports on the TV	Y	P _B	P _R
---------------------------	---	----------------	----------------

Video output ports on DVD player	Y	P _B	P _R
	Y	B-Y	R-Y
	Y	Cb	Cr
	Y	Pb	Pr

Component supported mode

Resolution	Horizontal Frequency (KHz)	Vertical Frequency (Hz)
720x480i	15.73	59.94
	15.73	60.00
720x480p	31.47	59.94
	31.50	60.00
1280x720p	44.96	59.94
	45.00	60.00
1920x1080i	33.72	59.94
	33.75	60.00
1920x1080p	26.97	23.976
	27.00	24.00
	33.71	29.97
	33.75	30.00
	67.432	59.94
	67.50	60.00

Wireless LAN module (WN8122E1) specification

Standard	IEEE802.11a/b/g/n
Frequency Range	2400 to 2483.5 MHz 5150 to 5250 MHz 5725 to 5850 MHz
Output Power (Max.)	802.11a: 16.5 dBm 802.11b: 16 dBm 802.11g: 15.5 dBm 802.11n - 2.4GHz: 15.5 dBm 802.11n - 5GHz: 16.5 dBm

- Because band channel used by the country could be different, the user can not change or adjust the operating frequency and this product is set for the regional frequency table.
- Contains FCC ID: BEJWN8122E1
Contains IC: 2703H-WN8122E1

Bluetooth module (BM-LDS401) specification

Standard	Bluetooth Version 3.0
Frequency Range	2400 ~ 2483.5 MHz
Output Power (Max.)	10 dBm or lower

- Contains FCC ID: BEJLDS401
Contains IC: 2703H-LDS401

3D supported mode

- The method for 3D digital broadcast may differ depending on the signal environment. If video is not switched automatically into 3D, manually convert the settings to view 3D images.

3D supported mode automatically				
Input	Signal	Horizontal Frequency (kHz)	Vertical Frequency (Hz)	Playable 3D video format
HDMI	640 X 480	31.469 / 31.5	59.94 / 60	Top & Bottom, Side by Side(Half), Side by Side(Full)
		62.938 / 63		Frame Packing, Line Alternative
	480p	31.469 / 31.5		Top & Bottom, Side by Side(Half), Side by Side(Full)
		62.938 / 63		Frame Packing, Line Alternative
	720p	44.96 / 45	59.94 / 60	Top & Bottom, Side by Side(Half), Side by Side(Full)
		89.91 / 90	59.94 / 60	Frame Packing, Line Alternative
	1080i	33.72 / 33.75	59.94 / 60	Top & Bottom, Side by Side(Half), Side by Side(Full)
		67.5	59.94 / 60	Frame Packing, Field Alternative
	1080p	26.97 / 27	23.97 / 24	Top & Bottom, Side by Side(Half), Side by Side(Full)
		33.72 / 33.75	29.976 / 30	
		43.94 / 54	23.97 / 24	Frame Packing, Line Alternative
		67.432 / 67.5	29.976 / 30	
		67.432 / 67.5	59.94 / 60	

3D supported mode manually				
Input	Signal	Horizontal Frequency (KHz)	Vertical Frequency (Hz)	Playable 3D video format
HDMI-DTV	720p	45.00	60	2D to 3D, Side by Side(Half), Top & Bottom, Single Frame Sequential
	1080i	33.75	60	2D to 3D, Side by Side(Half), Top & Bottom
	1080p	27.00	24	2D to 3D, Side by Side(Half), Top & Bottom, Checker Board
		33.75	30	
	67.50	60	2D to 3D, Side by Side(Half), Top & Bottom, Checker Board, Single Frame Sequential, Row Interleaving, Column Interleaving	
HDMI-PC	1024x768	48.36	60	2D to 3D, Side by Side(Half), Top & Bottom
	1360x768	47.71		
	1920x1080	67.50		2D to 3D, Side by Side(Half), Top & Bottom, Checker Board, Single Frame Sequential, Row Interleaving, Column Interleaving
	Others	-	-	2D to 3D
Component	720p	45.00	60	2D to 3D, Side by Side(Half), Top & Bottom
	1080i	33.75	60	
	1080p	27.00	24	
		33.75	30	
		67.50	60	
Others	-	-	2D to 3D	
USB	1080p	33.75	30	2D to 3D, Side by Side(Half), Top & Bottom, Checker Board, Row Interleaving, Column Interleaving(Photo : Side by Side(Half), Top & Bottom), Single Frame Sequential
	Signal		Playable 3D video format	
DTV	HD		2D to 3D, Side by Side(Half), Top & Bottom	
	SD		2D to 3D	

Video Supported Formats

File Extension	Video Codec	Audio Codec	Max Resolution
mpg, mpeg	MPEG1,2	MP3, Dolby Digital, PCM	1920 x 1080 @ 30p
ts, trp, tp	MPEG1,2 H.264	MP3, Dolby Digital, AAC, HE-AAC,	
vob	MPEG1, 2	MP2, Dolby Digital	
mp4, mov	MPEG4, DivX 3.11, DivX 4, DivX 5, H.264, H.263	Dolby Digital, AAC, HE-AAC, MP3	
mkv	H.264, VC1, VP8, MPEG2, MPEG4, DivX 5	MP3, Dolby Digital, AAC HE-AAC	
avi, divx	MPEG4, DivX 3.11, DivX 4, DivX 5, DivX 6, H.264, VC-1, XVID	MP3, Dolby Digital, PCM, AAC, HE-AAC, WMA(standard)	
asf, wmv	VC1	WMA(standard)	
flv	Sorenson H.263, H264, VP6	MP3, AAC, PCM	

Subtitle Supported Formats

File Extension	Language	Etc.	Remark
smi, srt	English	Support UTF-8 encoded file.	Adjust : - 10 ~ + 10
	Spanish		
	French		

ENGLISH

Photo Supported Formats

File Extension	Item	Profile
JPEG, JPG, JPE	Support File type	SOF0 : baseline SOF1 : Extend Sequential SOF2 : Progressive
	Picture Size	Min : 64 * 64 Max : - Normal type : 15360(W)*8640(H), - Progressive type : 1920(W) * 1440(H)
PNG, GIF, BMP	Picture Size	Min 64x64 Max 8000 x 6000

Open Source Software Notice

To obtain the source code under GPL, LGPL, MPL and other open source licenses, that is contained in this product, please visit <http://opensource.lge.com>.

In addition to the source code, all referred license terms, warranty disclaimers and copyright notices are available for download.

LG Electronics will also provide open source code to you on CD-ROM for a charge covering the cost of performing such distribution (such as the cost of media, shipping and handling) upon email request to opensource@lge.com. This offer is valid for three (3) years from the date on which you purchased the product.

) **Federal Communications Commission(FCC) Statement**

You are cautioned that changes or modifications not expressly approved by the part responsible

for compliance could void the user's authority to operate the equipment.

This equipment has been tested and found to comply with the limits for a Class B digital device, pursuant to part 15 of the FCC rules.

These limits are designed to provide reasonable protection against harmful interference in a residential installation.

This equipment generates, uses and can radiate radio frequency energy and, if not installed and used in accordance with the instructions, may cause harmful interference to radio communications.

However, there is no guarantee that interference will not occur in a particular installation.

If this equipment does cause harmful interference to radio or television reception, which can be determined by turning the equipment off and on, the user is encouraged to try to correct the

interference by one or more of the following measures:

- . Reorient or relocate the receiving antenna.
- . Increase the separation between the equipment and receiver.
- . Connect the equipment into an outlet on a circuit different from that to which the receiver is connected
- . Consult the dealer or an experienced radio/TV technician for help.

This device complies with Part 15 of the FCC Rules.

Operation is subject to the following two conditions:

- 1) this device may not cause harmful interference, and
- 2) this device must accept any interference received, including interference that may cause undesired operation of the device.

Indoor use only

FCC Caution: Any changes or modifications not expressly approved by the party responsible for compliance could void the user's authority to operate this equipment.

Caution: Exposure to Radio Frequency Radiation.

1. This device and its antenna must not be co-located or operating in conjunction with any other antenna or transmitter.

2. This equipment complies with FCC RF radiation exposure limits set forth for an uncontrolled environment. This equipment should be installed and operated with a minimum distance of 20 centimeters between the radiator and your body.



The model and serial numbers of the TV is located on the back of the TV
Record it below should you ever need service.

MODEL _____

SERIAL _____