

## SIMPLINK Functions

- **Direct Play:** After connecting AV devices to the TV, you can directly control the devices and play media without additional settings.
- **Select AV device:** Enables you to select one of the AV devices connected to TV.
- **Disc playback:** Control connected AV devices by pressing the  $\wedge$   $\vee$   $\langle$   $\rangle$ , ENTER,  $\blacktriangleright$ ,  $\blacksquare$ ,  $\text{II}$ ,  $\blacktriangleleft$  and  $\blacktriangleright$  buttons.
- **Power off all devices:** When you power off the TV, all connected devices are turned off.
- **Switch audio-out:** Offers an easy way to switch audio-out.
- **Sync Power on:** When the equipment with Simplink function connected HDMI terminal starts to play, The TV will change automatically to turn on mode.

(A device, which is connected to the TV through a HDMI cable but does not support SIMPLINK, does not provide this function)

Note: To operate SIMPLINK, an HDMI cable over Version 1.3 with \*CEC function should be used. (\*CEC: Consumer Electronics Control).

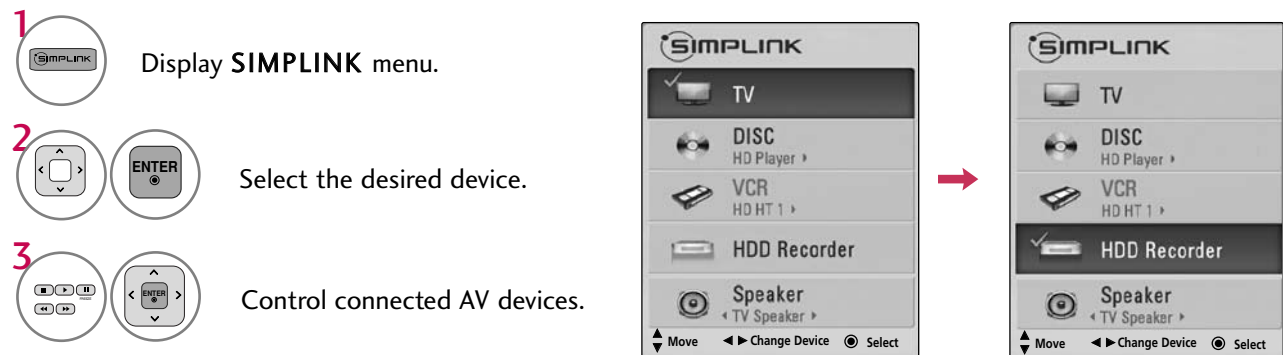

## SIMPLINK Menu

- 1 **TV viewing:** Switch to the previous TV channel regardless of the current mode.
- 2 **DISC playback:** Select and play discs. When multiple discs are available, the titles of discs are conveniently displayed at the bottom of the screen.
- 3 **VCR playback:** Control the connected VCR.
- 4 **HDD Recordings playback:** Control recordings stored in HDD.
- 5 **Audio Out to Home Theater speaker/Audio Out to TV:** Select Home Theater speaker or TV speaker for Audio Out.

- ▶ When no device is connected (displayed in gray)
- ▶ Selected Device
- ▶ When a device is connected (displayed in bright color)

# USB - Only 50/60PK550, 42/50PJ350 models

## ENTRY MODES

When you connect a USB device, this screen is displayed automatically.

In USB device, you can not add a new folder or delete the existing folder.

**1** Connect the USB device to the **USB IN** jacks on the side of TV.

- It doesn't support USB HDD.
- This TV supports JPG and MP3 files.

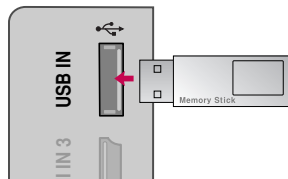

**2** Select **Photo List**, **Music List** or **Movie List**.

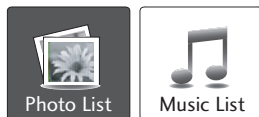

### NOTE

- ▶ In order to avoid losing the USB memory stick, use the USB connector to fix the USB memory stick to the USB connector holder of the TV.

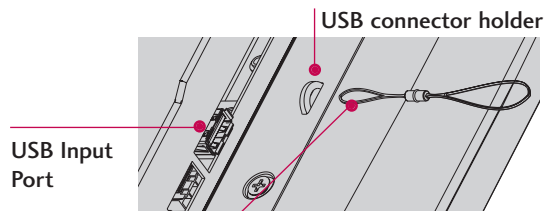

**USB Connector (sold separately)**

- Fix the one end of the USB connector to the USB memory stick and the other end to the USB connector holder.

### When removing the USB device

Select the **Eject USB** menu before removing the USB device.



### Precautions when using the USB device

- ▶ Only a USB storage device is recognizable.
- ▶ If the USB storage device is connected through a USB hub, the device is not recognizable.
- ▶ A USB storage device using an automatic recognition program may not be recognized.
- ▶ A USB storage device which uses its own driver may not be recognized.
- ▶ In case of a card reader, up to four memory cards are concurrently recognizable.
- ▶ The recognition speed of a USB storage device may depend on each device.
- ▶ Please do not turn off the TV or unplug the USB device when the connected USB storage device is working. When such device is suddenly separated or unplugged, the stored files or the USB storage device may be damaged.
- ▶ Only use a USB storage device which has normal music files or image files.
- ▶ Please use only a USB storage device which was formatted as a FAT16, FAT32 or NTFS file system provided with the Windows operating system. In case of a storage device formatted as a different utility program which is not supported by Windows, it may not be recognized.
- ▶ Please connect power to a USB storage device which requires an external power supply. If not, the device may not be recognized.
- ▶ Please connect a USB storage device with cable is offered by USB maker. If connected with cable is not offered by USB maker or an excessively long cable, the device may not be recognized.
- ▶ Some USB storage devices may not be supported or operate properly.
- ▶ The TV will display up to 128 characters of a files name.
- ▶ Please backup important files because data on USB device may be damaged. Data management is consumer's responsibility and as a result, the manufacturer does not cover data damage.
- ▶ The recommended capacity is 1TB or less for a USB external hard disk and 32GB or less for USB memory. Any device with more than the recommended capacity may not work properly.

# PHOTO LIST

You can view (\*.JPG) files from USB storage devices.  
 The On Screen Display on your model may be slightly different.

**Supported photo file: \*.JPG**

- You can play JPG files only.
- Only baseline scan is supported among JPG.

## Screen Components

**1** Select **USB**.

**2** Select **Photo List**.

**1** Moves to upper level file

**2** Preview: Display the thumbnail/folder name of the photo in the selected folder

**3** Current page/Total pages

**4** Total number of marked photos

**5** Usable USB memory

**6** Corresponding buttons on the remote control

**PHOTO LIST**

Page 1/1  No Marked

USB Device  
Free Space 150MB

Top Folder  
DriveA  
0 folder, 4 file(s)

DriveA

Up Folder





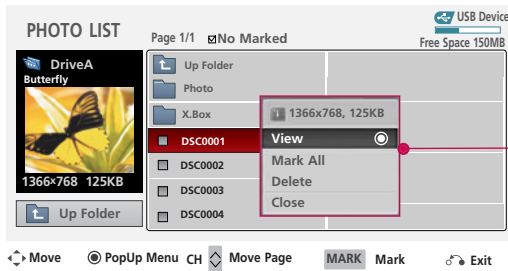
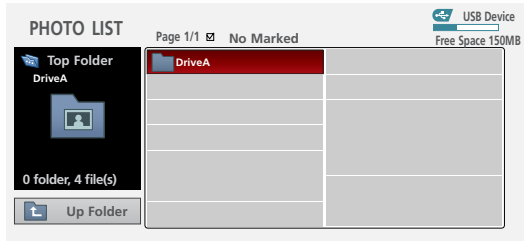

Move PopUp Menu CH Move Page MARK Mark Exit

## Photo Selection and PopUp Menu



When you select a file (not folder), this PopUp menu is displayed.

- ▶ **View:** Display the selected item.
- ▶ **Mark All:** Mark all photos on the screen.
- ▶ **Unmark All:** Deselect all marked photos.
- ▶ **Delete:** Delete the selected photo item.
- ▶ **Close:** Close the pop-up menu.

- 1  Select the target folder or drive.
- 2   Select the desired photos.
- 3  Show the Popup menu.
- 4   Select the desired Popup menu.





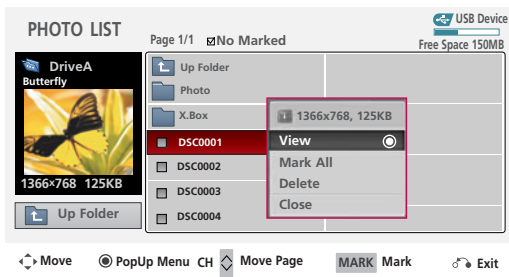
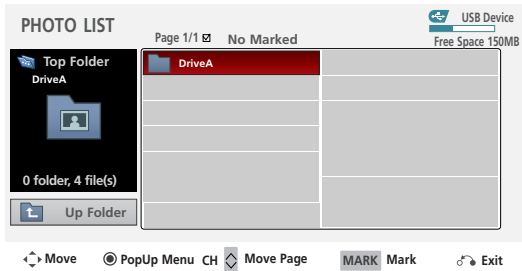

- Use the **CH** ^ v button to navigation in the photo page.
- Use the **MARK** button to mark or unmark a photo. When one or more photos are marked, you can view individual photos or a slide show of the marked photos. If no photos are marked, you can view all photos individually or all photos in the folder in a slide show.

## Full Screen Menu

You can change the Photo List view so that it fills the screen. More operations are available in full screen mode.



The aspect ratio of a photo may change the size of the photo displayed on the screen in full size.

- 1  Select the target folder or drive.
- 2   Select the desired photos.
- 3  Show the Popup menu.
- 4  Select **View**.
- 5  The selected photo is displayed in full size.

■ Use the CH ^ v button to navigation in the photo page.

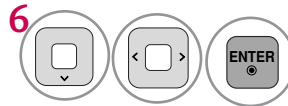

6 Select the **Slideshow**, **BGM**, **Rotate**, **Delete**, **Option**, or **Hide**.

- Use < > button to select the previous or next photo.
- Use ^ v < > button to select and control the menu on the full-sized screen.

- ▶ **Slideshow:** Selected photos are displayed during the slide show. If no photo is selected, all photos in the current folder are displayed during slide show.
  - Set the time interval of the slide show in **Option**.
- ▶ **BGM:** Listen to music while viewing photos in full size.
  - Set the BGM device and album in **Option**.
- ▶ **Rotate:** Rotate photos.
  - Rotates the photo 90°, 180°, 270°, 360° clockwise.
- ▶ **Delete:** Delete photos.
- ▶ **Option:** Set values for **Slide Speed** and **Music Folder**.
  - Use < > button and **ENTER** button to set values. Then go to **Enter** and press **ENTER** to save the settings.
  - You cannot change **Music Folder** while BGM is playing.
- ▶ **Hide :** Hide the menu on the full-sized screen.
  - To see the menu again on the full-sized screen, press **ENTER** button to display.

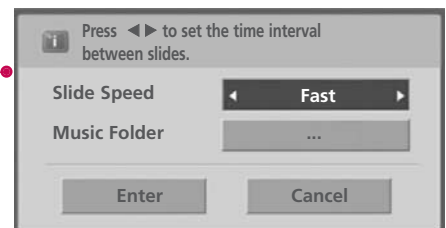

## ! NOTE

- ▶ This TV will not be able to decode most JPEG images saved using the Progressive option.

# MUSIC LIST

You can use the Music List menu to play MP3 files from a USB storage device.

This TV cannot play back copy-protected files.

The On Screen Display on your model may be slightly different.

### Supported music file: \*.MP3

Bit rate range 8Kbps ~ 320Kbps

- Sampling rate (Sampling Frequency)  
MPEG1 Layer 3 : 8KHz ~ 48KHz
- Music Max Length : 999.59 Sec.

## Screen Components

**1**

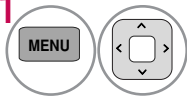

Select **USB**.

**2**

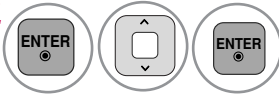

Select **Music List**.

- ① Moves to upper level file
- ② Preview: Display the title/folder name of the music in the selected folder
- ③ Current page/Total pages
- ④ Total number of marked musics
- ⑤ Usable USB memory
- ⑥ Corresponding buttons on the remote control

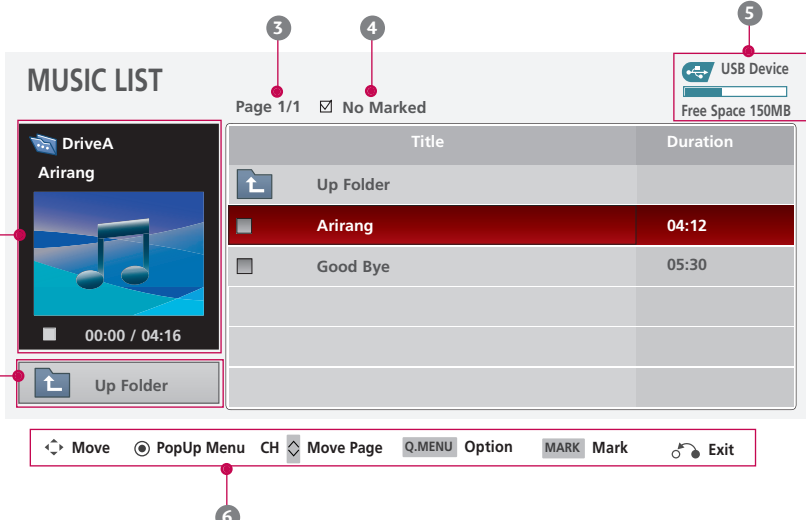

The screenshot shows the 'MUSIC LIST' screen. At the top, it displays 'Page 1/1' and 'No Marked'. A 'USB Device' status bar shows 'Free Space 150MB'. The main area is a table with columns 'Title' and 'Duration'. The first row is 'Up Folder'. The second row, 'Arirang', is highlighted in red and has a duration of '04:12'. The third row is 'Good Bye' with a duration of '05:30'. A preview window on the left shows 'DriveA Arirang' with a play button and a progress bar from '00:00 / 04:16'. At the bottom, a navigation bar includes buttons for 'Move', 'PopUp Menu', 'CH', 'Move Page', 'Q.MENU', 'Option', 'MARK', 'Mark', and 'Exit'.

## Music Selection and Popup Menu

Up to 6 music titles are listed per page.

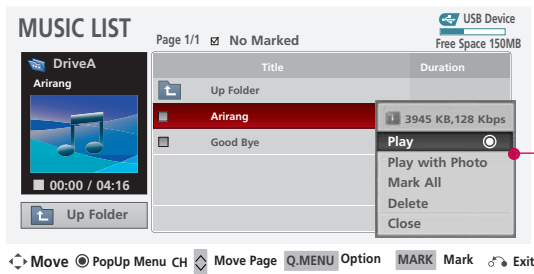
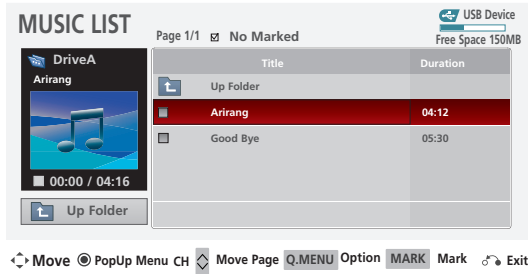

- ▶ **Play (During stop):** Play the selected music. Once a song finishes playing, the next selected one will be played. When there are no selected musics to play, the next one in the current folder will be played. If you go to a different folder and press the **ENTER** button, the current music in playback will stop.
- ▶ **Play Marked:** Play the selected musics. Once a music finishes playing, the next selected one will be played automatically.
- ▶ **Stop Play (During playback):** Stop the playing musics.
- ▶ **Play with Photo:** Start playing the selected musics and then move to the Photo List.
- ▶ **Mark All:** Mark all musics in the folder.
- ▶ **Unmark All:** Deselect all marked music.
- ▶ **Delete:** Delete the selected music.
- ▶ **Close:** Close the pop-up menu.

- 1 Select the target folder or drive.
- 2 Select the desired musics.
- 3 Show the Popup menu.
- 4 Select the desired Popup menu.
- 5 Return to TV viewing

- Use the **CH** ^ v button to navigation in the music page.
- Use **MARK** button to mark or unmark a music file. If no music is marked, all the music in the folder will be played in sequence. When one or more music files are marked, the marked music files will be played in sequence. If you want to listen to only one song repeatedly, just mark that one file and play.



- The play information box (as shown below) will automatically move across the screen when there is no user input to prevent a fixed image remaining on the screen for an extended period of time.



### ! NOTE

- ▶ When music is playing,  is displayed in front of the music play time.
- ▶ A damaged or corrupted music file that does not play displays 00:00 as the play time.
- ▶ Music files with copy-protection will not play.
- ▶ Press **ENTER**, **■**, or **RETURN** button to stop the screen saver.
- ▶ This TV can not play music files less than 16 Kbytes.

# PICTURE CONTROL

## PICTURE SIZE (ASPECT RATIO) CONTROL

This feature lets you choose the way an analog picture with a 4:3 aspect ratio is displayed on your TV.

- RGB-PC input source use 4:3 or 16:9 aspect ratio.

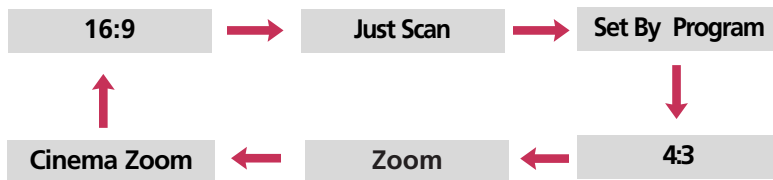
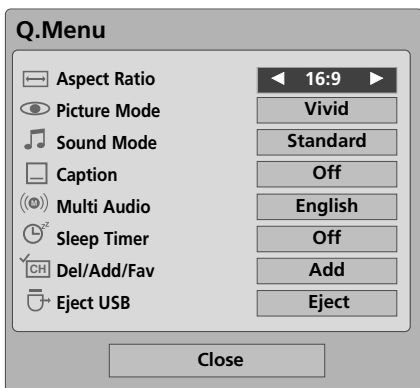

- 1   Select the **Aspect Ratio**.
- 2  Select the desired picture format.
- 3  Return to TV viewing.

- You can also press the **RATIO** button repeatedly on the remote control.

## 16:9

Adjust the picture horizontally, in a linear proportion to fill the entire screen.



## Just Scan

Normally the edges of video signals are cropped 1-2%. Just Scan turns off this cropping and shows the complete video.

Notes: If there is noise on the edges of the original signal, it will be visible when Just Scan is activated.

**Just Scan** operates only in DTV/CADTV/Component/HDMI-DTV/DVI-DTV (720p/1080i/1080p) input source.



## Set by program

Selects the proper picture proportion to match the source's image.

(4:3 → 4:3)



(16:9 → 16:9)



## 4:3

Choose 4:3 when you want to view a picture with an original 4:3 aspect ratio.



## Zoom

Choose Zoom when you want to view the picture without any alteration. However, the top and bottom portions of the picture will be cropped.

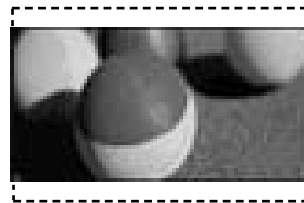

## Cinema Zoom

Choose Cinema Zoom when you want to enlarge the picture in correct proportion. Note: When enlarging or reducing the picture, the image may become distorted.



■ The adjustment range is 1-16.

# PICTURE CONTROL

## PICTURE WIZARD - Only 50/60PK550, 42/50PJ350 models

This feature lets you adjust the picture quality of the original image.

Use this to calibrate the screen quality by adjusting the Black and White Level etc. You can calibrate the screen quality by easily following each step.

When you adjust the image to **Low**, **Recommended** or **High**, you can see the example of the changes you made.

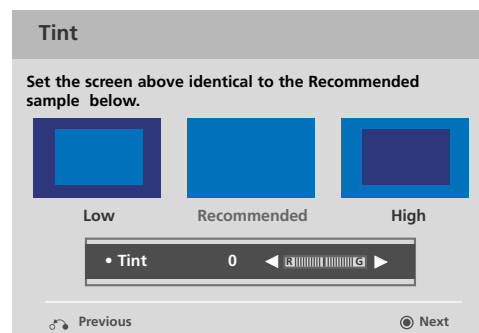
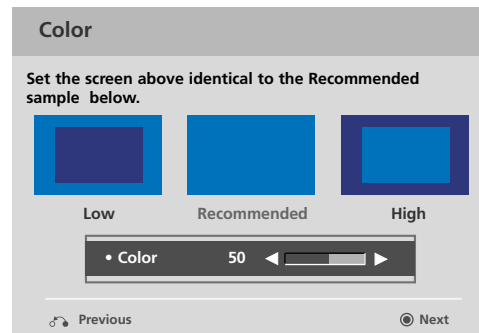
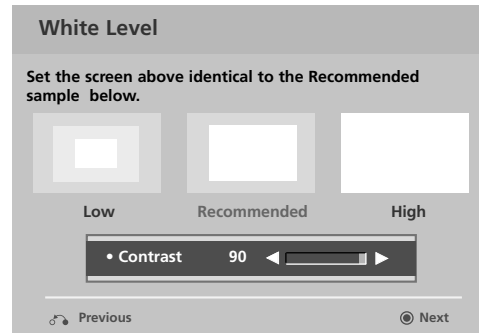
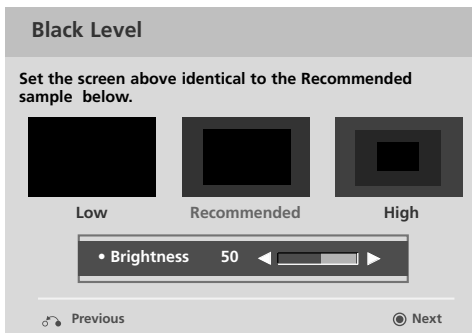
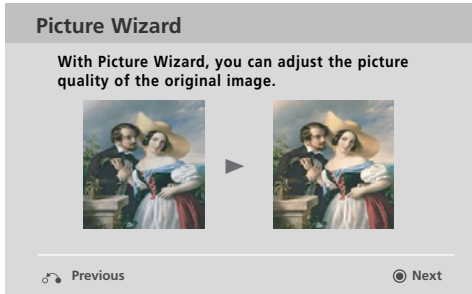
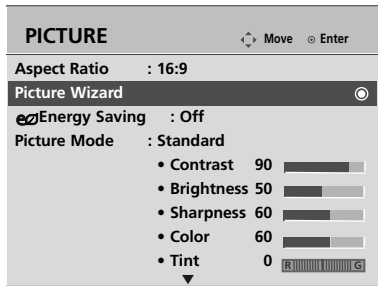

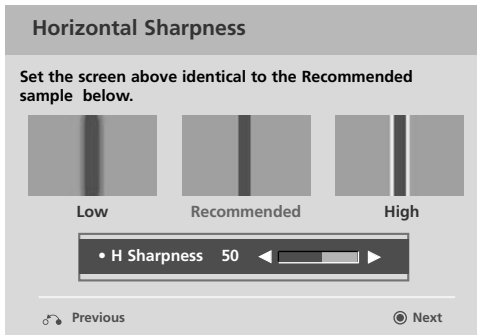

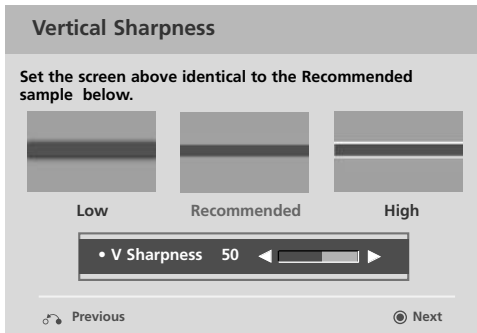

8   Adjust **Horizontal Sharpness**.



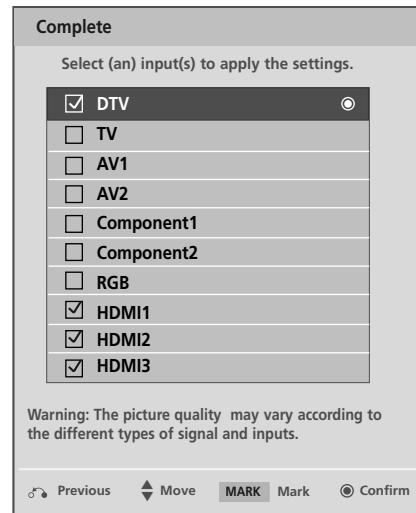

9   Adjust **Vertical Sharpness**.

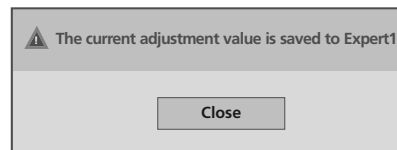

10   Select input source to apply the settings.

11  Save.



12  Finish the Picture Wizard.

■ If you stop the setting before the final step, the changes will not be saved to the TV.

# PICTURE CONTROL







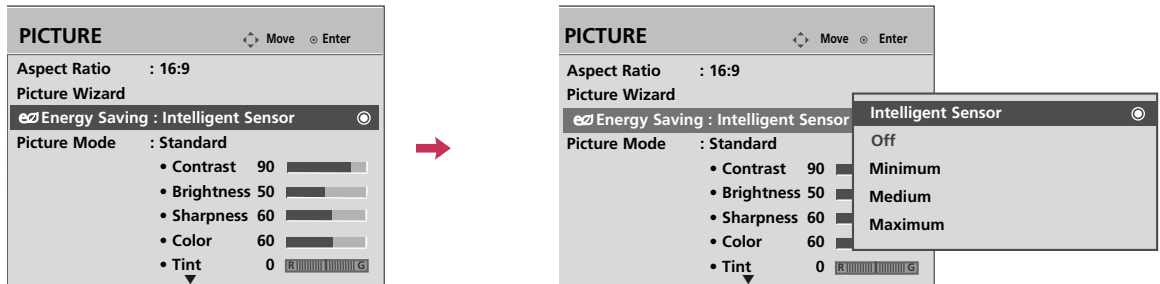

## e ENERGY SAVING

It reduces the TV's power consumption.

The default factory setting complies with the Energy Star requirements and is adjusted to the comfortable level to be viewed at home.

You can increase the brightness of your screen by adjusting the Energy Saving level or by setting the Picture Mode. This feature is disabled in "Picture Mode-Cinema".



-   Select **PICTURE**.
-   Select **Energy Saving**.
-   Select **Intelligent Sensor**,  
**Off, Minimum, Medium or Maximum**.
-  Return to the previous menu.
-  Return to TV viewing.

- You can also adjust the **ENERGY SAVING** button on the remote control.
- **Intelligent Sensor?**  
This function automatically adjusts the brightness of screen to the most suitable picture according to the surrounding conditions.

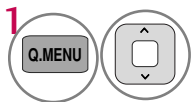
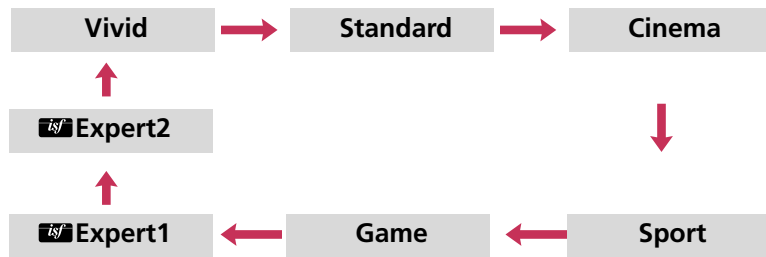
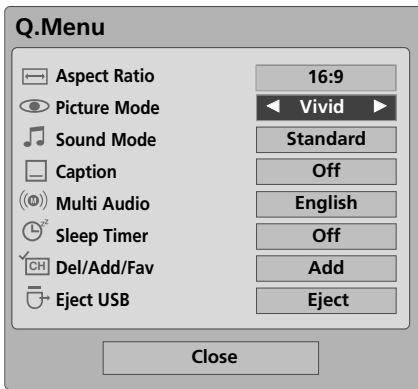

## PRESET PICTURE SETTINGS (PICTURE MODE)

There are factory presets for picture settings available in the user menus. You can use a preset, change each setting manually.

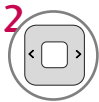

Select **Picture Mode**.



Select **Vivid, Standard, Cinema, Sport, Game,  Expert1 or  Expert2**.



Return to TV viewing.









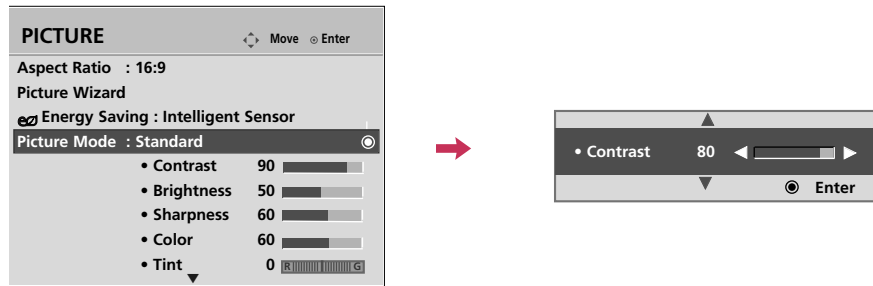



- **Vivid, Standard, Cinema, Sport, and Game** Settings are preset for the optimum picture quality at the factory.
- You can also adjust **Picture Mode** in the **PICTURE** menu.
- **Vivid:** This is the mode to maximize the effect of the video in the retail store. Strengthen the contrast, brightness, color and sharpness for vivid picture.
- **Standard:** This is the mode to realize optimum viewing condition for the general user.
- **Cinema:** This mode optimizes video for watching movies.
- **Sport:** This is the video mode to emphasize dynamic video and primary color (Ex, white, uniform, grass, sky blue etc.) by realizing the optimal screen for sports.
- **Game:** This is the mode to realize fast response speed in a fast gaming screen.
- **Expert:** This is the mode to adjust the video in detail for video quality expert and general user.

# PICTURE CONTROL

## MANUAL PICTURE ADJUSTMENT-USER MODE

Adjust the picture appearance to suit your preference and viewing situations.



- 1   Select **PICTURE**.
- 2   Select **Picture Mode**.
- 3   Select **Vivid, Standard, Cinema, Sport, or Game**.
- 4   Select **Contrast, Brightness, Sharpness, Color, or Tint**.
- 5   Make appropriate adjustments.
- 6  Return to the previous menu.
-  Return to TV viewing.

- **Contrast:** Increase or decrease the gradient of the video signal. You may use Contrast when the bright part of picture is saturated.
- **Brightness:** Adjusts the base level of the signal in the picture. You may use brightness when the dark part of the picture is saturated.
- **Sharpness:** Adjusts the level of crispness in the edges between the light and dark areas of the picture. The lower the level, the softer the image.
- **Color:** Adjusts intensity of all colors.
- **Tint:** Adjusts the balance between red and green levels.



# PICTURE IMPROVEMENT TECHNOLOGY

You can calibrate the screen for each Picture Mode or set the video value according to the special video screen. You can set the video seeing differently for each input.





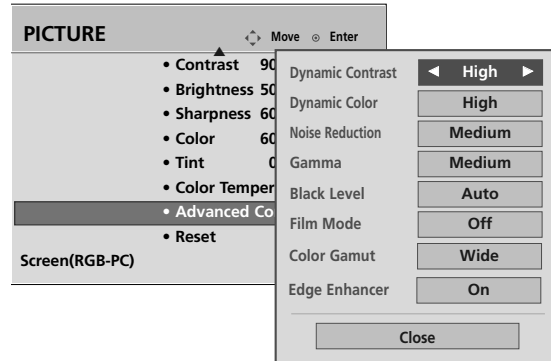
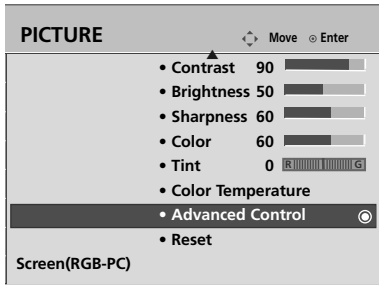

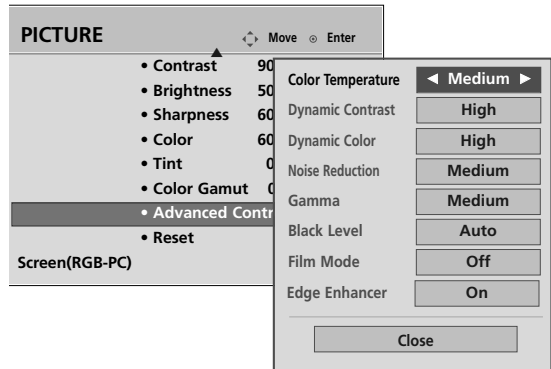
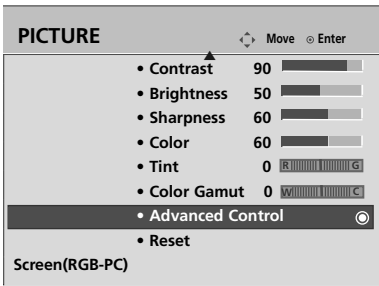

To reset to the factory default screen after making adjustments to each video mode, execute the “Reset” function for each Picture Mode.

For 50/60PK550, 42PJ350



For 50PK250



- 1   Select **PICTURE**.
  - 2   Select **Advanced Control**.
  - 3   Select your desired options.
  - 4  Make appropriate adjustments.
  - 5  Return to the previous menu.
-  Return to TV viewing.









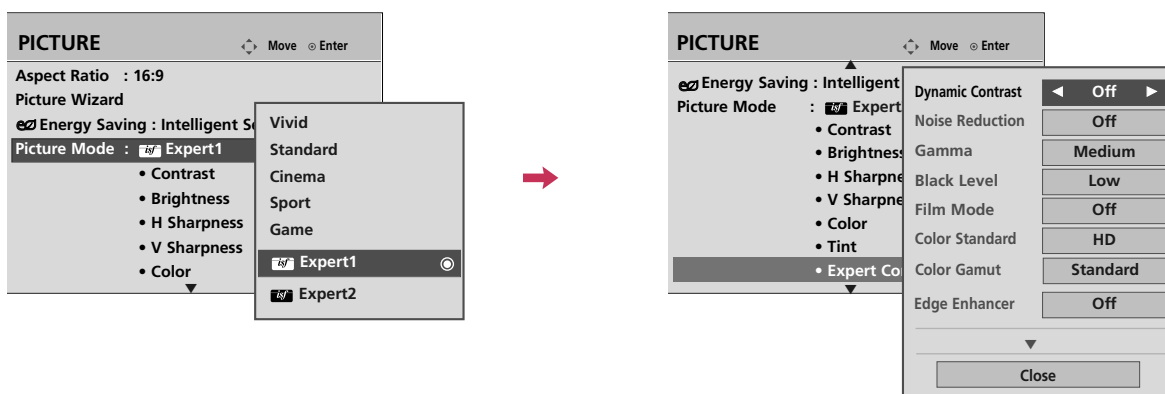



# PICTURE CONTROL

## EXPERT PICTURE CONTROL

By segmenting categories, **Expert1** and **Expert2** provide more categories which users can set as they see fit, offering the optimal picture quality for users.

This may also be used be a professional to help optimize the TV performance in the environment the TV is in.



-   Select **PICTURE**.
-   Select **Picture Mode**.
-   Select **Expert1**, or **Expert2**.
-   Select **Expert Control**.
-   Select your desired menu option.
-  Make appropriate adjustments.
-  Return to the previous menu.
-  Return to TV viewing.





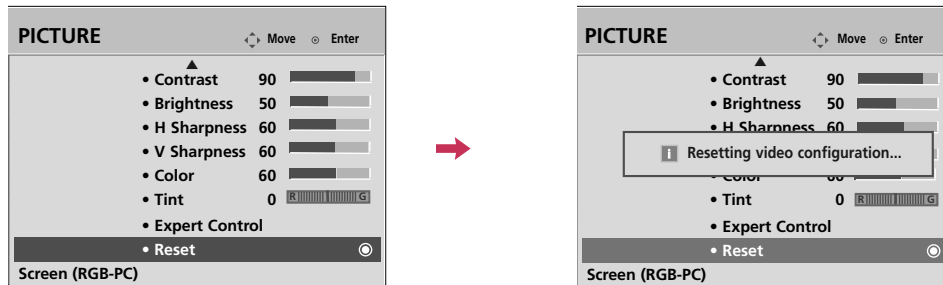

Color Temperature	<ul style="list-style-type: none"> <li>■ Set to warm to enhance hotter colors such as red, or set to cool to make picture bluish.</li> </ul>
Dynamic Contrast	<ul style="list-style-type: none"> <li>■ Adjusts the contrast to keep it at the best level according to the brightness of the screen. The picture is improved by making bright parts brighter and dark parts darker.</li> </ul>
Dynamic Color	<ul style="list-style-type: none"> <li>■ Adjusts screen colors so that they look livelier, richer and clearer. This feature enhances hue, saturation and luminance so that red, blue, green and white look more vivid.</li> </ul>
Noise Reduction	<ul style="list-style-type: none"> <li>■ Reduces screen noise without compromising video quality.</li> </ul>
Gamma	<p><i>Low : Make dark and middle gray level area of the picture brighter.</i>  <i>Medium: Express original picture levels.</i>  <i>High: Make dark and middle gray level area of the picture darker.</i></p> <ul style="list-style-type: none"> <li>■ You can adjust brightness of dark area and middle gray level area of the picture.</li> </ul>
Black Level	<p><i>Low: The reflection of the screen gets darker.</i>  <i>High: The reflection of the screen gets brighter.</i>  <i>Auto: Realizing the black level of the screen and set it to High or Low automatically.</i></p> <ul style="list-style-type: none"> <li>■ Set black level of the screen to proper level.</li> <li>■ This function enables to select 'Low' or 'High' in the following mode: AV (NTSC-M), HDMI or Component. Otherwise, 'Black level' is set to 'Auto'.</li> </ul>
Film Mode	<ul style="list-style-type: none"> <li>■ Makes video clips recorded in film look more natural by eliminating judder effect.</li> <li>■ DVD and Blu-ray movies are filmed at 24 frames per second.</li> </ul>
Color Gamut	<p><i>Standard: Displays standard color area.</i>  <i>Wide: Mode to use and set the rich color area of the display.</i></p> <ul style="list-style-type: none"> <li>■ Maximize the utilization of color to increase color quality.</li> <li>■ In Advanced Control mode, this feature is enabled in “<b>Color Temperature - Warm</b>”.</li> </ul>
Edge Enhancer	<ul style="list-style-type: none"> <li>■ Show clearer and distinctive yet natural corners of the video.</li> </ul>
Color Standard	<ul style="list-style-type: none"> <li>■ Convert the color of a different video to HD color.</li> </ul>
White Balance	<ul style="list-style-type: none"> <li>■ This is the function to adjust the overall color of the screen to the feeling you want. <ul style="list-style-type: none"> <li>a. Method : 2 Points <ul style="list-style-type: none"> <li>- Pattern: Inner, Outer</li> <li>- Red/Green/Blue Contrast, Red/Green/Blue Brightness: The adjustment range is -50 - +50.</li> </ul> </li> <li>b. Method : 20 Point IRE <ul style="list-style-type: none"> <li>- Pattern: Inner, Outer</li> <li>- IRE (Institute of Radio Engineers) is the unit to display the size of the video signal and can be set among 5, 10, 15 - 95, 100. You can adjust Red, Green or Blue according to each setting.</li> <li>- Red/Green/Blue: The adjustment range is -50 - +50.</li> </ul> </li> </ul> </li> </ul>
Color Management System	<ul style="list-style-type: none"> <li>■ As the tool used by the experts to make adjustments by using the test patterns, this does not affect other colors but can be used to selectively adjust the 6 color areas (Red/Green/Blue/Cyan/Mgt/Yellow). Color difference may not be distinctive even when you make the adjustments for the general video. Adjusts Red/Green/Blue/Yellow/Cyan, Magenta. <ul style="list-style-type: none"> <li>- Red/Green/Blue/Yellow/Cyan, Magenta Color: The adjustment range is -30 - +30.</li> <li>- Red/Green/Blue/Yellow/Cyan, Magenta Tint: The adjustment range is -30 - +30.</li> <li>- This feature is disable in RGB-PC and HDMI (PC) mode.</li> </ul> </li> </ul>

# PICTURE CONTROL

## PICTURE RESET

Settings of the selected picture modes return to the default factory settings.









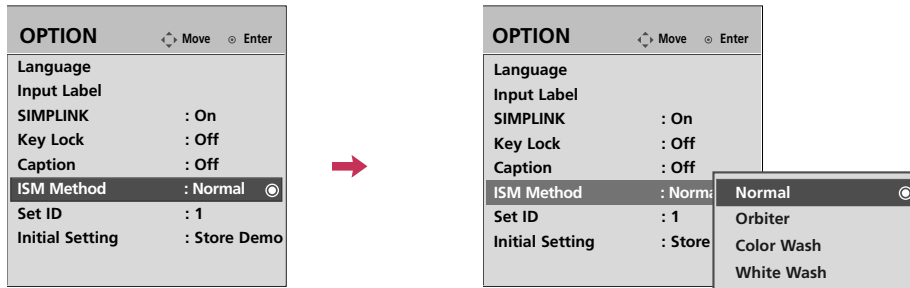

-   Select **PICTURE**.
-   Select **Reset**.
-  Initialize the adjusted value.
-  Return to TV viewing.

## IMAGE STICKING MINIMIZATION (ISM) METHOD

A frozen still picture displayed on the screen for prolonged periods can result in a ghost image. You can use Orbiter to help prevent image sticking. The other two functions are for removing a ghost image.



- 1   Select **OPTION**.
- 2   Select **ISM Method**.
- 3   Select **Normal, Orbiter, Color Wash** or **White Wash**.
- 4  Return to the previous menu.
-  Return to TV viewing.

- **Normal:** If image sticking is never a problem, ISM is not necessary - set to Normal.
- **Orbiter:** Orbiter may help prevent ghost images. However, it is best not to allow any fixed image to remain on the screen. To avoid a ghost image on the screen, the image will move every 2 minutes.
- **Color Wash:** The color block with the screen moved a little and the white pattern are alternately displayed. It is difficult to see the after image on all colors. Once it has been corrected it will not be visible in any color.
- **White Wash:** White Wash removes ghost images from the screen. Use sparingly. Watch the TV normally for a while before using this feature to see if the ghost image disappears on its own.

### ! NOTE

- ▶ An excessive ghosted image may be impossible to clear entirely with White Wash. To return to normal viewing, press the any button.

# PICTURE CONTROL







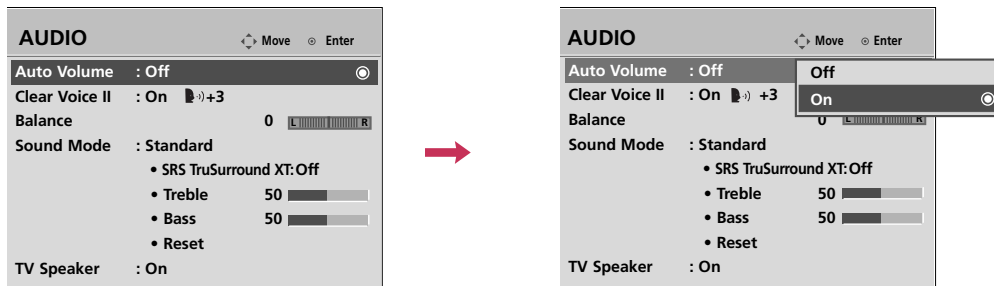

# SOUND & LANGUAGE CONTROL

## AUTO VOLUME LEVELER (AUTO VOLUME)

Auto Volume makes sure that the volume level remains consistent whether you are watching a commercial or a regular TV program.

Because each broadcasting station has its own signal conditions, volume adjustment may be needed every time the channel is changed. This feature allows users to enjoy stable volume levels by making automatic adjustments for each program.







- 1   Select **AUDIO**.
- 2   Select **Auto Volume**.
- 3   Select **On** or **Off**.
- 4  Return to the previous menu.
-  Return to TV viewing.

# SOUND & LANGUAGE CONTROL

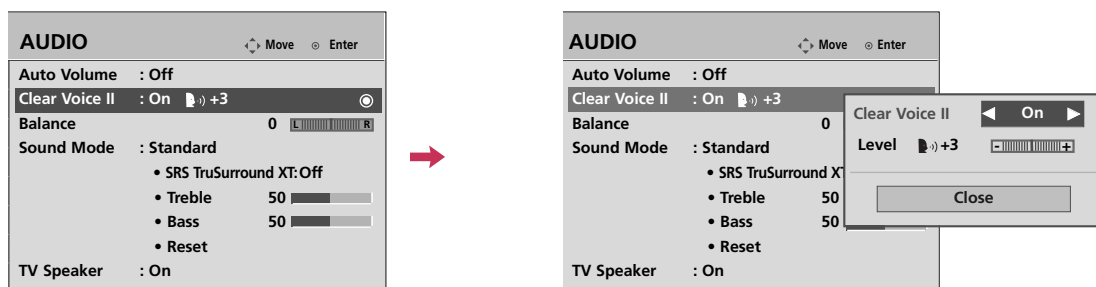

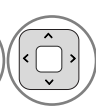

## CLEAR VOICE II

By differentiating the human sound range from others, it improves the sound quality of voices.

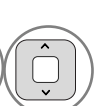

- 1   Select **AUDIO**.
- 2   Select **Clear Voice II**.
- 3   Select **On** or **Off**.

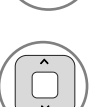
### Adjustment for Clear Voice II Level With selecting On

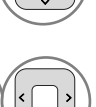
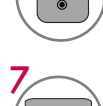
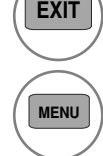
- 4   Select **Clear Voice II**.
- 5   Select **Level**.
- 6   Make appropriate adjustments.
- 7  Return to the previous menu.
-  Return to TV viewing.

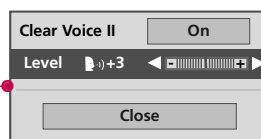



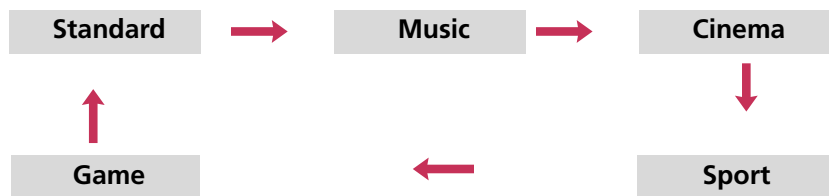
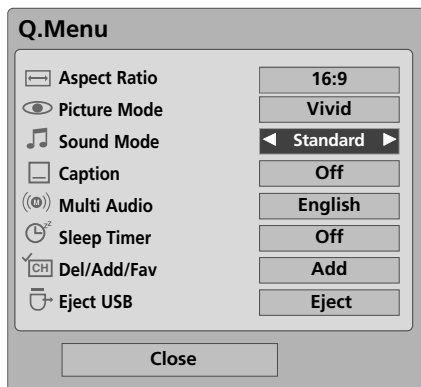

## PRESET SOUND SETTINGS (SOUND MODE)

Sound Mode lets you enjoy the best sound without any special adjustment as the TV sets the appropriate sound options based on the program content.

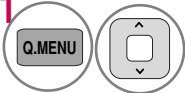

-  Select **Sound Mode**.
-  Select **Standard, Music, Cinema, Sport, or Game**.
-  Return to TV viewing.







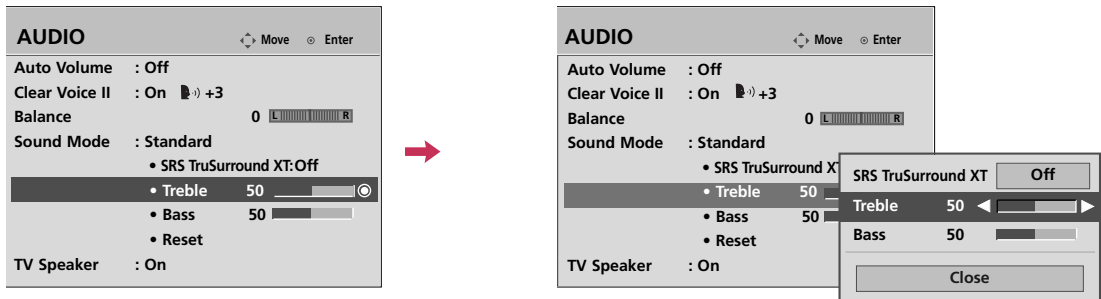

- **Standard, Music, Cinema, Sport, and Game** are preset for optimum sound quality at the factory.
- You can also adjust **Sound Mode** in the **AUDIO** menu.
- **Standard:** Offers standard-quality sound.
- **Music:** Optimizes sound for listening to music.
- **Cinema:** Optimizes sound for watching movies.
- **Sport:** Optimizes sound for watching sports events.
- **Game:** Optimizes sound for playing games.





# SOUND & LANGUAGE CONTROL

## SOUND SETTING ADJUSTMENT - USER MODE

Adjust the sound to suit your taste and room situations.











-   Select **AUDIO**.
-   Select **Sound Mode**.
-   Select **Standard, Music, Cinema, Sport, or Game**.
-   Select **Treble or Bass**.

-   Make appropriate adjustments.
-  Return to the previous menu.
-  Return to TV viewing.

### SRS TRUSURROUND XT

Select this option to sound realistic.







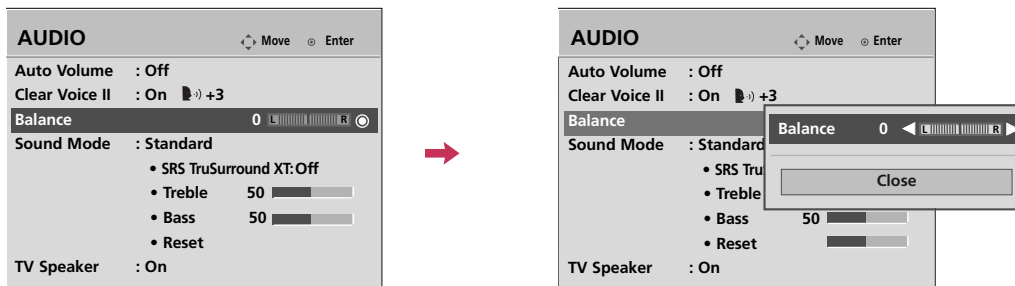

-   Select **AUDIO**.
-   Select **SRS TruSurround XT**.
-   Select **On or Off**.
-  Return to the previous menu.
-  Return to TV viewing.

- If sound quality or volume is not at the level you want, it is recommended to use a separate home theater system or amp to cope with different user environments.
- If you select “**Clear Voice II-On**”, **SRS TruSurround XT** feature will not work.
- **SRS TruSurround XT**: TruSurround XT is a patented SRS technology that solves the problem of playing 5.1 multichannel content over two speakers.

# BALANCE

Adjust the left/right sound of speaker to suit your taste and room situations.



-   Select **AUDIO**.
-   Select **Balance**.
-   Make appropriate adjustments.
-  Return to the previous menu.
-  Return to TV viewing.

# SOUND & LANGUAGE CONTROL

## TV SPEAKERS ON/OFF SETUP

Turn the TV speakers off if using external audio equipment.

In **AV**, **Component**, **RGB** and **HDMI** with HDMI to DVI cable, the TV speaker can be operational even when there is no video signal.

If you wish to use an external Hi-Fi system or a SRS System, turn off the TV's internal speakers.

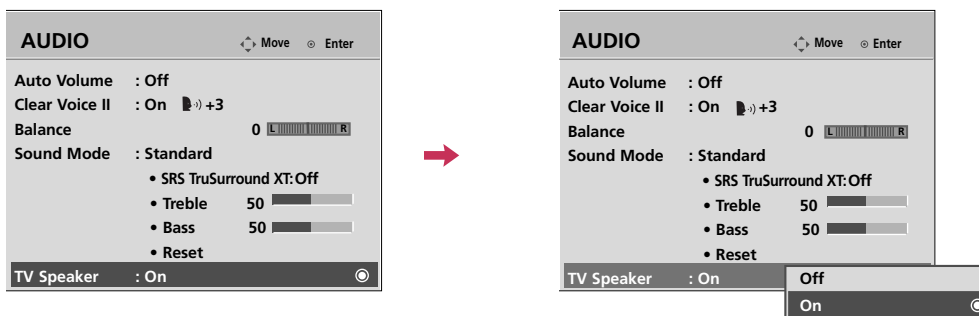

-   Select **AUDIO**.
-   Select **TV Speaker**.
-   Select **On** or **Off**.
-  Return to the previous menu.
-  Return to TV viewing.

# AUDIO RESET

Settings of the selected Sound Mode return to the default factory settings.

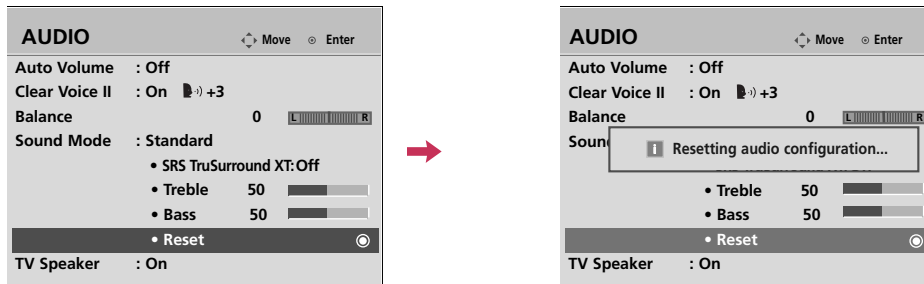

1   Select **AUDIO**.

2   Select **Reset**.

3  Initialize the adjusted value.

4  Return to TV viewing.



# SOUND & LANGUAGE CONTROL

## STEREO/SAP BROADCAST SETUP

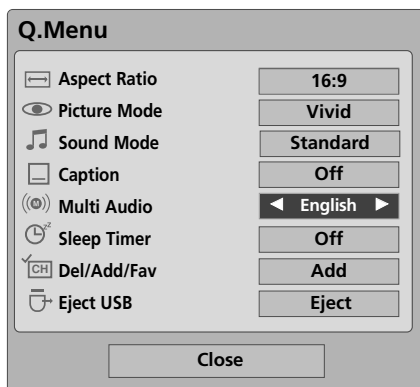

For Analog only: This TV can receive MTS stereo programs and any SAP (Secondary Audio Program) that accompanies the stereo program if the station transmits an additional sound signal. Mono sound is automatically used if the broadcast is only in Mono.

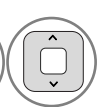
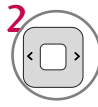

### Analog TV

- 1   Select **SAP**.
- 2  Select **Mono, Stereo, or SAP**.
- 3  Return to TV viewing.

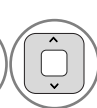
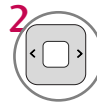

### Digital TV

- 1   Select **Multi Audio**.
- 2  Select other languages.
- 3  Return to TV viewing.

# AUDIO LANGUAGE

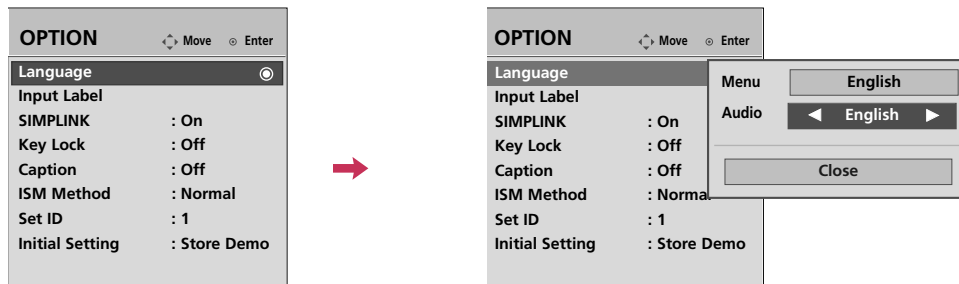
Other languages may be available if a digital signal is provided by the broadcasting station.  
This feature operates only in DTV/CADTV mode.









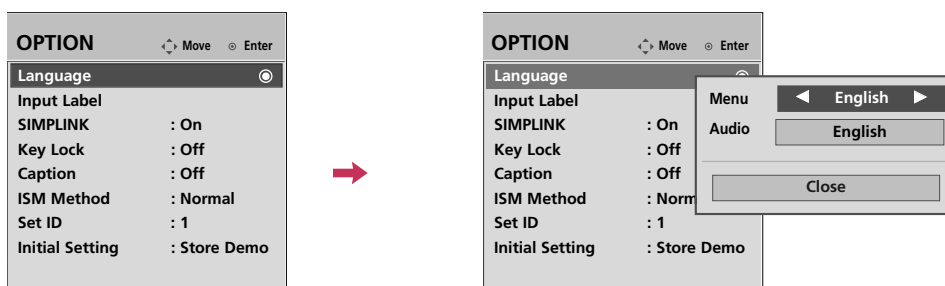

-   Select **OPTION**.
-   Select **Language**.
-   Select **Audio**.
-   Select your desired language.
-  Return to the previous menu.
-  Return to TV viewing.

# SOUND & LANGUAGE CONTROL

## ON-SCREEN MENUS LANGUAGE SELECTION

The menus can be shown on the screen in the selected language.



-   Select **OPTION**.
-   Select **Menu Language(Language)**.
-   Select your desired language.  
From this point on, the on-screen menus will be shown in the selected language.
-  Return to the previous menu.
-  Return to TV viewing.









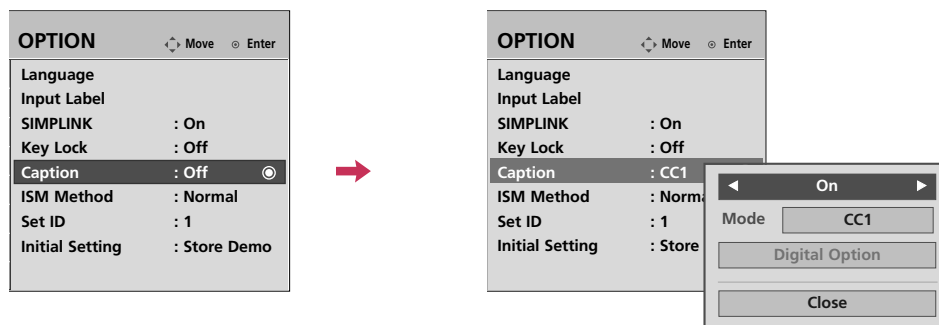

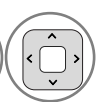
# CAPTION MODE

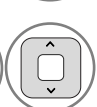
## Analog Broadcasting System Captions

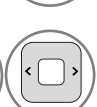
Captions are provided to help people with hearing loss watch TV. Select a caption mode for displaying captioning information if provided on a program. Analog caption displays information at any position on the screen and is usually the program's dialog. Caption/Text, if provided by the broadcaster, would be available for both digital and analog channels on the Antenna/Cable. This TV is programmed to memorize the caption/text mode which was last set when you turned the power off. This function is only available when **Caption Mode** is set **On**.

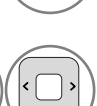

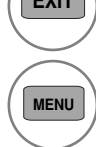
-   Select **OPTION**.
-   Select **Caption**.
-   Select **On**.
-   Select **CC1-4** or **Text1-4**.
-  Return to the previous menu.
-  Return to TV viewing.

- When selecting **Off**, Sub-menus for Analog, DTV, and Digital Option become disabled.
- **CAPTION**  
The term for the words that scroll across the bottom of the TV screen; usually the audio portion of the program provided for the hearing impaired.
- **TEXT**  
The term for the words that appear in a large black frame and almost cover the entire screen; usually messages provided by the broadcaster.

# SOUND & LANGUAGE CONTROL









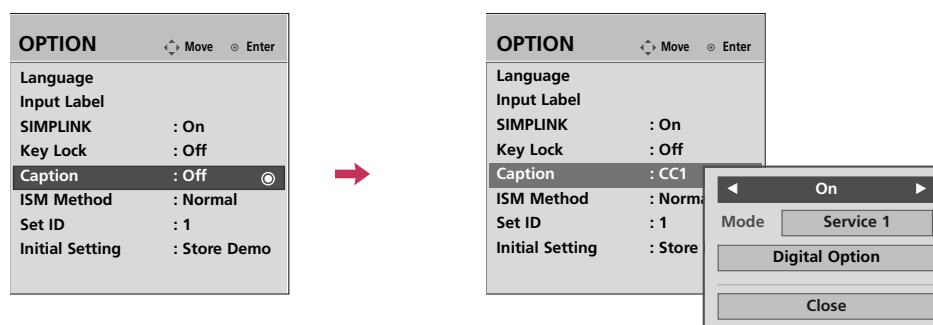

## Digital Broadcasting System Captions

Choose the language you want the DTV/CADTV Captions to appear in.

Other Languages can be chosen for digital sources only if they are included on the program.

This function is only available when **Caption Mode** is set **On**.



-   Select **OPTION**.
-   Select **Caption**.
-   Select **On**.
-   Select **CC1-4, Text1-4, or Service1 - 6**.
-  Return to the previous menu.
-  Return to TV viewing.

## Caption Option

Customize the DTV/CADTV captions that appear on your screen.  
This function is only available when Caption Mode is turned On.

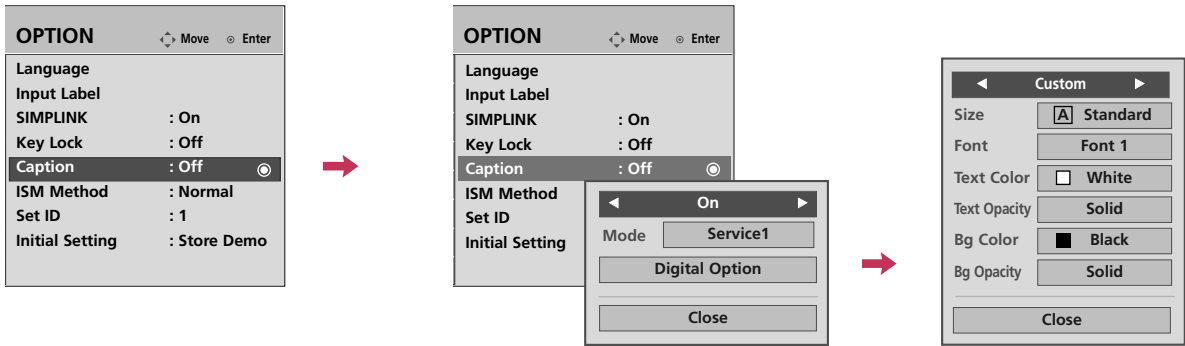



1   Select **OPTION**.

2   Select **Caption**

3   Select **On**.

4  Select **Digital Option**.

5   Select **Custom**.

6   Customize the **Style, Font**, etc., to your preference. A preview icon is provided at the bottom of the screen, use it to see the caption language.

7  Return to the previous menu.

 Return to TV viewing.

- **Size:** Set the word size.
- **Font:** Select a typeface for the text.
- **Text Color:** Choose a color for the text.
- **Text Opacity:** Specify the opacity for the text color.
- **Bg (Background) Color:** Select a background color.
- **Bg (Background) Opacity:** Select the opacity for the background color.

# TIME SETTING

## CLOCK SETTING









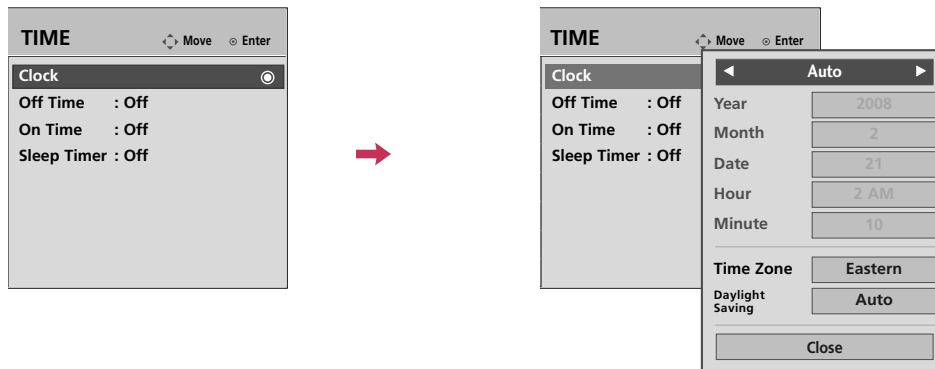

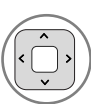
### Auto Clock Setup

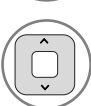
The time is set automatically from a digital channel signal.

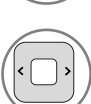
The digital channel signal includes information for the current time provided by the broadcasting station.

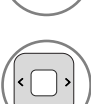
Set the clock manually if the current time is set incorrectly by the auto clock function.



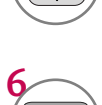





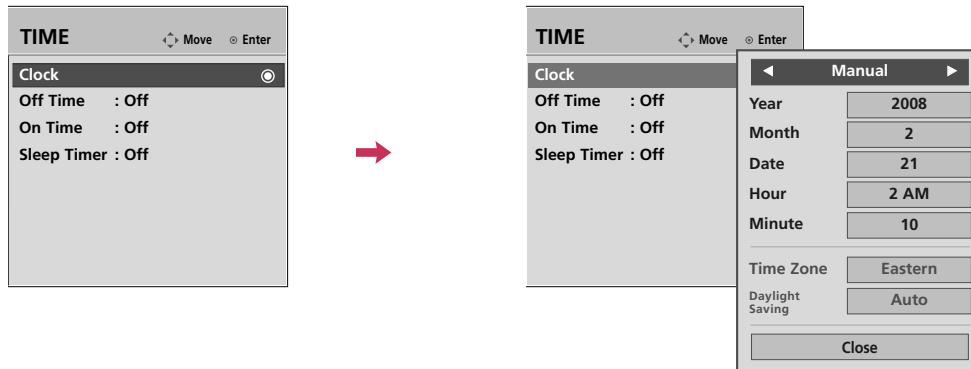



- 1   Select **TIME**.
- 2   Select **Clock**.
- 3   Select **Auto**.
- 4   Select your viewing area time zone.
  - U.S.A: **Eastern, Central, Mountain, Pacific, Alaska, or Hawaii.**
  - Canada: **Eastern, Central, Mountain, Pacific, New F.land, or Atlantic.**
- 5   Select **Auto, On, or Off** (depending on whether or not your viewing area observes Daylight Saving time).
- 6  Return to the previous menu.
-  Return to TV viewing.

## Manual Clock Setup

If the current time setting is wrong, set the clock manually.



-   Select **TIME**.
-   Select **Clock**.
-   Select **Manual**.
-  Select the Year, Month, Date, Hour, or Minutes option.
-  Set the Year, Month, Date, Hour, or Minutes option.
-  Return to the previous menu.
-  Return to TV viewing.

► If you unplug the TV once or turn the main power off, the clock function reset.

# TIME SETTING

## AUTO ON/OFF TIME SETTING



This function operates only if the current time has been set.

The **Off Time** function overrides the **On Time** function if they are both set to the same time.



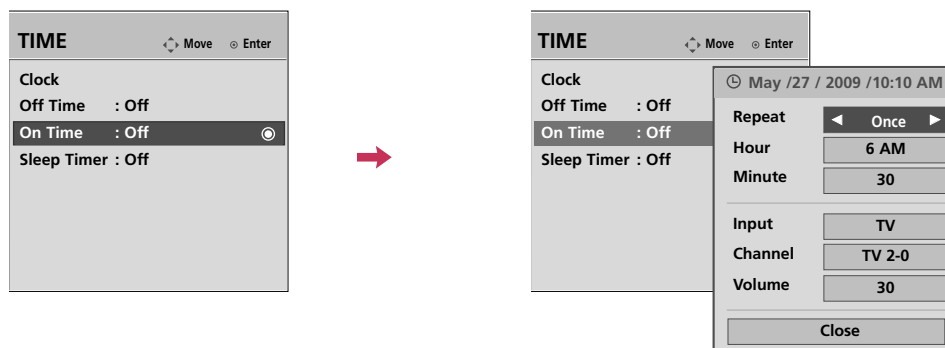



The TV must be in standby mode for the **On Time** to work.

If you do not press any button within 2 hours after the TV turns on with the **On Time** function, the TV will automatically revert to standby mode.



- 1   Select **TIME**.
- 2   Select **Off time** or **On time**.
- 3   Select **Repeat**.
- 4  Select **Off**, **Once**, **Daily**, **Mon.~Fri.**, **Mon.~Sat.**, **Weekend**, or **Sunday**.
- 5   Select and set **Hour** or **Minute**.
- 6  Return to the previous menu.
-  Return to TV viewing.

- To cancel **On/Off Time** function, select **Off**.
- Only for **On Time** function

- 1   Select **Input**.
- 2  Select the desired input source.
- 3   When Selecting **TV**: set the channel at turn-on.
- 4   Adjust to sound level at turn-on.

## SLEEP TIMER SETTING

The Sleep Time turns the TV off at the preset time.

Note that this setting is cleared when the TV is turned off.

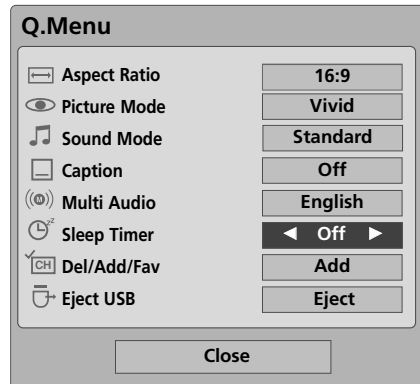

1   Select **Sleep Timer**.

2  Select **Off, 10, 20, 30, 60, 90, 120, 180, or 240** minutes.

3  Return to TV viewing.

■ You can also adjust **Sleep Timer** in the **TIME** menu.

# PARENTAL CONTROL / RATINGS

Parental Control can be used to block specific channels, ratings and other viewing sources.

The Parental Control Function (V-Chip) is used to block program viewing based on the ratings sent by the broadcasting station. The default setting is to allow all programs to be viewed. Viewing can be blocked by choosing the type of the program and the categories. It is also possible to block all program viewing for a time period. To use this function, the following must be done :

1. Set ratings and categories to be blocked.
2. Specify a password
3. Enable the lock

## V-Chip rating and categories

Rating guidelines are provided by broadcasting stations. Most television programs and television movies can be blocked by TV Rating and/or Individual Categories. Movies that have been shown at the theaters or direct-to-video movies use the Movie Rating System (MPAA) only.

## Ratings for Television programs including made-for-TV movies :

- TV-G (General audience)
- TV-PG (Parental guidance suggested)
- TV-14 (Parents strongly cautioned)
- TV-MA (Mature audience only)
- TV-Y (All children)
- TV-Y7 (Children 7 years older)

## SET PASSWORD & LOCK SYSTEM

### Setting up Your Password

Set up blocking schemes to block specific channels, ratings, and external viewing sources. A password is required to gain access to this menu.



1    Select **LOCK**.

2  Input the password.



- Enter the password as requested.
- The TV is set up with the initial password "0-0-0-0".

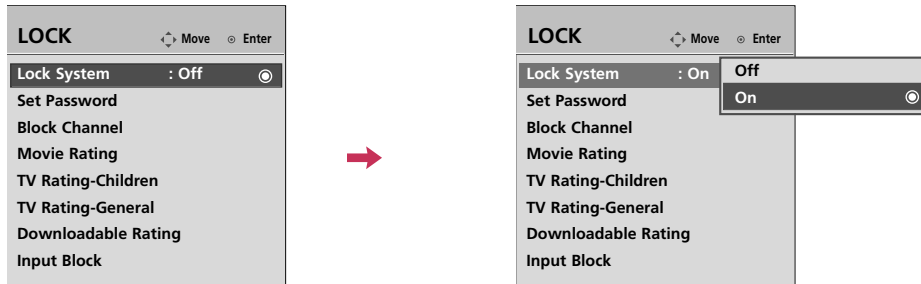

## Lock System

Enables or disables the blocking scheme you set up previously.





1    Select **LOCK**.

2  Input the password.

3  Select **Lock System**.

4   Select **On** or **Off**.

5  Return to the previous menu.

 Return to TV viewing.

- When you select **On**, the Lock System is enable.

# PARENTAL CONTROL / RATINGS

## Set Password

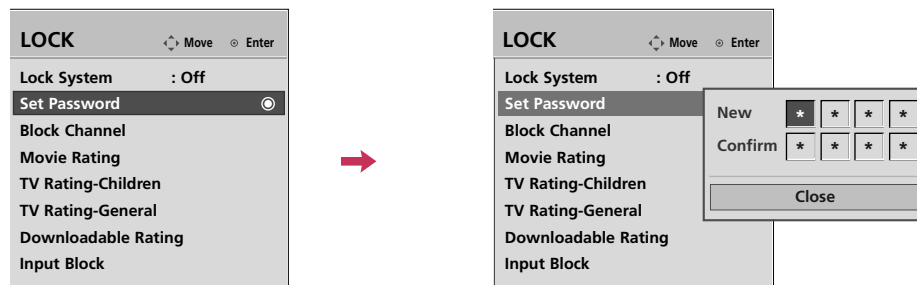

Change the password by inputting a new password twice.

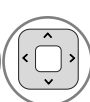



1    Select **LOCK**.

2  Input the password.

3  Select **Set password**.

4   Choose any 4 digits for your new password.  
As soon as the 4 digits are entered, re-enter the same 4 digits on the **Confirm**.

5  Return to the previous menu.

 Return to TV viewing.

# CHANNEL BLOCKING

Blocks any channels that you do not want to watch or that you do not want your children to watch.

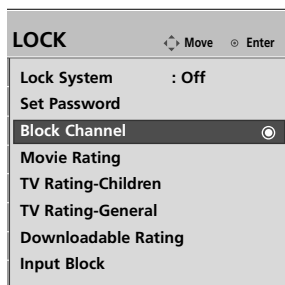

Ch.Change Move CH Move Page Previous Block/Unblock

1 Select **LOCK**.

2 Input the password.

3 Select **Block Channel**.

4 Select a channel to block or unblock.

5 Block or unblock a channel.

6 Return to the previous menu.

Return to TV viewing.



# PARENTAL CONTROL / RATINGS

## MOVIE & TV RATING

### Movie Rating (MPAA) - For USA only

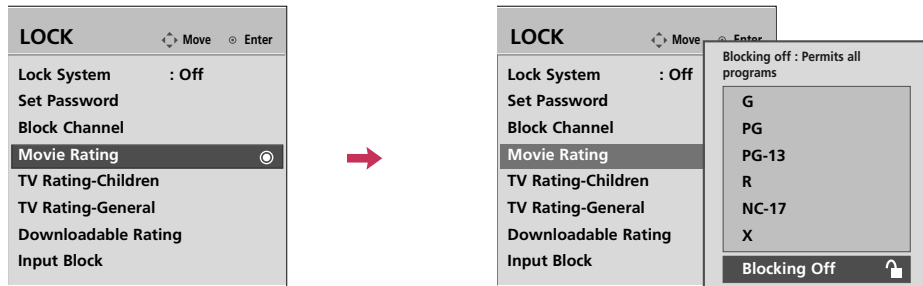
Blocks movies according to the movie ratings limits specified, so children cannot view certain movies. You can set the ratings limit by blocking out all the movies with the ratings above a specified level. Keep in mind that the movie ratings limit only applies to movies shown on TV, not TV programs, such as soap operas.





1    Select **LOCK**.

2  Input the password.

3  Select **Movie Rating**.

4   Select **G, PG, PG-13, R, NC-17, X, or Blocking Off**.

5  Return to the previous menu.

 Return to TV viewing.

- G (General audience)
- PG (Parental guidance suggested)
- PG-13 (Parents strongly cautioned)
- R (Restricted)
- NC-17 (No one 17 and under admitted)
- X (Adult only)
- Blocking Off (Permits all programs)
- ▶ If you set PG-13: G and PG movies will be available, PG-13, R, NC-17 and X will be blocked.

## TV Rating Children - For USA only

Prevents children from watching certain children's TV programs, according to the ratings limit set. The children rating does not apply to other TV programs. Unless you block certain TV programs intended for mature audiences in the TV Rating - sub menu, your children can view those programs.

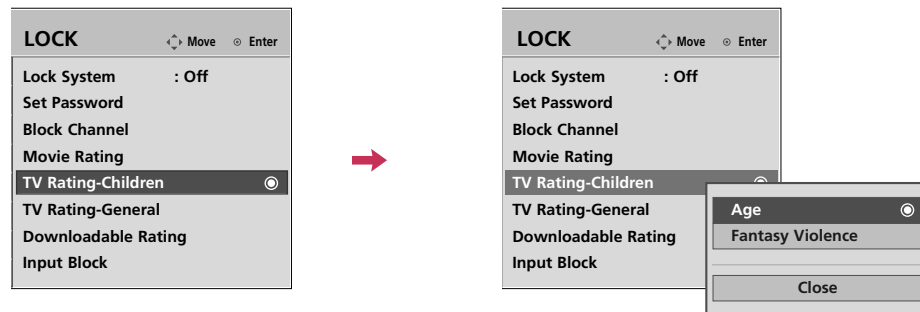

1    Select **LOCK**.

2  Input the password.

3  Select **TV Rating-Children**.

4   Select **Age** or **Fantasy Violence**.

5   Select block options.

6  Return to the previous menu.

 Return to TV viewing.

- Age (applies to TV-Y, TV-Y7)
- Fantasy Violence (applies to TV-Y7)

# PARENTAL CONTROL / RATINGS

## TV Rating General - For USA only

Based on the ratings, blocks certain TV programs that you and your family do not want to view.

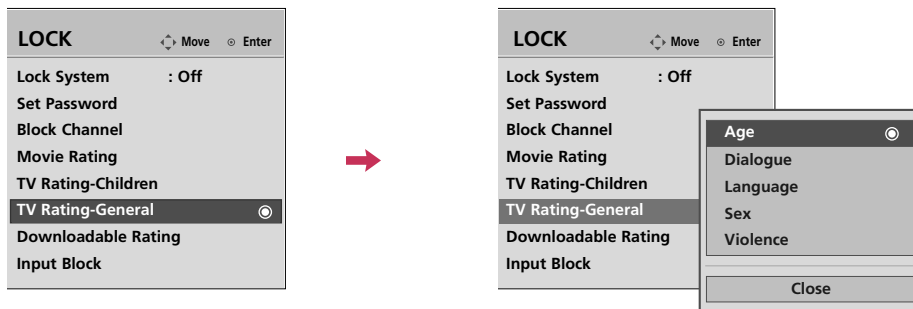

1    Select **LOCK**.

2  Input the password.

3  Select **TV Rating-General**.

4   Select **Age, Dialogue, Language, Sex or Violence**.

5   Select block options.

6  Return to the previous menu.



 Return to TV viewing.

- Age (applies to TV-G,TV-PG,TV-14,TV-MA).
- Dialogue-sexual dialogue (applies to TV-PG,TV-14).
- Language-adult language (applies to TV-PG, TV-14, TV-MA).
- Sex-sexual situations (applies to TV-PG, TV-14, TV-MA).
- Violence (applies to TV-PG, TV-14, TV-MA).

## TV Rating English - For CANADA only

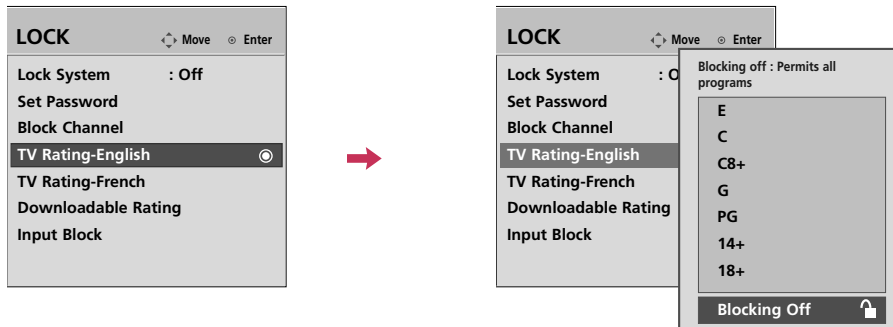

Selecting English rating system.





1    Select **LOCK**.

2  Input the password.

3  Select **TV Rating-English**.

4   Select **E, C, C8+, G, PG, 14+, 18+, or Blocking Off**.

5  Return to the previous menu.

 Return to TV viewing.



- E (Exempt)
- C (Children)
- C8+ (Children eight years and older)
- G (General programming, suitable for all audiences)
- PG (Parental Guidance)
- 14+ (Viewers 14 years and older)
- 18+ (Adult programming)
- Blocking Off (Permits all programs)

# PARENTAL CONTROL / RATINGS

## TV Rating French - *For CANADA only*

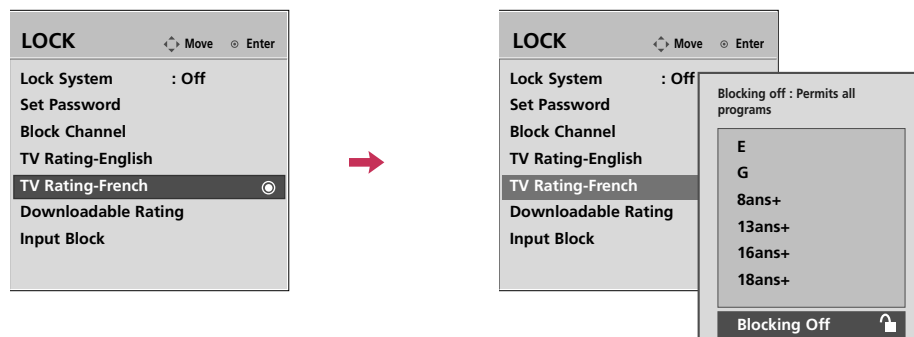
Selecting Canadian French rating system.

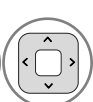



1    Select **LOCK**.

2  Input the password.

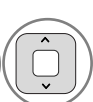
3  Select **TV Rating-French**.

4   Select **E, G, 8ans+, 13ans+, 16ans+, 18ans+, or Blocking off**.

5  Return to the previous menu.

 Return to TV viewing.

- E (Exempt)
- G (General)
- 8ans+ (General-Not convenient for little children)
- 13ans+ (Not convenient for children of 13 years and younger)
- 16ans+ (Not convenient for children of 16 years and younger)
- 18ans+ (This programs is only for adults)
- Blocking off (Permits all programs)









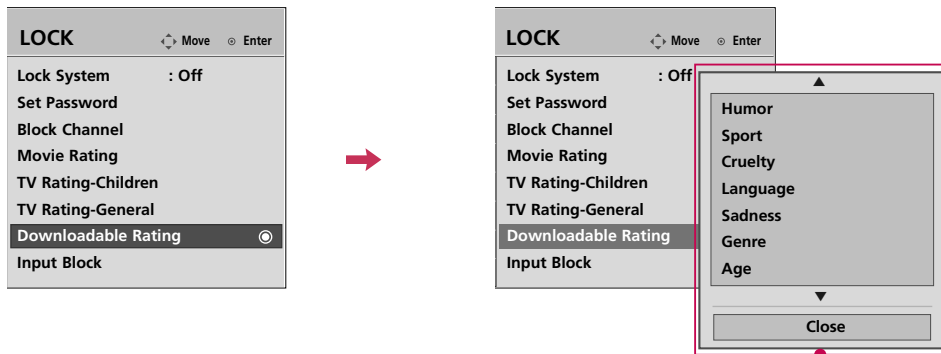



# DOWNLOADABLE RATING

This function is available only for digital channels.

This function operates only when TV has received Region5 Rating data.



- Based on rating table, your TV's OSD (On Screen Display) may differ slightly from what is shown in this manual.

-    Select **LOCK**.
-  Input the password.
-  Select **Downloadable Rating**.
-   Select desired **Downloadable Rating** option.
-   Select desired option and block it.
-  Return to the previous menu.
-  Return to TV viewing.

# PARENTAL CONTROL / RATINGS

## EXTERNAL INPUT BLOCKING



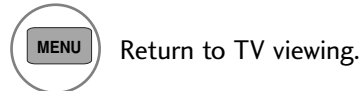
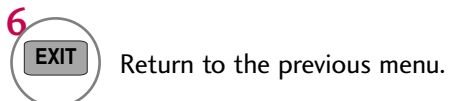
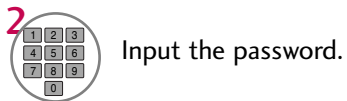
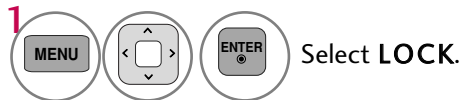
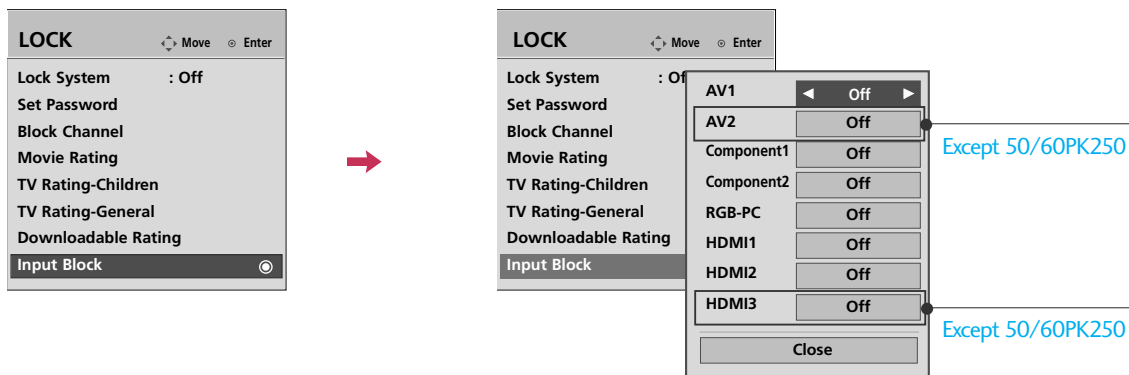



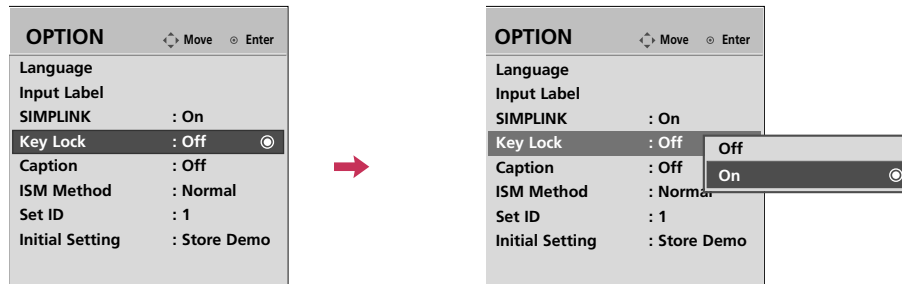

Enables you to block an input.



# KEY LOCK

The TV can be set up so that it can only be used with the remote control. This feature can be used to prevent unauthorized viewing by locking out the front panel controls. This TV is programmed to remember which option it was last set to even if you turn the TV off.



- 1   Select **OPTION**.
- 2   Select **Key Lock**.
- 3   Select **On** or **Off**.
- 4  Return to the previous menu.
-  Return to TV viewing.

- In **Key Lock 'On'**, if the TV is turned off, press the **INPUT, CH ▲, ▼** button on the TV or **POWER, INPUT, CH ^, v** or **NUMBER** buttons on the remote control.
- With the **Key Lock On**, the display **'⚠ Key Lock'** appears on the screen if any button (Except **⏻/⏻** (power) button) on the front panel is pressed while viewing the TV.

# APPENDIX

## TROUBLESHOOTING

The operation does not work normally.	
The remote control doesn't work	<ul style="list-style-type: none"> <li>Check to see if there is any object between the product and the remote control causing obstruction. Ensure you are pointing the remote control directly at the TV.</li> <li>Ensure that the batteries are installed with correct polarity (+ to +, - to -).</li> <li>Ensure that the correct remote operating mode is set: TV, VCR etc.</li> <li>Install new batteries.</li> </ul> <p style="text-align: right;">*This feature is not available for all models.</p>
Power is suddenly turned off	<ul style="list-style-type: none"> <li>Is the sleep timer set?</li> <li>Check the power control settings. Power interrupted.</li> <li>TV will be automatically turned off, in case of no signal for 15 minutes.</li> </ul>

The video function does not work.	
No picture & No sound	<ul style="list-style-type: none"> <li>Check whether the product is turned on.</li> <li>Try another channel. The problem may be with the broadcast.</li> <li>Is the power cord inserted into wall power outlet?</li> <li>Check your antenna direction and/or location.</li> <li>Test the wall power outlet, plug another product's power cord into the outlet where the product's power cord was plugged in.</li> </ul>
Picture appears slowly after switching on	<ul style="list-style-type: none"> <li>This is normal, the image is muted during the product startup process. Please contact your service center, if the picture has not appeared after five minutes.</li> </ul>
No or poor color or poor picture	<ul style="list-style-type: none"> <li>Adjust Color in menu option.</li> <li>Keep a sufficient distance between the product and the VCR.</li> <li>Try another channel. The problem may be with the broadcast.</li> <li>Are the video cables installed properly?</li> <li>Activate any function to restore the brightness of the picture.</li> </ul>
Horizontal/vertical bars or picture shaking	<ul style="list-style-type: none"> <li>Check for local interference such as an electrical appliance or power tool.</li> </ul>
Poor reception on some channels	<ul style="list-style-type: none"> <li>Station or cable product experiencing problems, tune to another station.</li> <li>Station signal is weak, reorient antenna to receive weaker station.</li> <li>Check for sources of possible interference.</li> </ul>
Lines or streaks in pictures	<ul style="list-style-type: none"> <li>Check antenna (Change the direction of the antenna).</li> </ul>
No picture when connecting HDMI	<ul style="list-style-type: none"> <li>Check HDMI cable over version 1.3. The HDMI cables don't support HDMI version 1.3, it cause flickers or no screen display. In this case use the latest cables that support HDMI version 1.3.</li> </ul>

**The audio function does not work.**

Picture OK & No sound	<ul style="list-style-type: none"> <li>■ Press the VOL or VOLUME button.</li> <li>■ Sound muted? Press MUTE button.</li> <li>■ Try another channel. The problem may be with the broadcast.</li> <li>■ Are the audio cables installed properly?</li> </ul>
No output from one of the speakers	<ul style="list-style-type: none"> <li>■ Adjust Balance in menu option.</li> </ul>
Unusual sound from inside the product	<ul style="list-style-type: none"> <li>■ A change in ambient humidity or temperature may result in an unusual noise when the product is turned on or off and does not indicate a fault with the product.</li> </ul>
No sound when connecting HDMI/USB	<ul style="list-style-type: none"> <li>■ Check HDMI cable over version 1.3.</li> <li>■ Check USB cable over version 2.0.</li> <li>■ Use normal MP3 file.</li> </ul> <p style="text-align: right; margin-top: 10px;">*This feature is not available for all models.</p>

**There is a problem in PC mode. (Only PC mode applied)**

The signal is out of range	<ul style="list-style-type: none"> <li>■ Adjust resolution, horizontal frequency, or vertical frequency.</li> <li>■ Check the input source.</li> </ul>
Vertical bar or stripe on background & Horizontal Noise & Incorrect position	<ul style="list-style-type: none"> <li>■ Work the Auto configure or adjust clock, phase, or H/V position. (Option)</li> </ul>
Screen color is unstable or single color	<ul style="list-style-type: none"> <li>■ Check the signal cable.</li> <li>■ Reinstall the PC video card.</li> </ul>

## MAINTENANCE

Early malfunctions can be prevented. Careful and regular cleaning can extend the amount of time you can enjoy your new TV.

**Caution:** Be sure to turn the power off and unplug the power cord before you begin any cleaning.

### Cleaning the Screen

- 1 Here's a great way to keep the dust off your screen for a while. Wet a soft cloth in a mixture of lukewarm water and a little fabric softener or dish washing detergent. Wring the cloth until it's almost dry, and then use it to wipe the screen.
- 2 Make sure the excess water is off the screen, and then let it air-dry before you turn on your TV.

### Cleaning the Cabinet

- To remove dirt or dust, wipe the cabinet with a soft, dry, lint-free cloth.
- Please be sure not to use a wet cloth.

### Extended Absence

#### CAUTION

- ▶ If you expect to leave your TV dormant for a long time (such as a vacation), it's a good idea to unplug the power cord to protect against possible damage from lightning or power surges.

# PRODUCT SPECIFICATIONS

MODEL		50PK550 (50PK550-UA)	60PK550 (60PK550-UA)	42PJ350 (42PJ350-UA)
Dimensions (Width x Height x Depth)	With stand	46.1 x 30.9 x 12.1 inches 1171.4 x 786.2 x 309.7 mm	54.8 x 36 x 14.4 inches 1392 x 915 x 367 mm	38.8 x 27.1 x 10.2 inches 988 x 688.5 x 260 mm
	Without stand	46.1 x 28.5 x 2.1 inches 1171.4 x 724.4 x 55.3 mm	54.8 x 33.5 x 2.1 inches 1392 x 852 x 55.3 mm	38.8 x 24.3 x 2.1 inches 988 x 617.8 x 55.3 mm
Weight	With stand	676 lbs / 30.7 kg	109.1 lbs / 49.5 kg	47.6 lbs / 21.6 kg
	Without stand	62.3 lbs / 28.3 kg	99.2 lbs / 45 kg	44 lbs / 20 kg
MODELS		50PK250 (50PK250-UA)	60PK250 (60PK250-UA)	
Dimensions (Width x Height x Depth)	With stand	46.1 x 30.7 x 12.1 inches 1171.5 x 782 x 309.7 mm	40.9 x 28.5 x 12.1 inches 1392 x 910 x 367 mm	
	Without stand	46.1 x 28.3 x 2.1 inches 1171.5 x 721 x 55.3 mm	40.9 x 26.3 x 3.0 inches 1392 x 843 x 55.3 mm	
Weight	With stand	676 lbs / 30.7kg	109.1 lbs / 49.5 kg	
	Without stand	62.3 lbs / 28.3 kg	99.2 lbs / 45 kg	
Power requirement Television System Program Coverage External Antenna Impedance		AC100-240V ~ 50/60Hz NTSC-M, ATSC, 64 & 256 QAM VHF 2-13, UHF 14-69, CATV 1-135, DTV 2-69, CADTV 1-135 75 ohm		
Environment condition	Operating Temperature Operating Humidity	32 ~ 104°F (0 ~ 40°C) Less than 80%		
	Storage Temperature Storage Humidity	-4 ~ 140°F (-20 ~ 60°C) Less than 85%		

- The specifications shown above may be changed without prior notice for quality improvement.

# APPENDIX



APPENDIX



# IR CODES

## 1. How to Connect

- Connect your wired remote control to the Remote Control port on the TV.

## 2. Remote Control IR Codes

### ■ Output waveform

Single pulse, modulated with 37.917KHz signal at 455KHz

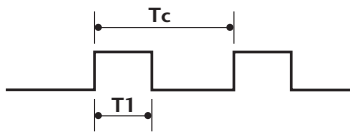

Carrier frequency  
 $FCAR = 1/T_C = f_{OSC}/12$   
 Duty ratio =  $T_1/T_C = 1/3$

### ■ Configuration of frame

1st frame

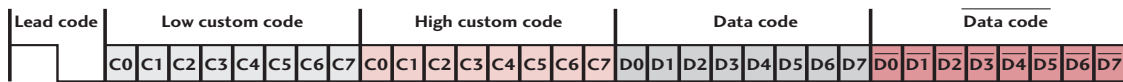

Repeat frame

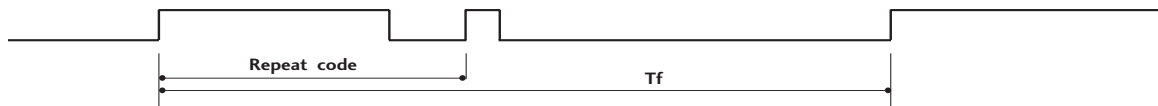

### ■ Lead code

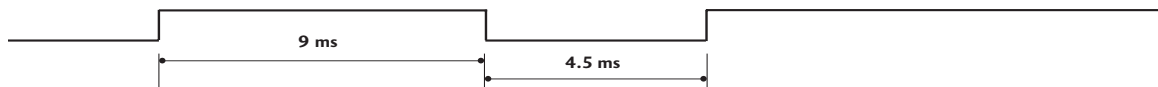

### ■ Repeat code

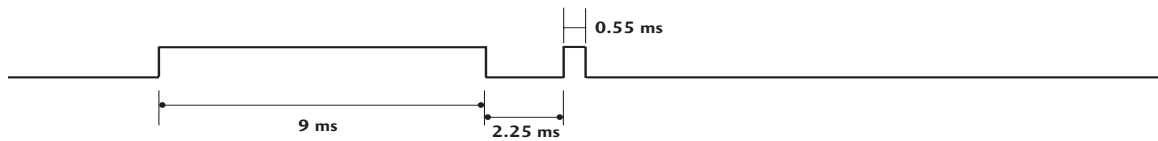

### ■ Bit description

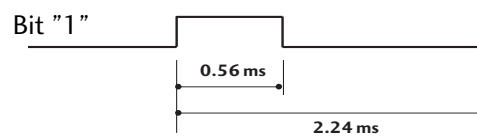
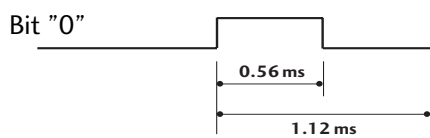

### ■ Frame interval: Tf

The waveform is transmitted as long as a key is depressed.



# APPENDIX

Code (Hexa)	Function	Note	Code (Hexa)	Function	Note
08	POWER	Remote control Button (Power On/Off)	D6	TV	Discrete IR Code (TV Input Selection)
45	Q.MENU	Remote control Button			
43	MENU	Remote control Button	C4	POWER ON	Discrete IR Code (Only Power On)
0B	INPUT	Remote control Button			
10-19	Number Key 0-9	Remote control Button	C5	POWER OFF	Discrete IR Code (Only Power Off)
4C	- Dash(List)	Remote control Button			
1A	FLASHBK	Remote control Button	5A	AV1	Discrete IR Code (AV1 Input Selection)
09	MUTE	Remote control Button			
02	VOL +	Remote control Button	D0	AV2	Discrete IR Code (AV2 Input Selection)
03	VOL -	Remote control Button			
00	CH ^	Remote control Button	BF	COMPONENT1	Discrete IR Code (Component1 Input Selection)
01	CH v	Remote control Button			
1E	FAV	Remote control Button	D4	COMPONENT2	Discrete IR Code (Component2 Input Selection)
40	^	Remote control Button			
41	v	Remote control Button	D5	RGB-PC	Discrete IR Code (RGB-PC Input Selection)
07	<	Remote control Button			
06	>	Remote control Button	CE	HDMI1	Discrete IR Code (HDMI1 Input Selection)
44	ENTER	Remote control Button			
28	RETURN	Remote control Button	CC	HDMI2	Discrete IR Code (HDMI2 Input Selection)
7E	SIMPLINK	Remote control Button			
30	AV MODE	Remote control Button	E9	HDMI3	Discrete IR Code (HDMI3 Input Selection)
79	RATIO	Remote control Button			
BA	Pause    (FREEZE)	Remote control Button	76	Ratio 4:3	Discrete IR Code (Only 4:3 Mode)
95	ENERGY	Remote control Button			
AA	Info	Remote control Button	77	Ratio 16:9	Discrete IR Code (Only 16:9 Mode)
72	Red	Remote control Button			
71	Green	Remote control Button	AF	Ratio Zoom	Discrete IR Code (Only Zoom1 Mode)
63	Yellow	Remote control Button			
61	Blue	Remote control Button			
8E	FF ►►	Remote control Button			
8F	Rew ◀◀	Remote control Button			
0F	TV	Remote control Button			
43	MENU	Remote control Button			
5B	EXIT	Remote control Button			
B1	Stop ■	Remote control Button			
B0	Play ►	Remote control Button			

Except 50/60PK250

# EXTERNAL CONTROL THROUGH RS-232C

The RS-232C port allows you connect the RS-232C input jack to an external control device (such as a computer or an A/V control system) to control the TV's functions externally.

- Note: RS-232C on this unit is intended to be used with third party RS-232C control hardware and software. The instructions below are provided to help with programming software or to test functionality using telenet software.

## RS-232C Setup

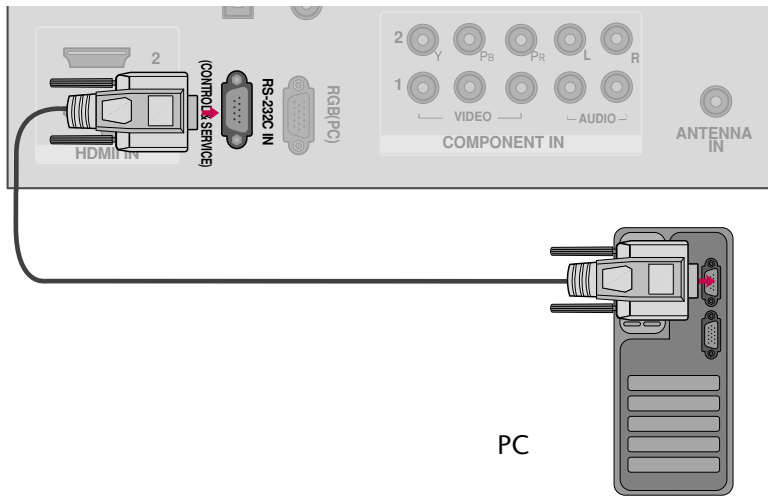

### Type of Connector; D-Sub 9-Pin Male

No.	Pin Name
1	No connection
2	RXD (Receive data)
3	TXD (Transmit data)
4	DTR (DTE side ready)
5	GND
6	DSR (DCE side ready)
7	RTS (Ready to send)
8	CTS (Clear to send)
9	No Connection

### Communication Parameters

- Baud rate : 9600 bps (UART)
- Data length : 8 bits
- Parity : None
- Stop bit : 1 bit
- Communication code : ASCII code
- Use a crossed (reverse) cable.

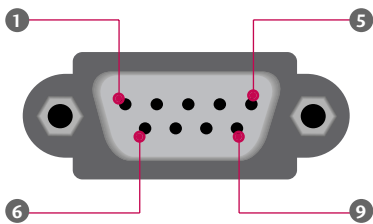

# APPENDIX

## RS-232C Configurations

Either cable below can be used.

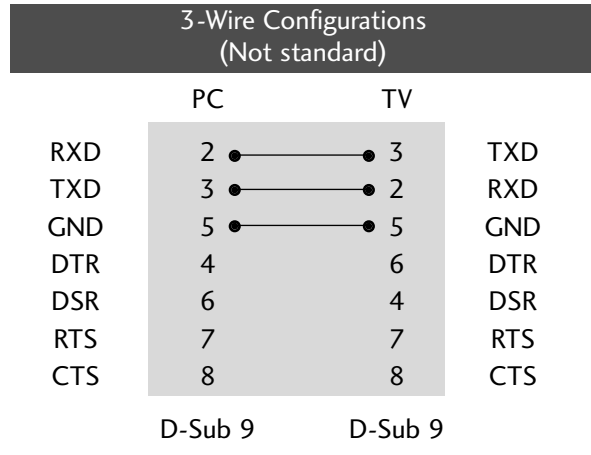
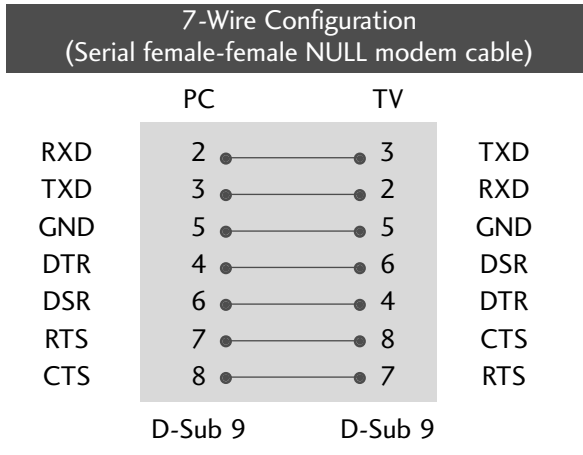

## Set ID

Use this function to specify a TV ID number.  
Refer to 'Real Data Mapping'.

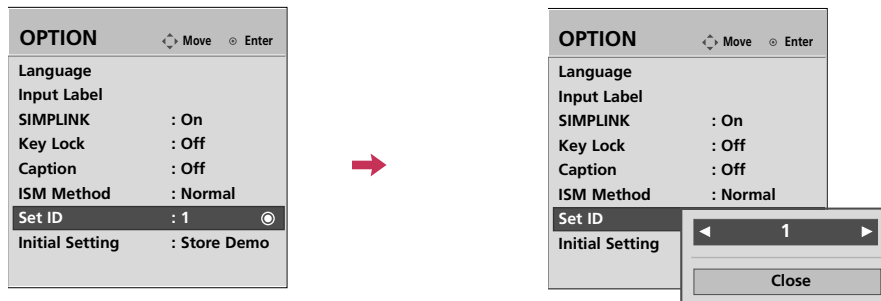

- 1 Select **OPTION**.
- 2 Select **Set ID**.
- 3 Choose the desired TV ID number.  
The adjustment range of Set ID is 1~99.
- 4 Return to the previous menu.
- Return to TV viewing.

\*Real data mapping

0 : Step 0

⋮

A : Step 10 (SET ID 10)

⋮

F : Step 15 (SET ID 15)

10 : Step 16 (SET ID 16)

⋮

63 : Step 99 (SET ID 99)

64 : Step 100

## Command Reference List

	COMMAND1	COMMAND2	DATA (Hexadecimal)		COMMAND1	COMMAND2	DATA (Hexadecimal)
01. Power	k	a	00 ~ 01	13. Remote Control	k	m	00 ~ 01
02. Input Select	x	b	(▶ p.118)	Lock Mode			
03. Aspect Ratio	k	c	(▶ p.118)	14. Treble	k	r	00 ~ 64
04. Screen Mute	k	d	00 ~ 01	15. Bass	k	s	00 ~ 64
05. Volume Mute	k	e	00 ~ 01	16. Balance	k	t	00 ~ 64
06. Volume Control	k	f	00 ~ 64	17. Color Temperature	k	u	00 ~ 02
07. Contrast	k	g	00 ~ 64	18. ISM Method	j	p	(▶ p.119)
08. Brightness	k	h	00 ~ 64	19. Power Saving	j	q	00 ~ 01
09. Color	k	i	00 ~ 64	20. Auto Configuration	j	u	(▶ p.119)
10. Tint	k	j	00 ~ 64	22. Channel Add/Del	m	b	00 ~ 01
11. Sharpness	k	k	00 ~ 64	23. Key	m	c	(▶ p.120)
12. OSD Select	k	l	00 ~ 01				

	COMMAND1	COMMAND2	DATA00 (Hexadecimal)	DATA01 (Hexadecimal)	DATA02 (Hexadecimal)	DATA03 (Hexadecimal)	DATA04 (Hexadecimal)	DATA05 (Hexadecimal)
21. Channel Tuning	m	a	physical program high	major program low	major low	minor high	minor low	attribute

## Transmission / Receiving Protocol

### Transmission

**[Command1][Command2][ ][Set ID][ ][Data][Cr]**

[Command 1] : First command to control the set.(j, k, m or x)

[Command 2] : Second command to control the set.

[Set ID] : You can adjust the set ID to choose desired TV ID number in Setup menu. Adjustment range is 1~99. When selecting Set ID '0', every connected the TV is controlled. Set ID is indicated as decimal (1~99) on menu and as Hexa decimal (0x0~0x63) on transmission /receiving protocol.

[DATA] : To transmit the command data.

Transmit the 'FF' data to read status of command.

[Cr] : Carriage Return

ASCII code '0x0D'

[ ] : ASCII code 'space (0x20)'

\* In this model, TV will not send the status during the standby mode.

### OK Acknowledgement

**[Command2][ ][Set ID][ ][OK][Data][x]**

The TV transmits ACK (acknowledgement) based on this format when receiving normal data. At this time, if the data is data read mode, it indicates present status data. If the data is data write mode, it returns the data of the PC computer.

\* In this model, TV will not send the status during the standby mode.

\* Data Format

[Command 2] : Use as command.

[Set ID] : Use the small character, if set ID is 10, it will send the '0', 'a'.

[DATA] : Use the small character, if data is 0 x ab, it will send the 'a', 'b'.

[OK] : Use the large character.

### Error Acknowledgement

**[Command2][ ][Set ID][ ][NG][Data][x]**

The TV transmits ACK (acknowledgement) based on this format when receiving abnormal data from non-viable functions or communication errors.

Data1: Illegal Code

Data2: Not supported function

Data3: Wait more time

\* In this model, TV will not send the status during the standby mode.

\* Data Format

[Command 2] : Use as command.

[Set ID] : Use the small character, if set ID is 10, it will send the '0', 'a'.

[DATA] : Use the small character, if data is 0 x ab, it will send the 'a', 'b'.

[NG] : Use the large character

## 01. Power (Command: k a)

To control Power On/Off of the TV.

**Transmission** [k][a][ ][Set ID][ ][Data][Cr]

Data 00: Power Off      Data 01: Power On

**Acknowledgement** [a][ ][Set ID][ ][OK/NG][Data][x]

\* In a like manner, if other functions transmit 'FF' data based on this format, Acknowledgement data feedback presents status about each function.

\* Note: In this model, TV will send the Acknowledge after power on processing completion.

There might be a time delay between command and acknowledge.

## 02. Input Select (Command: x b)

To select input source for TV.

**Transmission** [x][b][ ][Set ID][ ][Data][Cr]

Data 00: DTV (Antenna)      Data 01: DTV (Cable)  
 Data 10: Analog (Antenna)      Data 11: Analog (Cable)  
 Data 20: AV1      Data 21: AV2  
 Data 40: Component 1      Data 41: Component 2  
 Data 60: RGB-PC      Data 90: HDMI1  
 Data 91: HDMI2      Data 92: HDMI3  
 Data 93: HDMI4(Only 50PK250)

**Acknowledgement** [b][ ][Set ID][ ][OK/NG][Data][x]

## 03. Aspect Ratio (Command: k c)

To adjust the screen format.

**Transmission** [k][c][ ][Set ID][ ][Data][Cr]

Data 01: 4:3      09: Just scan  
 02: 16:9      10: Cinema Zoom (1)  
 04: Zoom  
 06: Set by program      1f: Cinema Zoom (16)

**Acknowledgement** [c][ ][Set ID][ ][OK/NG][Data][x]

## 04. Screen Mute (Command: k d)

To select screen mute on/off.

**Transmission** [k][d][ ][Set ID][ ][Data][Cr]

Data 00: Screen mute off (Picture on), Video-Out Mute Off  
 Data 01: Screen mute on (Picture off)  
 Data 10: Video-Out Mute On

**Acknowledgement** [d][ ][Set ID][ ][OK/NG][Data][x]

\* In case of Video-Out mute on only, TV will display On Screen Display(OSD). But, In case of Screen Mute On, TV will not display OSD.

## 05. Volume Mute (Command: k e)

To control volume mute on/off.

You can also adjust mute using the MUTE button on remote control.

**Transmission** [k][e][ ][Set ID][ ][Data][Cr]

Data 00: Volume mute on (Volume off)

Data 01: Volume mute off (Volume on)

**Acknowledgement** [e][ ][Set ID][ ][OK/NG][Data][x]

## 06. Volume Control (Command: k f)

To adjust volume.

You can also adjust volume with the volume buttons on remote control.

**Transmission** [k][f][ ][Set ID][ ][Data][Cr]

Data Min: 00 ~ Max: 64 (\*transmit by Hexadecimal code)

\*Refer to 'Real data mapping'. ► p.116.

**Acknowledgement** [f][ ][Set ID][ ][OK/NG][Data][x]

## 07. Contrast (Command: k g)

To adjust screen contrast.

You can also adjust contrast in the PICTURE menu.

**Transmission** [k][g][ ][Set ID][ ][Data][Cr]

Data Min: 00 ~ Max: 64 (\*transmit by Hexadecimal code)

\*Refer to 'Real data mapping'. ► p.116.

**Acknowledgement** [g][ ][Set ID][ ][OK/NG][Data][x]

## 08. Brightness (Command: k h)

To adjust screen brightness.

You can also adjust brightness in the PICTURE menu.

**Transmission** [k][h][ ][Set ID][ ][Data][Cr]

Data Min: 00 ~ Max: 64 (\*transmit by Hexadecimal code)

\*Refer to 'Real data mapping'. ► p.116.

**Acknowledgement** [h][ ][Set ID][ ][OK/NG][Data][x]

## 09. Color (Command: k i)

To adjust screen color.

You can also adjust color in the PICTURE menu.

**Transmission** [k][i][ ][Set ID][ ][Data][Cr]

Data Min: 00 ~ Max: 64 (\*transmit by Hexadecimal code)

\*Refer to 'Real data mapping'. ► p.116.

**Acknowledgement** [i][ ][Set ID][ ][OK/NG][Data][x]

## 10. Tint (Command: k j)

To adjust screen tint.

You can also adjust tint in the PICTURE menu.

**Transmission** [k][j][ ][Set ID][ ][Data][Cr]

Data Red: 00 ~ Green: 64 (\*transmit by Hexadecimal code)

\*Refer to 'Real data mapping'. ► p.116.

**Acknowledgement** [j][ ][Set ID][ ][OK/NG][Data][x]

## 11. Sharpness (Command: k k)

To adjust screen sharpness.

You can also adjust sharpness in the PICTURE menu.

**Transmission** [k][k][ ][Set ID][ ][Data][Cr]

Data Min: 00 ~ Max: 64 (\*transmit by Hexadecimal code)

\*Refer to 'Real data mapping'. ► p.116.

**Acknowledgement** [k][ ][Set ID][ ][OK/NG][Data][x]

**12. OSD Select (Command: k l)**

To select OSD (On Screen Display) on/off.

*Transmission* [k][l][ ][Set ID][ ][Data][Cr]

Data 00: OSD off      Data 01: OSD on

*Acknowledgement* [l][ ][Set ID][ ][OK/NG][Data][x]

**13. Remote Control Lock Mode (Command: k m)**

To lock the remote control and the front panel controls on the TV.

*Transmission* [k][m][ ][Set ID][ ][Data][Cr]

Data 00: Lock off      Data 01: Lock on

*Acknowledgement* [m][ ][Set ID][ ][OK/NG][Data][x]

If you're not using the remote control and front panel controls on the TV, use this mode. When main power is on/off, remote control lock is released.

**14. Treble (Command: k r)**

To adjust treble.

You can also adjust treble in the AUDIO menu.

*Transmission* [k][r][ ][Set ID][ ][Data][Cr]

Data Min: 00 ~ Max: 64 (\*transmit by Hexadecimal code)

\*Refer to 'Real data mapping'. ► p.116.

*Acknowledgement* [r][ ][Set ID][ ][OK/NG][Data][x]

**15. Bass (Command: k s)**

To adjust bass.

You can also adjust bass in the AUDIO menu.

*Transmission* [k][s][ ][Set ID][ ][Data][Cr]

Data Min: 00 ~ Max: 64 (\*transmit by Hexadecimal code)

\*Refer to 'Real data mapping'. ► p.116.

*Acknowledgement* [s][ ][Set ID][ ][OK/NG][Data][x]

**16. Balance (Command: k t)**

To adjust balance.

You can also adjust balance in the AUDIO menu.

*Transmission* [k][t][ ][Set ID][ ][Data][Cr]

Data Min: 00 ~ Max: 64 (\*transmit by Hexadecimal code)

\*Refer to 'Real data mapping'. ► p.116.

*Acknowledgement* [t][ ][Set ID][ ][OK/NG][Data][x]

**17. Color Temperature (Command: k u)**

To adjust color temperature.

You can also adjust color temperature in the PICTURE menu.

*Transmission* [k][u][ ][Set ID][ ][Data][Cr]

Data 00: Medium    01: Cool    02: Warm

*Acknowledgement* [u][ ][Set ID][ ][OK/NG][Data][x]

**18. ISM Method (Command: j p)**

To avoid having a fixed image remain on screen.

*Transmission* [j][p][ ][Set ID][ ][Data][Cr]

Data 02: Orbiter      04: White Wash

08: Normal      20: Color Wash

*Acknowledgement* [p][ ][Set ID][ ][OK/NG][Data][x]

**19. Power saving (Command: j q)**

To control the low power function on/off.

*Transmission* [j][q][ ][Set ID][ ][Data][Cr]

Data 00: Energy Saving off

01: Energy Saving: Minimum

02: Energy Saving: Medium

03: Energy Saving: Maximum

10: Intelligent Sensor: Low

11: Intelligent Sensor: Middle

12: Intelligent Sensor: High

*Acknowledgement* [q][ ][Set ID][ ][OK/NG][Data][x]

**20. Auto Configuration (Command: j u)**

To adjust picture position and minimize image shaking automatically. Auto configuration only works in RGB-PC mode.

*Transmission* [j][u][ ][Set ID][ ][Data][Cr]

Data 1: To set

*Acknowledgement* [u][ ][Set ID][ ][OK/NG][Data][x]

**21. Channel Tuning (Command: m a)**

To tune channel to following physical/major/minor number.

*Transmission* [m][a][ ][Set ID][ ][Data00][ ][Data01][ ][Data02][ ][Data03][ ][Data04][ ][Data05][Cr]

Digital channels have a Physical, Major, and Minor channel number. The Physical number is the actual digital channel number, the Major is the number that the channel should be mapped to, and the Minor is the sub-channel. Since the ATSC tuner automatically maps the channel to the Major number, the Physical number is not required when sending a command.

Data 00: Physical Channel Number

NTSC air: 02~45, NTSC cable: 01, 0E~7D

ATSC air: 01~45, ATSC cable: 01~87

Data 01 & 02: Major Channel Number

Data 01: High byte      Data 02: Low byte

Two bytes are available for the Major and Minor, normally only the second byte is used.

Data 03 & 04: Minor Channel Number

Not needed for NTSC.

Data 05:	7 Main/Sub Picture	6 Two/One Part Channel	5 Using Physical Channel	4 Reserved	3	2	1	0	Step
0 Main	0 Two	0 Use	x	0	0	0	0	0	NTSC Air
1 Sub	1 One	1 No Use	x	0	0	0	1	1	NTSC Cable
			x	0	0	1	0	0	ATSC Air
			x	0	0	1	1	1	ATSC Cable_std
			x	0	1	0	0	0	ATSC Cable_hrc
			x	0	1	0	1	1	ATSC Cable_irc
			x	0	1	1	0	0	ATSC cable_auto
			x	0	1	1	1	1	Reserved
			x	x	x	x	x	x	...
			x	1	1	1	1	1	Reserved

The table above lists the binary code which must be converted to Hexadecimal before sending. For example: The binary code to tune the sub source to an NTSC cable channel is "1000 0001", which translates to "81" in Hex.

- \* 7th bit : For which source do you want to change the channel.
- \* 6th bit: Use a two part or one part channel. Most cases just use 0 since it's ignored when using NTSC.
- \* 5th bit: Use 0 with NTSC since it can only use the physical channel number. Normally use 1 for ATSC since most times it doesn't matter what the physical number is.
- \* 4th bit: Set to 0.
- \* 3-0 bits: Choose signal type.

\* Tune Command Examples:

1. Tune to the analog (NTSC) cable channel 35.

Data 00 = Physical of 35 = 23  
 Data 01 & 02 = No Major = 00 00  
 Data 03 & 04 = No Minor = 00 00  
 Data 05 = 0000 0001 in binary = 01  
 Total = ma 00 23 00 00 00 00 01

2. Tune to the digital (ATSC) local channel 30-3.

Data 00 = Don't know Physical = 00  
 Data 01 & 02 = Major is 30 = 00 1E  
 Data 03 & 04 = Minor is 3 = 00 03  
 Data 05 = 0010 0010 in binary = 22  
 Total = ma 00 00 00 1E 00 03 22

```
Acknowledgement[a][ ][Set ID][ ][OK][Data00][Data01][Data02][Data03][Data04][x][a][ ][Set ID][ ][NG][Data00][x]
```

## 22. Channel Add/Del (Command: m b)

To add and delete the channels.

```
Transmission [m][b][ ][Set ID][ ][Data][Cr]
```

Data 00: Channel Delete    Data 01: Channel Add

```
Acknowledgement [b][ ][Set ID][ ][OK/NG][Data][x]
```

## 23. Key (Command: m c)

To send IR remote key code.

```
Transmission [m][c][ ][Set ID][ ][Data][Cr]
```

► p.114.

```
Acknowledgement [c][ ][Set ID][ ][OK/NG][Data][x]
```





**LG Electronics Inc.**