



OWNER'S MANUAL LED LCD TV / PLASMA TV

Please read this manual carefully before operating your set and retain it for future reference.

LED LCD TV MODELS

47LX9500
55LX9500
47LEX8
55LEX8
60LEX9
72LEX9

PLASMA TV MODELS

50PK950
60PK950
50PX950
60PX950

The model and serial number of the TV is located on the back and/or one side of the TV. Record it below should you ever need service.

MODEL _____

SERIAL _____

P/NO : SAC34134205 (1006-REV03)

www.lg.com

WARNING / CAUTION



TO REDUCE THE RISK OF ELECTRIC SHOCK DO NOT REMOVE COVER (OR BACK). NO USER SERVICEABLE PARTS INSIDE. REFER TO QUALIFIED SERVICE PERSONNEL.

 The lightning flash with arrowhead symbol, within an equilateral triangle, is intended to alert the user to the presence of uninsulated "dangerous voltage" within the product's enclosure that may be of sufficient magnitude to constitute a risk of electric shock to persons.

 The exclamation point within an equilateral triangle is intended to alert the user to the presence of important operating and maintenance (servicing) instructions in the literature accompanying the appliance.

WARNING/CAUTION

TO REDUCE THE RISK OF FIRE AND ELECTRIC SHOCK, DO NOT EXPOSE THIS PRODUCT TO RAIN OR MOISTURE.

NOTE TO CABLE/TV INSTALLER

This reminder is provided to call the CATV system installer's attention to Article 820-40 of the National Electric Code (U.S.A.). The code provides guidelines for proper grounding and, in particular, specifies that the cable ground shall be connected to the grounding system of the building, as close to the point of the cable entry as practical.

WARNING / CAUTION

To prevent fire or shock hazards, do not expose this product to rain or moisture.

FCC Notice

Class B digital device

This equipment has been tested and found to comply with the limits for a Class B digital device, pursuant to Part 15 of the FCC Rules. These limits are designed to provide reasonable protection against harmful interference in a residential installation. This equipment generates, uses and can radiate radio frequency energy and, if not installed and used in accordance with the instructions, may cause harmful interference to radio communications. However, there is no guarantee that interference will not occur in a particular installation. If this equipment does cause harmful interference to radio or television reception, which can be determined by turning the equipment off and on, the user is encouraged to try to correct the interference by one or more of the following measures:

- Reorient or relocate the receiving antenna.
- Increase the separation between the equipment and receiver.
- Connect the equipment to an outlet on a circuit different from that to which the receiver is connected.
- Consult the dealer or an experienced radio/TV technician for help.

This device complies with part 15 of the FCC Rules.

Operation is subject to the following two conditions: (1) This device may not cause (harmful) interference, and (2) this device must accept any interference received, including interference that may cause undesired operation (of the device).

Any changes or modifications in construction of this device which are not expressly approved by the party responsible for compliance could void the user's authority to operate the equipment.

CAUTION

Do not attempt to modify this product in any way without written authorization from LG Electronics.

Unauthorized modification could void the user's authority to operate this product.

SAFETY INSTRUCTIONS

IMPORTANT SAFETY INSTRUCTIONS

Read these instructions.

Keep these instructions.

Heed all warnings.

Follow all instructions.



- 1** Do not use this apparatus near water.

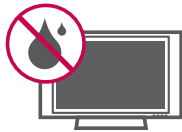

- 2** Clean only with dry cloth.



- 3** Do not block any ventilation openings. Install in accordance with the manufacturer's instructions.



- 4** Do not install near any heat sources such as radiators, heat registers, stoves, or other apparatus (including amplifiers) that produce heat.



- 5** Do not defeat the safety purpose of the polarized or grounding-type plug. A polarized plug has two blades with one wider than the other. A grounding type plug has two blades and a third grounding prong. The wide blade or the third prong are provided for your safety. If the provided plug does not fit into your outlet, consult an electrician for replacement of the obsolete outlet.



- 6** Protect the power cord from being walked on or pinched particularly at plugs, convenience receptacles, and the point where they exit from the apparatus.



- 7** Only use attachments/accessories specified by the manufacturer.



- 8** Use only with the cart, stand, tripod, bracket, or table specified by the manufacturer, or sold with the apparatus. When a cart is used, use caution when moving the cart/apparatus combination to avoid injury from tip-over.



S3125A

- 9** Unplug this apparatus during lightning storms or when unused for long periods of time.

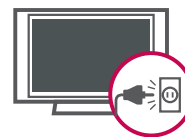

- 10** Refer all servicing to qualified service personnel. Servicing is required when the apparatus has been damaged in any way, such as power-supply cord or plug is damaged, liquid has been spilled or objects have fallen into the apparatus, the apparatus has been exposed to rain or moisture, does not operate normally, or has been dropped.

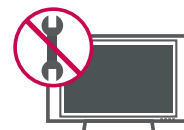

SAFETY INSTRUCTIONS

11 Never touch this apparatus or antenna during a thunder or lightning storm.

12 When mounting a TV on the wall, make sure not to install the TV by the hanging power and signal cables on the back of the TV.

13 Do not allow an impact shock or any objects to fall into the product, and do not drop onto the screen with something.

14 CAUTION concerning the Power Cord:
It is recommend that appliances be placed upon a dedicated circuit; that is, a single outlet circuit which powers only that appliance and has no additional outlets or branch circuits. Check the specification page of this owner's manual to be certain.

Do not connect too many appliances to the same AC power outlet as this could result in fire or electric shock.

Do not overload wall outlets. Overloaded wall outlets, loose or damaged wall outlets, extension cords, frayed power cords, or damaged or cracked wire insulation are dangerous. Any of these conditions could result in electric shock or fire. Periodically examine the cord of your appliance, and if its appearance indicates damage or deterioration, unplug it, discontinue use of the appliance, and have the cord replaced with an exact replacement part by an authorized servicer. Protect the power cord from physical or mechanical abuse, such as being twisted, kinked, pinched, closed in a door, or walked upon. Pay particular attention to plugs, wall outlets, and the point where the cord exits the appliance.

Do not use a damaged or loose power cord. Do not pull on the power cord to unplug the TV. Grasp the plug when unplugging the power cord.



15 WARNING - To reduce the risk of fire or electrical shock, do not expose this product to rain, moisture or other liquids. Do not touch the TV with wet hands. Do not install this product near flammable objects such as gasoline or candles or expose the TV to direct air conditioning.



16 Do not expose to dripping or splashing and do not place objects filled with liquids, such as vases, cups, etc. on or over the apparatus (e.g. on shelves above the unit).



17 **GROUNDING**
Ensure that you connect the earth ground wire to prevent possible electric shock (i.e. a TV with a three-prong grounded AC plug must be connected to a three-prong grounded AC outlet). If grounding methods are not possible, have a qualified electrician install a separate circuit breaker.

Do not try to ground the unit by connecting it to telephone wires, lightening rods, or gas pipes.

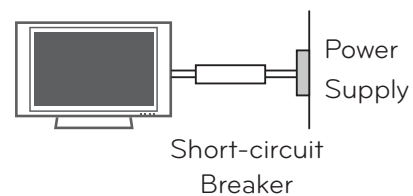

18 **DISCONNECTING DEVICE FROM MAINS**
Mains plug is the disconnecting device. The plug must remain readily operable.

19 As long as this unit is connected to the AC wall outlet, it is not disconnected from AC power even if you turn off the power switch on the unit.

20 ANTENNAS

Outdoor antenna grounding

If an outdoor antenna is installed, follow the precautions below. An outdoor antenna system should not be located in the vicinity of overhead power lines or other electric light or power circuits, or where it can come in contact with such power lines or circuits as death or serious injury can occur.

Be sure the antenna system is grounded so as to provide some protection against voltage surges and built-up static charges.

Section 810 of the National Electrical Code (NEC) in the U.S.A. provides information with respect to proper grounding of the mast and supporting structure, grounding of the lead-in wire to an antenna discharge unit, size of grounding conductors, location of antenna discharge unit, connection to grounding electrodes and requirements for the grounding electrode.

Antenna grounding according to the National Electrical Code, ANSI/NFPA 70

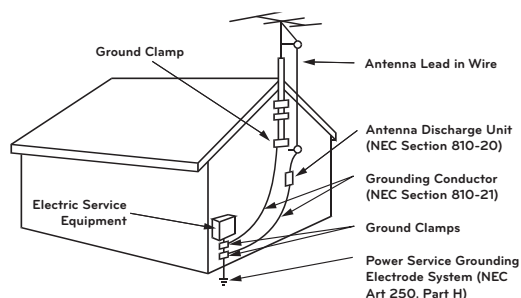

NEC: National Electrical Code

21 Cleaning

When cleaning, unplug the power cord and rub gently with a soft cloth to prevent scratching. Do not spray water or other liquids directly on the TV as electric shock may occur. Do not clean with chemicals such as alcohol, thinners or benzene.

22 Moving

Make sure the product is turned off, unplugged and all cables have been removed. It may take 2 or more people to carry larger TVs. Do not press against or put stress on the front panel of the TV.

23 Ventilation

Install your TV where there is proper ventilation. Do not install in a confined space such as a bookcase. Do not cover the product with cloth or other materials (e.g.) plastic while plugged in. Do not install in excessively dusty places.

24 Take care not to touch the ventilation openings. When watching the TV for a long period, the ventilation openings may become hot.

25 If you smell smoke or other odors coming from the TV or hear strange sounds, unplug the power cord contact an authorized service center.

26 Do not press strongly upon the panel with hand or sharp object such as nail, pencil or pen, or make a scratch on it.

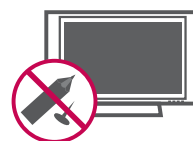

27 Keep the product away from direct sunlight.

28 For LED LCD TV

If the TV feels cold to the touch, there may be a small "flicker" when it is turned on. This is normal, there is nothing wrong with TV.

Some minute dot defects may be visible on the screen, appearing as tiny red, green, or blue spots. However, they have no adverse effect on the monitor's performance.

Avoid touching the LCD screen or holding your finger(s) against it for long periods of time. Doing so may produce some temporary distortion effects on the screen.

SAFETY INSTRUCTIONS

29 Viewing 3D Imaging

- ▶ When viewing 3D imaging, watch the TV from an effective viewing angle and within the appropriate distance. If you exceed this viewing angle or distance, you may not be able to view the 3D imaging. Furthermore, the 3D imaging may not display if it is viewed while you are lying down.
- ▶ If you watch the 3D imaging too closely or for a long period of time, it may harm your eyesight.
- ▶ Watching the TV or playing video games that incorporate 3D imaging with the 3D glasses for a long period of time can cause drowsiness, headaches or fatigue to you and/or your eyes. If you have a headache, or otherwise feel fatigued or drowsy, stop watching the TV and take a rest.
- ▶ Pregnant woman, seniors, persons with heart problems or persons who experience frequent drowsiness should refrain from watching 3D TV.
- ▶ Some 3D imaging may cause you to duck or dodge the image displayed in the video. Therefore, it is best if you do not watch 3D TV near fragile objects or near any objects that can be knocked over easily.
- ▶ Please prevent children under the age of 5 from watching 3D TV. It may affect their vision development.

▶ Warning for photosensitization seizure:

Some viewers may experience a seizure or epilepsy when exposed to certain factors, including flashing lights or images in TV or video games. If you or anybody from your family has a history of epilepsy or seizure, please consult with your doctor before watching 3D TV.

Also certain symptoms can occur in unspecified conditions without any previous history. If you experience any of the following symptoms, immediately stop watching the 3D imaging and consult a doctor: dizziness or lightheadedness, visual transition or altered vision, visual or facial instability, such as eye or muscle twitching, unconscious action, convulsion, loss of conscience, confusion or disorientation, loss of directional sense, cramps, or nausea. Parents should monitor their children, including teenagers, for these symptoms as they may be more sensitive to the effects of watching 3D TV.

Risk of photosensitization seizure can be reduced with the following actions.

- Take frequent breaks from watching 3D TV.
- For those who have vision that is different in each eye, they should watch the TV after taking vision correction measures.
- Watch the TV so that your eyes are on the same level as the 3D screen and refrain from sitting too closely to the TV
- Do not watch the 3D imaging when tired or sick, and avoid watching the 3D imaging for a long period of time.
- Do not wear the 3D glasses for any other purpose than viewing 3D imaging on a 3D TV.
- Some viewers may feel disoriented after watching 3D TV. Therefore, after you watch 3D TV, take a moment to regain awareness of your situation before moving.

CONTENTS

WARNING / CAUTION	2
SAFETY INSTRUCTIONS	3
CONTENTS	6
FEATURE OF THIS TV	9

PREPARATION

Accessories	10
Optional Extras	11
Front Panel Information	12
Back Panel Information	15
Stand Instructions	18
VESA Wall Mounting	22
Cable Management	24
Desktop Pedestal Installation	26
Swivel Stand	26
Kensington Security System	26
Securing the TV to the wall to prevent falling when the tv is used on a stand	27
Antenna or Cable Connection	28

EXTERNAL EQUIPMENT SETUP

HD Receiver Setup	29
DVD SETUP	33
VCR SETUP	36
Other A/V Source Setup	38
USB Connection	38
Headphone Setup	39
Audio Out Connection	40
External Equipment Wireless Connection (Optional Extras)	41
PC Setup	42
Network Setup	47

WATCHING TV / CHANNEL CONTROL

Remote Control Functions	55
Magic Motion Remote Control Functions	58
Turning on the TV	61
Channel Selection	61
Volume Adjustment	61
Initial Setting	62

On-Screen Menus Selection	64
Quick Menu	66
Home Menu	67
Customer Support	
- Software Update	68
- Picture Test/Sound Test	69
- Product/Service Info	70
- Network Test	71
Simple Manual	72
Channel Setup	
- Auto Scan (Auto Tuning)	73
- Add/Delete Channel (Manual Tuning)	74
- Channel Editing	75
Channel List	76
Favorite Channel Setup	77
Channel Information	78
Channel Brief Information	79
Input List	80
Input Label	81
Reset to Factory Default (Initial Setting)	82
Mode Setting	83
Demo Mode	84
AV Mode	85
Game/Schedule	86
SIMPLINK	90

3D VIDEO

3D Video	92
Watching 3D Video	94

MY MEDIA

Entry Mode	96
Connection Method	97
Movie list	102
Photo list	109
Music list	115
DivX Registration Code	120
Deactivation	121

NETWORK

Legal Notice	122
--------------------	-----

NETCAST

Netcast Menu.....	123
YOUTUBE.....	124
PICASA.....	126

PICTURE CONTROL

Picture Size (Aspect Ratio) Control.....	128
Picture Wizard.....	130
 Energy Saving.....	132
Preset Picture Settings (Picture Mode).....	133
Manual Picture Adjustment - User Mode	134
Picture Improvement Technology (Advanced Control).....	135
Expert Picture control.....	136
Picture Reset.....	139
TruMotion.....	140
LED Local Dimming.....	141
Power Indicator.....	142
Image Sticking Minimization (ISM) Method	143

SOUND & LANGUAGE CONTROL

Auto Volume.....	144
Clear Voice II.....	145
Balance.....	146
Preset Sound Settings (Sound Mode).....	147
Sound Setting Adjustment - User Mode.	148
Audio Reset.....	149
TV Speakers On/Off Setup.....	150
Stereo/SAP Broadcast Setup.....	151
Audio Language.....	152
On-screen Menus Language Selection....	153
Caption Mode	
- Analog Broadcasting System Captions.	154
- Digital Broadcasting System Captions...	155
- Caption Option.....	156

TIME SETTING

Clock Setting	
- Auto Clock Setup.....	157
- Manual Clock Setup.....	158
Auto On/Off Time Setting.....	159
Sleep Timer Setting.....	160

PARENTAL CONTROL / RATINGS

Set Password & Lock System	
- Setting up Your Password.....	161
- Set Password.....	162
Lock System.....	163
Channel Blocking.....	164
Movie & TV Rating.....	165
Downloadable Rating.....	170
External Input Blocking.....	171
Key Lock.....	172

APPENDIX

Troubleshooting.....	173
Maintenance.....	176
Product Specifications.....	177
IR Codes.....	180
External Control Through RS-232C.....	182
Open Source License.....	188

FEATURE OF THIS TV

- Some of these features are not available on all models.



High-definition television. High-resolution digital television broadcast and playback system composed of roughly a million or more pixels, 16:9 aspect-ratio screens, and AC3 digital audio. A subset of digital television, HDTV formats include 1080p, 1080i, and 720p resolutions.



Manufactured under license from Dolby Laboratories. "Dolby" and the double-D symbol are trademarks of Dolby Laboratories.



HDMI, the HDMI logo and High-Definition Multimedia Interface are trademarks or registered trademarks of HDMI Licensing LLC."



ABOUT DIVX VIDEO: DivX® is a digital video format created by DivX, Inc. This is an official DivX Certified device that plays DivX video. Visit www.divx.com for more information and software tools to convert your files into DivX video.

ABOUT DIVX VIDEO-ON-DEMAND: This DivX Certified® device must be registered in order to play DivX Video-on-Demand (VOD) content. To generate the registration code, locate the DivX VOD section in the device setup menu. Go to vod.divx.com with this code to complete the registration process and learn more about DivX VOD.

"DivX Certified to play DivX video up to HD 1080p, including premium content"

"Pat. 7,295,673; 7,460,688; 7,519,274"



This TV contains the detailed calibrations necessary for professional certification by the Imaging Science Foundation. The resulting ISF "day" and "night" modes will then be accessible by the user to experience the best their LG HDTV has to offer.

Sophisticated and detailed calibrations can be made through the ISFccc mode. Detailed calibration requires a licensed technician.

Please contact your local dealer to inquire about an ISF certified technician.



THX (Thomlinson Holman's Experiment) is an audio and video certification standard established by George Lucas and Thomlinson. A THX certified display guarantees screen quality that exceeds the display standard specification in both hardware and software.



View videos and photos and listen to music on your TV through USB 2.0 ('videos' dependent on model).



Displays HDTV programs in full 1920 x 1080p resolution for a more detailed picture.



IMPORTANT INFORMATION TO PREVENT "IMAGE BURN / BURN-IN" ON YOUR TV SCREEN

- When a fixed image (e.g. logos, screen menus, video game, and computer display) is displayed on the TV for an extended period, it can become permanently imprinted on the screen. This phenomenon is known as "image burn" or "burn-in." Image burn is not covered under the manufacturer's warranty.
- In order to prevent image burn, avoid displaying a fixed image on your TV screen for a prolonged period (2 or more hours for LCD, 1 or more hours for Plasma).
- Image burn can also occur on the letter-boxed areas of your TV if you use the 4:3 aspect ratio setting for an extended period.

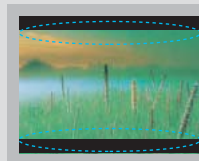
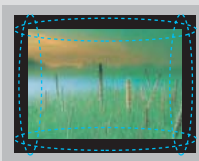
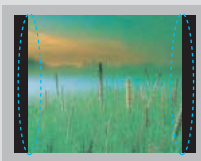

PREPARATION

ACCESSORIES

PREPARATION

Ensure that the following accessories are included with your TV. If an accessory is missing, please contact the dealer where you purchased the TV.

The accessories included may differ from the images below.



Owner's Manual

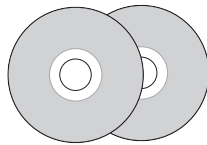

CD Manual,
Nero MediaHome 4
Essentials CD

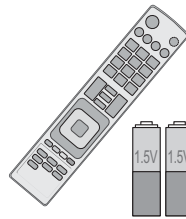

Remote Control,
Batteries (AAA)

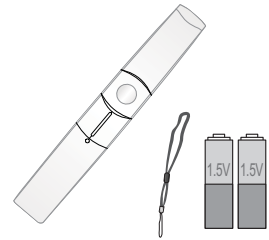

Motion Remote Control,
Strap,
Batteries (AA)

Not included with all models

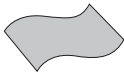

Polishing Cloth

- * Wipe spots on the exterior only with the polishing cloth.
- * Do not wipe roughly when removing stains. Excessive pressure may cause scratches or discoloration.

Option Extras

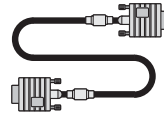

D-sub 15 pin Cable

When using the VGA (D-sub 15 pin cable) PC connection, the user must use shielded signal interface cables with ferrite cores to maintain standards compliance.

Not included with all models

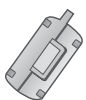

Ferrite Core
(Black)

Ferrite core can be used to reduce the electromagnetic waves that may interfere with the TV. Install the Ferrite core on the power cable close to the wall plug.



Ferrite Core
(White)

Ferrite core can be used to reduce the electromagnetic wave when connecting the LAN cable. Place the ferrite core far from TV and wind the LAN cable in the ferrite core once.

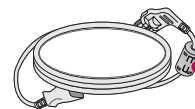

Close to the wall plug.

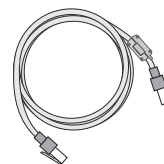

47/55LX9500, 47/55LEX8, 60/72LEX9

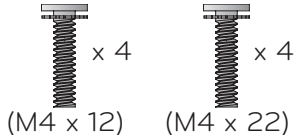

(M4 x 12) (M4 x 22)
Screws for stand assembly
(Refer to P.20)



Cable Holder
(Refer to p.25)

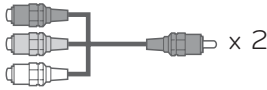

Component gender cable,
AV gender cable

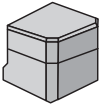

Stand Rear Cover

Plasma TV

(For 50PK95, **50PX950**)

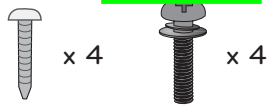

(M4 x 14) (M4 x 28)
Screws for stand assembly
(Refer to P.18)



Cable Holder
(Refer to P.24)



Power Cord

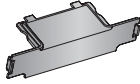

Protection Cover
(Refer to P.19)

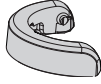

Cable
Management Clip
(Refer to P.24)



Wireless LAN for
Broadband/DLNA Adaptor
(AN-WF100)

OPTIONAL EXTRAS

Optional extras can be changed or modified for quality improvement without any notification. Contact your dealer for buying these items.

These devices only work with compatible LG LED LCD TV and Plasma TV.

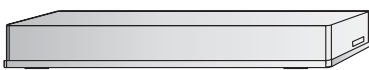

Wireless Media Box
(AN-WL100W)



Wireless LAN for Broadband/
DLNA Adaptor
(AN-WF100)

(For 47/55LX9500, 50/60PX950)

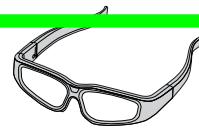

3D Glasses
(AG-S100)

PREPARATION

FRONT PANEL INFORMATION

PREPARATION

- Image shown may differ from your TV.

50/60PK950, 50/60PX950

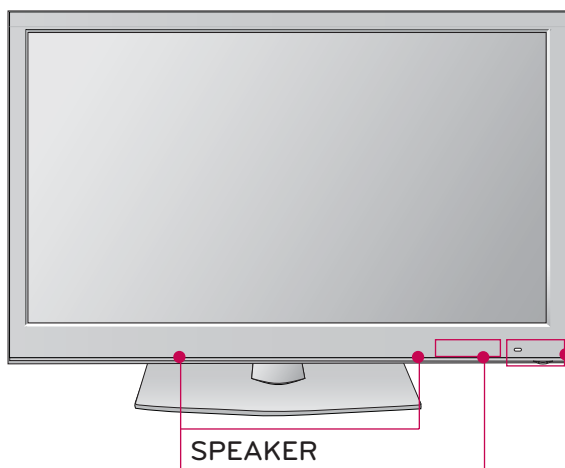

Intelligent Sensor
Adjusts picture according to the surrounding conditions

Remote Control Sensor

Power/Standby Indicator
Illuminates red in standby mode.
The lighting is off while the TV remains on.

A close-up diagram of the TV's front panel bezel. It shows three distinct components: the Intelligent Sensor (a small rectangular area), the Remote Control Sensor (a small rectangular area with a lens), and the Power/Standby Indicator (a small rectangular area). Red lines connect these components to their respective labels and descriptions.

Touch Button
You can operate the button just by touching the button lightly with your finger.

	INPUT	MENU	ENTER	- VOL +	∨ CH ^
POWER Button	INPUT Button	MENU Button	ENTER Button	VOLUME (+, -) Buttons	CHANNEL (^, ∨) Buttons

A diagram of the touch buttons on the TV's front panel. The buttons are arranged in a horizontal row. From left to right, they are: a Power/Standby Button (with a power symbol), an INPUT Button, a MENU Button, an ENTER Button (with a circle symbol), a VOLUME (+, -) Buttons (with minus, VOL, and plus symbols), and a CHANNEL (^, ∨) Buttons (with down arrow, CH, and up arrow symbols). Red lines connect each button to its label and description below.

47/55LX9500

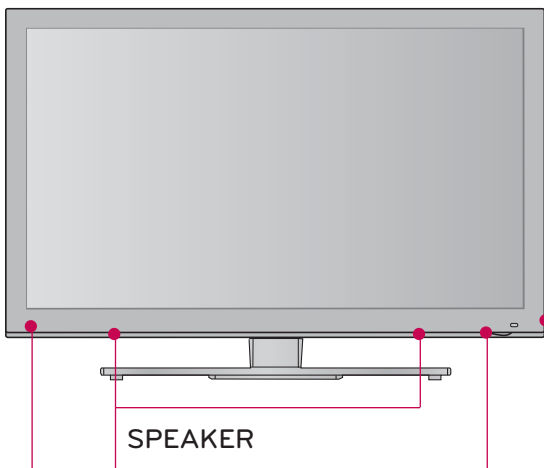

Emitter

It is the part equipped with the emitter exchanging signal with 3D glasses.
Please be careful not to block the screen with objects or people while watching a 3D Video.

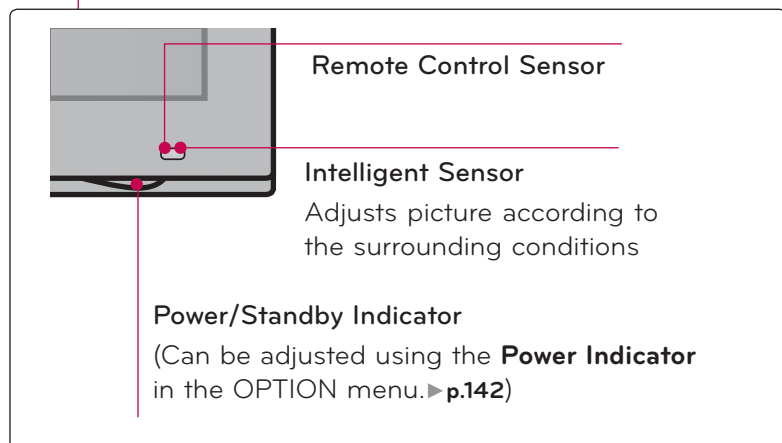
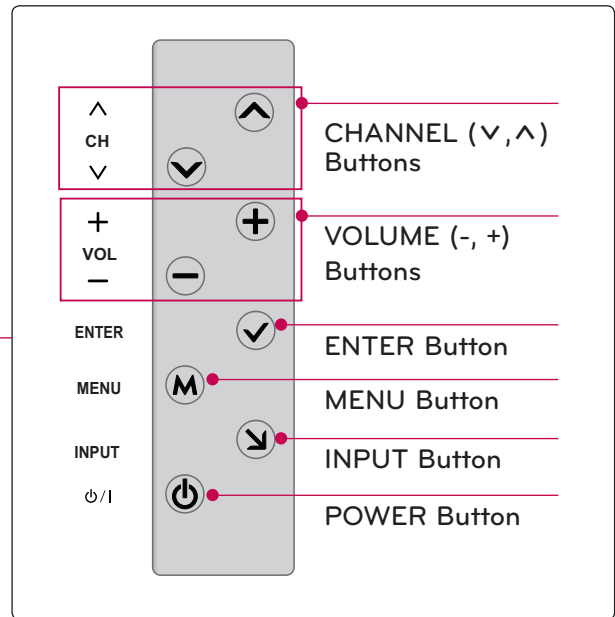

PREPARATION

PREPARATION

■ Image shown may differ from your TV.

47/55LEX8, 60/72LEX9

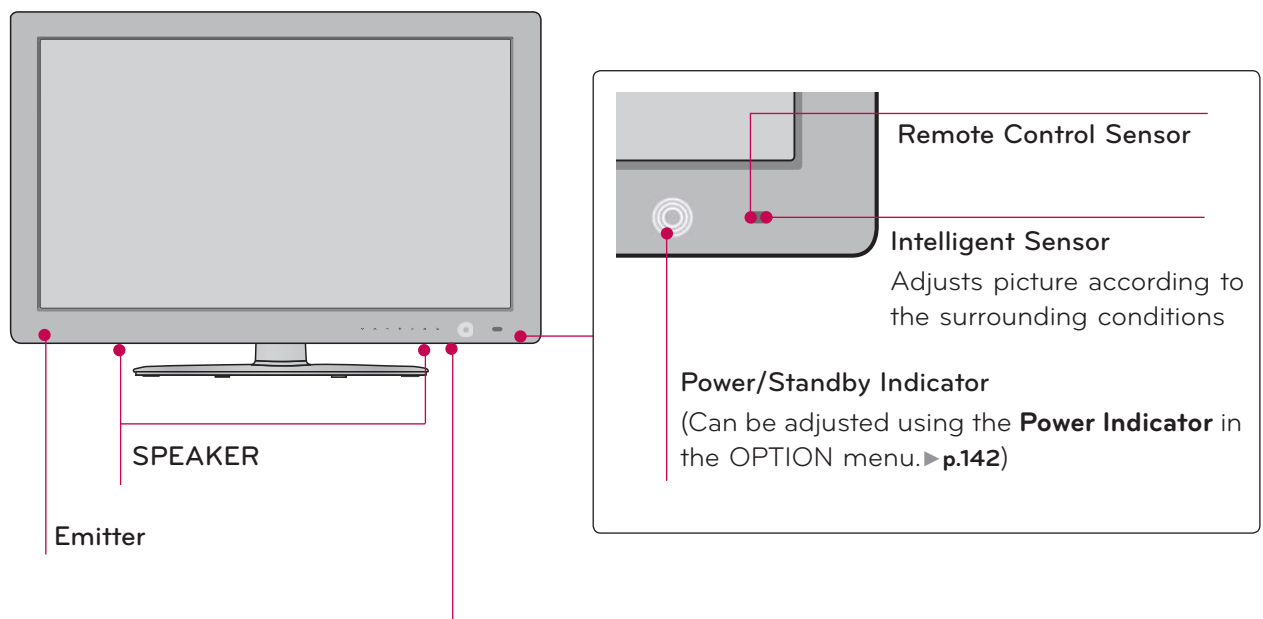

Touch Button
 You can operate the button just by touching the button lightly with your finger.

CH ↓ ↑	VOL - +	ENTER ✓	MENU M	INPUT ↘	⏻/I
CHANNEL (↓, ↑) Buttons	VOLUME (-, +) Buttons	ENTER Button	MENU Button	INPUT Button	POWER Button

BACK PANEL INFORMATION

Image shown may differ from your TV.

50/60PK950 50/60PX950

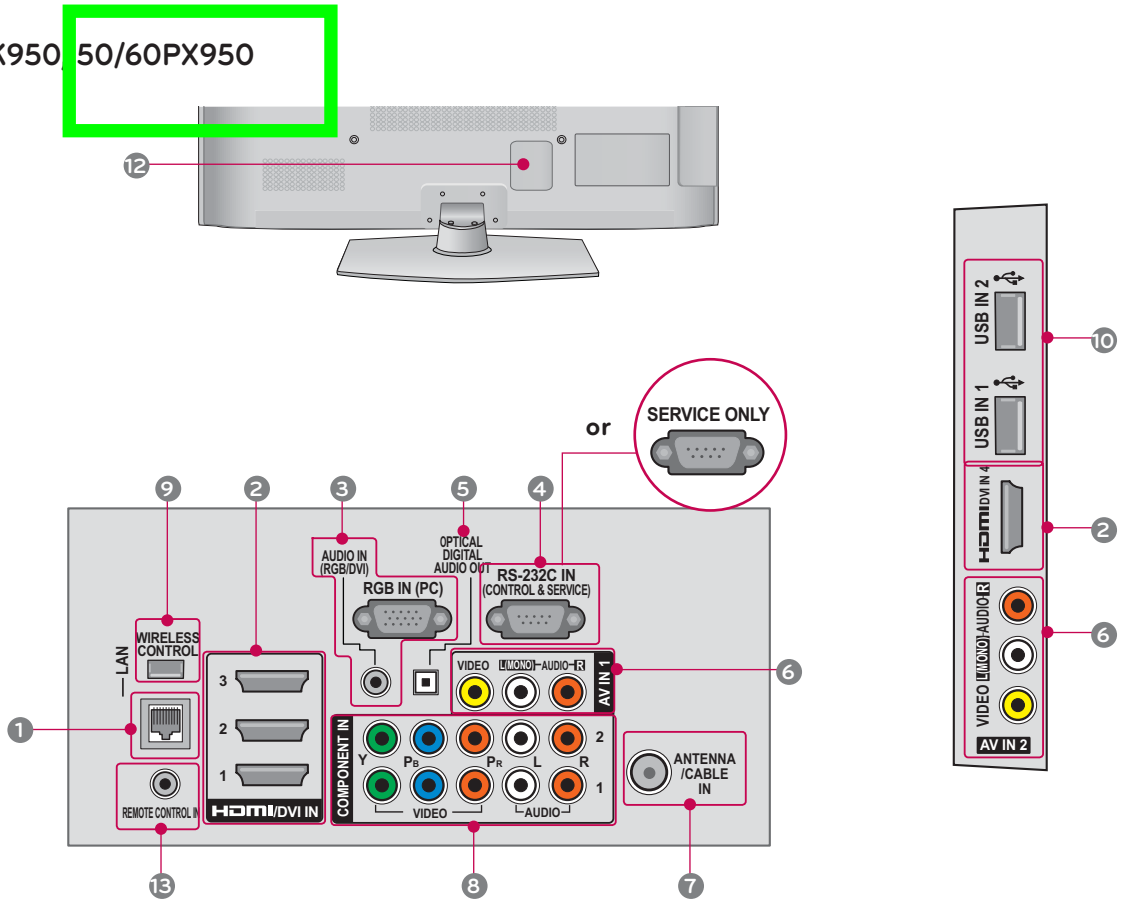

PREPARATION

47/55LX9500, 47/55LEX8, 60/72LEX9

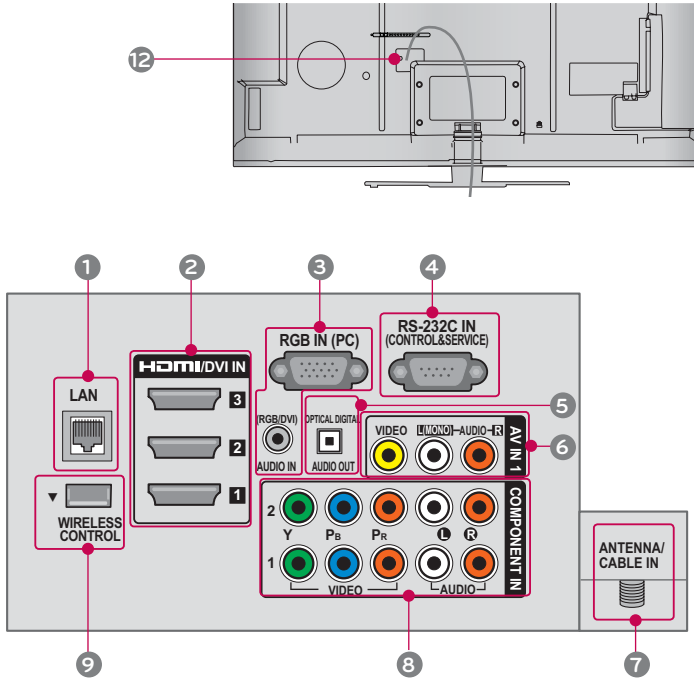

Close-up diagram of the TV's rear panel ports. The ports are numbered as follows:

- 2: HDMI IN 4
- 6: AV IN 2 (VIDEO/AUDIO)
- 8: COMPONENT IN 3 (AUDIO/Y, Pb, Pr)
- 10: USB IN 1 and 2
- 11: H/P

⚠ CAUTION

For HDMI IN 4 and USB IN 1, 2

- ▶ For an optimal connection, HDMI cables and USB devices should have bezels less than 10 mm (0.39 inches) thick.

*A ≤ 10 mm (0.39 inches)

1 LAN

Network connection for Netflix, Yahoo! TV Widgets, etc (for USA).

Also used for video, photo and music files on a local network.

2 HDMI/DVI IN, HDMI IN

Digital Connection.

Supports HD video and Digital audio. Doesn't support 480i.

Accepts DVI video using an adapter or HDMI to DVI cable (not included).

3 RGB IN (PC)

Analog PC Connection. Uses a D-sub 15 pin cable (VGA cable).

AUDIO IN (RGB/DVI)

0.32 cm (1/8 inch) headphone jack for analog PC audio input.

4 RS-232C IN (CONTROL & SERVICE) or SERVICE ONLY

Used by third party devices.

This port is used for service or Hotel mode.

5 OPTICAL DIGITAL AUDIO OUT

Digital optical audio output for use with amps and home theater systems.

Note: In standby mode, this port doesn't work.

6 AV (Audio/Video) IN

Analog composite connection.

Supports standard definition video only (480i).

7 ANTENNA/CABLE IN

Connect over-the-air or cable signals to this jack.

8 COMPONENT IN

Analog Connection.

Supports HD.

Uses a red, green, and blue cable for video & red and white for audio.

9 WIRELESS CONTROL

Connect the Wireless Ready Dongle to the TV to control the external input devices connected to Media Box wirelessly.

10 USB INPUT

Used for viewing photos, watching movies and listening to MP3s.

11 HEADPHONE

0.32 cm (1/8 inch) headphone jack

Impedance 16 Ω , Maximum audio out 15 mW

12 Power Cord or Socket

For operation with AC power.

Caution: Never attempt to operate the TV on DC power.

13 REMOTE CONTROL IN

For a wired remote control.

PREPARATION

STAND INSTRUCTIONS (For 50/60PK950, 50/60PX950)

Image shown may differ from your TV.

INSTALLATION

1 Carefully place the TV screen side down on a cushioned surface to protect the screen from damage.

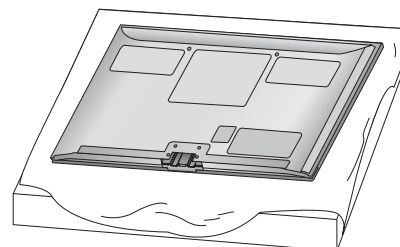

2 Assemble the parts of the **STAND BODY** with the **STAND BASE** of the TV.

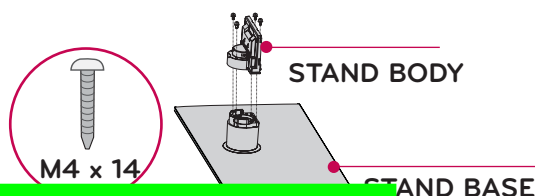

50PK950, 50PX950
(provided as parts of the product)

3 Assemble the parts of the **CABLE MANAGEMENT CLIP** with the **STAND BODY**.

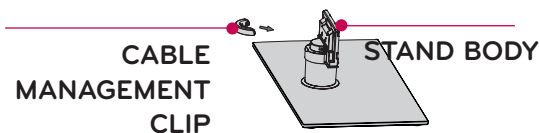

4 Assemble the TV as shown.

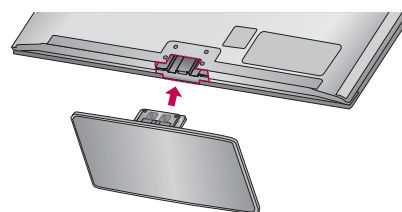

5 Install the 4 screws into the holes shown.

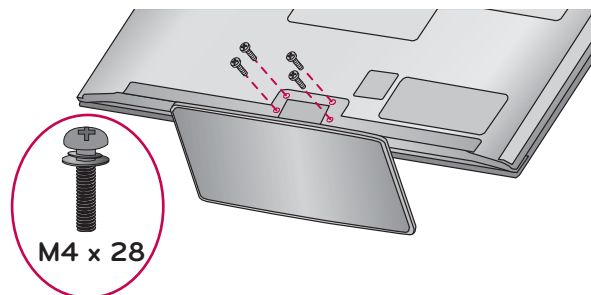

NOTE

▶ When assembling the desk type stand, make sure the screws are fully tightened (If not tightened fully, the TV can tilt forward after the product installation). Do not over tighten.

DETACHMENT

- 1 Carefully place the TV screen side down on a cushioned surface to protect the screen from damage.

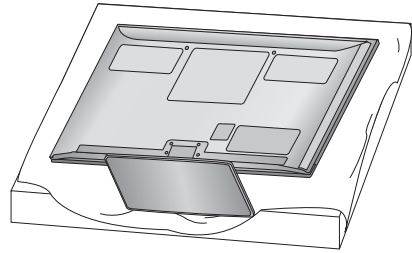

- 2 Remove the screws that hold the stand on.

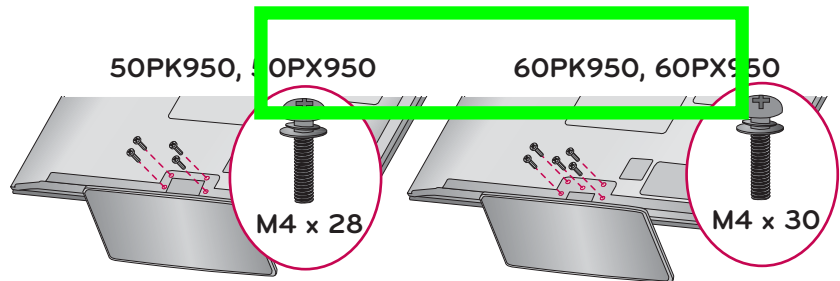

- 3 Detach the stand from TV.

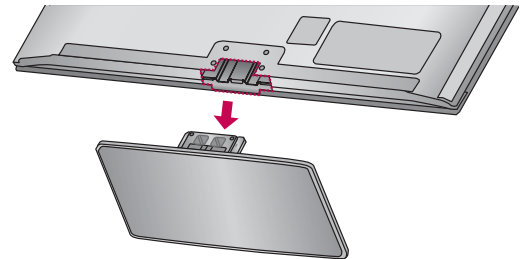

PROTECTION COVER

After removing the stand, install the included **PROTECTION COVER** over the hole for the stand.

Press the **PROTECTION COVER** into the TV until you hear it click.

When installing the wall mounting bracket, use the **PROTECTION COVER**.

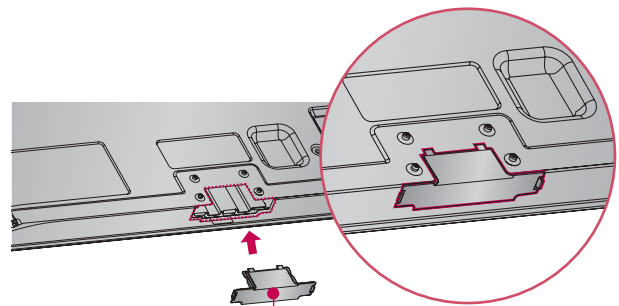

PROTECTION COVER

Fix a guide to the outside.

PREPARATION

STAND INSTRUCTIONS (For 47/55LX9500, 47/55LEX8)

- Image shown may differ from your TV.

INSTALLATION

- 1 Carefully place the TV screen side down on a cushioned surface to protect the screen from damage.

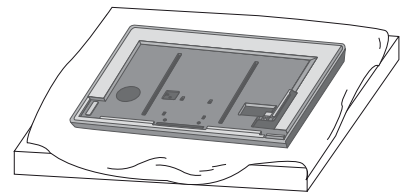

- 2 Assemble the parts of the **STAND BODY** with the **STAND BASE** of the TV.
At this time, tighten the screws that hold the **STAND BODY** on.

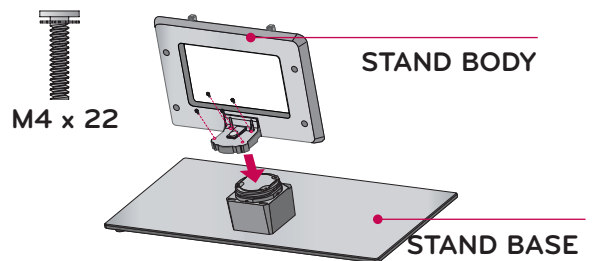

- 3 Install the 4 screws into the holes shown.

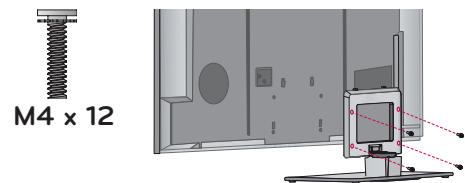

- 4 Assemble the part of the **STAND REAR COVER** with the TV.

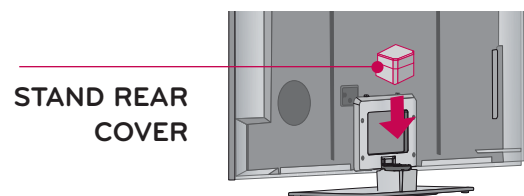

NOTE

- ▶ When assembling the desk type stand, make sure the screws are fully tightened (If not tightened fully, the TV can tilt forward after the product installation). Do not over tighten.

DETACHMENT

- 1 Carefully place the TV screen side down on a cushioned surface to protect the screen from damage.

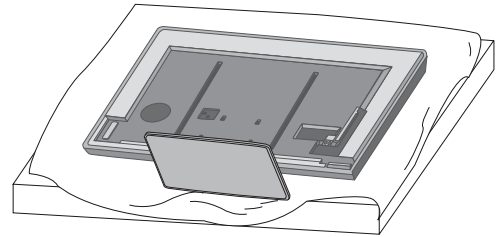

- 2 Detach the **STAND REAR COVER** from TV.

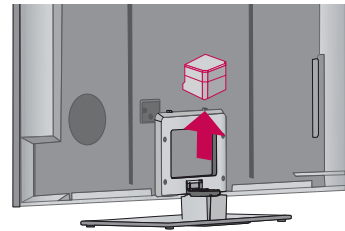

- 3 Remove the screws that hold the stand on.

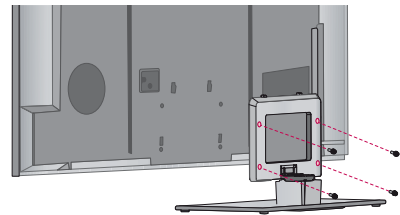

- 4 Detach the stand from TV.

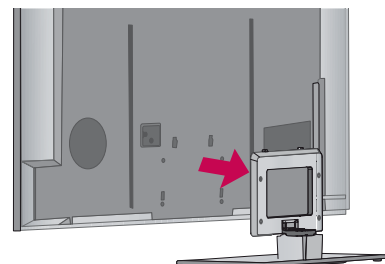

PREPARATION

VESA WALL MOUNTING

PREPARATION

Install your wall mount onto wooden studs perpendicular to the floor. When attaching to other building materials, please contact a professional.

If installed on a ceiling or slanted wall, it may fall and result in severe personal injury.

We recommend that you use an LG brand wall mount when mounting the TV to a wall.

LG recommends that wall mounting be performed by a qualified professional installer.

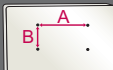
Model	VESA (A * B) 	Standard Screw	Quantity	Wall Mounting Bracket (sold separately)
47LX9500, 47LEX8	200 * 200	M6	4	LSW200B, LSW200BG, LSW200BX, LSW200BXG 
55LX9500, 55LEX8	400 * 400	M6	4	LSW400B, LSW400BG, DSW400BG 
50PK950, 50PX950	400 * 400	M6	4	AW-50PG60M AW-50PG60MS 
60PK950, 60PX950	600 * 400	M8	4	AW-60PG60M AW-60PG60MS 

NOTE

- ▶ Screw length needed depends on the wall mount used. For further information, refer to the instructions included with the mount.
- ▶ Standard dimensions for wall mount kits are shown in the table.
- ▶ When purchasing our wall mount kit, a detailed installation manual and all parts necessary for assembly are provided.
- ▶ Do not use screws longer than the standard dimension, as they may cause damage to the inside to the TV.
- ▶ For wall mounts that do not comply with the VESA standard screw specifications, the length of the screws may differ depending on their specifications.
- ▶ Do not use screws that do not comply with the VESA standard screw specifications.
Do not use fasten the screws too strongly, this may damage the TV or cause the TV to a fall, leading to personal injury. LG is not liable for these kinds of accidents.
- ▶ LG is not liable for TV damage or personal injury when a non-VESA or non specified wall mount is used or the consumer fails to follow the TV installation instructions.

CAUTION

- ▶ Do not install your wall mount kit while your TV is turned on. It may result in personal injury due to electric shock.

PREPARATION

CABLE MANAGEMENT

■ Image shown may differ from your TV.

Plasma TV

How to use the CABLE HOLDER

- 1 After connecting the cables as necessary, install the **CABLE HOLDER** as shown and bundle the cables.

In case of the LAN cable, install as shown to reduce the electromagnetic wave.

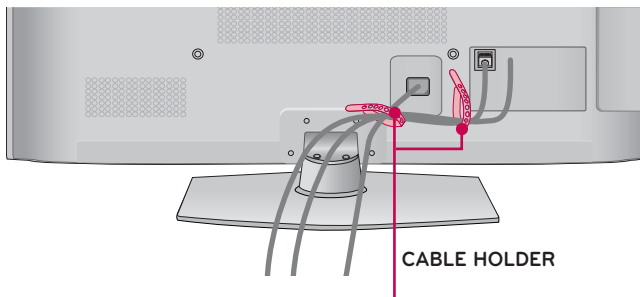

How to use the CABLE MANAGEMENT CLIP

- 1 Connect the cables as necessary.
To connect additional equipment, see the **EXTERNAL EQUIPMENT SETUP** section.

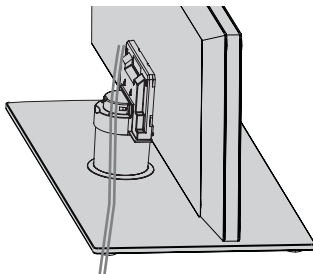

- 2 Install the **CABLE MANAGEMENT CLIP** into the TV until clicking sound.

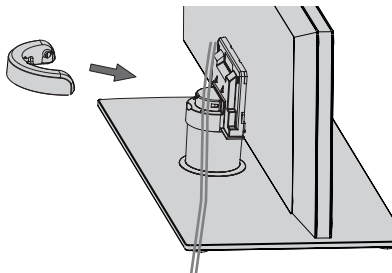

HOW TO REMOVE THE CABLE MANAGEMENT CLIP

- Hold the **CABLE MANAGEMENT CLIP** with both hands and pull it backward as shown.

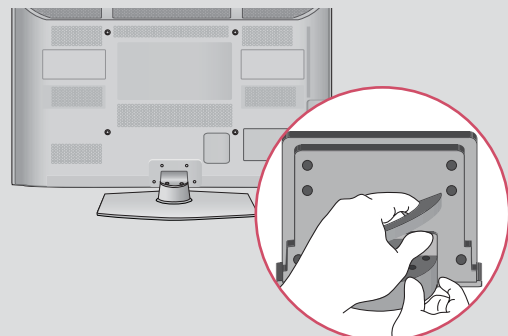

■ Image shown may differ from your TV.

47/55LX9500, 47/55LEX8, 60/72LEX9

- 1 Secure the power cord with the **CABLE HOLDER** on the TV back cover. It will help prevent the power cable from being removed by accident.

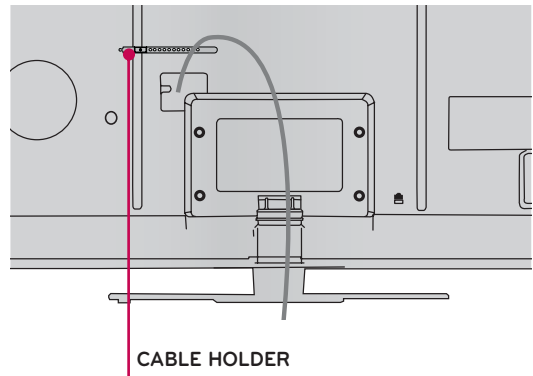

- 2 After connecting the cables as necessary, install the **CABLE HOLDER** as shown and bundle the cables.

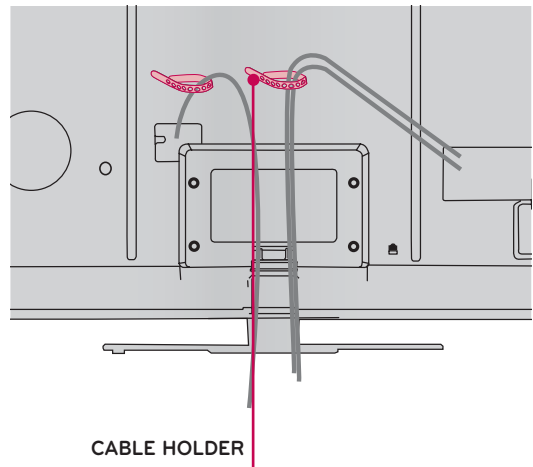

PREPARATION

DESKTOP PEDESTAL INSTALLATION

- Image shown may differ from your TV.

For proper ventilation, allow a clearance of 10.1 cm (4 inch) on all four sides from the wall.

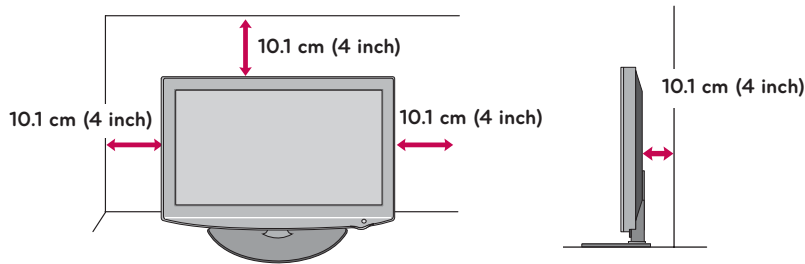

⚠ CAUTION

- ▶ Ensure adequate ventilation by following the clearance recommendations.
- ▶ Do not mount near or above any type of heat source.

SWIVEL STAND

After installing the TV, you can adjust the TV set manually to the left or right direction by 20 ° to suit your viewing position.

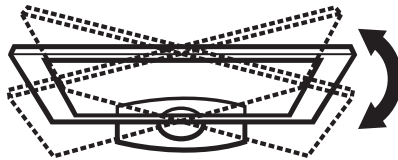

KENSINGTON SECURITY SYSTEM

- This feature is not available for all models.
 - The TV is equipped with a Kensington Security System connector on the back panel. Connect the Kensington Security System cable as shown below.
 - For the detailed installation and use of the Kensington Security System, refer to the user's guide provided with the Kensington Security System.
- For further information, contact <http://www.kensington.com>, the internet homepage of the Kensington company. Kensington sells security systems for expensive electronic equipment such as notebook PCs and LCD projectors.

NOTE: The Kensington Security System is an optional accessory.

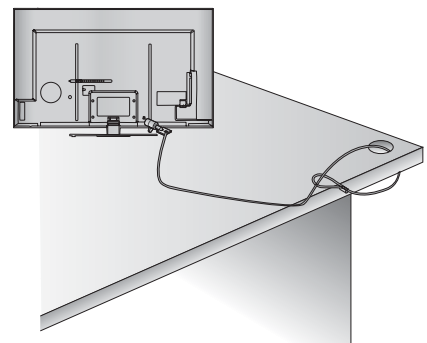

SECURING THE TV TO THE WALL TO PREVENT FALLING WHEN THE TV IS USED ON A STAND

- You should purchase necessary components to prevent the TV from tipping over (when not using a wall mount).
- Image shown may differ from your TV.

We recommend that you set up the TV close to a wall so it cannot fall over if pushed backwards. Additionally, we recommend that the TV be attached to a wall so it cannot be pulled in a forward direction, potentially causing injury or damaging the product.

Caution: Please make sure that children don't climb on or hang from the TV.

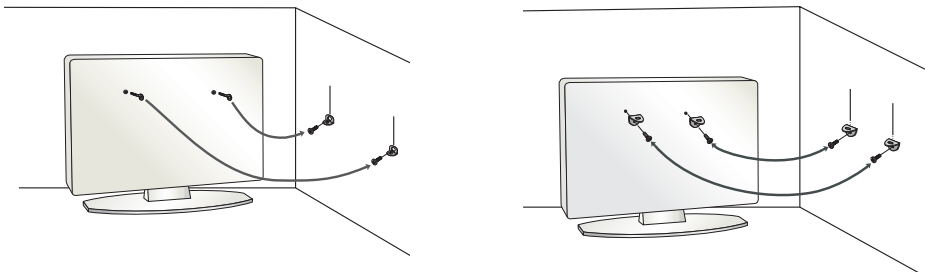

- Insert the eye-bolts (or TV brackets and bolts) to tighten the product to the wall as shown in the picture.

* If your product has the bolts in the eye-bolts position before inserting the eye-bolts, loosen the bolts.

* Insert the eye-bolts or TV brackets/bolts and tighten them securely in the upper holes.

Secure the wall brackets with the bolts (sold separately) to the wall. Match the height of the bracket that is mounted on the wall to the holes in the product.

Ensure the eye-bolts or brackets are tightened securely.

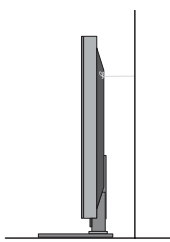

- Use a sturdy rope (sold separately) to tie the product. It is safer to tie the rope so it becomes horizontal between the wall and the product.

NOTE

- ▶ Use a platform or cabinet strong enough and large enough to support the size and weight of the TV.
- ▶ To use the TV safely make sure that the height of the bracket on the wall and the one on the TV are the same.

PREPARATION

- To prevent damage do not connect to the power outlet until all connections are made between the devices.
- Image shown may differ from your TV.

ANTENNA OR CABLE CONNECTION

1. Antenna (Analog or Digital)

Wall Antenna Socket or Outdoor Antenna without a Cable Box Connections.
For optimum picture quality, adjust antenna direction if needed.

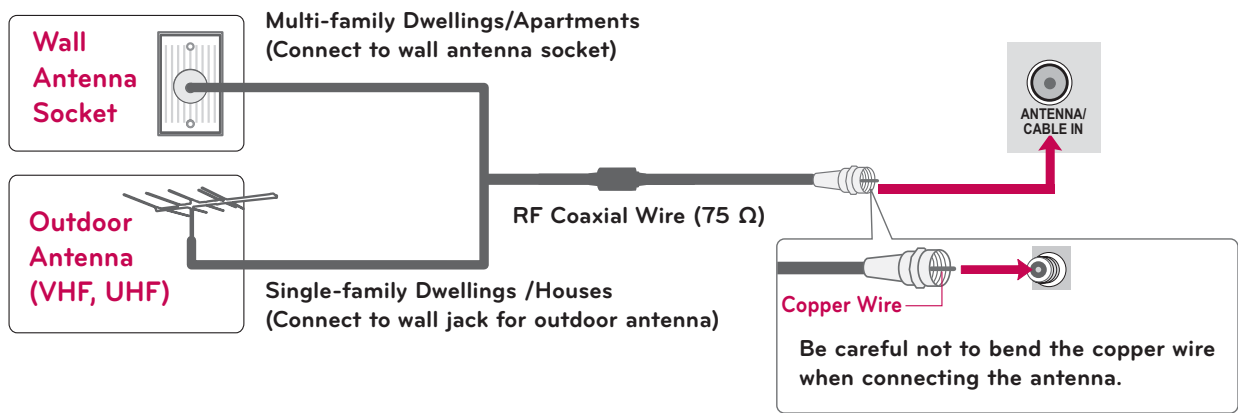

2. Cable

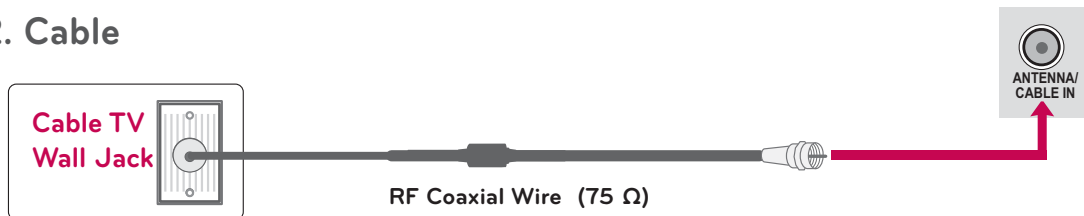

- If the antenna needs to be split for two TV's, install a 2-Way Signal Splitter.
- For much more information about antennas visit our Knowledgebase at <http://lgknowledgebase.com>. Search for antenna.

EXTERNAL EQUIPMENT SETUP

- To prevent the equipment damage, never plug in any power cords until you have finished connecting all equipment.
- Image shown may differ from your TV.

HD RECEIVER SETUP

This TV can receive digital over-the-air/digital cable signals without an external digital set-top box. However, if you do receive digital signals from a digital set-top box or other digital external device.

Component Connection

1. How to connect

- 1 Connect the video outputs (Y, PB, PR) of the digital set-top box to the **COMPONENT IN VIDEO 1, 2, or 3*** jacks on the TV. Match the jack colors (Y = green, PB = blue, and PR = red).
- 2 Connect the audio output of the digital set-top box to the **COMPONENT IN AUDIO 1, 2, or 3*** jacks on the TV.

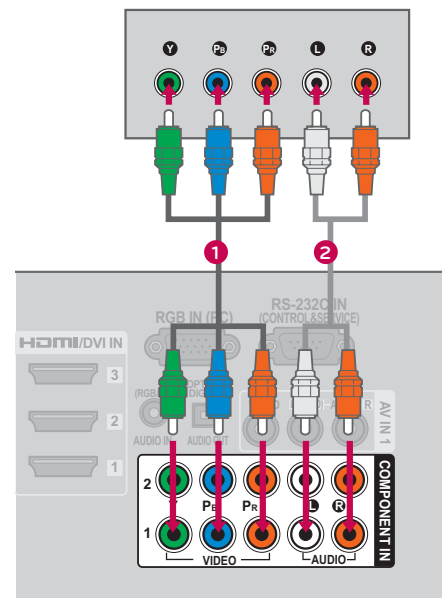

2. How to use

- Turn on the digital set-top box.
(Refer to the owner's manual for the digital set-top box operation.)
- Select the **Component1, Component2, or Component3** input source on the TV using the **INPUT** button on the remote control.

* Component3: For LED LCD TV

Y, CB/PB, CR/PR

Resolution	Horizontal Frequency(KHz)	Vertical Frequency(Hz)
720x480i	15.73	59.94
	15.73	60.00
720x480p	31.47	59.94
	31.50	60.00
1280x720p	44.96	59.94
	45.00	60.00
1920x1080i	33.72	59.94
	33.75	60.00
1920x1080p	26.97	23.976
	27.00	24.00
	33.71	29.97
	33.75	30.00
	67.432	59.94
	67.50	60.00

EXTERNAL EQUIPMENT SETUP

For LED LCD TV

EXTERNAL EQUIPMENT SETUP

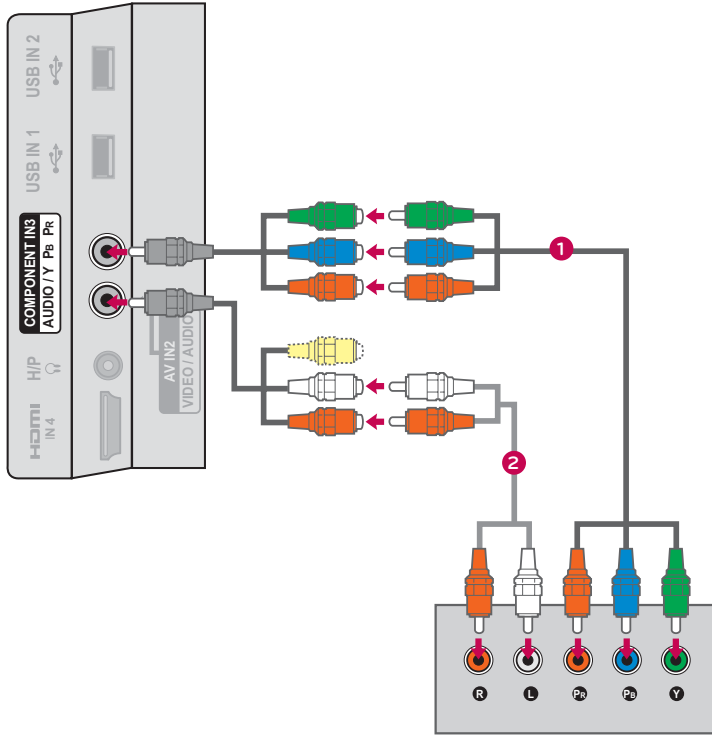

HDMI Connection

1. How to connect

- 1 Connect the digital set-top box to **HDMI/DVI IN 1, 2, 3,** or **4** jack on the TV.
- 2 No separate audio connection is necessary. HDMI supports both audio and video.

2. How to use

- Turn on the digital set-top box.
(Refer to the owner's manual for the digital set-top box.)
- Select the **HDMI1, HDMI2, HDMI3,** or **HDMI4** input source on the TV using the **INPUT** button on the remote control.

NOTE

- ▶ If an HDMI cable doesn't support High Speed HDMI, it can cause flickers or no screen display. In this case use the latest cables that support High Speed HDMI.
- ▶ HDMI Audio Supported Format: Dolby Digital (32 KHz, 44.1 KHz, 48 KHz), Linear PCM (32 KHz, 44.1 KHz, 48 KHz)

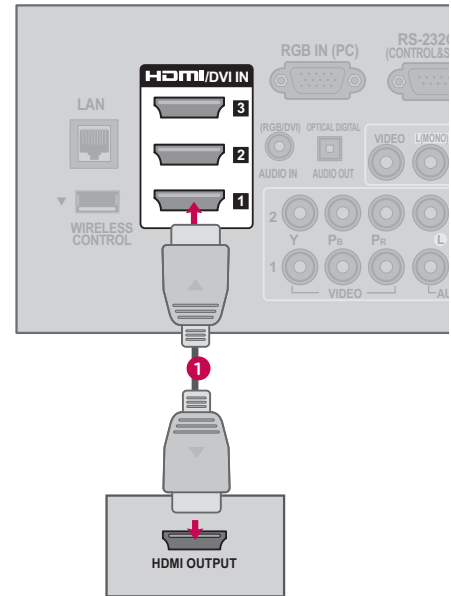

HDMI-DTV

Resolution	Horizontal Frequency(KHz)	Vertical Frequency(Hz)
720x480p	31.47	59.94
	31.50	60.00
1280x720p	44.96	59.94
	45.00	60.00
1920x1080i	33.72	59.94
	33.75	60.00
1920x1080p	26.97	23.976
	27.00	24.00
	33.71	29.97
	33.75	30.00
	67.432	59.94
	67.50	60.00

EXTERNAL EQUIPMENT SETUP

DVI to HDMI Connection

1. How to connect

- 1 Connect the DVI output of the digital set-top box to the **HDMI/DVI IN 1, 2, 3, or 4*** jack on the TV.
- 2 Connect the digital set-top box audio output to the **AUDIO IN (RGB/DVI)** jack on the TV.

2. How to use

- Turn on the digital set-top box.
(Refer to the owner's manual for the digital set-top box.)
- Select the **HDMI1, HDMI2, HDMI3, or HDMI4*** input source on the TV using the **INPUT** button on the remote control.

* *HDMI4: For Plasma TV*

NOTE

- ▶ A DVI to HDMI cable or adapter is required for this connection. DVI doesn't support audio, so a separate audio connection is necessary.

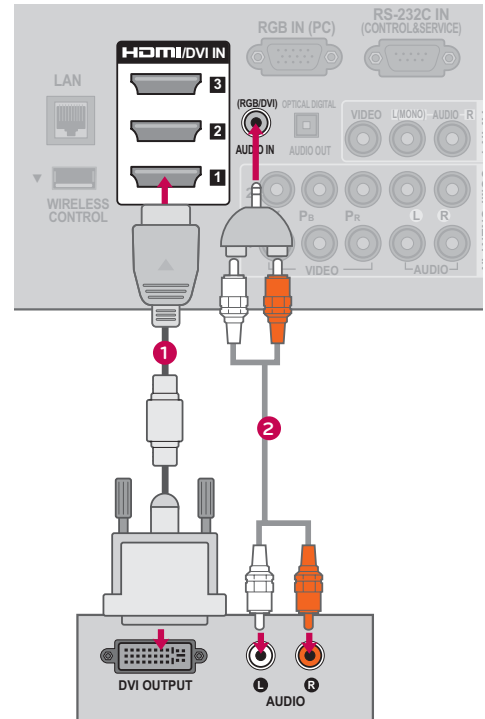

DVD SETUP

Component Connection

1. How to connect

- 1
 Connect the video outputs (Y, PB, PR) of the DVD to the **COMPONENT IN VIDEO 1, 2, or 3*** jacks on the TV.
 Match the jack colors (Y = green, PB = blue, and PR = red).
- 2
 Connect the audio outputs of the DVD to the **COMPONENT IN AUDIO 1, 2, or 3*** jacks on the TV.

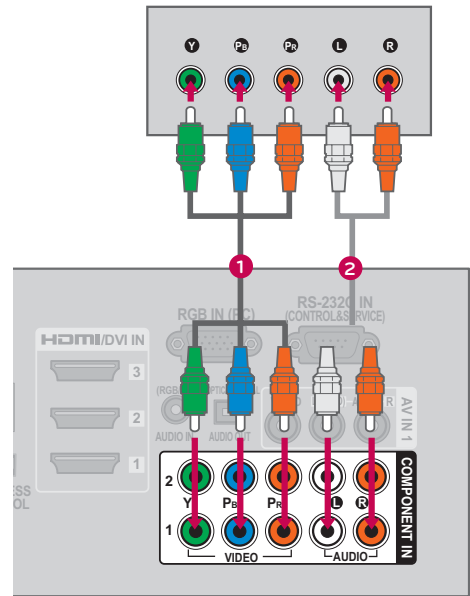

2. How to use

- Turn on the DVD player, insert a DVD.
- Select the **Component1**, **Component2**, or **Component3** input source on the TV using the **INPUT** button on the remote control.
- Refer to the DVD player's manual for operating instructions.

* Component3: For LED LCD TV

Component Input ports

To get better picture quality, connect a DVD player to the component input ports as shown below.

Component ports on the TV	Y	P _B	P _R
Video output ports on DVD player	Y	P _B	P _R
	Y	B-Y	R-Y
	Y	C _b	C _r
	Y	P _b	P _r

For LED LCD TV

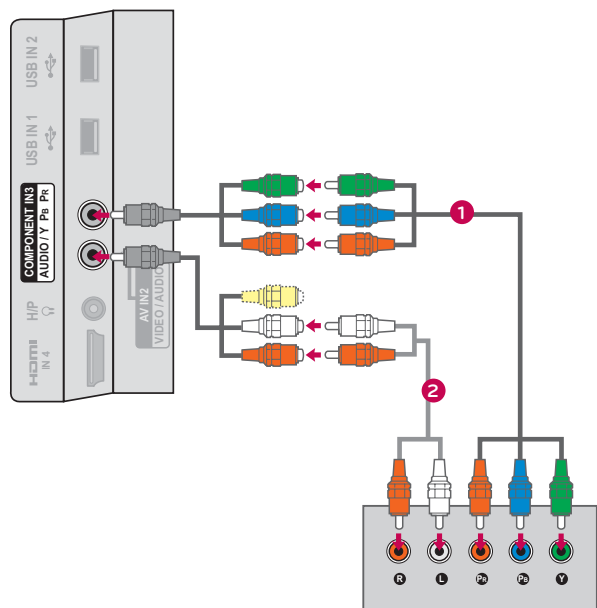

EXTERNAL EQUIPMENT SETUP

Composite (RCA) Connection

1. How to connect

- 1 Connect the **AUDIO/VIDEO** jacks between TV and DVD. Match the jack colors (Video = yellow, Audio Left = white, and Audio Right = red)

2. How to use

- Turn on the DVD player, insert a DVD.
- Select the **AV1** or **AV2** input source on the TV using the **INPUT** button on the remote control.
- Refer to the DVD player's manual for operating instructions.

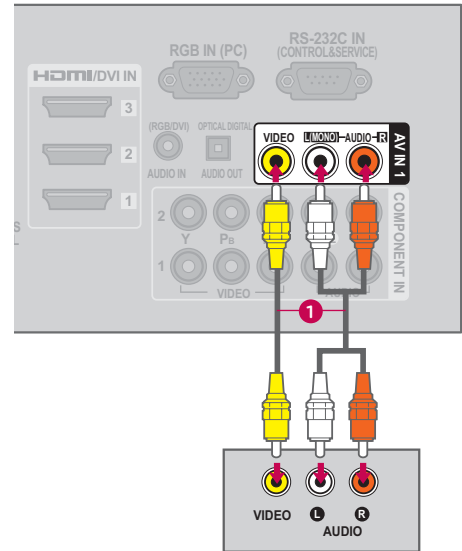

For LED LCD TV

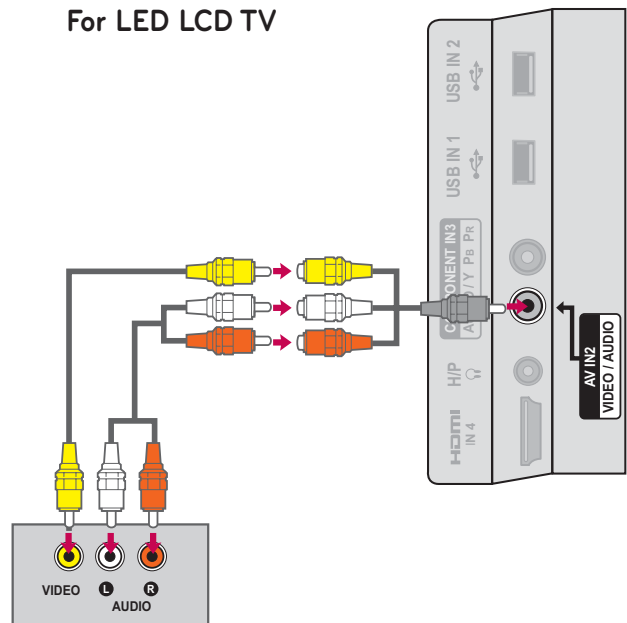

HDMI Connection

1. How to connect

- 1 Connect the HDMI output of the DVD to the **HDMI/DVI IN 1, 2, 3** or **4** jack on the TV.
- 2 No separate audio connection is necessary. HDMI supports both audio and video.

2. How to use

- Select the **HDMI1, HDMI2, HDMI3,** or **HDMI4** input source on the TV using the **INPUT** button on the remote control.
- Refer to the DVD player's manual for operating instructions.

NOTE

- ▶ If an HDMI cable doesn't support High Speed HDMI, it can cause flickers or no screen display. In this case use the latest cables that support High Speed HDMI.
- ▶ HDMI Audio Supported Format: Dolby Digital (32 KHz, 44.1 KHz, 48 KHz), Linear PCM (32 KHz, 44.1 KHz, 48 KHz)

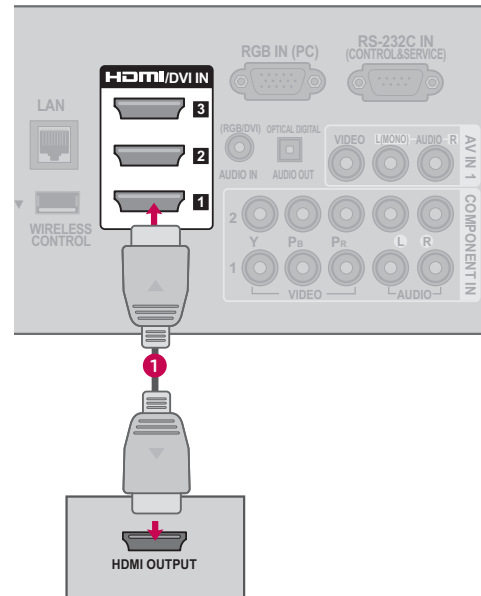

EXTERNAL EQUIPMENT SETUP

VCR SETUP

Antenna Connection

1. How to connect

- 1 Connect the RF antenna out socket of the VCR to the **ANTENNA/CABLE IN** socket on the TV.
- 2 Connect the antenna cable to the RF antenna in socket of the VCR.

2. How to use

- Set VCR output switch to 3 or 4 and then tune TV to the same channel number.
- Insert a video tape into the VCR and press PLAY on the VCR (Refer to the VCR owner's manual).

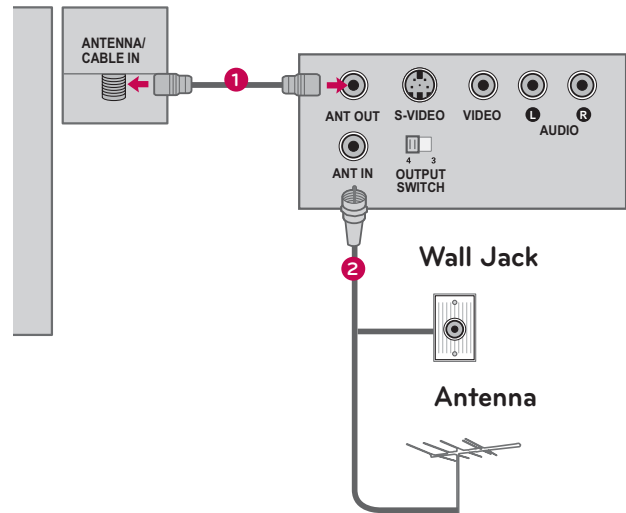

Composite (RCA) Connection

1. How to connect

- 1 Connect the **AUDIO/VIDEO** jacks between TV and VCR. Match the jack colors (Video = yellow, Audio Left = white, and Audio Right = red)

2. How to use

- Insert a video tape into the VCR and press PLAY on the VCR. (Refer to the VCR owner's manual.)
- Select the **AV1** or **AV2** input source on the TV using the **INPUT** button on the remote control.

NOTE

- ▶ If you have a mono VCR, connect the audio cable from the VCR to the **AUDIO L/MONO** jack of the TV.

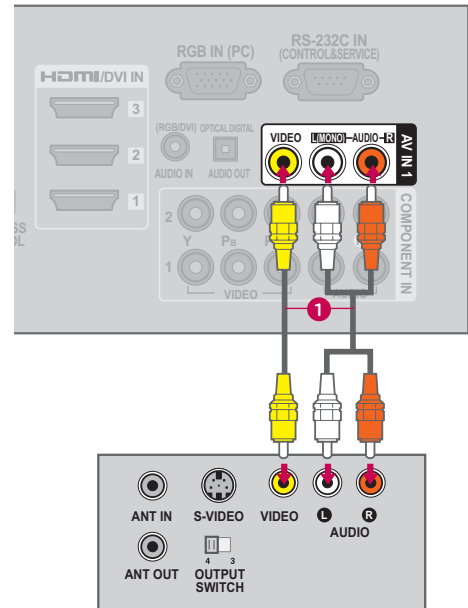

For LED LCD TV

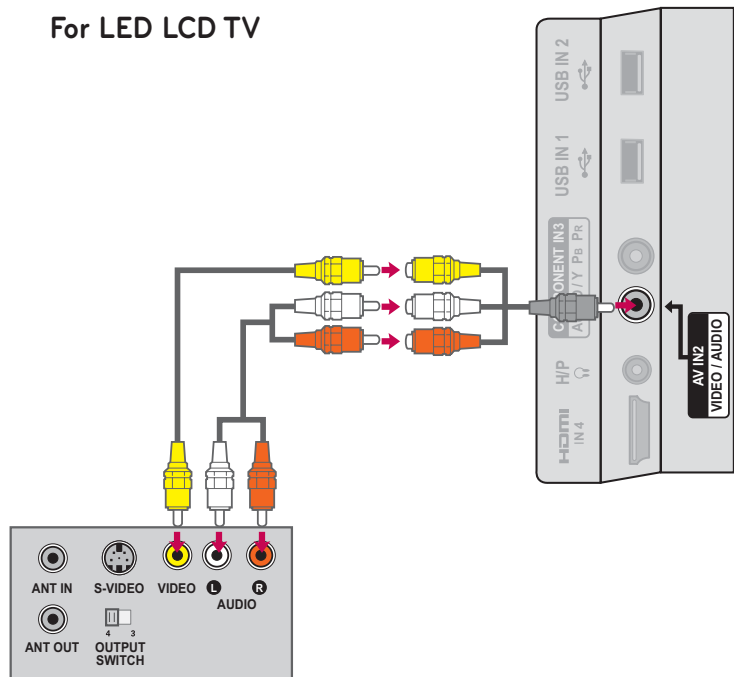

EXTERNAL EQUIPMENT SETUP

OTHER A/V SOURCE SETUP

1. How to connect

- 1 Connect the **AUDIO/VIDEO** jacks between TV and external equipment. Match the jack colors. (Video = yellow, Audio Left = white, and Audio Right = red)

2. How to use

- Select the **AV1** or **AV2** input source on the TV using the **INPUT** button on the remote control.
- Operate the corresponding external equipment.

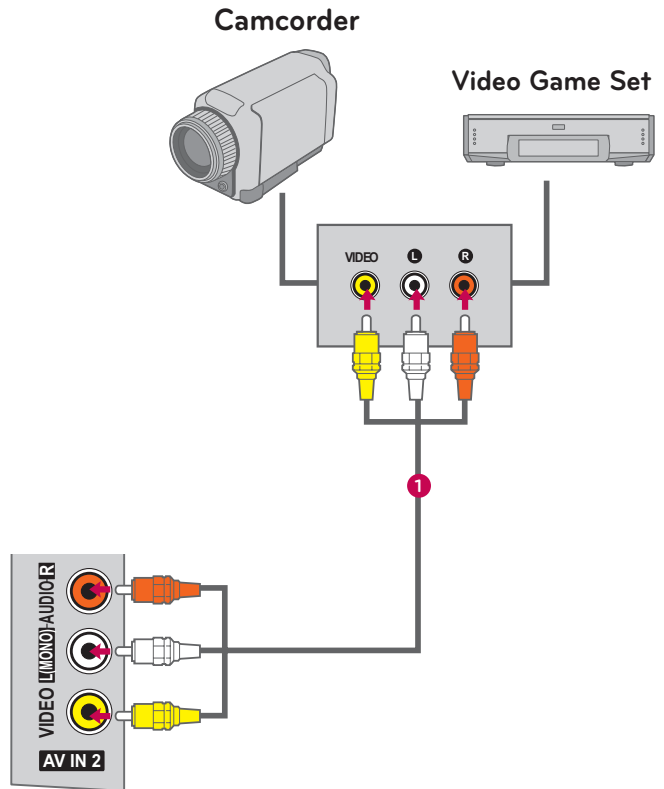

USB CONNECTION

1. How to connect

- 1 Connect the USB device to the **USB IN 1** or **2** jack on the side of TV.

2. How to use

- After connecting the **USB IN** jack, you use the USB function. (▶ p.97)

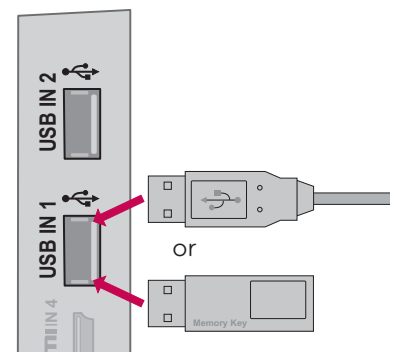

HEADPHONE SETUP (FOR LED LCD TV)

You can listen to the sound through headphones.

1. How to connect

- 1 Plug headphones into the headphone socket.
- 2 To adjust the headphone volume, press the **VOL +/-** button. If you press the **MUTE** button, the sound from the headphone is switched off.

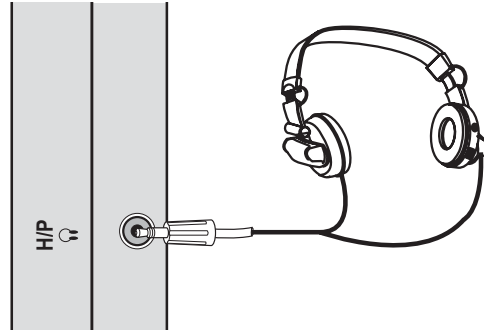

NOTE

- ▶ AUDIO menu options are disabled when connecting headphones.
- ▶ When changing AV MODE with headphones connected, the change is applied to video but not to audio.
- ▶ Optical Digital Audio Out is not available with headphones connected.

EXTERNAL EQUIPMENT SETUP

AUDIO OUT CONNECTION

Send the TV's audio to external audio equipment via the Audio Output port.

If you want to enjoy digital broadcasting through 5.1-channel speakers, connect the **OPTICAL DIGITAL AUDIO OUT** terminal on the back of TV to a Home Theater (or amp).

1. How to connect

- 1 Connect one end of the optical cable to the TV port of **OPTICAL DIGITAL AUDIO OUT**.
- 2 Connect the other end of the optical cable to the digital audio input on the audio equipment.
- 3 Set the "TV Speaker option - Off" in the AUDIO menu. (▶ p.150). See the external audio equipment instruction manual for operation.

NOTE

- ▶ When connecting with external audio equipment, such as amplifiers or speakers, you can turn the TV speakers off in the menu. (▶ p.150)

CAUTION

- ▶ Do not look into the optical output port. Looking at the laser beam may damage your vision.
- ▶ Audio with ACP (Audio Copy Protection) function may block digital audio output.

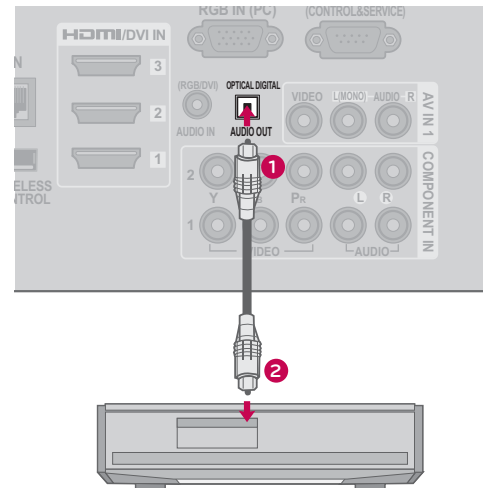

EXTERNAL EQUIPMENT WIRELESS CONNECTION (OPTIONAL EXTRAS)

LG TVs with a Wireless Control port support the LG Wireless Media Box, which is sold separately. When you connect the wireless ready dongle (included with the media box) to the TV, external devices can be connected to the LG Wireless Media Box and video and audio will be sent to the TV wirelessly.

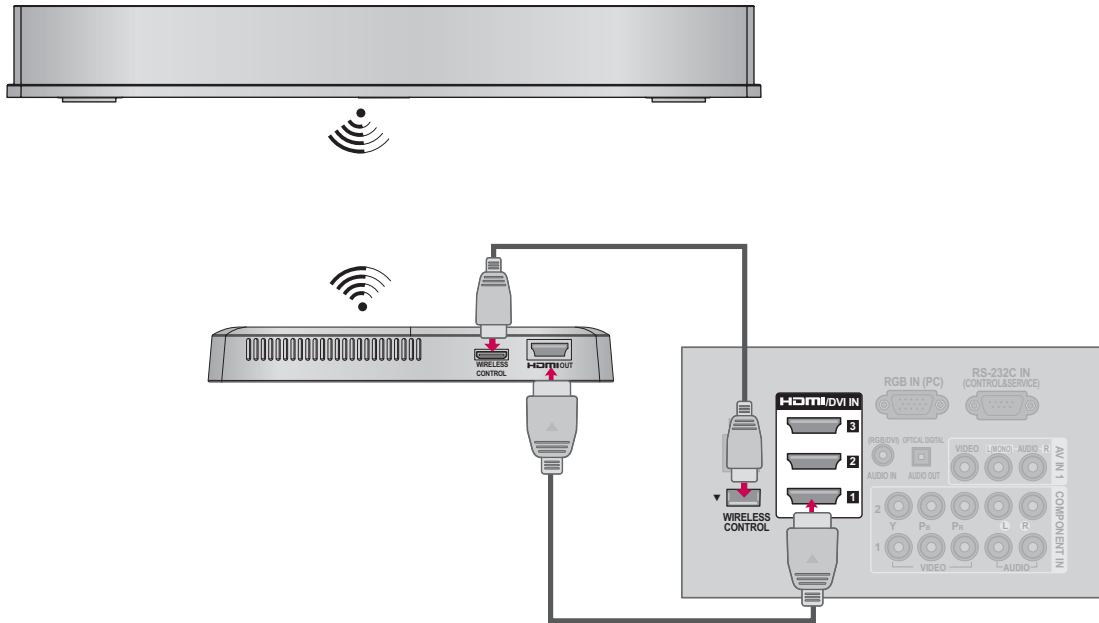

1. How to connect

- 1 Connect the **WIRELESS CONTROL** jack of the Wireless Ready Dongle to the **WIRELESS CONTROL** jack on the TV.
- 2 Connect **HDMI OUT** jack of the Wireless Ready Dongle to the **HDMI IN** jack on the TV.

2. How to use

- Select the desired input source on the TV using the **INPUT** button on the remote control.
- Refer to the Wireless Media Box manual for operating instructions.

NOTE

- ▶ When using the external device connected to the Wireless Media Box, some functions of the TV menu may not work.

EXTERNAL EQUIPMENT SETUP

PC SETUP

This TV provides Plug and Play capability, meaning that a PC adjusts automatically to the TV's settings.

VGA (D-Sub 15 Pin) Connection

1. How to connect

- 1 Connect the VGA output of the PC to the **RGB IN (PC)** jack on the TV.
- 2 Connect PC audio output to the **AUDIO IN (RGB/DVI)** jack on the TV.

2. How to use

- Turn on the PC and the TV.
- Select the **RGB-PC** input source on the TV using the **INPUT** button on the remote control.

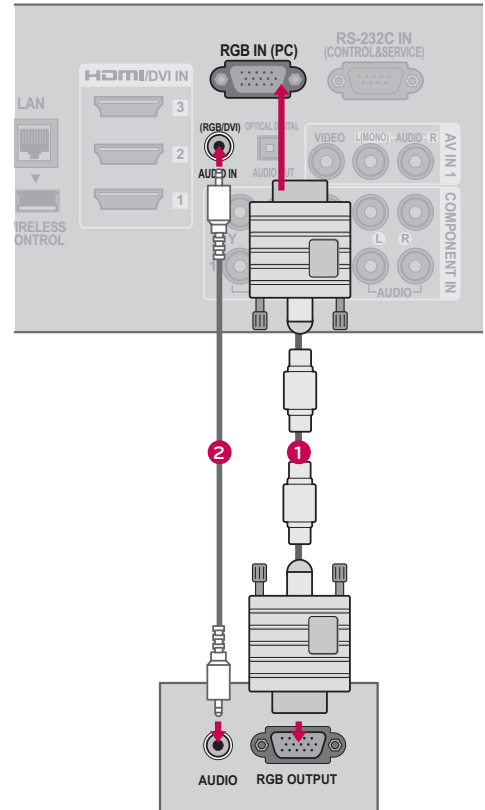

DVI to HDMI Connection

1. How to connect

- 1 Connect the DVI output of the PC to the **HDMI/DVI IN 1, 2, 3, or 4*** jack on the TV.
- 2 Connect the PC audio output to the **AUDIO IN (RGB/DVI)** jack on the TV.

2. How to use

- Turn on the PC and the TV.
- Select the **HDMI1, HDMI2, HDMI3, or HDMI4*** input source on the TV using the **INPUT** button on the remote control.

* HDMI4: For Plasma TV

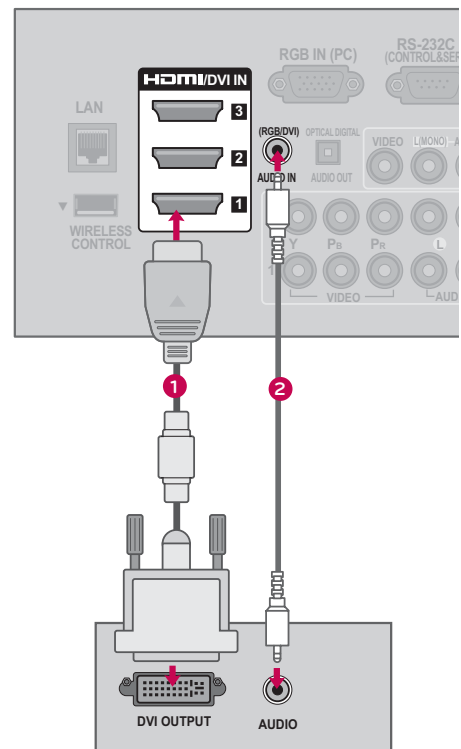

NOTE

- ▶ To get the the best picture quality, adjust the PC graphics card to **1920x1080**.
- ▶ Depending on the graphics card, DOS mode may not work if a HDMI to DVI Cable is in use.
- ▶ In PC mode, there may be noise associated with the resolution, vertical pattern, contrast or brightness. If noise is present, change the PC output to another resolution, change the refresh rate to another rate or adjust the brightness and contrast on the PICTURE menu until the picture is clear.
- ▶ Avoid keeping a fixed image on the screen for a long period of time. The fixed image may become permanently imprinted on the screen.
- ▶ The synchronization input form for Horizontal and Vertical frequencies is separate.
- ▶ Depending on the graphics card, some resolution settings may not allow the image to be positioned on the screen properly.
- ▶ If you experience overscan issues when using HDMI-PC 1920x1080, change aspect ratio to **Just scan**.
- ▶ When selecting HDMI-PC, set the "Input Label - PC" in the OPTION menu.

Supported Display Specifications (RGB-PC, HDMI-PC)

Resolution	Horizontal Frequency (KHz)	Vertical Frequency (Hz)
640x350	31.468	70.09
720x400	31.469	70.08
640x480	31.469	59.94
800x600	37.879	60.31
1024x768	48.363	60.00
1280x768	47.776	59.87
1360x768	47.712	60.015
1280x1024	63.981	60.02
1920x1080 RGB-PC	66.587	59.934
1920x1080 HDMI-PC	67.50	60.00

EXTERNAL EQUIPMENT SETUP

Screen Setup for PC mode







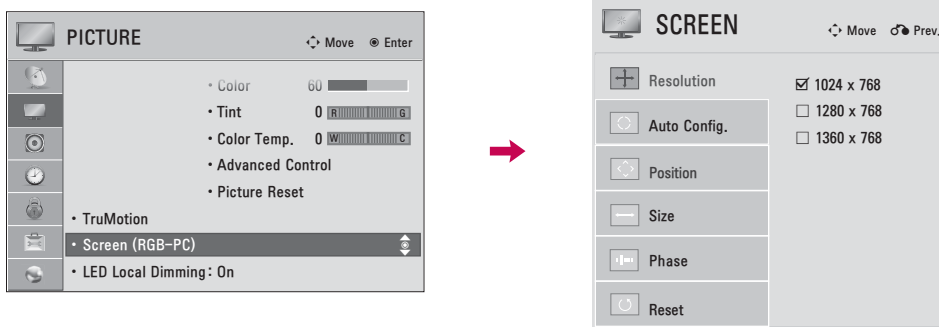

Selecting Resolution

You can choose the resolution in RGB-PC mode.

The Position, Phase, and Size can also be adjusted.

You can choose this option only when the PC resolution is set to 1024X768, 1280X768 or 1360X768.



-   Select **PICTURE**.
-   Select **Screen (RGB-PC)**.
-   Select **Resolution**.
-   Select the desired resolution.
- 

Auto Configure







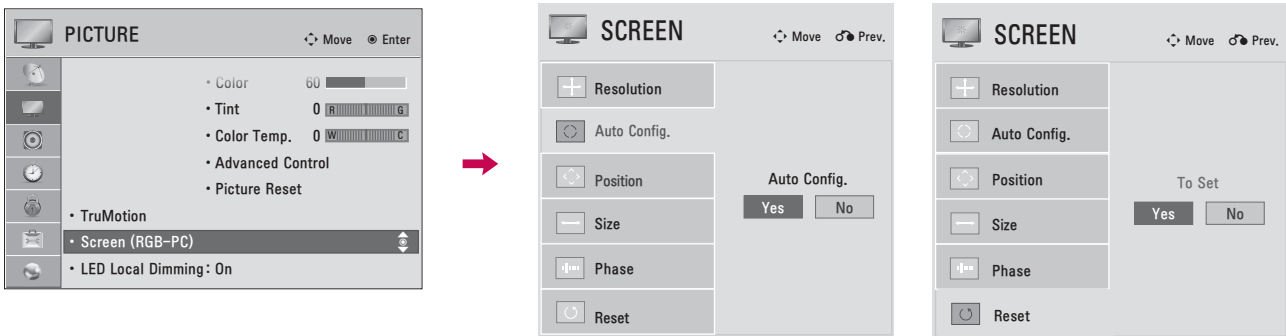

Automatically adjusts picture position and minimizes image instability. After adjustment, if the image is still not correct, try using the manual settings or a different resolution or refresh rate on the PC.

Screen Reset (Reset to original initial values)

Returns **Position**, **Size**, and **Phase** to the default initial settings.

This feature operates only in RGB-PC mode.



- 1   Select **PICTURE**.
- 2   Select **Screen (RGB-PC)**.
- 3   Select **Auto Config.** or **Reset**.
- 4   Select **Yes**.
- 5 







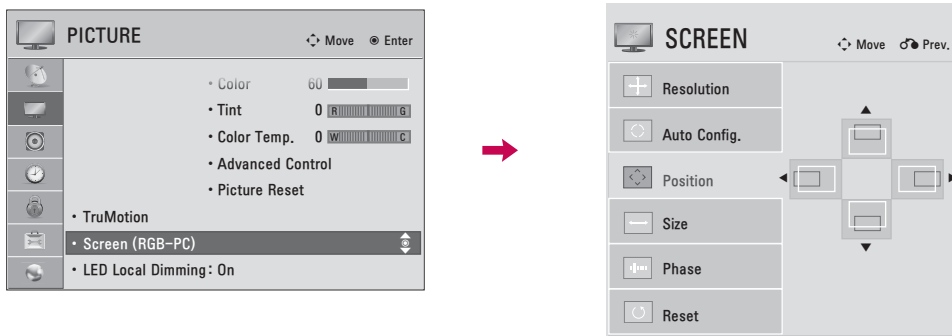

- If the position of the image is still not correct, try Auto adjustment again.
- If picture needs to be adjusted again after Auto adjustment in RGB-PC, you can adjust the **Position**, **Size** or **Phase**.

EXTERNAL EQUIPMENT SETUP

Adjustment for screen Position, Size, and Phase

If the picture is not clear after auto adjustment or if text is shaking, adjust the picture phase manually. This feature operates only in RGB-PC mode.



- 1   Select **PICTURE**.
- 2   Select **Screen (RGB-PC)**.
- 3   Select **Position, Size, or Phase**.
- 4   Make appropriate adjustments.
- 5 

- **Position:** This function is to adjust picture to left/right and up/down as you prefer.
- **Size:** This function is to minimize any vertical bars or stripes visible on the screen background. And the horizontal screen size will also change.
- **Phase:** This function allows you to remove any horizontal noise and clear or sharpen the image of characters.

NETWORK SETUP

Wired Network Connection

This TV can be connected to a local area network (LAN) via the LAN port. After making the physical connection, the TV needs to be set up for network communication.

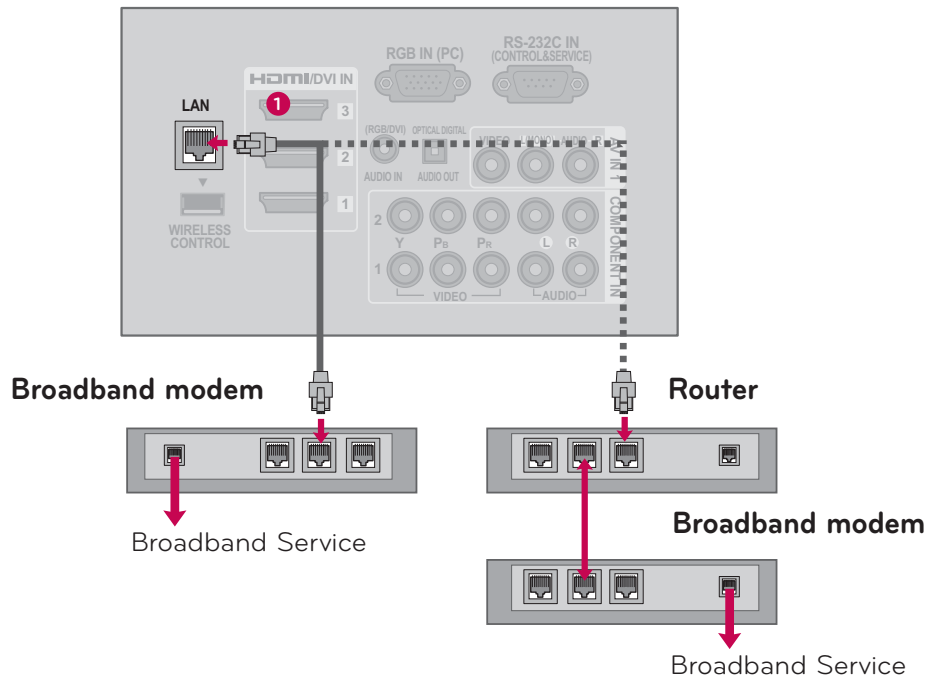

1. How to connect

- 1 Connect the LAN port of the Modem or Router to the **LAN** port on the TV.

2. How to use

- Select "**Network Setting**" in the NETWORK menu.
- After connecting the **LAN** port, use the NETCAST menu.
- For more information about NETCAST setup and troubleshooting, visit <http://lgknowledgebase.com>. Search for NETCAST.

⚠ CAUTION

- ▶ Do not connect a modular phone cable to the LAN port.
- ▶ Since there are various connection methods, please follow the specifications of your telecommunication carrier or internet service provider.

EXTERNAL EQUIPMENT SETUP

Wired Network Setup

If wired and wireless networks are both available, wired is the preferred method.

After making a physical connection, a small number of home networks may require the TV network settings to be adjusted.

For detail information, contact your internet provider or router manual.

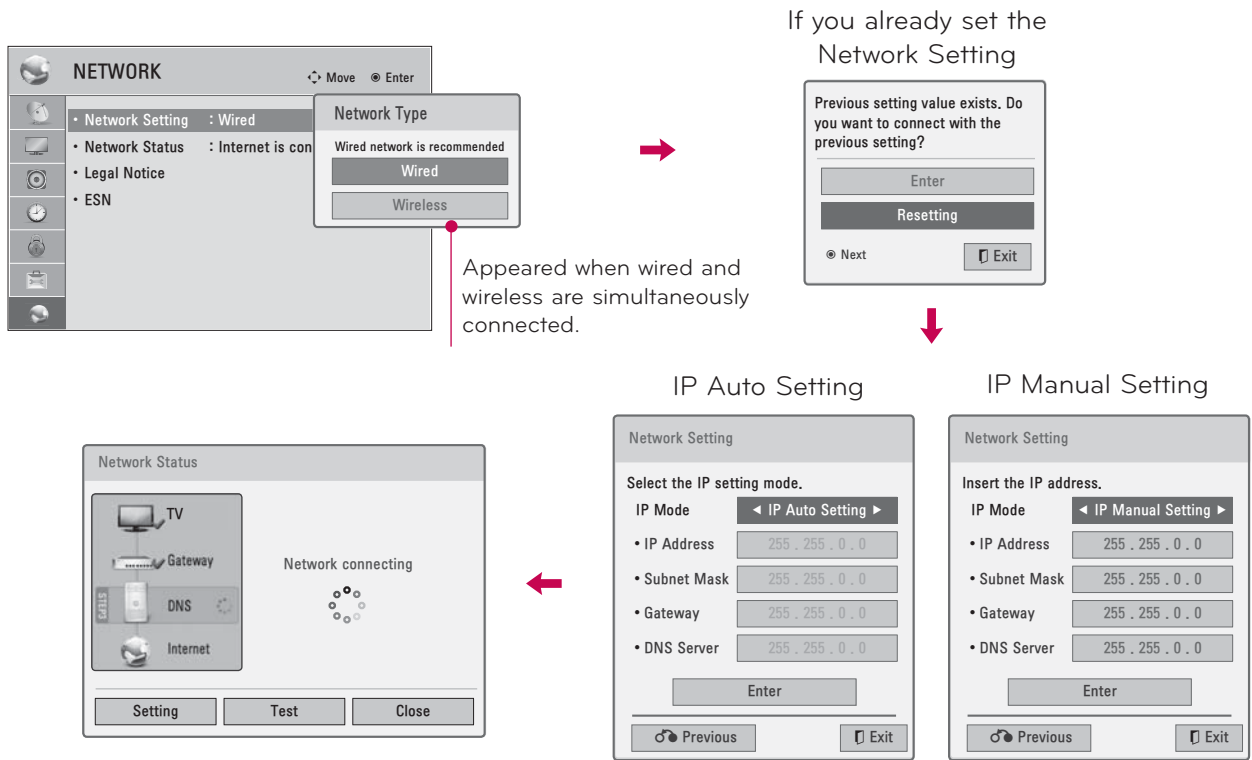

- 1 Select **NETWORK**.
- 2 Select **Network Setting**.
- 3 Select **Wired**.
- 4 If you already set Network Setting: Select **Resetting**. The new connection settings resets the current network settings.
- 5 Select **IP Auto Setting** or **IP Manual Setting**.
- 6 When Selecting **IP Manual Setting**: IP addresses will need to be input manually.

- This feature requires an always-on broadband internet connection.
- You do not need to connect to a PC to use this function.
- If **Network Setting** is not working, check your network conditions. Check the LAN cable and make sure your router has DHCP turned on if you wish to use the Auto Setting.
- If the **Network Setting** is not completed, network may not operate normally.
- **IP Auto Setting**: Select it if there is a DHCP server on the local area network (LAN) via wired connection, the TV will automatically be allocated an IP address. If you are using a router, it (normally) will have the DHCP server activated by default.
- **IP Manual Setting**: Select it if there is no DHCP server on the network and you want to set the IP address manually.

NOTE

- ▶ For more information about NETCAST setup and troubleshooting, visit <http://lgknowledgebase.com>. Search for NETCAST.
- ▶ Use a standard LAN cable with this TV. Cat5 or better with a RJ45 connector.
- ▶ Many network connection problems during set up can often be fixed by re-setting the router or modem. After connecting the player to the home network, quickly power off and/or disconnect the power cable of the home network router or cable modem. Then power on and/or connect the power cable again.
- ▶ Depending on the internet service provider (ISP), the number of devices that can receive internet service may be limited by the applicable terms of service. For details, contact your ISP.
- ▶ LG is not responsible for any malfunction of the TV and/or the internet connection feature due to communication errors/malfunctions associated with your broadband internet connection, or other connected equipment.
- ▶ LG is not responsible for problems within your internet connection.
- ▶ Some content available through the network connection may not be compatible with the TV. If you have questions about such content, please contact the producer of the content.
- ▶ You may experience undesired results if the network connection speed does not meet the requirements of the content being accessed.
- ▶ Some internet connection operations may not be possible due to certain restrictions set by the Internet service provider (ISP) supplying your broadband Internet connection.
- ▶ Any fees charged by an ISP including, without limitation, connection charges are your responsibility.
- ▶ A 10 Base-T or 100 Base-TX LAN port is required for connection to this TV. If your internet service does not allow for such a connection, you will not be able to connect the TV.
- ▶ A DSL modem is required to use DSL service and a cable modem is required to use cable modem service. Depending on the access method of and subscriber agreement with your ISP, you may not be able to use the internet connection feature contained in this TV or you may be limited to the number of devices you can connect at the same time. (If your ISP limits subscription to one device, this TV may not be allowed to connect when a PC is already connected.)
- ▶ The use of a "Router" may not be allowed or its usage may be limited depending on the policies and restrictions of your ISP. For details, contact your ISP directly.
- ▶ The wireless network operates at 2.4 GHz radio frequencies that are also used by other household devices such as cordless telephone, Bluetooth® devices, microwave oven, and can be affected by interference from them. It can be interrupted by the device using 5Ghz radio frequencies. It is same device with LG wireless media box, cordless telephone, other Wi-Fi device.
- ▶ It may decrease the service speed using Wireless network by surrounding wireless condition.
- ▶ Turn off all unused network equipment in your local home network. Some devices may generate network traffic.
- ▶ In some instances, placing the access point or wireless router higher up away from the floor may improve the reception.
- ▶ The reception quality over wireless depends on many factors such as type of the access point, distance between the TV and access point, and the location of the TV.
- ▶ When connecting internet through the wired/wireless sharing machine, it may interrupt the connection because of the use limitation and confirmation of service company.
- ▶ To connect wireless AP, an AP that supports the wireless connection is necessary, and the wireless connection function of the AP needs to be activated. Please enquire to the AP supplier for the possibility of AP wireless connections.
- ▶ Please verify the security settings of AP SSID for wireless AP connection, and enquire to the AP supplier for the AP SSID security settings.
- ▶ The TV can become slower or malfunction with wrong settings of network equipments (wired/wireless router, hub, etc). Please install correctly by referring to the manual of the equipment, and set the network.
- ▶ When AP is set to include 802.11 n, and if Encryption is designated as WEP(64/128bit) or WPA(TKIP/AES), the connection may not be possible. There may be different connection methods according to the AP manufacturers.

EXTERNAL EQUIPMENT SETUP

Wireless Network Connection

The LG Wireless LAN for Broadband/DLNA Adaptor, which is sold separately, allows the TV to connect to a wireless lan network.

The network configuration and connection method may vary depending on the equipment in use and the network environment. Refer to the setup instructions supplied with your access point or wireless router for detailed connection steps and network settings.

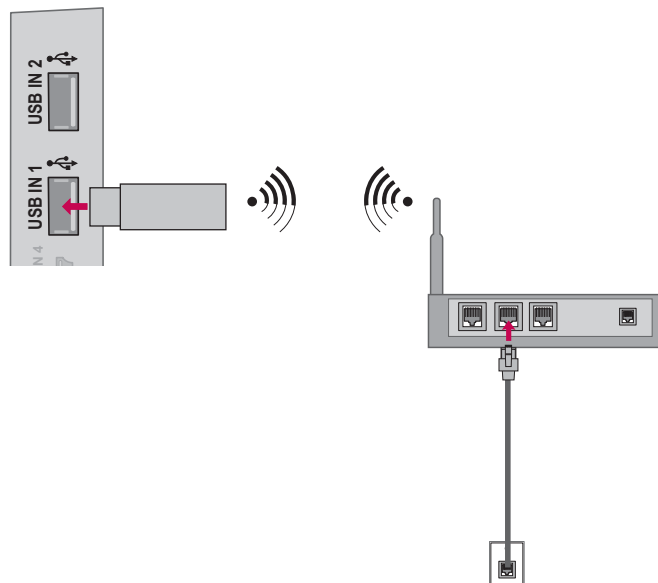

1. How to connect

- 1 Connect the "LG Wireless LAN for Broadband/DLNA Adaptor (LED LCD TV: sold separately)" to the **USB IN 1** or **2** port on the TV.

2. How to use

- Select "**Network Setting**" in the NETWORK menu.
- After connecting, you can use the NETCAST menu.

NOTE

- ▶ We recommend you use a wired network connection when available when viewing movies over the network connection.
- ▶ When the wireless port of the router is used, there may be restrictions for some functions.

Wireless Network Setup

Setting up the AP (Access Point) or the wireless router is required before connecting the TV to the network.

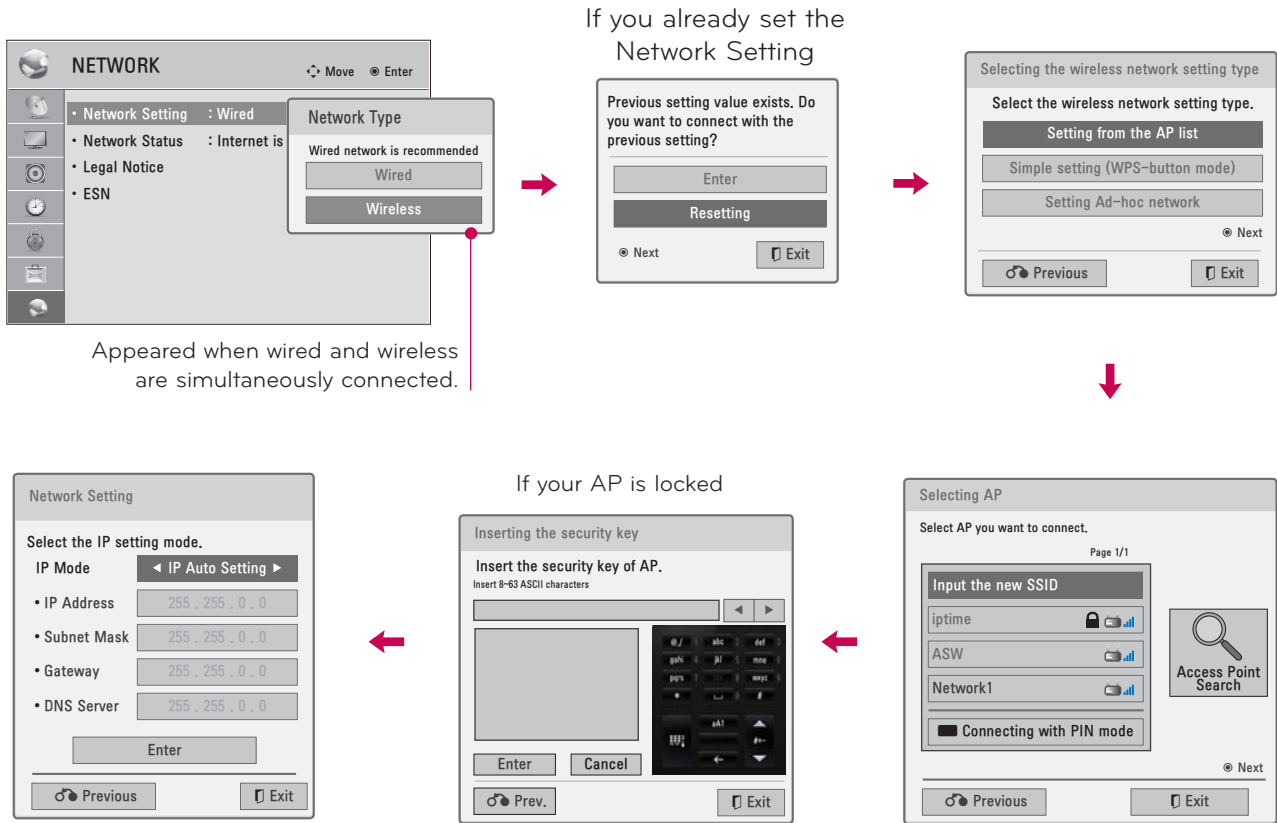

1 Select **NETWORK**.

2 Select **Network Setting**.

3 Select **Wireless**.

4 If you already set Network Setting: Select **Resetting**.
The new connection settings resets the current network settings.

5 Select **Setting from the AP list**.

6 Scan the all available AP (Access Point) or wireless routers within range and display them as a list.

7 Select an AP (Access Point) or wireless router on the list.
(If your AP is locked, insert the security key of AP).

8 Input the security key of AP.

9 Repeat step 4-5 on P.48.

EXTERNAL EQUIPMENT SETUP

When a security code is already set

PIN (Personal Identification Number)

If you want to connect the AP (Access Point) or router with PIN, use this feature.

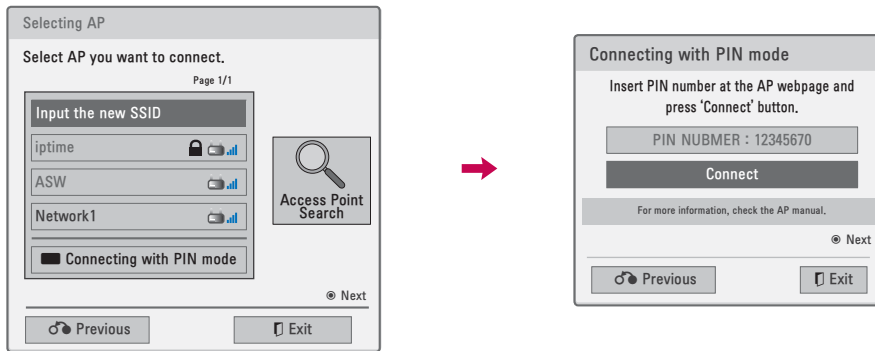

1 Repeat step 1-6 on P.51.

2  Connect the access point with **PIN** mode.

3 You can see the Network ID and Security Key on your TV screen.
Enter the PIN number to your device.

4  Select **Connect**.

5 Repeat step 4-5 on P.48.

■ PIN number is the unique 8 digit number of the dongle.

Simple setting (WPS-button mode)

Use the simple setting if your access point or wireless router supports a PIN or WPS (Wi-Fi Protected Setup)

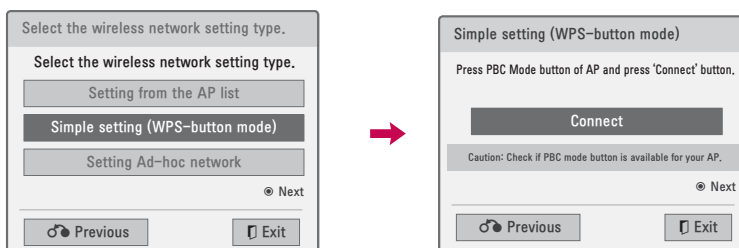

1 Repeat step 1-4 on P.51.

2   Select **Simple setting (WPS-button mode)**.

3  Select **Connect**.

4 Repeat step 4-5 on P.48.

AD-hoc Mode

The below settings are only for connecting directly to a PC.

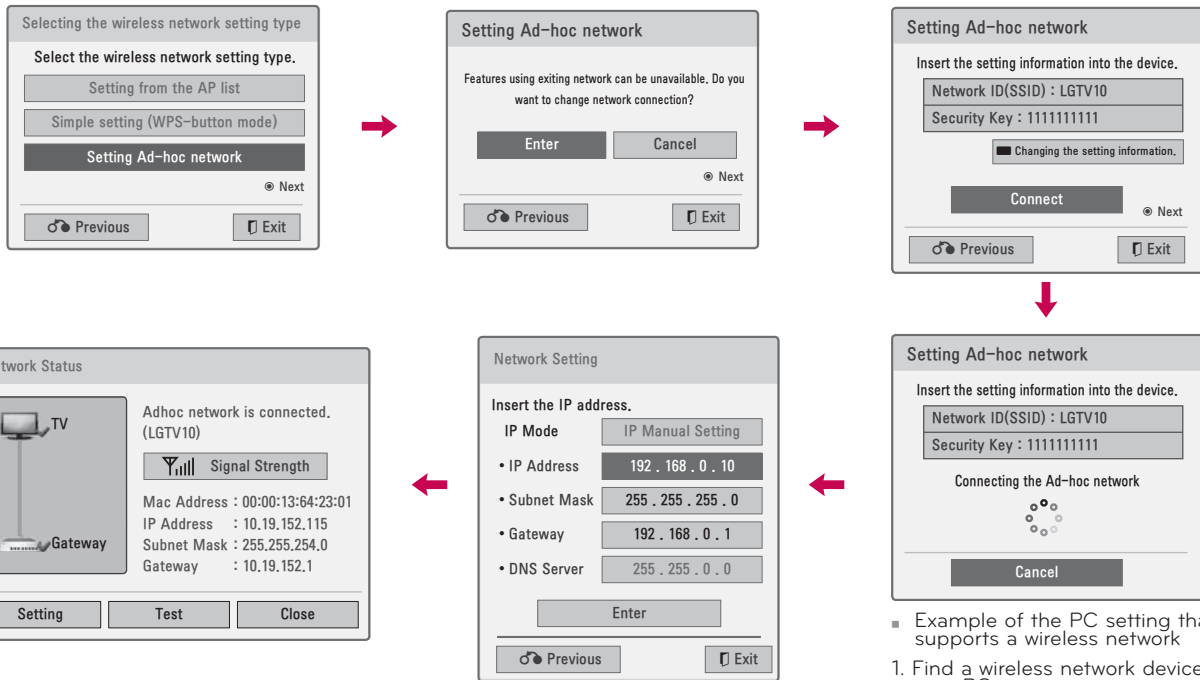

This is the same as connecting two PCs with a cross-over cable.



- PC Setting
Internet Protocol(TCP/IP) of PC needs to be set manually.
IP address, Subnet Mask, and default Gateway can be set with your own discretion.
i.e) IP address: 192.168.0.1 / Subnet Mask: 255.255.255.0 / default Gateway: 192.168.0.10
- TV Setting
Verify IP address and gateway of PC.
Input Gateway address of PC to IP Address, and IP Address of PC to Gateway, and select **Enter**.
i.e) IP address: 192.168.0.10 / Subnet Mask: 255.255.255.0 / default Gateway: 192.168.0.1

- Example of the PC setting that supports a wireless network
1. Find a wireless network device in your PC.
 2. Select LGTV10 that appears in the list. (Select the same name as the network ID that appears on your TV screen.)
 3. Type 1111111111 in the Inserting the security key dialog. (Type the security key that appears on your TV screen.)

1 Repeat step 1-3 on P.51.

2   Select **Setting AD-hoc network**.



3    Select **Enter**.

4  Select **Connect** to connect Ad-hoc network.

You can see the Network ID and Security Key on your TV screen.
Enter this Network ID and Security Key to your device.

If a network may not operate, change the setting information using the RED button.

5   Insert the IP address.

6   Network setting is completed. Select **Close**.

EXTERNAL EQUIPMENT SETUP

Network Status

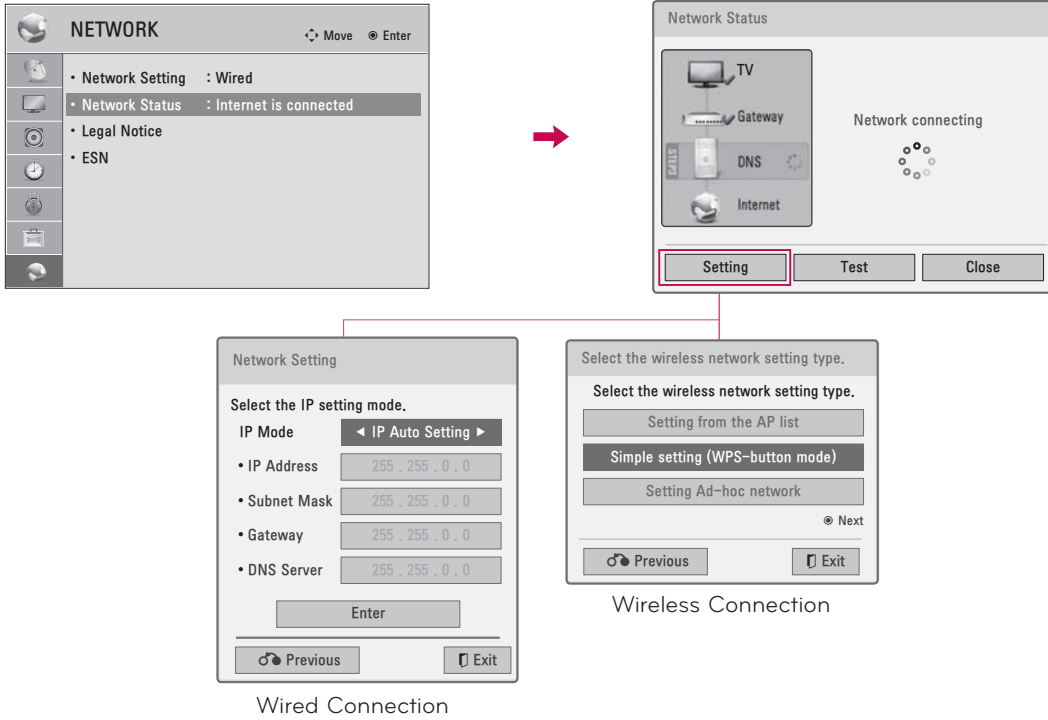

- 1 Select **NETWORK**.
- 2 Select **Network Status**.
- 3 Check the newtwork status.

- **Setting:** Return to the network setting menu or wireless network setting type menu.
- **Test:** Test the current network status after setting the network.
- **Close:** Return to the previous menu.

WATCHING TV / CHANNEL CONTROL

REMOTE CONTROL FUNCTIONS

When using the remote control, aim it at the remote control sensor on the TV.

The remote control may differ from the images below.

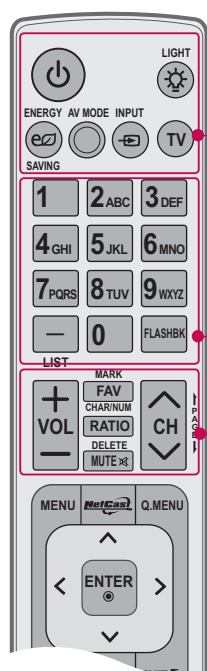

- POWER** Turns the TV on from standby or off to standby.
- LIGHT** Illuminates the remote control buttons.
- ENERGY SAVING** Adjusts the Energy Saving setting. ▶p.132
- AV MODE** Toggles through preset Video and Audio modes. ▶p.85
- INPUT** Rotates through inputs. Also switches the TV on from standby.
- TV** Returns to the last TV channel.

- NUMBER button**
 - (DASH)** Used to enter a program number for multiple program channels such as 2-1, 2-2, etc.
- LIST** Displays the channel table.
- FLASHBK** Tunes to the last channel viewed.

- VOLUME UP/DOWN** Adjusts the volume.
- FAV** Set up desired favorite channels list.
- MARK** Select the input to apply the Picture Wizard settings. ▶p.131
Use to mark or unmark a photo/music/movie. ▶p.105, 110, 116
- RATIO** Changes the aspect ratio. ▶p.128
- 3D** Used for viewing 3D video. ▶p.94
- CHAR/NUM** Shifts the Character or Number in internet settings.
- MUTE** Switches the sound on or off.
- DELETE** Delete the character or number on the screen.
- CHANNEL UP/DOWN** Changes the channel.
- PAGE UP/DOWN** Moves from one full set of screen information to the next one.

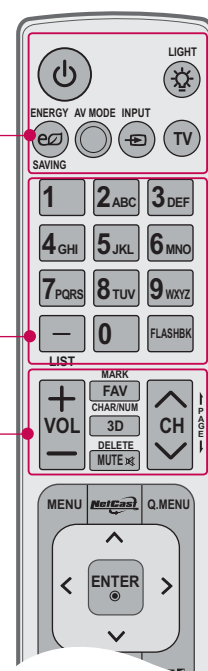

WATCHING TV / CHANNEL CONTROL

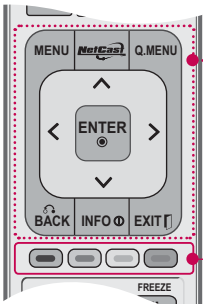
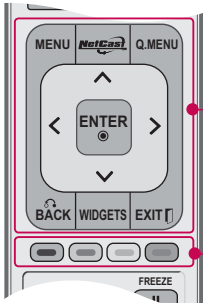

- MENU** Displays the main menu or clears all on-screen displays and return to TV viewing.
- NETCAST** Select the desired NETCAST menu source. ▶ **p.123**
- Q.MENU** Opens the list of Quick Menu options. ▶ **p.66**
- THUMBSTICK (Up/Down/Left Right/ENTER)** Navigates the on-screen menus and adjusts the system settings to your preference.
- BACK** Allows the user to move return one step in an interactive application or other user interaction function.
- WIDGETS** WIDGETS for showing or hiding the Yahoo! Dock and accessing the Yahoo! TV Widgets user experience.
- INFO** Displays channel information at the bottom of the screen. ▶ **p.78**
- EXIT** Clears all on-screen displays and return to TV viewing.

- COLOR BUTTON** Access special functions in some menus.
- L/R SELECT** Used for viewing 3D video. ▶ **p.95**

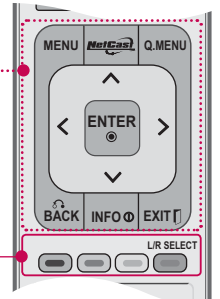
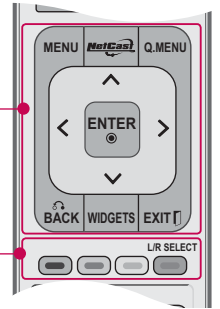



USB, SIMPLINK Control buttons

- Controls MY MEDIA menu (Movie List, Photo List, Music List)
- Controls the SIMPLINK compatible devices.

FREEZE (For Plasma TV)

Pause the present picture at the screen. (It doesn't work at USB Mode and Simplink.)

The TV returns to normal viewing automatically if no signal is received or no operation is performed for 5 minutes. If you keep the screen in Freeze condition, the residual image can exist.

SIMPLINK

See a list of AV devices connected to TV.

When you toggle this button, the SIMPLINK menu appears at the screen.

▶ p.90

RATIO

Changes the aspect ratio. ▶ p.128

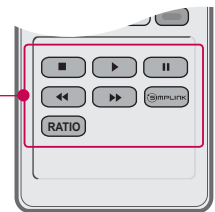
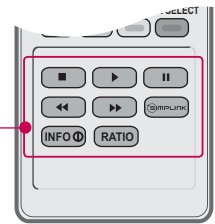

Installing Batteries

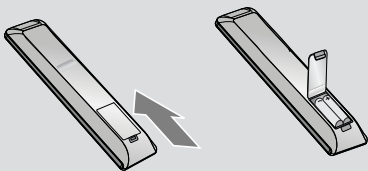

- Open the battery compartment cover on the back side and install the batteries matching correct polarity.
- Install two 1.5V AAA batteries. Don't mix old or used batteries with new ones.
- Close cover.

WATCHING TV / CHANNEL CONTROL

MAGIC MOTION REMOTE CONTROL FUNCTIONS

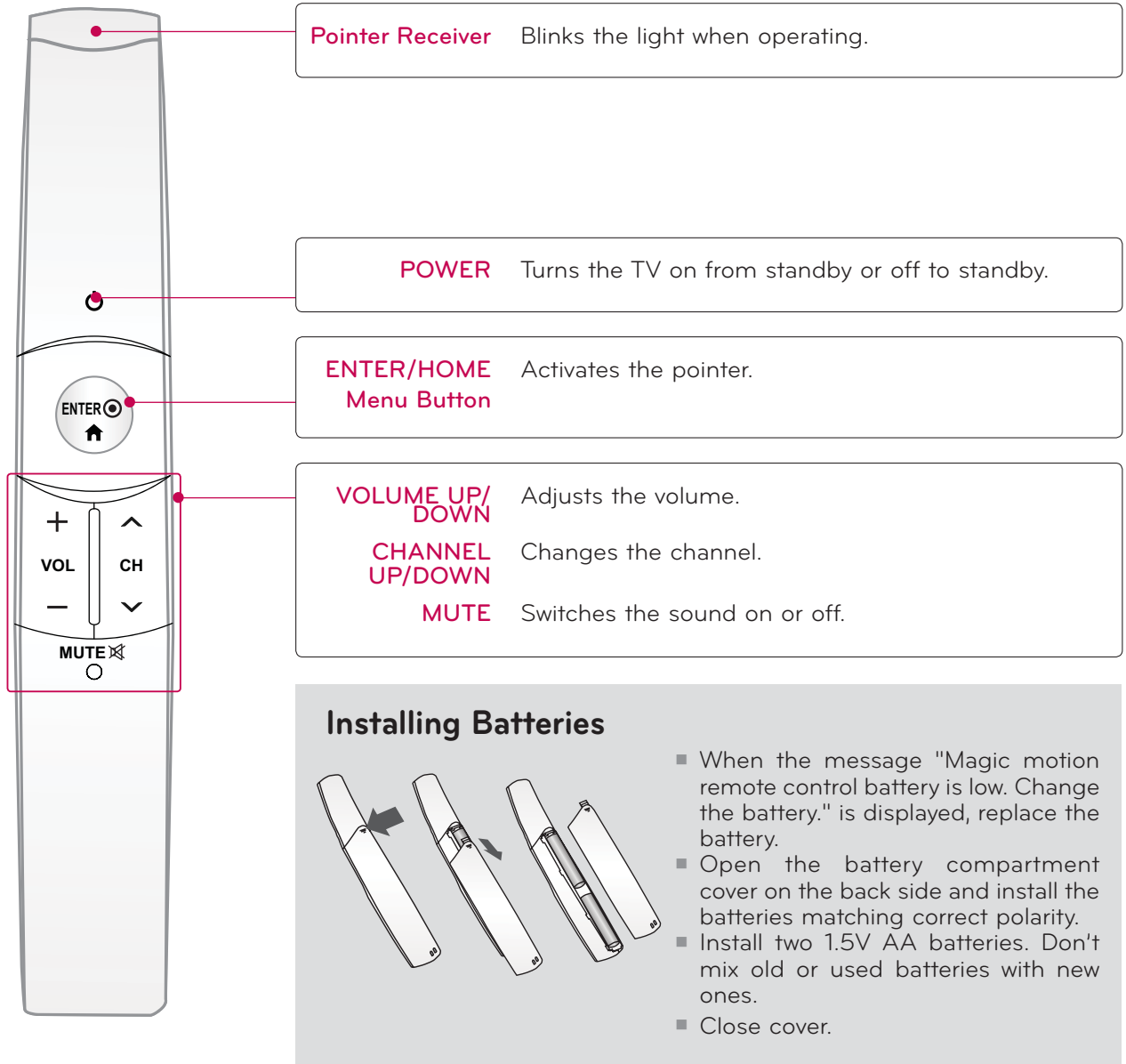

Pointer Receiver Blinks the light when operating.

POWER Turns the TV on from standby or off to standby.

ENTER/HOME Menu Button Activates the pointer.

VOLUME UP/DOWN Adjusts the volume.
CHANNEL UP/DOWN Changes the channel.
MUTE Switches the sound on or off.

Installing Batteries

- When the message "Magic motion remote control battery is low. Change the battery." is displayed, replace the battery.
- Open the battery compartment cover on the back side and install the batteries matching correct polarity.
- Install two 1.5V AA batteries. Don't mix old or used batteries with new ones.
- Close cover.

RF Specification of the Magic Motion Remote Control

The Magic Motion Remote Control communicates with your TV by using a 2.4 GHz bandwidth radio frequency (RF).

- Output: 1 dBm or lower
- Maximum Communication Distance: 10 m (30 ft) in an open space
- Bandwidth: 2.4 GHz (2.4035 GHz - 2.4783 GHz)
- Transfer Rate: 250 kbps

Magic Motion Remote Control Registration

The Magic Motion Remote Control operates by pairing with your TV.

Register the Magic Motion Remote Control after purchasing the TV.

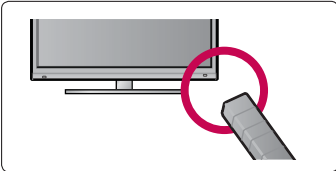

How to register the Magic Motion Remote Control

To register the Remote Control, press the **ENTER** button on the Remote Control while aiming it at your TV.



How to Re-register the Magic Motion Remote Control after Registration Failure

Reset the remote control by pressing and holding both the **ENTER** and **MUTE** buttons for 5 seconds. (Once the reset is complete, the light on the Pointer RF Receiver blinks.) Then repeat the above procedure to register the remote control.

How to use Magic Motion Remote Control



1 Press this button if there is no pointer on your TV screen. The pointer will then appear on the screen.

If the pointer has not been used for a certain period of time, it will disappear.

2

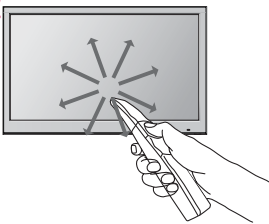

You can move the pointer by aiming the Pointer Receiver of the remote control at your TV then move it left, right, up or down.

If the pointer does not work properly after clicking the ENTER button, leave the remote control for 10 seconds then use it again.

Precautions to Take when Using the Magic Motion Remote Control

- Use the remote control within the maximum communication distance (10 m). Using the remote control beyond this distance, or with an object obstructing it, may cause a communication failure.
- A communication failure may occur due to nearby devices. Electrical devices such as a microwave oven or wireless LAN product may cause interference, as this will use the same bandwidth (2.4 GHz) as the Magic Motion Remote Control.
- The Magic Motion Remote Control may be damaged or may malfunction if it is dropped or receives a heavy impact.
- When playing a game using the Magic Motion Remote Control, hold it securely by wrapping its strap around your wrist and adjusting the length with the adjustable ring.
- Take care not to bump into nearby furniture or other people when using the Magic Motion Remote Control.
- Manufacturer and installer cannot provide service related to human safety as the applicable wireless device has possibility of electric wave interference.

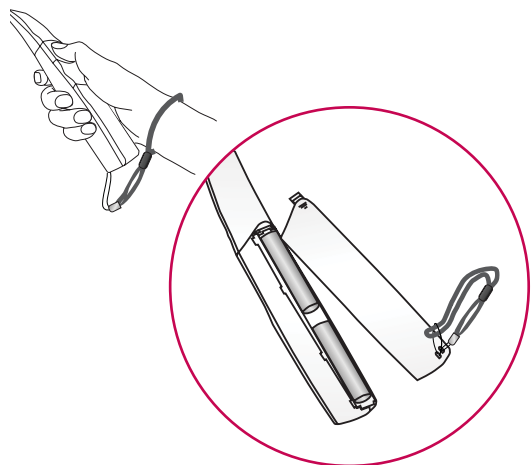

WATCHING TV / CHANNEL CONTROL

Pointer Menu Options

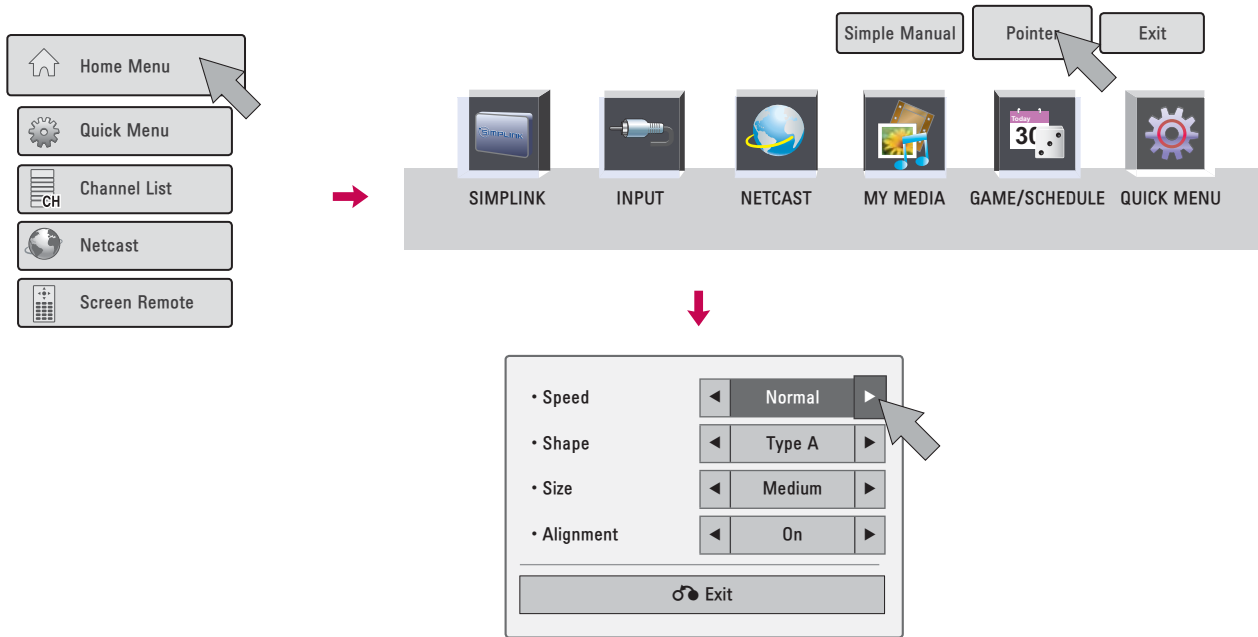

- 1 Select **Home Menu**.
- 2 Select **Pointer**.
- 3 Make appropriate adjustments.
- 4 Select **Exit**.

- **Speed:** Changed the pointer speed.
- **Shape:** Select the pointer shape.
- **Size:** Changes the pointer size.
- **Alignment:** When Alignment is On, you can easily align the remote control's direction with the pointer on your TV screen by shaking the remote control left and right. Then, the pointer automatically moves to the center of the screen.