



OWNER'S MANUAL LED LCD TV / LCD TV PLASMA TV

Please read this manual carefully before operating your set and retain it for future reference.

| LCD TV MODELS | LED LCD TV MODELS | PLASMA TV MODELS |
|-----------------|-------------------|------------------|
| 32LD550 47LD650 | 32LE5400 42LE5500 | 50PK750 50PZ540 |
| 42LD550 55LD650 | 42LE5400 47LE5500 | 60PK750 60PZ540 |
| 46LD550 | 47LE5400 55LE5500 | 50PZ750 50PZ550 |
| 52LD550 | 55LE5400 42LE7500 | 60PZ750 60PZ550 |
| 60LD550 | 42LE5350 47LE7500 | |
| | 47LE5350 55LE7500 | |

The model and serial number of the TV is located on the back and/or one side of the TV. Record it below should you ever need service.

MODEL _____

SERIAL _____

P/NO : SAC34134203 (1010-REV09)

www.lg.com

WARNING / CAUTION



WARNING / CAUTION
RISK OF ELECTRIC SHOCK
DO NOT OPEN



TO REDUCE THE RISK OF ELECTRIC SHOCK DO NOT REMOVE COVER (OR BACK). NO USER SERVICEABLE PARTS INSIDE. REFER TO QUALIFIED SERVICE PERSONNEL.



The lightning flash with arrowhead symbol, within an equilateral triangle, is intended to alert the user to the presence of uninsulated "dangerous voltage" within the product's enclosure that may be of sufficient magnitude to constitute a risk of electric shock to persons.



The exclamation point within an equilateral triangle is intended to alert the user to the presence of important operating and maintenance (servicing) instructions in the literature accompanying the appliance.

WARNING/CAUTION

TO REDUCE THE RISK OF FIRE AND ELECTRIC SHOCK, DO NOT EXPOSE THIS PRODUCT TO RAIN OR MOISTURE.

NOTE TO CABLE/TV INSTALLER

This reminder is provided to call the CATV system installer's attention to Article 820-40 of the National Electric Code (U.S.A.). The code provides guidelines for proper grounding and, in particular, specifies that the cable ground shall be connected to the grounding system of the building, as close to the point of the cable entry as practical.

WARNING / CAUTION

To prevent fire or shock hazards, do not expose this product to rain or moisture.

FCC Notice

Class B digital device

This equipment has been tested and found to comply with the limits for a Class B digital device, pursuant to Part 15 of the FCC Rules. These limits are designed to provide reasonable protection against harmful interference in a residential installation. This equipment generates, uses and can radiate radio frequency energy and, if not installed and used in accordance with the instructions, may cause harmful interference to radio communications. However, there is no guarantee that interference will not occur in a particular installation. If this equipment does cause harmful interference to radio or television reception, which can be determined by turning the equipment off and on, the user is encouraged to try to correct the interference by one or more of the following measures:

- Reorient or relocate the receiving antenna.
- Increase the separation between the equipment and receiver.
- Connect the equipment to an outlet on a circuit different from that to which the receiver is connected.
- Consult the dealer or an experienced radio/TV technician for help.

This device complies with part 15 of the FCC Rules.

Operation is subject to the following two conditions: (1) This device may not cause (harmful) interference, and (2) this device must accept any interference received, including interference that may cause undesired operation (of the device).

Any changes or modifications in construction of this device which are not expressly approved by the party responsible for compliance could void the user's authority to operate the equipment.

CAUTION

Do not attempt to modify this product in any way without written authorization from LG Electronics.

Unauthorized modification could void the user's authority to operate this product.

SAFETY INSTRUCTIONS

IMPORTANT SAFETY INSTRUCTIONS

Read these instructions.

Keep these instructions.

Heed all warnings.

Follow all instructions.



- 1** Do not use this apparatus near water.



- 2** Clean only with dry cloth.



- 3** Do not block any ventilation openings. Install in accordance with the manufacturer's instructions.



- 4** Do not install near any heat sources such as radiators, heat registers, stoves, or other apparatus (including amplifiers) that produce heat.



- 5** Do not defeat the safety purpose of the polarized or grounding-type plug. A polarized plug has two blades with one wider than the other. A grounding type plug has two blades and a third grounding prong. The wide blade or the third prong are provided for your safety. If the provided plug does not fit into your outlet, consult an electrician for replacement of the obsolete outlet.



- 6** Protect the power cord from being walked on or pinched particularly at plugs, convenience receptacles, and the point where they exit from the apparatus.



- 7** Only use attachments/accessories specified by the manufacturer.



- 8** Use only with the cart, stand, tripod, bracket, or table specified by the manufacturer, or sold with the apparatus. When a cart is used, use caution when moving the cart/apparatus combination to avoid injury from tip-over.



- 9** Unplug this apparatus during lightning storms or when unused for long periods of time.

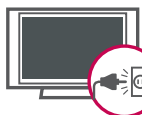

- 10** Refer all servicing to qualified service personnel. Servicing is required when the apparatus has been damaged in any way, such as power-supply cord or plug is damaged, liquid has been spilled or objects have fallen into the apparatus, the apparatus has been exposed to rain or moisture, does not operate normally, or has been dropped.



- 11** Never touch this apparatus or antenna during a thunder or lightning storm.

- 12** When mounting a TV on the wall, make sure not to install the TV by the hanging power and signal cables on the back of the TV.

- 13** Do not allow an impact shock or any objects to fall into the product, and do not drop onto the screen with something.

- 14** CAUTION concerning the Power Cord: It is recommended that appliances be placed upon a dedicated circuit; that is, a single outlet circuit which powers only that appliance and has no additional outlets or branch circuits. Check the specification page of this owner's manual to be certain. Do not connect too many appliances to the same AC power outlet as this could result in fire or electric shock.

Do not overload wall outlets. Overloaded wall outlets, loose or damaged wall outlets, extension cords, frayed power cords, or damaged or cracked wire insulation are dangerous. Any of these conditions could result in electric shock or fire. Periodically examine the cord of your appliance, and if its appearance indicates damage or deterioration, unplug it, discontinue use of the appliance, and have the cord replaced with an exact replacement part by an authorized servicer. Protect the power cord from physical or mechanical abuse, such as being twisted, kinked, pinched, closed in a door, or walked upon. Pay particular attention to plugs, wall outlets, and the point where the cord exits the appliance.

Do not make the TV with the power cord plugged in. Do not use a damaged or loose power cord. Be sure do grasp the plug when unplugging the power cord. Do not pull on the power cord to unplug the TV.



SAFETY INSTRUCTIONS

15 **WARNING** - To reduce the risk of fire or electrical shock, do not expose this product to rain, moisture or other liquids. Do not touch the TV with wet hands. Do not install this product near flammable objects such as gasoline or candles or expose the TV to direct air conditioning.



16 Do not expose to dripping or splashing and do not place objects filled with liquids, such as vases, cups, etc. on or over the apparatus (e.g. on shelves above the unit).



17 **GROUNDING**
Ensure that you connect the earth ground wire to prevent possible electric shock (i.e. a TV with a three-prong grounded AC plug must be connected to a three-prong grounded AC outlet). If grounding methods are not possible, have a qualified electrician install a separate circuit breaker.

Do not try to ground the unit by connecting it to telephone wires, lightning rods, or gas pipes.

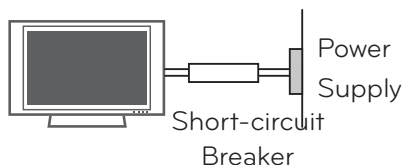

18 **DISCONNECTING DEVICE FROM MAINS**
Mains plug is the disconnecting device. The plug must remain readily operable.

19 As long as this unit is connected to the AC wall outlet, it is not disconnected from the AC power source even if you turn off this unit by SWITCH.

20 **Cleaning**
When cleaning, unplug the power cord and scrub gently with a soft cloth to prevent scratching. Do not spray water or other liquids directly on the TV as electric shock may occur. Do not clean with chemicals such as alcohol, thinners or benzene.

21 **Moving**
Make sure the product is turned off, unplugged and all cables have been removed. It may take 2 or more people to carry larger TVs. Do not press against or put stress on the front panel of the TV.

22 **ANTENNAS**
Outdoor antenna grounding
If an outdoor antenna is installed, follow the precautions below. An outdoor antenna system should not be located in the vicinity of overhead power lines or other electric light or power circuits, or where it can come in contact with such power lines or circuits as death or serious injury can occur.

Be sure the antenna system is grounded so as to provide some protection against voltage surges and built-up static charges.

Section 810 of the National Electrical Code (NEC) in the U.S.A. provides information with respect to proper grounding of the mast and supporting structure, grounding of the lead-in wire to an antenna discharge unit, size of grounding conductors, location of antenna discharge unit, connection to grounding electrodes and requirements for the grounding electrode.

Antenna grounding according to the National Electrical Code, ANSI/NFPA 70

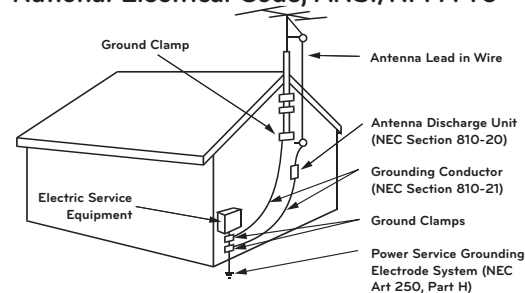

NEC: National Electrical Code

23 **Ventilation**
Install your TV where there is proper ventilation. Do not install in a confined space such as a bookcase. Do not cover the product with cloth or other materials (e.g.) plastic while plugged in. Do not install in excessively dusty places.

24 Take care not to touch the ventilation openings. When watching the TV for a long period, the ventilation openings may become hot.

25 If you smell smoke or other odors coming from the TV, unplug the power cord contact and authorized service center.

26 Do not press strongly upon the panel with hand or sharp object such as nail, pencil or pen, or make a scratch on it.



27 Keep the product away from direct sunlight.

28 Dot Defect

The Plasma or LCD panel is a high technology product with resolution of two million to six million pixels. In a very few cases, you could see fine dots on the screen while you're viewing the TV. Those dots are deactivated pixels and do not affect the performance and reliability of the TV.

29 Generated Sound

"Cracking" noise: A cracking noise that occurs when watching or turning off the TV is generated by plastic thermal contraction due to temperature and humidity. This noise is common for products where thermal deformation is required.

Electrical circuit humming/panel buzzing: A low level noise is generated from a high-speed switching circuit, which supplies a large amount of current to operate a product. It varies depending on the product.

This generated sound does not affect the performance and reliability of the product.

30 For LED LCD TV/LCD TV

If the TV feels cold to the touch, there may be a small "flicker" when it is turned on. This is normal, there is nothing wrong with TV.

Some minute dot defects may be visible on the screen, appearing as tiny red, green, or blue spots. However, they have no adverse effect on the monitor's performance.

Avoid touching the LCD screen or holding your finger(s) against it for long periods of time. Doing so may produce some temporary distortion effects on the screen.

31 Viewing 3D Imaging (For 3D TV)

- ▶ When viewing 3D imaging, watch the TV from an effective viewing angle and within the appropriate distance. If you exceed this viewing angle or distance, you may not be able to view the 3D imaging. Furthermore, the 3D imaging may not display if it is viewed while you are lying down.
- ▶ If you watch the 3D imaging too closely or for a long period of time, it may harm your eyesight.
- ▶ Watching the TV or playing video games that incorporate 3D imaging with the 3D glasses for a long period of time can cause drowsiness, headaches or fatigue to you and/or your eyes. If you have a headache, or otherwise feel fatigued or drowsy, stop watching the TV and take a rest.
- ▶ Pregnant woman, seniors, persons with heart problems or persons who experience frequent drowsiness should refrain from watching 3D TV.
- ▶ Some 3D imaging may cause you to duck or dodge the image displayed in the video. Therefore, it is best if you do not watch 3D TV near fragile objects or near any objects that can be knocked over easily.
- ▶ Please prevent children under the age of 5 from watching 3D TV. It may affect their vision development.
- ▶ Warning for photosensitization seizure: Some viewers may experience a seizure or epilepsy when exposed to certain factors, including flashing lights or images in TV or video games. If you or anybody from your family has a history of epilepsy or seizure, please consult with your doctor before watching 3D TV.

SAFETY INSTRUCTIONS

Also certain symptoms can occur in unspecified conditions without any previous history. If you experience any of the following symptoms, immediately stop watching the 3D imaging and consult a doctor: dizziness or lightheadedness, visual transition or altered vision, visual or facial instability, such as eye or muscle twitching, unconscious action, convulsion, loss of conscience, confusion or disorientation, loss of directional sense, cramps, or nausea. Parents should monitor their children, including teenagers, for these symptoms as they may be more sensitive to the effects of watching 3D TV.

Risk of photosensitization seizure can be reduced with the following actions.

- Take frequent breaks from watching 3D TV.
- For those who have vision that is different in each eye, they should watch the TV after taking vision correction measures.
- Watch the TV so that your eyes are on the same level as the 3D screen and refrain from sitting too closely to the TV
- Do not watch the 3D imaging when tired or sick, and avoid watching the 3D imaging for a long period of time.
- Do not wear the 3D glasses for any other purpose than viewing 3D imaging on a 3D TV.
- Some viewers may feel disoriented after watching 3D TV. Therefore, after you watch 3D TV, take a moment to regain awareness of your situation before moving.

ON DISPOSAL

(Only Hg lamp used LCD TV)

The fluorescent lamp used in this product contains a small amount of mercury. Do not dispose of this product with general household waste. Disposal of this product must be carried out in accordance to the regulations of your local authority.

CONTENTS

| | |
|----------------------------------|---|
| WARNING / CAUTION | 2 |
| SAFETY INSTRUCTIONS | 3 |
| CONTENTS | 6 |
| FEATURE OF THIS TV | 9 |

PREPARATION

| | |
|---|----|
| Accessories | 10 |
| Optional Extras | 11 |
| Front Panel Information | 12 |
| Back Panel Information | 17 |
| Stand Instructions | 20 |
| VESA Wall Mounting | 26 |
| Cable Management | 28 |
| Desktop Pedestal Installation | 31 |
| Swivel Stand | 31 |
| Attaching the TV to a Desk | 32 |
| Kensington Security System | 32 |
| Securing the TV to the wall to prevent falling when the tv is used on a stand | 33 |
| Antenna or Cable Connection | 34 |

EXTERNAL EQUIPMENT SETUP

| | |
|--|----|
| HD Receiver Setup | 35 |
| DVD SETUP | 39 |
| VCR SETUP | 42 |
| Other A/V Source Setup | 44 |
| USB Connection | 45 |
| Headphone Setup | 46 |
| Audio Out Connection | 47 |
| External Equipment Wireless Connection (Optional Extras) | 48 |
| PC Setup | 49 |
| Network Setup | 55 |

WATCHING TV / CHANNEL CONTROL

| | |
|--------------------------------|----|
| Remote Control Functions | 63 |
| Turning on the TV | 66 |
| Channel Selection | 66 |
| Volume Adjustment | 66 |
| Initial Setting | 67 |

| | |
|--|----|
| On-Screen Menus Selection | 69 |
| Quick Menu | 71 |
| Customer Support | |
| - Software Update | 72 |
| - Picture Test/Sound Test | 73 |
| - Product/Service Info | 74 |
| - Network Test | 74 |
| Simple Manual | 75 |
| Channel Setup | |
| - Auto Scan (Auto Tuning) | 76 |
| - Add/Delete Channel (Manual Tuning) | 77 |
| - Channel Editing | 78 |
| Favorite Channel Setup | 79 |
| Favorite Channel List | 79 |
| Channel List | 80 |
| Channel Information | 81 |
| Channel Brief Information | 82 |
| Input List | 83 |
| Input Label | 84 |
| Reset to Factory Default (Initial Setting) | 85 |
| Mode Setting | 86 |
| Demo Mode | 87 |
| AV Mode | 88 |
| Game | 89 |
| SIMPLINK | 90 |

3D VIDEO

| | |
|----------------|----|
| 3D Video | 92 |
|----------------|----|

MY MEDIA

| | |
|------------------------------|-----|
| Entry Mode | 96 |
| Connection Method | 97 |
| Movie list | 102 |
| Photo list | 109 |
| Music list | 115 |
| DivX Registration Code | 120 |
| Deactivation | 121 |

NETWORK

| | |
|--------------------|-----|
| Legal Notice | 122 |
|--------------------|-----|

NETCAST

| | |
|-------------------|-----|
| Netcast Menu..... | 123 |
| YOUTUBE..... | 124 |
| PICASA..... | 126 |

PICTURE CONTROL

| | |
|---|-----|
| Picture Size (Aspect Ratio) Control..... | 128 |
| Picture Wizard..... | 130 |
|  Energy Saving | 132 |
| Preset Picture Settings (Picture Mode)..... | 133 |
| Manual Picture Adjustment - User Mode | 134 |
| Picture Improvement Technology (Advanced Control) | 135 |
| Expert Picture control..... | 136 |
| Picture Reset..... | 139 |
| TruMotion | 140 |
| LED Local Dimming | 141 |
| Power Indicator | 142 |
| Image Sticking Minimization (ISM) Method . | 143 |

SOUND & LANGUAGE CONTROL

| | |
|---|-----|
| Auto Volume..... | 144 |
| Clear Voice II | 145 |
| Balance | 146 |
| Preset Sound Settings (Sound Mode) | 147 |
| Sound Setting Adjustment - User Mode. | 148 |
| Audio Reset..... | 149 |
| TV Speakers On/Off Setup | 150 |
| Stereo/SAP Broadcast Setup | 151 |
| Audio Language | 152 |
| On-screen Menus Language Selection.... | 153 |
| Caption Mode | |
| - Analog Broadcasting System Captions. | 154 |
| - Digital Broadcasting System Captions... | 155 |
| - Caption Option..... | 156 |

TIME SETTING

| | |
|--------------------------------|-----|
| Clock Setting | |
| - Auto Clock Setup | 157 |
| - Manual Clock Setup | 158 |
| Auto On/Off Time Setting | 159 |
| Sleep Timer Setting | 160 |

PARENTAL CONTROL / RATINGS

| | |
|----------------------------------|-----|
| Set Password & Lock System | |
| - Setting up Your Password | 161 |
| - Set Password | 162 |
| - Lock System..... | 163 |
| Channel Blocking..... | 164 |
| Movie & TV Rating | 165 |
| Downloadable Rating..... | 170 |
| External Input Blocking | 171 |
| Key Lock | 172 |

APPENDIX

| | |
|--|-----|
| Troubleshooting..... | 173 |
| Maintenance | 176 |
| Product Specifications | 177 |
| IR Codes..... | 182 |
| External Control Through RS-232C | 184 |
| Open Source License..... | 190 |

FEATURE OF THIS TV

- Some of these features are not available on all models.



High-definition television. High-resolution digital television broadcast and playback system composed of roughly a million or more pixels, 16:9 aspect-ratio screens, and AC3 digital audio. A subset of digital television, HDTV formats include 1080p, 1080i, and 720p resolutions.



Manufactured under license from Dolby Laboratories. "Dolby" and the double-D symbol are trademarks of Dolby Laboratories.



HDMI, the HDMI logo and High-Definition Multimedia Interface are trademarks or registered trademarks of HDMI Licensing LLC."



ABOUT DIVX VIDEO: DivX® is a digital video format created by DivX, Inc. This is an official DivX Certified device that plays DivX video. Visit www.divx.com for more information and software tools to convert your files into DivX video.

ABOUT DIVX VIDEO-ON-DEMAND: This DivX Certified® device must be registered in order to play DivX Video-on-Demand (VOD) content. To generate the registration code, locate the DivX VOD section in the device setup menu. Go to vod.divx.com with this code to complete the registration process and learn more about DivX VOD.

"DivX Certified® to play DivX® video up to HD 1080p, including premium content"

"DivX®, DivX Certified® and associated logos are registered trademarks of DivX, Inc. and are used under license."

Pat. 7,295,673; 7,460,668; 7,515,710; 7,519,274



This TV contains the detailed calibrations necessary for professional certification by the Imaging Science Foundation. The resulting ISF "day" and "night" modes will then be accessible by the user to experience the best their LG HDTV has to offer.

Sophisticated and detailed calibrations can be made through the ISFccc mode. Detailed calibration requires a licensed technician.

Please contact your local dealer to inquire about an ISF certified technician.



THX (Thomlinson Holman's Experiment) is an audio and video certification standard established by George Lucas and Thomlinson. A THX certified display guarantees screen quality that exceeds the display standard specification in both hardware and software.



View videos and photos and listen to music on your TV through USB 2.0 ('videos' dependent on model).



Displays HDTV programs in full 1920 x 1080p resolution for a more detailed picture.



IMPORTANT INFORMATION TO PREVENT "IMAGE BURN / BURN-IN" ON YOUR TV SCREEN

- When a fixed image (e.g. logos, screen menus, video game, and computer display) is displayed on the TV for an extended period, it can become permanently imprinted on the screen. This phenomenon is known as "image burn" or "burn-in." Image burn is not covered under the manufacturer's warranty.
- In order to prevent image burn, avoid displaying a fixed image on your TV screen for a prolonged period (2 or more hours for LCD, 1 or more hours for Plasma).
- Image burn can also occur on the letter-boxed areas of your TV if you use the 4:3 aspect ratio setting for an extended period.

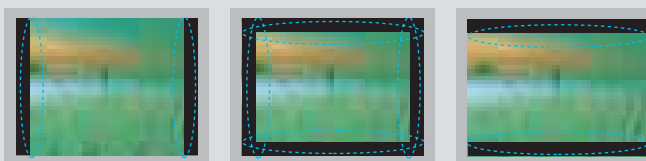

PREPARATION

ACCESSORIES

PREPARATION

Ensure that the following accessories are included with your TV. If an accessory is missing, please contact the dealer where you purchased the TV.

The accessories included may differ from the images below.



Owner's Manual

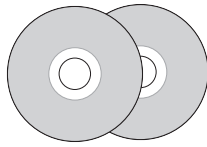

CD Manual,
Nero MediaHome 4
Essentials CD

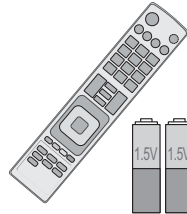

Remote Control,
Batteries (AAA)

Not included with all models

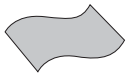

Polishing Cloth

- * Wipe spots on the exterior only with the polishing cloth.
- * Do not wipe roughly when removing stains. Excessive pressure may cause scratches or discoloration.

Option Extras

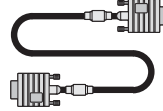

D-sub 15 pin Cable

When using the VGA (D-sub 15 pin cable) PC connection, the user must use shielded signal interface cables with ferrite cores to maintain standards compliance.

Not included with all models



Ferrite Core
(Black)

Ferrite core can be used to reduce the electromagnetic waves that may interfere with the TV. Install the Ferrite core on the power cable close to the wall plug.



Close to the wall plug.



Ferrite Core
(White)

Ferrite core can be used to reduce the electromagnetic wave when connecting the LAN cable. Place the ferrite core far from TV and wind the LAN cable in the ferrite core once.

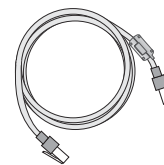

Plasma TV

(For 50PK750)

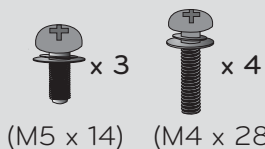

(M5 x 14) x 3 (M4 x 28) x 4

(50PZ540, 50PZ550,
50PZ750)

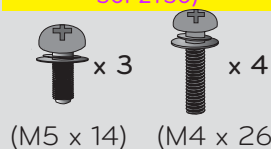

(M5 x 14) x 3 (M4 x 26) x 4

(For 60PZ540, 60PZ550,
60PZ750)

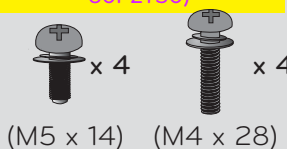

(M5 x 14) x 4 (M4 x 28) x 4

Screws for stand assembly (Refer to P.20)

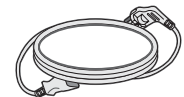

Power Cord



Cable Holder (Refer to p.28)

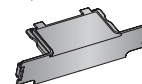

Protection Cover (Refer to p.21)

32/42/46/52/60LD550, 47/55LD650



Screws for stand assembly
(Refer to P.22)

(For 32/42LD550)



Screw for stand fixing
(Refer to P.32)



Protection Cover
(Refer to P.23)



Power Cord

42/47LE5350, 32/42/47/55LE5400, 42/47/55LE5500, 42/47/55LE7500, 47/55LE8500, 42/47/55LX6500

(47/55LE8500)



(M4 x 20)

(55LE5400/5500/7500,
55LX6500, 42LE5350)

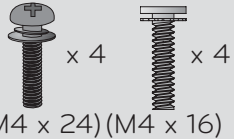

(M4 x 24) (M4 x 16)

(47LE5350)

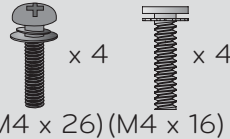

(M4 x 26) (M4 x 16)

(Other models)

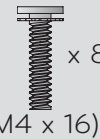

(M4 x 16)

Screws for stand assembly (Refer to P.24)



Cable Holder
(Refer to p.30)

(For 42/47/55LE7500,
47/55LE8500)

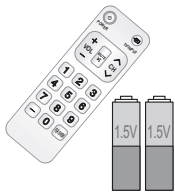

Simple Remote Control,
Batteries (AAA)

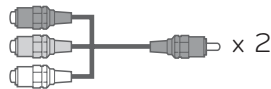

Component gender cable,
AV gender cable

(For 32LE5400)

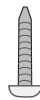

Screw for stand fixing
(Refer to P.32)

(For 42/47/55LE7500)



Cleansing Cloths
(mitt)

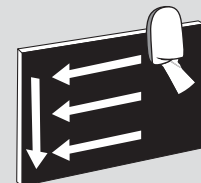

- * Wipe spots on the exterior only with the cleansing cloths.
- * Do not wipe roughly when removing stains. Excessive pressure may cause scratches or discoloration.
- * For cleaning front frame, please slowly wipe in one direction after spraying water 1-2 times on cleansing cloths. Please remove excessive moisture after cleaning. Excessive moisture may cause water stains on the frame.

OPTIONAL EXTRAS

Optional extras can be changed or modified for quality improvement without any notification.

Contact your dealer for buying these items.

This device only works with compatible LG LED LCD TV, LCD TV, or Plasma TV.

(Except 42/47LE5350)

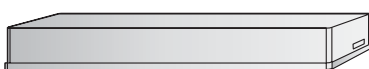

Wireless Media Box
(AN-WL100W)

(Except 42/47LE5350)



Wireless LAN for Broadband/
DLNA Adaptor
(AN-WF100)

(For 42/47/55LX6500, 50/60PZ540,
50/60PZ550, 50/60PZ750)



3D Glasses
(AG-S100)

PREPARATION

FRONT PANEL INFORMATION

PREPARATION

- Image shown may differ from your TV.

50/60K750, 50/60PZ540, 50/60PZ550, 50/60PZ750

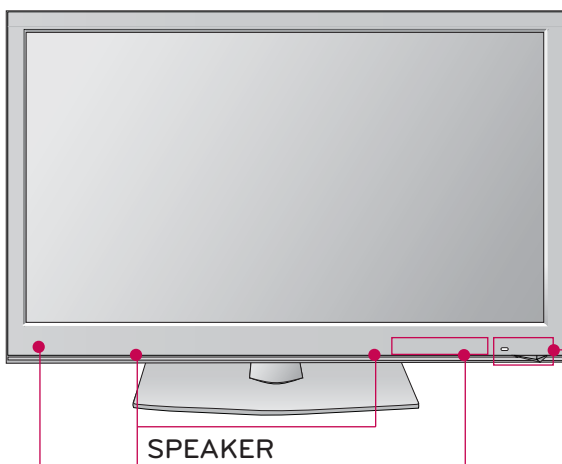

Emitter
(For 50/60PZ540, 50/60PZ550, 50/60PZ750)
It is the part equipped with the emitter exchanging signal with 3D glasses.
Please be careful not to block the screen with objects or people while watching a 3D Video.

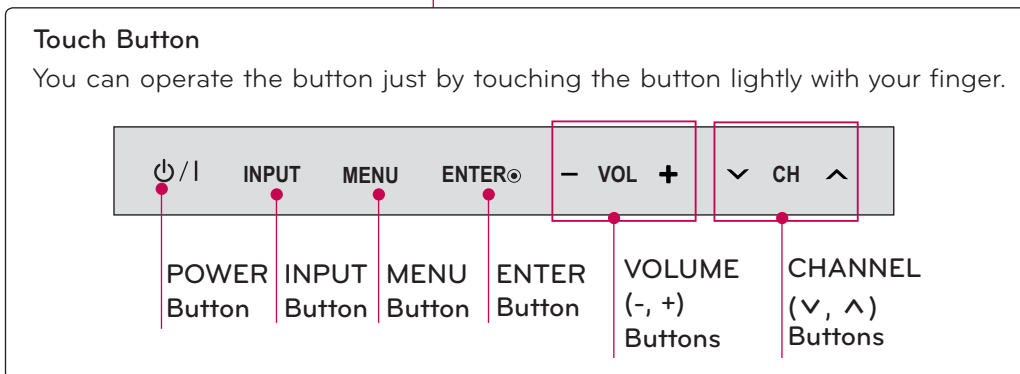
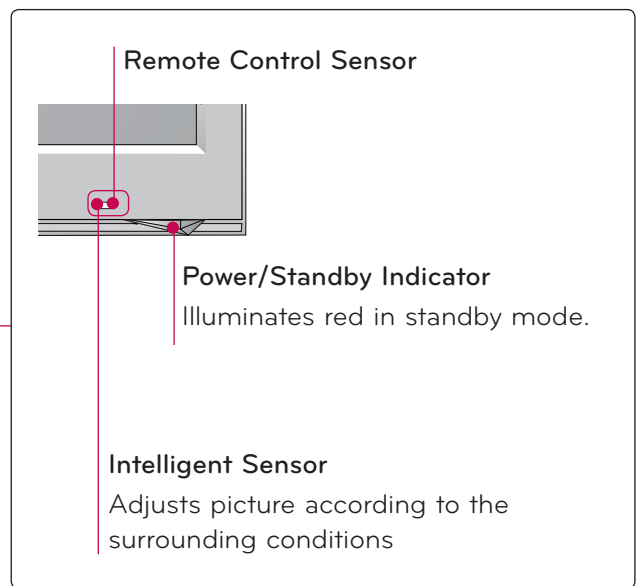

32/42/46/52/60LD550

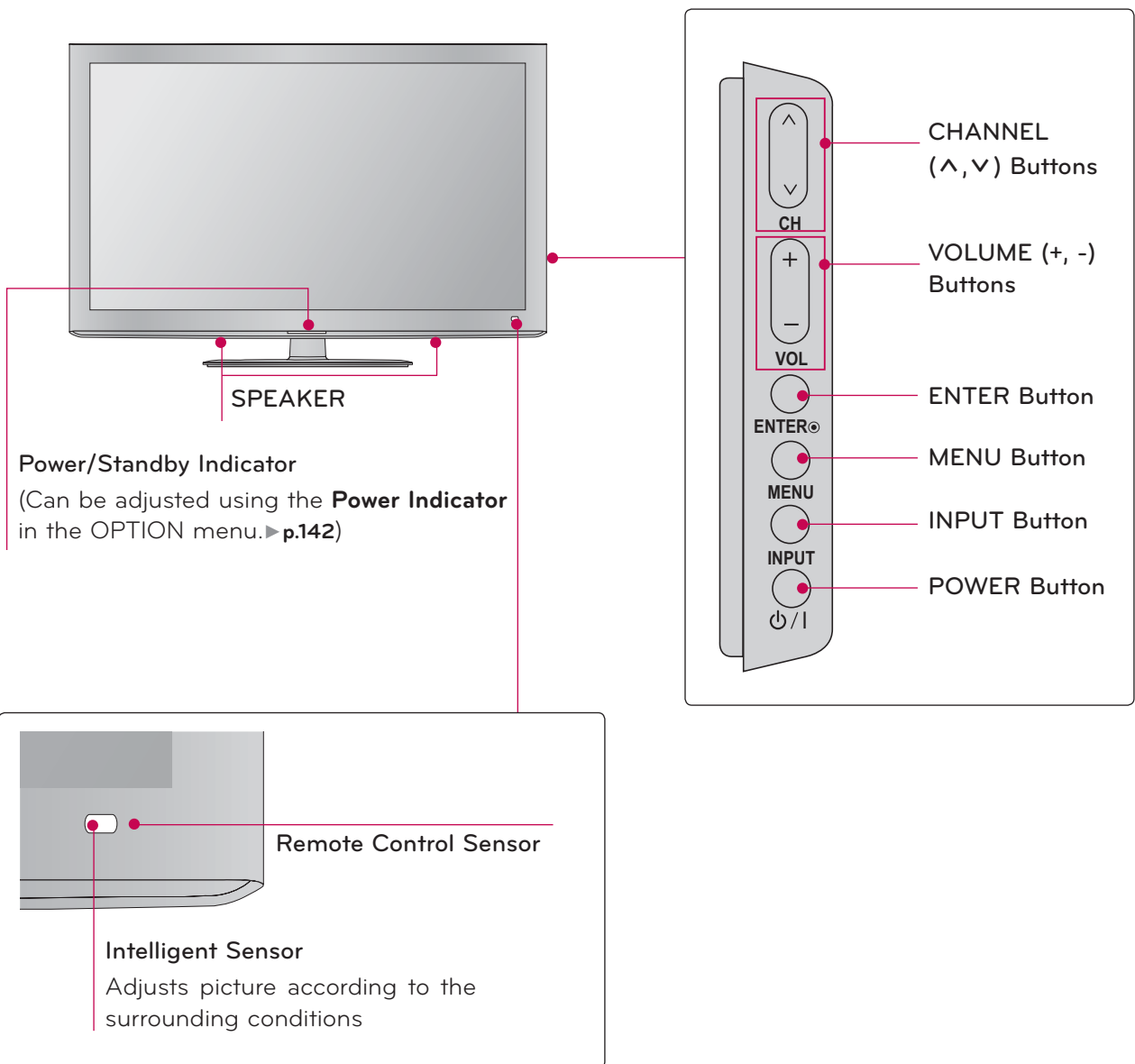

PREPARATION

■ Image shown may differ from your TV.

47/55LD650

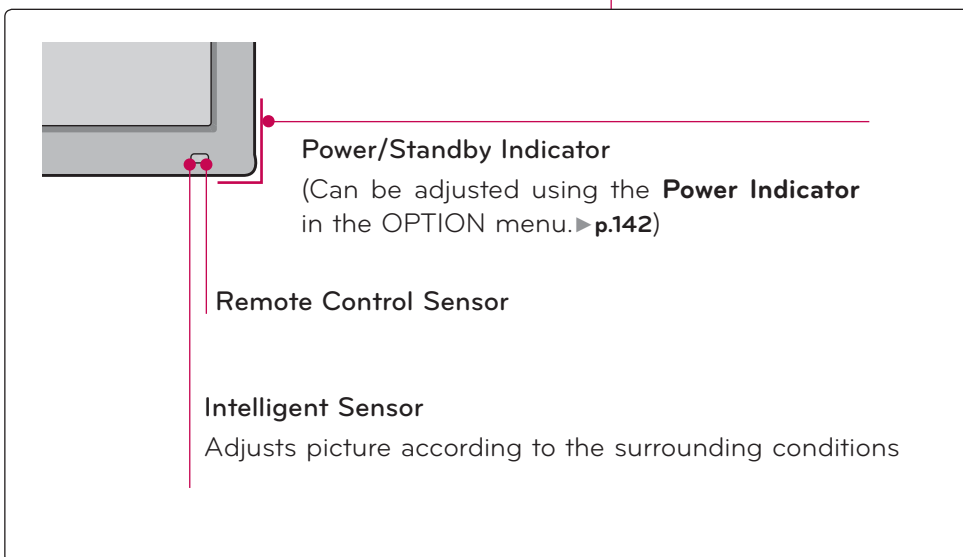
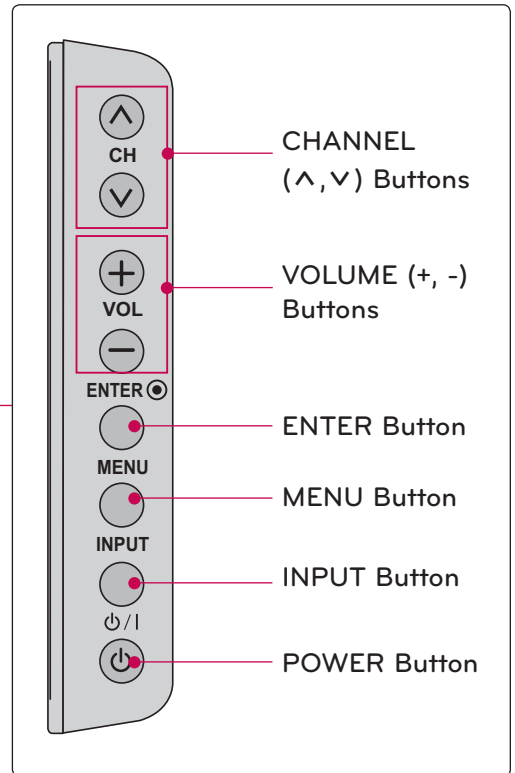
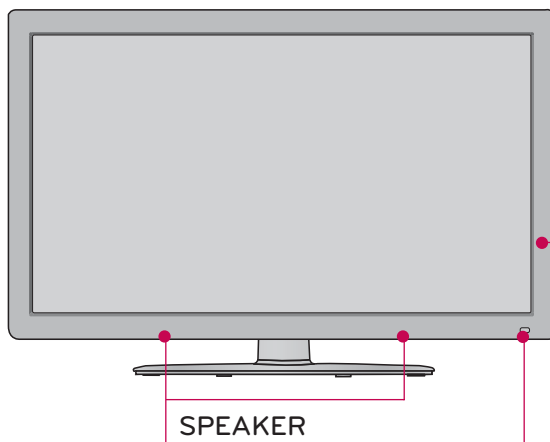

42/47LE5350, 32/42/47/55LE5400, 42/47/55LE5500, 42/47/55LE7500, 42/47/55LX6500

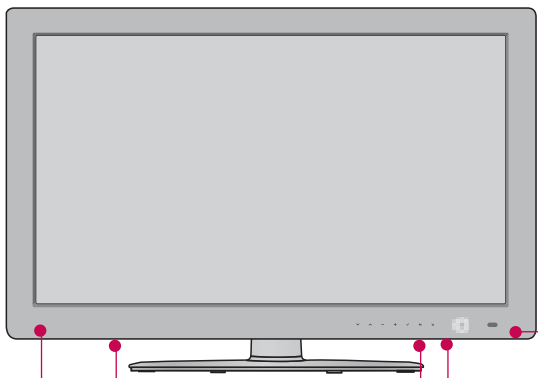

SPEAKER

Emitter
(For 42/47/55LX6500)

It is the part equipped with the emitter exchanging signal with 3D glasses. Please be careful not to block the screen with objects or people while watching a 3D Video.

Remote Control Sensor

Intelligent Sensor
Adjusts picture according to the surrounding conditions

Power/Standby Indicator
(Can be adjusted using the **Power Indicator** in the OPTION menu. ▶ p.142)

Touch Button
You can operate the button just by touching the button lightly with your finger.

| | | | | | |
|------------------------------|-----------------------------|-----------------|----------------|-----------------|-----------------|
| CH ∇ ▲ | VOL - + | ENTER ✓ | MENU M | INPUT ↘ | ⏻/I ⏻ |
| CHANNEL (∇, ▲) Buttons | VOLUME (-, +) Buttons | ENTER Button | MENU Button | INPUT Button | POWER Button |

PREPARATION

- Image shown may differ from your TV.

47/55LE8500

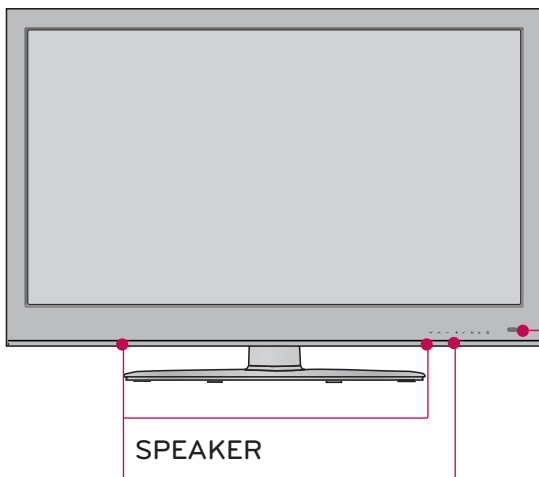

Remote Control Sensor

Intelligent Sensor
Adjusts picture according to the surrounding conditions

Touch Button
You can operate the button just by touching the button lightly with your finger.

| | | | | | |
|------------------------------|-----------------------------|-----------------|----------------|-----------------|------------------------------|
| CH ↓ ↑ | VOL - + | ENTER ✓ | MENU M | INPUT ↘ | Power/Standby Indicator ⏻ |
| CHANNEL (↓, ↑) Buttons | VOLUME (-, +) Buttons | ENTER Button | MENU Button | INPUT Button | POWER Button |

Power/Standby Indicator
(Can be adjusted using the **Power Indicator** in the **OPTION** menu. ▶ p.142)

BACK PANEL INFORMATION

■ Image shown may differ from your TV.

50/60PK750, 50/60PZ550, 50/60PZ750

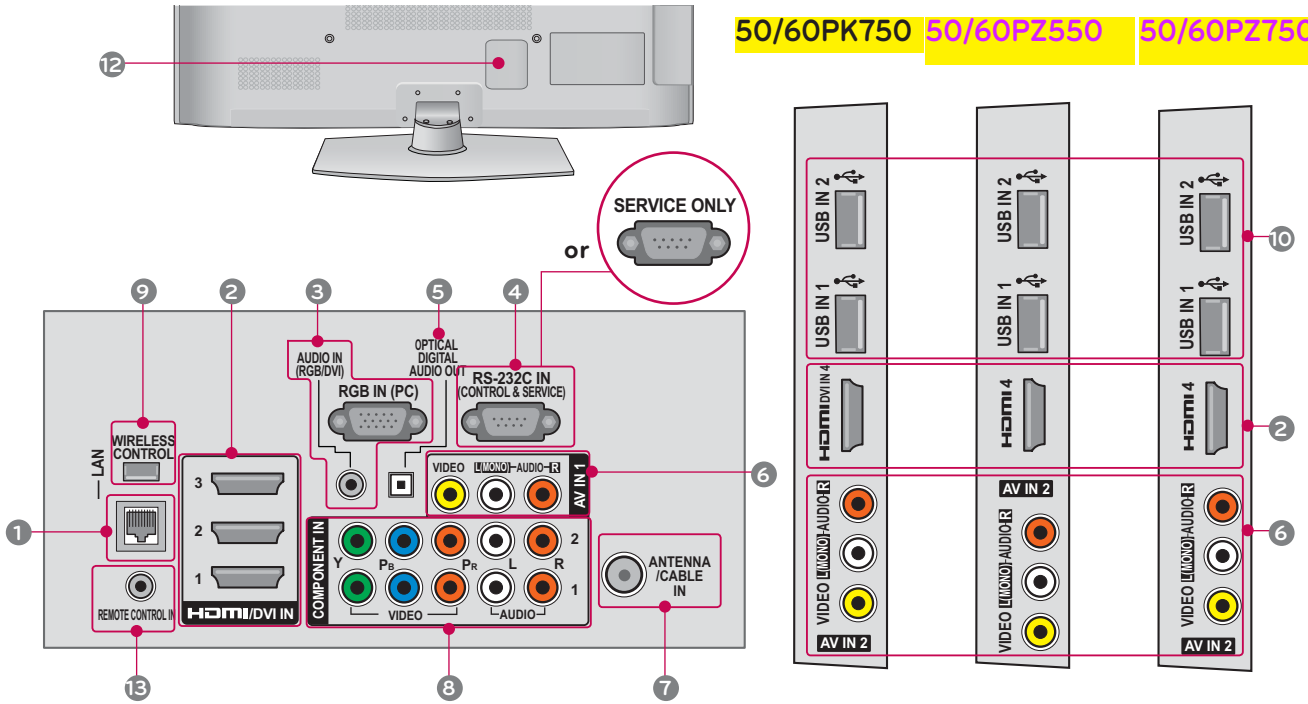

32/42/46/52/60LD550, 47/55LD650

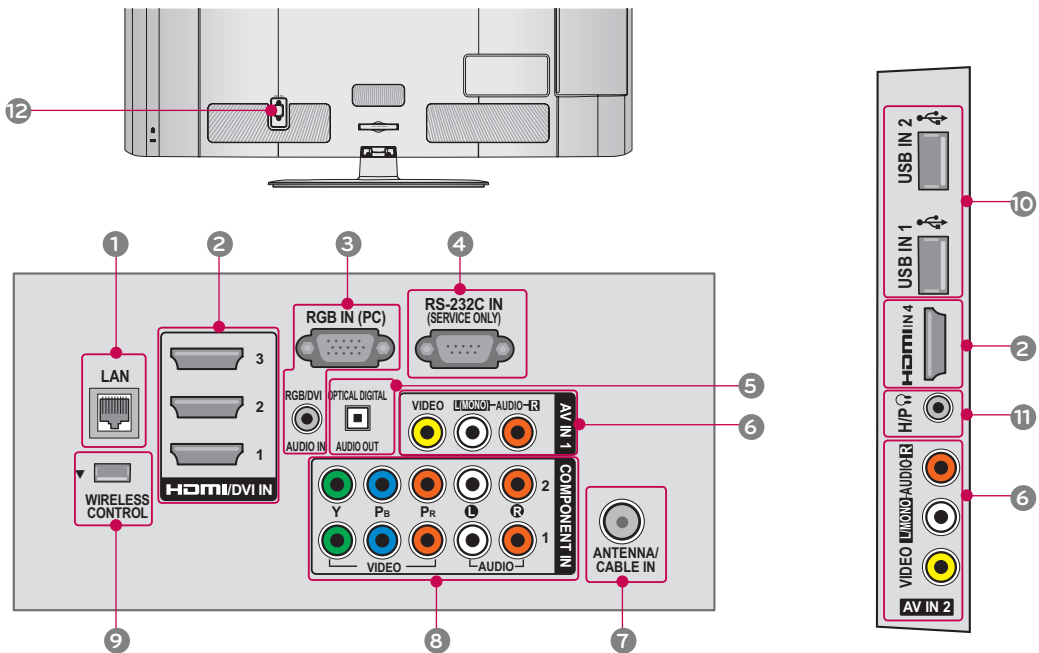

PREPARATION

42/47LE5350, 32/42/47/55LE5400, 42/47/55LE5500, 42/47/55LE7500, 47/55LE8500, 42/47/55LX6500

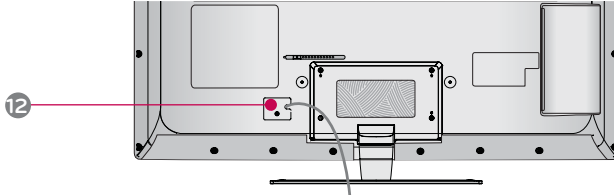

42/47LE5350

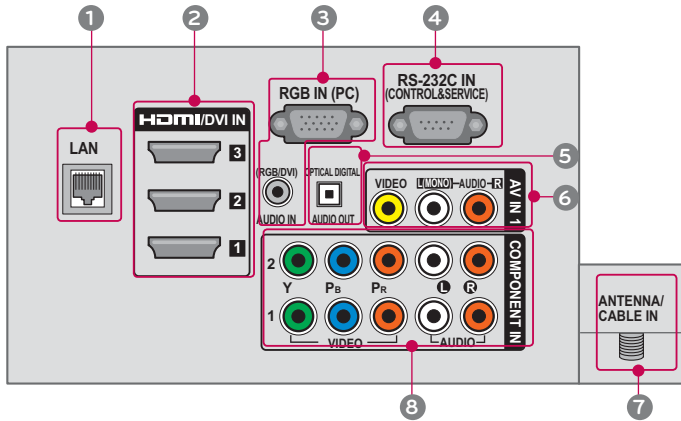

32/42/47/55LE5400, 42/47/55LE5500, 42/47/55LE7500, 47/55LE8500

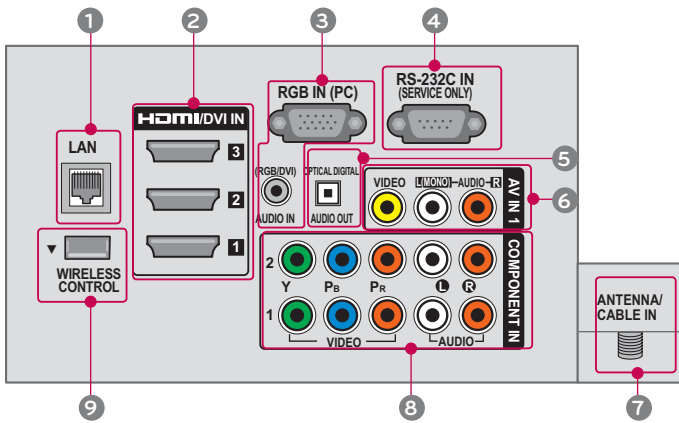

42/47/55LX6500

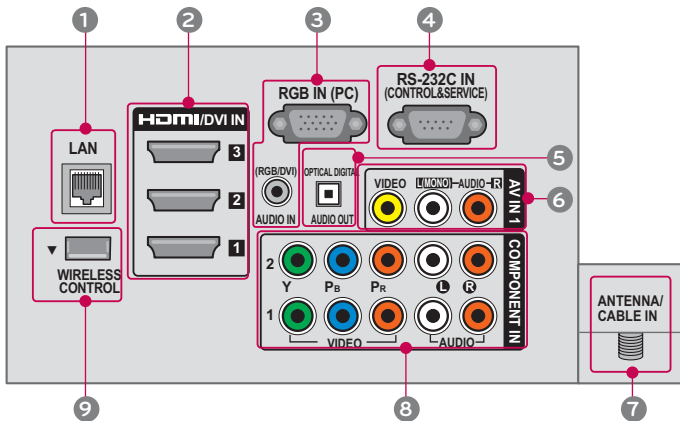

⚠ CAUTION

For HDMI IN 4 and USB IN 1, 2

- ▶ For an optimal connection, HDMI cables and USB devices should have bezels less than 10 mm (0.39 inches) thick.

*A ≤ 10 mm (0.39 inches)

50/60PZ540

1 LAN

Network connection for Netflix, Yahoo! TV Widgets, etc (for USA).

Also used for video, photo and music files on a local network.

2 HDMI/DVI IN, HDMI IN

Digital Connection.

Supports HD video and Digital audio. Doesn't support 480i.

Accepts DVI video using an adapter or HDMI to DVI cable (not included).

3 RGB IN (PC)

Analog PC Connection. Uses a D-sub 15 pin cable (VGA cable).

AUDIO IN (RGB/DVI)

0.32 cm (1/8 inch) headphone jack for analog PC audio input.

4 RS-232C IN (CONTROL & SERVICE), SERVICE ONLY, or RS-232C IN (SERVICE ONLY)

Used by third party devices.

This port is used for service or Hotel mode.

5 OPTICAL DIGITAL AUDIO OUT

Digital optical audio output for use with amps and home theater systems.

Note: In standby mode, this port doesn't work.

6 AV (Audio/Video) IN

Analog composite connection. Supports standard definition video only (480i).

7 ANTENNA/CABLE IN

Connect over-the-air or cable signals to this jack.

8 COMPONENT IN

Analog Connection.

Supports HD.

Uses a red, green, and blue cable for video & red and white for audio.

9 WIRELESS CONTROL

Connect the Wireless Ready Dongle to the TV to control the external input devices connected to Media Box wirelessly.

10 USB INPUT

Used for viewing photos, watching movies and listening to MP3s.

11 HEADPHONE

0.32 cm (1/8 inch) headphone jack

Impedance 16 Ω , Maximum audio out 15 mW

12 Power Cord or Socket

For operation with AC power.

Caution: Never attempt to operate the TV on DC power.

13 REMOTE CONTROL IN

For a wired remote control.

PREPARATION

STAND INSTRUCTIONS

(For 50/60PK750, 50/60PZ540, 50/60PZ550, 50/60PZ750)

Image shown may differ from your TV.

INSTALLATION

1 Carefully place the TV screen side down on a cushioned surface to protect the screen from damage.

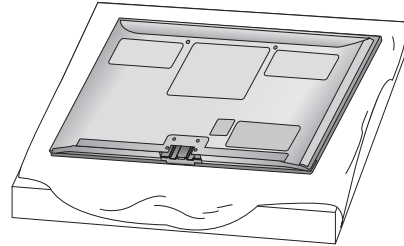

2 Assemble the parts of the **STAND BODY** with the **STAND BASE** of the TV.

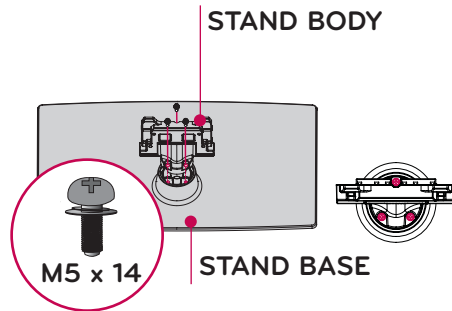

50PK750, 50PZ540, 50PZ550, 50PZ750
(provided as parts of the product)

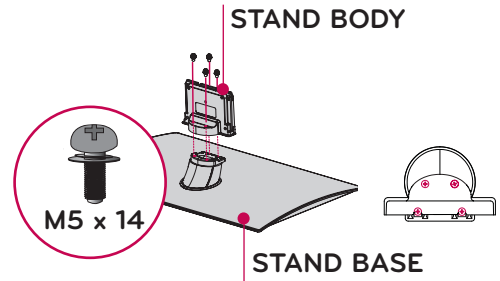

60PZ540, 60PZ550, 60PZ750
(provided as parts of the product)

3 Assemble the TV as shown.

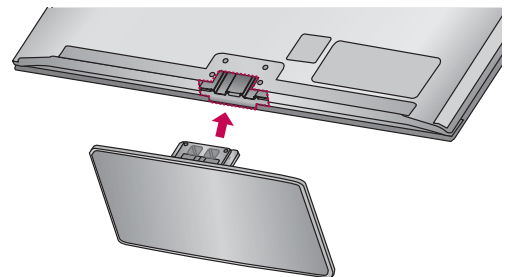

4 Install the 4 screws into the holes shown.

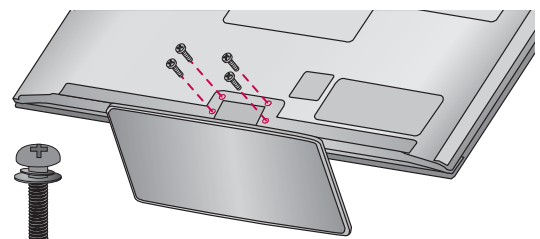

M4 x 26
(50PZ540/550/750)

M4 x 28
(Other models)

NOTE

► When assembling the desk type stand, make sure the screws are fully tightened (If not tightened fully, the TV can tilt forward after the product installation). Do not over tighten.

DETACHMENT

- 1 Carefully place the TV screen side down on a cushioned surface to protect the screen from damage.

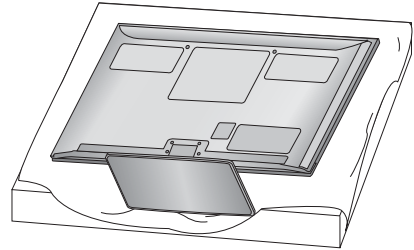

- 2 Remove the screws that hold the stand on.

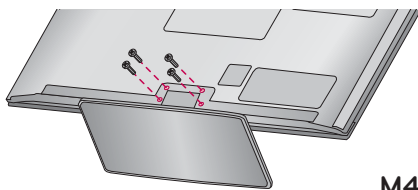

M4 x 28

(50PK750, 60PZ540,
60PZ550, 50/60PZ750)

M4 x 26

(50PZ540/550)

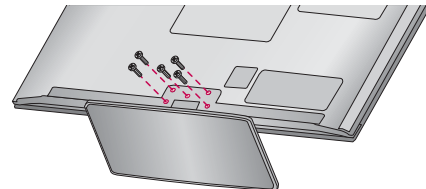

M4 x 30

(60PK750)

- 3 Detach the stand from TV.

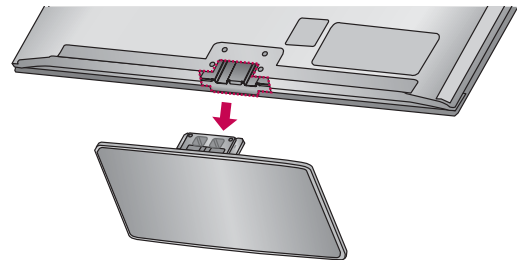

PROTECTION COVER

After removing the stand, install the included **PROTECTION COVER** over the hole for the stand.

Press the **PROTECTION COVER** into the TV until you hear it click.

When installing the wall mounting bracket, use the **PROTECTION COVER**.

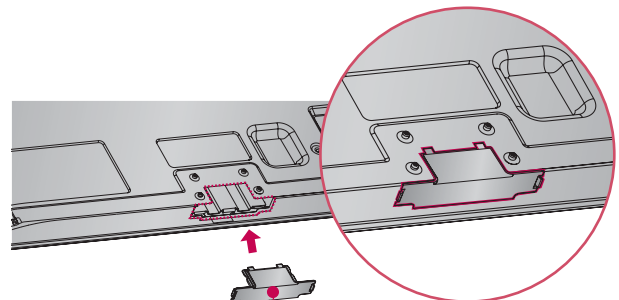

PROTECTION COVER

Fix a guide to the outside.

PREPARATION

STAND INSTRUCTIONS (For 32/42/46/52/60LD550, 47/55LD650)

- Image shown may differ from your TV.

INSTALLATION

- 1 Carefully place the TV screen side down on a cushioned surface to protect the screen from damage.

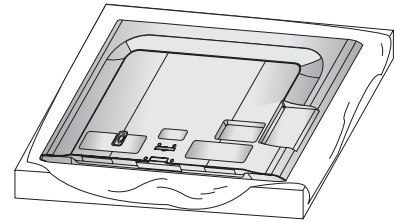

- 2 Assemble the parts of the **STAND BODY** with the **STAND BASE** of the TV.

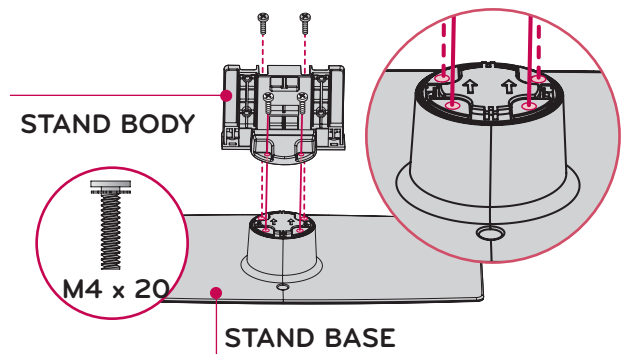

- 3 Assemble the TV as shown.

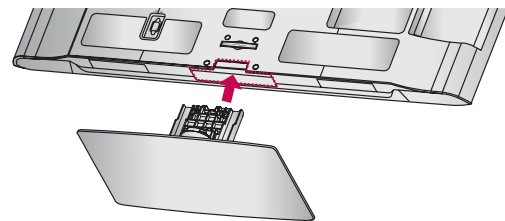

- 4 Install the 4 screws into the holes shown.

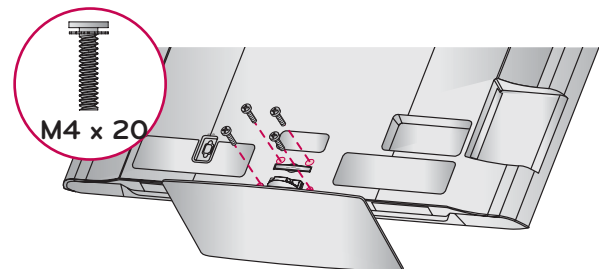

NOTE

- ▶ When assembling the desk type stand, make sure the screws are fully tightened (If not tightened fully, the TV can tilt forward after the product installation). Do not over tighten.

DETACHMENT

- 1 Carefully place the TV screen side down on a cushioned surface to protect the screen from damage.

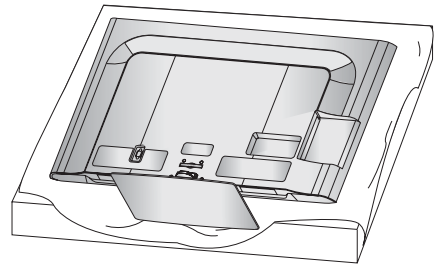

- 2 Remove the screws that hold the stand on.

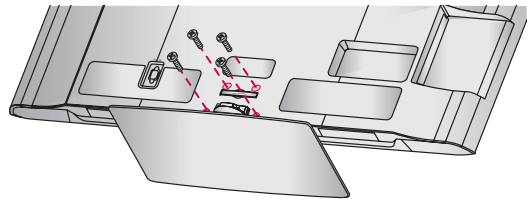

- 3 Detach the stand from TV.

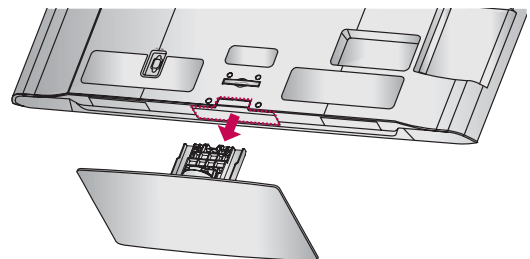

PROTECTION COVER

After removing the stand, install the included **PROTECTION COVER** over the hole for the stand.

Press the **PROTECTION COVER** into the TV until you hear it click.

When installing the wall mounting bracket, use the **PROTECTION COVER**.

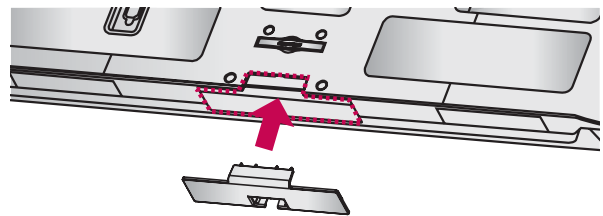

PREPARATION

STAND INSTRUCTIONS

(For 42/47LE5350, 32/42/47/55LE5400, 42/47/55LE5500, 42/47/55LE7500, 47/55LE8500, 42/47/55LX6500)

■ Image shown may differ from your TV.

INSTALLATION

- 1 Carefully place the TV screen side down on a cushioned surface to protect the screen from damage.
- 2 Assemble the parts of the **STAND BODY** with the **STAND BASE** of the TV.
At this time, tighten the screws that hold the **STAND BODY** on.

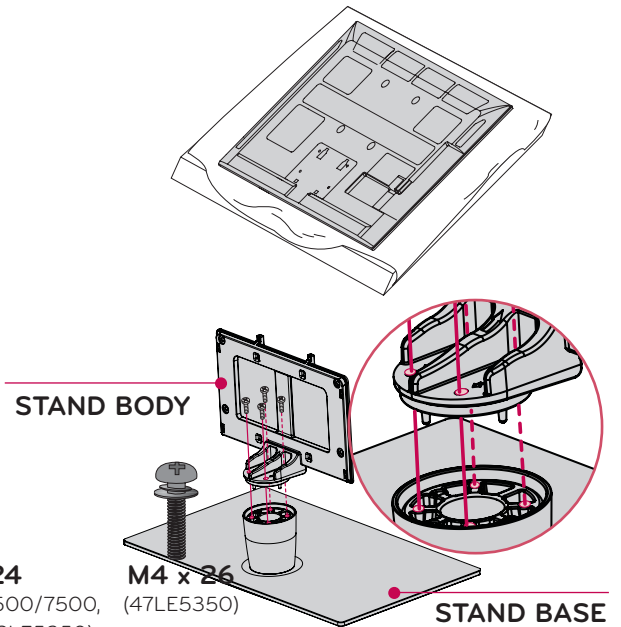
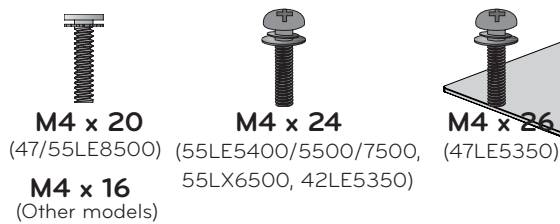

- 3 Assemble the TV as shown.

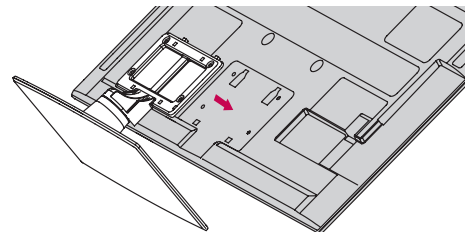

- 4 Assemble the part of the **STAND REAR COVER** with the TV.

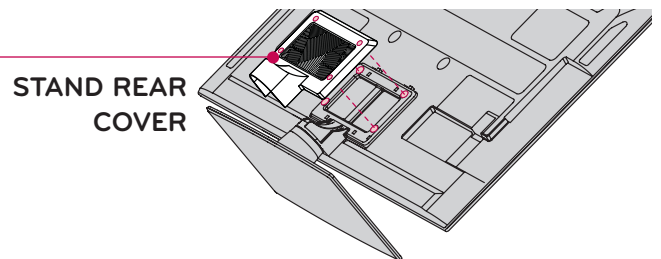

- 5 Install the 4 screws into the holes shown.

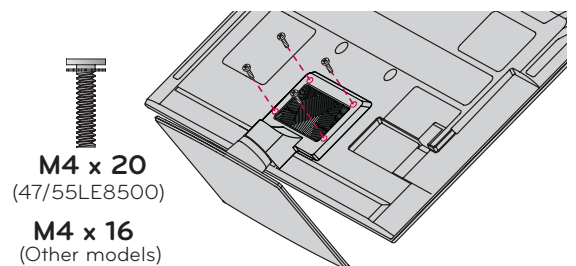

NOTE

- ▶ When assembling the desk type stand, make sure the screws are fully tightened (If not tightened fully, the TV can tilt forward after the product installation). Do not over tighten.

DETACHMENT

- 1 Carefully place the TV screen side down on a cushioned surface to protect the screen from damage.

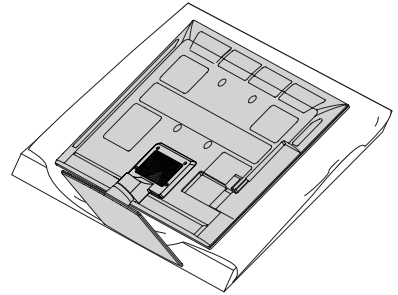

- 2 Remove the screws that hold the stand on.

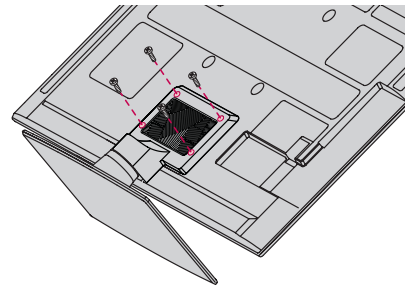

- 3 Detach the **STAND REAR COVER** from TV.

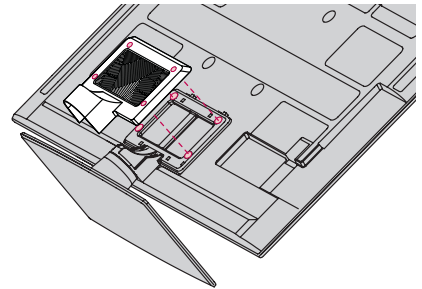

- 4 Detach the stand from TV.

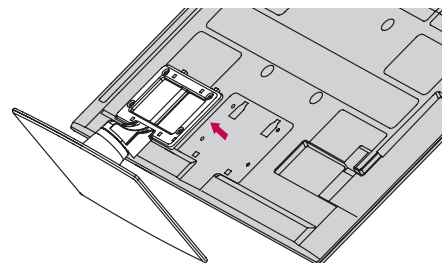

PREPARATION

VESA WALL MOUNTING

PREPARATION

Install your wall mount on a solid wall perpendicular to the floor. When attaching to other building materials, please contact your nearest installer.

If installed on a ceiling or slanted wall, it may fall and result in severe personal injury.

We recommend that you use an LG brand wall mount when mounting the TV to a wall.

LG recommends that wall mounting be performed by a qualified professional installer.

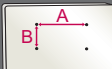
| Model | VESA (A * B)  | Standard Screw | Quantity | Wall Mounting Bracket (sold separately) |
|---|---|----------------|----------|---|
| 32LD550, 32LE5400 | 200 * 100 | M4 | 4 | LSW100B, LSW100BG |
| 42/46LD550, 47LD650, 42/47LE5350, 42/47LE5400, 42/47LE5500, 42/47LE7500, 47LE8500, 42/47LX6500 | 200 * 200 | M6 | 4 | LSW200B, LSW200BG |
| 52LD550, 55LD650, 55LE5400, 55LE5500, 55LE7500, 55LE8500, 60LD550, 55LX6500 | 400 * 400 | M6 | 4 | LSW400B, LSW400BG, DSW400BG |
| 50PK750, 50PZ540 50PZ550, 50PZ750 | 400 * 400 | M6 | 4 | PSW400B, PSW400BG |
| 60PK750, 60PZ540 60PZ550, 60PZ750 | 600 * 400 | M8 | 4 | PSW600B, PSW600BG |

NOTE

- ▶ Screw length needed depends on the wall mount used. For further information, refer to the instructions included with the mount.
- ▶ Standard dimensions for wall mount kits are shown in the table.
- ▶ When purchasing our wall mount kit, a detailed installation manual and all parts necessary for assembly are provided.
- ▶ Do not use screws longer than the standard dimension, as they may cause damage to the inside to the TV.
- ▶ For wall mounts that do not comply with the VESA standard screw specifications, the length of the screws may differ depending on their specifications.
- ▶ Do not use screws that do not comply with the VESA standard screw specifications.
Do not use fasten the screws too strongly, this may damage the TV or cause the TV to a fall, leading to personal injury. LG is not liable for these kinds of accidents.
- ▶ LG is not liable for TV damage or personal injury when a non-VESA or non specified wall mount is used or the consumer fails to follow the TV installation instructions.

CAUTION

- ▶ Do not install your wall mount kit while your TV is turned on. It may result in personal injury due to electric shock.

PREPARATION

CABLE MANAGEMENT

PREPARATION

- Image shown may differ from your TV.

Plasma TV

- 1 After connecting the cables as necessary, install the **CABLE HOLDER** as shown and bundle the cables.

In case of the LAN cable, install as shown to reduce the electromagnetic wave.

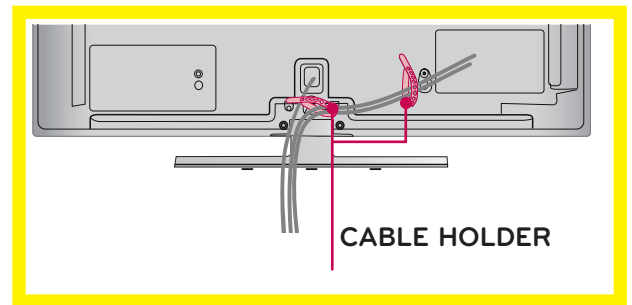
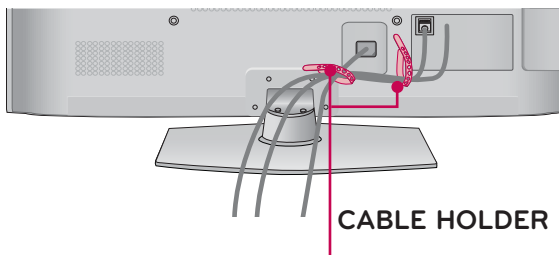

- Image shown may differ from your TV.

32/42/46/52/60LD550, 47/55LD650

- 1** Connect the cables as necessary.
To connect additional equipment, see the **EXTERNAL EQUIPMENT SETUP** section.

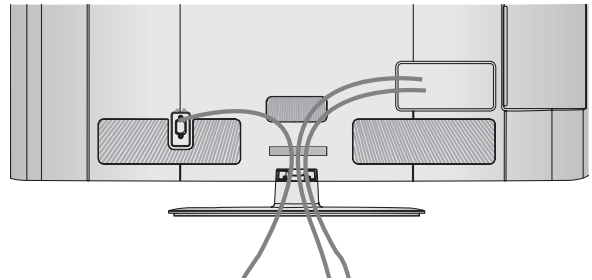

- 2** Open the **CABLE MANAGEMENT CLIP** as shown.

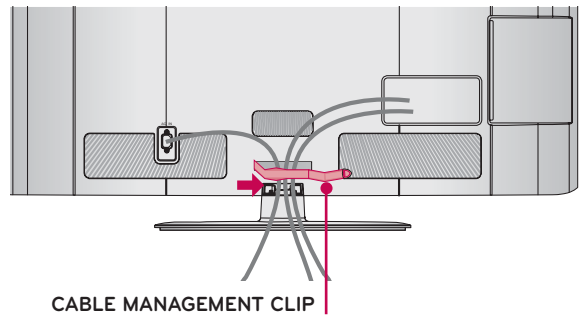

- 3** Put the cables inside the **CABLE MANAGEMENT CLIP** and snap it closed.

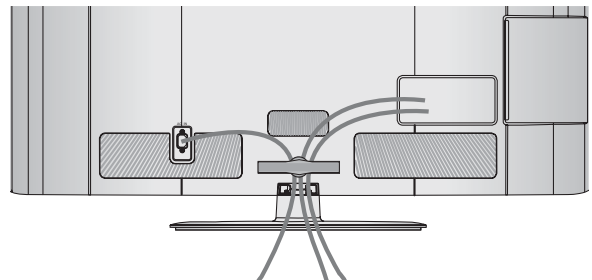

PREPARATION

- Image shown may differ from your TV.

42/47LE5350, 32/42/47/55LE5400, 42/47/55LE5500, 42/47/55LE7500, 47/55LE8500,
42/47/55LX6500

- 1** Secure the power cord with the **CABLE HOLDER** on the TV back cover. It will help prevent the power cable from being removed by accident.

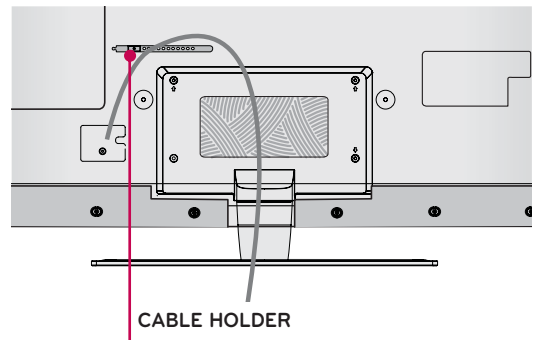

- 2** After connecting the cables as necessary, install the **CABLE HOLDER** as shown and bundle the cables.

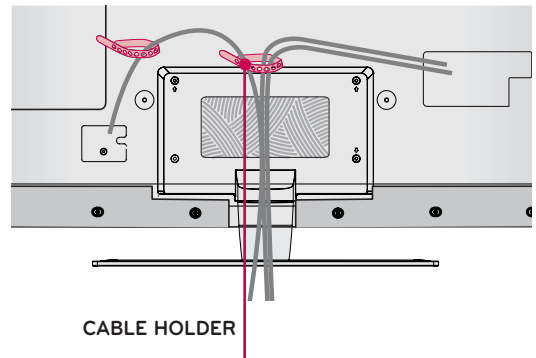

DESKTOP PEDESTAL INSTALLATION

- Image shown may differ from your TV.

For proper ventilation, allow a clearance of 10.1 cm (4 inch) on all four sides from the wall.

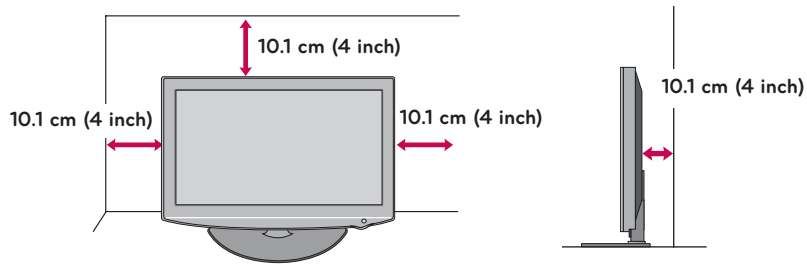

⚠ CAUTION

- ▶ Ensure adequate ventilation by following the clearance recommendations.
- ▶ Do not mount near or above any type of heat source.

SWIVEL STAND

After installing the TV, you can adjust the TV set manually to the left or right direction by 20 ° to suit your viewing position.

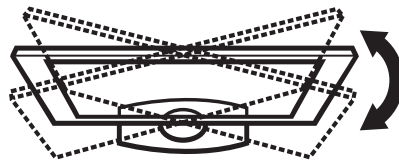

PREPARATION

ATTACHING THE TV TO A DESK (For 32/42LD550, 32LE5400)

- Image shown may differ from your TV.

The TV must be attached to a desk so it cannot be pulled in a forward/backward direction, potentially causing injury or damaging the product.

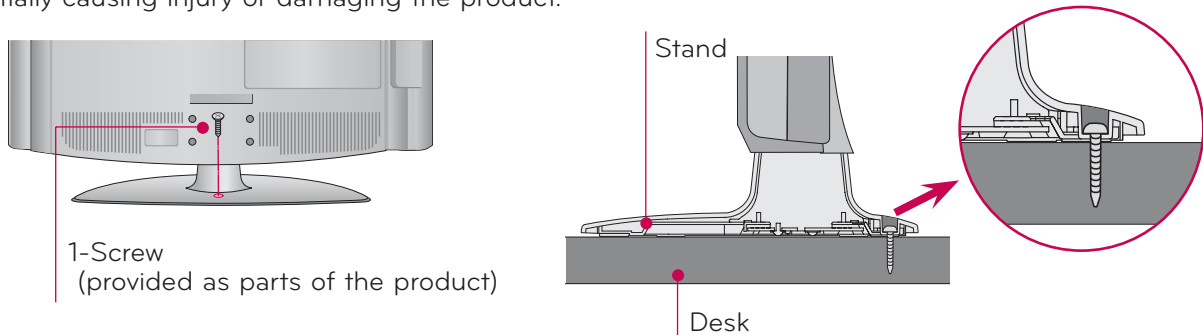

⚠ WARNING

- ▶ To prevent TV from falling over, the TV should be securely attached to the floor/wall per installation instructions. Tipping, shaking, or rocking the machine may cause injury.

KENSINGTON SECURITY SYSTEM

- This feature is not available for all models.
 - The TV is equipped with a Kensington Security System connector on the back panel. Connect the Kensington Security System cable as shown below.
 - For the detailed installation and use of the Kensington Security System, refer to the user's guide provided with the Kensington Security System.
- For further information, contact <http://www.kensington.com>, the internet homepage of the Kensington company. Kensington sells security systems for expensive electronic equipment such as notebook PCs and LCD projectors.

NOTE: The Kensington Security System is an optional accessory.

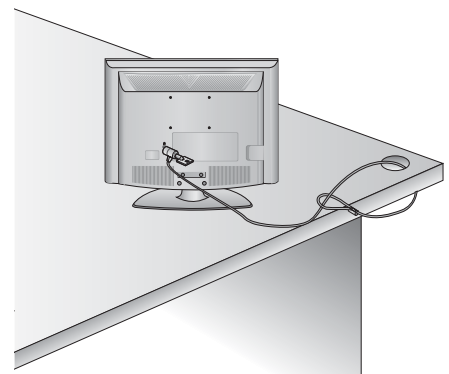

SECURING THE TV TO THE WALL TO PREVENT FALLING WHEN THE TV IS USED ON A STAND

- You should purchase necessary components to prevent the TV from tipping over (when not using a wall mount).
- Image shown may differ from your TV.

We recommend that you set up the TV close to a wall so it cannot fall over if pushed backwards. Additionally, we recommend that the TV be attached to a wall so it cannot be pulled in a forward direction, potentially causing injury or damaging the product.

Caution: Please make sure that children don't climb on or hang from the TV.

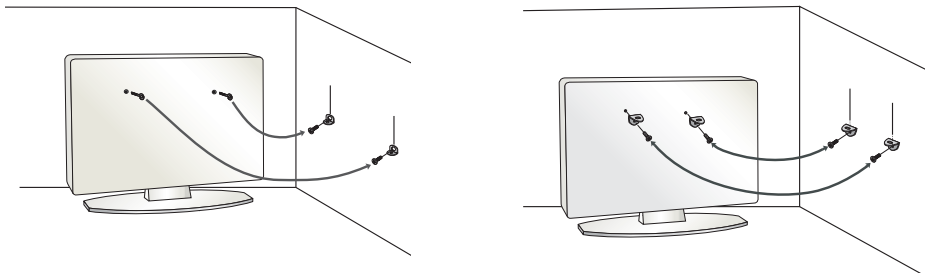

- Insert the eye-bolts (or TV brackets and bolts) to tighten the product to the wall as shown in the picture.

* If your product has the bolts in the eye-bolts position before inserting the eye-bolts, loosen the bolts.

* Insert the eye-bolts or TV brackets/bolts and tighten them securely in the upper holes.

Secure the wall brackets with the bolts (sold separately) to the wall. Match the height of the bracket that is mounted on the wall to the holes in the product.

Ensure the eye-bolts or brackets are tightened securely.

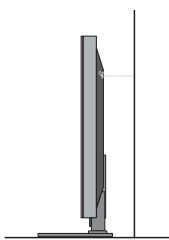

- Use a sturdy rope (sold separately) to tie the product. It is safer to tie the rope so it becomes horizontal between the wall and the product.

NOTE

- ▶ Use a platform or cabinet strong enough and large enough to support the size and weight of the TV.
- ▶ To use the TV safely make sure that the height of the bracket on the wall and the one on the TV are the same.

PREPARATION

- To prevent damage do not connect to the power outlet until all connections are made between the devices.
- Image shown may differ from your TV.

ANTENNA OR CABLE CONNECTION

1. Antenna (Analog or Digital)

Wall Antenna Socket or Outdoor Antenna without a Cable Box Connections.
 For optimum picture quality, adjust antenna direction if needed.

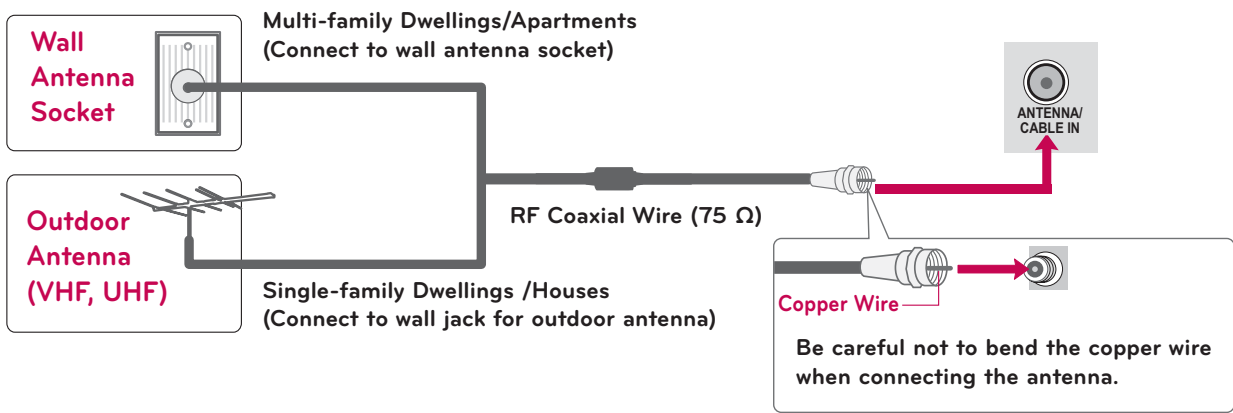

2. Cable

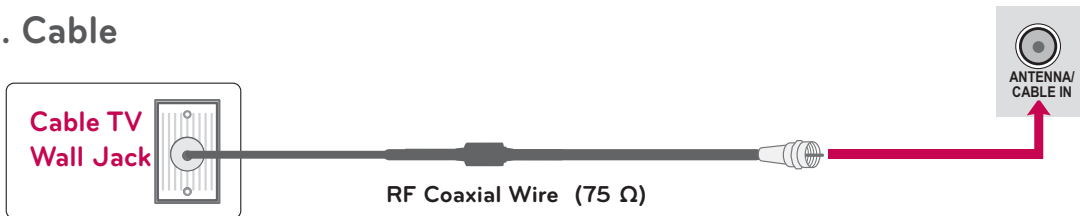

- If the antenna needs to be split for two TV's, install a 2-Way Signal Splitter.
- For much more information about antennas visit our Knowledgebase at <http://lgknowledgebase.com>. Search for antenna.

EXTERNAL EQUIPMENT SETUP

- To prevent the equipment damage, never plug in any power cords until you have finished connecting all equipment.
- Image shown may differ from your TV.

HD RECEIVER SETUP

This TV can receive digital over-the-air/digital cable signals without an external digital set-top box. However, if you do receive digital signals from a digital set-top box or other digital external device.

Component Connection

1. How to connect

- 1 Connect the video outputs (Y, PB, PR) of the digital set-top box to the **COMPONENT IN VIDEO 1, 2, or 3*** jacks on the TV. Match the jack colors (Y = green, PB = blue, and PR = red).
- 2 Connect the audio output of the digital set-top box to the **COMPONENT IN AUDIO 1, 2, or 3*** jacks on the TV.

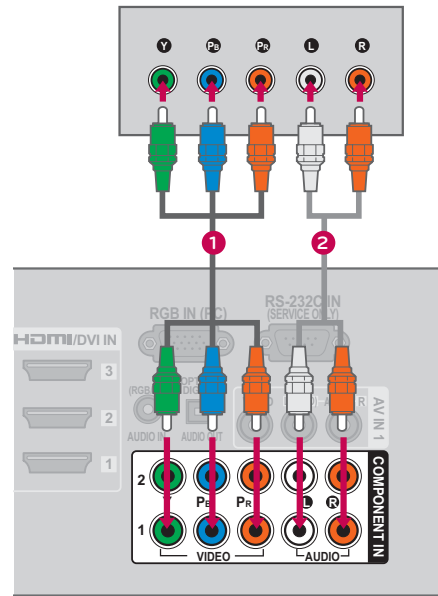

2. How to use

- Turn on the digital set-top box.
(Refer to the owner's manual for the digital set-top box operation.)
- Select the **Component1, Component2,** or **Component3** input source on the TV using the **INPUT** button on the remote control.

* Component3: For LED LCD TV

Y, CB/PB, CR/PR

| Resolution | Horizontal Frequency(kHz) | Vertical Frequency(Hz) |
|------------|---------------------------|------------------------|
| 720x480i | 15.73 | 59.94 |
| | 15.73 | 60.00 |
| 720x480p | 31.47 | 59.94 |
| | 31.50 | 60.00 |
| 1280x720p | 44.96 | 59.94 |
| | 45.00 | 60.00 |
| 1920x1080i | 33.72 | 59.94 |
| | 33.75 | 60.00 |
| 1920x1080p | 26.97 | 23.976 |
| | 27.00 | 24.00 |
| | 33.71 | 29.97 |
| | 33.75 | 30.00 |
| | 67.432 | 59.94 |
| | 67.50 | 60.00 |

EXTERNAL EQUIPMENT SETUP

For LED LCD TV

EXTERNAL EQUIPMENT SETUP

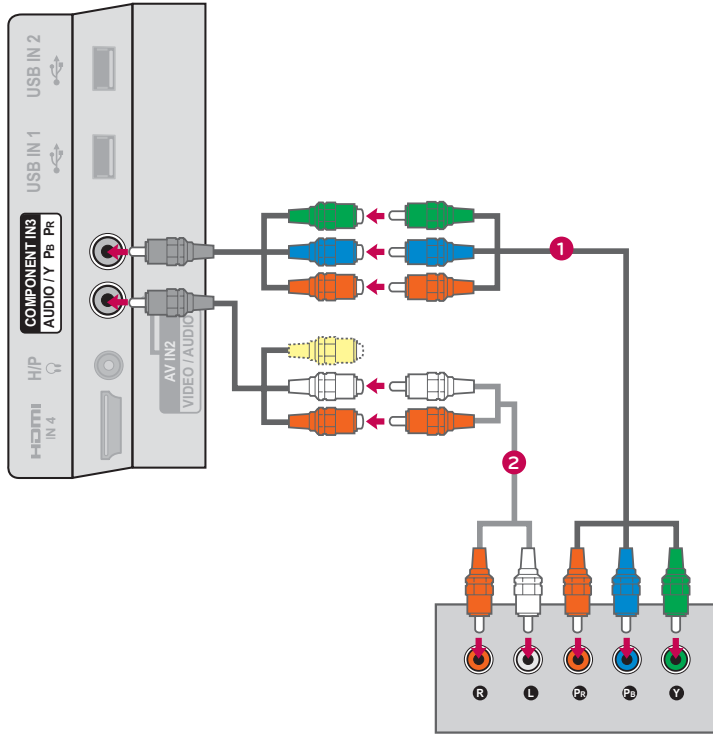

HDMI Connection

1. How to connect

- 1 Connect the digital set-top box to **HDMI/DVI IN 1, 2, 3, or 4** jack on the TV.
- 2 No separate audio connection is necessary. HDMI supports both audio and video.

2. How to use

- Turn on the digital set-top box.
(Refer to the owner's manual for the digital set-top box.)
- Select the **HDMI1, HDMI2, HDMI3, or HDMI4** input source on the TV using the **INPUT** button on the remote control.

NOTE

- ▶ If an HDMI cable doesn't support High Speed HDMI, it can cause flickers or no screen display. In this case use the latest cables that support High Speed HDMI.
- ▶ HDMI Audio Supported Format: Dolby Digital (32 kHz, 44.1 kHz, 48 kHz), Linear PCM (32 kHz, 44.1 kHz, 48 kHz)

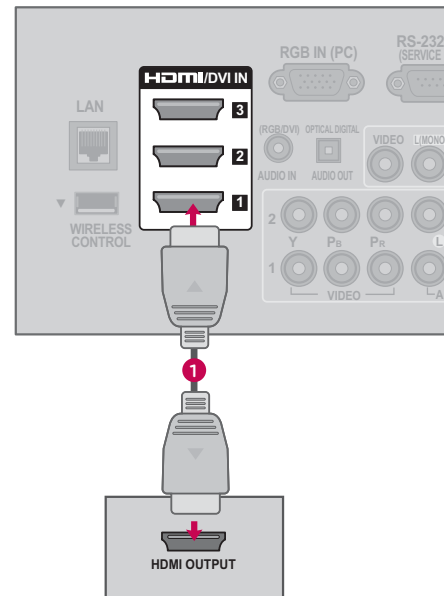

HDMI-DTV

| Resolution | Horizontal Frequency(kHz) | Vertical Frequency(Hz) |
|------------|---------------------------|------------------------|
| 720x480p | 31.47 | 59.94 |
| | 31.50 | 60.00 |
| 1280x720p | 44.96 | 59.94 |
| | 45.00 | 60.00 |
| 1920x1080i | 33.72 | 59.94 |
| | 33.75 | 60.00 |
| 1920x1080p | 26.97 | 23.976 |
| | 27.00 | 24.00 |
| | 33.71 | 29.97 |
| | 33.75 | 30.00 |
| | 67.432 | 59.94 |
| | 67.50 | 60.00 |

EXTERNAL EQUIPMENT SETUP

DVI to HDMI Connection

1. How to connect

- 1 Connect the DVI output of the digital set-top box to the **HDMI/DVI IN 1, 2, 3, or 4*** jack on the TV.
- 2 Connect the digital set-top box audio output to the **AUDIO IN (RGB/DVI)** jack on the TV.

2. How to use

- Turn on the digital set-top box.
(Refer to the owner's manual for the digital set-top box.)
- Select the **HDMI1, HDMI2, HDMI3, or HDMI4*** input source on the TV using the **INPUT** button on the remote control.

* *HDMI4: For Plasma TV*

NOTE

- ▶ A DVI to HDMI cable or adapter is required for this connection. DVI doesn't support audio, so a separate audio connection is necessary.

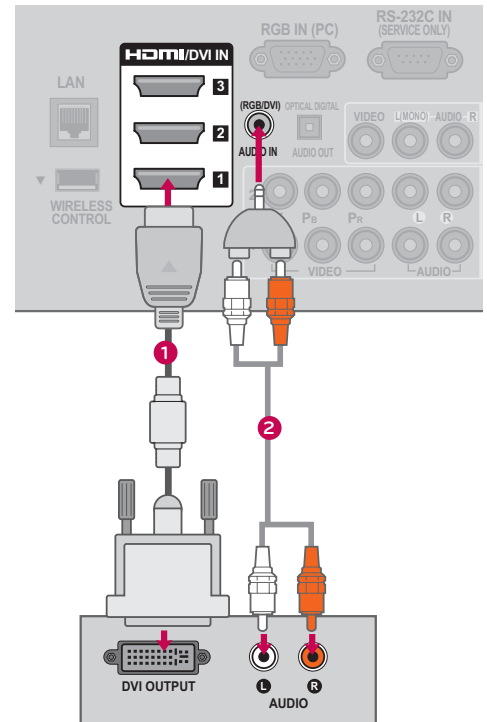

DVD SETUP

Component Connection

1. How to connect

- 1 Connect the video outputs (Y, PB, PR) of the DVD to the **COMPONENT IN VIDEO 1, 2, or 3*** jacks on the TV.
Match the jack colors (Y = green, PB = blue, and PR = red).
- 2 Connect the audio outputs of the DVD to the **COMPONENT IN AUDIO 1, 2, or 3*** jacks on the TV.

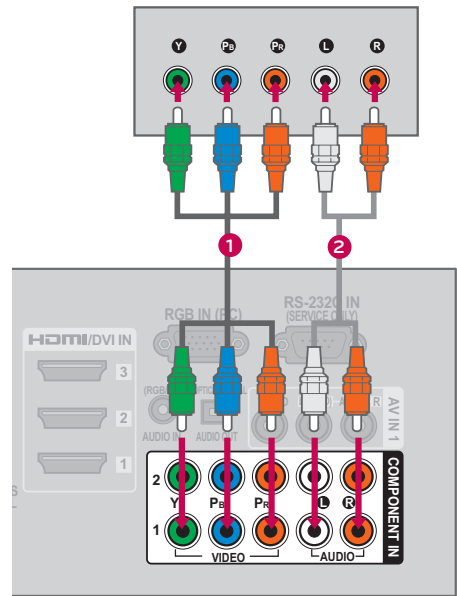

2. How to use

- Turn on the DVD player, insert a DVD.
- Select the **Component1**, **Component2**, or **Component3** input source on the TV using the **INPUT** button on the remote control.
- Refer to the DVD player's manual for operating instructions.

* Component3: For LED LCD TV

For LED LCD TV

Component Input ports

To get better picture quality, connect a DVD player to the component input ports as shown below.

| Component ports on the TV | Y | P _B | P _R |
|----------------------------------|---|----------------|----------------|
| Video output ports on DVD player | Y | P _B | P _R |
| | Y | B-Y | R-Y |
| | Y | C _b | C _r |
| | Y | P _b | P _r |

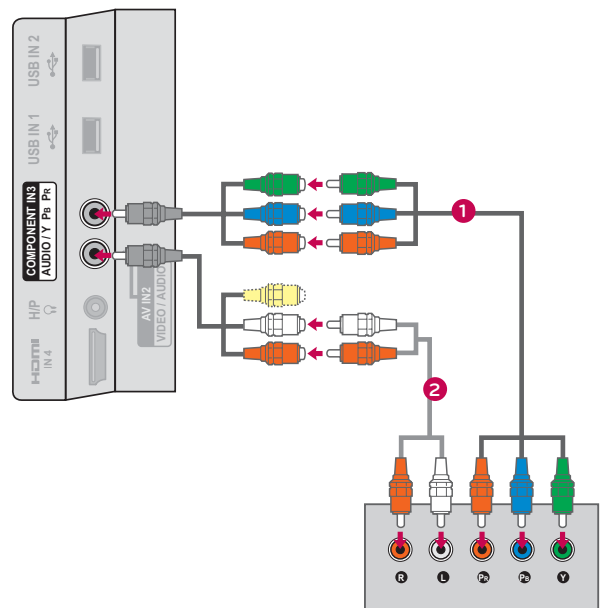

EXTERNAL EQUIPMENT SETUP

Composite (RCA) Connection

1. How to connect

- 1 Connect the **AUDIO/VIDEO** jacks between TV and DVD. Match the jack colors (Video = yellow, Audio Left = white, and Audio Right = red)

2. How to use

- Turn on the DVD player, insert a DVD.
- Select the **AV1** or **AV2** input source on the TV using the **INPUT** button on the remote control.
- Refer to the DVD player's manual for operating instructions.

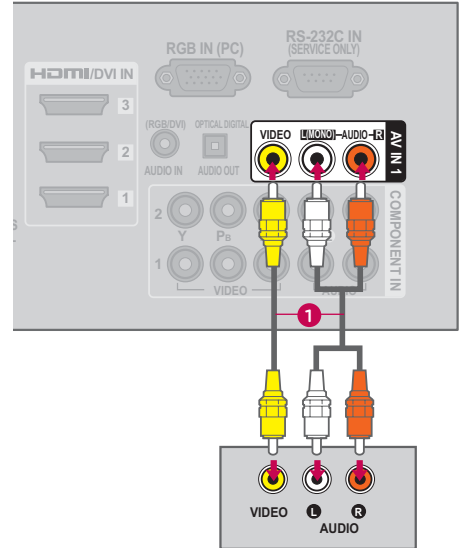

For LED LCD TV

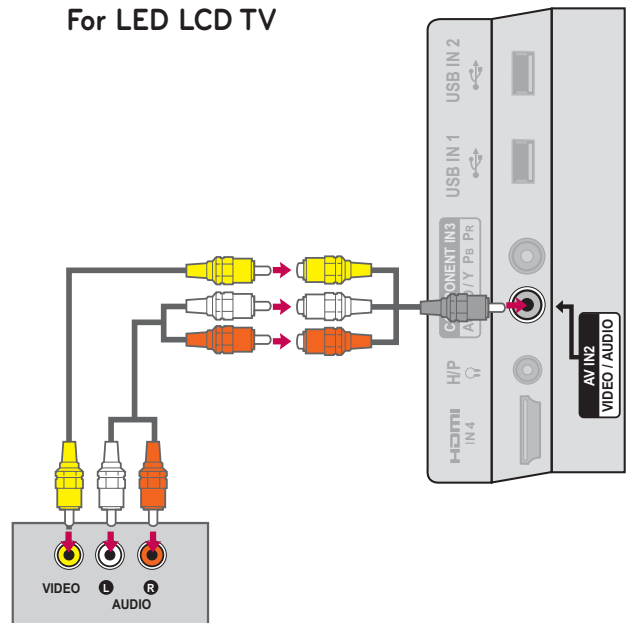

HDMI Connection

1. How to connect

- 1 Connect the HDMI output of the DVD to the **HDMI/DVI IN 1, 2, 3** or **4** jack on the TV.
- 2 No separate audio connection is necessary. HDMI supports both audio and video.

2. How to use

- Select the **HDMI1**, **HDMI2**, **HDMI3**, or **HDMI4** input source on the TV using the **INPUT** button on the remote control.
- Refer to the DVD player's manual for operating instructions.

NOTE

- ▶ If an HDMI cable doesn't support High Speed HDMI, it can cause flickers or no screen display. In this case use the latest cables that support High Speed HDMI.
- ▶ HDMI Audio Supported Format: Dolby Digital (32 kHz, 44.1 kHz, 48 kHz), Linear PCM (32 kHz, 44.1 kHz, 48 kHz)

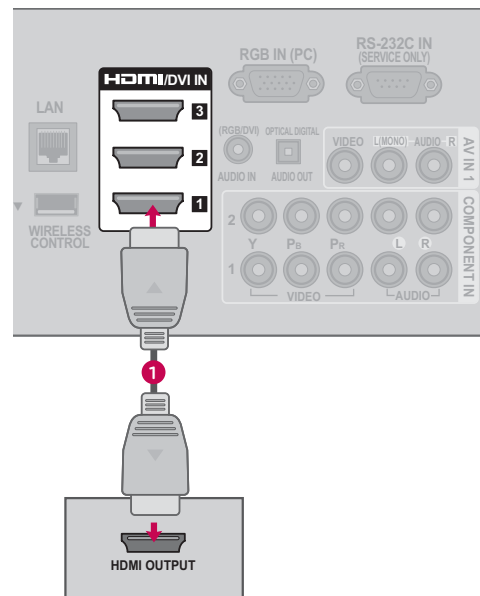

EXTERNAL EQUIPMENT SETUP

VCR SETUP

Antenna Connection

1. How to connect

- 1 Connect the RF antenna out socket of the VCR to the **ANTENNA/CABLE IN** socket on the TV.
- 2 Connect the antenna cable to the RF antenna in socket of the VCR.

2. How to use

- Set VCR output switch to 3 or 4 and then tune TV to the same channel number.
- Insert a video tape into the VCR and press PLAY on the VCR (Refer to the VCR owner's manual).

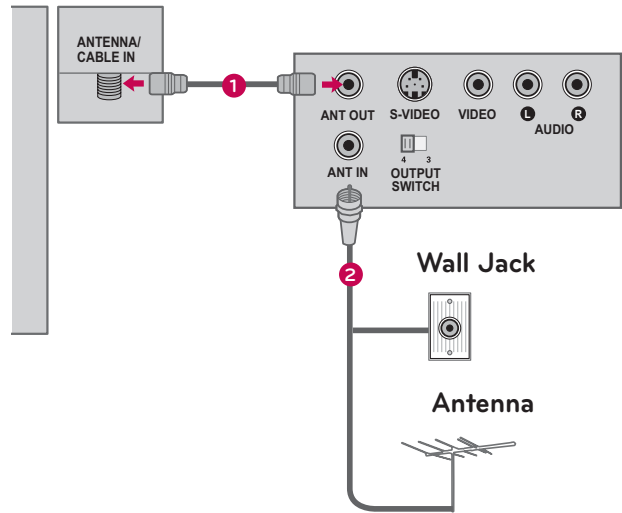

Composite (RCA) Connection

1. How to connect

- 1 Connect the **AUDIO/VIDEO** jacks between TV and VCR. Match the jack colors (Video = yellow, Audio Left = white, and Audio Right = red)

2. How to use

- Insert a video tape into the VCR and press PLAY on the VCR. (Refer to the VCR owner's manual.)
- Select the **AV1** or **AV2** input source on the TV using the **INPUT** button on the remote control.

NOTE

- ▶ If you have a mono VCR, connect the audio cable from the VCR to the **AUDIO L/MONO** jack of the TV.

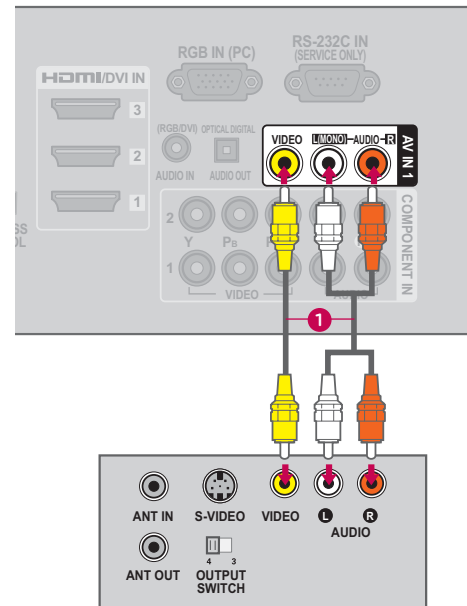

For LED LCD TV

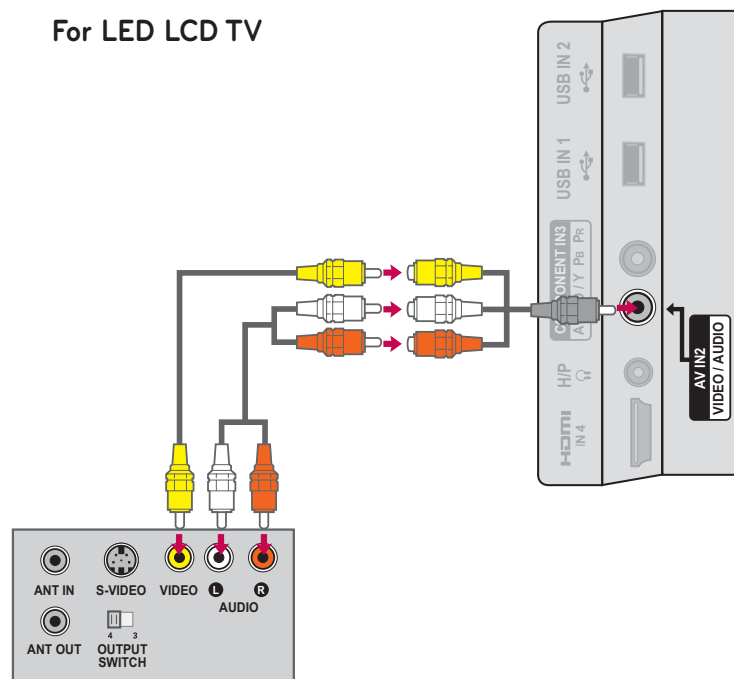

EXTERNAL EQUIPMENT SETUP

OTHER A/V SOURCE SETUP

1. How to connect

- 1 Connect the **AUDIO/VIDEO** jacks between TV and external equipment. Match the jack colors. (Video = yellow, Audio Left = white, and Audio Right = red)

2. How to use

- Select the **AV1** or **AV2** input source on the TV using the **INPUT** button on the remote control.
- Operate the corresponding external equipment.

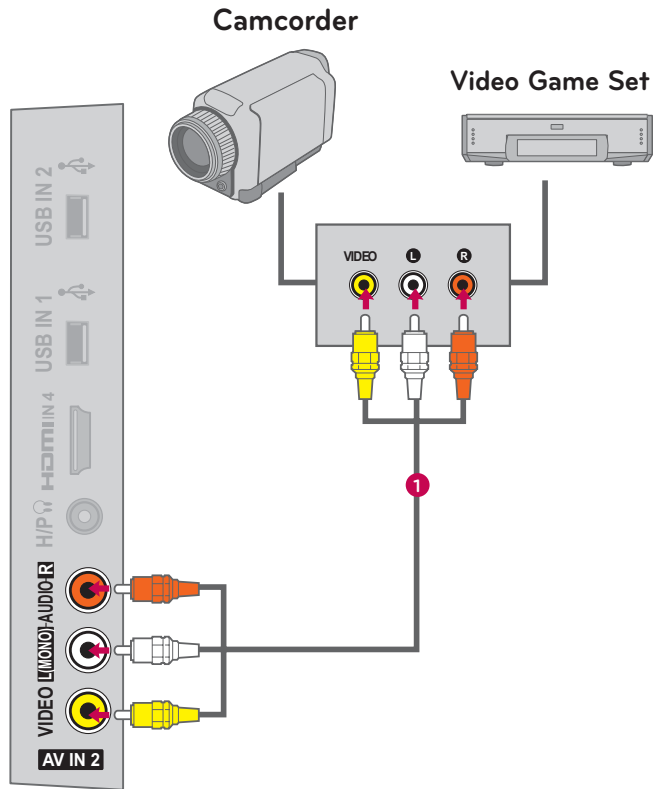

USB CONNECTION

1. How to connect

- 1 Connect the USB device to the **USB IN 1** or **2** jack on the side of TV.

2. How to use

- After connecting the **USB IN** jack, you use the USB function. (▶ p.97)

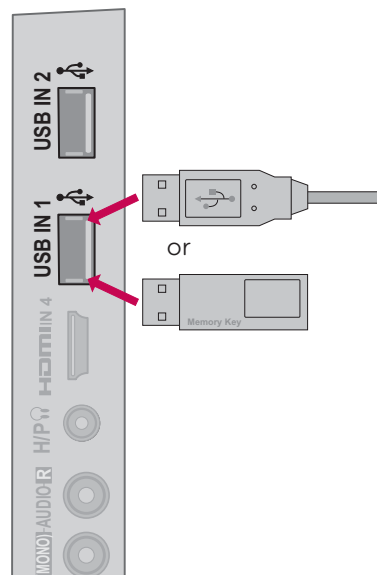

EXTERNAL EQUIPMENT SETUP

HEADPHONE SETUP (FOR LED LCD TV/LCD TV)

You can listen to the sound through the headphone.

1. How to connect

- 1 Plug the headphone into the headphone socket.
- 2 To adjust the headphone volume, press the **VOL +/-** button. If you press the **MUTE** button, the sound from the headphone is switched off.

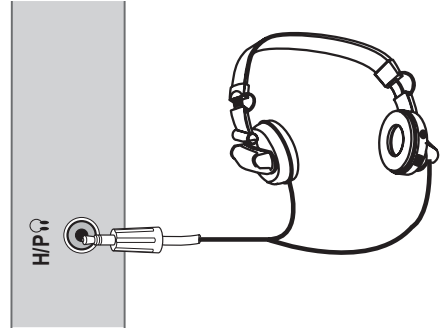

NOTE

- ▶ AUDIO menu options are disabled when connecting a headphone.
- ▶ When changing AV MODE with a headphone connected, the change is applied to video but not to audio.
- ▶ Optical Digital Audio Out is not available when connecting a headphone.

AUDIO OUT CONNECTION

Send the TV's audio to external audio equipment via the Audio Output port.

If you want to enjoy digital broadcasting through 5.1-channel speakers, connect the OPTICAL DIGITAL AUDIO OUT terminal on the back of TV to a Home Theater (or amp).

1. How to connect

- 1 Connect one end of the optical cable to the TV port of **OPTICAL DIGITAL AUDIO OUT**.
- 2 Connect the other end of the optical cable to the digital audio input on the audio equipment.
- 3 Set the "TV Speaker option - Off" in the AUDIO menu. (▶ p.150). See the external audio equipment instruction manual for operation.

NOTE

- ▶ When connecting with external audio equipment, such as amplifiers or speakers, you can turn the TV speakers off in the menu. (▶ p.150)

CAUTION

- ▶ Do not look into the optical output port. Looking at the laser beam may damage your vision.
- ▶ Audio with ACP (Audio Copy Protection) function may block digital audio output.

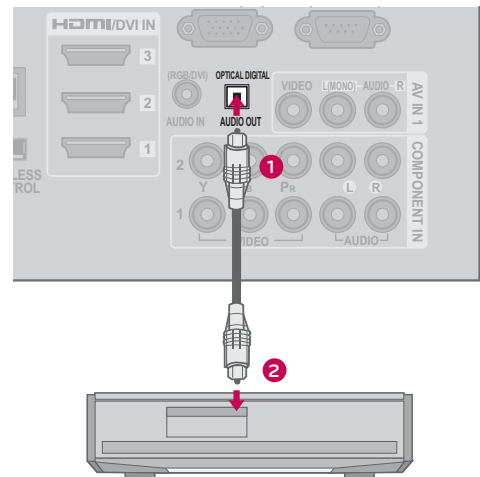

EXTERNAL EQUIPMENT SETUP

EXTERNAL EQUIPMENT WIRELESS CONNECTION (OPTIONAL EXTRAS, EXCEPT 42/42LE5350)

LG TVs with a Wireless Control port support the LG Wireless Media Box, which is sold separately. When you connect the wireless ready dongle (included with the media box) to the TV, external devices can be connected to the LG Wireless Media Box and video and audio will be sent to the TV wirelessly.

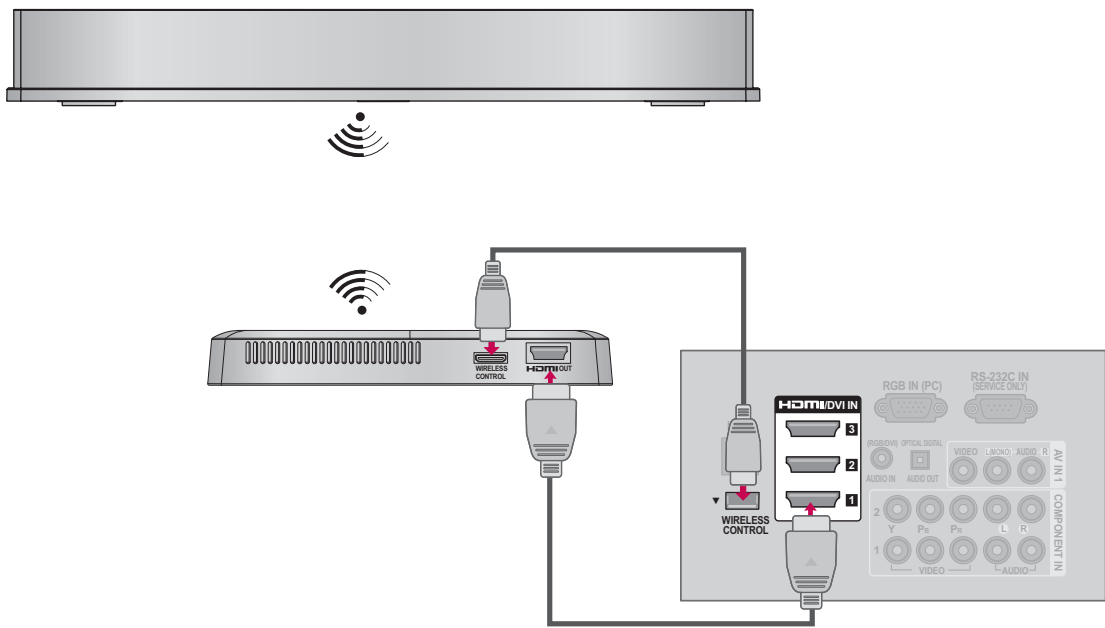

1. How to connect

- 1 Connect the **WIRELESS CONTROL** jack of the Wireless Ready Dongle to the **WIRELESS CONTROL** jack on the TV.
- 2 Connect **HDMI OUT** jack of the Wireless Ready Dongle to the **HDMI IN** jack on the TV.

2. How to use

- Select the desired input source on the TV using the **INPUT** button on the remote control.
- Refer to the Wireless Media Box manual for operating instructions.

NOTE

- ▶ When using the external device connected to the Wireless Media Box, some functions of the TV menu may not work.

PC SETUP

This TV provides Plug and Play capability, meaning that a PC adjusts automatically to the TV's settings.

VGA (D-Sub 15 Pin) Connection

1. How to connect

- 1 Connect the VGA output of the PC to the **RGB IN (PC)** jack on the TV.
- 2 Connect PC audio output to the **AUDIO IN (RGB/DVI)** jack on the TV.

2. How to use

- Turn on the PC and the TV.
- Select the **RGB-PC** input source on the TV using the **INPUT** button on the remote control.

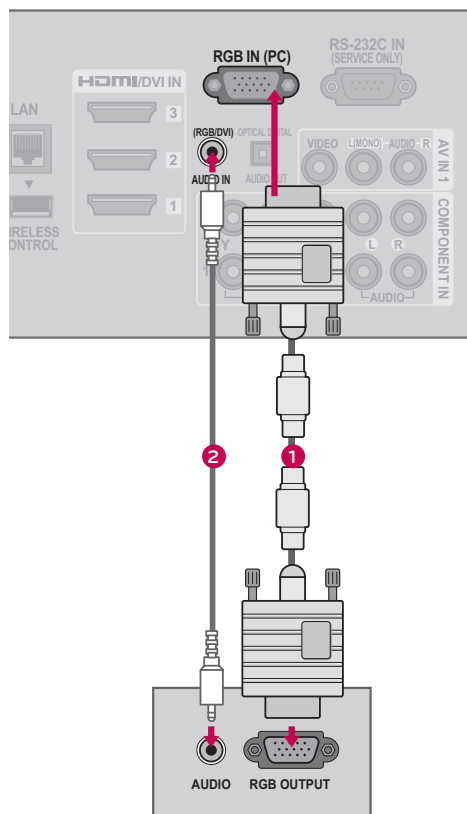

EXTERNAL EQUIPMENT SETUP

DVI to HDMI Connection

1. How to connect

- 1 Connect the DVI output of the PC to the **HDMI/DVI IN 1, 2, 3, or 4*** jack on the TV.
- 2 Connect the PC audio output to the **AUDIO IN (RGB/DVI)** jack on the TV.

2. How to use

- Turn on the PC and the TV.
- Select the **HDMI1, HDMI2, HDMI3, or HDMI4*** input source on the TV using the **INPUT** button on the remote control.

* *HDMI4: For Plasma TV*

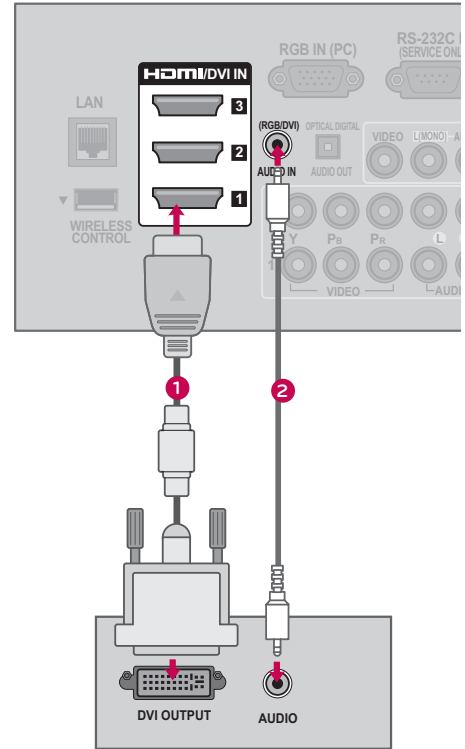

NOTE

- ▶ To get the the best picture quality, adjust the PC graphics card to **1920x1080**.
- ▶ Depending on the graphics card, DOS mode may not work if a HDMI to DVI Cable is in use.
- ▶ In PC mode, there may be noise associated with the resolution, vertical pattern, contrast or brightness. If noise is present, change the PC output to another resolution, change the refresh rate to another rate or adjust the brightness and contrast on the PICTURE menu until the picture is clear.
- ▶ Avoid keeping a fixed image on the screen for a long period of time. The fixed image may become permanently imprinted on the screen.
- ▶ The synchronization input form for Horizontal and Vertical frequencies is separate.
- ▶ Depending on the graphics card, some resolution settings may not allow the image to be positioned on the screen properly.
- ▶ If you experience overscan issues when using HDMI-PC 1920x1080, change aspect ratio to **Just scan**.
- ▶ When selecting HDMI-PC, set the "Input Label - PC" in the OPTION menu.

Supported Display Specifications (RGB-PC, HDMI-PC)

| Resolution | Horizontal Frequency (kHz) | Vertical Frequency (Hz) |
|----------------------|----------------------------|-------------------------|
| 640x350 | 31.468 | 70.09 |
| 720x400 | 31.469 | 70.08 |
| 640x480 | 31.469 | 59.94 |
| 800x600 | 37.879 | 60.31 |
| 1024x768 | 48.363 | 60.00 |
| 1280x768 | 47.776 | 59.87 |
| 1360x768 | 47.712 | 60.015 |
| 1280x1024 | 63.981 | 60.02 |
| 1920x1080 RGB-PC | 66.587 | 59.934 |
| 1920x1080 HDMI-PC | 67.50 | 60.00 |

EXTERNAL EQUIPMENT SETUP

Screen Setup for PC mode







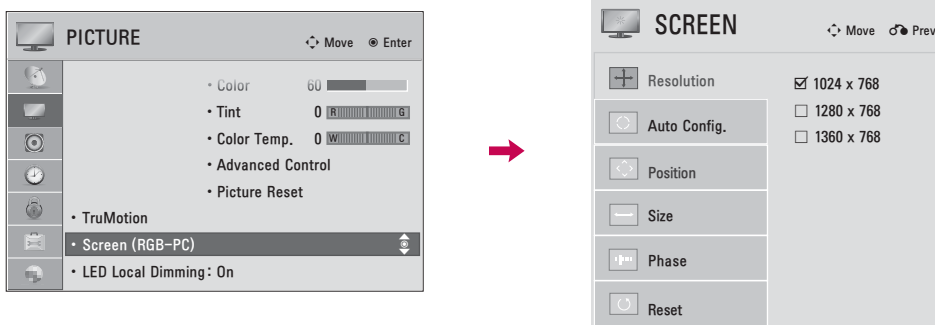

Selecting Resolution

You can choose the resolution in RGB-PC mode.

The Position, Phase, and Size can also be adjusted.

You can choose this option only when the PC resolution is set to 1024X768, 1280X768 or 1360X768.



- 1   Select **PICTURE**.
- 2   Select **Screen (RGB-PC)**.
- 3   Select **Resolution**.
- 4   Select the desired resolution.
- 5 

Auto Configure







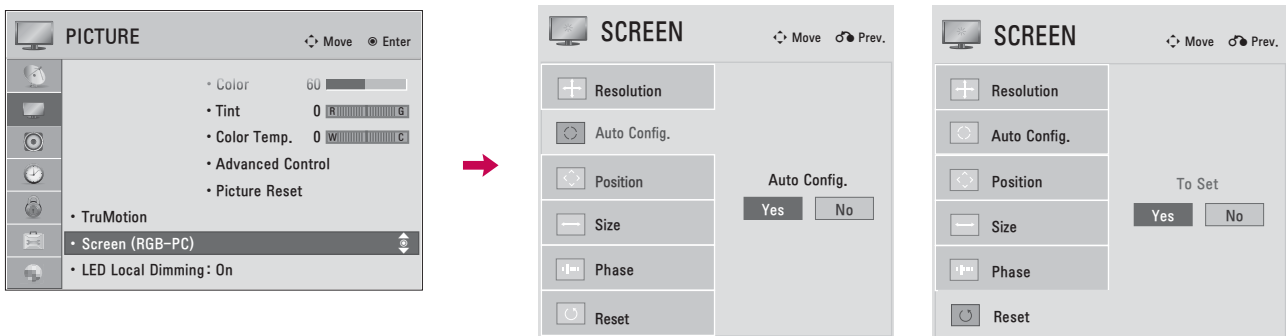

Automatically adjusts picture position and minimizes image instability. After adjustment, if the image is still not correct, try using the manual settings or a different resolution or refresh rate on the PC.

Screen Reset (Reset to original initial values)

Returns **Position**, **Size**, and **Phase** to the default initial settings.

This feature operates only in RGB-PC mode.



- 1   Select **PICTURE**.
- 2   Select **Screen (RGB-PC)**.
- 3   Select **Auto Config.** or **Reset**.
- 4   Select **Yes**.
- 5 









- If the position of the image is still not correct, try Auto adjustment again.
- If picture needs to be adjusted again after Auto adjustment in RGB-PC, you can adjust the **Position**, **Size** or **Phase**.

EXTERNAL EQUIPMENT SETUP

Adjustment for screen Position, Size, and Phase

If the picture is not clear after auto adjustment or if text is shaking, adjust the picture phase manually. This feature operates only in RGB-PC mode.



- 1   Select **PICTURE**.
- 2   Select **Screen (RGB-PC)**.
- 3   Select **Position, Size, or Phase**.
- 4   Make appropriate adjustments.
- 5 

- **Position:** This function is to adjust picture to left/right and up/down as you prefer.
- **Size:** This function is to minimize any vertical bars or stripes visible on the screen background. And the horizontal screen size will also change.
- **Phase:** This function allows you to remove any horizontal noise and clear or sharpen the image of characters.

NETWORK SETUP

Wired Network Connection

This TV can be connected to a local area network (LAN) via the LAN port. After making the physical connection, the TV needs to be set up for network communication.

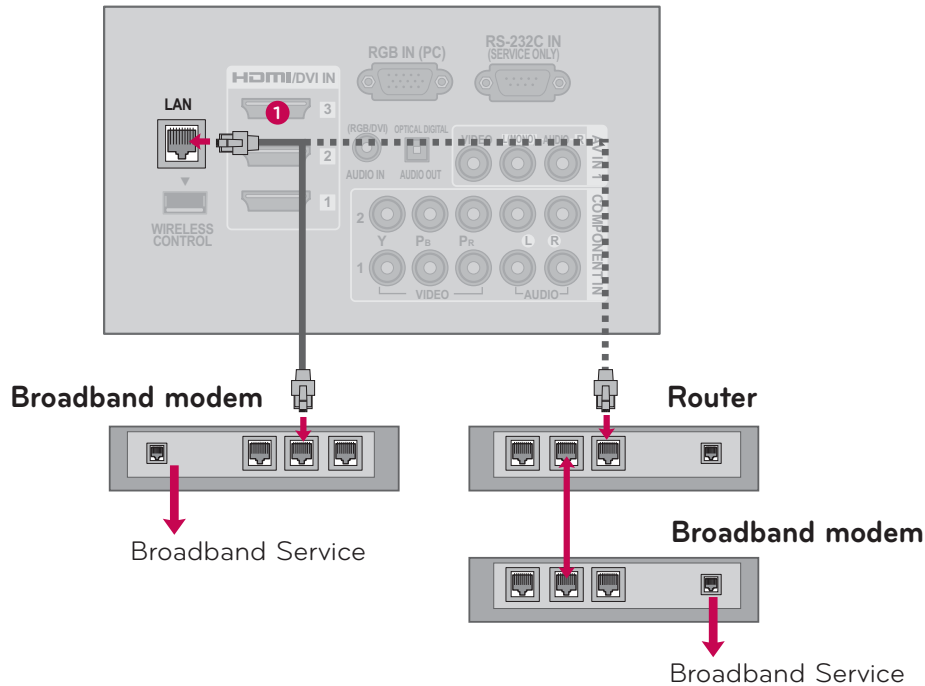

1. How to connect

- 1 Connect the LAN port of the Modem or Router to the **LAN** port on the TV.

2. How to use

- Select "**Network Setting**" in the NETWORK menu.
- After connecting the **LAN** port, use the NETCAST menu.
- For more information about NETCAST setup and troubleshooting, visit <http://lgknowledgebase.com>. Search for NETCAST.

⚠ CAUTION

- ▶ Do not connect a modular phone cable to the LAN port.
- ▶ Since there are various connection methods, please follow the specifications of your telecommunication carrier or internet service provider.

EXTERNAL EQUIPMENT SETUP

Wired Network Setup

If wired and wireless networks are both available, wired is the preferred method.

After making a physical connection, a small number of home networks may require the TV network settings to be adjusted.

For detail information, contact your internet provider or router manual.

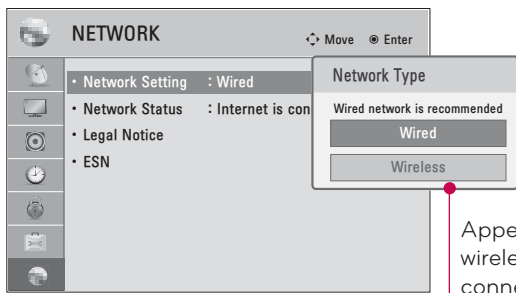

Appeared when wired and wireless are simultaneously connected.

If you already set the Network Setting

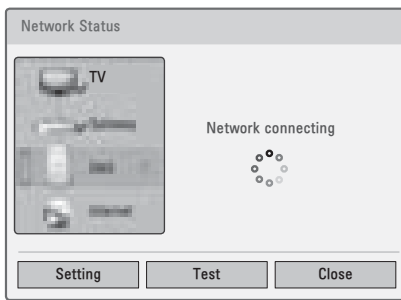
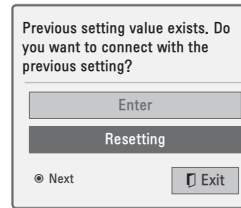

IP Auto Setting

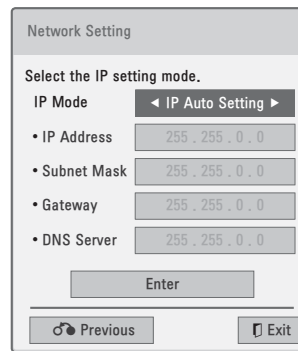

IP Manual Setting

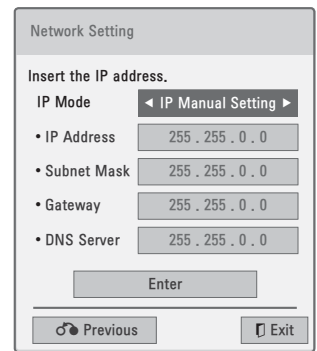

- 1 Select **NETWORK**.
- 2 Select **Network Setting**.
- 3 Select **Wired**.
- 4 If you already set Network Setting: Select **Resetting**. The new connection settings resets the current network settings.
- 5 Select **IP Auto Setting** or **IP Manual Setting**.
- 6 When Selecting **IP Manual Setting**: IP addresses will need to be input manually.
- 6 Select **Enter**.

- This feature requires an always-on broadband internet connection.
- You do not need to connect to a PC to use this function.
- If **Network Setting** is not working, check your network conditions. Check the LAN cable and make sure your router has DHCP turned on if you wish to use the Auto Setting.
- If the **Network Setting** is not completed, network may not operate normally.
- **IP Auto Setting**: Select it if there is a DHCP server on the local area network (LAN) via wired connection, the TV will automatically be allocated an IP address. If you're using a broadband router or broadband modem that has a DHCP (Dynamic Host Configuration Protocol) server function. The IP address will automatically be determined.
- **IP Manual Setting**: Select it if there is no DHCP server on the network and you want to set the IP address manually.

NOTE

- ▶ For more information about NETCAST setup and troubleshooting, visit <http://lgknowledgebase.com>. Search for NETCAST.
- ▶ Use a standard LAN cable with this TV. Cat5 or better with a RJ45 connector.
- ▶ Many network connection problems during set up can often be fixed by re-setting the router or modem. After connecting the player to the home network, quickly power off and/or disconnect the power cable of the home network router or cable modem. Then power on and/or connect the power cable again.
- ▶ Depending on the internet service provider (ISP), the number of devices that can receive internet service may be limited by the applicable terms of service. For details, contact your ISP.
- ▶ LG is not responsible for any malfunction of the TV and/or the internet connection feature due to communication errors/malfunctions associated with your broadband internet connection, or other connected equipment.
- ▶ LG is not responsible for problems within your internet connection.
- ▶ Some content available through the network connection may not be compatible with the TV. If you have questions about such content, please contact the producer of the content.
- ▶ You may experience undesired results if the network connection speed does not meet the requirements of the content being accessed.
- ▶ Some internet connection operations may not be possible due to certain restrictions set by the Internet service provider (ISP) supplying your broadband Internet connection.
- ▶ Any fees charged by an ISP including, without limitation, connection charges are your responsibility.
- ▶ A 10 Base-T or 100 Base-TX LAN port is required for connection to this TV. If your internet service does not allow for such a connection, you will not be able to connect the TV.
- ▶ A DSL modem is required to use DSL service and a cable modem is required to use cable modem service. Depending on the access method of and subscriber agreement with your ISP, you may not be able to use the internet connection feature contained in this TV or you may be limited to the number of devices you can connect at the same time. (If your ISP limits subscription to one device, this TV may not be allowed to connect when a PC is already connected.)
- ▶ The use of a "Router" may not be allowed or its usage may be limited depending on the policies and restrictions of your ISP. For details, contact your ISP directly.
- ▶ The wireless network operates at 2.4 GHz radio frequencies that are also used by other household devices such as cordless telephone, Bluetooth® devices, microwave oven, and can be affected by interference from them. It can be interrupted by the device using 5Ghz radio frequencies. It is same device with LG wireless media box, cordless telephone, other Wi-Fi device.
- ▶ It may decrease the service speed using Wireless network by surrounding wireless condition.
- ▶ Turn off all unused network equipment in your local home network. Some devices may generate network traffic.
- ▶ In some instances, placing the access point or wireless router higher up away from the floor may improve the reception.
- ▶ The reception quality over wireless depends on many factors such as type of the access point, distance between the TV and access point, and the location of the TV.
- ▶ When connecting internet through the wired/wireless sharing machine, it may interrupt the connection because of the use limitation and confirmation of service company.
- ▶ To connect wireless AP, an AP that supports the wireless connection is necessary, and the wireless connection function of the AP needs to be activated. Please enquire to the AP supplier for the possibility of AP wireless connections.
- ▶ Please verify the security settings of AP SSID for wireless AP connection, and enquire to the AP supplier for the AP SSID security settings.
- ▶ The TV can become slower or malfunction with wrong settings of network equipments (wired/wireless router, hub, etc). Please install correctly by referring to the manual of the equipment, and set the network.
- ▶ When AP is set to include 802.11 n, and if Encryption is designated as WEP(64/128bit) or WPA(TKIP/AES), the connection may not be possible. There may be different connection methods according to the AP manufacturers.

Wireless Network Setup (Except 42/47LE5350)

Setting up the AP (Access Point) or the wireless router is required before connecting the TV to the network.

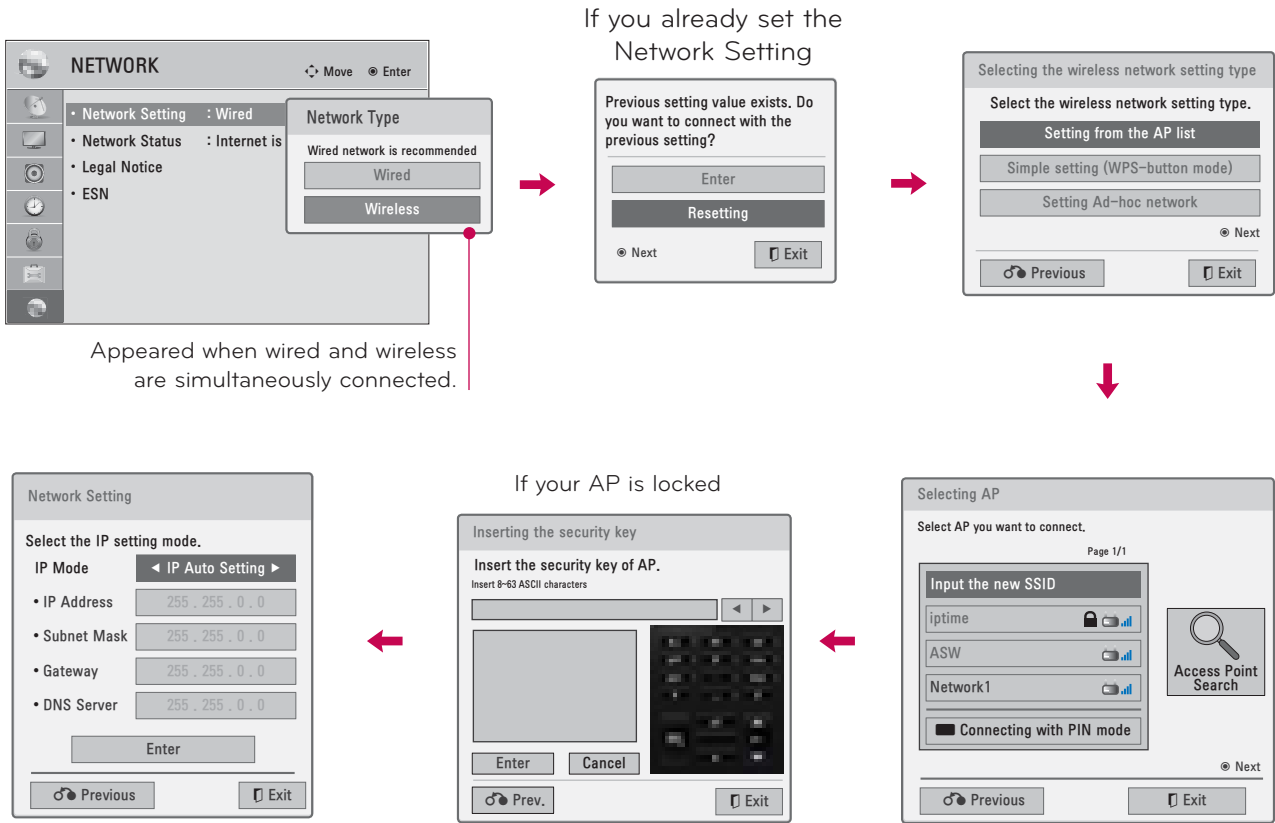

1 Select **NETWORK**.

2 Select **Network Setting**.

3 Select **Wireless**.

4 If you already set Network Setting: Select **Resetting**.
The new connection settings resets the current network settings.

5 Select **Setting from the AP list**.

6 Scan the all available AP (Access Point) or wireless routers within range and display them as a list.

7 Select an AP (Access Point) or wireless router on the list.
(If your AP is locked, insert the security key of AP).

8 Input the security key of AP.

9 Repeat step 4-5 on P.56.

EXTERNAL EQUIPMENT SETUP

When a security code is already set

PIN (Personal Identification Number)

If you want to connect the AP (Access Point) or router with PIN, use this feature.

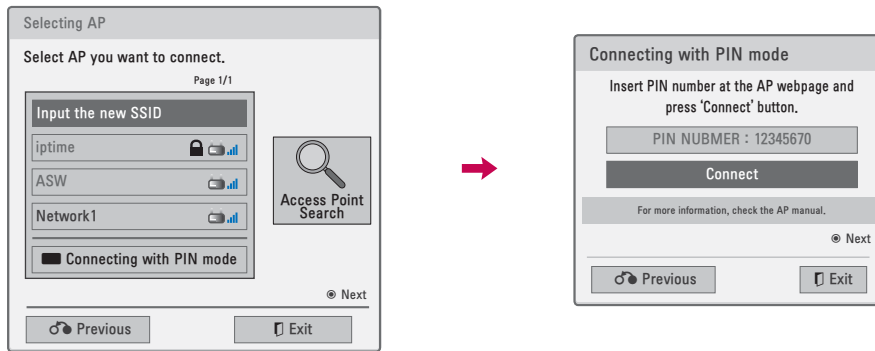

1 Repeat step 1-6 on P.59.

2  Connect the access point with **PIN** mode.

3 You can see the Network ID and Security Key on your TV screen.
Enter the PIN number to your device.

4  Select **Connect**.

5 Repeat step 4-5 on P.56.

■ PIN number is the unique 8 digit number of the dongle.

Simple setting (WPS-button mode)

If your access point or wireless router that supports PIN or WPS (Wi-Fi Protected Setup), it's available to use your access point or wireless router within 120 counts. You do not need to know the access point name (SSID: Service Set Identifier) and security code of your access point or wireless router.

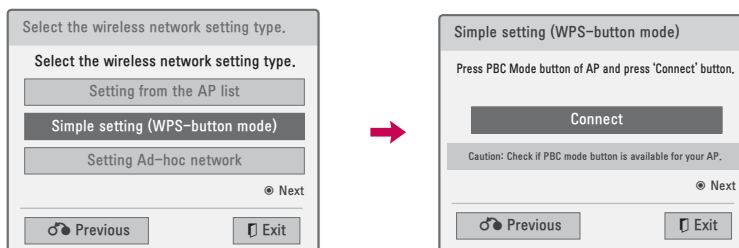

1 Repeat step 1-4 on P.59.

2   Select **Simple setting (WPS-button mode)**.

3  Select **Connect**.

4 Repeat step 4-5 on P.56.

AD-hoc Mode

This is the method of communicating directly with the machine to communicate without AP.

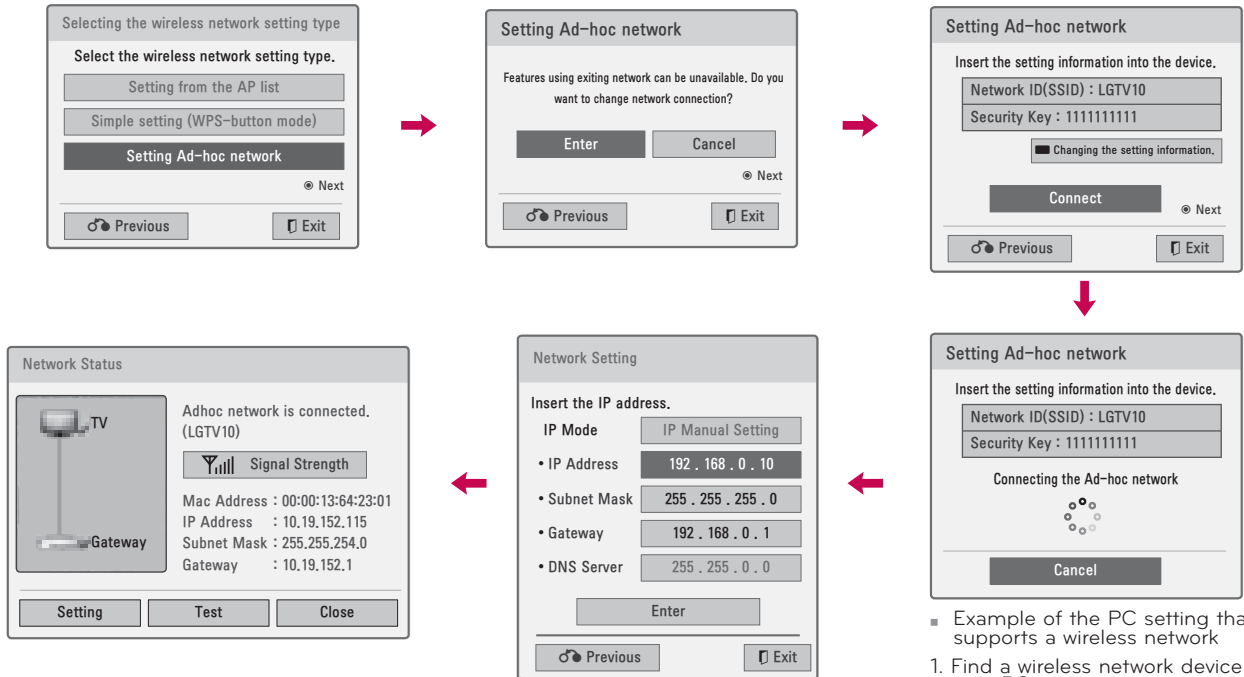

This is the same as connecting two PCs with a cross cable.



- PC Setting
Internet Protocol(TCP/IP) of PC needs to be set manually.
IP address, Subnet Mask, and default Gateway can be set with your own discretion.
i.e) IP address: 192.168.0.1 / Subnet Mask: 255.255.255.0 / default Gateway: 192.168.0.10
- TV Setting
Verify IP address and gateway of PC.
Input Gateway address of PC to IP Address, and IP Address of PC to Gateway, and select **Enter**.
i.e) IP address: 192.168.0.10 / Subnet Mask: 255.255.255.0 / default Gateway: 192.168.0.1

- Example of the PC setting that supports a wireless network
1. Find a wireless network device in your PC.
 2. Select LGTV10 that appears in the list. (Select the same name as the network ID that appears on your TV screen.)
 3. Type 1111111111 in the Inserting the security key dialog. (Type the security key that appears on your TV screen.)

1 Repeat step 1-3 on P.59.

2   Select **Setting AD-hoc network**.

3    Select **Enter**.

4  Select **Connect** to connect Ad-hoc network.

You can see the Network ID and Security Key on your TV screen.
Enter this Network ID and Security Key to your device.

If a network may not operate, change the setting information using the RED button.

5   Insert the IP address.

6   Network setting is completed. Select **Close**.

EXTERNAL EQUIPMENT SETUP

Network Status

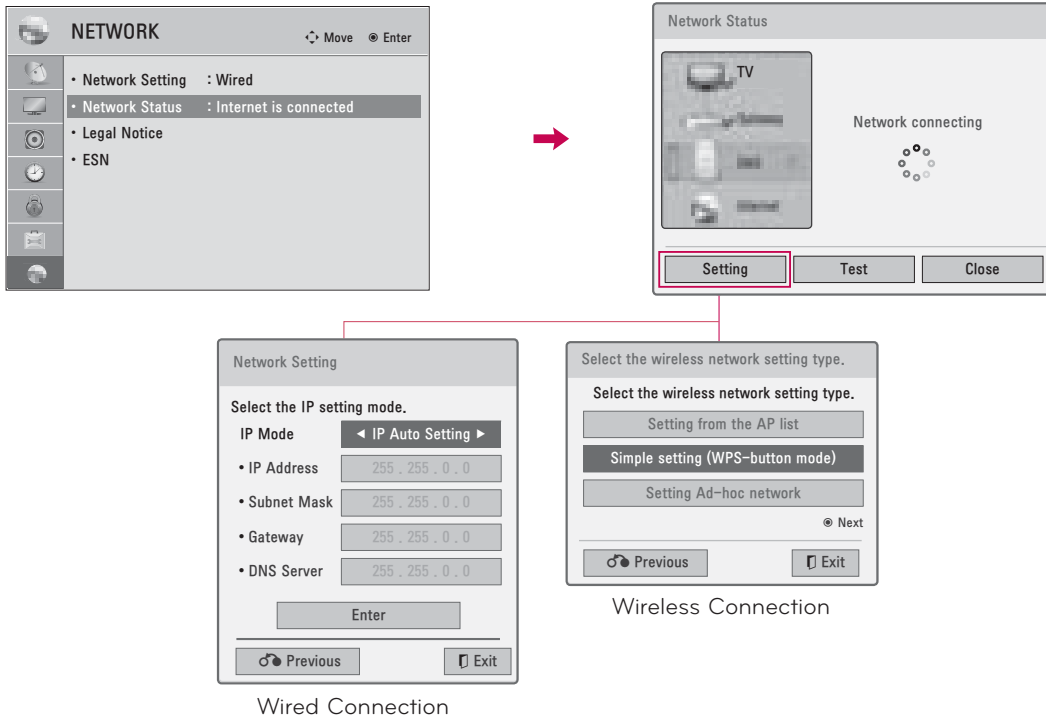

- 1 Select **NETWORK**.
- 2 Select **Network Status**.
- 3 Check the network status.

- **Setting:** Return to the network setting menu or wireless network setting type menu.
- **Test:** Test the current network status after setting the network.
- **Close:** Return to the previous menu.

WATCHING TV / CHANNEL CONTROL

REMOTE CONTROL FUNCTIONS

When using the remote control, aim it at the remote control sensor on the TV.
The remote control may differ from the images below.



POWER Turns the TV on from standby or off to standby.

LIGHT Illuminates the remote control buttons.
(Except 32/42/46/52/60LD550, 47/55LD650)

ENERGY SAVING Adjusts the Energy Saving setting. ▶p.132

AV MODE Toggles through preset Video and Audio modes. ▶p.88

INPUT Rotates through inputs.
Also switches the TV on from standby.

TV Returns to the last TV channel.

NUMBER button

– (DASH) Used to enter a program number for multiple program channels such as 2-1, 2-2, etc.

LIST Displays the channel table.

FLASHBK Tunes to the last channel viewed.

VOLUME UP/DOWN Adjusts the volume.

FAV Set up desired favorite channels list.

MARK Select the input to apply the Picture Wizard settings. ▶p.131
Use to mark or unmark a photo/music/movie. ▶p.105, 110, 116

RATIO Changes the aspect ratio. ▶p.128

3D Used for viewing the 3D video. ▶p.94

CHAR/NUM Shifts the Character or Number for internet service.

MUTE Switches the sound on or off.

DELETE Deleted the character or number on the screen.

CHANNEL UP/DOWN Changes the channel.

PAGE UP/DOWN Moves from one full set of screen information to the next one.



WATCHING TV / CHANNEL CONTROL

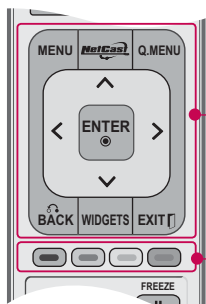

MENU, HOME

Displays the main menu or clears all on-screen displays and return to TV viewing.

NETCAST, PREMIUM

Select the desired NETCAST menu source. ▶ p.123

Q.MENU

Opens the list of Quick Menu options. ▶ p.71

THUMBSTICK (Up/Down/Left Right/ENTER)

Navigates the on-screen menus and adjusts the system settings to your preference.

BACK

Allows the user to move return one step in an interactive application or other user interaction function.

WIDGETS

WIDGETS for showing or hiding the Yahoo! Dock and accessing the Yahoo! TV Widgets user experience.

INFO

Displays channel information at the bottom of the screen. ▶ p.81

EXIT

Clears all on-screen displays and return to TV viewing.

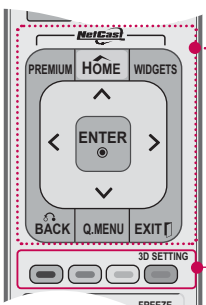
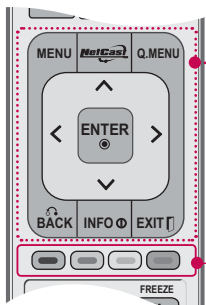

COLOR BUTTON

Access special functions in some menus.

L/R SELECT, 3D SETTING

Used for viewing the 3D video. ▶ p.95

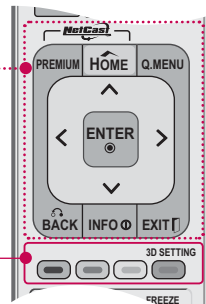
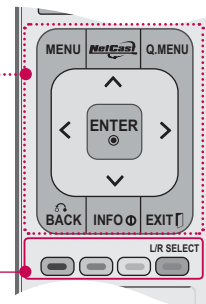
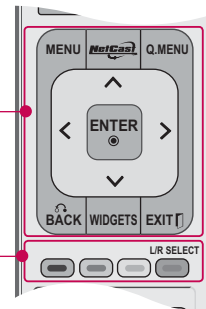

USB, SIMPLINK Control buttons

- Controls MY MEDIA menu (Movie List, Photo List, Music List)
- Controls the SIMPLINK compatible devices.

FREEZE (For Plasma TV)

Pause the present picture at the screen. (It doesn't work at USB Mode and Simplink.)

The TV returns to normal viewing automatically if no signal is received or no operation is performed for 5 minutes. If you keep the screen in Freeze condition, the residual image can exist.

SIMPLINK

See a list of AV devices connected to TV.

When you toggle this button, the SIMPLINK menu appears at the screen. ▶ p.90

RATIO

Changes the aspect ratio. ▶ p.128

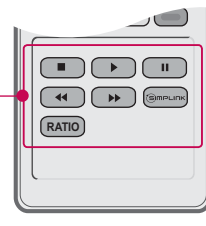
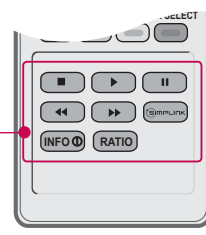

Simple Remote Control (For 42/47/55LE7500, 47/55LE8500)

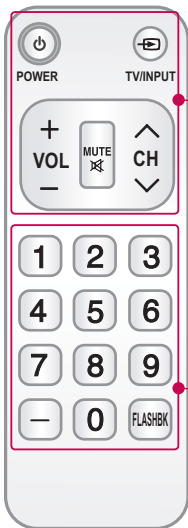

- POWER** Turns the TV on from standby or off to standby.
- TV/INPUT** Rotates through inputs.
Also switches the TV on from standby. ▶p.83
- VOLUME UP/DOWN** Adjusts the volume.
- MUTE** Switches the sound on or off. ▶p.66
- CHANNEL UP/DOWN** Changes the channel.

NUMBER button

- (DASH)** Used to enter a program number for multiple program channels such as 2-1, 2-2, etc.
- FLASHBK** Tunes to the last channel viewed.

Installing Batteries

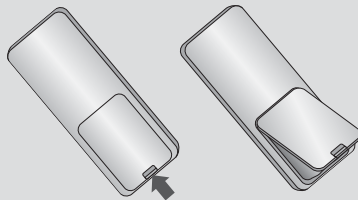

- Open the battery compartment cover on the back side and install the batteries matching correct polarity.
- Install two 1.5V AAA batteries. Don't mix old or used batteries with new ones.
- Close cover.

Installing Batteries

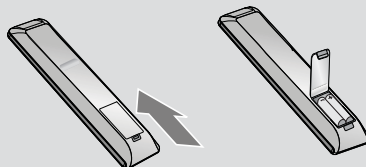

- Open the battery compartment cover on the back side and install the batteries matching correct polarity.
- Install two 1.5V AAA batteries. Don't mix old or used batteries with new ones.
- Close cover.

WATCHING TV / CHANNEL CONTROL

TURNING ON THE TV

- 1 First, connect power cord correctly.
At this moment, the TV switches to standby mode.
 - In standby mode to turn TV on, press the **⏻** / **I**, **INPUT**, **CH (▲ or ▼)** button on the TV or press the **⏻**, **INPUT**, **CH (▲ or ▼)**, **Number (0-9)** button on the remote control.
 - 2 Select the viewing source by using the **INPUT** button on the remote control.
 - 3 When finished using the TV, press the **POWER** button on the remote control. The TV reverts to standby mode.
-

NOTE

- ▶ If you intend to be away on vacation, disconnect the power plug from the wall power outlet.
- ▶ If you do not complete the **Initial setting**, it will appear whenever the TV is switched on until the **Initial setting** procedure is completed.

CHANNEL SELECTION

- 1 Press the **CH (▲ or ▼)** or **NUMBER** buttons to select a channel number.
-

VOLUME ADJUSTMENT

Adjust the volume to suit your personal preference.

- 1 Press the **VOL (+ or -)** button to adjust the volume.
 - 2 If you want to switch the sound off, press the **MUTE** button.
 - 3 You can cancel the Mute function by pressing the **MUTE** or **VOL (+ or -)** button.
-

INITIAL SETTING

This Function guides the user to easily set the essential items for viewing the TV for the first time when purchasing the TV. It will be displayed on the screen when turning the TV on for the first time. It can also be activated from the user menus.

- Default selection is "**Home Use**". We recommend setting the TV to "**Home Use**" mode for the best picture in your home environment.
- "**Store Demo**" Mode is only intended for use in retail environments. Customers can adjust the "**Picture** menu - **Picture mode**" manually while inspecting the TV, but the TV will automatically return to preset in-store mode after 5 minutes.
- "**Store Demo**" Mode is an optimal setting for displaying at stores. "Store Demo" mode initializes the TV to set the image quality:

Step 1. Selecting Language



Select Menu Language.



Step 2. Mode setting

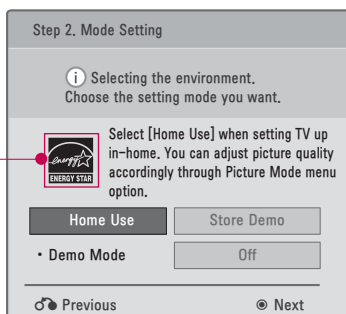

Select **Home Use**.



Except Plasma TV, 32LD550

WATCHING TV / CHANNEL CONTROL

Step 3. Power Indicator (For LED LCD TV)

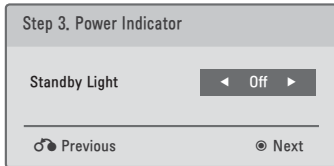



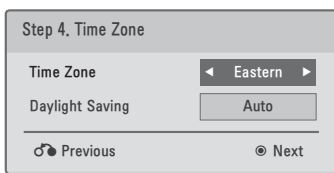

- 1  Select **On** or **Off**.
- 2 

■ This function is disabled in "Step2. Mode Setting - Store Demo".

Step 4. Time Zone



- 1  Select **Time Zone** option.
- 2   Select **Daylight Saving** option.
- 3 

Step 5. Auto Tuning

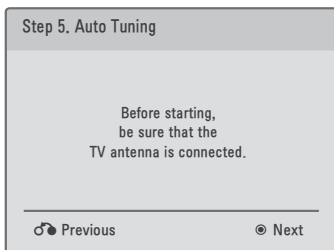

- 1  Check your antenna connection and start **Auto Tuning**.