

JVC

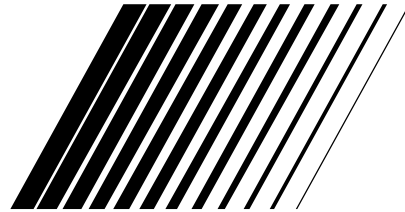

DVD DIGITAL THEATER SYSTEM

TH-G51J

Consists of XV-THG51, SP-THG51F,
SP-THG61C, SP-THG50W and RX-THG51



iPod is a trademark of Apple Inc., registered in the U.S. and other countries.

INSTRUCTIONS

For Customer Use:

Enter below the Model No. and Serial No. which are located on the rear of cabinet. Retain this information for future reference.

Model No. _____

Serial No. _____

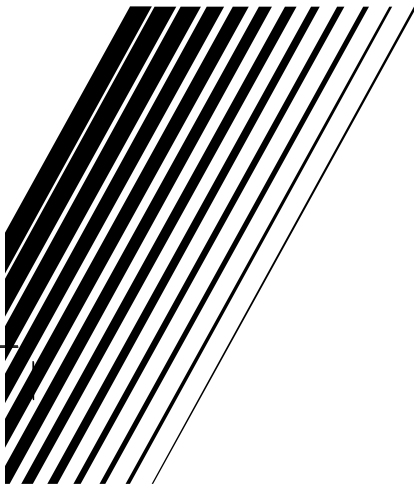



CAUTION: TO REDUCE THE RISK OF ELECTRIC SHOCK DO NOT REMOVE COVER (OR BACK) NO USER-SERVICEABLE PARTS INSIDE REFER SERVICING TO QUALIFIED SERVICE PERSONNEL.



This lightning flash with arrowhead symbol within an equilateral triangle is intended to alert the user to the presence of uninsulated dangerous voltage within the product's enclosure that may be of sufficient magnitude to constitute a risk of electric shock to persons.



The exclamation point within an equilateral triangle is intended to alert the user to the presence of important operating and maintenance (servicing) instructions in the literature accompanying the product.

WARNING: TO REDUCE THE RISK OF FIRE OR ELECTRIC SHOCK, DO NOT EXPOSE THIS APPARATUS TO RAIN OR MOISTURE AND OBJECTS FILLED WITH LIQUIDS, SUCH AS VASES, SHOULD NOT BE PLACED ON THIS APPARATUS.

WARNING: Do not install this equipment in a confined space such as a bookcase or similar unit.

CAUTION: Do not block any ventilation openings. Install in accordance with the manufacturer's instructions.

Slots and openings in the cabinet are provided for ventilation and to ensure reliable operation of the product and to protect it from over heating.

The openings shall be never be blocked by placing the product on a bed, sofa, rug or other similar surface. This product shall not be placed in a built-in installation such as a bookcase or rack unless proper ventilation is provided or the manufacturer's instruction have been adhered to.

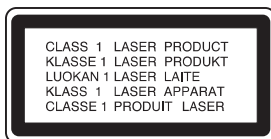

CAUTION:

This product employs a Laser System.

To ensure proper use of this product, please read this owner's manual carefully and retain it for future reference. Shall the unit require maintenance, contact an authorized service center.

Use of controls, adjustments or the performance of procedures other than those specified herein may result in hazardous radiation exposure.

To prevent direct exposure to laser beam, do not try to open the enclosure. Visible laser radiation when open. DO NOT STARE INTO BEAM.

CAUTION: The apparatus shall not be exposed to water (dripping or splashing) and no objects filled with liquids, such as vases, shall be placed on the apparatus.

CAUTION concerning the Power Cord

Most devices are recommended be placed on a dedicated circuit;

That is, a single outlet circuit which powers only that electronic device and has no additional outlets or branch circuits. Check the specification page of this owner's manual to be certain.

Do not overload wall outlets. Overloaded wall outlets, loose or damaged wall outlets, extension cords, frayed power cords, or damaged or cracked wire insulation are dangerous. Any of these conditions could result in electric shock or fire. Periodically examine the cord of your appliance, and if its appearance indicates damage or deterioration, unplug it, discontinue use of the appliance, and have the cord replaced with an exact replacement part by an authorized servicer.

Protect the power cord from physical or mechanical abuse, such as being twisted, kinked, pinched, closed in a door, or walked upon. Pay particular attention to plugs, wall outlets, and the point where the cord exits the appliance. To disconnect power from the mains, pull out the mains cord plug. When installing the product, ensure that the plug is easily accessible.

NOTE TO CABLE/TV INSTALLER: This reminder is provided to call the cable TV system installer's attention to Article 820-40 of the National Electric Code (U.S.A.). The code provides guidelines for proper grounding and, in particular, specifies that the cable ground shall be connected to the grounding system of the building, as close to the point of the cable entry as practical.

FCC WARNING: This equipment may generate or use radio frequency energy. Changes or modifications to this equipment may cause harmful interference unless the modifications are expressly approved in the instruction manual. The user could lose the authority to operate this equipment if an unauthorized change or modification is made.

REGULATORY INFORMATION: FCC Part 15

This equipment has been tested and found to comply with the limits for a Class B digital device, pursuant to Part 15 of the FCC Rules. These limits are designed to provide reasonable protection against harmful interference when the product is operated in a residential installation.

This product generates, uses, and can radiate radio frequency energy and, if not installed and used in accordance with the instruction manual, may cause harmful interference to radio communications. However, there is no guarantee that interference will not occur in a particular installation. If this product does cause harmful interference to radio or television reception, which can be determined by turning the product off and on, the user is encouraged to try to correct the interference by one or more of the following measures:

- Reorient or relocate the receiving antenna.
- Increase the separation between the product and receiver.
- Connect the product into an outlet on a circuit different from that to which the receiver is connected.
- Consult the dealer or an experienced radio/TV technician for help.

- Labelling information:

This device complies with Part 15 of the FCC rules. Operation is subject to the following two conditions: (1) This device may not cause harmful interference, and (2) This device must accept any interference received, including interference that may cause undesired operation.

- RF Exposure Statement:

The antenna(s) used for this transmitter must be installed to provide a separation distance of at least 20 cm from all persons and must not be colocated or operating in conjunction with any antenna or transmitter other than those contained in this device.

IMPORTANT SAFETY INSTRUCTIONS

CAUTION: PLEASE READ AND OBSERVE ALL WARNINGS AND INSTRUCTIONS IN THIS OWNER'S MANUAL. AND THOSE MARKED ON THE PRODUCT. RETAIN THIS BOOKLET FOR FUTURE REFERENCE.

This product has been designed and manufactured to assure personal safety. Improper use can result in electric shock or fire hazard. The safeguards incorporated in this product will protect you if you observe the following procedures for installation, use, and servicing.

This product does not contain any parts that can be repaired by the user.

DO NOT REMOVE THE CABINET COVER, OR YOU MAY BE EXPOSED TO DANGEROUS VOLTAGE. REFER SERVICING TO QUALIFIED SERVICE PERSONNEL ONLY.

- 1. Read these instructions.** - All these safety and operating instructions should be read before the product is operated.
- 2. Keep these instructions.** - The safety, operating and use instructions should be retained for future reference.
- 3. Heed all warnings.** - All warnings on the product and in the operating instructions should be adhered to.
- 4. Follow all instructions.** - All operating and use instructions should be followed.
- 5. Do not use this apparatus near water.** - For example: near a bath tub, wash bowl, kitchen sink, laundry tub, in a wet basement; or near a swimming pool; and other areas located near water.
- 6. Clean only with dry cloth.** - Unplug this product from the wall outlet before cleaning. Do not use liquid cleaners.
- 7. Do not block any ventilation openings. Install in accordance with the manufacturer's instructions.** - Slots and openings in the cabinet are provided for ventilation and to ensure reliable operation of the product and to protect it from over-heating. The openings should never be blocked by placing the product on a bed, sofa, rug or other similar surface. This product should not be placed in a built-in installation such as a bookcase or rack unless proper ventilation is provided or the manufacturer's instructions have been adhered to.
- 8. Do not install near any heat sources such as radiators, heat registers, stoves, or other apparatus (including amplifiers) that produce heat.**
- 9. Do not defeat the safety purpose of the polarized or grounding-type plug. A polarized plug has two blades with one wider than the other. A grounding type plug has two blades and a third grounding prong. The wide blade or the third prong are provided for your safety. If the provided plug does not fit into your outlet, consult an electrician for replacement of the obsolete outlet.**
- 10. Protect the power cord from being walked on or pinched particularly at plugs, convenience receptacles, and the point where they exit from the apparatus.**
- 11. Only use attachments/accessories specified by the manufacturer.**
- 12. Use only with the cart, stand, tripod, bracket, or table specified by the manufacturer, or sold with apparatus. When a cart is used, use caution when moving the cart/product combination to avoid injury from tip-over.**
- 13. Unplug this apparatus during lightning storms or when unused for long periods of time.**
- 14. Refer all servicing to qualified service personnel. Servicing is required when the product has been damaged in any way, such as power-supply cord or plug is damaged, liquid has been spilled or objects have fallen into the apparatus, the product has been exposed to rain or moisture, does not operate normally, or has been dropped.**



Contents

Introduction	2-5	LOCK (PARENTAL CONTROL)	14
About the  Symbol Display	2	• Initial Setting the Area Code	14
Symbol Used in this Manual	2	• Rating	14
Screen Saver	2	• Password	14
Notes on Discs	2	• Area Code	14
Handling Discs	2	OTHERS	14
Storing Discs	2	Operations	15-22
Cleaning Discs	2	General Features	15
Types of Playable Discs	3	Additional Features	16
Regional Code	3	Playing an Audio CD or MP3/WMA file	17
Front Panel	4	Programmed Playback	18
Remote Control	5	Repeat Programmed Tracks	18
Remote Control operation	5	Erasing a Track from Program List	18
Remote Control Battery installation	5	Erasing the Complete Program List	18
Installation and Setup	6-13	Viewing a JPEG file	19
TV Connection	6	Slide Show	19
Video connection	6	Still Picture	19
Component Video connection	6	Moving to another file	19
Antenna Connection	6	Rotating the picture	19
Optional Equipment Connection	7	Listening to music during slide show	19
AUX IN connection (A)	7	Using iPod	20
OPTICAL IN connection (O)	7	General operation	20
HDMI In connection (H)	7	General features	20
AUDIO IN connection (D)	7	Presetting the Radio Stations	21
iPod connection (I)	7	To tune in a station with a weak signal	21
HDMI Connection	8	To clear all the stored stations	21
About HDMI	8	Listening to the Radio	21
Resolution setting	8	To turn off the radio	21
Available resolution according to connection	8	To listen to non-preset radio stations	21
Setup the wireless system	9	To select a preset radio station directly	21
Initial Setting an ID of Wireless	9	Sleep Timer Setting	22
Setting an ID of Wireless	9	Dimmer	22
Speaker System Connection	10	Muting	22
Displaying Disc Information on-screen	11	Setting the disc ejection lock	22
Initial Settings	11-14	Enjoying audio form an external source	22
OSD Initial language settings	11	Setting the surround mode	22
General Operation	12	Reference	23-26
Language	12	Language Codes	23
• Menu language	12	Area Codes	23
• Disc Audio / Subtitle / Menu	12	Troubleshooting	24-25
DISPLAY	12	Specifications	26
• TV Aspect	12		
• Display Mode	12		
AUDIO	13		
• Dynamic Range Control (DRC)	13		
• Vocal	13		
• HD AV Sync	13		
5.1 SPEAKER SETUP	13-14		

Introduction

To ensure proper use of this product, please read this owner's manual carefully and retain it for future reference.

This manual provides information on the operation and maintenance of your DVD player. Should the unit require service, contact an authorized service location.

About the Symbol Display

"" may appear on your TV display during operation and indicates that the function explained in this owner's manual is not available on that specific DVD video disc.

Symbol Used in this Manual







Note:

Indicates special notes and operating features.

Tip:

Indicates tips and hints for making the task easier.

A section whose title has one of the following symbols is applicable only to the disc represented by the symbol.

-  All discs and file listed below
-  DVD and finalized DVD±R/RW
-  Audio CDs
-  MP3 files
-  WMA files
-  JPEG files

Screen Saver

The screen saver activates when there is no operation made for approximately 5 minutes since a still picture was last displayed.

To cancel the screen saver, push any key.

Notes on Discs

Handling Discs

Do not touch the playback side of the disc. Hold the disc by the edges so that fingerprints do not get on the surface. Never stick paper or tape on the disc.



Storing Discs

After playing, store the disc in its case. Do not expose the disc to direct sunlight or sources of heat and never leave it in a parked car exposed to direct sunlight.

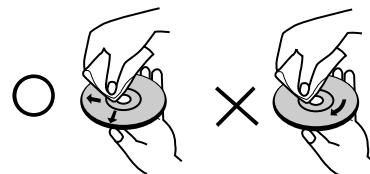

Cleaning Discs

Fingerprints and dust on the disc can cause poor picture quality and sound distortion. Before playing, clean the disc with a clean cloth. Wipe the disc from the center out.



Do not use strong solvents such as alcohol, benzene, thinner, commercially available cleaners, or anti-static spray intended for older vinyl records.

Types of Playable Discs

	DVD (8 cm / 12 cm disc)
	Audio CD (8 cm / 12 cm disc)

In addition, this unit plays DVD±R/RW and CD-R/RW, Dual disc that contains audio titles, MP3, WMA, and/or JPEG files.

Notes:

- Depending on the conditions of the recording equipment or the CD-R/RW (or DVD±R/RW) disc itself, some CD-R/RW (or DVD±R/RW) discs may not be played on the unit.
- Do not use irregularly shaped CDs (e.g., heart-shaped or octagonal) since they may result in malfunctions.
- This unit requires discs and recordings to meet certain technical standards in order to achieve optimal playback quality. Pre-recorded DVDs are automatically set to these standards. There are many different types of recordable disc formats (including CD-R containing MP3 or WMA files) and these require certain pre-existing conditions (see above) to ensure compatible playback.

Customers should note that permission is required in order to download MP3 / WMA files and music from the Internet. Our company has no right to grant such permission. Permission should always be sought from the copyright owner.

Regional Code

This unit has a regional code printed on the rear of the unit. This unit can play only DVD discs labelled as the same as the rear of the unit or "ALL".

Notes on Regional Codes

- Most DVD discs have a globe with one or more numbers in it clearly visible on the cover. This number must match your unit's regional code or the disc cannot play.
- If you try to play a DVD with a different regional code from your player, the message "Check Regional Code" appears on the TV screen.

Notes on Copyrights:

It is forbidden by law to copy, broadcast, show, broadcast via cable, play in public, or rent copyrighted material without permission. This product features the copy protection function developed by Macrovision. Copy protection signals are recorded on some discs. When recording and playing the pictures of these discs picture noise will appear. This product incorporates copyright protection technology that is protected by method claims of certain U.S. patents and other intellectual property rights owned by Macrovision Corporation and other rights owners. The Use of this copyright protection technology must be authorized by Macrovision Corporation, and is intended for home and other limited viewing uses only unless otherwise authorized by Macrovision Corporation. Reverse engineering or disassembly is prohibited.

CONSUMERS SHOULD NOTE THAT NOT ALL HIGH DEFINITION TELEVISION SETS ARE FULLY COMPATIBLE WITH THIS PRODUCT AND MAY CAUSE ARTIFACTS TO BE DISPLAYED IN THE PICTURE. IN CASE OF 525 PROGRESSIVE SCAN PICTURE PROBLEMS, IT IS RECOMMENDED THAT THE USER SWITCH THE CONNECTION TO THE 'STANDARD DEFINITION' OUTPUT. IF THERE ARE QUESTIONS REGARDING OUR TV SET COMPATIBILITY WITH THIS MODEL 525p DVD PLAYER, PLEASE CONTACT OUR CUSTOMER SERVICE CENTER.

Front Panel

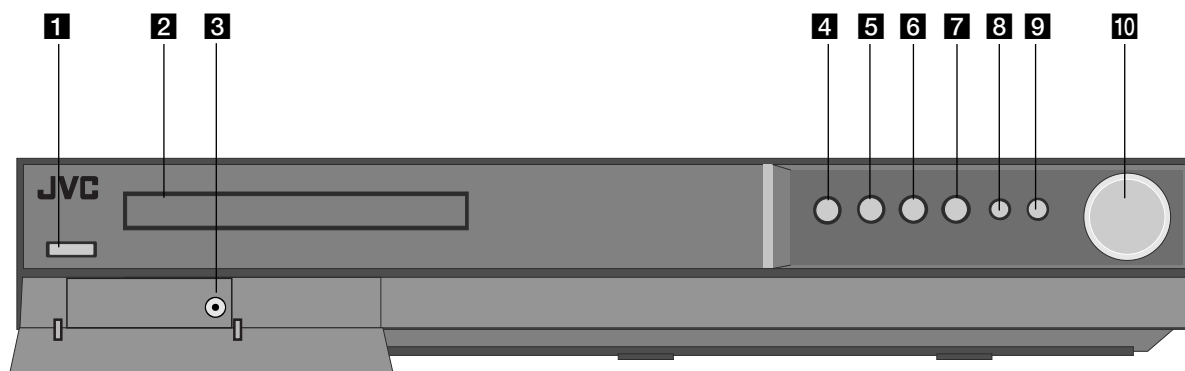

1  (STANDBY/ON)

Switches the unit ON and OFF.

2 Disc Tray

Insert a disc here.

3 AUDIO IN

The AUDIO IN port means you can connect a audio device to play through the surround sound speakers.

4  (OPEN/CLOSE)

Opens or closes the disc tray.

5  (STOP)

Stops playback.

6  (PLAY)

Starts playback.

SOURCE

Press and hold down this button about 3 seconds, then press repeatedly to select other function

7  (PAUSE)

Pause playback.

FM MODE

This will change the tuner from stereo to mono and usually improve the reception.

8  (SKIP)

Returns to the beginning of current chapter or track or go to the previous chapter or track. **(SCAN)**

During playback, press and hold this button repeatedly to select the required scan speed.

- TUNING

Tunes in the desired radio station.

9  (SKIP)

Go to the next chapter or track.

(SCAN)

During playback, press and hold this button repeatedly to select the required scan speed.

+ TUNING

Tunes in the desired radio station.

10 VOLUME controller

Remote Control

AUDIO (⏻/⏻)

Switches the unit ON and OFF.

FUNCTION

Selects the function (DVD/CD, FM)

INPUT

Changes the input source (AUX, AUX OPT, AUDIO IN, OSD IPOD, IPOD, HDMI IN)

SLEEP

Sets the System to turn off automatically at a specified time.

DIMMER

Changes brightness of the display window on the front panel during in power-on status.

RETURN

Press to move back wards in the menu.

TOP MENU

If the current DVD title has a menu, the title menu appears on the screen. Otherwise, the disc menu may appear.

MENU

Accesses the menu on a DVD disc.

SET UP

Accesses or removes setup menu.

DISPLAY

Accesses On-Screen display.

◀/▶/▲/▼ (left/right/up/down)

Selects an option in the menu.

ENTER

Acknowledges the menu selection.

PRESET (⊖/⊕)

Selects program of Radio.

TUNING. (⊖/⊕)

Tunes in the desired radio station.

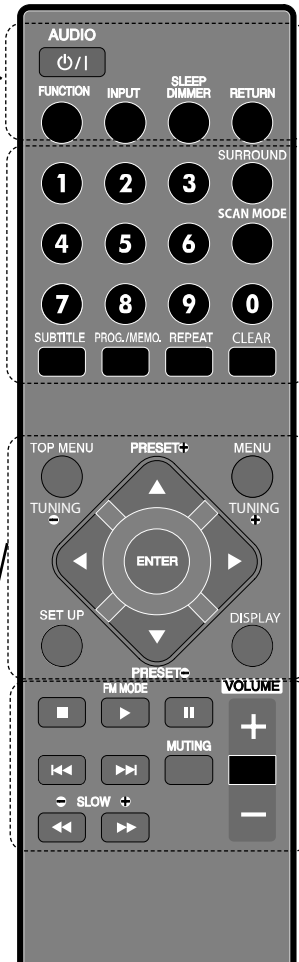

0-9 numerical buttons: Selects numbered options in a menu.

SURROUND

Selects the surround mode.

SCAN MODE

Sets the output resolution for HDMI and COMPONENT VIDEO OUT jacks.

SUBTITLE

Selects a subtitle language (DVD).

PROG./MEMO.

Accesses or removes Program menu.

Enter a radio station's frequency into the tuner.

REPEAT

Repeats chapter, track, title, all

CLEAR

Removes a track number on the Program List.

SCAN/SLOW(◀◀/▶▶)

Searches backward or forward. Reverse/ Forward slow playback.

SKIP (◀◀/▶▶)

STOP (■)

PLAY (▶)

FM MODE

This will change the tuner from stereo to mono and usually improve the reception.

PAUSE/STEP (||)

VOLUME (-/+)

Adjusts speaker volume.

MUTING

To mute the sound

Remote Control operation

Point the remote control at the remote sensor and press the buttons.

Cautions:

- Do not mix old and new batteries and never mix different types of batteries such as standard, alkaline, etc.
- Do not put the batteries in the place where young children can reach.
- Battery shall not be exposed to excessive heat such as sunshine, fire or the like.
- When discarding batteries, environmental problems must be considered and local rules or laws governing the disposal of these batteries must be followed strictly.

Remote Control Battery installation

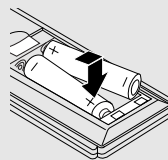

Detach the battery cover on the rear of the remote control, and insert two batteries (size AAA) with ⊕ and ⊖ aligned correctly.

Installation and Setup

TV Connection

Make one of the following connections, depending on the capabilities of your existing equipment.

Tips:

- Depending on your TV and other equipment you wish to connect, there are various ways you could connect the DVD/CD Receiver. Use one of the connections described below.
- Please refer to the manuals of your TV, VCR, Stereo System or other devices as necessary to make the best connections.

Caution:

- Make sure the DVD/CD Receiver is connected directly to the TV. Select the correct AV input on your TV.
- Do not connect your DVD/CD Receiver to TV via your VCR. The DVD image could be distorted by the copy protection system.

Video connection

Connect the MONITOR OUT jack from the DVD/CD Receiver to the VIDEO IN jack on the TV using the video cable (V).

Component Video connection

Connect the COMPONENT VIDEO OUT jacks from the DVD/CD Receiver to the corresponding jacks on the TV using an Y P_B P_R cable (C).

- If your television is a high-definition or “digital ready” television, you may take advantage of the DVD/CD Receiver’s progressive scan output for the highest video resolution.
- If your TV does not accept your resolution setting, abnormal picture appears on the screen. Please read owner’s manual for TV then set the resolution that your TV can accept.

Antenna Connection

Connect the supplied FM antenna for listening to the radio.

- Connect the FM Wire antenna to the FM antenna connector.

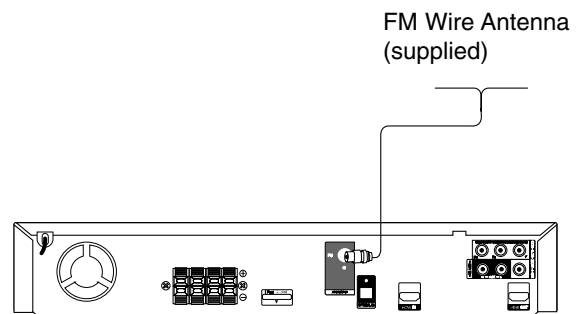
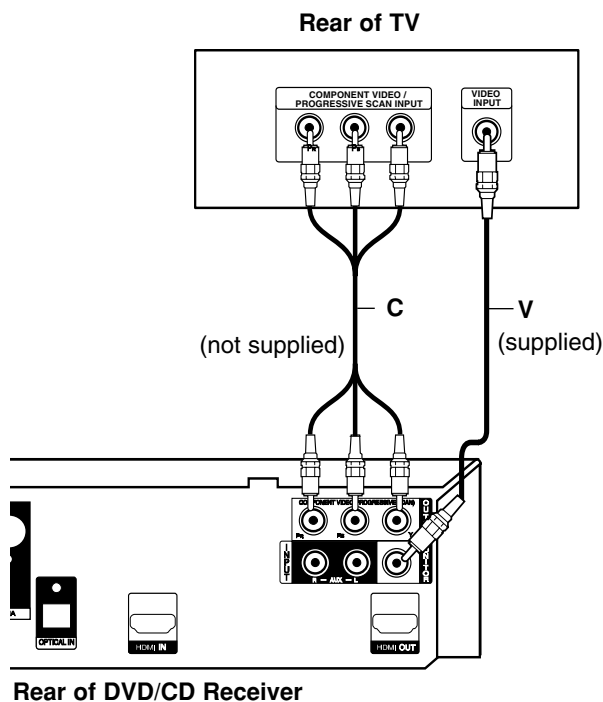

Notes:

- Be sure to fully extend the FM wire antenna.
- After connecting the FM Wire antenna, keep it as horizontal as possible.

Optional Equipment Connection

Rear of DVD/CD Receiver

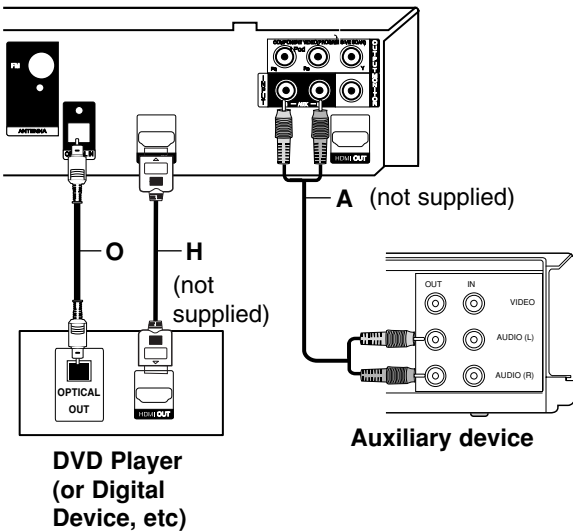

AUX IN connection (A)

Connect a Output of auxiliary device to the AUX AUDIO Input (L/R) Connector.

OPTICAL IN connection (O)

Connect an optical output of DVD Player (or Digital Device etc) to the OPTICAL IN connector.

HDMI In connection (H)

Connect the HDMI INPUT jack on the unit to the HDMI output jack on your Set-Top box (or Digital Device etc.) using an HDMI cable. Set the external source to HDMI IN by pressing INPUT. In HDMI IN mode, you can't change the resolution.

AUDIO IN connection (D)

Connect a output of portable device (MP3 or PMP etc) to the AUDIO input connector.

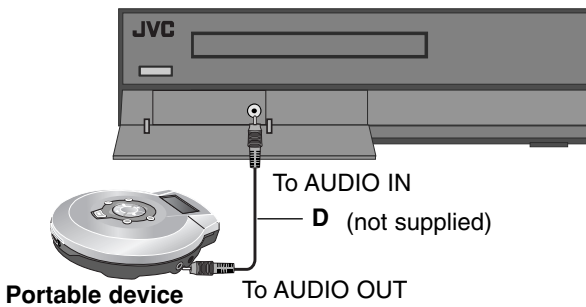

iPod connection (I)

Connect the iPod and the unit with iPod docking station.(I).

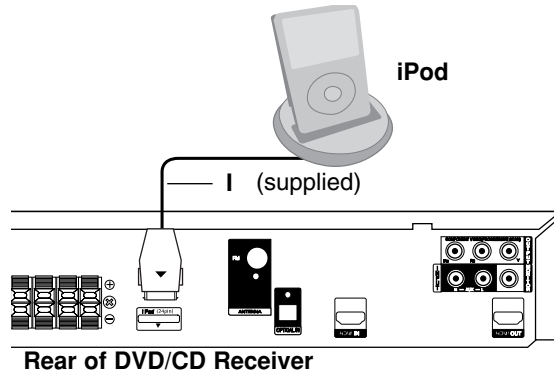

Notes:

- The connector plug is protected with a cover when it is first purchased. Please remove the cover before operating the unit.
- When the iPod is not connected, insert the terminal cover. This prevents dust from entering and possibly damaging the unit.
- Depending on the type of iPod, you may need to insert one of the dock adapters into the dock slot before you station your iPod.
- Adjust the volume to a moderate level before you connect your iPod and this unit.
- The jack for the iPod cable of docking station are keyed so that the cable connectors only connect in one way. Connect the end on the cable with the marked "▲" facing down wards to rear on the unit.

HDMI Connection

About HDMI

HDMI (High Definition Multimedia Interface) supports both video and audio on a single digital connection for an easy all-digital output to an HDMI or DI-equipped TV.

Connection to an HDMI TV requires an HDMI cable while connection to a DVI-equipped TV requires a DVI adapter besides a HDMI cable.

HDMI has the capability to support standard, enhanced, or high-definition video plus standard to multi-channel surround-sound audio, HDMI features include uncompressed digital video, a bandwidth of up to 5 gigabytes per second, one connector (instead of several cables and connector), and communication between the AV source and AV devices such as DTVs. *HDMI, the HDMI logo and High-Definition Multimedia Interface are trademarks or registered trademarks of HDMI licensing LLC.*

If you have a HDMI TV or monitor, you can connect it to this DVD/CD Receiver using a HDMI cable.

1. Connect the HDMI OUT jack on the DVD/CD Receiver to the HDMI jack on a HDMI compatible TV or monitor (H).
2. Set the TV's source to HDMI (refer to owner's manual for TV).

Notes on HDMI Out connection

- If your TV does not accept your resolution setting, abnormal picture appears on the screen. ("TV do not support" will appears in screen)
Please read owner's manual for TV, and then set the resolution that your TV can accept.
- Changing the resolution when the unit is connected with HDMI connector may result in malfunctions. To solve the problem, turn off the unit and then turn it on again.
- When you connect a HDMI or DVI compatible device make sure of the following :
 - Try switching off the HDMI/ DVI device and this unit. Next, switch on the HDMI/ DVI device and leave it for around 30 seconds, then switch on this unit.
 - The connected device's video input is set correctly for this unit.
 - The connected device is compatible with 720X576i(480i), 720X576p(480p), 1280X720p, 1920X1080i or 1920X1080p video input.
 - The 1080p, 720p and 576p(480p) resolutions are the progressive scan applied resolution.
- Not all HDCP-compatible DVI devices will work with this unit.
 - The picture will not be displayed properly with non-HDCP device.

HDMI compatible TV

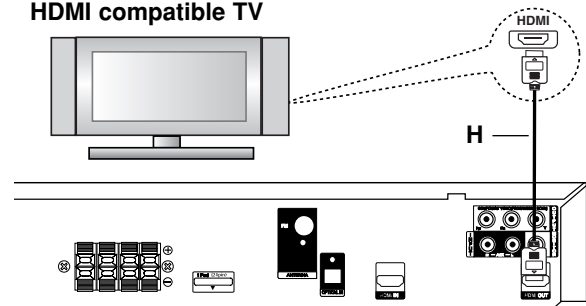

Rear of DVD/CD Receiver

Resolution setting

You can change the resolution for component video and HDMI output.

Press **SCAN MODE** repeatedly to select the desired resolution - 480i (or 576i), 480p (or 576p), 720p, 1080i, 1080p

The resolution may not be selected depending on the connection or TV.

Note:

Depending on your TV, some of the resolution settings may result in the picture disappearing or an abnormal picture appearing. In this case, press **SCAN MODE** repeatedly until the picture re-appears.

You can set 1080p video resolution to enjoy Full HD picture quality. (Full HD up-scaling)

Available resolution according to connection

HDMI OUT - 1080p, 1080i, 720p 480p and 480i

COMPONENT VIDEO OUT - 480p and 480i

VIDEO OUT - 480i

Note:

If your TV does not accept your resolution setting, abnormal picture appears on the screen.

Please read owner's manual for TV, and then set the resolution that your TV can accept.

Setup the wireless system

Note:

If there is a product with a strong electromagnetic field nearby, interference may occur.

(Ex : Micro wave oven)

LED indicator of Wireless Receiver

* LED indicator - "BLUE"

The Wireless Receiver is receiving the signal of the Wireless transmitter.

* LED indicator - "RED"

The Wireless Receiver is in standby mode.

Initial Setting an ID of Wireless

- 1 Connect the Wireless Receiver and the rear speaker (right, left) with the speaker cables.
- 2 Connect the power cord of the Wireless Receiver to the outlet.
- 3 Turn on the main unit and Wireless Receiver. The main unit and wireless receiver will be automatically connected. "MATE OK" appears in display window.

Setting an ID of Wireless

When the unit is manufactured, the ID is already set. If an interference occurs or you use a new Wireless Receiver, an ID should be set again.

1. Turn on the main unit and Wireless Receiver.
2. Press and hold STOP(■) on the front of unit and MUTE on the remote control. "REMATE" appears in display window.
3. Turn off the Wireless Receiver.
4. Turn on the Wireless Receiver: A new ID is set..

Notes:

- If there is a strong electromagnetic wave product nearby, interference may occur. Put the unit (Wireless Receiver and main unit) away from there. (Ex: Microwave oven)
- If there is no audio signal for longer than 10 minutes, the Wireless Receiver will automatically switch to standby mode. In power saving mode, both LEDs will turn red. LEDs will turn blue when there is any audio signal back.
- If you operate main unit then wireless speakers (rear speakers) sound within a few seconds in standby mode.
- Set the distance between this unit and Wireless Receiver within 10m.
- Optimum performance can be implemented only when the Wireless Transmitter and the Wireless Receiver within distance of 2m to 10m is used since communication failure may occur if longer distance is used.
- It takes a few seconds (and may take longer) for the Wireless Transmitter and Wireless Receiver to communicate with each other.

Speaker System Connection

Connect the speakers using the supplied speaker cables.

To obtain the best possible surround sound, adjust the speaker parameters (volume, distance, etc.).

Notes:

- Be sure to match the speaker cable to the appropriate terminal on the components: + to + and – to –. If the cables are reversed, the sound will be distorted and will lack base.
- If you use front speakers with low maximum input rating, adjust the volume carefully to avoid excessive output on the speakers.

Caution:

- The left and right speakers can be installed on a wall.
- When installing the speakers on a wall, be sure to have the speakers installed by qualified personnel.
- DO NOT install the speakers on the wall by yourself to avoid unexpected damage from them falling off the wall due to incorrect installation or weakness in wall structure.
- Care must be taken in selecting a location for speaker installation on a wall. Injury to personnel or damage to devices may result if the installed speakers interfere with daily activities.

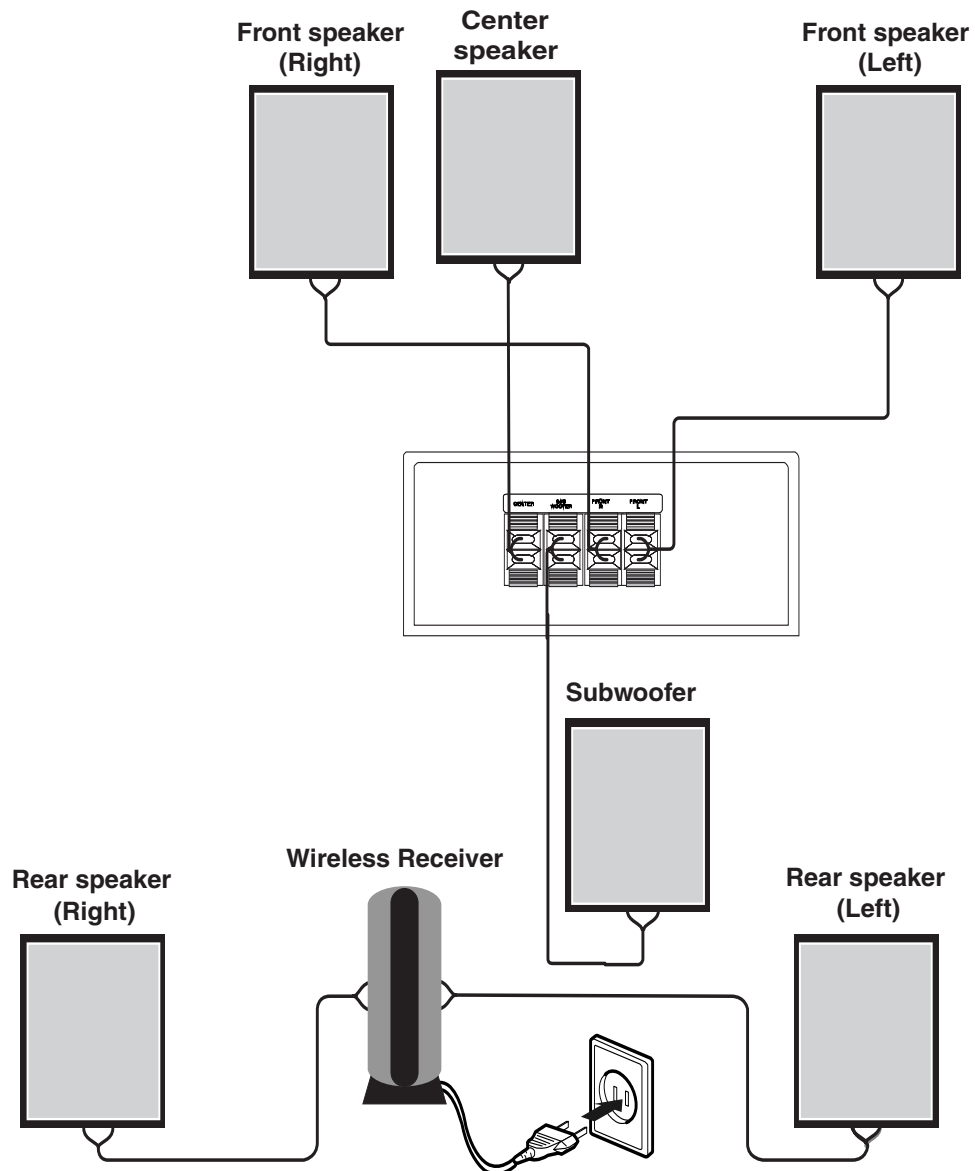

Displaying Disc Information on-screen

You can display various information about the disc loaded on-screen.

1. Press DISPLAY to show various playback information.
The displayed items differ depending on the disc type or playing status.



2. You can select an item by pressing ▲ / ▼ and change or select the setting by pressing ◀ / ▶.
 - Title – Current title number/ total number of titles.
 - Chapter – Current chapter number/total number of chapters.
 - Time – Elapsed playing time.
 - Audio – Selected audio language or channel.
 - Subtitle – Selected subtitle.
 - Angle – Selected angle/total number of angles.
 - Sound – Selected sound mode.

Note:

If any button is not pressed for a few seconds, the on-screen display disappears.

Initial Settings

By using the Setup menu, you can make various adjustments to items such as picture and sound. You can also set a language for the subtitles and the Setup menu, among other things. For details on each Setup menu item, see pages 11 to 14.

OSD Initial language settings:

When the POWER is turned on for the first time, the unit need to set the menu language. Follow the descriptions below after the display connections. After OSD Initial language setting, to set Area code (see page 14)



1. Press POWER to turn the unit on. The language setup menu will appear on the screen.
2. Use ◀ / ▶ / ▲ / ▼ to select a language then press ENTER. The confirm menu will appear.
3. Use ◀ / ▶ to select the [Enter] then press ENTER to finish the language setup.

To display and exit the Menu:

Press SETUP to display the menu. A second press of SETUP will take you back to initial screen.

To go to the next level:

Press ▶ on the remote control.

To go back to the previous level:

Press ◀ on the remote control.

General Operation

1. Press **SETUP**.
The Setup menu appears.



2. Use **▲ / ▼** to select the desired option then press **▶** to move to the second level. The screen shows the current setting for the selected item, as well as alternate setting(s).
3. Use **▲ / ▼** to select the second desired option and then press **▶** to move to the third level.
4. Use **▲ / ▼** to select the desired setting then press **ENTER** to confirm your selection.
Some items require additional steps.
5. Press **SETUP** or **PLAY (▶)** to exit the Setup menu.

LANGUAGE



Menu Language

Select a language for the Setup menu and then on-screen display.

Disc Audio / Subtitle / Menu

Select the language you prefer for the audio track (disc audio), subtitles, and the disc menu.

Original – Refers to the original language in which the disc was recorded.

Other – To select another language, press numeric buttons and then **ENTER** to enter the corresponding 4-digit number according to the language code list on the page 23. If you enter the wrong language code, press **CLEAR**.

DISPLAY



TV Aspect

- 4:3** – Select when a standard 4:3 TV is connected.
- 16:9** – Select when a 16:9 wide TV is connected.

Display Mode

The Display Mode setting works only when the TV Aspect mode is set to 4:3.

Letterbox – Displays a wide picture with bands on the upper and lower portions of the screen.

Panscan – Automatically displays the wide picture on the entire screen and cuts off the portions that do not fit. (If the disc/file is not compatible with Pan Scan, the picture is displayed at Letterbox ratio.)

AUDIO

Each DVD disc has a variety of audio output options. Set the player's AUDIO options according to the type of audio system you use.



Dynamic Range Control (DRC)

With the DVD*1 format, you can hear a program's soundtrack in the most accurate and realistic presentation, thanks to digital audio technology. However, you may wish to compress the dynamic range of the audio output (the difference between the loudest sounds and the quietest ones). Then, you may listen to a movie at a lower volume without losing clarity of sound. Set DRC to On for this effect.

*1: Dolby Digital only

Vocal

Set Vocal to On only when a multi-channel karaoke DVD is playing. The karaoke channels on the disc will mix into normal stereo sound.

HD AV Sync

When using Digital TV.

Sometimes AV signal could not be transmitted simultaneously because of later transmission of video signal compared to audio signal.

Because it takes some time to convert analogue video signal to digital one in the Digital TV.

And It means that you may not enjoy picture on the screen and sound from speaker at the same time even though it is one scene.

In the HD AV Sync menu, you could adjust delay time to audio signal for simultaneous AV signal transmission

- Delay time could be set up with 10msec unit. (0 ~ 300ms)
- Delay time is different according to each TV Brand. So you need to adjust optimal delay time complying with your TV.

5.1 Speaker Setup

Make the following settings for the built-in 5.1 channel surround decoder.

1. Press ENTER, and the 5.1 Speaker Setup menu appears.

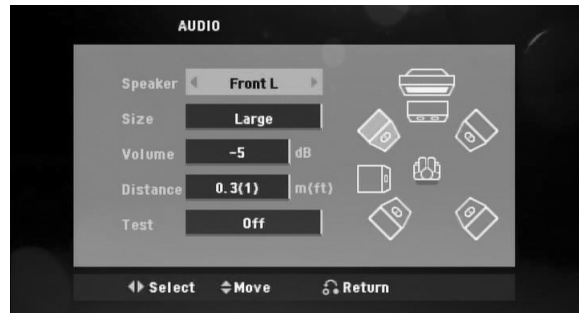

2. Use ◀ / ▶ to select the desired speaker.
3. Adjust options using ▲ / ▼ / ◀ / ▶ buttons.
4. Press ENTER to confirm your selection. Returns to the previous menu.

Speaker selection

Select a speaker that you want to adjust. [Front speaker (Front L), Front speaker (Front R), Center Speaker (Center), Subwoofer (SubWoofer), Rear speaker (Rear L), Rear speaker (Rear R)]

Note:

Certain speaker settings are prohibited by the Dolby Digital licensing agreement.

Size

Since the speaker settings are fixed, you cannot change the settings.

Volume

Press ◀ / ▶ to adjust the output level of the selected speaker. (-5dB ~ 5dB)

Distance

After you connected speakers to your DVD Receiver, set the Distance between the speakers and your listening point if the distance of Center or Rear speakers is bigger than the distance of Front speakers. This allows the sound from each speaker to reach the listener at the same time.

Press ◀ / ▶ to adjust the Distance of the selected speaker. This distance is equivalent to a difference of the distance between Center or Rear speaker and Front speakers.

Note:

You can't adjust Front/Woofer speakers.

The distance of Front speaker is considered to be the standard.

5.1 Speaker Setup

Test

Press ◀ / ▶ to test the signals of each speaker. Adjust the volume to match the volume of test signals memorized in the system.

Front Left (Front L) → Center → Front Right (Front R)
→ Rear Right (Rear R) → Rear Left (Rear L) →
SubWoofer

LOCK (Parental Control)

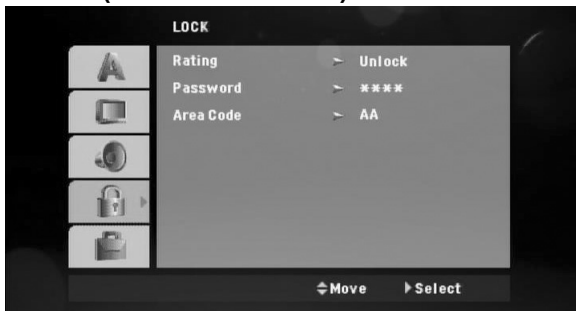

Initial Setting the Area Code:

See the Area Codes on page 23.

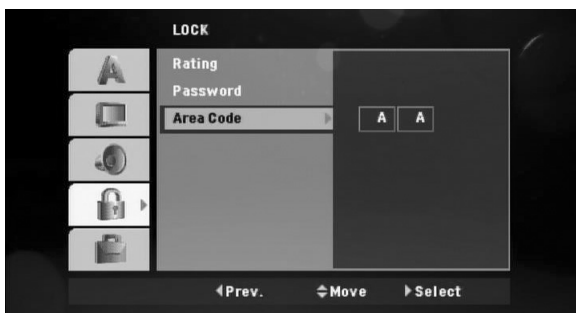

1. Select the LOCK menu and then press ▶.
2. To access the LOCK options, you must input the password you have created. Input a password and press ENTER. Enter it again and press ENTER to verify. If you make a mistake before pressing ENTER, press CLEAR.
3. Select the first character using ▲ / ▼ buttons.
4. Press ▶ and select the second character using ▲ / ▼ buttons.
5. Press ENTER to confirm your Area code selection.

Rating

Blocks playback of rated DVDs based on their contents. Not all discs are rated.

1. Select "Rating" on the LOCK menu then press ▶.
2. Input a password and press ENTER.
3. Select a rating from 1 to 8 using the ▲ / ▼ buttons.
Rating 1-8: Rating one (1) has the most restrictions and rating eight (8) is the least restrictive.
Unlock: If you select unlock, parental control is not active and the disc plays in full.
4. Press ENTER to confirm your rating selection, then press SETUP to exit the menu.

Password

You can enter or change password.

1. Select Password on the LOCK menu and then press ▶.
2. Follow the step 2 as shown above (Rating).
To change the password, press ENTER when the "Change" option is highlighted. Input a password and press ENTER. Enter it again and press ENTER to verify.
3. Press SETUP to exit the menu.

If you forget your password

If you forget your password, you can clear it using the following steps:

1. Press SETUP to display the Setup menu.
2. Input the 6-digit number "210499" and press ENTER. The password is cleared.

Area Code

Enter the code of the area whose standards were used to rate the DVD video disc, based on the list on page 23.

1. Select "Area Code" on the LOCK menu then press ▶.
2. Follow the step 2 as shown previous paragraph (Rating).
3. Select the first character using ▲ / ▼ buttons.
4. Press ENTER and select the second character using ▲ / ▼ buttons.
5. Press ENTER to confirm your Area code selection.

OTHERS



This option has no selection on this set.

Operation

General features

Buttons	Operations	Discs
▲ (OPEN / CLOSE)	Opens or closes the disc tray.	ALL
⏸ (PAUSE)	During playback, press ⏸ to pause playback. Press ⏸ repeatedly to play Frame-by-Frame.	ALL DVD
⏮ / ⏭	During playback, press ⏮ or ⏭ to go to the next chapter/track or to return to the beginning of the current chapter/track. Press ⏮ twice briefly to step back to the previous chapter/track.	ALL
⏪ / ⏩	During playback, press ⏪ or ⏩ repeatedly to select the required scan speed. DVD : ⏪, ⏪⏪, ⏪⏪⏪, ⏪⏪⏪⏪ or ⏩, ⏩⏩, ⏩⏩⏩, ⏩⏩⏩⏩ WMA/MP3, Audio CD : ⏪⏪ (X2, X4, X8) or ⏩⏩ (X2, X4, X8)	DVD ACD MP3 WMA
REPEAT	During playback, press REPEAT repeatedly to select a desired repeat mode. DVD Video discs: Chapter/Title/Off Audio CD, MP3/WMA discs: Track/All/Off	ALL
TOP MENU	If the current DVD title has a menu, the title menu appears on the screen. Otherwise, the disc menu may appear.	DVD
MENU	The disc menu appears on the screen.	DVD
⏸ (SUBTITLE)	During playback, press SUBTITLE repeatedly to select a desired subtitle language.	DVD
SLOW	In the pause mode, press SLOW (⏪ or ⏩) to select the required speed. DVD : ⏪ (1/2, 1/4, 1/8, 1/16) or ⏩ (1/2, 1/4, 1/8, 1/16)	DVD

Additional features

Time Search **DVD**

To start playing at any chosen time on the disc:

1. Press DISPLAY during playback.
2. Press ▲ / ▼ to select the time clock icon and "--:--:--" appears.
3. Input the required start time in hours, minutes, and seconds from left to right. If you enter the wrong numbers, press CLEAR to remove the numbers you entered. Then input the correct numbers.
4. Press ENTER to confirm. Playback starts from the selected time.

1.5 times speed playback

DVD

You can play at 1.5 times speed.

The 1.5 speed allows you to watch the pictures and listen to the sound quicker than playing at a normal speed on the disc.

1. During playback, press PLAY(▶) to play at 1.5 times speed. "▶X1.5" appears on the screen.
2. Press PLAY(▶) again to exit.

Screen Saver

The screen saver appears when you leave the unit in Stop mode for about five minutes. To cancel the Screen Saver, press any button and then operate the unit.

Last Scene Memory **DVD**

This receiver memorizes the last scene from the last disc that is viewed. The last scene remains in the memory even if you remove the disc from the receiver or switch off the receiver. If you load a disc that has the scene memorized, the scene is automatically recalled.

Note:

This receiver does not memorize the scene of a disc if you switch off the receiver before commencing to play the disc.

Mixed disc – MP3/WMA and JPEG

When playing a disc contained with MP3/WMA and JPEG files together, you can select which menu of files you would like to play by pressing MENU.

Playing an Audio CD or MP3/WMA file

This unit can play Audio CDs or MP3/WMA files.

MP3/ WMA/ Audio CD

Once you insert an MP3/WMA files recording media or Audio CD a menu appears on the TV screen.

Press ▲ / ▼ to select a track/file and then press PLAY or ENTER, and playback starts. You can use variable playback functions. Refer to the page 15.

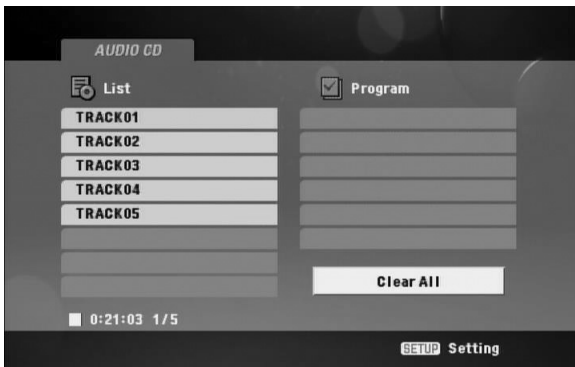

ID3 TAG

When playing a file containing information such as track titles, you can see the information by pressing DISPLAY. (Song, Artist, Album, Genre, Comment)

MP3 / WMA disc compatibility with this player is limited as follows:

- Sampling frequency: within 32 - 48 kHz (MP3), within 32 - 48kHz (WMA)
- Bit rate: within 32 - 320kbps (MP3), 40 - 192kbps (WMA)
- The DVD/CD Receiver cannot read an MP3/WMA file that has a file extension other than “.mp3” / “.wma”.
- CD-R physical format should be ISO 9660
- If you record MP3 / WMA files using software that cannot create a file system (eg. Direct-CD) it is impossible to playback MP3 / WMA files. We recommend that you use Easy-CD Creator, which creates an ISO 9660 file system.
- File names should have a maximum of 8 letters and must incorporate an .mp3 or .wma extension.
- They should not contain special letters such as / ? * : “ < > | etc.
- The total number of files on the disc should be less than 999.

This DVD/CD Receiver requires discs and recordings to meet certain technical standards in order to achieve optimal playback quality. Pre-recorded DVDs are automatically set to these standards. There are many different types of recordable disc formats (including CD-R containing MP3 or WMA files) and these require certain pre-existing conditions (see above) to ensure compatible playback.

Customers should note that permission is required in order to download MP3 / WMA files and music from the Internet. Our company has no right to grant such permission. Permission should always be sought from the copyright owner.

Programmed Playback

The program function enables you to store your favourite tracks from any disc in the receiver memory. A program can contain 30 tracks.

1. Insert a disc.
Audio CD and MP3/WMA Discs:
2. To add a music(s) on the program list, press **PROG/MEMO** to enter the program edit mode (Ⓜ mark appears on the menu).
3. Select a desired music on the [List] by using the ▲ / ▼ then press **ENTER** to add the music to the program list.
4. Select music from the program list then press **ENTER** to start programmed playback.

Repeat Programmed Tracks

1. Press REPEAT when playing a disc. The repeat icon appears.
2. Press REPEAT to select a desired repeat mode.
 - Track: repeats the current track
 - All: repeats all the tracks on programmed list.
 - Random: The current title, chapter or track will be played back randomly on programmed list.
 - Off (No display): does not play repeatedly.

Erasing a Track from “Program” List

1. Use ▲ / ▼ to select the track that you wish to erase from the Program list.
2. Press CLEAR in program edit mode.

Erasing the Complete Program List

Use ▲ / ▼ to select [Clear All] then press **ENTER** in program edit mode.

Note:

The programs are also cleared when the disc is removed, the unit is switched to power off or the function is switched to others.

Viewing a JPEG file

This unit can play discs with JPEG files. Before playing JPEG recordings, read the notes on JPEG Recordings on the right.

1. Insert a disc and close the tray.
The PHOTO menu appears on the TV screen.

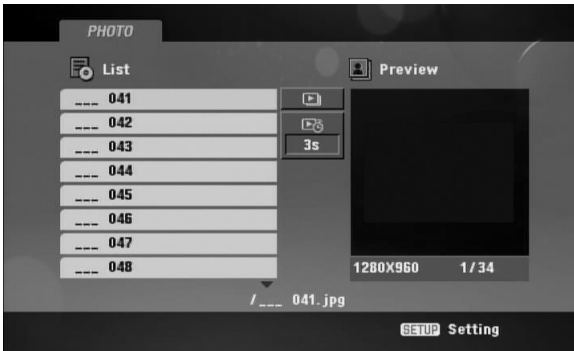

2. Press ▲ / ▼ to select a folder, and then press ENTER. A list of files in the folder appears. If you are in a file list and want to return to the previous Folder list, use the ▲ / ▼ buttons on the remote to highlight and press ENTER.
3. If you want to view a particular file, press ▲ / ▼ to highlight a file and press ENTER or PLAY. While viewing a file, you can press STOP to move to the previous menu (JPEG menu).

Tips:

There are three Slide Speed options : 3s, 5s, 8s
Use ▲ / ▼ / ◀ / ▶ to highlight the Speed. Then, use ◀ / ▶ to select the option you want to use and then press ENTER.

Note:

Depending on the size and resolution of JPEG files, it may take longer for slide show to be set.

Slide Show

1. Highlight the file (not folder) which you like beginning to slide show.
2. Select the slide speed. (Refer to the tips this page)
3. Use ▲ / ▼ / ◀ / ▶ to highlight the (Slide Show) then press ENTER.

Note:

- The sequence of slide show is from top to down, cannot be reverse.
- Slide show cannot repeat automatically, you could start the slide show again manually.

Still Picture

1. Press PAUSE/STEP during the slide show.
The DVD/CD Receiver will now go into the PAUSE mode.
2. To return to the slide show, press PLAY or press PAUSE/STEP again.

Moving to another File

Press SKIP (◀◀ or ▶▶) once during viewing a picture to advance to the next or previous file.

Rotating the picture

Press ▲ / ▼ during showing a picture to rotate the picture clockwise or counter-clockwise.

Listening to music during slide show

You can listen to music during slide show, if the disc contain music and photo files together. Use ▲ / ▼ / ◀ / ▶ to highlight icon then press ENTER to start slide show. This function is available only in disc.

JPEG disc compatibility with this player is limited as follows:

- Depending upon the size and the number of JPEG files, it could take a long time for the DVD/CD Receiver to read the disc's contents. If you don't see an on-screen display after several minutes, some of the files may be too large — reduce the resolution of the JPEG files to less than 2M pixels as 2760 x 2048 pixels and burn another disc.
- The total number of files and folders on the disc should be less than 999.
- Some discs may not operate due to a different recording format or the condition of disc.
- Ensure that all the selected files have the “.jpg” extensions when copying into the CD layout.
- If the files have “.jpe” or “.jpeg” extensions, please rename them as “.jpg” file.
- File names without “.jpg” extension will not be able to be read by this DVD/CD Receiver. Even though the files are shown as JPEG image files in Windows Explorer.

Using iPod

For detail refer to iPod guide.

iPod mode: You can operate your iPod by using the supplied remote control and directly control on your iPod.

OSD iPod mode: You can operate your iPod by controlling OSD menu on the TV screen with supplied remote control. The controls on your iPod are not operational in the OSD iPod mode.

General operation

1. Connect the iPod and the unit with iPod docking station. Refer to the page 7.
2. Turn the unit on.
Your iPod is automatically turned on.
3. Press INPUT on the remote control to enter the iPod mode.
The iPod menu appears on the TV screen.
The initial screen of iPod menu is the OSD iPod mode.
4. Use ▲ / ▼ and ENTER on the Remote Control to display the list of menu.
5. Press ENTER to play.

General features

Pauseing playback

Press PAUSE/STEP (⏸) or PLAY (▶) to pause playback. Press PAUSE/STEP (⏸) or PLAY (▶) to continue playback.

Skipping to the next/previous file

Press SKIP (▶▶) to move to the next file.

Press SKIP (◀◀) to return to the beginning of the current file.

Press SKIP (◀◀) twice briefly to step back to the previous file.

Fast forward or fast reverse

Audio files: During playback, press and hold SCAN (◀◀ or ▶▶) and then release at a point you want.

Video files: During playback, press SCAN (◀◀ or ▶▶). Press PLAY (▶) continue play at normal speed.

Playing repeatedly

Press REPEAT repeatedly to select an item to be repeated. The current file will be played back repeatedly. To return to normal playback, press REPEAT repeatedly. (On video files, this function is not available.)

iPod message

“Please, check your iPod” - If the power of your iPod is insufficient or the iPod is misconnected or unknown device. Reset the iPod if the iPod is not operating normally (Refer to <http://www.apple.com/support/>)

“If you connect to the [VIDEO OUT] terminal on this unit and switch TV input mode, you can enjoy video playback.” - When you connect the unit and TV to COMPONENT VIDEO OUT or HDMI OUT, connect the unit and TV to VIDEO OUT.

Compatible iPod

- When the unit is connected with dock connector may result in malfunctions
- Compatibility with your iPod may vary depending on the type of your iPod.
- Depending on your iPod's software version, it may not be possible to control your iPod from the unit. We recommend installing the latest software version.

Notes:

- Interference may happen depending on iPod devices.
- The video files are outputted only when you connect the unit to VIDEO OUT.
- Connect the end on the cable with the marked “▼” facing downwards to rear on the unit.
- Be careful not to put iPod dock strongly into the unit when connecting or disconnecting it. But the cable may be damaged.
- JVC is not responsible for any loss of data on an iPod when used with this system.
- This system can receive analog sound from the following iPod models
 - iPod touch
 - iPod classic
 - iPod 5th generation
 - iPod 4th generation
 - iPod nano (1st/2nd/3rd generation)
 - iPod mini (1st/2nd generation)
- If content on the iPod is not played back correctly, update your iPod software to the latest version. For details about updating the iPod, check the Apple web site <<http://www.apple.com>>.
- Adjust the volume to a moderate level before you connect your iPod and this unit.

Presetting the Radio Stations

You can preset 50 stations for FM. Before tuning, make sure that you have turned down the volume.

1. Press FUNCTION on the remote control until FM appears in the display window.
2. Press and hold TUNING.(-/+) for about two seconds until the frequency indication starts to change, then release.
Scanning stops when the DVD/CD Receiver tunes in a station.
3. Press PROG./MEMO. on the remote control.
A preset number will flash in the display window.
4. Press PRESET (-/+) on the remote control to select the preset number you want.
5. Press PROG./MEMO. on the remote control again.
The station is stored.
6. Repeat steps 3 to 6 to store other stations.

To tune in a station with a weak signal

Press TUNING.(-/+) repeatedly in step 3 to tune in the station manually.

To clear all the stored stations

Press and hold PROG./MEMO. for about two seconds and "ERASE ALL" is appeared in the display window and then press PROG./MEMO. again, the stations are cleared.

- If you have accidentally entered into the "ERASE ALL" mode and you do not wish to clear the memory, do not press any key. After a few seconds, "ERASE ALL" will go off by itself and change to normal mode.

Note:

If all stations have already been entered, the FULL message will appear in the display window for a moment and then a preset number will flash. To change the preset number, follow the steps 5-6 as above.

Listening to the Radio

Preset radio stations in the DVD/CD Receiver's memory first (see "Presetting radio stations" on the left).

1. Press FUNCTION until FM appears in the display window.
The last received station is tuned in.
2. Press PRESET (-/+) repeatedly on the remote control to select the preset station you want.
Each time you press the button, the DVD/CD Receiver tunes in one preset station at a time.
3. Adjust the volume by rotating VOLUME on the front panel or by pressing VOLUME + or - on the remote control repeatedly.

To turn off the radio

Press POWER to turn the DVD/CD Receiver off or select another function mode.

To listen to non-preset radio stations

- Use manual or automatic tuning in the step 2.
- For manual tuning, press TUNING.(-/+) repeatedly.
- For automatic tuning, press and hold TUNING.(-/+) for about two seconds on the front panel.

To select a preset radio station directly

You can use the number buttons on the remote control to select a preset radio station directly. For example, to listen to the preset station 4, press 4 on the remote control. To listen to the preset station 19, press 1 and then 9 (within 3 seconds).

For your reference

- **If an FM program is noisy**
Press FM MODE. on the front panel or on the Remote Control to make "MONO" appear in the display window. There will be no stereo effect, but the reception will improve. Press the button again to restore the stereo effect.
- **To improve reception**
Reorient the supplied antennas.

Sleep Timer Setting

You can set the DVD/CD Receiver to turn off automatically at a specified time.

1. **Press SLEEP to set the desired sleep time.**
The SLEEP indicator and the sleep time appears in the display window.
2. **Each time you press SLEEP the setting changes in the following order.**
SLEEP 180 → 150 → 120 → 90 → 80 → 70 → 60 → 50 → 40 → 30 → 20 → 10 → OFF (No display)

Note:

You can check the remaining time before the DVD/CD Receiver turns off.
Press SLEEP. The remaining time appears in the display window.

Dimmer

This function will change the brightness of the display window on the front panel during in power-on status.

Press the DIMMER repeatedly.

Muting

Press MUTING to mute your unit.

You can mute your unit in order, for example, to answer the telephone, the "MUTING" indicator flashes in the display window.

Note:

This muting doesn't affect the audio output to HDMI; it only mutes the output of speakers connected to the unit.

Setting the disc ejection lock

You can lock the disc tray to prevent the disc from being ejected.

When the main unit is turned off, hold down the STOP key at the front panel for 5 seconds

If you attempt to open the disc tray by pressing OPEN/CLOSE key, the disc tray does not open and "LOCKED" appears in the display window.

To cancel the disc ejection lock, hold down the STOP key at the front panel for 5 seconds again when the main unit is turned off.

"UNLOCKED" is displayed in the display window.

Note:

Before the main unit is turned off, DVD/CD function should be selected.

Enjoying audio form an external source

You can enjoy audio form an external source through your unit.

Press INPUT repeatedly to select the desired input source. - AUX, AUX OPT, AUDIO IN, OSD IPOD, IPOD, HDMI IN

Setting the surround mode

This system has a number of pre-set surround sound fields. You can select a desired sound mode by using **SOURROUND**. You can change the **SOURROUND** using ◀/▶ arrow key while the **SOURROUND** information is displayed on.

The displayed items for the Equalizer may be different depending on sound sources and effects.

[[PLII MOVIE/ PLII MUSIC/ PLII MTRX(matrix)] Dolby Pro Logic II enables you to play stereo source on 5.1-channel.

[Bypass] You can enjoy the sound without equalizer effect.

Notes:

- In some of surround modes, some speakers maybe no sound or low sound, it depends on the mode of surround and the source of audio, it is not defective.
- You may need resetting the surround mode, after switch the input, sometimes even after the sound track changed.

Language Codes

Use this list to input your desired language for the following initial settings:
Disc Audio, Disc Subtitle, Disc Menu.

Language	Code	Language	Code	Language	Code	Language	Code
Abkhazian	6566	Fiji	7074	Lingala	7678	Singhalese	8373
Afar	6565	Finnish	7073	Lithuanian	7684	Slovak	8375
Afrikaans	6570	French	7082	Macedonian	7775	Slovenian	8376
Albanian	8381	Frisian	7089	Malagasy	7771	Somali	8379
Ameharic	6577	Galician	7176	Malay	7783	Spanish	6983
Arabic	6582	Georgian	7565	Malayalam	7776	Sudanese	8385
Armenian	7289	German	6869	Maltese	7784	Swahili	8387
Assamese	6583	Greek	6976	Maori	7773	Swedish	8386
Aymara	6588	Greenlandic	7576	Marathi	7782	Tagalog	8476
Azerbaijani	6590	Guarani	7178	Moldavian	7779	Tajik	8471
Bashkir	6665	Gujarati	7185	Mongolian	7778	Tamil	8465
Basque	6985	Hausa	7265	Nauru	7865	Tatar	8484
Bengali; Bangla	6678	Hebrew	7387	Nepali	7869	Telugu	8469
Bhutani	6890	Hindi	7273	Norwegian	7879	Thai	8472
Bihari	6672	Hungarian	7285	Oriya	7982	Tibetan	6679
Breton	6682	Icelandic	7383	Panjabi	8065	Tigrinya	8473
Bulgarian	6671	Indonesian	7378	Pashto, Pushto	8083	Tonga	8479
Burmese	7789	Interlingua	7365	Persian	7065	Turkish	8482
Byelorussian	6669	Irish	7165	Polish	8076	Turkmen	8475
Cambodian	7577	Italian	7384	Portuguese	8084	Twi	8487
Catalan	6765	Japanese	7465	Quechua	8185	Ukrainian	8575
Chinese	9072	Javanese	7487	Rhaeto-Romance	8277	Urdu	8582
Corsican	6779	Kannada	7578	Rumanian	8279	Uzbek	8590
Croatian	7282	Kashmiri	7583	Russian	8285	Vietnamese	8673
Czech	6783	Kazakh	7575	Samoan	8377	Volapük	8679
Danish	6865	Kirghiz	7589	Sanskrit	8365	Welsh	6789
Dutch	7876	Korean	7579	Scots Gaelic	7168	Wolof	8779
English	6978	Kurdish	7585	Serbian	8382	Xhosa	8872
Esperanto	6979	Laothian	7679	Serbo-Croatian	8372	Yiddish	7473
Estonian	6984	Latin	7665	Shona	8378	Yoruba	8979
Faroese	7079	Latvian, Lettish	7686	Sindhi	8368	Zulu	9085

Area Codes

Choose a area code from this list.

Area	Code	Area	Code	Area	Code	Area	Code
Afghanistan	AF	Ethiopia	ET	Malaysia	MY	Saudi Arabia	SA
Argentina	AR	Fiji	FJ	Maldives	MV	Senegal	SN
Australia	AU	Finland	FI	Mexico	MX	Singapore	SG
Austria	AT	France	FR	Monaco	MC	Slovak Republic	SK
Belgium	BE	Germany	DE	Mongolia	MN	Slovenia	SI
Bhutan	BT	Great Britain	GB	Morocco	MA	South Africa	ZA
Bolivia	BO	Greece	GR	Nepal	NP	South Korea	KR
Brazil	BR	Greenland	GL	Netherlands	NL	Spain	ES
Cambodia	KH	Heard and McDonald Islands	HM	Netherlands Antilles	AN	Sri Lanka	LK
Canada	CA	Hong Kong	HK	New Zealand	NZ	Sweden	SE
Chile	CL	Hungary	HU	Nigeria	NG	Switzerland	CH
China	CN	India	IN	Norway	NO	Taiwan	TW
Colombia	CO	Indonesia	ID	Oman	OM	Thailand	TH
Congo	CG	Israel	IL	Pakistan	PK	Turkey	TR
Costa Rica	CR	Italy	IT	Panama	PA	Uganda	UG
Croatia	HR	Jamaica	JM	Paraguay	PY	Ukraine	UA
Czech Republic	CZ	Japan	JP	Philippines	PH	United States	US
Denmark	DK	Kenya	KE	Poland	PL	Uruguay	UY
Ecuador	EC	Kuwait	KW	Portugal	PT	Uzbekistan	UZ
Egypt	EG	Libya	LY	Romania	RO	Vietnam	VN
El Salvador	SV	Luxembourg	LU	Russian Federation	RU	Zimbabwe	ZW

Troubleshooting

Check the following guide for the possible cause of a problem before contacting service.

Symptom	Cause	Correction
No power.	<ul style="list-style-type: none"> The power cord is disconnected. 	<ul style="list-style-type: none"> Plug the power cord securely into the wall outlet.
The power is on, but the DVD/CD Receiver does not work.	<ul style="list-style-type: none"> No disc is inserted. 	<ul style="list-style-type: none"> Insert a disc. (Check that the DVD or, audio CD indicator in the DVD display is lit.)
No picture.	<ul style="list-style-type: none"> The TV is not set to receive DVD signal output. 	<ul style="list-style-type: none"> Select the appropriate video input mode on the TV so the picture from the DVD/CD Receiver appears on the TV screen.
	<ul style="list-style-type: none"> The video cable is not connected securely. 	<ul style="list-style-type: none"> Connect the video cable into the jacks securely.
	<ul style="list-style-type: none"> The connected TV power is turned off. 	<ul style="list-style-type: none"> Turn on the TV.
There is no sound or only a very low-level sound is heard.	<ul style="list-style-type: none"> The equipment connected with the audio cable is not set to receive DVD signal output. 	<ul style="list-style-type: none"> Select the correct input mode of the audio receiver so you can hear the sound from the DVD/CD Receiver.
	<ul style="list-style-type: none"> The audio cables are not connected securely. 	<ul style="list-style-type: none"> Connect the audio cable into the jacks securely.
	<ul style="list-style-type: none"> The power of the equipment connected with the audio cable is turned off. 	<ul style="list-style-type: none"> Turn on the equipment connected with the audio cable.
	<ul style="list-style-type: none"> The audio connecting cable is damaged. 	<ul style="list-style-type: none"> Replace it with new one.
The playback picture is poor.	<ul style="list-style-type: none"> The disc is dirty. 	<ul style="list-style-type: none"> Clean the disc.
The DVD/CD Receiver does not start playback.	<ul style="list-style-type: none"> No disc is inserted. 	<ul style="list-style-type: none"> Insert a disc. (Check that the DVD, or audio CD indicator in the DVD display is lit.)
	<ul style="list-style-type: none"> An unplayable disc is inserted. 	<ul style="list-style-type: none"> Insert a playable disc. (Check the disc type, colour system and Regional code.)
	<ul style="list-style-type: none"> The disc is placed upside down. 	<ul style="list-style-type: none"> Place the disc with the playback side down.
	<ul style="list-style-type: none"> The disc is not placed within the guide. 	<ul style="list-style-type: none"> Place the disc on the disc tray correctly inside the guide.
	<ul style="list-style-type: none"> The disc is dirty. 	<ul style="list-style-type: none"> Clean the disc.
	<ul style="list-style-type: none"> A menu is on the TV screen. 	<ul style="list-style-type: none"> Press the SETUP button to turn off the menu screen.
	<ul style="list-style-type: none"> The Rating level is set. 	<ul style="list-style-type: none"> Cancel the Rating function or change the rating level.
Loud hum or noise is heard.	<ul style="list-style-type: none"> The disc is dirty. 	<ul style="list-style-type: none"> Clean the disc.
	<ul style="list-style-type: none"> The speakers and components are connected poorly. 	<ul style="list-style-type: none"> Connect the speakers and components securely.
	<ul style="list-style-type: none"> The DVD/CD Receiver is located too close to the TV. 	<ul style="list-style-type: none"> Move your TV away from the audio components.

Symptom	Cause	Correction
Radio stations cannot be tuned in.	<ul style="list-style-type: none"> The antenna is positioned or connected poorly. 	<ul style="list-style-type: none"> Connect the antenna securely. Adjust the antennas and connect an external antenna if necessary.
	<ul style="list-style-type: none"> The signal strength of the stations is too weak (when tuning in with automatic tuning). 	<ul style="list-style-type: none"> Tune in the station manually.
	<ul style="list-style-type: none"> No stations have been preset or preset stations have been cleared (when tuning by scanning preset stations). 	<ul style="list-style-type: none"> Preset the stations (page 21).
The remote control does not work properly.	<ul style="list-style-type: none"> The remote control is not pointed at the remote sensor of the DVD/CD Receiver. 	<ul style="list-style-type: none"> Point the remote control at the remote sensor of the DVD/CD Receiver.
	<ul style="list-style-type: none"> The remote control is too far from the DVD/CD Receiver. 	<ul style="list-style-type: none"> Use the remote control within about 23 ft (7 m).
	<ul style="list-style-type: none"> There is an obstacle in the path of the remote control and the DVD/CD Receiver. 	<ul style="list-style-type: none"> Remove the obstacle.
	<ul style="list-style-type: none"> The batteries in the remote control are flat. 	<ul style="list-style-type: none"> Replace the batteries with new ones.
The front panel display is too dim.	<ul style="list-style-type: none"> Nothing is displayed on the front panel display. 	<ul style="list-style-type: none"> Press DIMMER on the remote control.

Specifications

General	Power supply	120 V ~ 60 Hz		
	Power consumption	110 W		
	Net Weight	4 kg		
	External dimensions (W x H x D)	430 x 72 x 307 mm		
	Operating conditions	Temperature: 5°C to 35°C, Operation status: Horizontal		
	Operating humidity	5% to 85%		
	Laser	Semiconductor laser, wavelength 650 nm		
CD/DVD	Video system	NTSC		
	Frequency response (audio)	140 Hz to 20 kHz ★		
	Signal-to-noise ratio (audio)	More than 75 dB (1 kHz, 20 kHz LPF/A-Filter) ★		
	Dynamic range (audio)	More than 75 dB ★		
	Harmonic distortion (audio)	0.5 % (1 kHz, at 1W position) (20 kHz LPF) ★		
Video	Video output	1.0 V (p-p), 75 Ω, negative sync., RCA jack x 1		
	COMPONENT VIDEO OUT	(Y) 1.0 V (p-p), 75 ohms, negative sync, RCA jack x 1 (P _B)/(P _R) 0.7 V (p-p), 75 ohms, RCA jack x 1		
	HDMI OUT	480p/720p/1080i/1080p		
Tuner	FM	Tuning Range	87.5 - 108.0 MHz	
		Intermediate Frequency	10.7 MHz	
		Signal-to Noise Ratio	60 dB (Mono) ★	
		Frequency Response	140 - 10,000 Hz ★	
Amplifier	Stereo mode	155 W + 155 W (4Ω at 1 kHz, THD 10 %)		
	Surround mode (* Depending on the sound mode settings and the source, there may be no sound output.)	Front: 155 W + 155 W (THD 10 %) center*: 155 W Surround*: 155 W + 155 W (4Ω at 1 kHz, THD 10 %) Subwoofer*: 225 W (3Ω at 70 Hz, THD 10 %)		
	Inputs	AUDIO IN, OPTICAL IN, AUX IN, iPod, HDMI IN		
	Outputs	MONITOR OUT, HDMI OUT, COMPONENT VIDEO OUT		
Speakers		Front/Rear Speaker	Center speaker	Passive Subwoofer
	Type	1 Way 1 Speaker	1 Way 1 Speaker	1 Way 1 Speaker
	Impedance	4 Ω	4 Ω	3 Ω
	Frequency Response	120 - 20000 Hz	120 -20000 Hz	40 - 1500 Hz
	Sound Pressure Level	83 dB/W (1m)	83 dB/W (1m)	82 dB/W (1m)
	Rated Input Power	155 W	155 W	225 W
	Max. Input Power	310 W	310 W	450 W
	Net Dimensions (W x H x D)	117 x 210 x 111 mm	300 x 115 x 111 mm	236 x 435 x 391 mm
	Net Weight	0.9 kg	1.1 kg	5.7 kg

Items with ★ are measured at Front Speaker Terminals in STEREO mode

Supplied Accessories

FM Antennax1	Video RCA cablex1
Speaker cablex6	iPod Docking stationx1
Remote controlx1	Batteriesx2

* Designs and specifications are subject to change without notice.

WARRANTY (Only in U.S.A.)

JVC[®] **LIMITED WARRANTY** **USA ONLY**

ONLY FOR PRODUCT PURCHASED IN U.S.A. CONSUMER VIDEO 1-90

JVC COMPANY OF AMERICA (JVC) warrants this product and all parts thereof, except as set forth below ONLY TO THE ORIGINAL RETAIL PURCHASER to be FREE FROM DEFECTIVE MATERIALS AND WORKMANSHIP from the date of original purchase for the period shown below. ("The Warranty Period")

PARTS	1 YR	LABOR	90 DAYS
-------	-------------	-------	----------------

THIS LIMITED WARRANTY IS VALID ONLY IN THE FIFTY (50) UNITED STATES, THE DISTRICT OF COLUMBIA AND IN THE COMMONWEALTH OF PUERTO RICO.

WHAT WE WILL DO:

If this product is found to be defective within the warranty period, JVC will repair or replace defective parts with new or rebuilt equivalents at no charge to the original owner. Such repair and replacement services shall be rendered by JVC during normal business hours at JVC authorized service centers. Parts used for replacement are warranted only for the remainder of the Warranty Period. All products may be brought to a JVC authorized service center on a carry-in basis. Color televisions with a screen size of 27" or greater qualify for in-home service. In such cases, a technician will come to your home and either repair the TV there or remove and return it if it cannot be repaired in your home.

WHAT YOU MUST DO FOR WARRANTY SERVICE:

Please do not return your product to the retailer
 Instead, return your product to the JVC authorized service center nearest you. If shipping the product to the service center, please be sure to package it carefully, preferably in the original packaging, and include a brief description of the problem(s). Please call 1-800-252-5722 to locate the nearest JVC authorized service center. Service locations can also be obtained from our website <http://www.jvc.com>. If your product qualifies for in-home service, the service representative will require clear access to the product.

If you have any questions concerning your JVC Product, please contact our Customer Relations Department at 800-252-5722

WHAT IS NOT COVERED:

This limited warranty provided by JVC does not cover:

1. Products which have been subject to abuse, accident, alteration, modification, tampering, negligence, misuse, faulty installation, lack of reasonable care, or if repaired or serviced by anyone other than a service facility authorized by JVC to render such service, or if affixed to any attachment not provided with the products, or if the model or serial number has been altered, tampered with, defaced or removed;
2. Initial installation, installation and removal from cabinets or mounting systems.
3. Operational adjustments covered in the Owner's Manual, normal maintenance, video and audio head cleaning;
4. Damage that occurs in shipment, due to act of God, and cosmetic damage;
5. Signal reception problems and failures due to line power surge;
6. User Removal Memory Devices/Video Pick-up Tubes/CCD Image Sensors are covered for 90days from the date of purchase;
7. Accessories;
8. Batteries (except that Rechargeable Batteries are covered for 90 days from the date of purchase);
9. Products used for commercial purposes, including, but not limited to rental.
10. Loss of data resultant from malfunction of hard drive or other data storage device.

There are no express warranties except as listed above.

THE DURATION OF ANY IMPLIED WARRANTIES, INCLUDING THE IMPLIED WARRANTY OF MERCHANTABILITY, IS LIMITED TO THE DURATION OF THE EXPRESS WARRANTY HEREIN.

JVC SHALL NOT BE LIABLE FOR ANY LOSS OF USE OF THE PRODUCT, INCONVENIENCE, OR ANY OTHER DAMAGES, WHETHER DIRECT, INCIDENTAL OR CONSEQUENTIAL (INCLUDING, WITHOUT LIMITATION, DAMAGE TO TAPES, RECORDS OR DISCS) RESULTING FROM THE USE OF THIS PRODUCT, OR ARISING OUT OF ANY BREACH OF THIS WARRANTY. ALL EXPRESS AND IMPLIED WARRANTIES, INCLUDING THE WARRANTIES OF MERCHANTABILITY AND FITNESS FOR PARTICULAR PURPOSE, ARE LIMITED TO THE WARRANTY PERIOD SET FORTH ABOVE.

Some states do not allow the exclusion of incidental or consequential damages or limitations on how long an implied warranty lasts, so these limitations or exclusions may not apply to you. This warranty gives you specific legal rights and you may also have other rights which vary from state to state.

JVC COMPANY OF AMERICA 1700 Valley Road
 DIVISION OF JVC AMERICAS CORP. Wayne, NJ 07470
<http://www.jvc.com>

REFURBISHED PRODUCTS CARRY A SEPARATE WARRANTY, THIS WARRANTY DOES NOT APPLY. FOR DETAIL OF REFURBISHED PRODUCT WARRANTY, PLEASE REFER TO THE REFURBISHED PRODUCT WARRANTY INFORMATION PACKAGED WITH EACH REFURBISHED PRODUCT.

For customer use:

Enter below the Model No. and Serial No. which is located either on the rear, bottom or side of the cabinet. Retain this information for future reference.

Model No. :	Serial No. :
Purchase date :	Name of dealer :

FOR SERVICING (Only in U.S.A.)

TO OUR VALUED CUSTOMER

THANK YOU FOR PURCHASING THIS JVC PRODUCT.
WE WANT TO HELP YOU ACHIEVE A PERFECT EXPERIENCE.

**NEED HELP ON HOW TO HOOK UP?
NEED ASSISTANCE ON HOW TO OPERATE?
NEED TO LOCATE A JVC SERVICE CENTER?
LIKE TO PURCHASE ACCESSORIES?**

TH-G50J

JVC[®] IS HERE TO HELP!
TOLL FREE: 1(800)252-5722
<http://www.jvc.com>

Remember to retain your Bill of Sale for Warranty Service.

Do not attempt to service the product yourself

Caution

To prevent electrical shock, do not open the cabinet.
There are no user serviceable parts inside.
Please refer to qualified service personnel for repairs.

BT-51005-9
(0904)

JVC

© 2009 Victor Company of Japan, Limited

0409SKMLGEEGL

