



VCR OWNER'S MANUAL

MODEL: CC990M



**Before connecting, operating, or adjusting this product,
please read this instruction booklet carefully and completely.**

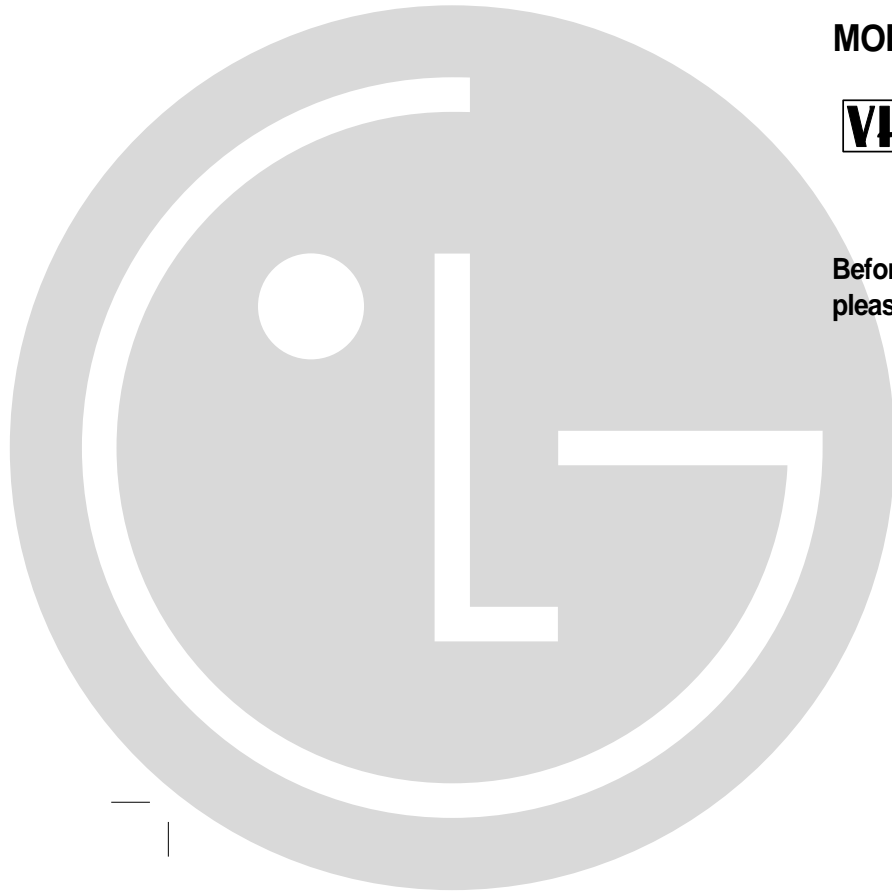

Precautions Information

Note to CATV system installer: This reminder is provided to call the CATV system installer's attention to Section 820-40 of the NEC which provides guidelines for proper grounding and, in particular, specifies that the cable ground shall be connected to the grounding system of the building, as close to the point of cable entry as practical.

2

**WARNING : TO REDUCE THE RISK OF FIRE OR ELECTRIC SHOCK,
DO NOT EXPOSE THIS APPLIANCE TO RAIN OR MOISTURE.**



CAUTION
RISK OF ELECTRIC SHOCK
DO NOT OPEN



This lightning flash with arrowhead symbol within an equilateral triangle is intended to alert the user to the presence of uninsulated dangerous voltage within the product's enclosure that may be of sufficient magnitude to constitute a risk of electric shock to persons.



The exclamation point within an equilateral triangle is intended to alert the user to the presence of important operating and maintenance (servicing) instructions in the literature accompanying the product.

CAUTION : TO REDUCE THE RISK OF
ELECTRIC SHOCK,
DO NOT REMOVE COVER (OR BACK);
NO USER-SERVICEABLE PARTS INSIDE
REFER SERVICING TO QUALIFIED SERVICE PERSONNEL.

CAUTION : TO PREVENT ELECTRIC SHOCK, DO NOT USE THIS PLUG WITH AN EXTENSION CORD, RECEPTACLE OR OTHER OUTLET UNLESS THE PLUG CAN BE FULLY INSERTED WITHOUT EXPOSING ANY PARTS OF THE BLADES.

FCC WARNING: This equipment may generate or use radio frequency energy. Changes or modifications to this equipment may cause harmful interference unless the modifications are expressly approved in the instruction manual. The user could lose the authority to operate this equipment if an unauthorized change or modification is made.

REGULATORY INFORMATION

This equipment has been tested and found to comply with the limits for a Class B digital device, pursuant to Part 15 of the FCC Rules. These limits are designed to provide reasonable protection against harmful interference in a residential installation! This equipment generates, uses and can radiate radio frequency energy and, if not installed and used in accordance with the instructions, may cause harmful interference to radio communications.

However, there is no guarantee that interference will not occur in a particular installation. If this equipment does cause harmful interference to radio or television reception, which can be determined by turning the equipment off and on, the user is encouraged to try to correct the interference by one or more of the following measures:

- Reorient or relocate the receiving antenna.
- Increase the separation between the equipment and receiver.
- Connect the equipment into an outlet on a circuit different from that to which the receiver is connected.
- Consult the dealer or an experienced radio/TV technician for help.

This Class (B) digital apparatus meets all requirements of the Canadian Interference-Causing Equipment Regulations.

Cet appareil numérique de la classe (B) respecte toutes les exigences du Règlement sur le matériel brouilleur du Canada.

Table of Contents

Features



Main features of this VCR

- **MTS Hi-Fi Stereo**
- **OPR (Optimum Picture Response)**
- **Easy Graphic Menu**
- **Video Doctor (Advanced Self-Diagnosis)**
- **181 Channel Frequency Synthesized Cable Compatible Tuner with Autochannel Programming and Multichannel Scan**
- **1 Year/7 Event Timer with DAILY and WEEKLY Function**
- **Auto Power and Playback Functions**
- **ITR (Instant Timer Recording)**
- **Real-Time Tape Counter**
- **Visual Search, Logic Search, CM Skip**
- **Clean Still, Slow, Frame Advance**
- **Auto Tracking Function/ Auto Head Cleaner**
- **On-screen Display of Function**
- **Trilingual On-screen Programming (English/Spanish/Portuguese)**

Features/Contents	3	Hi-Fi Stereo System	23-24
Safety Tips	4-5	<i>MTS Broadcast</i>	23
Remote Control	6	<i>Audio Output Selection</i>	23
Your VCR's Controls (Front & Rear)	7	<i>Broadcast type selection for recording</i>	24
Connections	8-9	<i>SAP Recording</i>	24
<i>VCR to TV & Antenna to VCR</i> ..	8	Real-Time Counter/ Counter Memory	25
<i>CATV to VCR</i>	9	Other Functions	26
Display Window	10	<i>Video Doctor</i>	26
On-screen Display (OSD)	11	<i>Operating Hints</i>	26
Setting the On-screen Display	12	<i>ez (easy) Operation</i>	27
Setting the menu	13	Troubleshooting	28
<i>Language Select</i>	13	Specifications	29
<i>Function OSD On/Off</i>	13		
<i>Setting the Clock</i>	13		
Tuning in TV Stations	14		
How to Play Back a Tape	15-17		
<i>Normal Playback</i>	15		
<i>Special Playback</i>	16		
<i>The Others' Playback</i>	17		
How to Record	18-22		
<i>Normal Recording</i>	18		
<i>Instant Timer Recording</i>	19		
<i>Timer Recording</i>	20-21		
<i>Dubbing and Editing</i>	22		

The serial number is found on the back of this unit. This number is unique to this unit and not available to others. You should record requested information here and retain this guide as a permanent record of your purchase.

Model No. _____

Serial No. _____

SAFETY TIPS



Important safeguards for you and your new product

Your product has been manufactured and tested with your safety in mind. However, improper use can result in potential electrical shock or fire hazards. To avoid defeating the safeguards that have been built into your new product, please read and observe the following safety points when installing and using your new product, and save them for future reference.

Observing the simple precautions discussed in this section of the operating guide can help you get many years of enjoyment and safe operation that are built into your new product.

1. Read Instructions

All the safety and operating instructions should be read before the product is operated.

2. Follow Instructions

All operating and use instructions should be followed.

3. Retain Instructions

The safety and operating instructions should be retained for future reference.

4. Heed Warnings

All warnings on the product and in the operating instructions should be adhered to.

5. Cleaning

Unplug this product from the wall outlet before cleaning. Do not use liquid cleaners or aerosol cleaners. Use a damp cloth for cleaning.

6. Water and Moisture

Do not use this product near water – for example, near a bath tub, wash bowl, kitchen sink, or laundry tub, in a wet basement, or near a swimming pool.

7. Accessories

Do not place this product on an unstable cart, stand, tripod, bracket, or table. The product may fall, causing serious injury to a child or adult, and serious damage to the product. Use only with a cart, stand, tripod, bracket, or table recommended by the

manufacturer, or sold with the product. Any mounting of the product should follow the manufacturer's instructions, and should use a mounting accessory recommended by the manufacturer.

8. Transporting Product

A product and cart combination should be moved with care. Quick stops, excessive force, and uneven surfaces may cause the product and cart combination to overturn.



PORTABLE CART
WARNING

9. Attachments

Do not use attachments not recommended by the product manufacturer as they may cause hazards.

10. Ventilation

Slots and openings in the cabinet are provided for ventilation and to ensure reliable operation of the product and to protect it from overheating, and these openings must not be blocked or covered. The openings should never be blocked by placing the product on a bed, sofa, rug, or other similar surface. This product should not be placed in a built-in installation such as a bookcase or rack unless proper ventilation is provided or the manufacturer's instructions have been adhered to.

11. Power Sources

This product should be operated only from the type of power source indicated on the marking label. If you are not sure of the type of power supply to your home, consult your product dealer or local power company. For products intended to operate from battery power, or other sources, refer to the operating instructions.

12. Line-Cord Polarization

This product is equipped with a polarized alternating-current line plug (a plug having one blade wider than the other). This plug will fit into the power outlet only one way. This is a safety feature. If you are unable to insert the plug fully into the outlet, try reversing the plug. If the plug should still fail to fit, contact your electrician to replace your obsolete outlet. Do not defeat the safety purpose of the polarized plug.

13. Power-Cord Protection

Power-supply cords should be routed so that they are not likely to be walked on or pinched by items placed upon or against them, paying particular attention to cords at plugs, convenience receptacles, and the point where they exit from the product.

14. Outdoor Antenna Grounding

If an outside antenna or cable system is connected to the product, be sure the antenna or cable system is grounded so as to provide some protection against voltage surges and built-up static charges. Article 810 of the National Electrical Code (U.S.A), ANSI/NFPA 70 provides information with regard to proper grounding of the mast and supporting structure, grounding of the lead-in wire to an antenna discharge unit, size of grounding conductors, location of antenna-discharge unit, connection to grounding electrodes, and requirements for the grounding electrode. (See figure 1 on the right.)

15. Lightning

For added protection for this product (receiver) during a lightning storm, or when it is left unattended and unused for long periods of time, unplug it from the wall outlet and disconnect the antenna or cable system. This will prevent damage to the product due to lightning and power-line surges.

16. Power Lines

An outside antenna system should not be located in the vicinity of overhead power lines or other electric light or power circuits, or where it can fall into such power lines or circuits. When installing an outside antenna system, extreme care should be taken to keep from touching such power lines or circuits as contact with them might be fatal.

17. Overloading

Do not overload wall outlets and extension cords as this can result in a risk of fire or electric shock.

18. Object and Liquid Entry

Never push objects of any kind into this product through openings as they may touch dangerous voltage points or short-out parts that could result in a fire or electric shock. Never spill liquid of any kind on the product.

19. Servicing

Do not attempt to service this product yourself as opening or removing covers may expose you to dangerous voltage or other hazards. Refer all servicing to qualified service personnel.

20. Damage Requiring Service

Unplug this product from the wall outlet and refer servicing to qualified service personnel under the following conditions:

- a. If the power-supply cord or plug is damaged.
- b. If liquid has been spilled, or objects have fallen into the product.
- c. If the product has been exposed to rain or water.
- d. If the product does not operate normally by following the operating instructions. Adjust only those controls that are covered by the operating instructions as an improper adjustment of other controls may result in damage and will often require extensive work by a qualified technician to restore the product to its normal operation.
- e. If the product has been dropped or the cabinet has been damaged.
- f. If the product exhibits a distinct change in performance.

21. Replacement Parts

When replacement parts are required, be sure the service technician has

used replacement parts specified by the manufacturer or have the same characteristics as the original part. Unauthorized substitutions may result in fire, electric shock, or other hazards.

22. Safety Check

Upon completion of any service or repairs to this product, ask the service technician to perform safety checks to determine that the product is in proper operating condition.

23. Wall or Ceiling Mounting

The product should be mounted to a wall or ceiling only as recommended by the manufacturer.

24. Heat

The product should be situated away from heat sources such as radiators, heat registers, stoves, or other products (including amplifiers) that produce heat.

Figure 1

EXAMPLE OF GROUNDING ACCORDING TO NATIONAL ELECTRICAL CODE INSTRUCTIONS

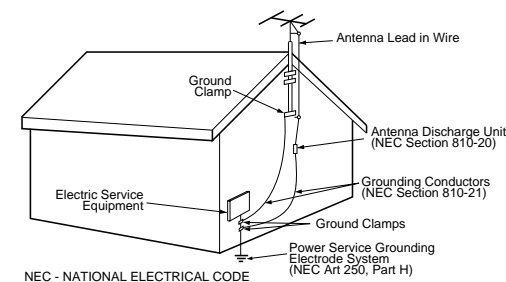

Remote Control Location & Functions

To install batteries:

Your remote control is powered by two AA type batteries.

1. To insert them, push the tab backwards and lift off the cover of the remote control.
2. Put the two batteries into the compartment making sure the + and - are correctly positioned.
3. Replace the cover.

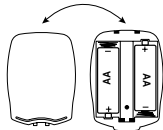

6

Your video recorder (VCR) is designed so that almost all of its features can be controlled from the Remote Control. Some features can also be controlled from the front panel of the video recorder. The maximum operating distance that you may control your video recorder is about 25 feet (7.5 meters). It must also be within an angle of 30 degrees either side of the remote sensor on the front of your video recorder.

To avoid damage from possible battery leakage, remove the batteries if you do not plan to use the remote control for an extended period of time. Do not use batteries of differing age or type. Always discard batteries safely.

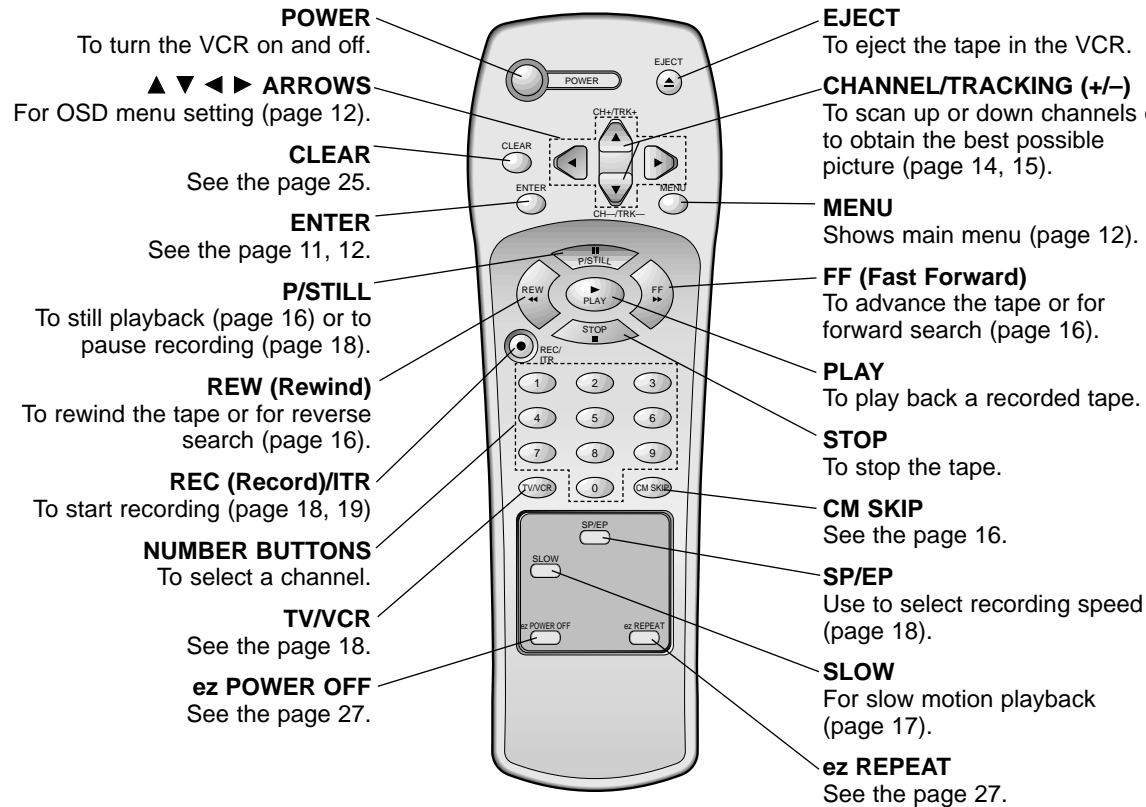



Each button on your VCR has the same function as its corresponding button on the remote control.

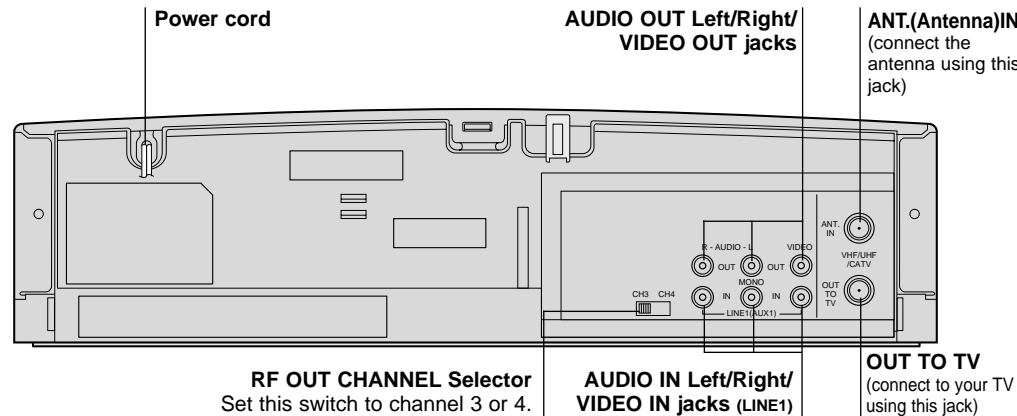
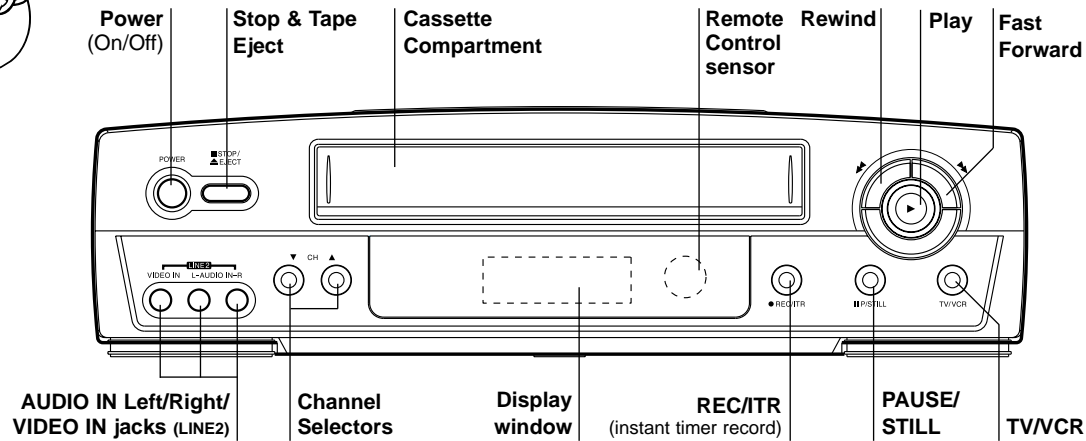

Your VCR's Controls

You can select LINE1 (from AUDIO/VIDEO IN jacks at the rear) or LINE 2 (from AUDIO/ VIDEO IN jacks at the front) pressing **CH (+/-)** continuously to display "LINE1" or "LINE2" on the TV screen.

You can also select "LINE1" or "LINE2" by pressing **0** button twice or four times.

Connections

VCR to TV & Antenna to VCR

VCR reception setting

When a TV is connected with a coaxial cable only
 When the TV is connected to the OUT TO TV using a supplied coaxial cable only, set the channel selector at the rear to CH 3 or CH 4, not employed for broadcasts, and select the same channel on the TV.

When a TV is connected with an audio/video cable
 When the TV is connected using an audio/video cable, turn the TV and VCR on, and select the video input mode on the TV.

The guidance given on the next two pages is the most common forms of connection. However please check with your manufacturers instruction books for specific information. Make sure all connections are made with both your VCR and additional appliance unplugged from the mains to avoid damaging your equipment. Connecting a VCR using a Audio/Video cable is one of the best ways to achieve optimum sound and picture quality from video-tape playback. If you own a stereo TV you will be able to enjoy stereo sound when playing a stereo video tape or stereo TV reception.

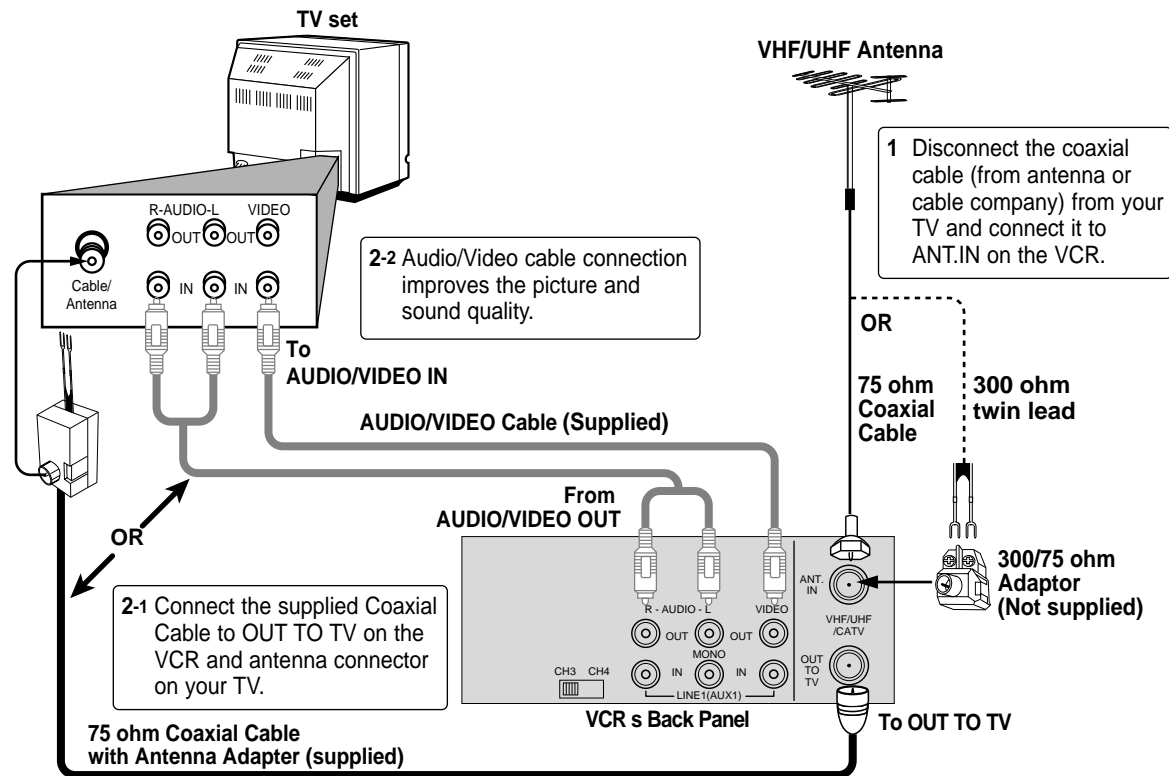

Connections

CATV to VCR

If your cable service supplies you with a cable converter box, you can use the basic connection shown below.



To view or record CATV channel

- 1 Set the TV channel to the video output channel as located on the back of the VCR (CH3 or CH4).
- 2 Set the VCR channel selector to the output channel of the cable converter box by pressing **CH (+/-)** or number buttons (**0-9**) of your VCR. (Example: CH3)
- 3 Select the channel to view at the Cable Converter Box.

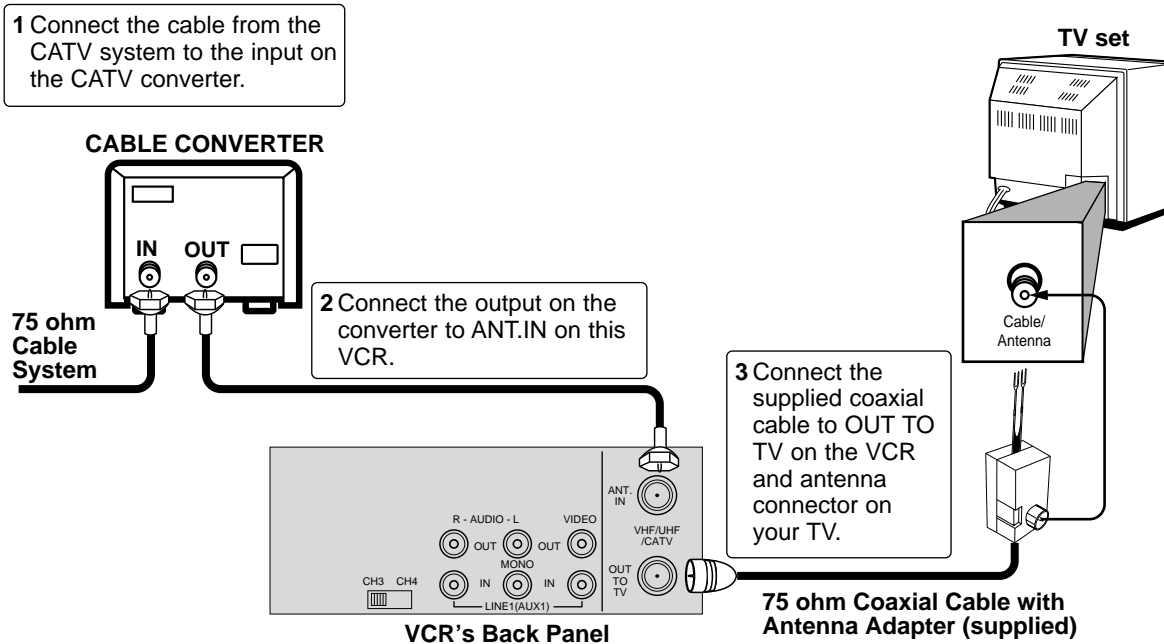

With this connection, you **CANNOT** record one program while viewing another.

Display window



Information appears in the display window depending on the VCR function being used.

Display window shows which VCR function you are using. For example, when you press **PLAY**, **PLAY** appears to indicate the tape operation. As you change channels, the channel numbers appear. The current time shows even while the VCR is off.

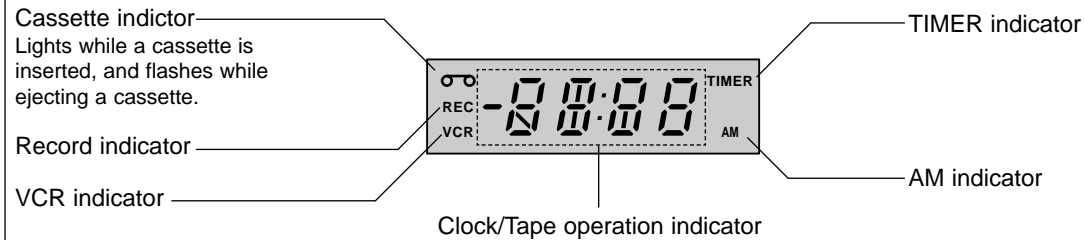

Front Panel Display shows which VCR function you are using. For example, when you press SP/EP, SP or EP appears to indicate the tape speed. As you change channels, the channel numbers appear. The current time shows even while the VCR is off.

HI — VCR is turned on.

BYE — VCR is turned off.

CUE — Tape is advancing rapidly in playback mode for visual search.

-CUE — Tape is reversing rapidly in playback mode for visual search.

FF (Fast Forward) — Tape is advancing rapidly.

L_ (Line_) — Auxiliary channel is selected for viewing equipment connected to Audio/Video jacks on the VCR.

PLAY — Tape is playing at normal playback speed.

REW (Rewind) — Tape is rewinding rapidly.

SLW (Slow) — Tape is playing at slow-motion forward speed.

STL (Still) — Playback is halted on one frame.

STOP — Tape rewind or playback is stopped.

CH _ — VCR tuned to Channel _.



Some of these functions will be displayed every time the VCR is operated.

Identifying the on-screen display item

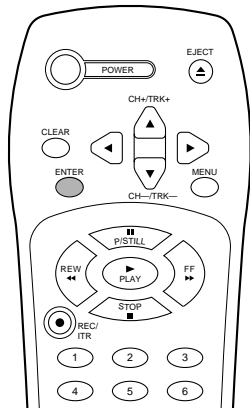
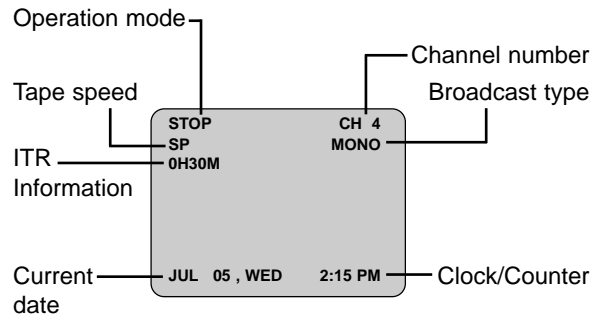

Changing the on-screen function display

Each press of the **ENTER** changes the TV screen in the following sequence.

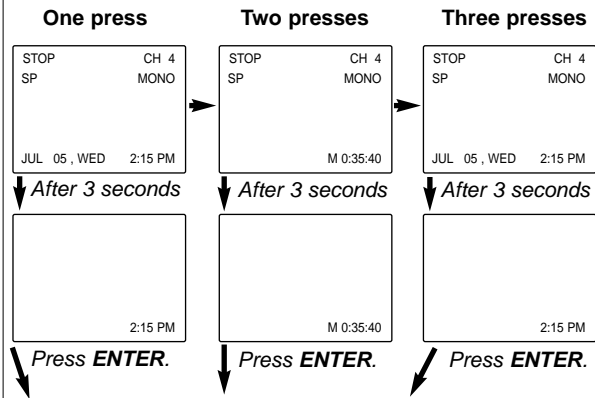

All indicator are turned off.

OSD On-screen Display

The clock (or tape counter) only mode will continue until you press **ENTER** again.

The tape counter display does not appear when the tape is not inserted.

Setting the On-screen Display

The SETUP, clock setting, and timer recordings are accessed conveniently with On-screen Menu Displays that lead you through each step. The following pages describe the On-screen selections to be set.



Blue Background on-screen Function: Shows blue background color on-screen while setting a menu. We recommend keeping blue background option ON when On-screen display flickers.

1

Press **MENU**.

The main menu appears.

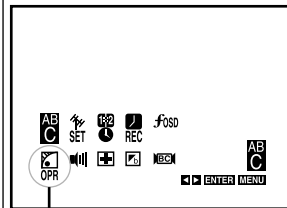
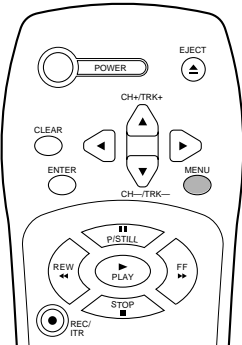

You may only set OPR when playing a tape.

2

Select the desired menu with **◀** or **▶** and then press **ENTER** to see desired sub menu to be used.

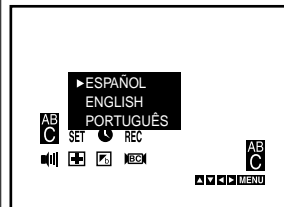
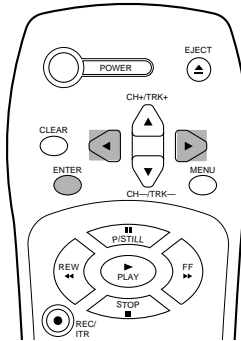

3

Press **MENU** to exit the menu.

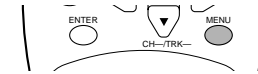

Blue Background on-screen Function On/Off

Select the item on the main menu with **◀** or **▶** and then press **ENTER**.

Select a desired mode (ON or OFF) with **▲** or **▼** and then press **◀** or **▶**.

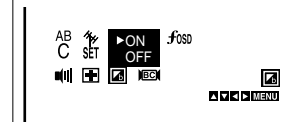
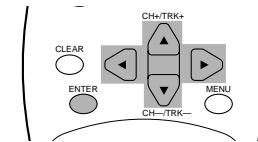

- To change the language setting for OSD (page 13).
- Manual/Automatic tuning setting (page 14).
- Date & clock setting (page 13).
- Timer recording setting (page 20).
- To display the operational mode of your VCR (page 13).
- To improve the playback picture (page 17).
- To select the channel for audio output (page 23).
- To check a problem with your VCR (page 26).
- To use blue background on-screen function (Details are on the right).
- To select received Broadcast type. (page 24)

Setting the Menu

Language Select Function OSD On/Off Setting the Clock

Language Selection: The on-screen programming of this VCR can display in either English, Spanish, or Portuguese.

Function OSD On/Off: The on-screen display of this VCR can be turned on or off.

Setting the Clock: You must set the date and time for timer recordings.

1

Language Selection

Select the $\frac{AB}{C}$ item on the main menu with ◀ or ▶ and then press **ENTER**.

Select a desired language with ▲ or ▼ and then press ◀ or ▶.

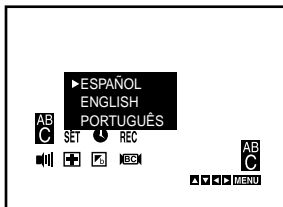
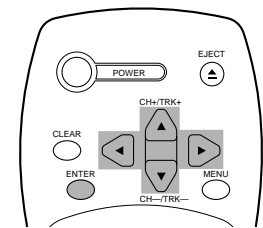

2

Function OSD ON/OFF

Select the f_{OSD} item on the main menu with ◀ or ▶ and then press **ENTER**.

Select a desired mode (ON or OFF) with ▲ or ▼ and then press ◀ or ▶.

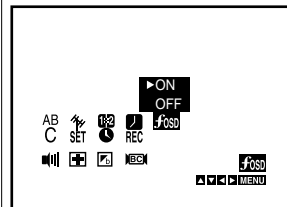
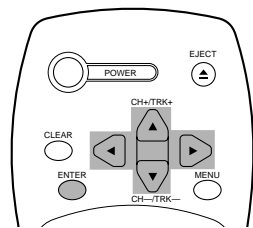

3

Setting the Clock

Select the $\frac{12}{24}$ item on the main menu with ◀ or ▶ and then press **ENTER**.

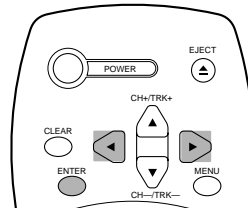

↓ Press **ENTER**

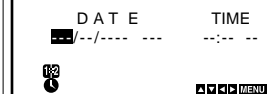

Press the ▼ or ▲ to set MONTH first, then press ▶ to move to next option. And then set DAY, YEAR and TIME by using ▼, ▲, and ▶.

Press **MENU** to exit the menu.

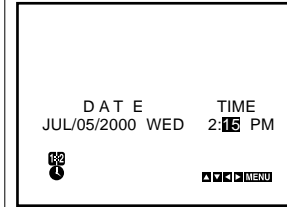
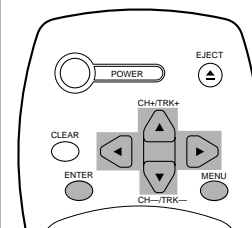



Tuning in TV Stations Automatically and Manually



This convenient Auto Channel Set function can preset up to 181 channels in your area (VHF channels 2 to 13, UHF channels 14 to 69 and CATV channels 1 to 125) on the VCR.

1

Select the  item on the main menu with  or , and then press **ENTER**.

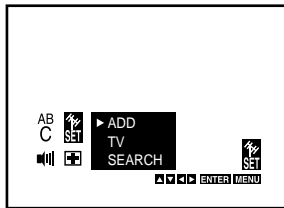
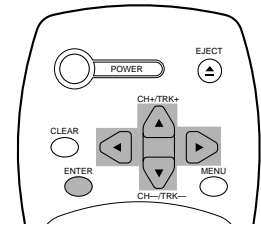

2



Press  to choose the **SEARCH** item, then press **ENTER**.

All available channels in your area are scanned and stored in the memory of the VCR. After scanning, the previous screen returns.

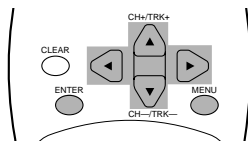
Press **MENU** to exit the menu.



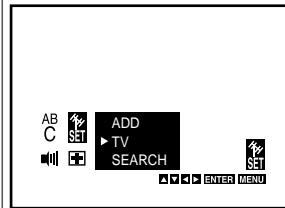

When you perform the Auto Channel Set, the VCR automatically selects the band (TV or CATV) in which there are more channels to be preset. Remember, TV is for the air antenna reception, CATV is for cable or wireless cable connection.

You can change the band by pressing  or  to choose second item, then press **ENTER** to display TV or CATV.



3

Adding or Deleting VCR channels manually

- 1 Select a channel using the **Number** buttons to add or **CH (+/-)** to delete.
- 2 Follow Step 1, then press  or  to choose the first item, then press **ENTER** to display ADD or DEL (Delete).

Press **MENU** to exit the menu.

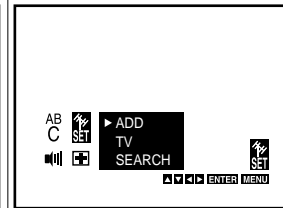
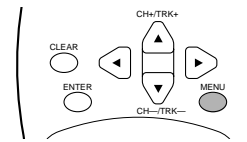

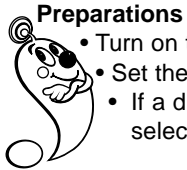

Preparations

- Turn on the power of both the VCR and TV.
- Set the TV to the VCR Output Channel (CH 3 or 4) or video input.
- If a direct VIDEO/AUDIO connection is made between the VCR and the TV, set the TV's source selector to VIDEO.

1

Insert the video cassette into your VCR.

The video cassette should have the window side facing up and the arrow facing away from you.

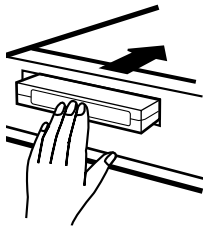

The power turns on automatically, if you load a video cassette which has had its record protection tab removed (e.g rental movies from video hire shops) playback of the cassette will start automatically.

2

Press **PLAY** to start playback.

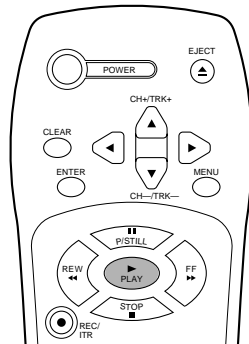

3

Press **STOP** to stop playback.

If the tape reaches the end before **STOP** is pressed, the VCR will automatically stop, rewind, eject, and it will turn itself off.

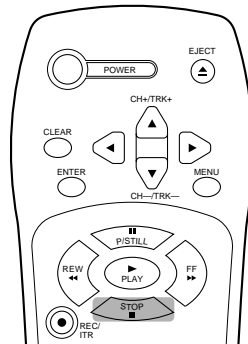

4

Adjusting the picture

Although the VCR adjusts the tracking automatically, you may need to adjust the tracking manually if the tape quality is too poor.

Auto tracking

While the VCR is adjusting the tracking automatically, "AUTO TRACKING" appears. It turns off after the adjustment is complete.

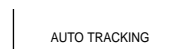

Manual tracking

If noise appears on the screen during playback, press either **TRK (+/-)** on the remote control until the noise on the screen is reduced.

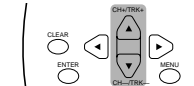

How to Play back a tape (Normal)

If you do not wish to record on a tape (this can happen quite easily by accident!) remove the protection tab on the back edge of the video cassette.

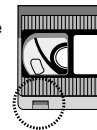

It is possible to record on a video cassette with the record protection tab removed by covering the hole with self adhesive tape.

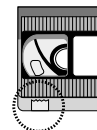

How to Play back a tape (Special)

Special effects playback notes:

Horizontal lines (noise bars) will appear on the TV screen. This is normal.

The audio is automatically muted during special effect modes, so there is no sound during search.

During the visual (or logic) search modes, a short period is needed to stabilize tape speed when re-entering the PLAY mode. Slight interference may be observed during this period.



Still Picture (& Frame Advance); You can watch a still picture during playback.

Visual search; This function lets you quickly and visually search for a desired tape section in either direction: forward (called CUE) and reverse (called REVIEW).

Logic search; You can watch a picture during fast-forward or rewind mode.

CM (Commercial Message) Skip; This feature enables you during playback of a tape to skip a commercial break in a few seconds, then resume normal playback.

1

Still Picture (& Frame Advance) during Playback

Press **P/STILL** to pause a picture during playback.

Press and hold **P/STILL** to advance the tape frame by frame (slow mode).

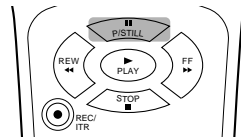

If a still picture vibrates vertically, stabilize it by pressing **TRK (+/-)** on the remote control.

If a still picture lasts for more than 5 minutes, the VCR will automatically enter stop mode to protect the tape.

To continue normal playback, press **PLAY**.

2

Visual search

Press the desired search buttons (**FF** or **REW**) during playback.

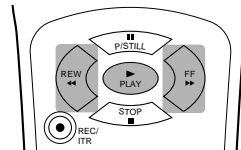

If forward and reverse searches lasts for more than 3 minutes, the VCR will automatically enter playback mode to protect the tape.

To continue normal playback, press **PLAY**.

3

Logic search

Press and hold the desired search button (**FF** or **REW**) during fast-forward or rewind mode.

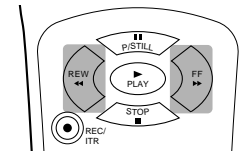

Visual search (CUE/REVIEW) begins so you can check what is on the tape.

When released, Fast Forward or Rewinding resumes.

4

CM (Commercial Message) Skip:

Press **CM SKIP** during playback to skip commercials or other material.

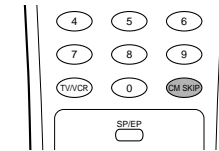

Pressing 1, 2, 3, 4, 5 or 6 times skips 30, 60, 90, 120, 150 or 180 seconds, respectively.

CM SKIP skips a full 180 seconds of commercials in a few seconds, then resumes normal playback.



Auto power shut-off; This feature is especially helpful when you finish watching a tape.

OPR (Optimum Picture Response); This feature automatically improves playback picture quality by adjusting your VCR to the condition of the tape.

1
Slow Motion Playback

Press **SLOW** during playback.

The tape will be played back at a speed 1/19 times slower than the normal speed.

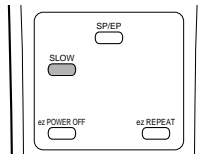

During slow playback, **TRK (+/-)** on the Remote Control can be used to minimize noise bands. When the slow mode continues for more than 3 minutes, the VCR will automatically change to play mode.

2
Auto power shut-off

During the REWIND mode, press **POWER** once.

The VCR will enter the Auto power shut-off mode.

The REW will flash.

After tape is rewind, VCR will turn off automatically.

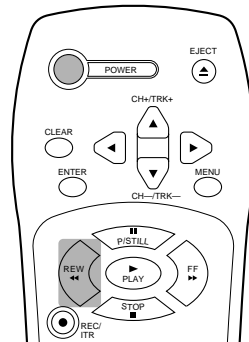

3
OPR (Optimum Picture Response):

You may only set OPR when playing a tape.

Select the  item on the main menu with **◀** or **▶** and then press **ENTER**.

Select a desired OPR mode (OFF, SOFT or HARD) with **▲** or **▼** and then press **▶** or **▶**.

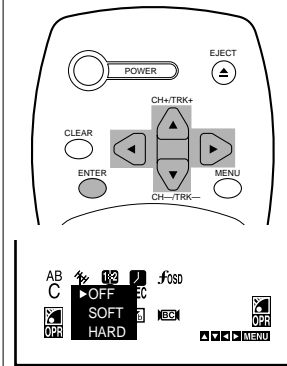

How to
Play back a tape
(Others)

 Select "OPR-SOFT" to make a picture more soft.

Select "OPR-HARD" to make a picture more sharp.

You may only set OPR when playing a tape.

How to record

Normal recording

To watch another TV program while recording

If the TV is connected only with an coaxial cable, press **TV/VCR** after starting the recording so that VCR indicator in the display window disappears. Then select another channel on the TV.

Preparations



- Make sure that you have correctly installed your VCR as described earlier in this book.
- Turn on the power of both the VCR and TV.
- Set the TV to the VCR Output Channel (CH 3 or 4) or video input.
- **Insert a video cassette with protection tab into your VCR.**

1

Set the desired speed (SP or EP) by pressing **SP/EP**.

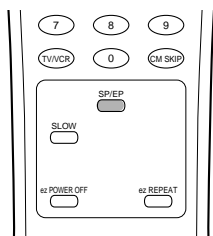

EP provides three times as much recording time as SP, although SP produces better picture and audio sounds.

2

Press **CH (+/-)** or **Number** buttons to select the channel to record.

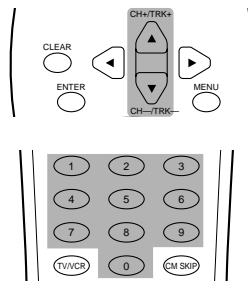

If you want to record the program through the line input, press **CH (+/-)** continuously to display "LINE1" (from AUDIO/VIDEO IN jacks at the rear) or "LINE2" (from AUDIO/VIDEO IN jacks at the front) on the TV screen.

You can also select "LINE1" or "LINE2" by pressing **0** button twice or four times.

3

Press the **REC/ITR** once.

The RECORD and REC indicator appear on the TV screen and display window.

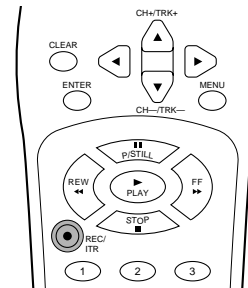

If a cassette with no prevention tab is loaded, the cassette will be ejected automatically. ("NO TAB CASSETTE" message appears)

4

To stop recording.

Press **STOP**.

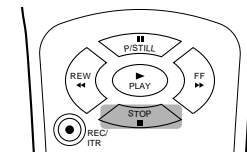

To pause recording.

Press **P/STILL**.

The PAUSE appear on the TV screen. Also REC indicator will flash during pause mode on the display window

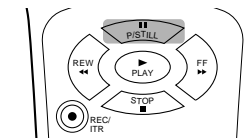

To resume recording, press **P/STILL** again.

How to record Instant Timer Recording

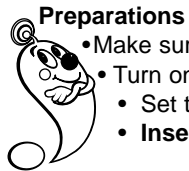

Preparations

- Make sure that you have correctly installed your VCR as described earlier in this book.
- Turn on the power of both the VCR and TV.
- Set the TV to the VCR Output Channel (CH 3 or 4) or video input.
- **Insert a video cassette with protection tab into your VCR.**

1
Set the desired speed (SP or EP) and select the channel to record by following steps **1** to **2** as shown "Normal Recording" on the previous page.

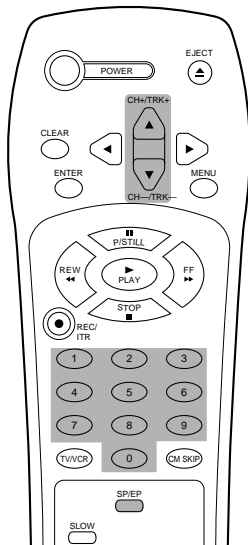

2
Press **REC/ITR** twice.
The ITR information as illustrated, will appear on the TV screen and display window.

Recording will start.

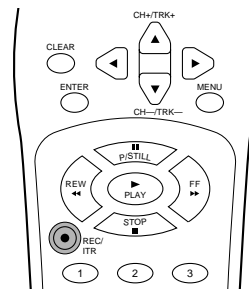

ITR Information

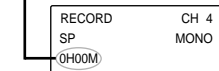

3
Within a few seconds, press **REC/ITR** repeatedly to set the recording duration.

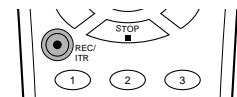

0H00M (Regular recording)
↓
0H30M → 1H00M →.....→ 9H00M
↑

Instant Timer Recording information appears on the TV screen and window display. (TIMER indicator appears also.)

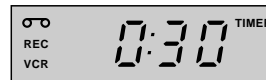
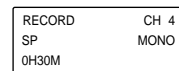

4
To stop, pause, or turn off the power while recording

Press **STOP**, **P/STILL**, or **POWER**.

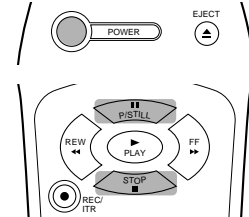

To extend the recording duration while recording

Press **REC/ITR**, until the new duration you want appears.

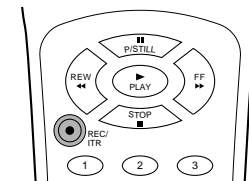

When the recording time indicator in the display window counts down to "0:00", recording stops and VCR turns off.

When the regular recording is resumed by pressing **REC/ITR** repeatedly to display "0H00M", Instant Timer Recording is canceled.

How to record Timer Recording



If you have finished programming and you want to set the VCR to record the programs you have entered.
A) MAKE SURE YOU HAVE INSERTED A TAPE INTO THE VCR. B) YOU MUST TURN OFF THE VCR BEFORE IT WILL RECORD ANY TIMER PROGRAMS. (TIMER indicator appears). The VCR is now set to record the preset programs.

5

Press **▼▲▶** to select and set each of the remaining items at right.

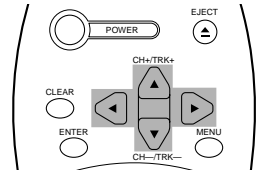

Remaining item to be set:
 START and STOP time
 Recording Speed (SP or EP)

To make corrections
 Repeatedly press **◀** to move the cursor to the left, or **▶** to move to the right to the incorrect entry and make the correction.

CH	DATE	TIME		
▶ 04	JUL 6	6:00	7:30	SP
---	---	---	---	SP
---	---	---	---	SP
---	---	---	---	SP
---	---	---	---	SP
---	---	---	---	SP
---	---	---	---	SP
---	---	---	---	SP

DELETE: **◀ ▶** ENTER MENU

6

Press **MENU**, the program will be memorized at the VCR.

Additional programs may be entered by repeating steps **2** to **5**.

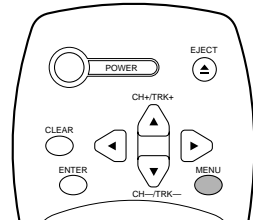

CH	DATE	TIME		
▶ 04	JUL 6	6:00	7:30	SP
---	---	---	---	SP
---	---	---	---	SP
---	---	---	---	SP
---	---	---	---	SP
---	---	---	---	SP
---	---	---	---	SP
---	---	---	---	SP

DELETE: **◀ ▶** ENTER MENU

7

Press **MENU** to exit the menu again.

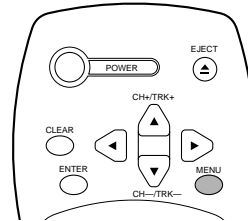

Press **POWER** off to set the timer.

TIMER indicator appears on the display window.

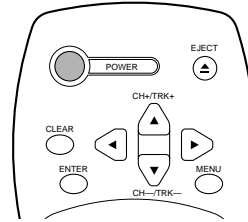

8

Checking (Erasing) the Timer recording

- Select the **REC** item on the main menu with **◀** or **▶**, and then press **ENTER**.
- Press **▼** or **▲** to select a program you want to check or erase.
- Press **◀** or **ENTER** to erase or modify the program.

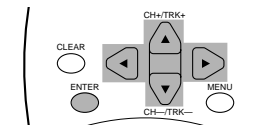

CH	DATE	TIME		
▶ 04	JUL 6	6:00	7:30	SP
---	---	---	---	SP
---	---	---	---	SP
---	---	---	---	SP
---	---	---	---	SP
---	---	---	---	SP
---	---	---	---	SP
---	---	---	---	SP

DELETE: **◀ ▶** ENTER MENU



If the program preset time is past, the **PAST TIME PROGRAMMED** message will appear on the TV screen. Correct the time.

If the incorrect data is entered, the **PLEASE CORRECT THE DATA** message will appear on the TV screen. Correct the data.

Make sure that the preset times of the timer recording events do not overlap. If that do, the earlier program will always be given priority.

How to record Dubbing and Editing

**IMPORTANT
COPYRIGHT
INFORMATION:**
Many television programs and films are copyrighted. In certain circumstances, copyright law may apply to private in-home video taping of copyrighted materials.

22

If you wish to edit or dub your another VCR (or camcorder) recordings to this VCR, the rear (or Front) panel mounted Audio and Video input jacks make the connections quick and easy. The direct A/V jacks will also provide better picture results than using the RF jack on the rear panel.

1

Connect the another VCR's (or camcorder's) Audio/Video outputs to your VCR as illustrated below.

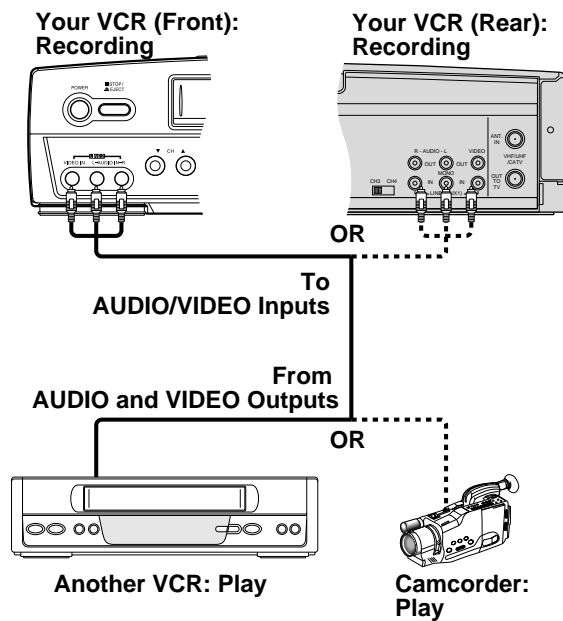

2

Set the input channel "LINE1" or "LINE2".

Press **CH (+/-)** continuously to display "LINE1" (from AUDIO/VIDEO IN jacks at the rear) or "LINE2" (from AUDIO/VIDEO IN jacks at the front) on the TV screen.

You can also select "LINE1" or "LINE2" by pressing the **0** button twice or four times.

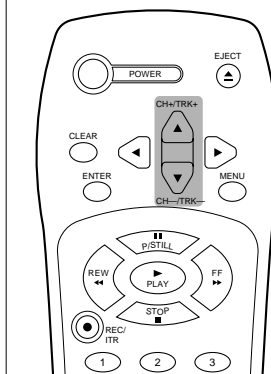

3

Play the tape in the another VCR (or camcorder).

If you have a TV attached to your VCR, you can see the video playing.

Press **REC/ITR** on the recording VCR.

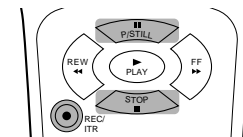

To edit out unwanted parts
Press **P/STILL** on the recording VCR while copying is in progress. Press **P/STILL** again to resume copying.

To stop copying
Press **STOP** on the recording VCR.

Hi-Fi Stereo System

MTS Broadcast

Audio output selection

This VCR is equipped with the VHS Hi-Fi audio sound system for recording and playback. The information below gives a brief description of Hi-Fi audio and how to record and play a tape in the Hi-Fi audio mode.

To enjoy the Hi-Fi stereo system, you connect your VCR's AUDIO(L/R)/VIDEO OUT jacks to the AUDIO(L/R)/VIDEO INPUT jacks on back your TV (or another A/V system) using the A/V cable.

Receivable Broadcast types

The following are possible audio broadcast type and on screen displays.

Press **ENTER** to display the broadcast signal currently being received.

MTS Stereo and SAP broadcast

Multi-channel Television Sound Stereo (main language) and Secondary Audio Program (sub language) broadcasts are being received simultaneously. Select STEREO or SAP broadcast type mode.

STOP CH 4
SP STEREO/SAP

MTS Stereo broadcast

Multi-channel Television Sound Stereo broadcast. Select STEREO. If a stereo broadcast is weak and the display flickers, you may want to select the MONO audio mode for better picture.

STOP CH 4
SP STEREO

SAP broadcast

Secondary Audio Program (sub language) broadcast. Select SAP audio mode for the sub language.

STOP CH 4
SP SAP

MONO broadcast

Normal monaural sound broadcast.

STOP CH 4
SP MONO

1

Audio output selection

Select the  item on the main menu with **◀** or **▶** and then press **ENTER**.

Select a desired audio output mode (STEREO, LEFT, RIGHT, or MONO) with **▲** or **▼** and then press **◀** or **▶**.

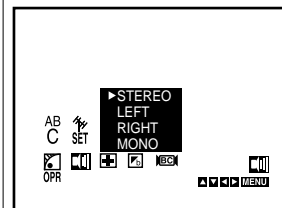
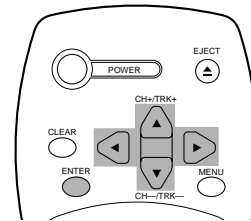

2

STEREO- The left channel sound (L) is heard from the left speaker and the right channel sound (R) is heard from the right speaker.

LEFT- The left channel sound (L) is heard from both speakers.

RIGHT- The right channel sound (R) is heard from both speakers.

MONO- The monaural sound is heard from both speakers (playback mode only).

If audio output selection is selected at STEREO position while playing a prerecorded SAP audio program, the main language (Left) and the sub language (Right) will be heard simultaneously. For SAP BILINGUAL playback do not use STEREO position. Select the RIGHT position.

Hi-Fi Stereo System

Broadcast type selection for recording

SAP Recording

Broadcast type selection for recording: You can select the broadcast audio format (STEREO, SAP or MONO) to use when recording. We recommend using STEREO.

SAP (Secondary Audio Program; sub language) recording: Some stations transmit a Second Audio Program, which is used for a sub language or additional information. When the station broadcasts a Second Audio Program, follow the procedure below to record the SAP.



1

Broadcast type selection for recording

Select the **REC** item on the main menu with **◀** or **▶** and then press **ENTER**.

Select a desired Broadcast type mode (STEREO, SAP, or MONO) with **▲** or **▼** and then press **◀** or **▶**.

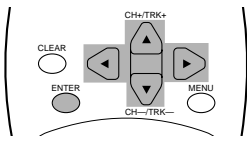
Please refer to the "Receivable Broadcast types" section on the previous page.

2

Do a recording.

Follow "Normal recording" section on the 18 page.

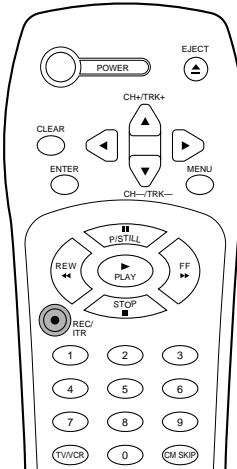

1

SAP (Second Audio Program) recording

Select the **REC** item on the main menu with **◀** or **▶** and then press **ENTER**.

Select Broadcast type to SAP with **▲** or **▼** and then press **◀** or **▶**.

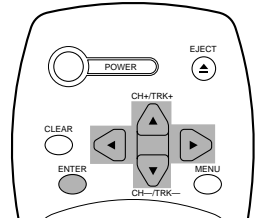
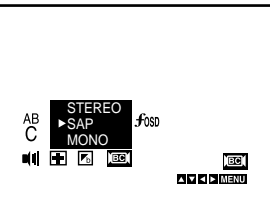
2

Do a recording.

Follow normal recording section on the 18 page.

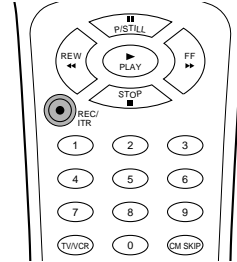

Do the SAP (Second Audio Program) recording if only the SAP appears on the TV screen. Please refer to the "Receivable Broadcast types" section on the previous page.

Real-time counter Counter memory

Real-time counter: Shows length of tape run in hours, minutes, and seconds.



Counter memory: This is useful if there is a section of tape you want to view immediately after recording or if you want to return to the same point several times.

Real-time counter

Press the **ENTER** to select the real-time counter display.

Every press of the **ENTER** changes the TV screen as illustrated below.

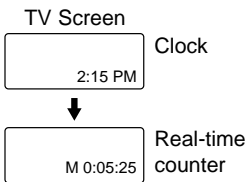
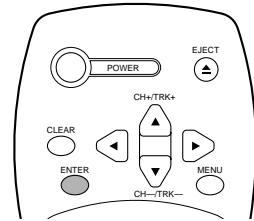

1

Counter memory

Press the **ENTER** repeatedly to display the tape counter on the TV screen.

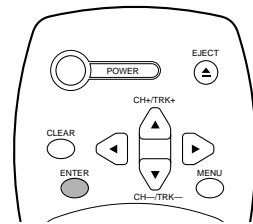

2

Press **CLEAR** at the point you want to locate later.

The tape counter on the TV screen resets to "M 0:00:00".

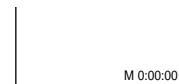
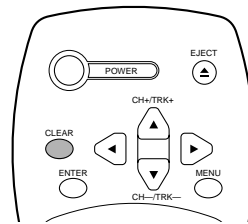

3

After playback or recording, press **STOP**, then **REW**.

The tape automatically stops when the tape counter returns to about "M 0:00:00".

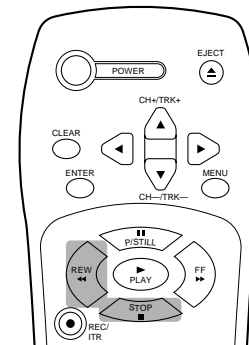

Counter memory does not work during fast-forward and Auto rewind.

When you insert a cassette, the tape counter is reset to "M 0:00:00".

The real-time counter does not operate when nothing is recorded on the tape.

The real-time counter does not work when the tape is not inserted.

Other functions



Video Doctor



Operating Hints



Video Doctor (Advanced Self-Diagnosis); This feature informs you that there is a problem with your VCR. These error messages will appear on the TV screen.

Video Doctor

Select the  item on the main menu with  or , and then press **ENTER**.

Press  or  to select a item to check a problem.

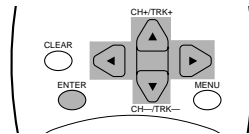

ANTENNA CONNECT– If **PLEASE CHECK!** appears, Connect the VCR to the antenna and TV correctly and securely.

HEAD STATUS– If “PLEASE CLEAN” appears, clean your video heads.

TAPE STATUS– Indicates whether the protection tab of the cassette inside VCR is removed or not. (RECORDABLE, NOT RECORDABLE or NO TAPE IS LOADED)

NO. OF TIMER PROGRAM– Indicates how many timer recording are set.

NEXT TIMER PROGRAM– Indicates setting contents of the next timer recording.

1

Operating hints

- **Auto play system;** If you insert a cassette tape without a prevention tab into the VCR, the tape will begin playing automatically. When the tape is finished, it will rewind and be ejected, and it will turn itself off. Auto play function is not operated when VCR is in Timer Recording mode (The **TIMER** indicator is lighted.)
- In manual recording, Timer recording, Instant Timer Recording, playback, or fast forward modes, the VCR automatically starts rewinding the tape at the end of the tape. The cassette will stop at the beginning of the tape and be ejected, and the VCR will turn itself off.

2

- After you have finished using the VCR, rewind, eject, and remove the cassette. Place the cassette in its protective sleeve to protect it from dust. It is not necessary to rewind the cassette before removing it, but if you do, it will be ready to play or record the next time you use it.
- Be sure the VCR Channel Selector is on the correct channel you wish to record. The channel that is being recorded can always be checked by setting the television on the VCR channel (3 or 4) and pressing **TV/VCR** selector to turn the VCR indicator on.
- Do not attempt to hook up more than one television set to the VCR for either recording or playback.

ez (easy) operation

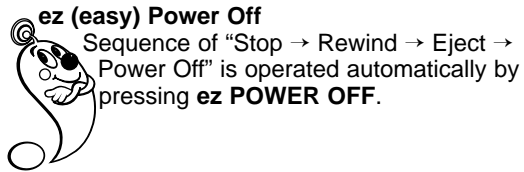

ez (easy) Power Off

Sequence of "Stop → Rewind → Eject → Power Off" is operated automatically by pressing **ez POWER OFF**.

1

During playing back press **ez POWER OFF**.

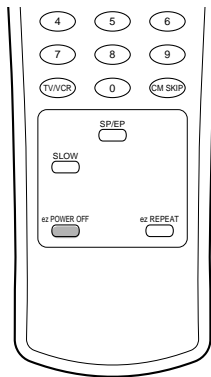

2

Your VCR will be operated as the follow;

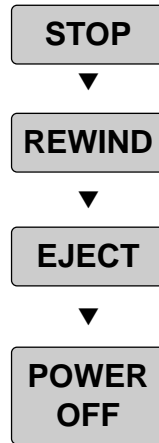

ez (easy) Repeat

By pressing and holding **ez REPEAT** during playing back, the holding section is replayed twice automatically.

1

During playing back, press and hold **ez REPEAT** at the point where repeat play is to be concluded.

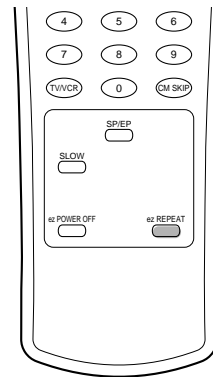

2

Release **ez REPEAT** at the point where repeat play is to start.

The holding section is replayed twice automatically.

Pressing **ez REPEAT** again during repeat play, return to normal play.

Then, your VCR is started reverse search.

Troubleshooting

Check list



MOISTURE CONDENSATION

If you pour a cold liquid into a glass, water vapor in the air will condense on the surface of the glass. This is moisture condensation. Moisture condensation on the head drum, one of the most crucial parts of the unit, will cause damage to the tape.

When the VCR is exposed to a rapid temperature change from cold to warm, some condensation will occur. Under this condition, connect the power cord to the AC line, turn on the VCR and allow at least two hours for the VCR to dry out.

If the unit does not seem to operate properly, read the instructions again, then check the table below.



Video Head Cleaning

Whenever a video cassette is inserted into or ejected from your VCR the video head is automatically cleaned. This should mean that additional head cleaning should not be necessary. However dirt accumulating on the head after a long period of time can cause the playback picture to become blurred or broken up. High quality video cassette tapes will not normally deposit dirt onto the video head, but old or damaged tapes might.

Cassette cannot be inserted.

- Load cassette in direction indicated by arrow on cassette.
- A cassette is already in the VCR.
- Check if display window is lit. If not, make sure power cord is plugged in.
- If the  indicator flashes, press **POWER** again.

No picture appears on TV screen.

- Set the television to the same channel selected on the RF Channel Select Switch. (CH3 or CH4).

The playback picture is noisy.

- Make sure the TV is set to the video channel or video input.
- Adjust the tracking manually when the tape quality is poor.
- Although the unit cleans the video heads automatically, dirt may be accumulated after a long period of use. Clean the video heads with a commercially available video heads cleaning tape.
- Make sure all the connections with the VCR are made correctly and securely.

TV reception is noisy or there is no TV reception.

- Connect the VCR to the antenna and TV correctly and securely.
- Move the VCR away from the TV set.

No picture, but audio is clear.

- The heads may require cleaning.

The VCR will not go into the recording mode, even when REC/ITR is pressed.

- The cassette has had the erase prevention tab removed. Stick a piece of adhesive tape over the erase prevention tab hole or select a different cassette.

No picture appears on television screen during playback.

- Set the television to the VCR channel (3 or 4) depending upon the selected channel on the back of the VCR.
- Try a different cassette tape.

The VCR cannot be remotely controlled or the remote control has short range.

- Weak or dead batteries.
- Do not block sensor.

--:-- appears on the display window.

- Reset time according to instructions. Power has been interrupted.

VCR does not start at preset record starting time.

- Setup recording time according to instructions.
- Be sure the AM-PM display is correct.

The tape is ejected in the timer mode.

- The cassette has had the erase prevention tab removed. Stick a piece of adhesive tape over the erase prevention tab hole or select a different cassette.

indication flashes.

- Insert a cassette.



Designs and specifications are subject to change without notice.
Weight and dimensions shown are approximate.

GENERAL

Head System	Four head helical scan azimuth system
Power Source	AC 100-240V, 50/60Hz
Power Consumption	Approx. 22 Watts
Dimensions (WxHxD)	360 x 98 x 274 mm (14.2" x 3.9" x 10.8")
Operating Temperature	5 °C~35 °C (41 °F~95 °F)
Operating Humidity	Less than 80% RH
Timer	12-hour display type with AM, PM
Weight	Approx. 3.4 kg (7.5 lbs)
Tape Speed	33.35 mm/sec (SP mode) 16.67 mm/sec (LP mode) 11.12 mm/sec (EP mode)
Tape Width	12.7 mm
Maximum Recording Time	2 HOURS (T-120, SP mode) 6 HOURS (T-120, EP mode) 8 HOURS (T-160, EP mode)
Rewind Time	About 60 seconds (T-120)

TUNER

Antenna	75 ohms (UHF), 75 ohms (VHF)
VHF Output Signal	Channel 3 or 4 (Switchable)
Channel Coverage	VHF; 2-13 UHF; 14-69 CATV; 4A, A~W, W+1~W+84, A-5~A-1

VIDEO

Video Signal System	EIA Standard (525 lines, 60 fields) NTSC type color signal
Input	1.0 Vp-p 75 ohms unbalanced
Output	1.0 Vp-p 75 ohms unbalanced
Signal to Noise Ratio	More than 43 dB (SP mode)

AUDIO

FM audio	
Frequency Range	20Hz to 20kHz
Dynamic Range	More than 83 dB
Channel Separation	More than 55 dB
Conventional audio	
Input	-6.0 dBm more than 47 kohms (LINE)
Output	-6.0 dBm less than 1.5 kohms (LINE)
S/N Ratio	More than 43 dB (SP mode)
Frequency Range	200 Hz to 10kHz (SP mode)

Supplied Accessories

- Coaxial Cable (1)
- Audio Cable (1)
- Video Cable (1)
- Remote control (1)

Specifications



P/NO :