

Installation and Operating Guide | Warranty

Model Number | XBV243 | DVD Player + Video Cassette Recorder



Safety Precautions



WARNING
RISK OF ELECTRIC SHOCK
DO NOT OPEN



WARNING: TO REDUCE THE RISK OF ELECTRIC SHOCK DO NOT REMOVE COVER (OR BACK) NO USER-SERVICEABLE PARTS INSIDE REFER SERVICING TO QUALIFIED SERVICE PERSONNEL.



This lightning flash with arrowhead symbol within an equilateral triangle is intended to alert the user to the presence of uninsulated dangerous voltage within the product's enclosure that may be of sufficient magnitude to constitute a risk of electric shock to persons.



The exclamation point within an equilateral triangle is intended to alert the user to the presence of important operating and maintenance (servicing) instructions in the literature accompanying the product.

WARNING: TO REDUCE THE RISK OF FIRE OR ELECTRIC SHOCK, DO NOT EXPOSE THIS PRODUCT TO RAIN OR MOISTURE.

CAUTION: TO PREVENT ELECTRIC SHOCK, MATCH WIDE BLADE OF PLUG TO WIDE SLOT, FULLY INSERT.

ATTENTION: POUR ÉVITER LES CHOC ÉLECTRIQUES, INTRODUIRE LA LAME LA PLUS LARGE DE LA FICHE DANS LA BORNE CORRESPONDANTE DE LA PRISE ET POUSSER JUSQU'AU FOND.

NOTE TO CABLE/TV INSTALLER: This reminder is provided to call the cable TV system installer's attention to Article 820-40 of the National Electric Code (U.S.A.). The code provides guidelines for proper grounding and, in particular, specifies that the cable ground shall be connected to the grounding system of the building, as close to the point of the cable entry as practical.

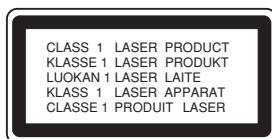

CAUTION:

This DVD+VCR employs a Laser System.

To ensure proper use of this product, please read this owner's manual carefully and retain for future reference, should the unit require maintenance, contact an authorized service location—see service procedure.

Use of controls, adjustments or the performance of procedures other than those specified herein may result in hazardous radiation exposure.

To prevent direct exposure to laser beam, do not try to open the enclosure. Visible laser radiation when open. **DO NOT STARE INTO BEAM.**

CAUTION: The apparatus shall not be exposed to water, dripping or splashing and that no objects filled with liquids, such as vases, shall be placed on the apparatus.

FCC WARNING: This equipment may generate or use radio frequency energy. Changes or modifications to this equipment may cause harmful interference unless the modifications are expressly approved in the instruction manual. The user could lose the authority to operate this equipment if an unauthorized change or modification is made.

REGULATORY INFORMATION: FCC Part 15

This product has been tested and found to comply with the limits for a Class B digital device, pursuant to Part 15 of the FCC Rules. These limits are designed to provide reasonable protection against harmful interference when the product is operated in a residential installation. This product generates, uses and can radiate radio frequency energy and, if not installed and used in accordance with the instruction manual, may cause harmful interference to radio communications. However, there is no guarantee that interference will not occur in a particular installation. If this product does cause harmful interference to radio or television reception, which can be determined by turning the product off and on, the user is encouraged to try to correct the interference by one or more of the following measures:

- Reorient or relocate the receiving antenna.
- Increase the separation between the product and receiver.
- Connect the product into an outlet on a circuit different from that to which the receiver is connected.
- Consult the dealer or an experienced radio/TV technician for help.

FCC COMPLIANCE: The responsible party for this product's compliance is:

Zenith Electronics Corporation, 2000 Millbrook Drive,
Lincolnshire, IL 60069, USA.
Phone: 1-847-391-7000



Notes on copyrights:

It is forbidden by law to copy, broadcast, show, broadcast via cable, play in public, or rent copyright material without permission.

This product features the copy protection function developed by Macrovision. Copy protection signals are recorded on some discs. When recording and playing the pictures of these discs on a VCR, the picture noise will appear.

This product incorporates copyright protection technology that is protected by method claims of certain U.S. patents and other intellectual property rights owned by Macrovision Corporation and other rights owners. Use of this copyright protection technology must be authorized by Macrovision Corporation, and is intended for home and other limited viewing uses only unless otherwise authorized by Macrovision Corporation. Reverse engineering or disassembly is prohibited.

SERIAL NUMBER: The serial number is found on the back of this unit. This number is unique to this unit and not available to others. You should record requested information here and retain this guide as a permanent record of your purchase.

Model No. _____

Serial No. _____

IMPORTANT SAFETY INSTRUCTIONS

CAUTION: PLEASE READ AND OBSERVE ALL WARNINGS AND INSTRUCTIONS IN THIS OWNER'S MANUAL AND THOSE MARKED ON THE UNIT. RETAIN THIS BOOKLET FOR FUTURE REFERENCE.

This set has been designed and manufactured to assure personal safety. Improper use can result in electric shock or fire hazard. The safeguards incorporated in this unit will protect you if you observe the following procedures for installation, use and servicing.

This unit is fully transistorized and does not contain any parts that can be repaired by the user.

DO NOT REMOVE THE CABINET COVER, OR YOU MAY BE EXPOSED TO DANGEROUS VOLTAGE. REFER SERVICING TO QUALIFIED SERVICE PERSONNEL ONLY.

1. Read owner's manual

After unpacking this product, read the owner's manual carefully, and follow all the operating and other instructions.

2. Power Sources

This product should be operated only from the type of power source indicated on the marking label. If you are not sure of the type of power supply in your home, consult your product dealer or local power company. For products intended to operate from battery power, or other sources, refer to the operating instructions.

3. Grounding or Polarization

This product is equipped with a polarized alternating current line plug (a plug having one blade wider than the other). This plug will fit into the power outlet only one way. This is a safety feature. If you are unable to insert the plug fully into the outlet, try reversing the plug. If the plug should still fail to fit, contact your electrician to replace your obsolete outlet. Do not defeat the safety purpose of the polarized plug.

4. Ventilation

Slots and openings in the cabinet are provided for ventilation and to ensure reliable operation of the product and to protect it from overheating. These openings must not be blocked or covered. The openings should never be blocked by placing the product on a bed, sofa, rug or other similar surface. This product should not be placed in a built-in installation such as a bookcase or rack unless proper ventilation is provided or the manufacturer's instructions have been adhered to.

5. Heat

The product should be situated away from heat sources such as radiators, heat registers, stoves, or other products (including amplifiers) that produce heat.

6. Water and Moisture

Do not use this product near water. For example: Near a bath tub, wash bowl, kitchen sink, laundry tub, in a wet basement; or near swimming pools and the like.

7. Cleaning

Unplug this product from the wall outlet before cleaning. Do not use liquid cleaners or aerosol cleaners. Use a damp cloth for cleaning.

8. Power-Cord Protection

Power-supply cords should be routed so that they are not likely to be walked on or pinched by items placed upon or against them, paying particular attention to cords at plugs, convenience receptacles, and the point where they exit from the product.

9. Overloading

Do not overload wall outlets, extension cords, or integral convenience receptacles as this can result in a risk of fire or electric shock.

10. Outdoor Antenna Grounding

If an outside antenna or cable system is connected to the product, be sure the antenna or cable system is grounded so as to provide some protection against voltage surges and built-up static charges. Article 810 of the National Electrical Code (U.S.A), ANSI/NFPA 70 provides information with regard to proper grounding of the mast and supporting structure, grounding of the lead-in wire to an antenna discharge unit, size of grounding conductors, location of antenna-discharge unit, connection to grounding electrodes, and requirements for the grounding electrode.

EXAMPLE OF GROUNDING ACCORDING TO NATIONAL ELECTRICAL CODE INSTRUCTIONS

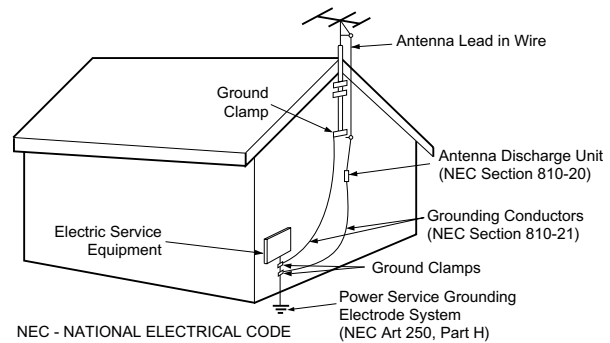

11. Lightning

For added protection of this product during storms, or when it is left unattended and unused for long periods of time, unplug it from the wall outlet.

This will prevent damage to the product due to lightning and power-line surges.

12. Power Lines

An outside antenna system should not be located in the vicinity of overhead power lines or other electric light or power circuits, or where it can fall into such power lines or circuits. When installing an outside antenna system, extreme care should be taken to keep from touching such power lines or circuits as contact with them might be fatal.

13. Object and Liquid Entry

Never push objects of any kind into this product through openings as they may touch dangerous voltage points or short-out parts that could result in a fire or electric shock. Never spill liquid of any kind on the product.

14. Attachments

Do not use attachments not recommended by the product manufacturer as they may cause hazards.

IMPORTANT SAFETY INSTRUCTIONS (Cont'd)

15. Accessories

Do not place this product on an unstable cart, stand, tripod, bracket, or table. The product may fall, causing serious injury to a child or adult, and serious damage to the product. Use only with a cart, stand, tripod, bracket, or table recommended by the manufacturer, or sold with the product. Any mounting of the product should follow the manufacturer's instructions, and should use a mounting accessory recommended by the manufacturer. A product and cart combination should be moved with care. Quick stops, excessive force, and uneven surfaces may cause the product and cart combination to overturn.



16. Disc Tray

Keep your fingers well clear of the disc tray as it is closing. It may cause serious personal injury.

17. Burden

Do not place a heavy object on or step on the product. The object may fall, causing serious personal injury and serious damage to the product.

18. Connecting

When you connect the product to other equipment, turn off the power and unplug all of the equipment from the wall outlet. Failure to do so may cause an electric shock and serious personal injury. Read the owner's manual of the other equipment carefully and follow the instructions when making any connections.

19. Sound Volume

Reduce the volume to the minimum level before you turn on the product. Otherwise, sudden high volume sound may cause hearing or speaker damage.

20. Sound Distortion

Do not allow the product to output distorted sound for a longtime. It may cause speaker overheating and fire.

21. Earphone

When you use the earphone, keep the volume at a moderate level. If you use the earphone continuously with high volume sound, it may cause hearing damage.

22. Laser Beam

Do not look into the opening of the disc tray or ventilation opening of the product to see the source of the laser beam. It may cause sight damage.

23. Disc

Do not use a cracked, deformed, or repaired disc. These discs are easily broken and may cause serious personal injury and product malfunction.

24. Damage Requiring Service

Unplug this product from the wall outlet and refer servicing to qualified service personnel under the following conditions:

- a) When the power-supply cord or plug is damaged.
- b) If liquid has been spilled, or objects have fallen into the product.
- c) If the product has been exposed to rain or water.
- d) If the product does not operate normally by following the operating instructions. Adjust only those controls that are covered by the operating instructions as an improper adjustment of other controls may result in damage and will often require extensive work by a qualified technician to restore the product to its normal operation.
- e) If the product has been dropped or damaged in any way.
- f) When the product exhibits a distinct change in performance—this indicates a need for service.

25. Servicing

Do not attempt to service this product yourself as opening or removing covers may expose you to dangerous voltage or other hazards. Refer all servicing to qualified service personnel.

26. Replacement parts

When replacement parts are required, be sure the service technician has used replacement parts specified by the manufacturer or have the same characteristics as the original part. Unauthorized substitutions may result in fire, electric shock, or other hazards.

27. Safety Check

Upon completion of any service or repairs to this product, ask the service technician to perform safety checks to determine that the product is in proper operating condition.

Table of Contents

Introduction

Safety Precautions	2
IMPORTANT SAFETY INSTRUCTIONS	3-4
Table of Contents	5
Before Use	6-7
Playable Discs	6
Precautions	7
Notes on Discs	7
About Symbols	7
Front Panel	8
Display Window	9
Remote Control	10
Rear Panel	11

Preparation

Connections	12-14
Connecting antenna/cable TV to a DVD+VCR ..	12
Basic connecting to a TV	13
Optional connecting to a TV	13
Connecting to Optional Equipment	14
Before Operation - VCR Part	15-17
On-Screen Display	15
Setting the On-Screen Display	15
Setting the VCR Setup Menu	16
Channel Selection	16
Setting the Clock	17
Before Operation - DVD Part	18-21
General Explanation	18
On-Screen Display	18
Initial Settings	19-21
• <i>Initial Settings General Operation</i>	19
• <i>Language</i>	19
• <i>Picture</i>	19
• <i>Sound</i>	20
• <i>Others (DRC/Vocal)</i>	20
• <i>Parental Control</i>	21

Operation



Operation with tape	22-27
Normal Playback	22
Special Effects Playback	22
• <i>Search</i>	22
• <i>Still Picture and Frame-by-Frame Playback</i> ..	22
• <i>Slow Motion</i>	22
• <i>CM Skip</i>	22
Normal Recording	23
Timer Recording	23-24
Instant Timer Recording	25
Dubbing and Editing	25
Copying from DVD to VCR	25
MTS Hi-Fi Stereo System/MTS Broadcast	26
Tape Counter Memory Feature	27
Additional Information	27

Operation with DVD and Audio CD	28
Playing a DVD and Audio CD	28
General Features	28
• <i>Moving to another TITLE</i>	28
• <i>Moving to another CHAPTER/TRACK</i>	28
• <i>Slow Motion</i>	28
• <i>Still Picture and Frame-by-Frame Playback</i> ..	29
• <i>Search</i>	29
• <i>Random</i>	29
• <i>Repeat</i>	29
• <i>Repeat A-B</i>	29
• <i>3D Surround</i>	29
Special DVD Features	30
• <i>Time Search</i>	30
• <i>Zoom</i>	30
• <i>Marker Search</i>	30
• <i>Title Menu</i>	31
• <i>Disc Menu</i>	31
• <i>Camera Angle</i>	31
• <i>Changing the Audio Language</i>	31
• <i>Subtitle</i>	31
Operation with MP3 Disc	32
Notes on MP3 Discs	32
Playing an MP3 Disc	32
Programmed Playback with MP3 Disc	33

Reference

Troubleshooting	34-35
Language Code List	36
Specification	37



About the symbols for instructions

-  Indicates hazards likely to cause harm to the unit itself or other material damage.
-  Indicates special operating features of this unit.
-  Indicates tips and hints for making the task easier.



Before Use

Playable Discs

	DVD (8 cm / 12 cm disc)
	Audio CD (8 cm / 12 cm disc)

In addition, this unit can play a CD-R or CD-RW that contains audio titles or MP3 files.

Notes

- Depending on the conditions of the recording equipment or the CD-R/RW disc itself, some CD-R/RW discs cannot be played on the unit.
- The unit cannot play the CD-R/RW discs that contain no data, or contain different kinds of formatted data other than MP3 and CD-DA data.
- Do not attach any seal or label to either side (the labeled side or the recorded side) of a disc.
- Do not use irregular shaped CDs (e.g., heart-shaped or octagonal). It may result in malfunctions.

Notes on DVDs

Some playback operations of DVDs may be intentionally fixed by software manufacturers. As this unit plays DVDs according to disc content designed by the software manufacturer, some playback features of the unit may not be available, or other functions may be added. Refer also to the instructions supplied with the DVDs. Some DVDs made for business purposes may not be played on the unit.

Regional code of the DVD+VCR and DVDs

This DVD+VCR is designed and manufactured for playback of region “1” encoded DVD software. The region code on the labels of some DVD discs indicates which type of DVD+VCR can play those discs. This unit can play only DVD discs labeled “1” or “ALL”. If you try to play any other discs, the message “Check Regional Code” will appear on the TV screen. Some DVD discs may not have a region code label even though their playback is prohibited by area limits.



Note on DTS-encoded CDs

When playing DTS-encoded CDs, excessive noise may be exhibited from the analog stereo output. To avoid possible damage to the audio system, turn down the volume before playing back such discs, adjust the volume gradually, and keep the volume level low. To enjoy DTS Digital Surround™ playback, an external 5.1 channel DTS Digital Surround™ decoder system must be connected to the digital output of the unit.

Disc-related terms

Title (DVD only)

The main film content or accompanying feature content or additional feature content, or music album.

Each title is assigned a title reference number enabling you to locate it easily.

Chapter (DVD only)

Sections of a picture or a musical piece that are smaller than titles.

A title is composed of one or several chapters. Each chapter is assigned a chapter number, enabling you to locate the chapter you want. Depending on the disc, no chapters may be recorded.

Track (audio CD only)

Sections of a picture or a musical piece on an audio CD. Each track is assigned a track number, enabling you to locate the track you want.

Remote control battery installation

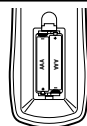

Detach the battery cover on the rear of the remote control, and insert two R03 (size AAA) batteries with \oplus and \ominus aligned correctly.

Caution

Do not mix old and new batteries. Never mix different types of batteries (standard, alkaline, etc.).

Remote Control Operation Range

Point the remote control at the remote sensor and press the buttons.

- **Distance:** About 23 ft (7 m) from the front of the remote sensor
- **Angle:** About 30° in each direction of the front of the remote sensor

Before Use (Cont'd)

Precautions

Handling the unit

When shipping the unit

The original shipping carton and packing materials come in handy. For maximum protection, re-pack the unit as it was originally packed at the factory.

When setting the unit

The picture and sound of a nearby TV, VCR, or radio may be distorted during playback. In this case, position the unit away from the TV, VCR, or radio, or turn off the unit after removing the disc.

To keep the surface clean

Do not use volatile liquids, such as insecticide spray, near the unit. Do not leave rubber or plastic products in contact with the unit for a long period of time. They will leave marks on the surface.

Cleaning the unit

To clean the cabinet

Use a soft, dry cloth. If the surfaces are extremely dirty, use a soft cloth lightly moistened with a mild detergent solution. Do not use strong solvents, such as alcohol, benzene, or thinner, as these might damage the surface of the unit.

To obtain a clear picture

The DVD+VCR is a high-tech, precision device. If the optical pick-up lens and disc drive parts are dirty or worn down, the picture quality will be poor. Regular inspection and maintenance are recommended after every 1,000 hours of use. (This depends on the operating environment.)
For details, please contact your nearest dealer.

Notes on Discs

Handling discs

Do not touch the playback side of the disc.
Hold the disc by the edges so that fingerprints will not get on the surface.
Do not stick paper or tape on the disc.

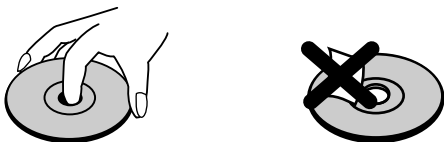

Storing discs

After playing, store the disc in its case. Do not expose the disc to direct sunlight or sources of heat, or leave it in a parked car exposed to direct sunlight, as there may be a considerable temperature increase inside the car.

Cleaning discs

Fingerprints and dust on the disc can cause poor picture quality and sound distortion. Before playing, clean the disc with a clean cloth. Wipe the disc from the center out.

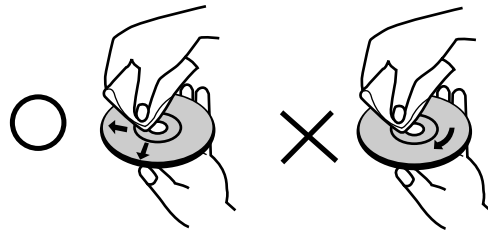

Do not use strong solvents such as alcohol, benzene, thinner, commercially available cleaners, or anti-static spray intended for older vinyl records.

About Symbols

About the symbol display

“” may appear on the TV screen during operation. This icon means the function explained in this owner’s manual is not available on that specific DVD video disc.

About the disc symbols for instructions

A section whose title has one of the following symbol is applicable only to the disc represented by the symbol.

- DVD
- Audio CDs.
- MP3 disc.

Manufactured under license from Dolby Laboratories. “Dolby”, “Pro Logic”, and the double-D symbol are trademarks of Dolby Laboratories. Confidential unpublished works. Copyright 1992-1997 Dolby Laboratories. All rights reserved.

“DTS” and “DTS Digital Out” are trademarks of Digital Theater Systems, Inc.

Front Panel

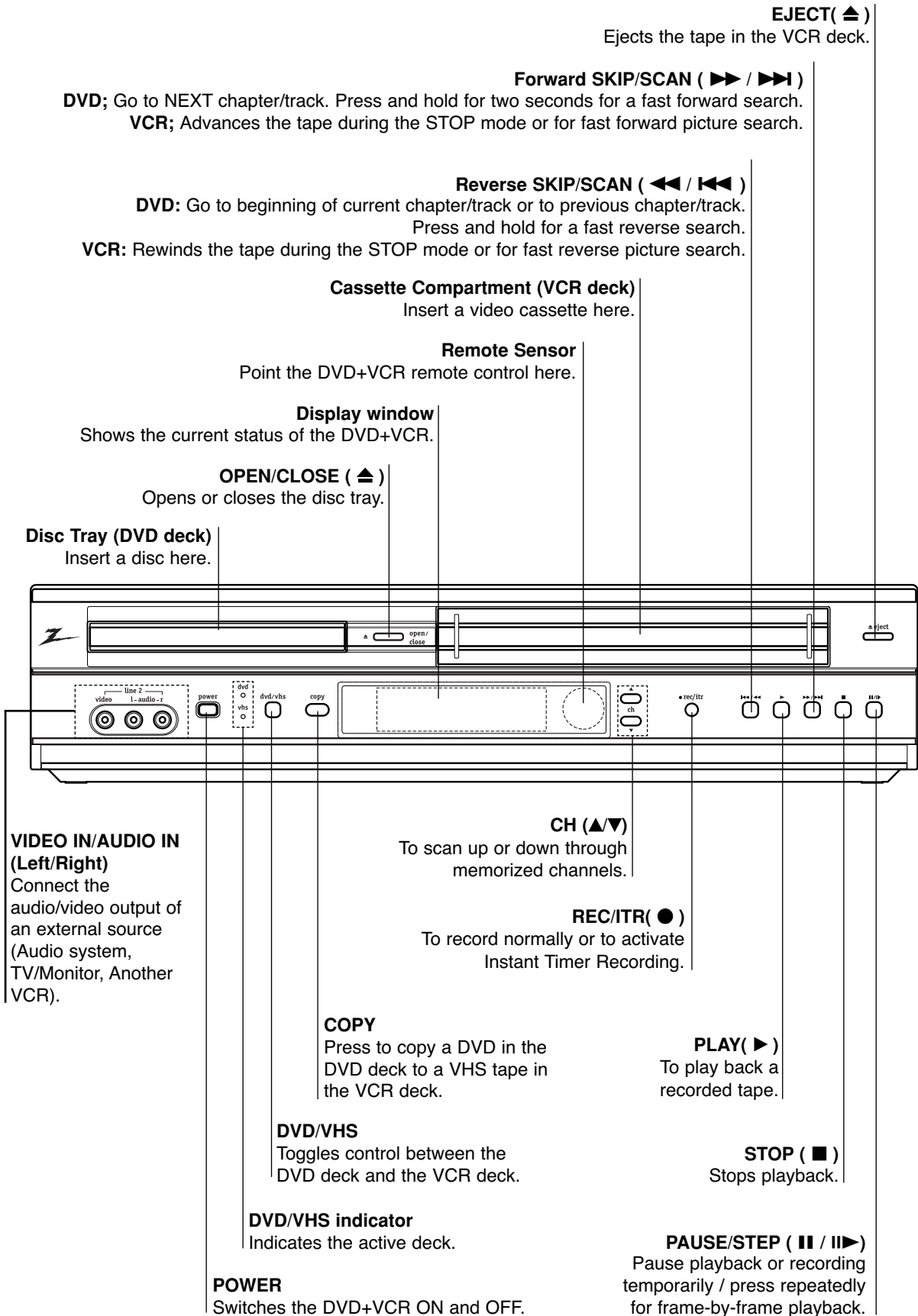

Display Window

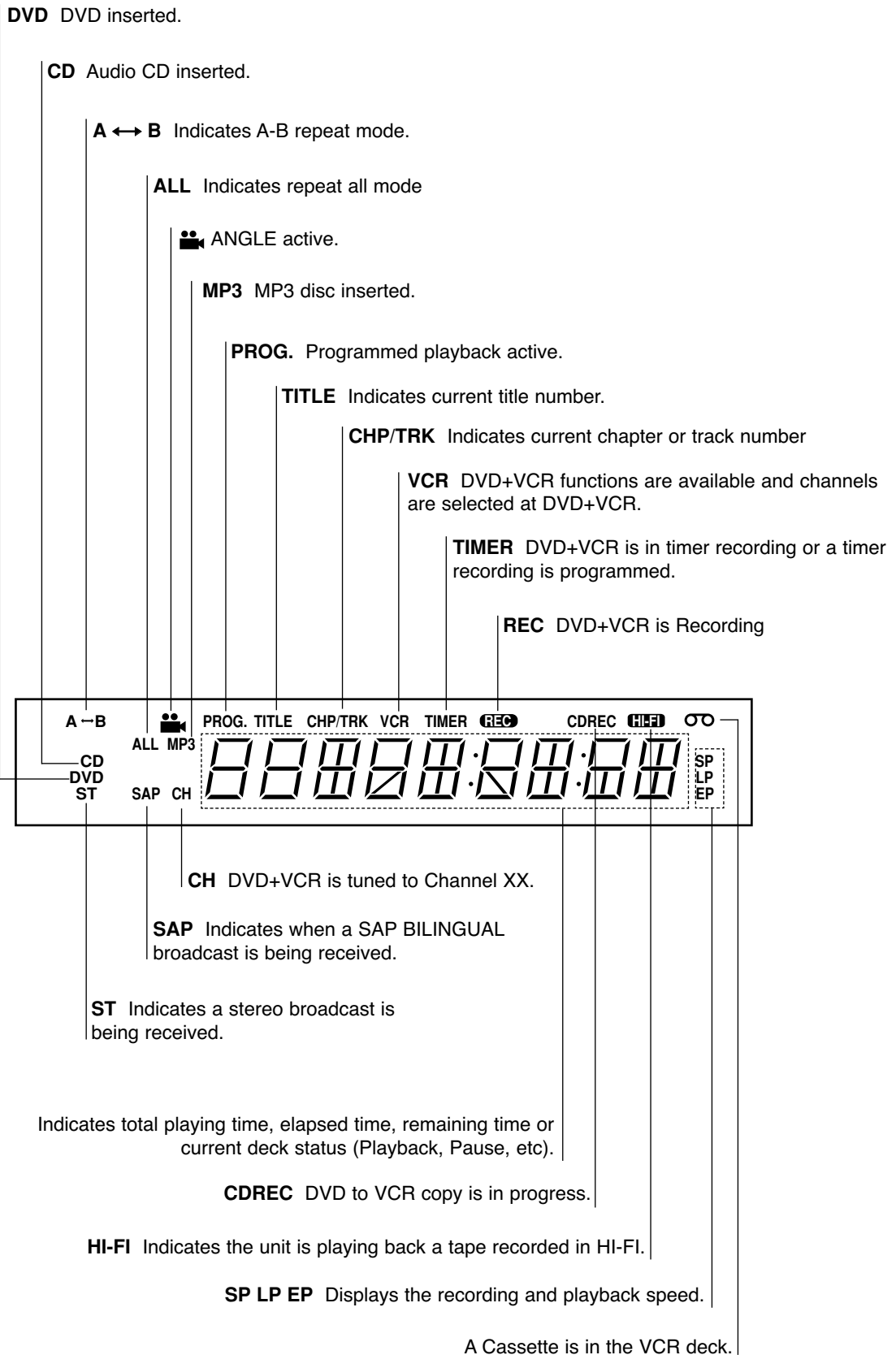

Remote Control

- DVD/VHS select button**
Selects operational mode of remote control.
- POWER**
Switches DVD+VCR ON and OFF.
- TV/VCR**
To view channels selected by the VCR tuner or by the TV tuner.
- DISPLAY, CLK/CNT**
Accesses on-screen display.
Switches among the clock, tape counter and tape remaining modes on the display.
- ◀ ▶ ▲ ▼ (left/right/up/down)**
- Selects an item in the menu
- Selects channel of VCR.
- Adjusts manually the tape's picture onscreen.
- SETUP/MENU**
Accesses or removes DVD setup menu and VCR menu.
- TITLE ●**
Displays the Title menu of the disc if available.
- PAUSE/STEP (||) ●**
Pause playback or recording temporarily / press repeatedly for frame-by-frame playback.
- STOP (■) ●**
Stops playback.
- REC/ITR (●) ●**
Records normally or activates Instant Timer Recording.
- 0-9 numerical buttons**
Selects numbered items in a menu.
- AUDIO ●**
Selects an audio language (DVD) or an audio channel (CD).
- SUBTITLE ●**
Selects a subtitle language.
- MARKER ●**
Marks any point during playback.
- SEARCH ●**
Displays MARKER SEARCH menu.
- REPEAT ●**
Repeat chapter, track, title, all.
- RANDOM, CM SKIP ●**
- Plays tracks in random order.
- Fast forwards picture search through 30 seconds of recording.
- A-B, SP/EP ●**
- Repeats sequence.
- Selects recording speed

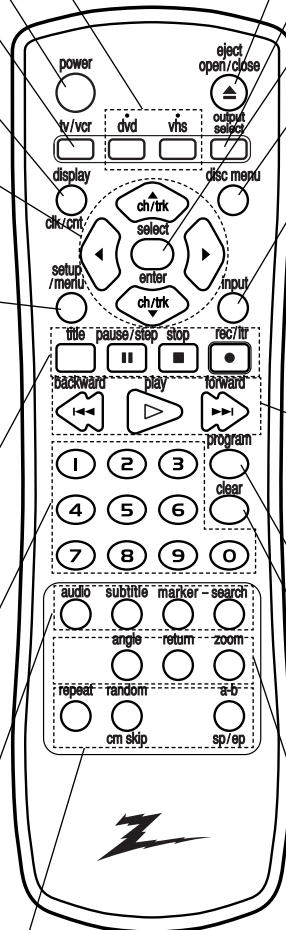

- EJECT, OPEN/CLOSE**
- Opens and closes the disc tray.
- Ejects the tape in the VCR deck.
- OUTPUT SELECT**
Select one of your output sources to view on the TV screen.
- SELECT/ENTER**
Acknowledges menu selection.
- DISC MENU**
Accesses menu on a DVD disc.
- INPUT**
To select the VCR deck's source (Tuner, LINE 1, or LINE 2).
 - **FORWARD (▶▶▶)**
DVD; Search forward* / go to next chapter or track.
VCR; Advances the tape during the STOP mode or for fast forward picture search.
 - **PLAY (▶)**
Starts playback.
 - **BACKWARD (◀◀◀)**
DVD; Search backward* / go to beginning of current chapter or track or go to previous chapter or track.
VCR; Rewinds the tape during the STOP mode or for fast reverse picture search.
- * Press and hold button for about two seconds.
- PROGRAM**
Accesses or removes Program menu.
- CLEAR**
Removes a track number on the program menu or a mark on the MARKER SEARCH menu.
- **ANGLE**
Selects a DVD camera angle if available.
- **RETURN**
Removes the setup menu.
- **ZOOM**
Enlarges video image.

Rear Panel

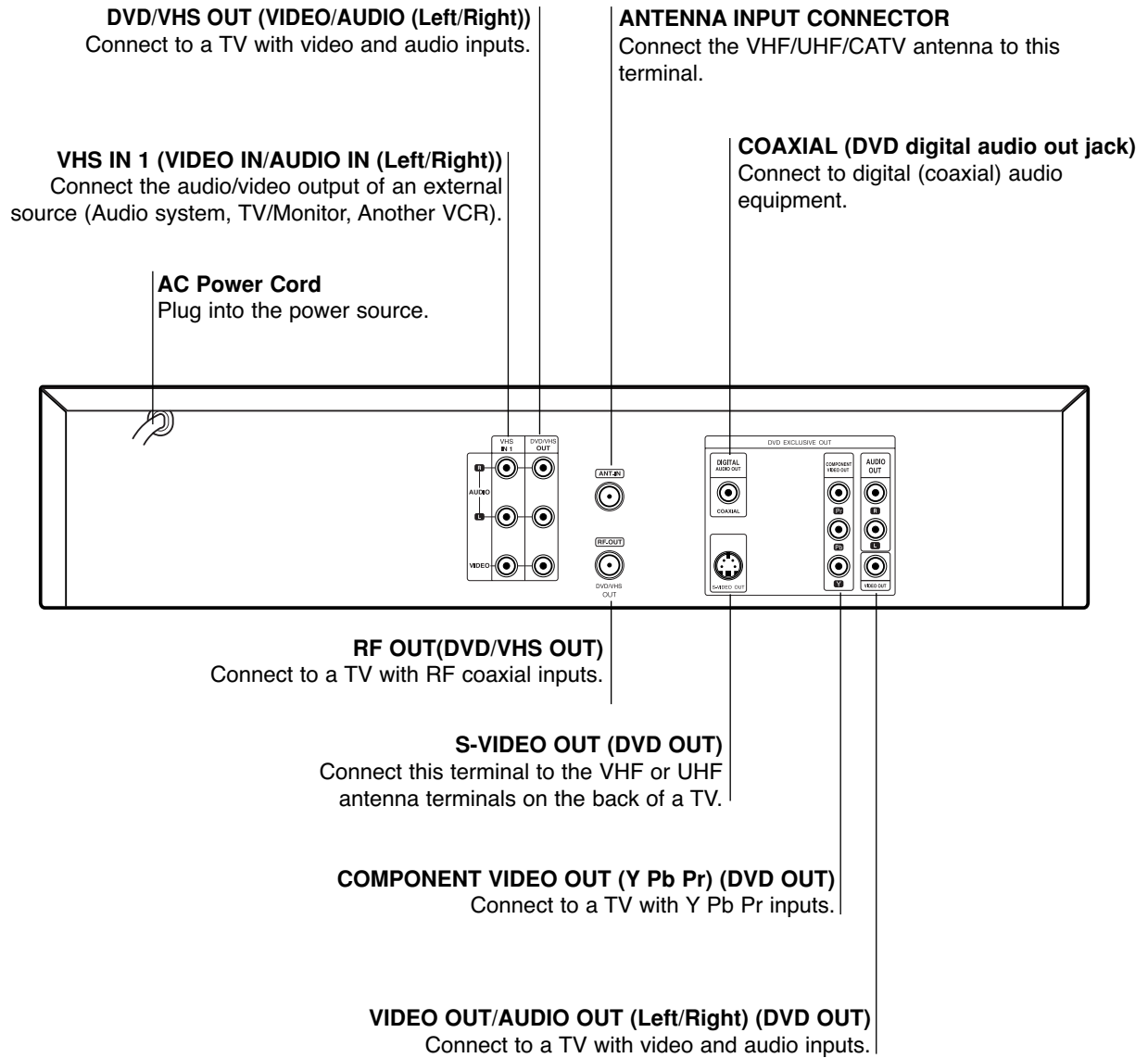

INTRODUCTION



Do not touch the inner pins of the jacks on the rear panel. Electrostatic discharge may cause permanent damage to the unit.

Connections

Tips

- Depending on your TV and other equipment you wish to connect, there are various ways you could connect the DVD+VCR. Use only one of the connections described below.
- Please refer to the manuals of your TV, VCR, Stereo System or other devices as necessary to make the best connections.
- For better sound reproduction, connect the DVD+VCR's DVD/VHS AUDIO OUT jack to the audio in jacks of your amplifier, receiver, stereo or audio/ video equipment. See "Connecting to optional equipment" on page 14.

Caution

- Make sure the DVD+VCR is connected directly to the TV. Tune the TV to the correct video input channel.
- Do not connect the DVD+VCR's DVD/VHS AUDIO OUT jack to the phono in jack (record deck) of your audio system.
- Do not connect your DVD+VCR via your VCR. The DVD image could be distorted by the copy protection system.

Connecting antenna/cable TV to DVD+VCR

- 1 Disconnect the antenna leads from the rear of the TV.
- 2 Identify the type of cable from your antenna. If it is a round cable as illustrated, it is a 75 ohm coaxial antenna cable. This cable will connect directly to the connector marked ANT.IN on your DVD+VCR.

Tips

- If your antenna lead wire is a flat type antenna cable, connect it to a Antenna Adaptor (300-ohm to 75-ohm) (not supplied) and slip the Adaptor onto the ANT.IN connector. The Adaptor does not screw on to the DVD+VCR, it just slips over the connector.

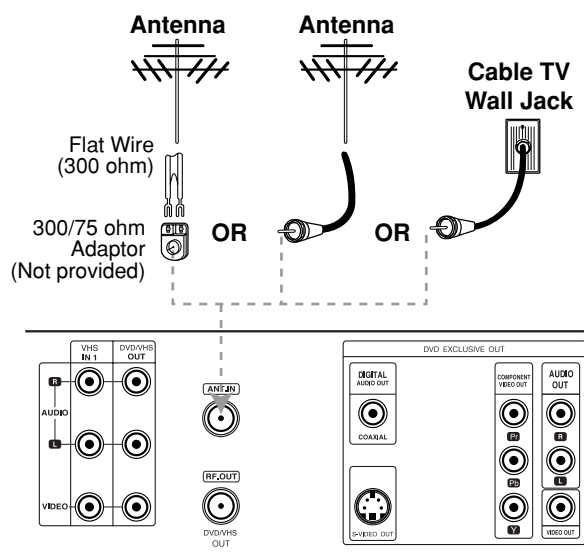

Without Cable Box

If your cable wire is connected to your TV without a converter or descrambler box, unscrew the wire from your TV and attach it to the ANT.IN connector on the VCR. Use the supplied round coaxial cable to connect between the VCR's VHF/UHF/CATV connector and the 75 ohm antenna input connector on the TV. With this connection, you can receive all midband, super band, and hyperband channels.

With Cable Box

If a converter is required in your cable system, follow the instruction below:

The cable hookup permits both TV and VCR operation.

To view or record CATV channel

- 1 Set the TV channel to the video output channel as located on the back of the DVD+VCR (CH3 or CH4).
- 2 Set the VCR channel selector to the output channel of the Cable Converter box by pressing the **CH/TRACK** (▲/▼) or number (0-9) of your VCR. (Example: CH3)
- 3 Select the channel to view at the Cable Converter Box.

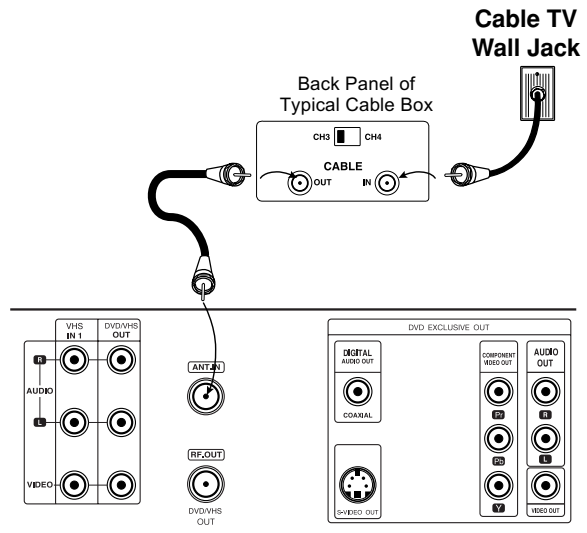

Notes

- With this connection, you CANNOT record one program while viewing another.
- Channel memory programming is not needed when using the connection..

Connections (Cont'd)

Basic connecting to a TV

- Make one of the following connections, depending on the capabilities of your existing equipment.

RF coaxial connection

Connect the RF.OUT jack on the DVD+VCR to the antenna in jack on the TV using the 75-ohm Coaxial Cable supplied (R).

If you use this connection, tune the TV to the DVD+VCR's RF output channel (CH 3 or 4).

How to set the DVD+VCR's RF output channel

When the VCR is turned off, press and hold CH (▲ or ▼) on the front panel for about five seconds and toggles RF output channel between CH 03 and CH 04. The "RF 03" or "RF 04" is displayed in the display window.

Audio/Video connection

- 1 Connect the DVD/VHS VIDEO OUT jack on the DVD+VCR to the video in jack on the TV using the video cable supplied (V).
- 2 Connect the Left and Right DVD/VHS AUDIO OUT jacks of the DVD+VCR to the audio left/right in jacks on the TV (A1) using the supplied audio cables.

If you use this connection, set the TV's source selector to VIDEO.

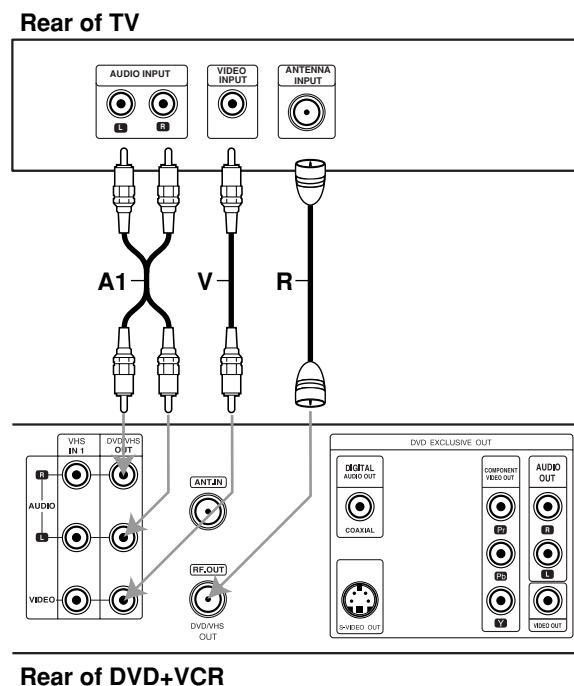

Optional connecting to a TV

Notes

- You can ONLY watch and listen the DVD playback through below connections.
- For using S-VIDEO OUT or COMPONENT VIDEO OUT jack, set the TV Oupt Select mode on the SETUP menu to corresponding mode. See page 19.

Audio/Video connection

- 1 Connect the VIDEO OUT jack on the DVD+VCR to the video in jack on the TV using the video cable supplied (V).
- 2 Connect the Left and Right AUDIO OUT jacks of the DVD+VCR to the audio left/right in jacks on the TV (A2) using the supplied audio cables.

S-Video connection

- 1 Connect the S-VIDEO OUT jack on the DVD+VCR to the S-Video in jack on the TV using the supplied S-Video cable (S).
- 2 Connect the Left and Right AUDIO OUT jacks of the DVD+VCR to the audio left/right in jacks on the TV (A2) using the supplied audio cables.

Component Video (Color Stream®) connection

- 1 Connect the COMPONENT VIDEO OUT jacks on the DVD+VCR to the corresponding in jacks on the TV using an optional Y Pb Pr cable (C).
- 2 Connect the Left and Right AUDIO OUT jacks of the DVD+VCR to the audio left/right in jacks on the TV (A2) using the supplied audio cables.

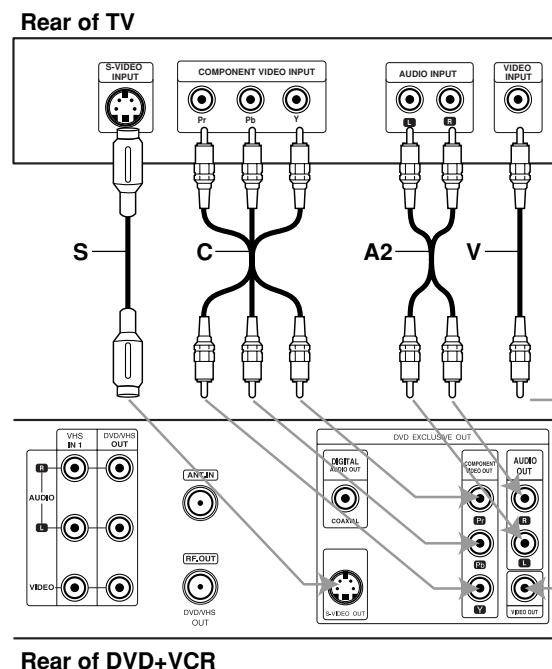

Connections (Cont'd)

Connecting to Optional Equipment

Note

- You can ONLY listen the DVD playback through COAXIAL (C) and AUDIO OUT (A2) connection method. The tuner and VCR will still be listened through the RF.OUT (R) or DVD/VHS AUDIO OUT (A1) jack

Connecting to an amplifier equipped with two channel analog stereo or Dolby Surround

Connect the Left and Right AUDIO OUT (or DVD/VHS AUDIO OUT) jacks on the DVD+VCR to the audio left and right in jacks on your amplifier, receiver or stereo system, using the supplied audio cables (A1, A2).

Connecting to an amplifier equipped with two channel digital stereo (PCM) or to an Audio/Video receiver equipped with a multi-channel decoder (Dolby Digital™, MPEG 2 or DTS)

- Connect one of the DVD+VCR's DIGITAL AUDIO OUT jacks (COAXIAL X) to the corresponding in jack on your amplifier. Use an optional digital (coaxial X) audio cable.
- You will need to activate the DVD+VCR's digital output. (See "Digital Audio Output" on page 20).

Digital Multi-channel sound

A digital multi-channel connection provides the best sound quality. For this you need a multi-channel Audio/Video receiver that supports one or more of the audio formats supported by your DVD+VCR (MPEG 2, Dolby Digital and DTS). Check the receiver manual and the logos on the front of the receiver.

Caution:

Due to the DTS Licensing agreement, the digital output will be in DTS digital out when DTS audio stream is selected.

Notes

- If the audio format of the digital output does not match the capabilities of your receiver, the receiver will produce a strong, distorted sound or no sound at all.
- Six Channel Digital Surround Sound via digital connection can only be obtained if your receiver is equipped with a Digital Multi-channel decoder.
- To see the audio format of the current DVD in the on-screen display, press AUDIO.

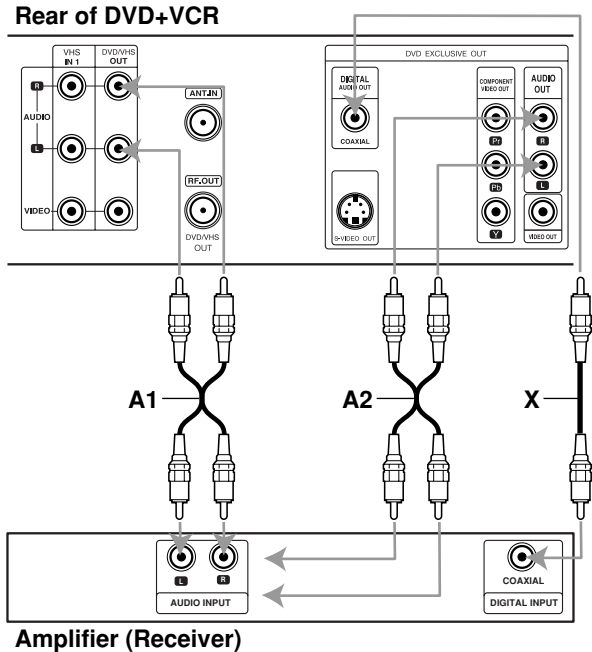

Accessory Audio/Video (A/V) Connections to DVD+VCR

Connect the VHS IN1 or VHS IN2 jacks on the DVD+VCR to the audio/video out jacks on your accessory component, using the optional audio/video cables.



Jack panel of Accessory

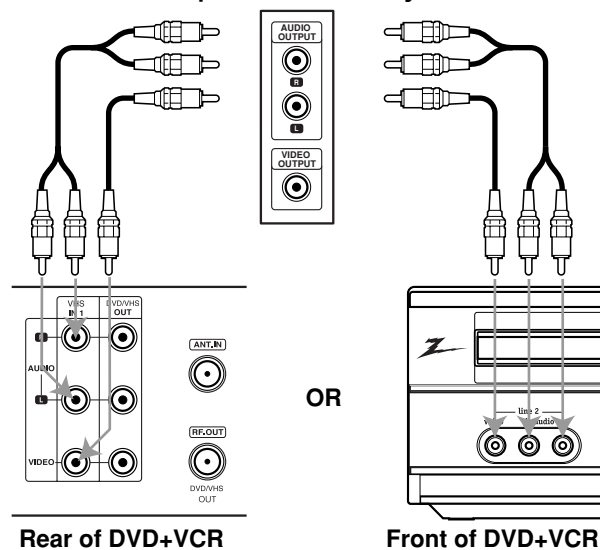

Before Operation - VCR Part

On-Screen Display (OSD)

Some of these functions will be displayed every time the VCR is operated.

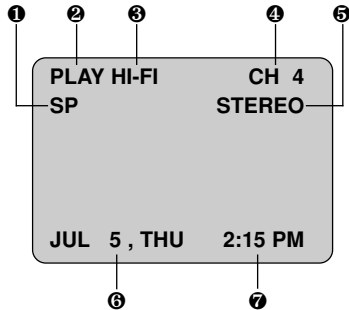

1 TAPE SPEED DISPLAY

Shows the current tape speed.

2 FUNCTION DISPLAY

Indicates the function in progress.

3 HI-FI DISPLAY

Indicates when this unit are playing back tape recorded with HI-FI.

4 CHANNEL DISPLAY

Indicates the selected channel (or LINE1, LINE2).

5 STEREO/SAP DISPLAY (MONO is not displayed)

Shows the type of audio signal received by the VCR tuner.

6 DATE DISPLAY

Shows the current date. (Month/Day/Day of the week format)

7 CLOCK/COUNT/REMAIN DISPLAY

Shows the current time, the tape counter and remaining time on the tape.

Each press of the **SELECTER/ENTER** changes the TV screen in the following sequence.

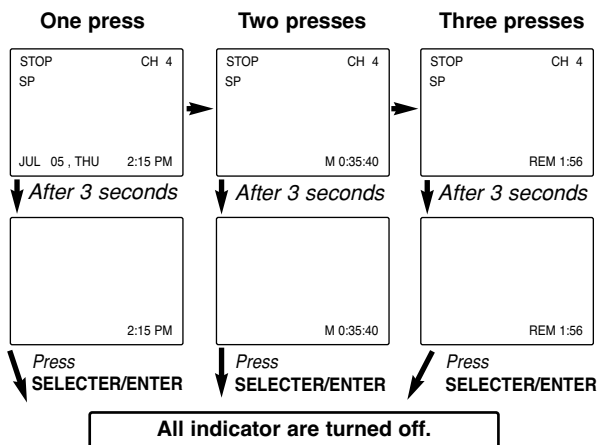

Notes

- The function displays can be seen displayed on the TV screen for 5 seconds.
- The clock (or tape counter, tape remaining) mode will continue until you press **SELECTER/ENTER**.
- The tape counter and the remaining tape length indicator appear only when a cassette is inserted. Also, the remaining tape length indicator appears after any tape operation.

Setting the On-Screen Display

The SETUP, clock setting, and timer recordings are accessed conveniently with On-Screen Menu Displays that lead you through each step. The following pages describe the On-screen selections to be set.

Menu Selection

Your VCR allows remote control adjustment of several features.

1 Press **MENU** and the **MAIN** menu will appear.

2 Select the desired menu with the **▲** or **▼** button and then press **SELECTER/ENTER**.

Note

- The on-screens can be seen displayed for 3 minutes.

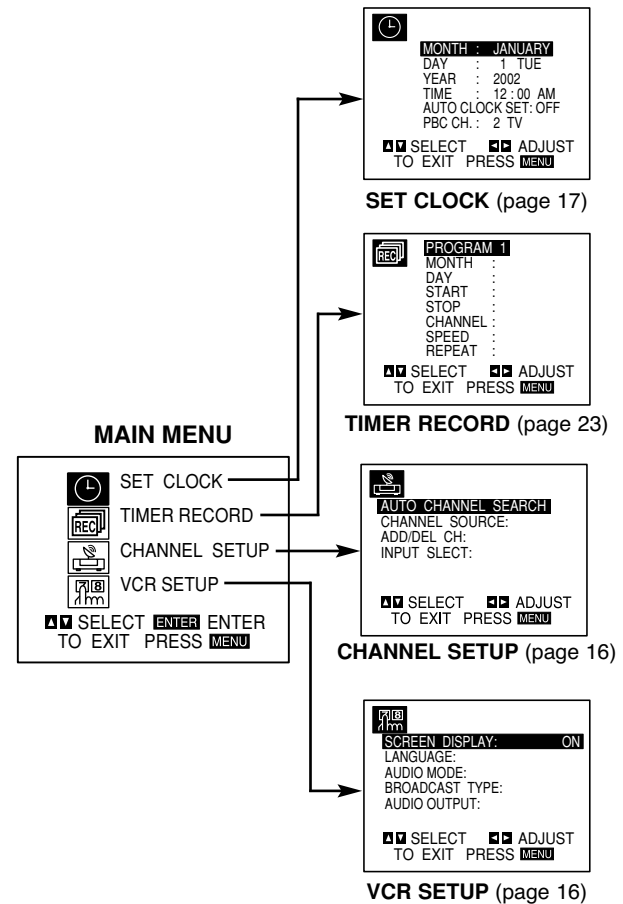

Before Operation - VCR Part (Cont'd)

Setting the VCR Setup Menu

- 1 Press **MENU** and the **MAIN** menu will appear.
- 2 Press **▲** or **▼** to select the **VCR SETUP** menu, then press **SELECTER/ENTER**.
The **VCR SETUP** menu will appear.

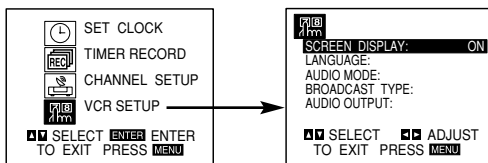

- 3 Press **▲** or **▼** to choose a desired item on the **VCR SETUP** menu. Then press **◀** or **▶** to choose a desired setting.

SCREEN DISPLAY

The on-screen display of this VCR can be turned on or off.

- The **SCREEN DISPLAY** is switched between **ON** and **OFF** by pressing **◀** or **▶**.

LANGUAGE

The on-screen programming of this VCR can display in either English, Spanish, or French.

- The **LANGUAGE** is switched among **ENGLISH**, **SPANISH** and **FRENCH** by pressing **◀** or **▶**.

AUDIO MODE

The VCR has two separate audio playback systems, the high quality **VHS Hi-Fi** system and standard **NORMAL** mono system. The same audio is generally recorded on both systems. The **VHS Hi-Fi** system plays on separate (left and right) channels, and the **NORMAL** system plays monaural sound. The normal track is always played so the cassette can be played on a VCR that does not have **VHS Hi-Fi**.

- The **AUDIO MODE** is switched between **HI-FI** and **NORMAL** by pressing **◀** or **▶**.

BROADCAST TYPE (STEREO/SAP/MONO)

Multichannel Television Sound (MTS) carries stereo and/or Second Audio Program (SAP) bilingual signals. Set this display to the desired position when both MTS stereo and SAP signals are received. When only one of the MTS signal is received, the VCR automatically selects the corresponding receiving mode (Stereo or SAP) regardless of the selected position. For normal operation, the display should be in the **STEREO** position. The VCR will then record a **STEREO** program when available, and record a **mono** program IF the program NOT IN **STEREO**. For weak **STEREO** and/or **SAP** broadcasting, changing the display to **mono** may give clearer sound.

- The **BROADCAST TYPE** is switched among **STEREO**, **SAP**, and **MONO** by pressing **◀** or **▶**.

AUDIO OUTPUT (STEREO/LEFT/RIGHT)

Used during playback [when **AUDIO MODE** (**HI-FI**/ **NORMAL**) is in **HI-FI** position] for selecting the audio output signals from the **AUDIO OUT** terminals (L ch and R ch), and **VHF/UHF/CATV**.

This display setting should normally be left in the **stereo** position, so that when a stereo tape is played, the stereo sound will be heard through the left and right channels. If a mono tape is played and the audio output is set to **stereo**, the same mono sound will be heard from both left and right channels.

The **AUDIO OUTPUT** is switched among **STEREO**, **LEFT**, and **RIGHT** by pressing **◀** or **▶**.

Channel Selection

This VCR is equipped with a frequency synthesized tuner capable of receiving up to 181 channels. These include **VHF** channels 2-13, **UHF** channels 14-69 and **CATV** channels 1-125.

Preparation:

- Connect the VCR to the desired type of antenna or cable TV system, as shown in **ANTENNA TO VCR CONNECTIONS**.

AUTO CHANNEL PROGRAMMING

- 1 Press **MENU** and the **MAIN** menu will appear.
- 2 Press **▲** or **▼** to select the **CHANNEL SETUP** menu, then press **SELECTER/ENTER**.
The **CHANNEL SETUP** menu will appear.

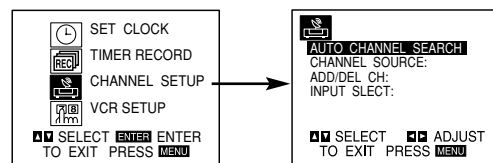

- 3 Press **▼** to choose the **CHANNEL SOURCE** item, then press **◀** or **▶** to select **TUNER**.
Press **◀** or **▶** repeatedly to switch between **TUNER**, **LINE1** and **LINE2**.
- 4 Press **▲** or **▼** to choose the **AUTO CHANNEL SEARCH** item, then press **◀** or **▶** to set the channel.
The tuner will automatically cycle through all available channels in the area and place them in the tuner's memory.
- 5 After the **AUTO CHANNEL SEARCH PROCEEDING** is complete, make sure the **CHANNEL SOURCE** is set appropriately (**TV** or **CATV**) by pressing **▲** or **▼** and choosing the correct **CHANNEL SOURCE** (**TV** or **CATV**) by pressing **◀** or **▶** using the **CHANNEL SETUP** menu.
Remember, **TV** is for the air antenna reception, **CATV** is for cable or wireless cable connection.
- 6 Press **MENU** to return to the **TV** screen.
- 7 Use **CH/TRACK** (**▲/▼**) or **CHANNEL** (**▲/▼**) on the front panel to cycle the VCR through the channels in memory.

TO ADD OR ERASE CHANNELS FROM MEMORY

This feature allows you to add or erase channels from memory manually.

- 1 Press **▼** to choose the **ADD/DEL CH** item on the **CHANNEL SETUP** menu. Press **◀** or **▶** to select a channel to add or erase.
- 2 Press **SELECTER/ENTER** to add or erase the channel.
Repeat steps 1 and 2 to add or erase channels.
- 3 Press **MENU** to return to the **TV** screen.

Before Operation - VCR Part (Cont'd)

Setting the Clock

The VCR gives you two ways to set the time and date: the Auto Clock Feature or manually. The Auto Clock Feature enables the VCR to set up the clock when the VCR is turned off.

Things to know before starting

- The clock uses the 12-hour system. (Be sure to set AM and PM correctly.)
- The initial Clock Setting is **JANUARY 1, 2002, 12:00 AM**.

Auto Clock Set

The Auto Clock Set feature is set to ON at the factory. In the ON setting, the VCR looks for a channel carrying XDS (Extended Data Services) information. XDS updates the clock using the Coordinated Universal Time.

- 1** Press **MENU** and the **MAIN** menu will appear.
- 2** Press **▲** or **▼** to choose the **SET CLOCK** menu. Press **SELECTER/ENTER** and the **SET CLOCK** menu will appear.

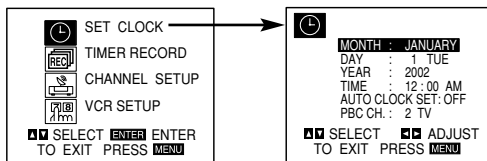

- 3** Press **▼** to choose the **AUTO CLOCK SET** item. Press **◀** or **▶** to choose **ON**.

The Auto Clock Set feature is set to ON at the factory. In the ON setting, the VCR looks for a channel carrying XDS (Extended Data Services) information. XDS updates the clock using the Coordinated Universal Time.

- 4** Press **▼** to choose the **PBS CH.** item. Press **◀** or **▶** to choose channel of PBS broadcast.
- 5** Press **MENU** when finished.

Note

There are cases that TV station does not send or send wrong date and/or time information and VCR set the incorrect time accordingly. In this case we recommend that you set the clock manually.

Manual Clock Set

Example: July 5, 2002 ; 2:15 AM

- 1** Press **MENU** and the **MAIN** menu will appear.
- 2** Press **▲** or **▼** to choose the **SET CLOCK** menu. Press **SELECTER/ENTER** and the **SET CLOCK** menu will appear.

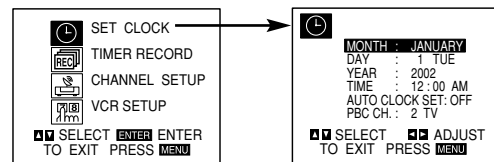

- 3** Press **◀** or **▶** to choose the month.
- 4** Press **▼** to choose the **DAY** item. Press **◀** or **▶** to choose the day. The day of the week will display automatically.
- 5** Press **▼** to choose the **YEAR** item. Press **◀** or **▶** to choose the year.
- 6** Press **▼** to choose the **TIME** item. Press **◀** or **▶** to choose the time.
- 7** Press **MENU** when finished.

Note

The "AUTO CLOCK SET" must be set to "OFF". If set to "ON", an incorrect date and/or time will be entered again when the VCR is turned off.

Before Operation - DVD Part

General Explanation

This manual gives the basic instructions for operating the DVD+VCR. Some DVDs require specific operation or allow only limited operation during playback. When this occurs, the symbol  appears on the TV screen, indicating that the operation is not permitted by the DVD+VCR or is not available on the disc.









On-Screen Display

The general playback status can be displayed on the TV screen. Some items can be changed on the menu.

On-screen display operation

- 1** Press **DISPLAY** during playback.
- 2** Press **▲** or **▼** to select an item.
The selected item will be highlighted.
- 3** Press **◀** or **▶** to change the setting of an item.
The number buttons can be also be used for setting numbers (e.g., title number). For some functions, press **SELECT/ENTER** to execute the setting.







Temporary Feedback Field Icons

-  TITLE Repeat Title (DVD)
-  CHAPT Repeat Chapter (DVD)
-  TRACK Repeat Track (CD)
-  ALL Repeat All Tracks (CD)
-  A B Repeat A-B
-  OFF Repeat Off
-  Resume play from this point
-  Action prohibited or not available





Notes

- Some discs may not provide all of the features on the on-screen display example shown below.
- If no button is pressed for 10 seconds, the on-screen display disappears.

DVD

Items		Function (Press ▲/▼ to select desired item)	Selection Method
Title Number	 1	Shows the current title number and, skip to the desired title number.	◀ / ▶, or Numeric, SELECT/ENTER
Chapter Number	 1	Shows the current chapter number and, skip to the desired chapter number.	◀ / ▶, or Numeric, SELECT/ENTER
Time search	 0:16:57	Shows the elapsed playing time and, search the point by the elapsed time directly.	Numeric, SELECT/ENTER
Audio language and Digital Audio Output mode	 1 ENG 6 CH	Shows the current audio soundtrack language, encoding method and channel number, and changes the setting.	◀ / ▶, AUDIO
Subtitle language	 OFF	Shows the current subtitles language, and changes the setting.	◀ / ▶, SUBTITLE
Angle	 1	Shows the current angle number and, changes the angle number.	◀ / ▶, ANGLE
Sound	 NORM.	Shows the current sound mode, and changes the setting.	◀ / ▶

CD

Items		Function (Press ▲/▼ to select desired item)	Selection Method
Track Number	 1	Shows the current track number and, skip to the desired track number.	◀ / ▶, or Numeric, SELECT/ENTER
Time	 16:57	Shows the elapsed playing time (Display only)	-
Audio Channel	 STER.	Shows the audio channel, and changes the audio channel.	◀ / ▶, AUDIO
Sound	 NORM.	Shows the current sound mode, and changes the setting.	◀ / ▶

Before Operation - DVD Part (Cont'd)

Initial Settings

You can set your own Personal Preferences on the DVD+VCR.

Initial Settings General Operation

- 1 Press SETUP.**
The setup menu appears.



- 2 Press ▲/▼ to select the desired item.**
The screen will show the current setting for the selected item, as well as alternate setting(s).
- 3 While the desired item is selected, press ►, then ▲/▼ to select the desired setting.**
- 4 Press SELECT/ENTER to confirm your selection.**
Some items require additional steps.
- 5 Press SETUP, RETURN or PLAY to exit the setup menu.**

Language

Disc Language **DVD**

Select a language for the disc's Menu, Audio and Subtitle.

Original : The original language set for the disc is selected.

Other : To select another language, press number buttons to enter the corresponding 4-digit number according to the language code list on page 36. If you enter the wrong language code, press CLEAR.



Menu Language

Select a language for the setup menu. This is the menu you see when you press SETUP.



Picture

TV Aspect **DVD**

4:3 Letterbox: Select when a standard 4:3 TV is connected. Displays theatrical images with masking bars above and below the picture.

4:3 Panscan: Select when a standard 4:3 TV is connected. Displays pictures cropped to fill your TV screen. Either sides of the picture are cut off.

16:9 Wide: Select when a 16:9 wide TV is connected.

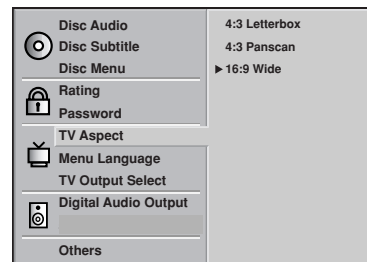

TV Output Select **DVD**

It can be used to select the video output between S-VIDEO OUT jack and COMPONENT VIDEO OUT jack.

S-Video: Select when you use S-VIDEO jack for TV connection.

Component: Select when you use COMPONENT VIDEO OUT jack for TV connection.



Before Operation - DVD Part (Cont'd)

Sound

Digital Audio Output

Each DVD disc has a variety of audio output options. Set the DVD+VCR's Digital Audio Output according to the type of audio system you use.

DOLBY DIGITAL/PCM: Select "DOLBY DIGITAL/PCM" if you connected the DVD+VCR's DIGITAL OUT jack to a Dolby Digital decoder (or an amplifier or other equipment with a Dolby Digital decoder).

Stream/PCM: Select "Stream/PCM" if you connected the DVD+VCR's DIGITAL OUT jack to an amplifier or other equipment with a DTS decoder, Dolby Digital decoder or MPEG decoder.

PCM: Select when connected to a 2 channel digital stereo amplifier. The DVD+VCR outputs sounds in the PCM 2ch format when you play a DVD video disc recorded on the Dolby Digital, MPEG1 or MPEG2 recording system.

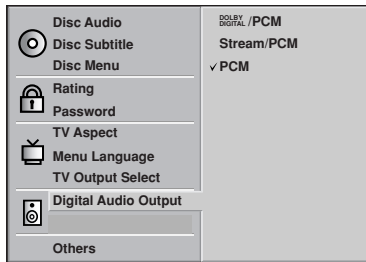

Others

The DRC and Vocal settings can be changed.

- Press ▲/▼ to select the desired item and press SELECT/ENTER. The setting of the selected item is changed between On and Off.



Dynamic Range Control (DRC)

With the DVD format, you can hear a program's soundtrack in the most accurate and realistic presentation possible, thanks to digital audio technology. However, you may wish to compress the dynamic range of the audio output (the difference between the loudest sounds and the quietest ones). Then, you may listen to a movie at a lower volume without losing clarity of sound. Set DRC to On for this effect.

Vocal

Set Vocal to On only when a multi-channel karaoke DVD is playing. The karaoke channels on the disc will mix into normal stereo sound.

Before Operation - DVD Part (Cont'd)

Parental Control

Rating **DVD**

Movies on DVDs may contain scenes not suitable for children. Therefore, discs may contain Parental Control information that applies to the complete disc or to certain scenes on the disc. These scenes are rated from 1 to 8, and alternatively, more suitable scenes are available for selection on some discs. Ratings are country dependent. The Parental Control feature allows you to prevent discs from being played by your children or to have certain discs played with alternative scenes.

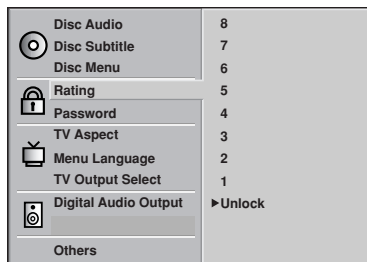

1 Select "Rating" on the Setup menu using the ▲ and ▼ buttons.

2 While "Rating" is selected, press ►.

3 When you have not entered a password yet; Go to step 4.

When you have already entered a password; Enter a 4-digit password using the numerical buttons to confirm the personal 4-digit security password, then press SELECT/ENTER.

If you make a mistake before pressing SELECT/ENTER, press CLEAR and enter 4-digit security password again.

4 Select a rating from 1 to 8 using the ▲/▼ buttons. **One (1) has the least playback restrictions. Eight (8) has the most playback restrictions.**

Unlock: If you select Unlock, Parental Control is not active. The disc will play in full.

Ratings 1 to 8: Some discs contain scenes not suitable for children. If you set a rating for the DVD+VCR, all disc scenes with the same rating or lower will be played. Higher rated scenes will not be played unless an alternative scene is available on the disc. The alternative must have the same rating or a lower one. If no suitable alternative is found, playback will stop. You must enter the 4-digit password or change the rating level in order to play the disc.

5 Press SELECT/ENTER to confirm your rating selection, then press SETUP to exit the menu.

Password **DVD**

If you change the rating level to "7" or lower, you must enter a 4-digit "password" to prevent playback of discs with higher ratings.



1 Select Password using the ▲/▼ buttons on the setup menu.

2 While Password is selected, press ►.

3 Enter a 4-digit password using the numerical buttons to create a personal 4-digit security password, then press SELECT/ENTER.

Do not forget your password.

4 Enter the 4-digit password again and press SELECT/ENTER to verify.

Setting is complete.

N Note

Confirmation of the 4-digit password is necessary when the code is changed (see "Changing the 4-digit code" below).

Changing the 4-digit code

- 1 Press SETUP to display the setup menu.
- 2 Press ▼ to select Password.
- 3 Enter the old code, then press SELECT/ENTER.
- 4 Select Change using the ▲/▼ buttons then press SELECT/ENTER.
- 5 Enter the new 4-digit code, then press SELECT/ENTER.
- 6 Enter exactly the same code a second time and verify by pressing SELECT/ENTER.
- 7 Press SETUP to exit the menu.

If you forget your 4-digit code

If you forget your password, to clear the current password, follow the procedure below.

- 1 Press SETUP to display the setup menu.
- 2 Press ▼ to select Password.
- 3 Use the Number buttons to enter the 6-digit number "210499." and then press SELECT/ENTER. The 4-digit password is cleared.
- 4 Enter a new code as shown above.

Operation with tape

Normal Playback

Preparations:

- Turn on the TV.
- Tune the TV to the VCR output channel (CH 3 or 4).
- If a direct VIDEO/AUDIO connection is made between the VCR and the TV, set the TV's source selector to VIDEO.

1 Insert a prerecorded video cassette.

The TAPE IN indicator will light and the VCR will power-up automatically.

- Make sure that the TIMER indicator in the VCR indicator panel is not lighted. If it is, press **POWER** once.
- If a tape without a safety tab is inserted the unit will start the playback automatically.

2 Press PLAY once.

The PLAY appears on the TV screen .

- It is not necessary to select the tape speed for playback. It will be automatically selected by the VCR.
- In playback, the **TV/VCR** selector switches to VCR mode automatically.

3 Press STOP to stop playback.

The STOP appears on the TV screen.

- If the tape reaches the end before **STOP** is pressed, the VCR will automatically stop, rewind, eject, and it will turn itself off.

Tracking Control

Auto Tracking

The automatic tracking function adjusts the picture to remove snow or streaks.

The AUTO TRACKING function works in the following cases:

- A tape is played back for the first time.
- Tape speed (SP, LP, EP) changes.
- Streaks or snow appear because of scratches on the tape.

Manual Tracking

If noise appears on the screen during playback, press either **CH/TRACK** (▲ / ▼) on the remote control or **CHANNEL** (▲ / ▼) on the front panel until the noise on the screen is reduced.

- In case of vertical jitter, adjust these controls very carefully.
- Tracking is automatically reset to normal when the tape is ejected or the power cord is unplugged for more than 3 seconds.

Special Effect Playbacks

Special effects playback notes

- Horizontal lines (noise bars) will appear on the TV screen. This is normal.
- The audio is automatically muted during special effect modes, so there is no sound during search.
- During the high-speed picture search modes, a short period is needed to stabilize tape speed when re-entering the PLAY mode. Slight interference may be observed during this period.

Search

This function lets you quickly and visually search for a desired tape section in either direction: forward and reverse.

1 Press BACKWARD ◀◀ or FORWARD ▶▶ during playback.

The VCR will be activated in the SEARCH mode.

- If the VCR is left in the SEARCH mode for more than 3 minutes, the VCR will automatically enter the PLAY mode, to protect the tape and video heads.

2 To exit search mode, press PLAY.

Still Picture and Frame-by-frame playback

1 Press PAUSE/STEP during playback.

Still picture will appear on the TV screen.

- If a still picture vibrates vertically, stabilize it by pressing **CH/TRACK** (▲ / ▼) on the remote control.
- If the VCR is left in the STILL mode for more than 5 minutes, the VCR will automatically enter the STOP mode to protect the tape and video heads.

2 Press PAUSE/STEP repeatedly to advance the video picture one frame at a time while viewing a still picture.

3 To exit still picture mode, press PLAY.

Slow Motion

1 While in still video mode, press BACKWARD ◀◀ or FORWARD ▶▶.

The tape will be played back at a speed 1/19 times slower than the normal speed.

- During slow playback, **CH/TRACK** (▲/▼) on the Remote Control can be used to minimize noise bands.
- When the slow mode continues for more than 30 seconds, the VCR will automatically change to playback mode.

2 Press BACKWARD ◀◀ or FORWARD ▶▶ to control slow speed during slow motion.

3 To exit search mode, press PLAY.

CM SKIP (Commercial Skip)

This is useful for skipping commercials or short program segments.

1 Press CM SKIP during the playback mode.

The tape will fast forward picture search through 30 seconds of recording.

- The skipping time can be extended by pressing CM SKIP.
- Subsequent presses result in advancing the fast forward picture search time by 30-second increments (maximum 3 minutes).

2 When the search is completed, the VCR will go into playback mode automatically.

Operation with tape (Cont'd)

Normal Recording

Preparations:

- Turn on the power of both the VCR and TV.
- Be sure the TV is set to the VCR Output Channel (CH 3 or 4).
- If a direct VIDEO/AUDIO connection is made between the VCR and the TV, set the TV's source selector to VIDEO.

- 1** Insert the video cassette that the safety tab is in place.
- 2** Select the desired channel by using CH/TRACK (▲/▼).
 - If you are recording from another source via audio/video input jacks (at the Rear or Front panel), select the LINE1 or LINE2 by pressing INPUT.
- 3** Set the desired recording speed (SP or EP) by pressing SP/EP.
 - This VCR is not designed to record in LP mode.
- 4** Set the MTS mode as desired (See page 16, 26).
- 5** Press REC once.
Recording will start. (The REC indicator will light on the VCR indicator panel)
 - If a cassette with no safety tab is loaded, the cassette will be ejected automatically.
- 6** Press STOP to stop recording.
If the tape reaches the end before STOP is pressed, the VCR will automatically stop, rewind, eject, and it will turn itself off.

To pause the recording

- 1** Press PAUSE/STEP to pause the tape during recording.
The REC indicator will flash on the VCR indicator panel.
- 2** When you want to continue recording, press PAUSE/STEP or press REC.
 - After 5 minutes in pause mode, the tape will be stopped automatically to protect the tape and the video heads.

To record one TV program while watching another

- 1** Press TV/VCR to select the TV mode during recording.
The VCR indicator disappears.
- 2** Using the TV, select the channel to be viewed.

Tips

Always use PAUSE/STEP for best results when making changes during recording.
For example: To change channels during recording, first press PAUSE/STEP to put the unit in pause mode. Then select the desired channel on the VCR, and press PAUSE/STEP again to resume recording.

Timer Recording

This VCR can be programmed to record up to 8 programs within a period of 1 year. For unattended recording, the timer needs to know the channels to be recorded and the starting and ending times.

Things to know before starting

- If you try to set the program timer before setting the clock, PLEASE SET THE CLOCK appears for a moment and then SET CLOCK menu appears on the TV screen. Set the time and date before proceeding.
- Make sure a tape is in the VCR and the safety tab is in place or the tape will be automatically ejected.

Preparations:

- Turn on the power of both the VCR and the TV.
- Be sure the TV is set to the VCR output channel (3 or 4).
- Make sure the CHANNEL SOURCE in the CHANNEL SETUP menu is set appropriately (TV or CATV) (see illustration left).

- 1** Press MENU and the MAIN menu will appear.
- 2** Press ▲ or ▼ to choose the TIMER RECORD menu.
- 3** Press SELECTER/ENTER to enter the TIMER RECORD menu.
The TIMER RECORD menu will appear.
 - If all programs have already been entered, FULLY PROGRAMMED message will appear for a moment and then PROGRAM 1 will appear on the TV screen.

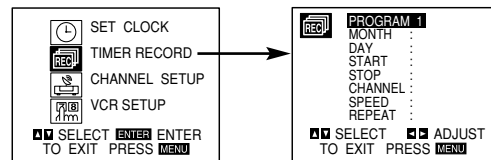

- 4** Press ◀ or ▶ to choose the PROGRAM No. (1-8).
- 5** Press ▼ to choose the MONTH item.
Press ◀ or ▶ to choose the desired month.
- 6** Press ▼ to choose the DAY item.
Press ◀ or ▶ to choose the desired day.
- 7** Press ▼ to choose the START item.
Press ◀ or ▶ to choose the desired start time.
- 8** Press ▼ to choose the STOP item.
Press ◀ or ▶ to choose the desired stop time.
- 3** Press ▼ to choose the CHANNEL item.
Press ◀ or ▶ to choose the desired channel (Channel, LINE1 or LINE2).

Cable Users: If you have CABLE TV and used Cable Box in Cable Antenna Connections (page 12), using a cable box converter, you must set the channel in this step to match the cable box output channel (usually CH 3 or 4). Change channels on the cable box instead of with the VCR.

Operation with tape (Cont'd)

- 10** Press ▼ to choose the SPEED item.
 Press ◀ or ▶ to choose the desired recording speed (AUTO, SP or EP).
- The AUTO mode determines how much tape is left and switches speed from SP to EP, if necessary, to complete recording the program. There will be some picture and sound distortion at the point of the speed change.

- 11** Press ▼ to choose the REPEAT item.
 Press ◀ or ▶ to choose the desired repeat (ONCE, WEEKLY, or DAILY).
- ONCE event....**for recording up to 8 programs on a single day or over the days within a period of 1 year.
WEEKLY event....for recording up to 8 programs on a certain day of every week.
DAILY event....for recording up to 8 programs at the same time(s) Monday through Friday.

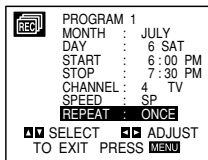

Tips

If the input data is wrong, press ▲ to select the data and correct it by pressing ◀ or ▶.

- 12** Press MENU, the program will be memorized at the VCR.

- If the program preset time is past, the PAST TIME PROGRAMMED message will appear on the TV screen. Return to the incorrect program and program it with the correct time.
- If you had entered a past date, the timer recording will be performed on that date of the next year.
- Additional programs may be entered by repeating steps 1-12.

Cable Users: If your cable hookup is via a TV converter box, you can program multiple recordings only on the converter box output channel. This is because the converter determines what channel you view through your VCR.

- 13** Turn the DVD+VCR off for a timer recording to take place.

Tips

If you are finished programming and you want to set the VCR to record the programs you have entered. **A) MAKE SURE YOU HAVE INSERTED A TAPE INTO THE VCR. B) YOU MUST TURN OFF THE VCR BEFORE IT WILL RECORD ANY TIMER PROGRAMS. (TIMER indicator lights).** The VCR is now set to record the preset programs.

Notes

If the power fails or the VCR is unplugged from the AC outlet, the correct clock time and timer settings are kept in memory for approximately 3 seconds. After 3 seconds, the clock and program timer must be reset when power is restored. Reset time according to instructions.

Checking (Erasing) the Timer Program

Programming can be checked whenever the VCR is turned on.

- Press MENU and the MAIN menu will appear.
- Press ▲ or ▼ to choose the TIMER RECORD menu. Press SELECTER/ENTER and the PROGRAM menu will appear.

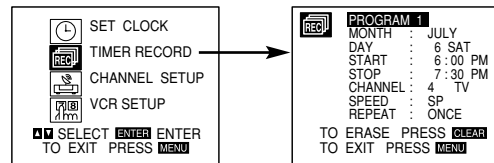

- Press ◀ or ▶ to select a program you want to check or erase. If you want to erase the program, press CLEAR.
- Press MENU to return to the TV screen.

Program Priority

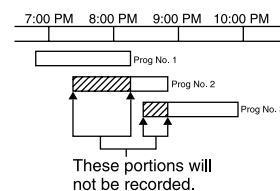

If the recording start and end times of preset programs overlap on the same day (see the example and diagram left), program number 2 will not be recorded until program number 1 is finished.

The first part of program number 2 will not be recorded. The same thing will happen to program number 3.

Operation with tape (Cont'd)

Instant Timer Recording

Instant Timer Recording allows you to make a recording easily of a preset length without using the program timer.

Preparations:

- Turn on the power of both the VCR and the TV.
- Be sure the TV is set to the VCR output channel (3 or 4).
- If a direct VIDEO/AUDIO connection is made between the VCR and the TV, set the TV's source selector to VIDEO.

- 1** Insert the video cassette that the safety tab is in place.
- 2** **Select the desired channel by using CH/TRACK (▲/▼) or number (0-9).**
The channel number appears on the TV screen.
 - If you are recording from another source via audio/video input jacks (at the Rear or Front panel), select the LINE1 or LINE2.
- 3** **Set the desired recording speed (SP or EP) by pressing SP/EP.**
The tape speed will appear on the TV screen.
- 4** **Press REC twice.**
The menu as illustrated, will appear on the TV screen.
 - Recording will start. (The TIMER indicator will light)
- 5** **Press REC repeatedly to select the recording time length.**
At the end of the recording, the VCR will stop recording and shut off.
 - During Instant Timer Recording, changing the channel on the VCR will not be possible.
 - You can stop the recording by pressing **STOP**.

INSTANT TIMER RECORD MENU

INSTANT TIMER RECORD	
CHANNEL	2
SPEED	SP
START LENGTH	NOW 0H30M

0H30M 9H00M → 0H00M
↑
Length Display
(each pressing REC increases recording by 30 minutes)

Checking the Recording Time

Press REC once to check the recording time. The recalled setting will automatically return to the TV screen after 6 seconds.

To extend the Recording Time

The recording time can be extended anytime by pressing REC. Subsequent presses result in advancing the recording time by 30-minute increments.

N Notes

- If you press **PAUSE/STEP** during instant timer recording, the VCR will enter the normal recording mode.
- If the VCR is set to "0H00M", the VCR goes to normal recording mode.

Dubbing and Editing

If you wish to edit or dub your camcorder (or another VCR) recordings to this VCR, the rear (or Front) panel mounted Audio and Video (A/V) input jacks make the connections quick and easy. The direct A/V jacks will also provide better picture results than using the RF jack on the rear panel.

- 1** **Connect the camcorder's (or another VCR's) A/V outputs to your DVD+VCR as illustrated on page 14.**
- 2** **Set the input channel "LINE2". (press INPUT to select LINE2.)**
 - If you have connected your VCR to the A/V input jacks on the rear of VCR, you should select the input channel LINE1 by pressing **INPUT** twice.
- 3** **Play the tape in the camcorder (or another VCR). If you have a TV attached to your VCR, you can see the video playing.**
- 4** **When you desire recording to begin, press VCR's REC once to start.**

N Note

Before recording, please confirm the recording start position.

Copying from DVD to VCR

This unit allows you to copy the contents of a DVD to a VHS tape with a press of the COPY button.

N Notes

- If the DVD you are attempting to copy is copy protected, you will not be able to copy the disc. It is not permitted to copy Macrovision encoded DVDs.
- If the DVD you are attempting to copy is copy protected, the VCR will stop Automatically.

- 1** **Insert Disc**
Insert the disc you wish to copy in the DVD deck and close the disc tray.
- 2** **Insert VHS Tape**
Insert a blank VHS videotape into the VCR deck.
- 3** **Press the COPY button on the unit front panel.**
The DVD will go into Play mode and the VCR will go into Record mode.
 - If the DVD disc menu appears, you may need to press the Play button manually to begin copying.
- 4** **Stop the Copy Process**
When the DVD is finished playing, press the VCR button on the remote control and then press the STOP button to end the copy.
You must stop the Copy process manually when the DVD movie ends, or the unit may replay and record over and over again.

Operation with tape (Cont'd)

VHS Hi-Fi Stereo System/ MTS Broadcast

This VCR is equipped with the VHS Hi-Fi audio sound system for recording and playback. The information below gives a brief description of Hi-Fi audio and how to record and play a tape in the Hi-Fi audio mode.

Playback with Hi-Fi Stereo Audio Sound

A stereo TV with AUDIO/VIDEO input jacks or a stereo audio system is required for true stereo playback. To experience the full and rich stereo sound available with Hi-Fi recorded tapes, we recommend the connection of this unit to a home stereo audio system.

- 1** Set the **AUDIO MODE** item to **HI-FI** on the **VCR SETUP** menu .

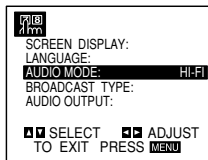

- 2** Set the **AUDIO OUTPUT** item to **STEREO** position.

(STEREO) POSITION: The left channel sound (L) is heard from the left speaker and the right channel sound (R) is heard from the right speaker.

(LEFT) POSITION: The left channel sound (L) is heard from both speakers.

(RIGHT) POSITION: The right channel sound (R) is heard from both speakers.

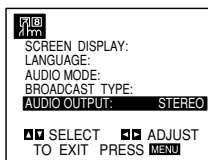

- 3** Insert a cassette and press **PLAY**.
Adjust volume at your stereo system.

MTS (Multi-Channel TV Sound)

This VCR will decode MTS stereo and bilingual (SAP) off-the-air broadcast sound signals. It also decodes stereo TV sound from local cable companies, as long as they operate on assigned cable frequencies and use the EIA-recommended MTS stereo/bilingual TV sound system.

Multichannel TV Sound Indicator (MTS)

Shows Onscreen as illustrated below when **SELECTER/ENTER** is pressed.

- One or both of the indicators will light, depending on the MTS broadcast.

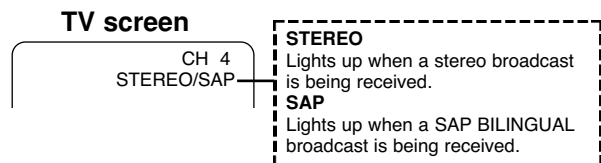

If only the **STEREO** appears on the TV screen.

The VCR can record in stereo onto the VHS Hi-Fi audio tracks when the **BROADCAST TYPE** item is in the **STEREO** position. The VCR will also record mono audio onto the mono audio track.

If only the **SAP** appears on the TV screen.

Select the **BROADCAST TYPE** item to **SAP**.

If both the **STEREO/SAP** appears on the TV screen

Use the **BROADCAST TYPE** item to select the desired recording mode (**STEREO** or **SAP**).

SAP (Second Audio Program) Recording

Some stations transmit a Second Audio Program, which is used for a second language or additional information. When the station broadcasts a Second Audio Program, follow the procedure below to record the SAP.

- 1** Insert a video cassette that the safety tab is in place.
- 2** Set the **BROADCAST TYPE** item to **SAP** (**VCR SETUP** menu).

Do this if only the **SAP** appears on the TV screen or you know the program will use the **SAP**.

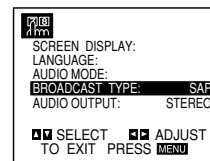

- 3** Set the desired recording speed (**SP** or **EP**) by pressing **SP/EP**.

- 4** Select the desired channel. The **SAP** should appear on the TV screen.

- 5** Press **REC** once

You are now recording the program you see and hear on the TV.

- 6** Press **STOP** to stop recording.

Operation with tape (Cont'd)

Tape Counter Memory Feature

Real-Time Counter

Shows length of tape run in hours, minutes, and seconds (refer to the left). Press **CLK/COUNT** to select the real-time counter display.

Every press of **CLK/COUNT** changes the TV screen as illustrated below.



- Counter changes to "M 0:00:00" when the cassette is ejected.
- The real-time counter does not operate when nothing is recorded on the tape.
- The real-time counter will not work when the tape is not inserted.

Counter Memory Function

This is useful if there is a section of tape you want to view immediately after recording or if you want to return to the same point several times.

- 1** Begin recording or playing a tape.
- 2** Press **CLK/COUNT** repeatedly to display the real-time counter appears on the TV screen.
- 3** At the point that you want locate later, reset the real-time counter to "M 0:00:00" by pressing **CLEAR**.
- 4** Continue to play or record.
- 5** Press **STOP** when recording or playback finishes.
- 6** Press **BACKWARD**.
The tape automatically stops when the tape counter returns to about "M 0:00:00".

Tape Remaining

This function allows the time of the remaining tape to be displayed during recording or playback.

Press **CLK/COUNT** until the **REM** indicator displays on the TV screen during recording or playback.

Note

The remaining tape length indicator may not be displayed correctly depending on the condition of the tape and the kind of the tape (T-140, T-160, or T-210 etc)

Additional Information

- In manual recording, Timer recording, Instant Timer Recording, playback, or fast forward modes, the VCR automatically starts rewinding the tape at the end of the tape. The cassette will stop at the beginning of the tape and be ejected, and the VCR will turn itself off.
- After you have finished using the VCR, rewind, eject, and remove the cassette. Place the cassette in its protective sleeve to protect it from dust. It is not necessary to rewind the cassette before removing it, but if you do, it will be ready to play or record the next time you use it.
- Be sure the VCR Channel Selector is on the correct channel you wish to record. The channel that is being recorded can always be checked by setting the television on the VCR channel (3 or 4) and pressing the **TV/VCR** selector to turn the VCR's VCR indicator on.
- Do not attempt to hook up more than one television set to the VCR for either recording or playback.

Auto Play System

This VCR features full automatic playback and rewind. Load a cassette (with the safety tab removed).

- The power turns on automatically and playback begins.
- At the end of the tape, the VCR stops, then rewinds.
- The cassette is ejected after rewinding and turn itself off automatically.

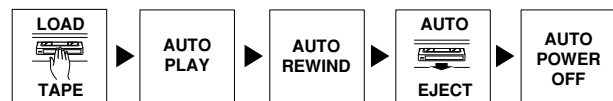

Auto Power Shut-Off Function

This feature is especially helpful when you finish watching a tape. Press **STOP**, **BACKWARD**, and **POWER**. The VCR will rewind the tape and turn itself off automatically.

1. Press **STOP** when you finish watching a tape.
2. Press **BACKWARD** to rewind the tape.
3. Press **POWER** during the **REWIND** mode, the VCR will enter the **AUTO POWER SHUT-OFF** mode.
4. The **POWER** indicator will flash on the VCR indicator panel.
5. After tape is rewound, VCR will turn off automatically.

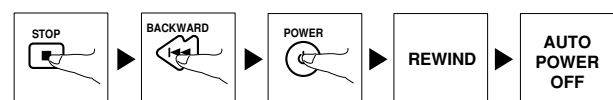

Operation with DVD and Audio CD

Playing a DVD and Audio CD

Playback Setup **DVD** **CD**

- Turn on the TV and select the video input source connected to the DVD+VCR.
- Audio system: Turn on the audio system and select the input source connected to the DVD+VCR.

1 Press OPEN/CLOSE to open the disc tray.

2 Load your chosen disc in the tray, with the label facing up.

When a double-sided DVD is inserted, make sure the side you want to play is facing up.

3 Press OPEN/CLOSE to close the tray.

“disc LOAD” appears on the display window, and playback starts automatically. If playback does not start, press PLAY.

In some cases, the disc menu might appear instead.

If a menu screen is displayed

The menu screen may be displayed first after loading a DVD which contains a menu.

DVD

Use the ◀ ▶ ▲ ▼ buttons to select the title/chapter you want to view, then press SELECT/ENTER to start playback.

Press TITLE or DISC MENU to return to the menu screen.

Notes

- If Parental Control is set and the disc is not within the Rating settings (not authorized), the 4-digit code must be entered and/or the disc must be authorized (see “Parental Control”, on page 21).
- DVDs may have a region code.
- Your DVD+VCR will not play discs that have a region code different from your DVD+VCR. The region code for this DVD+VCR is 1 (one).

Screen Saver

The screen saver picture appears when you leave the DVD+VCR in stop mode for about five minutes. After the Screen Saver has been engaged for about five minutes, the DVD+VCR will automatically turn itself off.

General Features

Note

Unless stated otherwise, all operations described use the remote control. Some features may also be available on the Setup menu.

Moving to another TITLE **DVD**



When a disc has more than one title, you can move to another title as follows:

- Press DISPLAY when playback is stopped, then press the appropriate numbered button (0-9) to select a title number.

Moving to another CHAPTER/TRACK



When a title on a disc has more than one chapter or a disc has more than one track, you can move to another chapter/track as follows:

- Press BACKWARD ◀◀ or FORWARD ▶▶ briefly during playback to select the next chapter/track or to return to the beginning of the current chapter/track.
- Press BACKWARD ◀◀ twice briefly to step back to the previous chapter/track.
- To go directly to any chapter during DVD playback, press DISPLAY. Then, press ▲/▼ to select C (chapter) (or for a Audio CD, select T for track). Then, enter the chapter/track number using the numbered buttons (0-9).

Tip

In case of audio CD, to go directly to any track, enter the track number using the numbered buttons (0-9) during playback.

Slow Motion **DVD**

- 1 Press BACKWARD ◀◀ or FORWARD ▶▶ during pause mode.
The DVD+VCR will enter SLOW mode.
- 2 Use the BACKWARD ◀◀ or FORWARD ▶▶ to select the required speed: ◀◀ 1/16, ◀◀ 1/8, ◀◀ 1/4 or ◀◀ 1/2 (backward), or ▶▶ 1/16, ▶▶ 1/8, ▶▶ 1/4 or ▶▶ 1/2 (forward).
- 3 To exit slow motion mode, press PLAY.

Operation with DVD and Audio CD (Cont'd)

General Features (cont'd)

Still Picture and Frame-by-frame playback

DVD CD

DVD Video Discs

- 1 Press PAUSE/STEP during playback.
The DVD+VCR will now go into PAUSE mode.
- 2 With a DVD, You can advance the picture frame by frame by pressing PAUSE/STEP repeatedly on the remote control.

Audio CDs

- 1 Press PAUSE/STEP during playback.
The DVD+VCR will now go into PAUSE mode.
- 2 To return to playback, press PLAY or PAUSE/STEP again.

Search **DVD CD**

- 1 Press and hold BACKWARD ◀◀ or FORWARD ▶▶ for about two seconds during playback.
The DVD+VCR will now go into SEARCH mode.
- 2 Press and hold BACKWARD ◀◀ or FORWARD ▶▶ repeatedly to select the required speed: ◀◀X2, ◀◀X4, ◀◀X16, ◀◀X100 (backward) or ▶▶X2, ▶▶X4, ▶▶X16, ▶▶X100 (forward).
With a Audio CD, the Search speed changes: ◀◀X2 (backward) or ▶▶X2 (forward).
- 3 To exit SEARCH mode, press PLAY.

Random **Karaoke DVD CD**

- 1 Press RANDOM during playback or in stop mode.
The unit automatically begins Random Playback and "RANDOM" appears on the TV screen.
- 2 To return to normal playback, press RANDOM until "NORMAL" appears on the TV screen.

Tips

By pressing BACKWARD ◀◀ or FORWARD ▶▶ during Random playback, the unit selects another title (track) and resumes Random playback.

Note

This function only works with DVD Karaoke discs and audio CDs.

Repeat A-B **DVD CD**



To repeat a sequence in a title:

- 1 Press A-B at your chosen starting point.
A- appears briefly on the TV screen.
- 2 Press A-B again at your chosen end point.
A-B appears briefly on the TV screen, and the repeat sequence begins (a-b repeat appears on the DVD+VCR's display).
- 3 To cancel the sequence, press A-B.

Repeat **DVD CD**



DVD Video Discs - Repeat Chapter/Title/Off

- 1 To repeat the currently playing chapter, press REPEAT.
The Repeat Chapter icon appears on the TV screen.
- 2 To repeat the title currently playing, press REPEAT a second time.
The Repeat Title icon appears on the TV screen.
- 3 To exit Repeat mode, press REPEAT a third time.
The Repeat Off icon appears on the TV screen.

Audio CDs - Repeat Track/All/Off

- 1 To repeat the track currently playing, press REPEAT.
The Repeat Track icon appears on the TV screen.
- 2 To repeat the disc currently playing, press REPEAT a second time.
The Repeat All icon appears on the TV screen.
- 3 To exit Repeat mode, press REPEAT a third time.
The Repeat Off icon appears on the TV screen.

3D Surround **DVD CD**



This unit can produce a 3D Surround effect, which simulates multi-channel audio playback from two conventional stereo speakers, instead of the five or more speakers normally required to listen to multi-channel audio from a home theater system.

- 1 Press DISPLAY during playback.
- 2 Press ▲ or ▼ to select the sound option.
The sound option will be highlighted.
- 3 Press ◀ or ▶ to select "3D SUR".
To turn off the 3D Surround effect, select "NORM".

Operation with DVD and Audio CD (Cont'd)

General Features (cont'd)

Time Search **DVD**



The Time Search function allows you to start playing at any chosen time on the disc.

- 1 Press DISPLAY during playback. The on-screen display appears on the screen.
The Time Search box shows the elapsed playing time of the current disc.
- 2 Within 10 seconds, press ▲/▼ to select the Time Search icon in the on-screen display.
The “-:--:--” appears in the Time Search box.
- 3 Within 10 seconds, use the numerical buttons to enter the required start time. Enter hours, minutes and seconds from left to right in the box.
If you enter the wrong numbers, press CLEAR to remove the numbers you entered. Then enter the correct numbers.
- 4 Within 10 seconds, press SELECT/ENTER to confirm the start time.
Playback starts from the selected time on the disc. If you enter an invalid time, playback will continue from the current point.

Zoom **DVD**

The Zoom function allows you to enlarge the video image and to move through the enlarged image.

- 1 Press ZOOM during playback or still playback to activate the Zoom function.
The square frame will be displayed in the center of the picture. If no button is pressed for more than 10 seconds, the square frame will disappear.
Each press of the ZOOM button changes the TV screen in the left sequence.

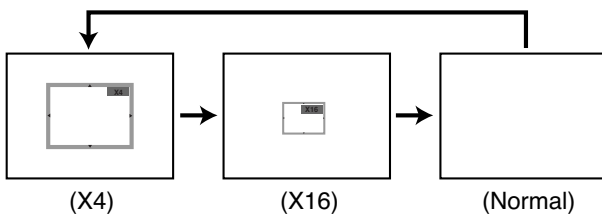

- 2 Use the ◀/▶/▲/▼ buttons to move the zoom point.
- 3 Press SELECT/ENTER.
The zoomed picture appears.
- 4 To resume normal playback, press ZOOM repeatedly until the normal picture appears.

Note

- The zoom function may not work for some DVDs.
- The zoom function may not work on multi-angle scenes.

Marker Search **DVD**



You can start playback from a memorized point. Up to nine points can be memorized.

To enter a mark, follow these steps.

- 1 During disc playback, press MARKER when playback reaches the spot that you want to memorize.
The Marker icon will appear on the TV screen briefly.
- 2 Repeat step 1 to enter up to nine Marker points on a disc.

To Recall a Marked Scene

- 1 During disc playback, press SEARCH.
The Marker Search menu will appear on the screen.

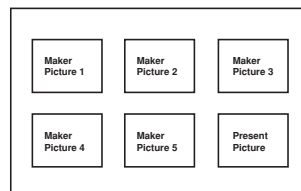

- 2 Press ◀ ▶ ▲ ▼ to select a Marker that you want to recall.
- 3 Press SELECT/ENTER.
Playback will start from the Marked scene.

To clear a Marked Scene

- 1 During disc playback, press SEARCH.
The Marker Search menu will appear on the screen.
- 2 Press ◀ ▶ ▲ ▼ to select the Marker that you want to erase.
- 3 Press CLEAR.
The Marker will be erased from the Marker Search menu.
- 4 Repeat steps 2 and 3 to erase additional Marker numbers.

Changing the Audio Language **DVD**



Press AUDIO repeatedly during playback to hear a different audio language or audio track.

Changing the Audio Channel **CD**



Press AUDIO repeatedly during playback to hear a different audio channel (STEREO, LEFT or RIGHT).

Operation with DVD and Audio CD (Cont'd)

Special DVD Features (Cont'd)

Checking the contents of DVD Video discs: Menus

DVDs may contain menus that allow you to access special features. To use the disc menu, press DISC MENU. Then, press the appropriate number button to select an option. Or, use the ◀/▶/▲/▼ buttons to highlight your selection, then press SELECT/ENTER.

Title Menu **DVD**

- 1 Press TITLE.
If the current title has a menu, the menu will appear on the screen. Otherwise, the disc menu may appear.
- 2 The menu can list camera angles, spoken language and subtitle options, and chapters for the title.
- 3 To remove the title menu, press TITLE again.

Disc Menu **DVD**

- 1 Press DISC MENU.
The disc menu is displayed.
- 2 To remove the disc menu, press DISC MENU again.

Camera Angle **DVD**

If the disc contains sequences recorded from different camera angles, the angle icon blinks on the display. You can then change the camera angle if you wish.

- Press ANGLE repeatedly during playback to select a desired angle.
The number of the current angle appears on the display.

Subtitles **DVD**

Press SUBTITLE repeatedly during playback to see the different subtitle languages.

N Note

If  appears, the feature is not available on the disc.

Programmed Playback with Audio CD

Program allows you to store your favorite tracks for a particular disc in the DVD+VCR memory.

Program can contain 20 tracks.

- 1 Insert an audio CD and close the tray.
- 2 Press PROGRAM during playback or in the stop mode.

The Program menu appears.

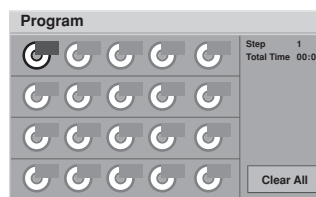

N Note

Press PROGRAM to exit the Program menu.

- 3 Press the number buttons to select the desired track number.

- 4 Press ▶ and the number buttons to select the next track number.

- 5 Repeat step 4 to place additional tracks on the Program list.

- 6 Press PLAY or SELECT/ENTER to start playback.

Playback begins in the order in which you programmed the tracks and "PROG." appears on display window. Playback stops after all of the tracks on the Program menu have played once.

Clearing the program

To clear the programmed tracks one by one

Press ◀ ▶ ▲ ▼ to select the unwanted number and then press CLEAR.

To clear all the programmed tracks

Press ◀ ▶ ▲ ▼ to select "Clear All" and then press SELECT/ENTER. Press PLAY or SELECT/ENTER to exit the screen. If you press PROGRAM to exit the screen, the programs are not cleared. (The programs are also cleared when the power is turned off or the disc is removed.)

Operation with MP3 Disc

Notes on MP3 Discs

About MP3

- An MP3 file is audio data compressed by using MPEG1, the audio layer-3 file-coding scheme. We call files that have the “.mp3” file extension “MP3 files”.
- The DVD+VCR can not read an MP3 file that has a file extension other than “.mp3”.
- The DVD+VCR can not read a fake MP3 file that has a file extension “.mp3”.

MP3 disc compatible with this DVD+VCR is limited as follows:

1. Sampling Frequency / only at 44.1kHz
2. Bit rate / within 32 - 320kbps
3. CD-R physical format should be “ISO 9660”
4. If you record MP3 files using the software which cannot create a FILE SYSTEM, for example “Direct-CD” etc., it is impossible to playback MP3 files. We therefore recommend that you use “Easy-CD Creator”, which creates an ISO9660 file system.
5. A single session disc requires MP3 files in the first track. If there is no MP3 file in the 1st track, it cannot playback MP3 files. If you wish to playback MP3 files, format all the data in the disc or use a new one.
6. We do not recommend using CD-RW discs. Please use finished CD-R discs only.
7. File names should be named using 8 letters or less and must incorporate “.mp3” extension e.g. “*****.MP3”.
8. Do not use special letters such as “_?!><+*} { [@] ; \ , ,” etc.
9. Total number of files on the disc should be less than 256.
10. Use 74 minute CD-R discs (650M), Do not use 80 minute CD-R (700M) software

This DVD+VCR requires discs/recordings to meet certain technical standards in order to achieve optimal playback quality. Pre-recorded DVDs are automatically set to these standards. There are many different types of recordable disc formats (including CD-R containing MP3 files).

Customers should also note that permission is required in order to download MP3 files and music from the Internet. Our company has no right to grant such permission. Permission should always be sought from the copyright owner.

Playing an MP3 disc

The DVD+VCR can play MP3 format recordings on CD-ROM, CD-R or CD-RW discs.

Before playing MP3 recordings, read the notes on MP3 Recordings to the left.

- 1 Insert an MP3 disc and close the tray.**
The MP3 menu appears on the TV screen.

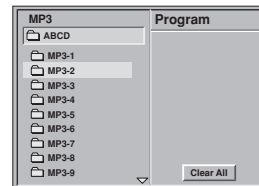

MP3 menu

- 2 Press ▲/▼ to select the directory containing the track that you want to play.**
- 3 Press SELECT/ENTER and press ▲/▼ to select the desired track.**
- 4 Press SELECT/ENTER or PLAY.**
Playback starts.
During playback, the current track's elapsed playing time will appear on the display window.
Playback will stop after playback the last track within the directory.

To return to the previous MP3 menu

Press RETURN.

To move to the first MP3 menu

Press DISC MENU.

To return to the top of the page within the directory

Press TITLE.

Each time you press the button, the pages within directory will change in rotating.

To pause playback

Press PAUSE/STEP during playback. To return to playback, press PLAY or PAUSE/STEP again.

To skip to another track during playback

Press BACKWARD ◀◀ or FORWARD ▶▶ briefly during playback.

Operation with MP3 Disc (Cont'd)

Programmed Playback with MP3 Disc

Program allows you to store your favorite tracks for a particular disc in the DVD+VCR memory.

Program can contain 60 tracks.

- 1 Follow steps 1 - 3 of MP3 Playing an MP3 disc to the left .
- 2 Press PROGRAM to list the selected track on the MP3 Program list.

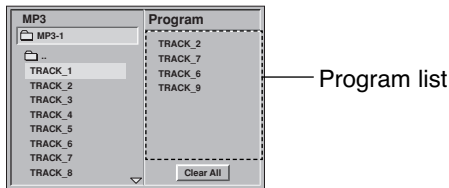

- 3 Repeat step 2 to place additional tracks on the Program list.

- 5 Press ►. The programmed track you selected last is highlighted on the program list.

- 6 Press ▲/▼ to select the track you want to start playing.

- 7 Press PLAY to start. Playback begins in the order in which you programmed the tracks and "PROG." appears on the display window. Playback stops after all of the tracks on the Program list have played once.

Erasing a Track from Program List

- 1 Use ▲/▼/◀/▶ to select the track that you wish to erase from the Program list.
- 2 Press CLEAR. The track will be erased from the Program list.

Erasing the Complete Program List

- 1 Use ▲/▼/◀/▶ to select "Clear All" then press SELECT/ENTER. The complete Program for the disc will be erased. The programs are also cleared when the disc is removed.
- 2 Press SELECT/ENTER again.

Repeat Playback with MP3 Disc

To playback a track repeatedly press REPEAT once during playback. The current track will be played back repeatedly.

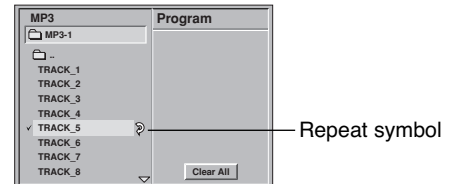

To playback a entire directory repeatedly Press REPEAT twice during playback. All of the tracks within the directory will be played back repeatedly.

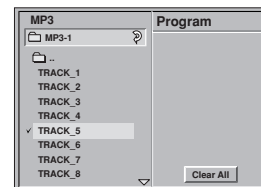

To playback a programmed track repeatedly press REPEAT once during programmed playback. The current track will be played back repeatedly.

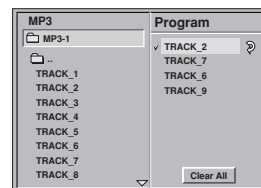

To playback a entire directory repeatedly Press REPEAT twice during programmed playback. All of the listed tracks on the MP3 Programmed list will be played back repeatedly.

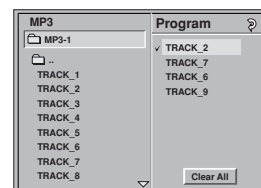

To exit Repeat mode Press REPEAT repeatedly until the Repeat icon disappears on the menu screen.

Troubleshooting

Check the following guide for the possible cause of a problem before contacting service.

Symptom	Cause	Correction
No power.	<ul style="list-style-type: none"> The power cord is disconnected. 	<ul style="list-style-type: none"> Plug the power cord into the wall outlet securely.
The power is on, but the DVD+VCR does not work.	<ul style="list-style-type: none"> No disc is inserted. No tape is inserted. 	<ul style="list-style-type: none"> Insert a disc or tape. (Check that the disc or tape indicator in the display window is lit.)
No picture.	<ul style="list-style-type: none"> The TV is not set to receive DVD+VCR signal output. 	<ul style="list-style-type: none"> Select the appropriate video input mode on the TV so the picture from the DVD+VCR appears on the TV screen.
	<ul style="list-style-type: none"> TV/VCR mode for DVD+VCR is set to TV. 	<ul style="list-style-type: none"> Press the TV/VCR button on remote repeatedly to choose VCR mode. VCR indicator light appears in VCR front panel.
	<ul style="list-style-type: none"> The video cable is not connected securely. 	<ul style="list-style-type: none"> Connect the video cable into the jacks securely.
	<ul style="list-style-type: none"> The connected TV power is turned off. 	<ul style="list-style-type: none"> Turn on the TV.
No sound.	<ul style="list-style-type: none"> The equipment connected with the audio cable is not set to receive DVD+VCR signal output. 	<ul style="list-style-type: none"> Select the correct input mode of the audio receiver so you can listen to the sound from the DVD+VCR.
	<ul style="list-style-type: none"> The audio cables are not connected securely. 	<ul style="list-style-type: none"> Connect the audio cable into the jacks securely.
	<ul style="list-style-type: none"> The power of the equipment connected with the audio cable is turned off. 	<ul style="list-style-type: none"> Turn on the equipment connected with the audio cable.
	<ul style="list-style-type: none"> The Digital Audio Output is set to the wrong position. 	<ul style="list-style-type: none"> Set the Digital Audio Output to the correct position, then turn on the DVD+VCR again by pressing POWER.
The playback picture is poor.	<ul style="list-style-type: none"> The disc is dirty. 	<ul style="list-style-type: none"> Clean the disc.
	<ul style="list-style-type: none"> Tape heads are dirty. 	<ul style="list-style-type: none"> Clean video heads.
	<ul style="list-style-type: none"> Tape is a rental or was recorded on another VCR. 	<ul style="list-style-type: none"> Use CH/TRK (▲/▼) for manual tracking adjustment while tape is playing.
The DVD+VCR does not start playback.	<ul style="list-style-type: none"> No disc is inserted. No tape is inserted. 	<ul style="list-style-type: none"> Insert a disc or tape. (Check that the disc or tape indicator in the display window is lit.)
	<ul style="list-style-type: none"> An unplayable disc is inserted. 	<ul style="list-style-type: none"> Insert a playable disc. (Check the disc type, color system and Regional code.)
	<ul style="list-style-type: none"> The disc is placed upside down. 	<ul style="list-style-type: none"> Place the disc with the playback side down.
	<ul style="list-style-type: none"> The disc is not placed within the guide. 	<ul style="list-style-type: none"> Place the disc on the disc tray correctly inside the guide.
	<ul style="list-style-type: none"> The disc is dirty. 	<ul style="list-style-type: none"> Clean the disc.
	<ul style="list-style-type: none"> The Rating level is set. 	<ul style="list-style-type: none"> Cancel the Rating function or change the rating level.
The remote control does not work properly.	<ul style="list-style-type: none"> The remote control is not pointed at the remote sensor of the DVD+VCR. 	<ul style="list-style-type: none"> Point the remote control at the remote sensor of the DVD+VCR.
	<ul style="list-style-type: none"> The remote control is too far from the DVD+VCR. 	<ul style="list-style-type: none"> Operate the remote control within about 23 ft (7 m).
	<ul style="list-style-type: none"> There is an obstacle in the path of the remote control and the DVD+VCR. 	<ul style="list-style-type: none"> Remove the obstacle.
	<ul style="list-style-type: none"> The batteries in the remote control are exhausted. 	<ul style="list-style-type: none"> Replace the batteries with new ones.

Troubleshooting (Cont'd)

Symptom	Cause	Correction
Some channels are skipped over when using CH (+/-).	<ul style="list-style-type: none"> Those channels were deleted with the CH. ADD/DEL option. 	<ul style="list-style-type: none"> Use ADD/DEL CH. to restore channels. See "Channel Selection" on page 16.
Picture and sound of broadcasting channel are weak or missing.	<ul style="list-style-type: none"> Antenna or cables are loose. 	<ul style="list-style-type: none"> Tighten connections or replace cable.
	<ul style="list-style-type: none"> Wrong SOURCE option is being used. 	<ul style="list-style-type: none"> Try all CHANNEL SOURCE options. See "Channel Selection" on page 16 for details.
Camcorder image is not shown.	<ul style="list-style-type: none"> Camcorder is off. 	<ul style="list-style-type: none"> Turn camcorder on and operate properly.
Camcorder image via A/V input to DVD+VCR is not shown on TV screen.	<ul style="list-style-type: none"> VCR SOURCE is not set to AUX. 	<ul style="list-style-type: none"> Press INPUT to select LINE input channel.
Timer recording is not possible.	<ul style="list-style-type: none"> Clock in VCR is not set to correct time. 	<ul style="list-style-type: none"> Set clock to correct time. See "Setting the Clock" on page 17.
	<ul style="list-style-type: none"> VCR is on which disables timer. 	<ul style="list-style-type: none"> Turn DVD+VCR off to enable timer. TIMER indicator light appears in the VCR front panel.
	<ul style="list-style-type: none"> Timer has been programmed incorrectly. 	<ul style="list-style-type: none"> Reprogram Timer. See "Timer Recording" on page 23.
	<ul style="list-style-type: none"> TIMER indicator light does not appear after programming timer. 	<ul style="list-style-type: none"> Reprogram Timer and turn DVD+VCR off to enable timer.
TIMER indicator light appears after VCR is turned off.	<ul style="list-style-type: none"> VCR is in Timer Recording mode. 	<ul style="list-style-type: none"> This is the normal indication that the VCR is in TIMER mode.
Stereo Audio Record and/or Playback is not present.	<ul style="list-style-type: none"> TV is not Stereo-compatible. 	<ul style="list-style-type: none"> No action is possible.
	<ul style="list-style-type: none"> Broadcast program is not in stereo format. 	<ul style="list-style-type: none"> No action is possible.
	<ul style="list-style-type: none"> DVD+VCR A/V Out jacks are not connected to TV A/V In jacks. 	<ul style="list-style-type: none"> Make A/V connections. Stereo is available only via A/V output from VCR.
	<ul style="list-style-type: none"> DVD+VCR Audio/Video Out is not selected for viewing at the TV. 	<ul style="list-style-type: none"> Select AUX or A/V source as TV input.
	<ul style="list-style-type: none"> DVD+VCR BROADCAST TYPE mode is set to SAP or MONAURAL. 	<ul style="list-style-type: none"> Set BROADCAST TYPE mode to STEREO. See "Setting the VCR Setup Menu" on page 16.

Moisture Condensation

Moisture condensation can occur:	In locations where moisture condensation may occur:
<ul style="list-style-type: none"> When the DVD+VCR is moved from a cold place to a warm place. Under extremely humid conditions. 	<ul style="list-style-type: none"> Keep the power cord plugged into an AC outlet and POWER On. This will help prevent condensation. When condensation has occurred, wait a few hours for the VCR to dry before using it.

Language Code List

Enter the appropriate code number for the initial settings “Disc Audio”, “Disc Subtitle” and/or “Disc Menu” (See page 19).

Code	Language	Code	Language	Code	Language	Code	Language
6565	Afar	7079	Faroese	7678	Lingala	8375	Slovak
6566	Abkhazian	7082	French	7679	Laothian	8376	Slovenian
6570	Afrikaans	7089	Frisian	7684	Lithuanian	8377	Samoan
6577	Ameharic	7165	Irish	7686	Latvian, Lettish	8378	Shona
6582	Arabic	7168	Scots Gaelic	7771	Malagasy	8379	Somali
6583	Assamese	7176	Galician	7773	Maori	8381	Albanian
6588	Aymara	7178	Guarani	7775	Macedonian	8382	Serbian
6590	Azerbaijani	7185	Gujarati	7776	Malayalam	8385	Sudanese
6665	Bashkir	7265	Hausa	7778	Mongolian	8386	Swedish
6669	Byelorussian	7273	Hindi	7779	Moldavian	8387	Swahili
6671	Bulgarian	7282	Croatian	7782	Marathi	8465	Tamil
6672	Bihari	7285	Hungarian	7783	Malay	8469	Telugu
6678	Bengali; Bangla	7289	Armenian	7784	Maltese	8471	Tajik
6679	Tibetan	7365	Interlingua	7789	Burmese	8472	Thai
6682	Breton	7378	Indonesian	7865	Nauru	8473	Tigrinya
6765	Catalan	7383	Icelandic	7869	Nepali	8475	Turkmen
6779	Corsican	7384	Italian	7876	Dutch	8476	Tagalog
6783	Czech	7387	Hebrew	7879	Norwegian	8479	Tonga
6789	Welsh	7465	Japanese	7982	Oriya	8482	Turkish
6865	Danish	7473	Yiddish	8065	Panjabi	8484	Tatar
6869	German	7487	Javanese	8076	Polish	8487	Twi
6890	Bhutani	7565	Georgian	8083	Pashto, Pushto	8575	Ukrainian
6976	Greek	7575	Kazakh	8084	Portuguese	8582	Urdu
6978	English	7576	Greenlandic	8185	Quechua	8590	Uzbek
6979	Esperanto	7577	Cambodian	8277	Rhaeto-Romance	8673	Vietnamese
6983	Spanish	7578	Kannada	8279	Rumanian	8679	Volapük
6984	Estonian	7579	Korean	8285	Russian	8779	Wolof
6985	Basque	7583	Kashmiri	8365	Sanskrit	8872	Xhosa
7065	Persian	7585	Kurdish	8368	Sindhi	8979	Yoruba
7073	Finnish	7589	Kirghiz	8372	Serbo-Croatian	9072	Chinese
7074	Fiji	7665	Latin	8373	Singhalese	9085	Zulu

Specification

General

Power requirements	AC 120V , 60 Hz
Power consumption	23W
Dimensions (approx.)	430 X 97.5 X 360 mm (16.9 x 3.9 x 14.2 inches) (w/h/d)
Mass (approx.)	5.4 kg (11.9 lbs)
Operating temperature	5° C to 35° C (41° F to 95° F)
Operating humidity	5 % to 90 %
Signal system	NTSC

Inputs

ANTENNA IN	Antenna or CATV input, 75 ohms
VHS VIDEO IN	1 Vp-p 75 ohms, sync negative, RCA jack x 1
VHS AUDIO IN	-6.0 dBm more than 47 kohms, RCA jack (L, R) x 1

Outputs

VIDEO OUT	1 Vp-p 75 ohms, sync negative
S-VIDEO OUT	(Y) 1.0 V (p-p), 75 ohms, negative sync., Mini DIN 4-pin x 1 (C) 0.3 V (p-p) 75 ohms
COMPONENT VIDEO OUT	(Y) 1.0 V (p-p), 75 ohms, negative sync., RCA jack x 1 (Pb)/(Pr) 0.7 V (p-p), 75 ohms, RCA jack x 2
Audio output (digital audio)	0.5 V (p-p), 75 ohms, RCA jack x 1
Audio output (analog audio)	1.0 Vrms (1 KHz, 0 dB), 600 ohms, RCA jack (L, R) x 1
RF OUT	Channel 3 or 4

VCR Specification

Head system	Four head helical scan azimuth system
Timer	12-hour display type with AM, PM
Tape speed	SP: 33.35 mm/sec, LP: 16.67 mm/sec, EP: 11.12 mm/sec
Tape width	12.7 mm
Maximum recording time	SP: 2 HOURS (T-120), EP: 6 HOURS (T-120)/8 HOURS (T-160)
Rewind time	About 3 minutes (T-120)
Timer	12-hour display type with AM, PM
Tape width	12.7 mm
Rewind time	About 3 minutes (T-120)
Antenna	75 ohms (VHF/UHF)
VHF output signal	Channel 3 or 4 (Switchable)
Channel coverage	VHF: 2-13, UHF: 14-69, CATV: 1-125 (4A, A-W, W+1 - W+84, A-5 - A-1)
Frequency range	20Hz to 20kHz
Signal-to-noise ratio	More than 43dB
Dynamic range	More than 83 dB
Channel separation	More than 55 dB

DVD Specification

Laser system	Semiconductor laser, wavelength 650 nm
Frequency response	DVD (PCM 96 kHz): 8 Hz to 44 kHz, DVD (PCM 48 kHz): 8 Hz to 22 kHz CD: 8 Hz to 20 kHz
Signal-to-noise ratio	More than 100dB (ANALOG OUT connectors only)
Harmonic distortion	Less than 0.008%
Dynamic range	More than 100 dB

Accessory:

Video cable x 1, Audio cable x 1, RF 75-ohm Coaxial Cable x 1, Remote control x 1, Batteries x 2

- Design and specifications are subject to change without notice.

**ZENITH ELECTRONICS CORPORATION
DVD + VCR LIMITED WARRANTY-USA**

Zenith will repair or replace your product, at Zenith's option, if it proves to be defective in material or workmanship under normal use during the warranty period listed below from the date of original consumer purchase. **This warranty is available only to the original purchaser of the product and effective only when used in the United States, excluding U.S. Territories.**

WARRANTY PERIOD:		HOW SERVICE IS HANDLED:
Labor:	90 Days from date of purchase	Carry in service: Please retain your bill of sale for proof of warranty.
Parts:	One Year from the date of purchase	Please call 1-877-9Zenith (1-877-993-6484) to locate your nearest Zenith Authorized Service Center. Please see below for further information.

THIS WARRANTY IS IN LIEU OF ANY OTHER WARRANTY, EXPRESS OR IMPLIED, INCLUDING WITHOUT LIMITATION, ANY WARRANTY OF MERCHANTABILITY OR FITNESS FOR A PARTICULAR PURPOSE. TO THE EXTENT ANY IMPLIED WARRANTY IS REQUIRED BY LAW, IT IS LIMITED IN DURATION TO THE EXPRESS WARRANTY PERIOD ABOVE. ZENITH WILL NOT BE LIABLE FOR ANY INCIDENTAL, CONSEQUENTIAL, INDIRECT, SPECIAL, OR PUNITIVE DAMAGES OF ANY NATURE, INCLUDING WITHOUT LIMITATION LOST PROFITS, LOST OR CORRUPTED PROGRAMMING OR DATA, OR ANY OTHER DAMAGE WHETHER BASED IN CONTRACT, TORT, OR OTHERWISE.

Some states do not allow the exclusion or limitation of incidental or consequential damages or limitations on how long an implied warranty lasts, so the above exclusion or limitation may not apply to you. This warranty gives you specific legal rights and you may also have other rights that vary from state to state.

THIS LIMITED WARRANTY DOES NOT APPLY:

- To damages or problems that result from shipping, installation, calibration, maintenance, or separate system components.
- To damages or problems that result from misuse, abuse, operation outside environmental specifications or contrary to the requirements and precautions in the Operating Guide, accident, lightning strikes or other natural causes, modification or alteration, incorrect electrical current or voltage, signal reception or input, software not licensed directly by Zenith, software errors that do not disable functionality, operating and software protocols adopted after date of manufacture or for outside the U.S., or institutional or commercial use.

Therefore, the cost of repair or replacement under these circumstances is borne by the customer.

CUSTOMER ASSISTANCE NUMBERS:

To prove warranty coverage:	Retain your dated sales receipt to prove date of purchase. Legible copy of your sales receipt must be submitted at the time warranty service is provided.
To obtain where-to-buy, product assistance, or customer assistance:	Call 1-877-9Zenith (1-877-993-6484) (Mon. - Fri. 7 AM to 8 PM and Sat. 8 AM to 5:00 PM CT) Please select the appropriate option from the menu.